









# Nature

A WEEKLY

ILLUSTRATED JOURNAL OF SCIENCE



*Supplement to Nature,* ]  
May 31, 1894

# Nature

A WEEKLY

ILLUSTRATED JOURNAL OF SCIENCE

VOLUME XLIX

NOVEMBER 1893 to APRIL 1894

*"To the solid ground  
Of Nature trusts the mind which builds for aye."*—WORDSWORTH

London and New York  
MACMILLAN AND CO.

G  
1  
N. 2  
49  
104. 2

RICHARD CLAY AND SONS, LIMITED,  
LONDON AND BUNGAY.



# INDEX

- ABBE (PROF. C.), the Measurement of the Highest Cirrus Clouds, 508
- Abbott (W. J. L.), the Ossiferous Fissures in Shode Valley, near Ightham, 355; the Vertebrate Fauna collected therefrom by E. T. Newton, F.R.S., 355
- Abnormal Eggs, W. B. Tegetmeier, 366; E. J. Lowe, F.R.S., 366
- Abraham (H.), Measurement of Coefficients of Induction, 72
- Abrastol in Wines, Discovery of, M. Sangle-Ferrière, 167
- Abroad, Voices from, Prof. Henry E. Armstrong, F.R.S., 225
- Acari, our Knowledge of the, A. D. Michael, 330
- Achromatic Object-Glass, a New, 464
- Acoustics; Application of Sound-Vibrations to Analysis of Mixtures of Gases, E. Hardy, 47; Hydrodynamical Acoustical Investigations, W. König, 239; Researches in Acoustics, No. 9, A. M. Mayer, 305; the Origin of "Beats," K. L. Schaefer, 370; Relation of Fog Signals to other Sounds, C. A. White, 508; Determination of Pitches of very High Notes, F. Melde, 560; an Apparatus to show simultaneously to several hearers the blending of the Sensations of Interrupted Tones, Alfred M. Mayer, 617
- Adair (Peter), the disappearance of the Field Vole, 14
- Adam (T. H.), Bequest for purposes of Technical Education by, 320
- Adams Memorial, the Text of the, 67
- Adder's Blood, Poisonous Principles of, MM. Phisalix and Bertrand, 284
- Addyman (Frank T.) Practical Agricultural Chemistry for Elementary Students, 244
- Adelberg Grotto, Investigation of, E. A. Martel, 356
- Adeny (W. E.), Reduction of Manganese Peroxide in Sewage, 499
- Adler, (Dr. G.), Death of, 320
- Aerodynamics; the Internal Work of the Wind, Prof. S. P. Langley, 273
- Afforestation in the British Isles, Prof. W. R. Fisher, 601
- Africa: the Natural History of East Equatorial Africa, Dr. J. W. Gregory, 12; Dr. J. W. Gregory's Voyage to Mount Kenya, 276, 443; Large Supply of Ivory in South Africa, 13; Extra-Tropical South African Orchids, Henry Bolus, R. A. Rolfe, 50; Georges Muller's Last Explorations in Madagascar, 112; Mr. Astor Chanler's East African Expedition, 112; Lieutenant von Höhnel wounded, 112; Mr. Chanler's Expedition, 301; Crossing of the Eastern Horn, 163; Kling and Büttner's Expedition to Togo, 207; Visit of Mr. Crawshaw to Nyika Plateau, 210; Sir Claude Macdonald's Journey up the Cross River, 346; the Last Great Lakes of Africa, Ludwig von Hohnel, 457; Exploration of Lukuga River by M. Delcommune, 559; Government Scientific Work in the German Protectorates, 581; Delimitation of Congo State and Portuguese Frontier, 582; the Lubidi River, 582; the German Expedition to Delimit Hinterland of Cameroons, 606; Intended Expeditions of Dr. Donaldson Smith to Lake Rudolph, and of R. T. Coryndon to Great Congo Forest, 606
- Agamennone (Dr. G.), Velocity of Propagation of Earthquakes at Zante in 1893, 439
- Agni, the, a Tribe of Fair Negroes, Maurice Delaforce, 263
- Agriculture: the Disappearance of the Field Vole, Peter Adair, 14; Wheat-growing in Indiana, 15; Death and Obituary Notice of Prof. E. Lecouteux, 33; the Spermophile (Ground Squirrel) Pest in the Mississippi Valley, Vernon Bailey, 36; the Nitrification of Prairie Lands, J. Dumont and J. Crochetelle, 96; Death of Dr. Webb, 129; Practical Agricultural Chemistry for Elementary Students, J. Bernard Coleman and Frank T. Addyman, 244; an Elementary Text-Book on Agricultural Botany, M. C. Potter, 290; Death of Sir Harry Verney, 368; Agricultural Experiment Stations, 373; Educational Agricultural Experiments, 568; the Cambridge Diploma in Agriculture, 444; Analytical Determination of probably "available" Mineral Plant Food in Soils, B. Dyer, 451; Agricultural Resources of Canada, Prof. Long, 561; Mr. F. L. Scribner appointed United States Agrostologist, 605
- Ainu, Fresh Light on the, A. H. Savage Landor, 248
- Air, Proposed Standard of Normal, A. Leduc, 272
- Air-Pump, New Form of Rotatory, Herr F. Schulze-Berge, 65
- Aitken (John, F.R.S.): the Origin of Lake Basins, 315; the Cloudy Condensation of Steam, 340; Number of Dust Particles in Atmosphere of certain Places, 426; Dust and Meteorological Phenomena, 544
- Alaska, Glacial Erosion in, Prof. G. Frederick Wright, 316
- Albatross, the Pterapod Collections of the, 36
- Aleutian Islands, the Ptarmigan of, W. B. Evermann, 584
- Alford (C. J.), Auriferous Rocks from Mashonaland, 403
- Algæ, Green, the Alleged Action as Water-Purifiers of, Prof. Schenck, 182
- Algæ; the Laminariaceæ, W. A. Setchell, 207
- Algol, the System of, 349
- Allbutt (Prof. T. Clifford), Music, Rhythm and Muscle, 34
- Allen (Prof. F. J.), Earthquake at Shepton Mallet, 229; the Mendip Earthquake of December 30-31, 1893, 245
- Alloys, the Chemical Composition of, Prof. Behrens, 144
- Alsace-Lorraine, Geological Survey Department of, 322
- Altazimuths of Pistor and Martin and of Repsold, Accuracy of Divisions of, Prof. J. A. C. Oudemans, 192
- Altona, an Incident in the Cholera Epidemic at, Prof. Percy Frankland, F.R.S., 392
- Aluminium, Herr van Aubel's Method of Silvering, 356
- Amagat (E. H.), Interior Pressure in Gases, 404; the Internal Pressure of Fluids and the Form of the Function  $\phi(\rho, \tau) = O$ , 500
- Amber in Russia, F. T. Köppen, 181
- America: the Shrubs of North-Eastern America, Charles S. Newhall, 28; American Meteorological Journal, 71, 263, 329, 423; American Journal of Science, 92, 214, 305, 402, 520, 617; American Journal of Mathematics, 93, 449; Copy of Map by Columbus, 233; the True Discovery of America, Captain Gambier, 235; American Psychological Association, 252; Recent Publications of the American Geological Survey, Prof. T. G. Bonney, F.R.S., 434; the Pharmacopœia of the United States of America, 525
- Ammen (General J.), Death of, 368
- Amœbæ, Artificial, and Protoplasm, Dr. G. Quincke, 5; Dr. John Berry Haycraft, 79
- Amphioxus, the Ventral Nerves of, M. van Wyhe, 24
- Amsterdam Academy of Sciences, 24, 141, 192, 38c, 476
- Amu-Daria, the old Beds of the, M. Korshin, 515
- Anadyr, a new Province in Siberia, 18
- Analysers, Harmonic, Prof. O. Henrici, F.R.S., 521
- Anatomical Modifications of Plants of the same Species in the Mediterranean Region and in the Region of the Neighbourhood of Paris, W. Russell, 620
- Anatomy, Human and Comparative, at Oxford, Prof. J. Burdon Sanderson, F.R.S., 6; Prof. E. Ray Lankester, F.R.S., 29
- Anatomy, Comparative: the Sutura Condylo-Squamosa of Occipital Bone of Man and Mammalia, Prof. Zaaijer, 192; Myology of the Hystricomorphine and Sciuricomorphine Rodents, F. G. Parsons, 523; Death and Obituary Notice of H. C. G. Pouchet, 538

- Ancient Egyptian Pigments, Dr. William J. Russell, F.R.S., 374
- Ancients, on the Bugonia Superstition of the, Baron C. R. Osten-Sacken, 198
- Anderson (E. W.), the Grafton High Speed Steam Engine, 610
- Anderson (Rev. Thomas D.), New Variable Star in Andromeda, 101
- Anderson's Variable in Andromeda, Prof. E. Pickering, 419
- Andes, Eruption of El Calbuco Volcano, A. E. Noguez, 179
- André (Ch.), Electric Variation of High Regions of Atmosphere in Fine Weather, 131
- André (G.), Formation of Carbon Dioxide and Absorption of Oxygen by Detached Leaves of Plants, 284
- Andrews (E. A.), *Asymmetron lucayanum*, a new Acraniate found at Bahamas, 14
- Andrews (Rev. W. R.), Purbeck Beds of Vale of Wardour, 191
- Andromeda, New Variable Star in, Rev. Thomas D. Anderson, 101
- Andromeda, Anderson's Variable in, Prof. E. Pickering, 419
- Andrusoff (N.), the Black Sea during the Pliocene Age, 23
- Angot (Alfred), Vallot's Mont Blanc Meteorological Observations, 1887, 167; Diurnal Range of Amount of Cloud at Paris, 206; Diurnal Variation of Tension of Aqueous Vapour, 240
- Animals, Chrono-Photographic Study of the Locomotion of, 41
- Animals, the Industries of, Frédéric Houssay, 171
- Annales de Geographie, 184
- Annuaire, the, of the Bureau des Longitudes, 397
- Annuario do Observatorio do Rio de Janeiro, 299
- Annular Eclipse of the Sun, an, 542
- Antarctic Exploration: Dr. John Murray, 112; Scheme for, Dr. F. A. Cook, 184
- Antarctic Research: the Scottish Geographical Society and Antarctic Research, 257; the Latitude reached by *Nezport* Whaler, Prof. George Davidson, 369; Norwegian Sealers in Antarctic Waters, 461; High Southern Latitude reached by *Fason* Whaler, 559
- Antarctica, a Vani-hed Austral Land, H. O. Forbes, 352
- Anthropology: L'Anthropologie, 22, 263, 472, 520, 593; Proportion of Trunk among the French, Dr. R. Collignon, 22; Dr. H. Ten Kate's Malaysian and Polynesian Researches, 23; Hindoo Dwarfs, Colonel A. T. Fraser, 35, 396; Dr. A. E. Grant, 396; the Man of Mentone, Arthur J. Evans, 42; Sense of Taste among Indians, E. H. S. Bailey, 82; Anthropological Institute, 215; the Agni, a Tribe of Fair Negroes, Maurice Delafosse, 263; Birth-rate in Canton of Beaumont-Hague, A. Dumont, 283; Memoires de la Société d'Anthropologie de Paris, 283; Bulletins de la Société d'Anthropologie de Paris, 306; Stone Cross found at Carnac, Ch. Letourneau, 330; Flattening of Chest and Skull in Celebes, Baron von Hoëvell, 377; Merovingian and Carolinian Crania of Boulogne District, Dr. E. T. Hamey, 472; Le Mirage Oriental, Salomon Reinach, 472; Distribution of Red Hair in France, Dr. P. Topinard, 472; Certain Inferences and Applications of Anthropology, Dr. Topinard, 520; Relation of Length of Trunk to Height, Ch. Féré, 520; the Perfect Man, Dr. Topinard, 520; Prehistoric History of the Pyrenees, 593; Ethnical Migrations in Central Asia from a Geographical Point of View, G. Cepas, 594
- Anthropometrical Registry, Proposed, 487
- Anti-Vivisectionists and the Indian Vivisection Bill and Pasteur Institute, 130
- Antipodes, Biology at the, 597
- Antropologia Generale, 472
- Ants, White, Dr. D. Sharp, F.R.S., 522
- Apache Indians, the Medicine Men of the, Captain J. G. Bourke, 439
- Apogamy in *Pteris serrulata* (L. fil.) var. *cristata*, A. H. Trow, 434
- Apteryx, the Genus, Hon. Walter Rothschild, 14
- Aquarium, the Melbourne Exhibition, 583
- Arachnida, the Stigmata of the, as a Clue to their Ancestry, H. M. Bernard, 68
- Aran Islands, the Ethnography of the, County Galway, Prof. A. C. Haddon and Dr. C. R. Browne, 468
- Arboriculture: British Forest Trees, J. Nisbet, 1
- Arbutnot Museum, Peterhead, the, Alexander Meek, 20
- Archæology; the Orkhon River Expedition, W. Radloff, 23; the Forgery of Prehistoric Stone Implements, Sir John Evans, 156; "Beni Hasan," P. E. Newberry and G. W. Fraser, 169; Death of Prof. Forchhammer, 251; Stone Cross found at Carnac, Ch. Letourneau, 330; Prehistoric Man in Jersey, Edward Lovett, 487; Roman Villa near Cardiff, John Storrie, 605
- Architecture, Naval: Institution of Naval Architects, 490; Recent First-class Battleships, W. H. White, 490; the Circulation of Water in Thornycroft Water-Tube Boilers, J. L. Thornycroft, 491; the Vibration of Steamers, Otto Schlick, 491
- Arctic Exploration: Proposed Station in Ellesmere Land, Robert Stein, 18; Plan for Exploration of Ellesmere Land, Robert Stein, 346; Dr. Stein's Expedition, 256; Dr. Nansen and the Kara Sea, 39; Dr. Nansen's Expedition, 112, 210; Hans Johannessen, 85; the Fate of the Björling Exploring Expedition, Captain McKay, 85; Proposed Search for the Björling Expedition, 606; Projected Expedition by Mr. Wollman, 416; Results of Swedish International Polar Expedition, Dr. J. Hann, 498; Current Arctic Expeditions, 301; Return of Mr. F. G. Jackson, 301
- Arctic Lands, Geological History of, Sir Henry Howorth, 36
- Arendt (Dr.), the Transport of Heat by Aerial Currents, 216
- Arithmetic: Graphic Arithmetic and Statics, J. J. Prince, 284
- Arithmetic, Key to Mr. J. B. Lock's Shilling, Henry Carr, 480
- Arithmometers, Prof. Boys, 618
- Armatures, the Construction of Drum, and Commutators, F. M. Weymouth, E. Wilson, 478
- Armstrong (Prof. Henry E., F.R.S.), Flame, 100, 171; the Action of Bromine on Azobenzene, a Correction, 118; Coloured Hydrocarbons, 118; Voices from Abroad, 225
- Arons (Dr.), Polarisation Phenomena upon Thin Metal Partitions, 347
- Arsonval (M. d'), the Action of Sunshine on Microbes, 417
- Artaria (August), Death of, 275
- Arthropoda, Tracheate, on the Classification of the, a Correction, R. I. Pocock, 124
- Artificial Amœbæ and Protoplasm, Dr. G. Quincke, 5; Dr. John Berry Haycraft, 79
- Artificial Formation of the Diamond, the, J. B. Hannay, Dr. J. Joly, F.R.S., 530
- Artificial Preparation of the Diamond, M. Moissan, 418
- Ashdown (Dr. H. H.), Death of, 12
- Asia: M. de Poncin's Explorations in the Pamirs, 18; Earthquake in Western Asia, 81; "Chinese Central Asia, a Ride to Little Tibet," Henry Lansdell, W. F. Kirby, 309; Prince Constantine Wiazemski's Journey through Asia, 324; Across Central Asia, St. George Littledale, 567; Ethnical Migrations in Central Asia, from a Geographical Point of View, G. Capus, 593
- Asphalte Pavement, Petroleum in relation to, S. P. Peckham, 306
- Asphyxia, the Physiological Action of Oxygen in, 16
- Asterisms, Early, J. Norman Lockyer, F.R.S., 199
- Astigmatism of Rowland's Concave Gratings, the, 489
- Aston (Miss E.), Molecular Formulæ of some Liquids as Determined by their Molecular Surface Energy, 377
- Astronomy: a Popular History of Astronomy during the Nineteenth Century, Agnes M. Clerke, 2; the Nativity of Rama, Col. Walter R. Old, 4; Brooks's Comet (October 16), 18, 39; Brooks's New Comet (1893c), Prof. E. E. Barnard, 67; the Tail of Comet Brooks (1893), 210, 233; Our Astronomical Column, 18, 38, 67, 84, 111, 133, 162, 183, 209, 233, 256, 274, 300, 323, 349, 372, 397, 419, 441, 464, 489, 511, 542, 562, 585, 608; the Wave Lengths of the Nebular Lines, Prof. Keeler, 18; the Planet Jupiter, 18, 67; Period of Jupiter's Fifth Satellite, Prof. E. E. Barnard, 85; Motion of Jupiter's Fifth Satellite, F. Tisserand, 239; Jupiter and his Red Spot, W. F. Denning, 104; Anomalous Appearance of Jupiter's First Satellite, 300; Jupiter's Satellites in 1664, 323; Nova Aurigæ, 373; Prof. E. S. Holden, 32; a New Southern Star discovered by Mrs. Fleming, 38; *Astronomical Journal* Prize, 39; Moon Pictures, 39; Meteor Showers during November, 39; Biela Meteors, 97; Meteor Shower for December, 134; a Bright Meteor, 419; Prof. Schur, 111; an *Astronomical Glossary*, J. E. Gore, 51; Correlation of Solar and Magnetic Phenomena, William Ellis, F.R.S., 53, 78; A. R. Hinks, 78; Correlation of Magnetic and Solar Phenomena, H. A. Lawrence, 101; a New Variable Star, Rev. T. E. Espin, 67; the *Observatory* for November, 67; Text of the Adams Memorial, 67; Solar

- Observations at Catania, Rome, &c., 67; Solar Observations at Rome, 163; the New Star in Norma, 85; the Spectrum of Nova Normæ, 162; Prof. W. W. Campbell, 586; Mechanical Theory of Comets, Prof. J. M. Schaeberle, 84, 85; the Natal Observatory, 85, 562; Magnitude and Position of T Aurigæ, M. Bigourdan, 85; La Voie Lactée dans l'Hémisphère Boreale, C. Easton, 99; New Variable Star in Andromeda, Rev. Thomas D. Anderson, 101; Death of Baron von Bülow, 106; Otto Struve's Double-Star Measures, 111; Method of Pivot Testing, Maurice Hamy, 111; Astronomical Photography, H. C. Russell, F.R.S., 111; Vierteljahrsschrift der Astronomischen Gesellschaft, 111; the Variation of Latitude, Prof. S. C. Chandler, 133; Refraction Tables, 134; New Notation for Lines in Spectrum of Hydrogen, 162; Death of Prof. Rudolf Wolf, of Zurich, 163; the Companion to the *Observatory*, 163; Colour-Arrangement of Refracting Telescopes, H. Dennis Taylor, 183; Stars with Remarkable Spectra, 183; *Himmel und Erde* for December, 184; a New Variable, 184; Early Asterisms, J. Norman Lockyer, F.R.S., 199, 247; Small Distances Measured with the Heliometer, 209; Hydrogen Envelope of the Star D.M. + 30° 3639, Prof. W. W. Campbell, 210; *L'Astronomie* for December, 210; Prizes at the Paris Academy, 233; the Planet Venus, 233, 413; In the High Heavens, Sir Robert S. Ball, F.R.S., R. A. Gregory, 243; Harvard College Observatory Report, 256; the *Gegenschein* 256; Electromotive Force from the Light of the Stars, Prof. Geo. M. Minchin, 270; Sun-spots and Solar Radiation, R. Savélieff, 274; the Measurement of Stellar Diameters, Maurice Hamy, 275; the Moon and Weather, 275; The Vault of Heaven, R. A. Gregory, 291; Astronomy and Astro-Physics, 300; Report of the Wolsingham Observatory, 300; U.S. Naval Observatory, Capt. F. V. McNair, 324; the Satellite of Neptune, Prof. Struve, 324; Royal Astronomical Society, 345; Eclipse Meteorology, 349; a Remarkable Cometary Collision, 349; Mira Ceti, 349, 442; Proper Motions of Stars, 349; the System of Algol, 349; the Pleiades, 366; a Tempered Steel Meteorite, 372; Astronomy in Poetry, 372; Rev. Edward Geoghegan, 413; G. W. Murdoch, 434; The Story of the Sun, Sir Robert Ball, F.R.S., A. Fowler, 382; on the Cardinal Points of the Tusayan Villagers, J. Walter Fewkes, 388; the *Annuaire* of the Bureau des Longitudes, 397; Sun-spots and Magnetic Disturbances, Dr. L. Palazzo, 397; Dr. M. A. Veeder, 503; a Large Sun-spot, 419; Anderson's Variable in Andromeda, Prof. E. Pickering, 419; Fireballs, W. F. Denning, 434; the Aurora of February 28, C. Thwaites, 441; Mr. Fowler, 442; Rear-Admiral J. P. Maclear, 442; Halley's Comet, 442; a New Achromatic Object-Glass, 464; Solar Magnetic Influences on Meteorology, Prof. H. A. Hazen, 464; a New Telescope for Greenwich, 464; Occultation of Spica, 464; New Nebulæ, 464; Comet-Spectra as affected by Width of Slit, 489; the Astigmatism of Rowland's Concave Gratings, 489; Photographic Nebulosity in the Milky Way, Prof. E. E. Barnard, 511; Madras Observatory, 511; a New Comet, 511, 562; the New Comet, W. F. Denning, 531; Denning's Comet, 562; Ephemeris for Denning's Comet (*a* 1894), 586; the Reckoning of the Astronomical Day, 542; the Height of an Aurora, Arthur Harvey, 542; an Annular Eclipse of the Sun, 542; a Comet-finder, W. R. Brooks, F. W. Mack, 543; the Satellite of Neptune, M. Tisserand, 543; the Aurora of March 30, Prof. J. Ryan, 554; F. R. Welsh, 576; a New Southern Comet, 586; the Presence of Oxygen in the Sun, Dr. Janssen, 585; Melting of the Polar Caps of Mars, Prof. W. H. Pickering, 586; four New Variable Stars Discovered by Mrs. Fleming, 608; Speed of Perception of Stars, Prof. Riccò, 608; Elements and Ephemeris of Gale's Comet (*b* 1894), 608; a Mistaken Cometary Discovery, Prof. Krueger, 608
- Asymmetrical Frequency Curves, Prof. Karl Pearson, 6
- Asymmetron lucayanum*, a New Acraniate found at Bahamas, E. A. Andrews, 14
- Atlantic, Pilot Chart of North, 81
- Atlantic, North, *Deutsche Seewarte* Record of Meteorological Observations taken in, 109
- Atlantic Islands, the Lepidoptera of the, A. E. Holt White, W. F. Kirby, 384
- Atlas, Philip's Systematic, Physical and Political, E. G. Ravenstein, 574
- Atmosphere, Report on the Present State of our Knowledge respecting the General Circulation of the, L. Teisserenc de Bort, 217
- Atmosphere, the Dynamics of the, M. Möller, 422
- Atmosphere, some Phenomena of the, Richard Inwards, 619
- Atmospheric Electricity: Electric Measurements made during Balloon Ascents, Prof. Bornstein, 595
- Atomic Weights, Stas's Determination of, E. Vogel, 283
- Aubel (Herr van), Method of Silvering Aluminium, 356
- Auk's Egg, Great, Prof. Alfred Newton, F.R.S., 412, 456; J. E. Harting, 432
- Auk's Egg, Great, sold for 300 guineas, 415
- Aurigæ, Magnitude and Position of, M. Bigourdan, 85
- Aurigæ, Nova, 373; Prof. E. S. Holden, 32
- Aurora Australis, a Fine, Hon. H. C. Russell, F.R.S., 601
- Aurora Borealis of March 30, 1894, Brilliant, Hon. Kollo Russell, C. E. Stromeyer, and Mr. Greece, 539
- Aurora of February 28, C. Thwaites, 441; Mr. Fowler, 442; Rear-Admiral J. P. Maclear, 442
- Aurora, the Height of an, Arthur Harvey, 542
- Aurora of March 30, the, Prof. J. Ryan, 554; F. R. Welsh, 576
- Au-tin (Louis), Experimental Investigations concerning Elastic Longitudinal Torsional Fatigue in Metals, 239
- Australia: The Discovery of Australia, Albert F. Calvert, 28; Coal discovered at Port Jackson, 64; The Geology of Australia, Prof. Ralph Tate, 177
- Australasian Association for Advancement of Science, 228
- Austrian Geological Survey, Transactions of, 71
- Ayrton (Prof. W. E., F.R.S.), Transparent Conducting Screens for Electric and other Apparatus, 591
- Babes (Prof. V.) on the Position of the State in respect to Modern Bacteriological Research, 564
- Bach (Dr. Alexander von), Death of, 106
- Bacteriology: Proposed Pasteur Institute for India, 13; Herr Messner's Experiments with Bullets infected with Micro-organisms, 16; Russell's Observations on Microbial Condition of Massachusetts Coast Sea Water and Mud, 37; Cultivation of Pathogenic Bacteria in Non-Albuminous Media, Dr. Uschinsky, 83; the Tetanus Bacillus, Dr. Uschinsky, 84; Vitality of Cholera Organisms on Tobacco, Herr Wernicke, 108; the Virulence of the Cholera Bacillus increased by Salt, Dr. Gamaleia, 132; Sand-filtration as a Means of Purifying Water, Mrs. Percy Frankland, 156; the Bacterial Efficiency of Porous Cylinders in Filtration of Water, Dr. Schöfer, 160; Action of Light on Bacteria, Dr. H. M. Ward, 166; Sterilisation of Bread and Biscuit by Baking, MM. Ballard and Masson, 167; the Ferment-character of Toxic Products of Pathogenic Bacteria, Dr. Uschinsky, 208; the Ætiology of Delirium Acutum, Dr. Rasori, 208; the Bacilli of Leprosy, N. Wnukow, 231; Les Vibrions des Eaux et l'Étiologie du Choléra, Dr. Sanarelli, 231; Action of Nucleic Acid on Bacteria, Prof. A. Kossal, 240; the Purification of Sewage by Bacteria, Alex. C. Houston, 249; Virulence of Tetanus Bacillus increased by addition of other Organic Products, Signor Roncali, 254; Method for Making Permanent Microscopic Preparations of Particular Colonies on Gelatine Plate, Herr Hauser, 273; Method of Differentiating Typhoid and Colon Bacilli, Dr. Schild, 298; Micro-organisms in Ice, Messrs. Salazar and Newton, 322; Action of Light on Bacteria, Bacterial Photographs of Solar and Electric Spectra, Prof. H. M. Ward, F.R.S., 353; Possible Transmission of Tubercle Bacillus by Cigars, Dr. Kerez, 371; an Incident in the Cholera Epidemic at Altona, Prof. Percy Frankland, F.R.S., 392; Bacteriological Institutes established at Buda-Pesth, 393; Vitality of Micro-organisms on Artificial Ice, Herren Prudden and Renk, 395; the Action of Sunshine on Microbes, MM. d'Arsonval and Charrin, 417; Einführung in das Studium der Bakteriologie mit besonderer Berücksichtigung des Mikroskopischen Technik, Dr. Carl Günther, Mrs. Percy Frankland, 455; Bactericidal Influence of Sunshine on Drainwater Microbes, Dr. Procacci, 461; the Action of Sunshine upon Tetanus Filtrates, Signors Fermi and Pernossi, 509; the Bacterial Contents of Sea-water, Dr. H. L. Russell, 559; Prof. V. Babes on the Position of the State in respect to Modern Bacteriological Research, 564; Disease and Race, Jadroo, 575; Soil-microbes Assimilative of Atmospheric Nitrogen, M. Winogradsky, 607

- Balenoch (L. N.), Romance of the Insect World, 314  
 Balonrean (A.), the Slow Ascensional Movement of Scandinavia, 159  
 Bahamas, *Asymmetron lucayanum*, New Acraniate found at, E. A. Andrews, 14  
 Bailey (E. H. S.), Sense of Taste among Indians, 82  
 Bailey (Dr. G. H.), Aspects of Town as contrasted with Country Air, 416  
 Bailey (Prof. S. J.), the Misti (Peruvian Andes) Meteorological Station, 229  
 Bailey (Vernon), the Spermophiles of the Mississippi Valley, 36  
 Bain (T. C.), Death of, 12  
 Bain (Captain), Effect of Reversing Screw of Steamship on Steering, 208  
 Baker (H. F.), the Applications of Elliptic Functions, Alfred George Greenhill, F.R.S., 359  
 Baker (Sir Samuel), Obituary Notice of, 227  
 Bakerian Lecture, the, 392; Prof. T. E. Thorpe, F.R.S., and J. W. Rodger, 419  
 Bakhuizen (Prof.), the Variation of Latitude and Sea Level, 476; Rigidity of Earth, 476  
 Baldamus (Dr. A. K. E.), Death of, 81  
 Ball (Sir Robert S., F.R.S.), In the High Heavens, R. A. Gregory, 243; The Story of the Sun, A. Fowler, 382  
 Ball (Dr. V.), Volcano Folk-lore of India, 109  
 Balland (M.), Sterilisation of Bread and Biscuit by Baking, 167  
 Balloon Ascents at Munich, Nocturnal, 416  
 Balloon Ascents, Electric Measurements made during, Prof. Börnstein, 595  
 Baly (Mr.), New High Temperature Thermometer, 538  
 Bamber (E. F.), Electric Traction, 567  
 Barcena (Señor M.), Climate of Mexico City, 229  
 Barell (Prof. F. R.), Separation of three Liquids by Fractional Distillation, 93  
 Barford (J. G.), Death of, 63  
 Barillé (M.), Electric Alarm Thermometer for Laboratory Ovens, 355  
 Barium, the Atomic Weight of, Prof. Richards, 562  
 Barnard (Prof. E. E.), Brooks's New Comet (1893c), 67; Period of Jupiter's Fifth Satellite, 85; Photographic Nebulosity in the Milky Way, 511  
 Barometer, Bartrum's Open-scale, J. J. Hicks, 488  
 Barometer, Compensating Open-scale, Mr. Griffiths, 379  
 Bartrum's Open-scale Barometer, J. J. Hicks, 488  
 Barus (Dr. Carl), the Cloudy Condensation of Steam, 363  
 Basaltic Andesite of Glasdrumman Port, co. Down, Derived Crystals in, 499  
 Base-forming Element, Iodine as a, Prof. Victor Meyer and Dr. Hartmann, A. E. Tutton, 442  
 Basset (A. B., F.R.S.), A Treatise on Dynamics, W. H. Besant, 146; Stability of Deformed Elastic Wire, 215; the Foundations of Dynamics, 529  
 Batacchi Independenti, Fra i, Elio Modigliani, 314  
 Bath (W. H.), Vertical Distribution of British Lepidoptera, 346  
 Bather (F. A.), the Zoological Record, 53, 198  
 Bavaria, Geological Survey Department of, 322  
 Beadle (C.), the Decomposition of Liquids by Contact with Cellulose, 457  
 Beare (Prof. T. H.), the Research Committee on Marine Engine Trials, 350  
 "Beats," the Origin of, K. L. Schaefer, 370  
 Beats in Luminous Vibrations, on the Phenomenon of, Dr. J. Verschaefelt, 617  
 Beaulard (F.), Optical Properties of Quartz Plate compressed perpendicularly to Axis, 37  
 Becher (H. M.), the Death of, 112  
 Beddard (Frank E., F.R.S.), an Ornithological Retrospect, 31; the Fauna of the Victoria Regia Tank in the Botanical Gardens, 247  
 Bedell, Miller and Wagner (Messrs.), New Form of Contact Maker, 37  
 Beecher (C. E.), Larval Form of *Triarthrus*, 92; the Thoracic Legs of *Triarthrus*, 214; the Appendages of the Pygidium of *Triarthrus*, 617  
 Bees and Dead Carcasses, W. F. Kirby, 555  
 Beetles of New Zealand, W. F. Kirby, 459  
 Behn (U.), Peculiarities of Electrical Deposit of Silver on Platinum, 321  
 Behrens (Prof.), (1) the Structure of Native Gold, (2) Chemical Composition of Alloys, 144  
 Belgique, Bulletin de l'Académie Royale de, 283, 376  
 Belgium, Neolithic Discoveries in, 227  
 Beneden (Prof. P. van), Death of, 251; Obituary Notice of, 293  
 Beni Hasan, G. W. Fraser, 169; P. E. Newberry, 169, 432  
 Bennett (Dr. Geo.), Death of, 63  
 Bent (J. T.), The Sacred City of the Ethiopians, 314  
 Bent's (Mr. Theodore), Expedition, Return of, 487  
 Bentley (Prof. R.), Death of, 228  
 Benzene Nucleus, Further Light upon the Nature of the, A. E. Tutton, 614  
 Berlin, the Temperature in and outside, Prof. G. Hellmann, 460  
 Berlin Geographical Society, the Greenland Expedition of the, 399  
 Berlin Meteorological Society, 48, 216, 427, 596  
 Berlin Physical Society, 48, 167, 216, 356, 427, 595  
 Berlin Physiological Society, 48, 167, 240, 380, 427, 596  
 Bernard (H. M.), the Stigmata of the Arachnida, as a Clue to their Ancestry, 68; the Systematic Position of the Tribolites, 521  
 Berson (M.), Mutual Action of Bodies Vibrating in Fluid Media, 143  
 Berthelot (M.), Spontaneous Heating and Ignition of Hay, 240; Formation of Carbon Dioxide and Absorption of Oxygen by Detached Leaves of Plants, 284  
 Bertrand (C. E.), General Characters of Bogheads produced by Algae, 47  
 Bertrand (G.), Poisonous Principles of Adder's Blood, 284; Viper Poison, 380  
 Besant (W. H.) A Treatise on Dynamics, A. B. Basset, F.R.S., 146  
 Bezold (Prof. von), Wave Clouds, 48; Various Modes of Discriminating between Clouds, 427; Cloud-Formation, 508  
 Bicalic Phosphate, Action of Water on, A. Joly and E. Sorel, 572  
 Bidwell (Shelford, F.R.S.), the Cloudy Condensation of Steam, 212, 388, 413  
 Biela Meteors, 67  
 Bigelow (F. H.), Recurrence of Hurricanes in Solar Magnetism 26-68 day period, 330  
 Bigourdan (M.), Magnitude and Position of T Aurigæ, 85  
 Bile Ducts, on Absorption by the, Célestin Tobias, 617  
 Billroth (Prof.), Death of, 345  
 Biology: Reappearance of the Freshwater Medusa (*Limnocoidium Sowerbii*), Prof. E. Ray Lankester, F.R.S., 127; Text-Book of Biology, H. G. Wells, 148; Projected Marine Biological Station at Millport, N.B., 180; Death of Dr. Chabry, 158; Biologie der Pflanzen, 306; Forschungsberichte aus der Biologischen Station zu Plön, Dr. O. Zacharias, 385; Biology as it is applied against Dogma and Freewill, and for Weismannism, H. Croft-Hiller, 386; the Macleay Memorial Volume, 597; the Naples Zoological Station, 604; Marine Biology, the Pteropod Collections of the *Albatross*, 36; Week's Work of Plymouth Station, 37, 67, 84, 162, 323, 372, 418; Some Laboratories of Marine Biology, 70; the Protective Colouration of *Vibrios varians*, Prof. W. A. Herdman, F.R.S., 417; the Floor of the Ocean at Great Depths, Dr. John Murray, 426; Entomostraca and Surface-film of Water, D. J. Scourfield, 474; the Rovigno Station, 560; the Melbourne Exhibition Aquarium, 583  
 Bionomie des Meeres, Johannes Walther, 244  
 Birch, the Embryonal Development of the, S. Nawaschin, 23  
 Bird Life in Arctic Norway, Robert Collett, 599  
 Bird Protection Bill, the New, 54  
 Birds: Are Birds on the Wing Killed by Lightning? Skelfo, 577; G. W. Murdochs, 601; the Early Return of Birds, Robert M. Prideaux, 578  
 Björling Arctic Expedition, the Fate of the, Capt. McKay, 85; Proposed Search for the, 606  
 Black Sea during Pliocene Age, N. Andrusoff, 23  
 Blackburn's Pendulum for Slow Production of Lissajous's Figures, Improved Form of, Prof. A. Righi, 582  
 Blakesley (T. H.), a New Electrical Theorem, 450  
 Bliss (Dr. C. B.), Investigations on Reaction-time and Attention, 439

- Bloch (Salvador), the use of Collodion Films coloured with Fuchsin in Measurements of Light-absorption, 108
- Blondlot's (M.) Experiments on Velocity of Propagation of Electric Disturbance along Wire, 37, 83; Experiments on Propagation of Hertzian Waves, M. Mascart, 394
- Blood, the Chemistry of the, and other Scientific Papers, L. C. Wooldridge, 259
- Blood Corpuscles, Determination of Volume of, Dr. Grijns, 476
- Boehm (Dr. J.), Death of, 179, 270
- Boiler Management and Construction, Marine, C. E. Stromeyer, 410
- Boltzmann (Dr. Ludwig), Lectures on Maxwell's Theory of Electricity and Light, 381
- Bolus (Henry), Icones Orchidearum Austro-Africanarum Extra-Tropicarum, R. A. Rolfe, 50
- Bonaparte's (Prince Louis Lucien) Library, Catalogue of, Victor Collins, 584
- Bone (W. A.), the Formation of Indoxazin Derivatives, 118
- Bonetti (M.), New Form of Electrical Machine, 460
- Bonn University, Hygienic Laboratory established at, 345
- Bonney (G. E.), Electrical Experiments, 386
- Bonney (Prof. T. G., F.R.S.), the Erosion of Rock-Basins, 52; the Scandinavian Ice-sheet, 388; Conversion of Compact Greenstones into Schists, 403; Recent Publications of the American Geological Survey, 434; the North-East Wind.—Devonian Schists, 577
- Bordage (Edmond), Obituary Notice of Paul Henry Fischer, 296
- Bordas (M.), Anatomy of the Trachean System of the Larvæ of Hymenoptera, 524
- Börnstein (Prof.), Electric Measurements made during Balloon Ascents, 595
- Borodin (Alexander), Steam-pumps on Russian Railways, 19
- Boron Carbide, Preparation and Properties of, M. Henri Moissan, 500
- Bort (L. Teisserenc de), Report on the Present State of our Knowledge respecting the General Circulation of the Atmosphere, 217
- Botany: The Embryonal Development of the Birch, L. Nawaschin, 23; the Shrubs of North-Eastern America, Charles S. Newhall, 28; the Caoutchouc of the Orinoco, Dr. Ernst, 35; Botanical Gazette, 46, 306, 424; Journal of Botany, 46, 330, 424; Localisation of Active Principles in Tropæolum, Léon Guignard, 47; Icones Orchidearum Austro-Africanarum Extra-Tropicarum, Henry Bolus, R. A. Rolfe, 50; Phanerogamic Botany of Matto Grosso Expedition, Spencer Moore, 95; Morphological and Micro-chemical Investigations on Physodes, E. Crato, 132; Memoirs of St. Petersburg Society of Naturalists, 189; Origin of Plants and Structures by Self-adaptation to Environment, Rev. G. Henslow, 166; Gynodiœcism (III), J. C. Willis, 167; Death of Dr. G. Boehm, 179, 270; British Fungus Flora, a Classified Text-book of Mycology, George Masee, Dr. M. C. Cooke, 195; the Laminariaceæ, W. A. Setchell, 207; Handbook of British Hepaticæ, M. C. Cooke, 220; Death of R. Bentley, 228; Death of R. Spruce, 228; Index Kewensis plantarum phanerogamarum nomina et synonyma omnium generum et specierum a Linnaeo usque ad annum mdccclxxxv complectens nomine recepto auctore patria unicuique plantae subjectis, 241; the Fauna of the Victoria Regia Tank in the Botanical Gardens, Frank E. Beddard, F.R.S., 247; Influence of Artificial Rain on Plants, Prof. J. Wiesner, 253; the Edible Lichen of Japan, Dr. M. Miyoshi, 253; Death of Baron K. von Küster, 270; the Internal Temperature of Trees, W. Prinz, 271; a Collection presented by Mr. H. Fisher to Nottingham Museum, 271; Formation of Carbon Dioxide and Absorption of Oxygen by Detached Leaves of Plants, MM. Berthelot and André, 284; an Elementary Text-book on Agricultural Botany, M. C. Potter, 290; Death of Dr. J. K. Hasskarl, 296; Dropsical Disease in Tomatoes, G. F. Atkinson, 298; the Original Home of Maize, Dr. Harshberger, 298; Cohn's Beiträge zur Biologie der Pflanzen, 306; Changes in position of Flower-stalk of *Cobaea scandens* before and after Flowering, Dr. M. Scholtz, 306; Embryology of *Gnetum*, G. Karsten, 306; Origin of Structural Peculiarities of Climbing Stems, Rev. G. Henslow, 307; Sugar Maples, W. Trelease, 323; Orchids, W. A. Styles, 352; the Solandi Sun-printing Process as applied to Botanical Technique, Prof. Byron Halsted, 370; Botanical Garden established in Mountains near Grenoble, 393; Nuovo Giornale Botanico Italiano, 424; Germination of Pollen Grain and Nutrition of Pollen Tube, Prof. J. R. Green, 424; the Fertilisation of some Species of Medicago, J. H. Barkill, 426; Apogamy in *Pteris serrulata* (L. fil.) var. *cristata*, A. H. Trow, 434; Measurements of Growth of Trees, J. Heuchler, 439; Der Botanische Garten "s Land's Plantentuin" 2 v. Buitenzorg auf Java, 453; Eine Botanische Tropenreise, Indomalayische Vegetationsbilder und Reiseskizzen, Dr. Haberlandt, 453; Growth of Mould-Fungi on Solid Compounds of Arsenic, S. Bapodo, 461; the Blind Root-suckers of the Sunderbans, 461; on the Irritability of Plants, Prof. F. Elfving, 466; Root-galls, Dr. M. Masters, 474; Origin of Filamentous Thallus of *Dumontia siliformis*, George Brebner, 474; Illustrated Guide to British Mosses, H. G. Jameson, 479; the Flowering Plants of Western India, Rev. A. K. Nairne, 501; Remarkable Section of *Sequoia gigantea* acquired by British Museum, 507; Cause of Extinction of Pine in South of England, Clement Reid, 522; Growth of Wellingtonia, Mr. Carruthers, 522; Peculiar Method of the Development of the Axillary Buds of *Vanda teres*, Henry Dixon, 523; *Deherainea smaragdina*, J. C. Willis, 523; Death of Dr. G. A. Weiss, 538; Grundzüge einer Entwicklungsgeschichte der Pflanzenwelt Mitteleuropas seit dem Ausgang der Tertiärzeit, Dr. August Schulz, 533; the Royal Botanic Gardens, Péradeniya, Henry Trimen, F.R.S., 539; Botany of Death Valley, California, F. V. Coville, 583; Irritability of Plants, Prof. F. Elfving, 466; Prof. Pfeffer, 586; Anatomical Modifications of Plants of the same Species in the Mediterranean Region and in the Region of the Neighbourhood of Paris, W. Russell, 620
- Bottom (S. R.), How to manage the Dynamo, 363
- Boulenger (Mr.), a Nothosaurian Reptile from the Trias of Lombardy, 95
- Bourke (Capt. J. G.), the Medicine-men of the Apache Indians, 439
- Bovey, Lignite Age of the, A. R. Hunt, 600
- Bowen (Lord), Death of, 558
- Boyle (Frederick), the Orchid Seekers, 28
- Boys (Prof. C. V., F.R.S.), the Attachment of Quartz Fibres, 450
- Boys (Prof.), Arithmometers, 618
- Bozward (Lloyd), the Earthquake of November 2, 1893, at Worcester, 35; Brilliant Daylight Meteor seen near Worcester, 368
- Branly (Edward), Conductibility of Discontinuous Conducting Substances, 404
- Brauns (Dr. D. A.), Death of, 179
- Brazil, the supposed Glaciation of, W. T. Thiselton-Dyer, F.R.S., 4
- Brebner (George), on the Development of the Mucilage Canals of the *Marattiaceæ*, 523
- Bredikhin (Th.), the Perseids observed in Russia in 1892, 23
- Bricout (G.), Ceric Bichromate and Separation of Cerium from Lanthanum and Didymium, 308
- Briggs (William), Mensuration of the Simpler Figures, 28; Worked Examples in Co-ordinate Geometry, 52; the Geometrical Properties of the Sphere, 75
- British Forest Trees, J. Nisbet, 1
- British Fungus Flora; a Classified Text-book of Mycology, George Masee, Dr. M. C. Cooke, 195
- British Institute of Preventive Medicine, the Directorship of the, Prof. Chas. S. Roy, F.R.S., 269; Sir J. Fayer, F.R.S., 292; Prof. Victor Horsley, F.R.S., 292
- British Isles, Afforestation in the, Prof. W. R. Fisher, 601
- British Isles, Rainfall Records in, G. J. Symons, 438
- British Mosses, Illustrated Guide to, H. G. Jameson, 479
- British Museum, Remarkable Section of *Sequoia gigantea* acquired by, 507
- Brodie (F. J.), the Great Drought of 1893, 119
- Brögger (Prof. W. C.), Basic Eruptive Rocks of Gran, 142
- Brooks' Comet (October 16) 1893, 39
- Brooks, the Tail of Comet (c 1893), 210, 233
- Brooks' New Comet (c 1893), Prof. E. E. Barnard, 67
- Brooks (W. R.), a Comet Finder, F. W. Muck, 543
- Brough (Bennett H.), Iron Ores of Great Britain and Ireland, J. D. Kendall, 27
- Brown (Prof. Crum), on the Division of a Parallelepiped into Tetrahedra, 571

- Brown (E.), a Curiosity in Eggs, 317  
 Browne (Dr. C. R.) the Ethnography of the Aran Islands, County Galway, 468  
 Browne (Edward G.), a Year amongst the Persians, 528  
 Brown-Séguard (Dr., F. R. S.), Death of, 538; Obituary Notice of, 556  
 Brubaker (Dr. A. P.), Radius and Curvature of Cornea, 229  
 Brucchiotti (G.), Effect of Absorption of Hydrogen on Thermo-Electric Power and Electrical Resistance of Palladium, 65  
 Bruce (A. L.), Death and Obituary Notice of, 134  
 Brussels, Institutes of Physiology on Electro-Biology established by M. G. Solvay at, 180  
 Bryan (G. H.), Worked Examples in Co-ordinate Geometry, 52; the Second Law of Thermodynamics, 197; a Simple Contrivance for Compounding Elliptic Motions, 498; on the Buckling and Wrinkling of Plating supported on a Framework under the Influence of Oblique Stresses, 499  
 Bubbles in Tubes, on the Motion of, 351  
 Buda-Pesth, Bacteriological Institute established at, 393; an Estimate of the Degree of Legitimate Natality, as shown in the Table of Natality compiled from Observations made at, Joseph Korösi, 570; Results derived from the Natality Table of Korösi, Francis Galton, F. R. S., 570  
 Bugonia-Superstition of the Ancients, on the, Baron C. R. Osten-Sacken, 198  
 Buller (Ernest Wentworth), Navigation by Semi-Azimuths, 223  
 Bulletin de l'Académie Royal de Belgique, 283, 376, 546, 617  
 Bulletin de l'Académie des Sciences de St. Petersburg, 23  
 Bulletin of New York Mathematical Society, 71, 188, 330, 402, 497, 570  
 Bulletins de la Société d'Anthropologie de Paris, 306, 330  
 Bulletin de la Société des Naturalistes de Moscow, 189  
 Bullets Infected with Micro Organisms, Herr Messner's Experiments with, 16  
 Bülow (Baron von), Death of, 106  
 Burbury (S. H., F. R. S.), the Second Law of Thermodynamics, 150, 246; the North-East Wind, 481  
 Burkill (J. H.), the Fertilisation of some Species of Medicago, 426  
 Burnside (Prof. W., F. R. S.), Note on the Theory of Groups of Finite Order, 118; on the Sextic Resolvent of a Sextic Equation, 618  
 Busquet (J. Rodet et), Les Courants Polyphases, 122  
 Butler (Edward A.), Our Household Insects, an Account of the Insect Pests found in Dwelling-houses, 147  
 Butterflies and Moths of Teneriffe, the, A. E. Holt White, W. F. Kirby, 384  
 Byerly (W. E.), an Elementary Treatise on Fourier's Series, and Spherical, Cylindrical and Ellipsoidal Harmonics with Applications and Mathematical Physics, 598
- Cable, Submarine, between Zanzibar, Mauritius, and Seychelles, 134  
 Cacao-Seed, Transportation of, (J. H. Hart), 64  
 Cain, (Dr. John Cannell), Chemistry in Space, 173; Mechanics of Interaction of Ethyl Alcohol and Hydrogen Chloride, 274  
 Cajal (Prof. Ramon y), the Minute Structure of the Nerve Centres, 464  
 Calculating Machines, Mathematical, Prof. O. Henrici, F. R. S., 521  
 Calderon (Dr. L.), Death of, 507  
 California, the Earthworms of, Gustav Eisen, 207  
 California, the Climate of Southern, Dr. C. Theodore Williams, 307  
 California, Proposed Quarantine Legislation against Insect Pests in, 508  
 California; Botany of Death Valley, F. V. Coville, 583  
 Calmette (A.), Inoculation against Serpent-Poison, 548  
 Calvert (Albert F.), the Discovery of Australia, 28  
 Calvert (Philip P.), the Postal Transmission of Natural History Specimens, 314  
 Cambridge Diploma in Agriculture, 444  
 Cambridge Philosophical Society, 143, 166, 378, 424, 452, 523  
 Cameron (Captain Verney Lovett), Obituary Notice of, 537  
 Camerons, the German Expedition to Delimit Hinterland of, Dr. Passarge, 606  
 Campbell (Prof. W. W.), Hydrogen Envelope of the Star D.M. + 30° 3639, 210; the Spectrum of Nova Normæ, 586  
 Campetti (A.), Difference of Potential between Aqueous and Alcoholic Solutions of same Salt, 560  
 Canada, Agricultural Resources of, Prof. Long, 561  
 Canada, Discovery of Deposits of Infusorial Earth in, 416  
 Canadian Geological Survey, the, 438  
 Canadian Ice Age, the, Sir J. W. Dawson, F. R. S., 552  
 Canary Islands, Temperature, Rainfall, and Sunshine of Las Palmas, Dr. J. C. Taylor, 425  
 Cancani (Dr. A.), a New Time-Registering Photographic Seismograph, 64  
 Cancer, Sarcoma, and other Morbid Growths considered in Relation to the Sporozoa, J. Jackson Clarke, 502  
 Cancer, the C. C. Walker Prize for Investigation of, 508  
 Caoutchouc of the Orinoco, the, Dr. Ernst, 35  
 Capus (G.), Ethnical Migrations in Central Asia, from a Geographical Point of View, 593  
 Carbon, a New Sulphide of, A. E. Tutton, 275  
 Carcasses, Bees and Dead, W. F. Kirby, 555  
 Cardiff, Roman Villa near, John Storrie, 605  
 Cardinal Points of the Tusayan Villagers, on the, J. Walter Fewkes, 388  
 Carlisle Institute of Science, Art and Literature, Opening of, 63  
 Carr (F. H.), Action of Heat on Aconitine, 377  
 Carr (Henry), Key to Mr. J. B. Lock's Shilling Arithmetic, 480  
 Carrington (Mr.), Science at the Free Libraries, 418  
 Carroll (J.), a Key to Carroll's Geometry, 75  
 Carruthers (Mr.), Growth of Wellingtonia, 522  
 Carus (A. des), Tree Pruning, 526  
 Catalan (Eugene), Death of, 415; Obituary Notice of, 437  
 Catania, Solar Observations at, 67  
 Cattell (Prof.), Reaction-times and Velocity of Nervous Impulse, 462  
 Caucasus, Geography in, 515  
 Caucasus, Lake-desiccation on Northern Slopes of, K. N. Rossikoff, 515  
 Cavallo (W.), Colouring Matter of Tesu, 377  
 Caves: the Har Dalam Cavern and its Ossiferous Contents, 514  
 Celebes, Flattening of Chest and Skull in, Baron von Hoëvell, 377  
 Celestial Objects for Common Telescopes, Rev. T. W. Webb, 339  
 Cellulose, the Decomposition of Liquids by Contact with, C. Beadle, 457  
 Centipedes and their Young, F. W. Ulrich, 531  
*Century Magazine*, Science in the, 352, 543  
 Cerebellum, Functions of, Dr. J. S. R. Russell, 354  
 Ceylon, the Royal Botanic Gardens, Péradeniya, Harry Trimen, F. R. S., 539  
 Chabry (Dr.), Death of, 158  
 Chamberlin (T. C.), Further Studies of the Drainage Features of the Upper Ohio Basin, 617  
 Chambrelent (M.), the Grape-Vine Harvest of 1893, 47; Death of, 81  
 Chances, a Plausible Paradox in, Francis Galton, F. R. S., 365; Lewis R. Shorter, 413  
 Chandler (A.), the Climate of Torquay, 253  
 Chandler (Prof. S. C.), the Variation of Latitude, 133  
 Chanler's (Astor), East African Expedition, 112, 301  
 Chapman (Dr. H. C.), Radius of Curvature of Cornea, 229  
 Charpy (G.), the Transformation of Iron, 192  
 Charrin (M.), the Action of Sunshine on Microbes, 417  
 Chassavant (A.), Influence of Metallic Salts on Lactic Fermentation, 96  
 Chatir (Ad.), a Chemical Study of Green Colouration in Oysters, 263  
 Chauveau (A. B.), Diurnal Variation of Atmospheric Electricity, 240  
 Chemistry: Inorganic Chemistry for Beginners, Sir Henry Roscoe, F. R. S., 3; the Chemistry of Fire, M. M. Pattison Muir, 3; on the Latent Heat of Steam, P. J. Hartog and J. A. Harker, 5; Carbide of Silicon as Manufactured by Dr. Mühlhäuser's Process, 17; Analysis of a Vanadiferous Oil, A. Mourlot, 24; Chemical Conditions of Activity of Brewer's Yeast, J. Effront, 24; Effect of Electrolytic Dissociation on Magnetic Rotatory Polarisation of Solutions, Herr Humburg, 37; Ethyl and Methyl Derivatives of Hydroxylamine, Dr. Kjellin, 38; Death of J. G. Barford, 63; Influence of Heat

on Reactions in Aqueous Solutions containing Ferric Chloride and Oxalic Acid, M. Lemoine, 65; Compound of Carbon Monoxide with Potassium and Sodium, M. Joannis, 66; Determination of True Atomic Weight of Nitrogen, G. Hinrichs, 96; the Nitrication of Prairie Lands, J. Dumont and J. Crochetelle, 96; Influence of Metallic Salts on Lactic Fermentation, A. Chassevant and C. Richet, 96; the Preparation and Properties of Free Hydroxylamine, A. E. Tutton, 105; Isocyanogen Tetrabromide, Dr. Thiele, 110; Researches on Melting Points of Refractory Inorganic Salts, Prof. Victor Meyer and Dr. Riddle, 110; Chemical Society, 118, 142, 239, 306, 377, 425, 459, 523; the Action of Bromine on Azobenzene, a Correction, H. E. Armstrong, 118; Coloured Hydrocarbons, H. E. Armstrong, 118; the Action of Aluminium Chloride on Heptylic Chloride, 118; the Interaction of Chlorine and Lime, V. H. Veley, 118; Note on Hyponitrites, D. H. Jackson, 118; the Interaction of Hydrogen Chloride and Potassium Chloride, W. H. Pendlebury and Mr. McKillop, 118; the Formation of Indoxazin Derivatives, W. A. Bone, 118; Synthesis of Piazine Derivatives, A. P. Mason and G. Winder, 118; Preparation of  $\alpha$ - $\beta$ -diphenylindoles from Benzoin and Primary Benzenoid Amines, F. R. Japp and T. S. Murray, 118; the Freezing-points of Dilute Aqueous Solutions, Harry C. Jones, 132; Freezing-points of Alloys in which the Solvent is Thallium, C. T. Heycock and F. H. Neville, 239; Freezing-points of Triple Alloys, C. T. Heycock and F. H. Neville, 306; Ethereal Salts of Diacetylglyceric Acid in relation to Connection between Optical Activity and Chemical Constitution, P. Frankland and J. McGregor, 142; Oxidation of Paratoluidine, A. G. Green, 142; Formation of Benzoic Derivatives of Urochrome, J. L. W. Thudichum, 142; Combination of Hydrocarbons with Picric Acid, W. A. Tilden and M. O. Forster, 142; Conversion of  $\alpha$ -hydrindonoxime into Hydrocarbostyryl, F. S. Kipping, 142; the Temperature of Ignition of Explosive Gaseous Mixtures, A. E. Tutton, 138; the New Laboratories of the Institute of Chemistry, 154; General Method of Artificially Reproducing Crystallised Anhydrous Silicates, Dr. Hermann Traube, 161; Stability and Conservation of Dilute Solutions of Corrosive Sublimate, Léo Vigron, 167; Discovery of Abrastol in Wines, M. Sangle-Ferrière, 167; Chemistry in Space, Dr. John Cannell Cain, 173; Mr. M. C. Lea's Researches on Transformation of Mechanical Work into Chemical Action, 181; a New Process for the Preparation of Ethers, A. E. Tutton, 184; Death of Dr. E. Lellmann, 206; the Explosive Metallic Derivatives of Acetylene, Dr. Keiser, 209; Occluded Gas contained in Oxides of Copper, Zinc, Nickel, and Magnesium prepared by Ignition of Nitrate, Messrs. Richards and Rogers, 209; Methods of Coating Aluminium with other Metals, Prof. Neesen, 216; Voices from Abroad, Prof. Henry E. Armstrong, F.R.S., 225; Properties of Mirror Silver Chemically Precipitated on Glass, Herr H. Lütke, 229; Cause of Explosion on Contact of Metallic Sodium with Water, Prof. Rosenfeld, 232; Gases Occluded in Coal from Various Durham Collieries, 232; Chemical Action of Marine Organisms, Prof. J. W. Judd, 235; Magnetic Rotations of Hydrogen and Sodium Chlorides and Chlorine in different Solvents, W. H. Perkin, 239; Bromolapachol, S. C. Hooker, 239; Nucleic Acid, Prof. A. Kossel, 240; Chemical Action in Spontaneous Ignition of Hay, M. Berthelot, 240; Practical Agricultural Chemistry for Elementary Students, J. Bernard Coleman and Frank T. Addyman, 244; New Compounds of Formaldehyde, M. Henry, 255; New Method of Preparing Halogen Substitution Products of Oxides (Ethers) of Alkyl Radicles, M. Henry, 255; a New Isomeride of Cinchonine, E. Jungfleisch and E. Léger, 263; Chemical Study of Green Colouration in Oysters, Ad. Chatin and A. Muntz, 263; Composition of Waters of Dranse du Chablais and Rhone at Entrance into Lake of Geneva, A. Delebecque, 264; Decomposition of Liquids by Contact with Powdered Silica, Dr. G. Gore, 272; Proposed Standard of Normal Air, A. Leduc, 272; Mechanics of Interaction of Ethyl Alcohol and Hydrogen Chloride, Cannell Cain, 274; a New Sulphide of Carbon, A. E. Tutton, 275; on the Chemistry of the Blood, and other Scientific Papers, L. C. Wooldridge, 289; a Lecture Experiment, G. S. Newth, 293; Isolation of Pure Di-nitro Derivative of Marsh Gas, Dr. Paul Duden, 299; New Mode of Preparing Methylamine and Ethylamine, MM. Trillat and Fayollat, 300; Synthesis of Lapachol, S. C.

Hooker, 306; Ceric Bichromate and Separation of Cerium from Lanthanum and Didymium, G. Bricout, 308; the Essentials of Chemical Physiology, Prof. W. D. Halliburton, 313; New Method of Preparing Phosphorus, Messrs. Rossel and Frank, 323; Interaction between Oxygen and Phosphoretted Hydrogen, Dr. van der Stadt, 323; Death of Prof. Edmond Frémy, 345; Recent Progress in Stereo-Chemistry, Prof. Victor Meyer, 348; Extension of Stereo-Chemistry to Inorganic Elements, Dr. Werner, 372; *Handbuch der Stereochemie*, Dr. Paul Walden, 409; Thermal Constants of some Polyatomic Bases, MM. Colson and Darzens, 356; Adaptation of Alcoholic Ferments to Presence of Hydrofluoric Acid, E. Sorel, 356; New Boron Compounds, Prof. Michaelis, 371; Preparation and Properties of Boron Carbide, Henri Moissan, 500; New Processes for Detection of Vegetable and Mineral Oils, W. de la Royère, 377; Molecular Formulæ of some Liquids as Determined by their Molecular Surface Energy, Miss E. Aston and W. Ramsay, 377; Action of Heat of Aconitine, W. R. Dunstan and F. H. Carr, 377; Colouring Matter of Tesu, J. J. Hummel and W. Gwallo, 377; Interaction of Benzylamine and Ethylic Chloracetate, A. T. Mason and G. R. Winder, 377; Thermal Value of Replacement of Phenolic Hydrogen in Orcin, M. de Forcrand, 379; Campholene, M. Guerbert, 379; Two Camphoramic Acids, Messrs. Hoogewerff and van Dorp, 380; Comparison of Zinc and Copper Salts of Frankland's Dinitromethyllic Acid with those of Methylnitramine, Messrs. Franchimont and H. van Erp, 380; Dictionary of the Active Principles of Plants, C. E. Sohn, 385; Polymeric Modifications of Acetic Aldehyde, Messrs. Andorff and White, 396; Chemical Composition of Staurolite, S. L. Penfield and J. H. Pratt, 402; Celebration of Centenary of Birth of Friedlieb F. Runge, 415; the Atomic Weight of Palladium, Prof. Keiser, 418; the Artificial Preparation of the Diamond, M. Moissan, 418; the Bakerian Lecture, Prof. T. E. Thorpe, F.R.S., and J. W. Rodger, 419; Action of Heat upon Ethylene, Prof. Vivian B. Lewes, 424; Liberation of Chlorine during Heating of Mixture of Potassium Chloride and Manganic Peroxide, H. McLeod, 425; Salts of Dehydracetic Acid, J. N. Collie and H. R. Le Sueur, 425; Iodine as a Base-forming Element, Prof. Victor Meyer and Dr. Hartmann, A. E. Tutton, 442; the New Iodine Bases, Prof. Victor Meyer and Dr. Hartmann, A. E. Tutton, 467; Analytical Determination of probably available "Mineral" Plant Food in Soils, B. Dyer, 451; Stability of Oxides in Relation to Periodic Law, G. H. Bailey, 451; Action of Heat on Potassium and Sodium Ruthenium Nitrites, A. A. Joly and E. Leidić, 452; New Ptomaine extracted from Damaged Cheese, Charles Lepierre, 452; Crystallised Calcium Carbide prepared by Means of Electric Furnace, Henri Moissan, 475; Determination of Specific Gravity of Melted Magnesia, Henri Moissan, 475; Exact Atomic Weights, with Silver as Standard, G. Henrichs, 476; Alloys of Iron and Nickel, F. Osmond, 476; Isomerism of Nitro-benzoic Acids, Oechsner de Coninck, 476; Isolation of New Crystallised Compounds of Hydroxylamine with Chlorides and Sulphates of Cobalt and Manganese, Dr. Feldt, 489; Death of Dr. L. Calderon, 507; Death of Dr. Karl Schmidt, 507; Compound of Sugars with Mercaptans, Emil Fischer, 510; Chloraurate of Silver, Dr. Hermann, 510; Amides of Sodium, Potassium, and Lithium, A. W. Titherley, 523; Molecular Weight of Ferric Oxide, P. T. Muller, 524; Hydrate of Nitrous Oxide, M. Villard, 524; on Thallium Hypophosphates, M. A. Joly, 524; on  $\beta$ -dibromopropionic Acid, Thomas Mamert, 524; Prof. Ira Remsen on Chemical Laboratories, 531; Death of Dr. W. H. Delff, 538; the Gaseous Fluorides of the Simpler Organic Radicles, M. Meslans, 541; Fluoroform Prepared in Pure State, M. Meslans, 542; Refractometer applied to Study of Chemical Reactions, J. Verschaefelt, 546; Study of Crystallised Acetylides of Barium and Strontium, Henri Moissan, 548; Two Isomeric Methylcyanocamphors, A. Haller and Minguin, 548; Action of Nitrogen, Nitrous Oxide, and Nitric Oxide on Alkaline Ammoniums, A. Joannis, 548; Essays in Historical Chemistry, T. E. Thorpe, F.R.S. and M. M. Pattison Muir, 551; the Manufacture of Gas, C. Hunt, 561; the Atomic Weight of Barium, Prof. Richard, 562; Action of Water on Bicalcic phosphates, A. Joly and E. Sorel, 572; the Effect of Wave-Length in dealing with Refractive Index in elucidation of Chemical Constitution, MM. Jahn and

- Möller, 582; Artificial Preparation of Christobalite, Dr. K. von Chrustschoff, 584; Lecture Demonstration of Electrolysis of Hydrochloric Acid, Prof. Lothar Meyer, 584; the Preparation of Hydrazine Salts from Diazo-derivative of Acetic Acid, Prof. Curtius and Dr. Jay, 585; Chemistry in Relation to Pharmaco-Therapeutics and Materia Medica, Prof. B. J. Stokvis, 587; on the Fusibility of Mixtures of Salts, M. H. le Chatelier, 595; Action of Halogens on Homopyrocatechol, H. Cousin, 595; Further Light upon the Nature of the Benzene Nucleus, A. E. Tutton, 614
- Chevalier (Rev. S.), the Typhoons of 1892, 560
- Chicago, Foundation of International Horticultural Society at, 13
- Chicago, the Climate of, Prof. H. A. Hazen, 15
- Chicago, Projected Museum at, 64
- Chili, Fractures of Coal-Measures of Southern, A. E. Noguès, 47
- Chinese Central Asia: a Ride to Little Tibet, Henry Lansdell, W. F. Kirby, 309
- Cholera: Virulence of Cholera Bacillus increased by Salt, Dr. Gamaleia, 132; Sand Filtration as a means of Purifying Water, Mrs. Percy Frankland, 156; Cholera Epidemic: Meteorological Conditions of Hamburg, Captain C. H. Seemann, 180; Les Vibrions des Eaux et l'Étiologie du Choléra, Dr. Sanarelli, 231; an Incident in the Cholera Epidemic at Altona, Prof. Percy Frankland, F.R.S., 392; Cholera, Dr. E. Klein, F.R.S., 492
- Chorley (Mr.), New High Temperature Thermometer, 538
- Christobalite, Artificial Preparation of, Dr. K. von Chrustschoff, 584
- Christy (Miller), Scheme for Mapping Geographical Distribution of Vertebrates, 35
- Chrono-Photographic Study of the Locomotion of Animals, 41
- Chrustachoff (Dr. K. von), Artificial Preparation of Christobalite, 584
- Cider-Apple, Development and Maturation of the, L. Lindet, 119
- Cigars, Possible Transmission of Tubercle Bacillus by, Dr. Kerez, 371
- City and Guilds of London Institute for 1893, Work of, 607
- Civilisation, the Future of, Benjamin Kidd, Dr. Alfred R. Wallace, 549
- Clark (Sir Andrew), Death of, 33; Obituary Notice of, 6
- Clark (W. B.), the Cretaceous and Tertiary Formations of New Jersey, 347; Climatic Features of Maryland, 423
- Clarke (J. Jackson), Cancer, Sarcoma, and other Morbid Growths considered in relation to the Sporozoa, 502
- Clarke (W. E.), Threatened Extermination of the Great Skua, 253
- Claude (G.), Means of Increasing Security of High Tension Alternate Current Distribution, 119; Experiments on Electric Arc in Alternating Circuit, 441
- Clavel (G.), Forest Fires and Drought, 191
- Claybury, the Projected Pathological Laboratory at, 129
- Clayton (H. Helm), Six- and Seven-Day Weather Periods, 520
- Clerke (Agnes M.), a Popular History of Astronomy during the Nineteenth Century, 2
- Climate of South Damaraland, Dr. Karl Dove, 14
- Climatic and National Economic Influence of Forests, Dr. J. Nisbet, 302
- Cloud Formation, Prof. W. von Bezold, 508
- Cloud Nomenclature, Luke Howard, 607
- Cloud Photography, 267
- Clouds, the Measurement of the Highest Cirrus, Prof. C. Abbe, 508
- Clouds, the Motion of, M. Pomortseff, 230
- Clouds, Various Modes of Discriminating between, Prof. von Bezold, 427
- Cloudy Condensation of Steam, the, Shelford Bidwell, F.R.S., 212, 388, 413; John Aitken, F.R.S., 340; Dr. Karl Barus, 363
- Coal discovered at Port Jackson, 64
- Coal from various Durham Collieries, Gases occluded in, W. McConnell, 232
- Coal-balls and their Fossil-plant Contents, H. B. Stocks, 14
- Coal-gas: the New Process for Enriching with Oxy-oil Gas, Dr. L. T. Thorne, 162
- Cockerell (T. D. A.), Notes on the Habits of a Jamaican Spider, 412
- Cohn's Beiträge zur Biologie der Pflanzen, 306
- Cohnstein (Dr.), Influence of Diffusive Processes on Transudation, 48
- Cole (F. N.), Simple Groups as far as Order 660, 93
- Coleman (J. Bernard), Practical Agricultural Chemistry for Elementary Students, 244
- Collector's Handbook, the Outdoor World or Young, W. Furneaux, 52
- Collet (Robert), Bird Life in Arctic Norway, 599
- Collie (J. N.), Salts of Dehydracetic Acid, 425
- Collignon (Dr. R.), Proportion of Trunk among the French, 22
- Collins (Victor), Catalogue of Prince Louis Lucien Bonaparte's Library, 584
- Cologne, the Largest City (in area) in Germany, 85
- Colomb (Vice-Admiral, R.N.), the Manœuvring Powers of Steamships and their Practical Applications, 174
- Colour-Aberration of Refracting Telescopes, H. Dennis Taylor, 183
- Colour Vision, the Board of Trade and the Railway Companies, 558
- Colouring Lantern-slides for Scientific Diagrams, Method for, Dr. J. Alfred Scott, 572
- Colours, Painters', Oils and Varnishes, a Practical Manual, Geo. H. Hurst, 194
- Colson (Albert), Thermal Constants of some Polyatomic Bases, 356
- Columbus, Copy of Map by, 233
- Columbus's First Voyage in relation to Development of Oceanography, Dr. John Murray, 39
- Combustion Motors, Internal, Bryan Donkin, N. J. Lockyer, 430
- Comets: Brooks's (October 16), 18, 39; Brooks's New Comet (1893c), Prof. E. E. Barnard, 67; the Tail of Comet Brooks (1893), 210, 233; Mechanical Theory of Comets, Prof. J. M. Schaeberle, 84; a Remarkable Cometary Collision, 349; Halley's Comet, 442; Comet-Spectra as affected by Width of Slit, 489; a New Comet, 511, 562; the New Comet W. F. Denning, 531; Denning's Comet, 562; Ephemeris for Denning's Comet (1894), 586; a New Southern Comet, 586; Elements and Ephemeris of Gale's Comet, 608; a Mistaken Cometary Discovery, Prof. Krueger, 608
- Commission, the Report of the Gresham University, 405
- Commutator, a Liquid, for Sinusoidal Currents, Prof. J. A. Ewing, F.R.S., 317
- Composite Dykes, Henry E. Ede, 77
- Concave Gratings, the Astigmatism of Rowlands', 489
- Conchology: the *Albatross* collection of Galapagos Island Shells, Dr. Stearns, 82; Death of Paul Fischer, 158
- Condensation of Steam, the Cloudy, Shelford Bidwell, F.R.S., 212, 388, 413; John Aitken, F.R.S., 340; Dr. Carl Barus, 363
- Congo State and Portuguese Frontier, Delimitation of, 582
- Congress, the Eleventh International Medical, 538, 563; Piero Giacosa, 578
- Conics, an Elementary Treatise on the Geometry of, A. Mukhopadhyay, 75
- Coninck (Oechsner de), Isomerism of Nitrobenzoic Acids, 476
- Contemporary Review*, Science in the, 32, 155, 444
- Cook (Dr. F. A.), Scheme for Antarctic Exploration, 184
- Cooke (A. H.), Mimicry in Mollusca, 426
- Cooke (Dr. M. C.), British Fungus Flora, a Classified Text-book of Mycology, 195; Handbook of British Hepaticæ, 220
- Cooper's Island, U.S., Glacial Potholes of, W. O. Crosby, 160
- Copenhagen, Report for 1892 of Magnetic Observatory of, 298
- Cornu (A.), Numerical Verifications relating to Focal Properties of Plane Diffraction Gratings, 239; a Theorem Connecting Theory of Synchronisation with Theory of Resonance, 404
- Cornwall, the Charts of, Howard Fox, 82
- Correlation of Solar and Magnetic Phenomena, William Ellis, F.R.S., 30, 53, 78, 245; A. R. Hinks, 78; H. A. Lawrance, 101; Dr. M. A. Veeder, 245
- Coryndon (R. T.), Intended Expedition to Great Congo Forest, 606
- Cotes (E. C.), Dried Locusts as Food for Insectivorous Cage- and Game Birds, 253
- Cousin (H.), Action of Halogens on Homopyrocatechol, 595
- Cousin (Jean), the True Discoverer of America, Capt. Gambier, 235



- Coville (F. V.), Botany of Death Valley, California, 583  
 Cozens-Hardy's (W. H.) Journey through Montenegro, 461  
 Craniometry : Description of Sixty-two Crania taken from a Modern Cemetery at Karlsruhe, G. de Lapouge, 520  
 Crato (E.), Morphological and Microchemical Investigations on Physodes, 132  
 Crawford (J.), Evidence of Existence of Man in Nicaragua in Neolithic Age, 107  
 Crawshaw (Mr.), Visit to Nyika Plateau, 210  
 Crayfish, the Blind, W. P. Hay, 133  
 Criminals, Identification of Habitual : Proposed Anthropometrical Registry, 437  
 Critic Criticised, a, Dr. Alfred R. Wallace, F.R.S., 333  
 Crochetelle (J.), the Nitrification of Prairie Lands, 96  
 Croft (W. B.), Lecture-room Experiments on (1) Rings and Brushes in Crystal, and (2) Electric Radiation in Copper Filings, 47 ; some Phenomena of Diffraction, 354  
 Crosby (W. O.), Glacial Potholes of Cooper's Island, U.S., 160  
 Crustacea : a History of Crustacea, Recent Malacostraca, Rev. Thomas R. R. Stebbing, 74 ; the Blind Crayfish, W. P. Hay, 133 ; Entomostraca and Surface-film of Water, D. J. Scourfield, 474  
 Crystalline Schists of Devonian Age, Arthur R. Hunt, 554  
 Crystallisation in Super-cooled Substances, Velocity of, Mr. Moore, 130  
 Crystals : Lecture-room Experiments on Rings and Brushes in Crystals, W. B. Croft, 47 ; the Artificial Colouring of Crystals and Amorphous Bodies, O. Lehmann, 376 ; Instrument for accurately Grinding Section-plates and Prisms of Crystals, A. E. Tutton, 377 ; Derived Crystals in Basaltic Andesite of Glasdrumman Port, co. Down, 499  
 Csapodi (S.), Growth of Mould-fungi on Solid Compounds of Arsenic, 461  
 Cunliffe-Owen (Sir Philip), Death of, 507  
 Curie (M. P.), Magnetic Properties of Iron at Various Temperatures, 595, 620  
 Currents in the Great Lakes of North America, the, Prof. Mark W. Harrington, 592  
 Currents, Oceanic, Experiments with Floats on, 301  
 Curtius (Prof.), the Preparation of Hydrazine Salts from Diazo-Derivatives of Acetic Acid, 585  
 Curves, Asymmetrical Frequency, Prof. Karl Pearson, 6  
 Curves, Groups of Points on, F. S. Macauley, 498  
 Cvijic (Dr. Jovan), Das Karstphänomen, 197  
 Cyclones, on Mountain Observatories in connection with, M. Faye, 620  
 Czermak's (Herr P.), Photographs of Ascending Currents in Gases and Liquids, 15  
 Dall (W. H.), a Sub-Tropical Miocene Fauna in Arctic Siberia, 36  
 Dana (J. D.), New England, the Upper Mississippi Basin in the Glacial Period, 92  
 Danckelman (Dr.), Government Scientific Work in the German African Protectorate, 581  
 Daniel (John), Polarisation Phenomena upon Thin Metal Partitions, 347 ; Polarisation upon a Thin Metal Partition in a Voltmeter, 460  
 Darboux (M.), French Lady Mathematicians, 205  
 Darwin (Charles), Proposed Memorial at Shrewsbury to, 320  
 Darwinianism : Workmen and Work, Dr. James Hutchison Stirling, Dr. Alfred R. Wallace, F.R.S., 333  
 Darzers (Georges), Thermal Constants of some Polyatomic Bases, 356  
 Davidson (Prof. George), True Latitude reached by *Nevefort* Whaler, 369  
 Davis (W. G.), a South American Tornado, 263  
 Davis (W. M.), the Winds of the Indian Ocean, 263  
 Davison (Charles), the Recent Earthquake, 31  
 Dawkins (Prof. W. Boyd, F.R.S.), Obituary Notice of William Pengelly, 536  
 Dawson (Charles), Straining of Earth resulting from Secular Cooling, 424  
 Dawson (Dr. G. M., F.R.S.), Mammoth Remains in Canada and Alaska, 94  
 Dawson (Sir J. W., F.R.S.), some Salient Points in the Science of the Earth, 196 ; the Genus "Naaidites" occurring in Nova Scotia Coal Formation, 475 ; the Canadian Ice Age, 552  
 Day, the Reckoning of the Astronomical, 542  
 De Morgan Medal, the, A. B. Kempe, F.R.S., 80  
 Death-rate, Relation between Mean Quarterly Temperature and, D. H. Dines, 547  
 Decimal System, Introduction into Russia of, 129  
 Deeley (R. M.), Sir Henry Howarth and Geology in Nubibus, 122, 173 ; Dr. Alfred Wallace, F.R.S., 173  
 Deep-sea, the Fauna of the, Sydney J. Hickson, 502  
*Dehervinea smaragdina*, J. C. Willis, 523  
 Delafosse (Maurice), the Agni, a Tribe of Fair Negroes, 263  
 Delcommune (M.), Exploration of Lukuga River by, 559  
 Delebecque (A.), Observations on Amount of Solid Matter in Solution in Lake-water, 160 ; Composition of Waters of Dranse du Chablais and Rhone at Entrance into Lake of Geneva, 264  
 Delffs (Dr. W. H.), Death of, 538  
 Dembo (Dr.), the Humanest Method of Slaughtering Animals, 427  
 Demography, Public Health, and, Edward F. Willoughby, M.D., 285  
 Dendy (Dr. Arthur), Comparative Anatomy of Sponges. V. *Calaria heterocale*, 139  
 Denison's (Dr. Charles), Climates of United States, 396  
 Denmark, Central European Time adopted in, 228  
 Denning (W. F.), Jupiter and his Red Spot, 104 ; Fireballs, 434 ; the New Comet, 531 ; Denning's Comet, 562 ; Ephemeris for Denning's Comet (*a* 1894), 586  
 Denton (J. Bailey), Death of, 81  
*Deutsche Seewarte* Record of Meteorological Observations taken in North Atlantic, No. xi., 108  
*Deutsche Seewarte* Extra-European Meteorological Observations, 540  
 Devon (North), Earthquake in, 320  
 Devonian Age, Crystalline Schists of, Arthur R. Hunt, 554  
 Devonian Schists.—The North-East Wind, Prof. T. G. Bonney, F.R.S., 577  
 Dewar (T. J.), Spectacles for Double Vision, 433  
 Diamond, the Artificial Preparation of the, M. Moissan, 418  
 Diamond, the Thermal Expansion of the, Dr. J. Joly, F.R.S., 480  
 Diamond, the Artificial Formation of the, J. B. Hannay, Dr. J. Joly, F.R.S., 530  
 Dickens (F. Victor), the Teaching University, 536  
 Dielectricine, a New Insulating Material, M. Hurmuzescu, 370  
 Difference Terms, on Regular, A. B. Kempe, F.R.S., 618  
 Diffraction, some Phenomena of, W. B. Croft, 354  
 Digits of the Horse, on the Second and Fourth, Prof. Cossar Ewart, 571  
 Dines (W. H.), Relation between Mean Quarterly Temperature and Death-Rate, 547  
 Dinning (William), Death and Obituary Notice of, 81  
 Diprotodon and its Times, the, C. W. de Vis, 159  
 Directorship of the British Institute of Preventive Medicine, the, Prof. Chas. S. Roy, F.R.S., 269 ; Sir Joseph Fayrer, F.R.S., 292 ; Prof. Victor Horsley, F.R.S., 292  
 Disease, Zymotic, Distribution by Sewer Air of, Mr. Laws, 347  
 Disease and Race, Jadroo, 575  
 Ditté (A.), Action of some Metals upon Acid Solutions of their Chlorides, 119  
 Dixon (Edward T.), the Foundations of Dynamics, 578  
 Dixon (Henry), Peculiar Method of the Development of the Axillary Buds of *Vanda teres*, 523  
 Dixon (H. N.), Meteorology, 412  
 Dobson (B. A.), the Artificial Lighting of Workshops, 18  
 Dodd (H. W.), Relationship between Epilepsy and Errors of Refraction in Eye, 395  
 Dog, Prof. Golz's Research on a, which survived for a Long Time Extirpation of the Cerebrum, Prof. H. Munk, 596  
 Dogma and Freewill, Biology as it is applied against, and for Weismannism, H. Croft Miller, 386  
 Dolley (Prof.), Reaction Times and Velocity of Nervous Impulse, 462  
 Donkin (Bryan), a Text-book on Gas, Oil, and Air Engines, N. J. Lockyer, 430  
 Dorp (M. van), Two Camphoranic Acids, 380  
 Double Star Measures, Otto Struve's, 111

- Dove (Dr. Karl), Climate of South Damaraland, 14  
 Drainage Features of the Upper Ohio Basin, Further Studies of the, T. C. Chamberlin and Frank Leverett, 617  
 Dranse du Chablais at Entrance into Lake of Geneva, Composition of Water of, A. Delebecque, 264  
 Draper (C. H.), Heat, and the Principles of Thermodynamics, 148  
 Drawing, Machine, Thomas Jones and T. Gilbert Jones, 362  
 Dredging Expedition at Port Erin, Prof. W. A. Herdman, F.R.S., 503  
 Drought, Forest Fires and, E. Gaget and G. Clavel, 191  
 Drum Armatures and Commutators, the Construction of, F. M. Weymouth, E. Wilson, 478  
 Drumlins near Boston, U.S.A., Mr. Warren Upham's Theory of Formation of, 207  
 Dublin Area, Geology of, Prof. Sollas, 36  
 Dublin Royal Irish Academy, 523  
 Dublin Royal Society, 215, 379, 499, 572  
 Dubois (Marcel), the Classification of Rivers According to Size, 487  
 Duden (Dr. Paul), Isolation of Pure Di-nitro Derivative of Marsh Gas, 299  
 Dümichen (Prof. J. von), Death and Obituary Notice of, 393  
 Dumont (A.), Birth-rate in Canton of Beaumont-Hague, 283  
 Dumont (J.), the Nitrification of Prairie Lands, 96  
 Dunstan (W. R.), Action of Heat on Aconitine, 377  
 Dust and Meteorological Phenomena, John Aitken, F.R.S., 544  
 Dust-particles in Atmosphere of Certain Places, Number of, John Aitken, 426  
 Dwarf, Hindoo, Colonel A. T. Fraser, 35, 396; Dr. A. E. Grant, 221, 396  
 Dyer (B.), Analytical Determination of probably available "Mineral" Plant Food in Soils, 451  
 Dykes, Composite, Henry E. Ede, 77  
 Dynamics: Solutions of the Examples in the Elements of Statics and Dynamics, S. L. Loney, 122; a Treatise on Dynamics, W. H. Besant, A. B. Basset, F.R.S., 146; a Dynamical Theory of the Electric and Luminiferous Medium, Dr. Joseph Lamor, F.R.S., 260, 280; the Foundations of Dynamics, Prof. A. Gray, 389; Edward T. Dixon, 578; A. B. Basset, F.R.S., 529; the Dynamics of the Atmosphere, M. Möller, 422  
 Dynamo, How to Manage the, S. R. Boltone, 363  
 Dynamos, Alternators, and Transformers, Gisbert Kapp, 337  
 Dynamos, a Text-Book on Electromagnetism and the Construction of, Dugald C. Jackson, Prof. A. Gray, 429  
 Early Asterisms, J. Norman Lockyer, F.R.S., 199  
 Earth, the Mass of the, 575  
 Earth, some Salient Points in the Science of the, Sir J. William Dawson, F.R.S., 196  
 Earth, Condition of Interior of, Rev. O. Fisher, 379  
 Earth, Rigidity of, Prof. Bakhuyzen, 476  
 Earth, the Face of the, Prof. Chas. Lapworth, F.R.S., 614  
 Earth Currents, W. H. Preece, F.R.S., 554  
 Earth Movements, Prof. John Milne, F.R.S., 301  
 Earth Movements and the Question of the Cause of Glacial Conditions, Prof. Hughes, 426  
 Earthquakes: the Recent Earthquake, Charles Davison, 31; Earthquake in Wales and West of England, 34; a New Time-Registering Photographic Seismograph, Dr. A. Cancani, 64; Earthquake in Western Asia, 81; Earthquakes in Montreal and Peshawur, 106; the Earthquake of November 5 at Potsdam, 159; in Russian Turkestan, 159; Earthquake at Shepton Mallet, Prof. F. J. Allen, 229; the Mendip Earthquake of December 30-31, 1893, Prof. F. J. Allen, 245; Earthquake in North Devon, 320; Velocity of Earthquakes at Zante in 1893, Dr. G. Agamennone, 439; Mode of Propagation of Earthquake Shock between Zante and Catania, Prof. Ricci, 606; Earthquakes and Method of Measuring them, Dr. E. S. Holden, 444; Severe Earthquakes in Greece, 604  
 Earthworms of California, the, Gustav Eison, 207  
 Easton (C.), La Voie Lactée dans l'Hémisphère Boreal, 99  
 Eclipse Meteorology, 349  
 Eclipse of the Sun, an Annular, 542  
 Edkins (Dr. J. S.), Human Physiology, John Thornton, 431  
 Edinburgh, Rainfall Observations in, 520  
 Edinburgh Royal Society, 331, 426, 571; Prize Awards, 581  
 Edinburgh University, Recent Benefactions, 252  
 Edmondson (T. W.), Mensuration of the Simpler Figures, 28; the Geometrical Properties of the Sphere, 75  
 Education, the Training of Dull Children and others requiring special care, Sir Douglas Galton, 461; the Secondary Education Movement, Sir H. E. Roscoe, F.R.S., 203; the Progress of Technical Education, R. A. Gregory, 185; Technical Education, Bequest by Mr. T. H. Adam, 320; Formation of Association of Technical Institutions, 321; some Simple Methods in Teaching Elementary Physics, Dr. J. Joly, F.R.S., 379; on Preparing the Way for Technical Instruction, Sir Philip Magnus, 400; the Work of City and Guilds of London Institute for 1893, 607; Agricultural Education Experiment Stations, 373; Educational Agricultural Experiments, 568  
 Educational Atlas, an, Philip's Systematic Atlas, E. G. Ravenstein, 574  
 Educator, the New Technical, 148  
 Edwards (D. T.), Boring on Booyesen Estate, Witwatersrand, 239  
 Eels in Ice, 271  
 Effron (J.), Chemical Conditions of Activity of Brewer's Yeast, 24  
 Egg, Great Auk's, Prof. Alfred Newton, F.R.S., 412, 456; J. E. Harting, 432  
 Egg, Great Auk's, sold for 300 Guineas, 415  
 Eggs: a Curiosity in, E. Brown, 317; Abnormal, W. B. Tegetmeier, 366; E. J. Lowe, F.R.S., 366  
 Egypt, the Projected Irrigation Reservoirs, 129; the Tombs of "Beni Hasan," P. E. Newberry, 169, 432; G. W. Frazer, 169  
 Egypt: Ancient Egyptian Pigments, Dr. William J. Russell, F.R.S., 374  
 Egyptology: Death and Obituary Notice of Prof. J. van Dümichen, 393  
 Eiffel Tower, the Diurnal Range in Velocity and Direction of the Wind on the, Prof. Sprung, 596  
 Eison (Gustav), the Earthworms of California, 207  
 Elbrus, A. V. Pastukhoff's Ascent of the, 515  
 Electricity: Signor Augusto Righi's Experiments with Electro-Magnetic Waves of Small Length, 15; the Various Electric Wave Systems obtained by Lecher's Method, Signor Mazotto, 83; English Translation of Prof. Hertz's "Electric Waves," Prof. D. E. Jones, 396; M. Blondlot's Experiments on Propagation of Hertzian Waves, M. Mascart, 394; Propagation of Electro-Magnetic Waves, M. Mascart, 379; the Reflection of Electrical Waves, Signor Garbasso, 132; Dr. Oettel's Researches on Phenomena of Electrolytic Deposition of Metals, 16; Personal Recollections of Dr. Werner von Siemens, 25; New Form of Contact-Maker, Messrs. Bedell, Miller, and Wagner, 37; the Effect on Magnetic Rotatory Polarisation of Solutions of Electrolytic Dissociation, Herr Humburg, 37; Blondlot's Experiments on Velocity of Propagation of Electric Disturbance along Wire, 37, 83; Behaviour of Air-Core Transformer when frequency below certain critical value, 8; C. Rimington, 46; Electric-Radiation in Copper Filings, W. B. Croft, 47; Death of A. Reckenzaun, 63; Method for Comparing Capacities of Two Condensers of very small capacity, 65; Effect of Absorption of Hydrogen on Thermo-electric Power and Electrical Resistance of Palladium, Signor G. Brucchiotti, 65; Measurements of Coefficients of Induction, H. Abraham, 72; What Electricity is, Prof. Galileo Ferraris, 83; the Lausanne Municipal Council and Electrical Transmission of Power, 107; Improved Arrangement for "turning down" Electric Light, F. Moore, 108; Map of Electric Lighting District of London, 298; the Kathodic Light, Prof. Goldstein, 427; Absorption and Branching of Oscillations in Wires, Ignaz Klemencic, 117; Simple Method of Testing Conductivity of Dielectric Liquids, K. R. Koch, 118; Means of Increasing Security of High Tension Alternate-current Distribution of Clouds, 119; Action of some Metals upon Acid Solutions of their Chlorides, A. Ditte and R. Mentzner, 119; Les Courants Polyphases, J. Rodet et Busquet, 122; Currents produced by Heating various Metals, W. H. Steele, 131; Electric Variation of High Regions of Atmosphere in Fine Weather, Ch. André, 131; Action of Electromagnetic Radiation on Films containing Metallic Powder, Prof. G. M. Minchin, 142; Problèmes et Calculs Pratiques d'Électricité, M. Aimé Witz, Prof. A. Gray, 145; Institute of Electro-Biology established by M. G. Solvay at

- Brussels, 180; Electric Strength of Solid, Liquid, and Gaseous Dielectrics, A. Macfarlane and G. W. Pierce, 181; a Modified form of Thomson Quadrant Electrometer, Herr F. Himstedt, 181; a very Sensitive Idiostatic Electrometer, Prof. A. Righi, 606; the Swiss Experiments upon the use of Electricity gained from Water, 182; Utilisation of Water-power on Seine-Saone Canal, M. Galliot, 272; Potentiometer for Alternating Currents, James Swinburne, 190; Calculation of Coefficient of Self-induction of Circular Current of given aperture and Cross-section, Prof. G. M. Minchin, 190; Magnetic Field of Current running in Cylindrical Coil, Prof. G. M. Minchin, 190; Experiments in Devices for Compensating Hysteresis of Iron used for Measuring Instruments, Messrs. Field and Walker, 206; Ewart's Investigations on Electric Fishes, Prof. Gustav Fritsch, 222; the Effects of Light on the Electrical Discharge, 226; Propagation of Electricity, H. Poincaré, 239; Death of Prof. Hertz, 251; Novel Method of obtaining Sinusoidal Alternating Currents of very Low Frequency, Lieut. F. J. Patten, 253; Experiments on Electrical Convection in Air, M. Hurmuzescu, 254; a Dynamical Theory of the Electric and Luminiferous Medium, Dr. Joseph Larmor, F.R.S., 260, 280; Electromotive Force from the Light of the Stars, Prof. Geo. M. Minchin, 269; M. Violle on the Electric Arc, 272; Experiments on Electric Arc in Alternating Circuit, G. Claude, 441; a Liquid Commutator for Sinusoidal Currents, Prof. J. A. Ewing, F.R.S., 317; Peculiarities of Deposit of Silver on Platinum, U. Behn, 321; Minimum Electromotive Force necessary for Electrolysis of Dissolved Alkaline Salts, C. Nourrisson, 331; Dynamos, Alternators, and Transformers, Gisbert Kapp, 337; Polarisation Phenomena upon Thin Metal Partitions, Dr. Arons and John Daniel, 347; Polarisation upon a Thin Metal partition as a Voltmeter, John Daniel, 460; the Thermo-electric Diagram for some Pure Metals, 347; Nikola Tesla, T. C. Martin, 352; Electric Alarm Thermometer for Laboratory Ovens, M. Barillé, 355; Notes on Recent Researches in Electricity and Magnetism, J. J. Thomson, F.R.S., Prof. A. Gray, 357; Dielectrine, a New Insulating Material, Mr. Hurmuzescu, 370; How to Manage the Dynamo, S. R. Bottone, 363; Galvanic Deposits arranged in Streaks, U. Behn, 376; Polarisation of Solid Deposits between Electrolytes, P. Springmann, 376; Electricity of Drops, Prof. J. J. Thomson, 378; Lectures on Maxwell's Theory of Electricity and Light, Dr. Ludwig Boltzmann, 381; Electrical Experiments, G. E. Bonney, 386; on M. Mercadier's Test of the Relative Validity of the Electrostatic and Electro-magnetic Systems of Dimensions, Prof. Arthur Rücker, F.R.S., 387; Dr. G. Johnstone Stoney, F.R.S., 432; the Benzévill-Havre Railway Experiments, 395; Conductibility of Discontinuous Conducting Substances, Edward Branly, 404; Chapters on Electricity, Samuel Sheldon, 411; Measurement of Capacity of Condensers under Alternating Currents, J. Sahulka, 417; a Text-book on Electromagnetism and the Construction of Dynamos, Dugald C. Jackson, Prof. A. Gray, 429; a New Electrical Theorem, T. H. Blakesley, 450; Current-Sheets, R. H. D. Mayall, 452; New form of Electrical Machine, M. Bonetti, 460; Electrical Sanitation, 469; the Construction of Drum Armatures and Commutators, F. M. Weymouth, E. Wilson, 478; the Point of Application of Electromagnetic Forces, M. Pellat, 488; P. Lenard's Observations on the Cathode Rays in Gases with High Vacua, Prof. Fitzgerald, 509; Point of Application of Mechanical Force experienced by Conductor conveying Current in Magnetic Field, M. Pellat, 560; New Method of Studying Discharge, N. Pilchikoff, 540; Earth Currents, W. H. Preece, F.R.S., 554; Electric Traction, E. F. Bamber, 567; Death of Paul Jablochikoff, 558; Difference of Potential between Aqueous and Alcoholic Solutions of same Salt, A. Campetti, 560; Communication between Lighthouses and Lightships without Submarine Cable, C. A. Stevenson, 581; Improved Form of Blackburn's Pendulum for Slow Production of Lissajous's Figures, Prof. A. Righi, 582; Lecture Demonstration and Electrolysis of Hydrochloric Acid, Prof. Lothar Meyer, 584; Transparent Conducting Screens for Electric and other Apparatus, Prof. W. E. Ayrton, F.R.S., and T. Mather, 591; Prof. Börnstein on Electric Measurements made during Balloon Ascents, 595; the Magnetisation of Iron and Nickel Wires by Rapid Electrical Oscillations, Prof. Klemencic, 607; the Development of Electrical Engineering, Prof. Kennedy, 608; on an Electrochemical Method of Observation of Alternating Currents, P. Janet, 620
- Elfvig (Prof. F.), on the Irritability of Plants, 466
- Elgar (Dr. Francis), the Loss of H.M.S. *Victoria*, 102, 124, 151
- Elliptic Functions, the Applications of, Alfred George Greenhill, F.R.S., H. F. Baker, 359
- Elliptic Motions, a Simple Contrivance for Compounding, G. H. Bryan, 498
- Ellis (William, F.R.S.), Correlation of Solar and Magnetic Phenomena, 30, 53, 78, 245
- Emerson (Prof. B. K.), Recovery of, 129
- Emin Pasha, Proposed Monument to, 134
- Energy, the Nomenclature of Radiant, Prof. Simon Newcomb, F.R.S., 100; Prof. G. F. Fitzgerald, 149; Prof. A. N. Pearson, 389
- Engineering: Institution of Mechanical Engineers, 18, 350, 608; the Artificial Lighting of Workshops, B. A. Dobson, 18; Steam Pumps on Russian Railways, Alexander Borodin, 19; Effect of Reversing Screw of Steamship on Steering, Captain Bain, 208; Marine Engine Trials; Abstract of Results of Research Committee, Prof. T. H. Beare, 350; a Text-book on Gas, Oil, and Air Engines, Bryan Donkin, N. J. Lockyer, 430; the Falls of Niagara and its Water Power, 382; the Grafton High Speed Steam-engine, E. W. Anderson, 610; the Development of Electrical Engineering, Prof. Kennedy, 608
- England, Earthquake in West of, 34
- England and Wales, Geological Survey of, 495
- English Spiders, further Notes and Observations upon the Instinct of some Common, R. I. Pocock, 60
- Entomology: Collecting in the Transvaal, 12; Entomological Society, 23, 95, 190, 330, 378, 475, 522, 571, 619; the Reproduction of Wasps, Paul Marchal, 47; Further Notes and Observations upon the Instinct of some Common English Spiders, R. I. Pocock, 60; Protective Habit in a Spider, Prof. C. Lloyd Morgan, 102; Mimicry by Spider, 207; the Silk-Spider of Madagascar, Dr. Karl Müller, 253; Notes on the Habits of a Jamaican Spider, Prof. T. D. A. Cockerell, 412; Death of Dr. H. A. Hazen, 63; the Sugar-cane Moth, A. S. Skiff, 64; Method of Showing Geographical Distribution of Insects in Collections, Prof. E. B. Poulton, F.R.S., 95; Dr. Livingstone and the Zambesi Ants, 95; the Nematodes of the Pharyngean Glands of Ants, Charles Janet, 119; White Ants, Dr. D. Sharp, F.R.S., 522; our Household Insects, an Account of the Insect Pests found in Dwelling-houses, Edward A. Butler, 147; the Gipsy Moth Plague in Massachusetts, 231; Dried Locusts as Food for Insectivorous Cage and Game Birds, Dr. Günther, E. C. Cotes, 253; Insect Attacks on Crops and Trees, Miss E. A. Ormerod, 253; Report of Observations of Injurious Insects and Common Farm Pests during the Year 1893, Eleanor A. Ormerod, 480; Proposed Quarantine Legislation against Insect Pests in California, 508; Romance of the Insect World, L. N. Badenoch, 314; our Knowledge of the Acari, A. D. Michael, 330; Netherlands Entomological Society, 332; Vertical Distribution of British Lepidoptera, W. H. Bath, 346; Morphology of Pedipalpi, Malcolm Laurie, 378; the Beetles of New Zealand, W. F. Kirby, 459; Insect Sight and Defining Power of Composite Eyes, A. Mallock, 472; Anatomy of the Trachean System of the Larvæ of Hymenoptera, M. Bords, 524; Centipedes and their Young, F. W. Ulrich, 531; Death of J. Jenner Weir, 538, 571; a Specimen of *Gandaritis flavata* (Moore) from the Khari Hills, G. F. Hampson, 571; Bees and Dead Carcasses, W. F. Kirby, 555; Mimicry of Hemiptera by Lepidoptera, G. A. G. Rothney, 619
- Entomotraca and Surface-Film of Water, D. G. Scourfield, 474
- Eozoonal Structure of the Ejected Blocks of Monte Somma, Dr. J. W. Gregory and Prof. H. J. Johnston-Lavis, 499
- Ephemeris for Denning's Comet (*a* 1894), 586
- Epidemic Influenza, Hon. R. Russell, 210
- Epilepsy and Errors of Refraction in Eye, Relationship between, H. W. Dodd, 395
- Epping Forest Local Museum, Proposed, 393
- Epping Forest, the Recent Operations in, 605
- Equatorial Africa, the Natural History of East, Dr. J. W. Gregory, 12

- Equilibrium of Vapour Pressure inside Foam, on the, Prof. G. F. Fitzgerald, F.R.S., 316
- Ernst (Dr.), the Cauchouc of the Orinoco, 35
- Erosion of Rock-Basins, the, T. D. La Touche, 39; Prof. T. G. Bonney, F.R.S., 52
- Erp (H. van), Comparison of Zinc and Copper Salts of Frankland's Dinitromethyllic Acid with those of Methylnitramine, 380
- Eskimo Life, Dr. Fridtjof Nansen, 98
- Espin (Rev. T. E.), a New Variable Star, 67, 184; Stars with Remarkable Spectra, 183
- Ethers, a New Process for the Preparation of, A. E. Tutton, 184
- Ethiopians, the Sacred City of the, J. T. Bent, 314
- Ethical Migrations in Central Asia from a Geographical Point of View, G. Capus, 593
- Ethnography: Dr. Modigliani's Sumatra Engano Collections, Prof. Giglioli, 107; Internationales Archiv für Ethnographie, 377; Ethnography of the Aran Islands, County Galway, Prof. A. C. Haddon and Dr. C. R. Browne, 468
- Ethnology: Eighth Report of U.S. Bureau, Major J. W. Powell, 132; Ethnological Museum at Leyden, Dr. H. ten Kate, 165; the Medicine-Men of the Apache Indians, Capt. J. G. Bouike, 439
- Etna Eruptions of May and June 1886, Prof. Silvestri's Geodynamic Observations of, 107
- Euclid I. to IV., Solutions of the Exercises in Taylor's, W. W. Taylor, 3
- Euclid V.-VI., Pitt Press, H. M. Taylor, 52
- Euclid's Elements, a Text-Book of, H. S. Hall and F. H. Stevens, 599
- Eulerian Movement, the Sense and the Period of the, F. Folie, 617
- Europe, Forest Legislation in, B. E. Fernow, 543
- Europe, Recent Local Rising of Land in the North-West of, C. A. Lindvall, 433
- Evans (Arthur J.), the Man of Mentone, 42
- Evans (Sir John, F.R.S.), the Forgery of Prehistoric Stone Implements, 156; the Royal Society, 576
- Evans (Dr. J. W.), Geology of Matto Grosso, 94
- Evermann (W. B.), the Ptarmigan of Aleutian Islands, 584
- Ewart (Prof. Cossar), on the Second and Fourth Digits of the Horse, 571
- Ewart (Prof. J. A., F.R.S.), a Liquid Commutator for Sinusoidal Currents, 317
- Ewart (Prof. J. C.), Investigations on Electric Fishes, 222
- Exhibition at Hobart, Tasmania, Coming International, 13
- Exploration, Antarctic, Dr. John Murray, 112; Scheme for, Dr. F. A. Cook, 184
- Explosive Gaseous Mixtures, the Temperature of Ignition of, A. E. Tutton, 138
- Extra-Tropical Orchids, Harry Bolus, R. A. Rolfe, 50
- e
- Face of the Earth, the, Prof. Chas. Lapworth, F.R.S., 614
- Falls of Niagara and its Water-Power, the, 482
- Fauna of the Deep Sea, Sydney J. Hickson, 502
- Fauna of the Victoria Regia Tank in the Botanical Gardens, Frank E. Beddard, F.R.S., 247
- Favé (General), Death of, 486, 524
- Faye (M.), on Mountain Observatories in connection with Cyclones, 620
- Fayollat (M.), New Mode of Preparing Methylamine and Ethylamine, 300
- Fayer (Sir Joseph, F.R.S.), the Directorship of the Institute of Preventive Medicine, 292
- Feldt (Dr.), Isolation of New Crystallised Compounds of Hydroxylamine with Chlorides and Sulphates of Cobalt and Manganese, 489
- Fellenberg (Dr. von), Geology of the Bernese Oberland Alps, 297
- Félic (Ch.), Relation of the Length of the Trunk to the Height, 520
- Feimentation, Micro-Organisms and, Alfred Jörgensen, Dr. A. A. Kanthack, 527; Frank E. Lott, 577
- Fermi (Signor), the Action of Sunshine upon Tetanus Filtrates, 509; Tetanus Poison, 540
- Fernow (B. E.), Forest Legislation in Europe, 543
- Ferrand (Henri), Mont Iseran, 134
- Ferraris (Prof. Galileo), What Electricity is, 83
- Fever and Ozone, 180
- Fewkes (J. Walter), on the Cardinal Points of the Tusayan Villagers, 388
- Fibres, Quartz, the Attachment of, Prof. C. V. Boys, F.R.S., 450
- Field (Mr.), Experiments in Devices for Compensating Hysteresis of Iron used for Measuring Instruments, 206
- Figures, Mensuration of the Simpler, William Briggs and T. W. Edmondson, 28
- Films of Remarkable Stability, Method of Producing Thin Glass, F. Kohlrausch, 439
- Finsterwalder (Prof.), Observations during Nocturnal Balloon Ascents at Munich, 416
- Fire, the Chemistry of, M. M. Pattison Muir, 3
- Fireball of January 25, the Large, 324
- Fireball, Worthington G. Smith, 577
- Fireballs, W. F. Denning, 434
- Fires, New French Law for the Prevention of Forest, Prof. W. R. Fisher, 233
- Fischer (Emil), Compounds of Sugar with Mercaptans, 510
- Fischer (Paul), Death of, 158; Obituary Notice of, Edmond Bourbage, 296
- Fish: the Flying Fish, 13; Ewart's Investigation on Electric Fishes, Prof. Gustav Fritsch, 222
- Fisher (H.), Botanical Collection presented to Nottingham Museum by, 271
- Fisher (Rev. O.), Condition of Interior of Earth, 379
- Fisher (Prof. W. R.), New French Law for the Prevention of Forest Fires, 233; Tree Pruning, A. des Cars, 526; Practical Forestry, Angus D. Webster, 526; Afforestation in the British Isles, 601
- Fitzgerald (Prof. G. F., F.R.S.), Systematic Nomenclature, 148; on the Nomenclature of Radiant Energy, 149; on the Change of Superficial Tension of Solid Liquid Surfaces with Temperature, 293; on the Equilibrium of Vapour Pressure inside Foam, 316; P. Lenard's Observations on the Cathode Rays in Gases with High Vacua, 509
- Fixation of Nitrogen by Plants, Recent Investigations and Ideas on the, Prof. H. Marshall Ward, F.R.S., 511
- Flame: Prof. Arthur Smithells, 86, 149, 198; Prof. Henry E. Armstrong, F.R.S., 100, 171; G. S. Newth, 171
- Flame, Luminosity of Candle Calculable from Dimensions of, P. Glan, 460
- Fleming (Mrs.), a New Southern Star discovered by, 38; Four New Variable Stars discovered by, 608
- Flint-Saws, the Polado, Dr. R. Munro, 183
- Flints, the Formation of, A. J. Jukes-Browne, 160
- Flood, on a Possible Cause for the Origin of the Tradition of the, Dr. Prestwich, F.R.S., 594
- Flora of Texas, the Trinity (Fossil), W. M. Fontaine, 36
- Flounders, a Parasitic Disease in, G. Sandeman, 119
- Flowering Plants of Western India, the, Rev. A. K. Nairne, 501
- Fluids, the Internal Pressure of, and the Form of the Function  $\phi(\rho v) = 0$ , E. H. Amagat 500
- Fluids, the Compression of, Prof. Tait, 331
- Flying, Experiments on, Prof. C. Runge, 157; Correction, 183
- Flying, Lilienthal's Experiments on, Dr. A. du Bois Reymond, 356
- Flying Fish, the, 13
- Foam, on the Equilibrium of Vapour Pressure inside, Prof. G. F. Fitzgerald, F.R.S., 316
- Foam Theory of Protoplasm, the, E. A. Minchin, 31
- Fog Signals, Relation to other Sounds of, C. A. White, 508
- Folie (S.), on Variations of Latitudes, 376; Meteors of Night of Nov. 6-7, 1893; 377; the Definition of Latitude, 546; the Sense and the Period of the Eulerian Movement, 617
- Folk-Lore: German Superstitions about Minerals, F. Klinkhardt, 230
- Folk-Lore of India, Volcano, Dr. V. Ball, 109
- Fontaine (W. M.), the Trinity Flora of Texas, 36
- Forbes (H. O.), Antarctica, a Vanished Austral Land, 352
- Forchhammer (Prof.), Death of, 251
- Forcrand (M. de), Thermal Value of Replacement of Phenolic Hydrogen in Orcin, 379
- Forestry: British Forest Trees, J. Nisbet, 1; Means of Preventing Wood from being Worm-eaten, Emile Mer, 119; Forest Fires and Drought, G. Rayet and G. Clavel, 191; New French Law for the Prevention of Forest Fires, Prof. W. R. Fisher, 233; the Climatic and National Economic In-

- fluence of Forests, Dr. J. Nisbet, 302; Practical Forestry, Angus D. Webster, Prof. W. R. Fisher, 526; Tree Pruning, A. des Cars, Prof. W. R. Fisher, 526; Forest Legislation in Europe, B. E. Fernow, 543; Afforestation in the British Isles, Prof. W. R. Fisher, 601; the Recent Operations in Epping Forest, 605
- Formenephone, the, E. Hardy, 47
- Forster (M. O.), Combination of Hydrocarbons with Picric Acid, 142
- Fort William Diurnal Barometric Curve, the, 540
- Fortnightly Review, Science in the, 31, 155, 235, 352, 443
- Forum, Science in the, 32
- Fossils: Coal-Balls and their Fossil Plant Contents, H. B. Stocks, 14; Organisation of Fossil Plants of Coal Measures, W. C. Williamson, F.R.S., and D. H. Scott, 449; Fossil Plants, the Trinity Flora of Texas, W. M. Fontaine, 36; Mr. James McMurtrie's Collection of Fossil Plants acquired by South Kensington Museum, 415; a Sub-Tropical Miocene Fauna in Arctic Siberia, W. H. Dall, 36; the Unio Fauna of the Mississippi Valley, C. T. Simpson, 64; Larval Form of Triarthrus, C. E. Beecher, 92; Frost-Cracks and Fossils, Prof. G. A. Lebour, 412; the Systematic Position of the Trilobites, H. M. Bernard, 521
- Foster (Prof. G. C. Carey, F.R.S.), the Theory of Heat, Thomas Preston, 573
- Foster (Prof. Michael), on the Organisation of Science, 563
- Foundations of Dynamics, the, Prof. A. Gray, 389; A. B. Basset, F.R.S., 529; Edward T. Dixon, 578
- Fourier's Series, an Elementary Treatise on, W. E. Byerly, 598
- Fowler (Mr.), Aurora of February 28, 442
- Fowler (A.), the Story of the Sun, Sir Robert Ball, F.R.S., 382
- Fowler (Dr. G. H.), Octineon Lindahli, 423
- Fox (Howard), the Cherts of Cornwall, 82
- Foye (J. C.), a Lecture Experiment, 531
- France: New French Law for the Prevention of Forest Fires, Prof. W. R. Fisher, 233
- France, the Recent Planimetric Measurement of, 416
- Franchimont (M.), Comparison of Zinc and Copper Salts of Frankland's Dinitromethylic Acid with those of Methyl-nitramine, 380
- Frank (Herr), New Method of Preparing Phosphorus, 323
- Frankland's (Prof.) Our Secret Friends and Foes and the Anti-Vivisectionists, 34
- Frankland (P.), Ethereal Salts of Diacetylglyceric acid in relation to Connection between Optical Activity and Chemical Constitution, 142
- Frankland (Prof. Percy, F.R.S.), an Incident in the Cholera Epidemic at Altona, 392
- Frankland (Mrs. Percy), Land Filtration as a means of Purifying Water, 156; Einführung in das Studium der Bakteriologie mit besonderer Berücksichtigung des Mikroskopischen Technik, Dr. Carl Günther, 455
- Franklin Institute Prizes, 251
- Franklin's (Messrs. C. L.) New Theory of Light-Sensation, 394
- Fraser (Colonel A. T.), Hindoo Dwarfs, 35, 396
- Fraser (G. W.), Beni Hasan, 169
- Freedon (W. von), Death of, 270
- Frémy (Prof. Edmond), Death and Obituary Notice of, 345
- Frequency Curves, Asymmetrical, Prof. Karl Pearson, 6
- Freshwater Medusa (*Limnocolidum Soverbiti*), Reappearance of the, Prof. E. Ray Lankester, F.R.S., 127
- Frigate-Birds, the Continuous Flight of, J. Lancaster, 605
- Fritsch (Prof. Gustav), Ewart's Investigations on Electric Fishes, 222
- Frost-cracks and Fossils, Prof. G. A. Lebour, 412
- Fungus Flora, British: a Classified Text-book of Mycology, George Masser, Dr. M. C. Cooke, 195
- Fungus-Mycele, Growth in Solution of Sulphate of Quinine of, M. Heim, 509
- Functions, a Treatise on the Theory of, James Harkness and Frank Morley, 477
- Functions, Elliptic, the Applications of, Alfred George Greenhill, F.R.S., H. F. Baker, 359
- Furneaux (W.), The Outdoor World, or Young Collector's Handbook, 52
- Fusibility of Mixtures of Salts, on the, M. H. Le Chatelier, 595
- Galapagos Island Shells, the Albatross Collection of, Dr. Stearns, 82
- Gale of November 16-20, the Great, Charles Harding, 294
- Gale's Comet, Elements and Ephemeris of, 608
- Galitzini's (Herr) Experiments in Estimation of Critical Temperature, 83
- Galliot (M.), Utilisation of Water-power for Electrical Machinery on Seine-Saone Canal, 272
- Galton (Sir Douglas, K.C.B., F.R.S.), Healthy Hospitals, Observations on Hospital Construction, 290; the Education of Dull Children and others requiring special care, 461
- Galton (Francis, F.R.S.), a Plausible Paradox in Chances, 365; Results derived from the Natality Table of Korosi by employing the Method of Contours or Isogens, 570
- Galvanic Deposits arranged in Streaks, U. Behn, 376
- Gamaleia (Dr.), Virulence of Cholera Bacillus increased by Salt, 132
- Gambier (Captain), the True Discovery of America, 235
- Gannett (Henry), Average Elevation of United States, 461
- Garbasso (Signor), the Reflection of Electrical Waves, 132
- Gardner (J. Starkie), William Pengelly, 554
- Gas, the Manufacture of, C. Hunt, 561
- Gas, Coal, the new Process for enriching with Oxy-oil Gas, Dr. L. T. Thorne, 162
- Gas, Oil, and Air Engines, a Text-book on, Bryan Donkin, N. J. Lockyer, 430
- Gaseous Mixtures, the Temperature of Ignition of Explosive, A. E. Tutton, 138
- Gases, a Treatise on the Kinetic Theory of, Dr. William Watson, F.R.S., Prof. P. G. Tait, 73
- Gases, Interior Pressure in, E. H. Amagat, 404
- Gases, Radiation of, F. Paschen, 376
- Gaudaritis flavata*, Moore, Specimen of, from the Khâri Hills, G. F. Hampson, 571
- Gegenschein, the, 256
- Geikie (Sir Archibald, F.R.S.), Text book of Geology, 287; Relations of Basic and Acid Rocks of Inner Hebrides, Tertiary Volcanic Series, 474; Geological Survey of the United Kingdom, 495, 518
- Geoghegan (Rev. Edward), Astronomy in Poetry, 413
- Geography: Geographical Journal, 18, 346; Geographical Notes, 18, 39, 85, 111, 134, 163, 184, 210, 233, 256, 275, 301, 324; Siberia, Anadyr, a New Province in, 18; Proposed Station in Ellesmere Land, Robert Stein, 18; Plan for Exploration of Ellesmere Land, Robert Stein, 346; Dr. Stein's Arctic Expedition, 256; M. E. de Poncins' Explorations in the Pamirs, 18; Crossing of the Pamirs, E. de Poncins, 163; the Discovery of Australia, Albert F. Calvert, 28; Geographical Evolution of the North Sea, A. J. Jukes-Browne, 32; the First Voyage of Columbus in Relation to Development of Oceanography, Dr. John Murray, 39; Copy of a Map by Columbus, 233; the True Discovery of America, Captain Gambier, 235; Dr. Nansen and the Kara Sea, 39; Dr. Nansen's Expedition, 112, 210; Hans Johannessen, 85; the Present Standpoint of Geography, Clements R. Markham, F.R.S., 69; the Fate of the Björling Arctic Expedition, Captain McKay, 85; Proposed Search for the Björling Expedition, 606; Cologne, the Largest City (in area) in Germany, 85; Georges Müller's Last Explorations in Madagascar, 111; the Survey of the Laccadives, 111; the Death of Mr. H. M. Becher, 112; Mr. Astor Chanler's East African Expedition, 112, 301; Lieut. von Höhnel wounded, 112; Antarctic Exploration, Dr. John Murray, 112; Scheme for Antarctic Exploration, Dr. F. A. Cook, 184; the Scottish Geographical Society and Antarctic Research, 257; Norwegian Sealers in Antarctic Waters, 461; Les Pyrénées, Eugène Trutat, 122; Geographical Conditions of Pyrénées, MM. Schrader and De Margerie, 275; Proposed Monument to Emin Pasha, 134; Death and Obituary Notice of A. L. Bruce, 134; Grablovitz's Mareographical Observations in Italy, 134; Mont Iseran, Henri Ferrand, 134; Submarine Cable opened between Zanzibar, Mauritius, and Seychelles, 134; the Slow Ascensional Movement of Scandiravia, A. Badonrean, 159; Evolution of Geography of India, R. D. Oldham, 163; Crossings of the Eastern Horn of Africa, 163; Death of Dr. D. S. Moncrieff, 163; Death of Gustav von Kreitner, 184; Annales de Géographie, 184; Das Karst-Phänomen, Dr. Jovan Cvijic, 197; Kl and Büttner's Expedition to Togo, 207; Death of Dr. H. Kink, 210; Visit of

- Mr. Crawshaw to Nyika Plateau, 210; Amalgamation of "Das Ausland" and "Globus," 233; W. A. Obrecheff's Journey in Ordos Region, 233; Herr Hirsch's Journey to Hadramaut, 233; Memoirs of Russian Geographical Society, 254; Investigation of Adelsberg Grotto, E. A. Martel, 256; Completion of Elisée Reclus' Nouvelle Géographie Universelle, 256; the Chinese Map of Tibet, Dr. Wegener, 275; Death of August Arteria, 275; Dr. J. W. Gregory's Journey to Mount Kenia, 276, 443; a Journey through the Yemen, Walter B. Harris, 291; Current Arctic Expeditions: Return of Mr. F. G. Jackson, 301; Death of General Sir C. P. Beauchamp Walker, 301; Quincentenary of Birth of Prince Henry the Navigator, 301; Experiments on Oceanic Currents by means of Floats, 301; Petermann's Mittheilungen, 324; Prince Constantine Wiazemski's Journey through Asia, 324; Sir Claude Macdonald's Journey up the Cross River, 346; True Latitude reached by *Neoport* whaler, Prof. George Davidson, 369; Johore, Harry Lake, 370; the Greenland Expedition of the Berlin Geographical Society, 399; the Recent Planimetric Measurements of France, 416; the Upper Mekong, Warrington Smyth, 416; the Last Great Lakes of Africa, Ludwig von Höhnell, 457; Average Elevation of United States, Henry Gannett, 461; W. H. Cozens-Hardy's Journey through Montenegro, 461; the Classification of Rivers according to Size, Marcel Dubois, 487; Return of Mr. Theodore Bent's Expedition, 487; the Island of Sakhalin, F. Immanuel, 508; Geography in Caucasus, 515; the Old Beds of the Amu-Daria, M. Konshin, 515; A. V. Pastukhoff's Ascent of the Elbrus, 515; Lake Dedication on Northern Slopes of Caucasus, K. N. Rossikoff, 515; Bathymetrical Survey of Haweswater, Mill and Heawood, 540; Exploration of Lukuga River, by M. Delcommune, 559; High Southern Latitude reached by *Fason* Whaler, 559; Paris Geographical Society Awards, 559; Across Central Asia, St. George Littledale, 567; Delimitation of Congo State and Portuguese Frontier, 582; the Lubidi River, 582; Ethnical Migrations in Central Asia from a Geographical Point of View, G. Capus, 593; Royal Geographical Society Medal Awards, 604; the German Expedition to Delimit Hinterland of Cameroons, Dr. Passarge, 606; Intended Expeditions of Dr. Donaldson Smith to Lake Rudolph, and of R. T. Coryndon to Great Congo Forest, 606; the Finger Lakes in New York State, R. S. Tarr, 606; the Face of the Earth, Prof. Chas. Lapworth, F.R.S., 614.
- Geology: the Recent Glaciation of Tasmania, Dr. Alfred R. Wallace, F.R.S., 3; the Supposed Glaciation of Brazil, W. T. Thiselton-Dyer, F.R.S., 4; Glacial and Erratic Phenomena in Cachapoal Valley (Chili), A. F. Nogués, 72; New England and the Upper Mississippi Basin in the Glacial Period, J. F. Dana, 92; Glacial Potholes of Cooper's Island, U.S., W. O. Crosby, 160; Glacial Striae in Somerville, Mr. Upham, 183; Glacial Erosion in Alaska, Prof. G. Frederick Wright, 316; Earth Movements and the Question of the Cause of Glacial Conditions, Prof. Hughes, 426; Continuity of the Glacial Epoch, G. F. Wright, 520; the Origin of Glacial Drifts, Sir J. W. Dawson, F.R.S., 552; the Black Sea during the Pliocene Age, N. Andrusoff, 23; Geology in Nubibus, an Appeal to Dr. Wallace and others, Sir Henry H. Howorth, M.P., F.R.S., 29; Sir Henry H. Howorth on Geology in Nubibus, Dr. Alfred R. Wallace, F.R.S., 52, 101; Geology in Nubibus, a Reply to Dr. Wallace and Mr. La Touche, Sir Henry H. Howorth, F.R.S., 75; Sir Henry Howorth and Geology in Nubibus, R. M. Deeley, 122; Geology in Nubibus, R. M. Deeley and Dr. Alfred Wallace, F.R.S., Sir H. H. Howorth, F.R.S., 173; Geology of Dublin Area, Prof. Sollas, 36; the Geology of Thessaly, Prof. V. Iirbel, 36; Geological History of Arctic Lands, Sir Henry Howorth, 36; the Erosion of Rock Basins, T. D. La Touche, 39; Prof. T. G. Bonney, F.R.S., 52; R. D. Oldham, 77; Austrian Jahrbuch, 46; Geology of Ostrau District, Dr. Emil Tietze, 46; Systematic Position of Trigonidæ and Descent of Nayadide, Baron von Wöhmann, 46; Fractures of Coal-Measures of Southern Chili, A. E. Nogués, 47; General Characters of Bogheads produced by Algæ, C. E. Bertrand and B. Renault, 47; the Unio Fauna of the Mississippi Valley, C. T. Simpson, 64; Transactions of Austrian Geological Survey, 71; the So-called Granite of Bacher Mountains, F. Teller, 71; Composite Dykes, Henry E. Ede, 77; the Cherts of Cornwall, Howard Fox, 82; Use of Name "Catskill," J. J. Stevenson, 92; Geological Society, 94, 142, 191, 239, 306, 355, 393, 403, 451, 474, 521, 547; Geology of Bathurst, New South Wales, W. J. C. Ross, 94; Geology of Matto Grosso, Dr. J. W. Evans, 94; Mammoth Remains in Canada and Alaska, Dr. G. M. Dawson, F.R.S., Sir Henry Howorth, 94; Records of Geological Survey of India, 109; Geological Survey of Queensland, Progress in 1892, R. L. Jack, 109; Les Pyrénées, Eugène Trutat, 122; Ophites of the Western Pyrenees, P. W. Stuart-Menteth, 264; Anorthosytes of Minnesota Coast of Lake Superior, Dr. A. C. Lawson, 131; Laccolithic Sills of North-west Coast of Lake Superior, Dr. A. C. Lawson, 131; Basic Eruptive Rocks of Gran, Prof. W. C. Brögger, 142; Enclosures of Quartz in Lava of Stromboli, Prof. H. J. Johnston-Lavis, 143; the Geological Evidence for Recurrence of Ice Ages, Prof. Hughes, 143; the Ice Age and its Work, II., Dr. A. R. Wallace, 155; the Formation of Flints, A. J. Jukes-Browne, 160; the Viscous Motion of Ice, John Tennant, 173; Death of Dr. D. A. Brauns, 179; Purbeck Beds of Vale of Wardour, Rev. W. R. Andrews and A. J. Jukes-Browne, 191; Picrite and other Associated Rocks at Barnton, N.B., H. W. Monckton, 191; a Variety of Whitby Ammonite, H. W. Monckton, 191; some Salient Points in the Science of the Earth, Sir J. W. Dawson, F.R.S., 196; the Origin of Lake Basins, R. D. Oldham, 197, 292; Dr. Alfred R. Wallace, F.R.S., 197, 220; Sir Henry Howorth, F.R.S., 220; John Aitken, F.R.S., 315; R. S. Tarr, 315, Dr. A. M. Hanson, 364; T. D. La Touche, 365; Alfred C. R. Selwyn, F.R.S., 412; Mr. Warren Upham's Theory of the Formation of Drumlins near Boston, U.S.A., 207; Apparent Time-break between Eocene and Chattahoochee Miocene in S.W. Georgia, R. Pumpelly, 214; the Kulm District of Lenzkirch, Black Forest, Dr. Rafael Herrmann, 230; the Upper Yenisei Region, Mr. Kryloff, 230; the Plateau of Shan-si, Mr. Obrucheff, 230; Gosau Beds of Salzkammergut, Herbert Kynaston, 239; Artesian Boring at New Lodge, near Windsor Forest, Prof. Edward Hull, F.R.S., 239; Boring on Booyens Estate, Witwatersrand, D. T. Edwards, 239; Biominie des Meeres, Johannes Walther, 244; Origin of Pennsylvania Anthracite, J. J. Stevenson, 271; the Genesis of the Chalk, Dr. W. F. Hume, 271; Dr. J. W. Gregory's Journey to Mount Kenia, 276, 443; the Geology of Australia, Prof. Ralph Tate, 277; Text-Book of Geology, Sir Archibald Geikie, F.R.S., Prof. A. H. Green, F.R.S., 287; the Alleged "Anteprimordial" Fauna of Bohemia, Dr. Jahn, 297; of the Bernese Oberland, Alps, Dr. von Fellenberg, 297; Rhætic and some Liassic Ostracoda of Britain, Prof. T. Rupert Jones, F.R.S., 306; Horizontal Rock Movement and the Chablais Mountains, Hans Schardt, 322; Geological Survey Department of Bavaria and Alsace-Lorraine, 322; the Cretaceous and Tertiary Formations of New Jersey, W. B. Clark, 347; Geological Photographs, 347; the Ossiferous Fissures in Shode Valley, Ightham, W. J. L. Abbott, 355; the Vertebrate Fauna collected therefrom by Mr. Abbott, E. T. Newton, F.R.S., 355; Geologic Atlas of United States, Sheet I., 369; the Scandinavian Ice-Sheet, Prof. T. G. Bonney, F.R.S., 388; the Basalts of Kula, H. S. Washington, 402; the Fishing Banks between Cape Cod and Newfoundland, Warren Upham, 402; Auriferous Rocks from Mashonaland, C. G. Alford, 403; Conversion of Compact Greenstones into Schists, Prof. T. G. Bonney, F.R.S., 403; Place of Waldensian Gneisses in Cottian Sequence, Dr. J. W. Gregory, 403; Frost Cracks and "Fossils," Prof. G. A. Lebour, 412; Discovery of Deposits of Infusorial Earth in Canada, 416; Straining of Earth Resulting from Secular Cooling, Charles Davison, 424; Recent Publications of the American Geological Survey, Prof. T. G. Bonney, F.R.S., 434; the Canadian Geological Survey, 438; Organisation of Fossil Plants of Coal Measures, W. C. Williamson, F.R.S., W. D. H. Scott, 449; the Therapsuchia, H. G. Seeley, F.R.S., 450; Diademodon, H. G. Seeley, F.R.S., 450; Anniversary Address of W. H. Hudleston, F.R.S., President of the Geological Society, 451; Relations of Basic and Acid Rocks of Inner Hebrides Tertiary Volcanic Series, Sir A. Geikie, F.R.S., 474; the Genus *Naiadites* as occurring in Nova Scotia Coal-Formation, Sir J. W. Dawson, F.R.S., and Dr. Wheelton Hird, 475; Death of W. Pengelly, F.R.S., 486; Obituary Notice of William Pengelly, by Prof. W. Boyd Dawkins, F.R.S.,

- 536; the late W. Pengelly, F.R.S., and the Age of the Bovey Lignite, J. Starkie Gardner, 554; A. R. Hunt, 600; Geological Survey of the United Kingdom, Sir Archibald Geikie, F.R.S., 495, 518; Eozoölogical Structure of the Ejected Blocks of Monte Somma, Dr. J. W. Gregory and Prof. H. J. Johnston-Lavis, 499; Derived Crystals in Basaltic Andesite of Glasdrumman Port, co. Down, 499; the Origin of Certain Novaculites and Quartzites, Frank Rutley, 547; Perlitic Cracks in Quartz, W. W. Watts, 547; the Canadian Ice-Age, Sir J. W. Dawson, F.R.S., 552; Crystalline Schists of Devonian Age, Arthur R. Hunt, 554; Life and Rock, R. Lydekker, 575
- Geometry: Worked Examples in Co-ordinate Geometry, Wm. Briggs and G. H. Bryan, 52; the Geometrical Properties of the Sphere, Wm. Briggs and T. W. Edmondson, 75; A Key to Carroll's Geometry, J. Carroll, 75; an Elementary Treatise on the Geometry of Conics, A. Mukhopadhyay, 75; an Elementary Treatise on Analytical Geometry, W. J. Johnston, 99; Death of Prof. E. Weyr, 393
- German African Protectorates, Government Scientific Work in the, 581
- Germany, the Influenza Epidemic in, 1889-90, 569
- Germination, Experiments in, G. J. Romanes, F.R.S., 140
- Giacosa (Piero), the Eleventh International Medical Congress, 578
- Giglioli (Prof.), Dr. Modigliani's Sumatra and Engano Ethnographical Collections, 107
- Gilgoin Station, on a Meteorite from, H. C. Russell, F.R.S., 325
- Gillett (J.), Instruments for Drawing Conic Sections, 94
- Gipsy Moth Plague in Massachusetts, the, 231
- Girod (Paul), the Kidney of the Snail, 380
- Glacial Conditions, Earth Movements and the Question of the Cause of, Prof. Hughes, 426
- Glacial Drifts, the Origin of, Sir J. W. Dawson, F.R.S., 552
- Glacial Epoch, Continuity of the, G. F. Wright, 520
- Glacial Erosion in Alaska, Prof. G. Frederick Wright, 316
- Glacial Period, New England and the Upper Mississippi Basin in, J. D. Dana, 92
- Glacial Potholes of Cooper's Island, U.S., W. O. Crosby, 160
- Glacial Striæ in Somerville, Mr. Upham, 183
- Glaciation of Brazil, the Supposed, W. T. Thiselton-Dyer, F.R.S., 4
- Glaciation of Tasmania, the Recent, Dr. Alfred R. Wallace, F.R.S., 3
- Glaciers, Artificial, K. R. Koch, 321
- Glaisher (J., F.R.S.), Rainfall of Jerusalem, 297
- Glan (Paul), Change of Intensity of Light Polarised Parallel to Plane of Incidence by Reflection on Glass, 239; Luminosity of Candle calculable from Dimensions of Flame, 460
- Glass Films of Remarkable Stability, Method of Producing Thin, F. Kohlrausch, 439
- Glazebrook (R. T., F.R.S.), Heat: an Elementary Text-book, 386; Light: an Elementary Text-book, Theoretical and Practical, for Colleges and Schools, 432
- Glycogenesis, Hepatic, Dr. Noel Paton, 141
- Golasz (Dr.) on the Presence of a Polymorphous Microbe in Syphilis, 500
- Gold, the Structure of Native, Prof. Behrens, 144
- Gold Nuggets, the Origin of, Prof. A. Liversidge, 415
- Goldscheider (Dr.), Leucocytosis, 167
- Goldstein (Prof.), the Kathodic Light, 427
- Golf: a Royal and Ancient Game, W. Rutherford, 338
- Golz's (Prof.) Research on a Dog which Survived for a Long Time Extirpation of the Cerebrum, 596
- Good Words, Science in, 543
- Gordon (Dr. George), Death of, 251
- Gordon (Hugh), Elementary Course of Practical Science, Sir Philip Magnus, 121
- Gore (Dr. G.), Decomposition of Liquids by Contact with Powdered Silica, 272
- Gore (J. E.), an Astronomical Glossary, 51
- Göttingen Royal Society, 24, 548, 596
- Gouy (M.), Vision of Opaque Objects by means of Diffracted Light, 72
- Grablowitz (Giulio), Mareographical Observations in Italy, 134
- Grafton High Speed Steam-engine, E. W. A. Anderson, 610
- Grant (Dr. A. E.), Hindoo Dwarfs, 221; Col. Fraser and, Hindoo Dwarfs, 396
- Graphic Arithmetic and Statics, J. J. Prince, 28
- Gratings, the Astigmatism of Rowland's Concave, 489
- Gray (Prof. A.), Problèmes et Calculs Pratiques d'Electricité, M. Aimé Witz, 145; Notes on Recent Researches in Electricity and Magnetism, Prof. A. Gray, 357; the Foundations of Dynamics, 389; a Text-Book on Electro-Magnetism and the Construction of Dynamos, Dugald C. Jackson, 429; a Manual of Telephony, W. H. Preece, F.R.S., and Arthur J. Stubbs, 454
- Gray (O. L.), Magnetic Experiments in Senegambia, 141; on the Minimum Temperature of Visibility, 613
- Great Britain and Ireland, the Iron Ores of, J. D. Kendall, Bennett H. Brough, 27
- Greaves (John), a Treatise on Elementary Hydrostatics, 503
- Greece, Severe Earthquake in, 604
- Green (A. G.), Oxidation of Paratoluidine, 142
- Green (Prof. J. H., F.R.S.), Text-book of Geology, Sir Archibald Geikie, F.R.S., 287
- Green (Prof. J. R.), Germination of Pollen Grain and Nutrition of Pollen Tube, 424
- Greenhill (Alfred George, F.R.S.), the Applications of Elliptic Functions, H. F. Baker, 359
- Greenland Expedition of the Berlin Geographical Society, the, 399
- Greenwich, a New Telescope for, 464
- Gregory (Dr. J. W.), the Natural History of East Equatorial Africa, 12; Journey to Mount Kenia, 276, 443; Place of Waldensian Gneisses in Cottian Sequences, 403; Eozoölogical Structure of the Ejected Blocks of Monte Somma, 499
- Gregory (R. A.), the Progress of Technical Education, 185; In the High Heavens, Sir Robert S. Ball, F.R.S., 243; the Vault of Heaven, 291; the Vatican Observatory, 341
- Grenoble, Botanical Garden established in Mountains near, 393
- Gresham University Commission, the Report of the, 405
- Griffiths (Mr.), Compensating Open-Scale Barometer, 379
- Grijns (Dr.), Determination of Volume of Blood Corpuscles, 476
- Grotto, Adelsberg, Investigation of, E. A. Martel, 256
- Grubb (Sir Howard), New Form of Equatorial Mounting for Monster Reflecting Telescopes, 499
- Guerbet (M.), Campholene, 379
- Guignard (Léon), Localisation of Active Principles in Tropæolum, 47
- Gumlich (Dr.), Feeding Experiments with Nucleic Acid on Dogs, 167
- Günther (Dr.), Dried Locusts as Food for Insectivorous Cage and Game-Birds, 253
- Günther (Dr. Carl), Einführung in das Studium der Bakteriologie mit Besonderen Berücksichtigung des Mikroskopischen Technik, Mrs. Percy Frankland, 455
- Guttmann (Dr. S.), Death of, 251
- Guyon (E.), Ripples, 143
- Gynodiœcism (III.), J. C. Willis, 167
- Haberlandt (Dr.), Eine Botanische Tropenreise, Indomalayische Vegetationsbilder und Reiseskizzen, 453
- Haddon (Prof. A. C.), the Ethnography of the Aran Islands, county Galway, 468
- Hadramaut, Herr Hirsch's Journey to, 233
- Hagen (Dr. H. A.), Death and Obituary Notice of, 63
- Hail, on, Hon. Rollo Russell, 217
- Hall (H. S.), Elementary Trigonometry, 456
- Hall (H. S.), and J. S. Stevens, a Text-book of Euclid's Elements, 599
- Hall (Maxwell), the Sun-spot Period and the West Indian Rainfall, 399
- Haller (A.), Two Isomeric Methylcyanocamphors, 548
- Halley's Comet, 442
- Halliburton (Prof. W. D.), the Essentials of Chemical Physiology, 313
- Hallwachs (W.), Differential Method of Determining Refractive Index of Solutions, 206
- Halo Phenomena, the Frequency of, G. Hellmann, 130
- Halogens, Action of, on Homopyrocatechol, H. Cousin, 595
- Halsted (Prof. Byron), the Solandi Sun-printing Process as applied to Botanical Technique, 370
- Hamburg Cholera Epidemic, Meteorological Conditions of, Captain C. H. Feemann, 180
- Hampson (G. F.), Specimen of *Gaudaritis flavata*, Moore from the Khâri Hills, 571

- Hamy (E. T.), Merovingian and Carolinian Crania of Boulogne District, 472
- Hamy Maurice, Method of Pivot Testing, 111; the Measurement of Stellar Diameters, 275
- Hann Dr. J., Contribution to Daily Range of Meteorological Elements in Higher Strata of Atmosphere, 321; Results of the Swedish International Polar Expedition at Cape Thorsden, Spitzbergen, 1882-83, 495
- Hannay (J. B.), the Artificial Formation of the Diamond, 530
- Hanson (Dr. A. M.), the Origin of Lake Basins, 364
- Har Dalam Cavern, the, and its Ossiferous Contents, 514
- Harding (C.), the Great Storm of November 16-20, 1893, 215, 294
- Hart (L.), Application of Sound-Vibrations to Analysis of Mixtures of Gases, 47
- Harker (J. A.), on the Latent Heat of Steam, 5
- Harkness (James), a Treatise on the Theory of Functions, 477
- Harley (Dr. Vaughan), Sugar as Food in Production of Muscular Work, 253
- Harmonic Analysers, Prof. O. Henrici, F.R.S., 521
- Harmonics: an Elementary Treatise on Fourier's Series, and Spherical, Cylindrical, and Ellipsoidal Harmonics, with Applications to Problems in Mathematical Physics, W. E. Byerly, 598
- Harper's Magazine*, Science in, 444
- Harrington (Prof. M. W.), Unusual Rise of Water characteristic of Atlantic Coast Storms, 297; History of Weather Map, 329; the Texan Monsoons, 450; the Currents in the Great Lakes of North America, 592
- Harris (Walter B.), a Journey through the Yemen, 291
- Harshberger (Dr.), the Original Home of Maize, 298
- Hart (J. H.), Transportation of Cacao-Seed, 64
- Harting (J. E.), the Great Auk's Egg, 432
- Hartl (Colonel H.), Mercurial Barometers Compared with Boiling-point Thermometers, 424
- Hartmann (Dr.), Iodine as a Base-forming Element, 442; the New Iodine Bases, 467
- Hartog (P. J.), on the Latent Heat of Steam, 5
- Hartog (Prof. Marcus), on an Undescribed Rudimentary Organ in Human Attire, 199
- Harvard College Meteorological Observatories in Peru, Prof. W. H. Pickering, 180
- Harvard College Observatory Report, 256
- Harvey (Arthur), the Height of an Aurora, 542
- Hasall (Dr. A. H.), Death and Obituary Notice of, 581
- Hasskarl (Dr. J. K.), Death of, 296
- Hauser (Herr), Method for Making Permanent Microscopic Preparations of Particular Colonies on Gelatine Film, 273
- Haweswater, Bathymetrical Survey of, Mill and Heawood, 540
- Hay, Spontaneous Heating and Ignition of, M. Berthelot, 240
- Hay (W. P.), the Blind Crayfish, 133
- Haycraft (Dr. John Berry), Artificial Amœbe and Protoplasm, 79
- Hazen (Prof. H. A.), the Climate of Chicago, 15; Errors of the Psychrometer, 263; Ten Miles above the Earth, 423; Solar Magnetic Influences on Meteorology, 464
- Healthy Hospitals: Observations on Hospital Construction, Sir Douglas Galton, K.C.B., F.R.S., 290
- Heat: on the Latent Heat of Steam, P. J. Hartog and J. A. Harker, 5; Heat, and the Principles of Thermodynamics, Dr. C. H. Draper, 148; a Text-book of Heat, R. Wallace Stewart, 171; Solar Spots and Heat received by Earth, A. Savéniel, 284; Heat: an Elementary Text-book, Theoretical and Practical, for Colleges and Schools, R. T. Glazebrook, F.R.S., 386; the Theory of Heat, Thomas Preston, Prof. G. Carey Foster, F.R.S., 573; Influence of Pressure upon Specific Heat, P. de Heen, 617
- Heaviside (Oliver, F.R.S.), Quaternionic Innovations, 246
- Heawood (E.), Bathymetrical Survey of Haweswater, 540
- Heen (P. de.), Influence of Pressure upon Specific Heat, taken below and above the Critical Temperature, 617
- Heider (Dr.), Death of, 270
- Height of an Aurora, the, Arthur Harvey, 542
- Heim (M.), Growth of Fungus-Mycete in Solution of Sulphate of Quinine, 509
- Heliometer, Small Distances Measured with the, 209
- Heliotropism, Experiments in, G. J. Romanes, F.R.S., 140
- Hellman (Prof.), Halo Phenomena, 48, 130; Snow-Crystals, 216, 232; the Temperature in and outside Berlin, 460
- Hemslow (Rev. G.), Origin of Structural Peculiarities of Climbing Stems, 307; Origin of Plant-structures by Self-adaptation to Environment, 160
- Henrici (Prof. O., F.R.S.), Mathematical Calculating Machines, 521; Harmonic Analysers, 521
- Henry (A. J.), Early Individual Observers in United States, 329
- Henry (M.), New Compounds of Formaldehyde, 255; New Method of Preparing Halogen Substitution Products of Oxides (Ethers) of Alkyl Radicles, 255
- Henry Prince, the Navigator, 443
- Hepatic Glycogenesis, Dr. Noel Paton, 141
- Hepatica, Handbook of British, M. C. Cooke, 220
- Hepites (Dr. S. C.), the Climate of Sulina, 297
- Herdman (Prof. W. A., F.R.S.), the Protective Colouration of *Tribius varians*, 417; Dredging Expedition at Port Erin, 503
- Heredity: an Examination of Weismannism, Dr. G. J. Romanes, F.R.S., 49, 78; Rejoinder to Prof. Weismann, Herbert Spencer, 155; Panmixia, George J. Romanes, F.R.S., 599
- Hermann (Dr.), Chloraurate of Silver, 510
- Hermite's (M.), System of Treating Sewage Matter with Electrolysed Sea-water, Dr. C. Kelly, 539
- Hermann (Dr. Rafael), the Kulm District of Lenzkirch, Black Forest, 230
- Hertz (Prof.), Death of, 251; Obituary Notice of, 265; Righi's Experiments on Hertz's Oscillations, Dr. Rubens, 167; English Translation of Prof. Hertz's "Electric Waves," Prof. D. E. Jones, 396
- Heycock (C. T.), Freezing-points of Alloys in which Solvent is Thallium, 239; Freezing-points of Triple Alloys, 306
- Hicks (J. J.), Bartrum's Open-Scale Barometer, 488
- Hickson (Sydney J.), the Fauna of the Deep Sea, 502
- High Pressure, the Behaviour of Liquids under, J. W. Rodger, 506
- Hill (Dr. J. M.), on a Spherical Vortex, 498
- Hillier (H. Croft), Biology as it is applied against Dogma and Freewill and for Weismannism, 386
- Himalayas, Rock Basins in the, R. D. Oldham, 77
- Himalayas, Western Terrestrial Refraction in the, General J. T. Walker, F.R.S., 498
- Himmel und Erde*, 184
- Himstedt (Herr F.), a Modified Form of Thomson Quadrant Electrometer, 181
- Hind (Dr. Wheelton), the Genus *Vaidites* occurring in Nova Scotia Coal-Formation, 475
- Hindoo Dwarfs, Col. A. T. Fraser, 35; A. E. Grant, 221; Col. Fraser and Hindoo Dwarfs, Dr. A. E. Grant, 396
- Hinks (A. R.), Correlation of Solar and Magnetic Phenomena, 78
- Hinrichs (G.), Determination of True Atomic Weight of Nitrogen, 96; Exact Atomic Weights, with Silver as Standard, 476
- Hirbel (Prof. V.), the Geology of Thessaly, 36
- Hirsch (Prof. A.), Death of, 320; Herr Hirsch's Journey to Hadramaut, 233
- Historical Chemistry, Essay in, T. E. Thorpe, F.R.S., M. M. Pattison Muir, 551
- Hlek (M.), a Hermaphroditical Ray, 264
- Höbvel (Baron von), Flattening of Chest and Skull in Celebes, 377
- Höbnel (Lieut. von) Wounded, 112
- Höbnel (Ludwig von), the Last Great Lakes of Africa, 457
- Homogeneous Division of Space, on, Lord Kelvin, F.R.S., 445, 469
- Homopyrocatechol, Action of Halogens on, H. Cousin, 595
- Hoogewerff (M.), two Camphoramic Acids, 380
- Hooker (S. C.), Bromolapachol, 239; Synthesis of Lapachol, 306
- Horse, on the Second and Fourth Digits of the, Prof. Cossar Ewart, 571
- Horsley (Prof. Victor, F.R.S.), the Directorship of the Institute of Preventive Medicine, 292
- Horticultural Society, Foundation of International, 13
- Horticulture: Development and Maturation of Cider-Apple, L. Lindet, 119
- Horticulture: the Practice of Spraying Fruits with Mineral Insecticides, Dr. R. C. Kedzie, 394
- Hospitals: Construction, Observations on, Sir Douglas Galton, K.C.B., F.R.S., 290
- Houllevigue (L.), Variations of the Peltier Effect produced by Magnetisation, 524



- Houssay (Frédéric), the Industries of Animals, 171  
 Houston (Alex. C.), the Purification of Sewage by Bacteria, 249  
 Howard (Luke), on Cloud Nomenclature, 607  
 Howes (Prof. G. B.) *Lepidosiren paradoxa*, 576  
 Howorth (Sir Henry H., F.R.S.), Geology in Nubibus, 29; Dr. Alfred R. Wallace, F.R.S., 52, 173; a Reply to Dr. Wallace and Mr. La Touche, 75; R. M. Deeley, 122, 173; Geological History of Arctic Lands, 36; Mammoth Remains in Canada and Alaska, 94; the Origin of Lake Basins, 220  
 Hudleston (W. A., F.R.S.), Geological Society Anniversary Address, 451  
 Hughes (Prof.), Geological Evidence for Recurrence of Ice-Ages, 143; Earth Movements and the Question of the Cause of Glacial Conditions, 426  
 Hull (Prof. Edward, F.R.S.), Artesian Boring at New Lodge, near Windsor Forest, 239  
 Human Attire, on an Undescribed Rudimentary Organ in, Prof. Marcus Hartog, 199, 247  
 Human Physiology, John Thornton, Dr. J. S. Edkins, 431  
 Human and Comparative Anatomy at Oxford, Prof. J. Burdon Sanderson, F.R.S., 6; Prof. G. Ray Lankester, F.R.S., 29  
 Humburg (Herr), Effect of Electrolytic Dissociation on Magnetic Rotatory Polarisation of Solutions, 37  
 Hume (Dr. W. F.), the Genesis of the Chalk, 271  
 Hummel (J. J.), Colouring Matter of "Tesu," 377  
 Hunt (Arthur R.), Crystalline Schists of Devonian Age, 554; the Late Mr. Pengelly, and the Age of the Bovey Lignite, 600  
 Hunt (C.), the Manufacture of Gas, 561  
 Hurmuzescu (M.), Experiments on Electrical Convection in Air, 254; Dielectrine, a New Insulating Material, 370  
 Hurricanes of South Sea, Tropical, E. Kipping, 463  
 Hurst (Geo. H.), Painter's Colours, Oils and Varnishes, a Practical Manual, 194  
 Huxley (Prof. T. H.), Collected Essays, Prof. E. Ray Lankester, F.R.S., 310  
 Hydrogen, New Notation for Lines in Spectrum of, 162  
 Hydrogen Envelope of the Star D.M. + 30° 3639, Prof. W. W. Campbell, 210  
 Hydromeduse, Spermatogenesis in, Dr. Rawitz, 240  
 Hydrophobia: Pasteur Institute Statistics for November, 322; Report of Pasteur Institute for 1893, Henri Poitevin, 581  
 Hydrostatics, a Treatise on Elementary, John Greaves, 503  
 Hydrostatics and Pneumatics, R. H. Pinkerton, 362  
 Hydroxylamine, the Preparation and Properties of Free, A. E. Tutton, 105  
 Hygiene: a Treatise on Hygiene and Public Health, J. Stephenson and Shirley F. Murphy, 285; Public Health and Demography, Edward F. Willoughby, 285; Methods of Practical Hygiene, Prof. K. B. Lehmann, 285; Death of Dr. Heider, 270; Observations on Hospital Construction: Healthy Hospitals, Sir Douglas Galton, K.C.B., F.R.S., 290; Hygienic Laboratory established at Bonn University, 345; Distribution of Zymotic Disease by Sewer Air, Mr. Laws, 347; the Attitude of Statesmen towards the Claims of Hygiene, 565  
 Hysteresis attending Change in Length produced by Magnetisation in Nickel and Iron, the, H. Nagaoka, 229; Prof. Knott, 230  
 Ice Age and its Work, the, Dr. A. R. Wallace, 31  
 Ice Age, the Canadian, Sir J. W. Dawson, F.R.S., 552  
 Ice Ages, Geological Evidence for Recurrence of, Prof. Hughes, 143  
 Ice, the Viscous Motion of, John Tennant, 173  
 Ice, Eels in, 271  
 Ice, Micro-Organisms in, Messrs. Salazar and Newton, 322  
 Ice-Sheet, the Scandinavian, Prof. T. G. Bonney, F.R.S., 388  
 Ichthyology: the Flying Fish, 13; a New Acraniate (*Asymmetron lucayanum*) found at Bahamas, E. A. Andrews, 14; a Parasitic Disease in Flounders, G. Sandeman, 119; Ewart's Investigations on Electric Fishes, Prof. Gustav Fritsch, 222; a Hermaphroditical Ray, M. Hock, 264; the Limbs of *Lepidosiren paradoxa*, Prof. E. Ray Lankester, F.R.S., 555, 601; *Lepidosiren paradoxa*, Prof. G. B. Howes, 576  
 Identification of Habitual Criminals; Proposed Anthropometrical Registry, 487  
 Ignition of Explosive Gaseous Mixtures, the Temperature of, A. E. Tutton, 138  
 In the High Heavens, Sir Robert S. Ball, F.R.S., R. A. Gregory, 243  
 India: Proposed Pasteur Institute for, 13, 180; on a Meteorite which fell near Jafferabad on April 28, 1893, Prof. John W. Judd, F.R.S., 32; Volcano Folk-Lore of India, Dr. V. Ball, 109; Records of Geological Survey of India, 109; the Survey of the Laccadives, 111; the Death of Mr. H. M. Becher, 112; the Past Monsoon in India, 130; the Indian Vivisection Bill and the Anti-Vivisectionists, 130; Evolution of Geography of India, R. D. Oldham, 163; the Telephone in India, 460; the Blind Root-Suckers of the Sunderbans, 461; the Flowering Plants of Western India, Rev. A. K. Nairne, 501  
 Indiana, Wheat-Growing in, 15  
 Indians, Sense of Taste among (North American), E. H. S. Bailey, 82  
 India-rubber, the Cultivation of, Dr. Ernst, 35  
 Industries of Animals, the, Frédéric Houssay, 171  
 Infinitesimal, Phenomena of the Time-, Prof. E. L. Nichols, 113  
 Influenza and Ozone, 180  
 Influenza, Epidemic, Hon. R. Russell, 210  
 Influenza Epidemic in Germany, 1889-90, 569  
 Inoculation against Serpent Poison, A. Calmette, 548  
 Inorganic Chemistry for Beginners, Sir Henry Roscoe, F.R.S., 3  
 Insect World, Romance of the, L. N. Badenoch, 314  
 Insects, Our Household, an Account of the Insect Pests Found in Dwelling-houses, Edward A. Butler, 147  
 Insects, Report of Observations of Injurious, and Common Farm Pests during the year 1893, Eleanor A. Ormerod, 480  
 Insecticides, Mineral, the Practice of Spraying Fruits with, Dr. A. C. Kedgie, 394  
 Institute Scheme, the Indian Pasteur, 13, 180  
 Institute of Science, Art, and Literature, Opening of Carlisle, 63  
 Institutes of Physiology and Electro-Biology established by M. G. Solvay at Brussels, 180  
 Institution of Mechanical Engineers, 18, 350, 608  
 Institution of Naval Architects, 490  
 Institution, Royal, Resolution of Condolence with Mrs. Tyn-dall, 179  
 Internal Combustion Motors, Bryan Donkin, N. J. Lockyer, 430  
 International Exhibition at Hobart, Tasmania, Coming, 13  
 International Horticultural Society, Foundation of, 13  
 International Journal of Microscopy and Natural Science, 255  
 International Medical Congress, the, 538; Piero Giacosa, 578; the Organisation of Science, the Position of the State in respect to Modern Bacteriological Research, 563  
 International Sanitary Conference, the, 538  
 Internationales Archiv für Ethnographie, 377  
 Inwards (Richard), Weather Lore, 217; some Phenomena of the Upper Air, 619  
 Iodine as a Base-forming Element, Prof. Victor Meyer and Dr. Hartmann, A. E. Tutton, 442  
 Iodine Bases, the New, Prof. Victor Meyer and Dr. Hartmann, A. E. Tutton, 467  
 Ireland, Geological Survey of, 519  
 Iron Ores of Great Britain and Ireland, J. D. Kendall, Bennett H. Brough, 27  
 Iron, the Transformation of, E. Charpy, 192  
 Iron, Wrought, in Madras, 255  
 Iron, Law of Magnetisation of Soft, P. Joubin, 284  
 Iron, Magnetic Properties of, at Various Temperatures, M. P. Cuvier, 595, 620  
 Irrigation Reservoirs in Egypt, the Projected, 129  
 Irritability of Plants, on the, Prof. F. Elfving, 466; Prof. Pfeffer, 586  
 Irvine (C. M.), Meteor seen at Lesmahagon, N.B., 129; Excessive Rainfall at Lesmahagon, 440  
 Iseran, Mount, Henri Ferrand, 134  
 Isoperimetrical Problems, Lord Kelvin, P.R.S., 515  
 Italiano, Nuovo Giornale Botanico, 594  
 Italy, Grablovitz's Mareographical Observations in, 134  
 Italy, Adoption of Signor G. Jervis's Improved Clock-dial and Time-table, 81  
 Ivory in South Africa, Large Supply of, 13

- Jablochkoff (Paul), Death of, 558  
 Jack (P. L.), Progress in 1892 of Geological Survey of Queensland, 109  
 Jackson (Dugald C.), a Text-Book on Electromagnetism and the Construction of Dynamos, Prof. A. Gray, 429  
 Jackson (D. H.), Note on Hyponitrites, 118  
 Jackson (Mr. F. G.), Return of, 301  
 Jacob (Dr. E. H.), Death of, 486  
 Jadrow, Disease and Race, 575  
 Jafferabad, on a Meteorite which fell near, on April 28, 1893, Prof. John W. Judd, F.R.S., 32  
 Jahn (Dr.), the alleged Anti-primordial Fauna of Bohemia, 297  
 Jahn (Herr), the Effect of Wave-length in dealing with Refractive Index in Elucidation of Chemical Constitution, 582  
 Jahrbuch of Geology, Austrian, 46  
 Jamaica, Notes on the Habits of a Jamaican Spider, T. D. A. Cockerell, 412  
 Jameson (H. G.), Illustrated Guide to British Mosses, 479  
 Janet (Charles), the Nematodes of the Pharyngean Glands of Ants, 119  
 Janet (P.), on an Electrochemical Method of Observation of Alternating Currents, 620  
 Janssen (Dr.), the Presence of Oxygen in the Sun, 585  
 Japan, the Edible Lichen of, Dr. M. Miyoshi, 253  
 Japp (F. R.), Preparation of a  $\alpha$ - $\beta$ -diphenylindoles from Benzoin and Primary Benzenoid Amines, 118  
 Jay (Dr.), the Preparation of Hydrazine Salts from Diazo-Derivatives of Acetic Acid, 585  
 Jersey, Prehistoric Man in, Edward Lovett, 487  
 Jervis's (Signor G.), Improved Clock-dial and Time-table adopted in Italy, 81  
 Joannis(A.), Action of Nitrogen, Nitrous Oxide, and Nitric Oxide on Alkaline Ammoniums, 548  
 Joannis (M.), Compounds of Carbon Monoxide with Potassium and Sodium, 66  
 Johannessen (Hans), Dr. Nansen's Expedition, 85  
 Johnston (W. J.), an Elementary Treatise on Analytical Geometry, 99  
 Johnston-Lavis (Prof. H. J.), Enclosures of Quartz in Lava of Stromboli, 143; Eozoöcal Structure of the Ejected Blocks of Monte Somma, 499  
 Johore, Harry Lake, 370  
 Joly (A.), Action of Heat on Potassium and Sodium Ruthenium Nitrites, 452; on Thallium Hypophosphates, 524; Action of Water on Bicalcic Phosphates, 572  
 Joly (Dr. J., F.R.S.), Effect of Temperature upon Sensitiveness of Photographic Dry Plate, 379; some Simple Methods in teaching Elementary Physics, 379; Thermal Expansion of Diamond, 480; the Artificial Formation of the Diamond, 530  
 Jones (Prof. D. E.), English Translation of Prof. Hertz's "Electric Waves," 396  
 Jones (Harry C.), the Freezing-points of Dilute Aqueous Solutions, 132  
 Jones (O. G.), Viscosity of Liquids, 402  
 Jones (T. Gilbert), Machine Drawing, 362  
 Jones (Thomas), Machine Drawing, 362  
 Jones (Prof. T. Rupert, F.R.S.), Rhætic and some Liassic Ostracoda of Britain, 306  
 Jørgensen (Alfred), Micro-Organisms and Fermentations, Dr. A. A. Kanthack, 527  
 Joubin (P.), Law of Magnetisation of Soft Iron, 284; Magnetisation of Soft Iron, 308  
 Joule Memorial Statue, Unveiling of the, 163  
 Journal of Botany, 46, 330, 424, 547  
 Judd (Prof. John W., F.R.S.), on a Meteorite which fell near Jafferabad in India on April 28, 1893, 32; Chemical Action of Marine Organisms, 235  
 Jukes-Browne (A. J.), the Geographical Evolution of the North Sea, 32; the Formation of Flints, 160; Purbeck Beds of Vale of Wardour, 191  
 Jungfleisch (E.), a New Isomeride of Cinchonine, 263  
 Jupiter, the Planet, 18, 67  
 Jupiter and his Red Spot, W. F. Denning, 104  
 Jupiter's Fifth Satellite, Period of, Prof. E. E. Barnard, 85  
 Jupiter's First Satellite, Anomalous Appearance of, 300  
 Jupiter's Satellites in 1664, 323  
 Juppont (M.), Mutual Action of Bodies vibrating in Fluid Media, 143  
 Kämpfe (Herr Bruno), Formula giving all Values of Integral for Probable Error, 133  
 Kangaroo, the Earliest Mention of the, in Literature, Baron C. R. Osten-Sacken, 198  
 Kanthack (Dr. A. A.), Micro-Organisms and Fermentation, Alfred Jørgensen, 527  
 Kapp (Gisbert), Dynamos, Alternators, and Transformers, 337  
 Karsten (G.), Embryology of Gnetum, 306  
 Karstphänomen, das, Dr. Jovan Cvijic, 197  
 Kate (Dr. H. ten), the Ethnological Museum at Leyden, 165  
 Kathodic Light, the, Prof. Goldstein, 427  
 Katzenstein (Dr.), Experiments on Median Pharyngeal Nerve, 168  
 Kayser (Prof.), the Spectra of Tin, Lead, Arsenic, Antimony, and Bismuth, 509  
 Kearton (J. W.), a New Mode of making Magic Mirrors, 354  
 Kedzie (Dr. A. C.), the Practice of Spraying Fruits with Mineral Insecticides, 394  
 Keeler (Prof.), the Wave-Lengths of the Nebular Lines, 18  
 Keiser (Dr.), the Explosive Metallic Derivatives of Acetylene, 209; the Atomic Weight of Palladium, 418  
 Kelly (Dr. C.), M. Hermite's System of Treating Sewage Matter with Electrolysed Sea-Water, 539  
 Kelvin (Lord, P.R.S.), Anniversary Address to Royal Society, 134; on Homogeneous Division of Space, 445, 469; Isoperimetrical Problems, 515  
 Kempe (A. B., F.R.S.), the De Morgan Medal, 80; on Regular Difference Terms, 618  
 Kendall (J. D.), Iron Ores of Great Britain and Ireland, Bennett H. Brough, 27  
 Kennedy (Prof.), Presidential Address to Institution of Mechanical Engineers, 608  
 Kerez (Dr.), Possible Transmission of Tubercle Bacillus by Cigars, 371  
 Keuchler (J.), Measurements of Growth of Trees, 439  
 Kew Index of Plant Names, 241  
 Kew (Harry Wallis), the Dispersal of Shells, Clement Reid, 361  
 Khâri Hills, Specimen of *Gaudaritis flavata*, Moore, from the, G. F. Hampson, 571  
 Kidd (Benjamin), Social Evolution, Dr. Alfred R. Wallace, F.R.S., 549  
 Kinetic Theory of Gases, a Treatise on the, Dr. William Watson, F.R.S., Prof. P. G. Tait, 73  
 Kipping (F. S.), the Action of Aluminium Chloride on Heptylic Chloride, 118; Conversion of  $\alpha$ -hydrindonoxime into Hydrocarbohostyryl, 142  
 Kirby (W. F.), Chinese Central Asia: a Ride to Little Tibet, Henry Lansdell, 309; the Butterflies and Moths of Teneriffe, A. E. Holt White, 384; Beetles of New Zealand, 459; Bees and Dead Carcasses, 555  
 Kirchhoff's Law connecting Absorptive and Emissive Powers of Substances tested for Glass, by G. B. Rizzo, 606  
 Kjellin (Dr.), Ethyl and Methyl Derivatives of Hydroxylamine, 38  
 Klein (Dr. E., F.R.S.), Cholera, 492  
 Klein (Prof. Felix), Lectures on Mathematics, 456  
 Klemencic (Ignaz), Absorption and Branching of Oscillations in Wires, 117  
 Klemencic (Prof.), the Magnetisation of Iron and Nickel Wires by Rapid Electrical Oscillations, 607  
 Klinkhardt (F.), German Superstitions about Minerals, 230  
 Knight (S. R.), Elementary Trigonometry, 456  
 Knipping (E.), Tropical Hurricanes of South Sea, 463  
 Knott (Prof.), Magnetic Twist Cycles for Iron and Nickel, 230  
 Koch (K. R.), Simple Method of Testing Conductivity of Dielectric Liquids, 118; Artificial Glaciers, 321  
 Kohlrausch (F.), Method of Producing Thin Glass Films of Remarkable Stability, 439  
 König (W.), Hydrodynamical Acoustical Investigations, 239  
 Konshin (M.), the Old Beds of the Amu-Daria, 515  
 Köppen (F. T.), Amber in Russia, 181  
 Korösi, Results Derived from the Natality Table of, by Employing the Method of Contours or Isogens, Francis Galton, F.R.S., 570  
 Korösi (Joseph), an Estimate of the Degree of Legitimate Natality, as shown in the Table of Natality compiled by the Author from Observations made at Budapest, 570  
 Kossel (Prof. A.), Nucleic Acid, 240

- Krahmer (Dr. L.), Death of, 251  
Kreitner (Gustav von), Death of, 184  
Krueger (Prof.), a Mistaken Cometary Discovery, 608  
Kryloff (Mr.), the Upper Yenisei Region, 230  
Küster (Baron K. von), Death of, 270  
Kynaston (Herbert), Gosau Beds of Salzkammergut, 239
- La Touche (T. D.), the Erosion of Rock Basins, 39; the Origin of Lake Basins, 365  
Laboratory at Claybury, the Projected Pathological, 129  
Laboratories of the Institute of Chemistry, the New, 154  
Laboratories, Prof. Ira Remsen on Chemical, 531  
Lafar, (Dr.), Vinegar-producing Yeast, 183  
Lake (Harry), Johore, 370  
Lake Basins, the Origin of, R. D. Oldham, 197; Dr. Alfred R. Wallace, F.R.S., 197, 220; Sir Henry H. Howorth, F.R.S., 220; John Aitken, F.R.S., 315; R. S. Tarr, 315; Dr. A. M. Hanson, 364; T. D. La Touche, 365; Alfred C. R. Selwyn, F.R.S., 412  
Lake-water, Observations on Amount of Solid Matter in Solution in, A. Delebecque, 160  
Lakes of Africa, the last Great, Ludwig von Höhnel, 457  
Lakes, the Finger, in New York State, R. S. Tarr, 606  
Lakes of North America, the Currents in the Great, Prof. Mark W. Harrington, 592  
*Laminariaceæ*, the, W. A. Setchell, 207  
Lamp, Improved Lantern Oil, 110  
Lancaster (A.), the Commencement and End of Winter, 394  
Lancaster (J.), the Continuous Flight of Frigate-Birds, 605  
Land, Recent Local Rising of, in the North-west of Europe, C. A. Lindvall, 433  
Landon (A. H. Savage), Fresh Light on the Ainu, 248  
Landscape Marble, Berry Thompson, 522  
Langley (Prof. S. P.), the Internal Work of the Wind, 273; the Smithsonian Institution Report, 397  
Langmore (Rev. C. W.), a Lunar Rainbow, 321  
Lankester (Prof. E. Ray, F.R.S.), Human and Comparative Anatomy at Oxford, 29; Reappearance of the Freshwater Medusa (*Limnocoodium sowerbii*), 127; Collected Essays, Prof. T. H. Huxley, 310; the Limbs of *Lepidosiren paradoxa*, 555, 601  
Lansdell (Henry), Chinese Central Asia: a Ride to Little Tibet, W. F. Kirby, 309  
Lantern Oil Lamp, Improved, 110  
Lantern Slides, Method for Colouring, for Scientific Diagrams, Dr. J. Alfred Scott, 572  
Lapouge (G. de), Description of Sixty-two Crania taken from a Modern Cemetery at Karlsruhe, 520  
Lapworth (Prof. Chas., F.R.S.), the Face of the Earth, 614  
Larmor (Dr. Joseph, F.R.S.), a Dynamical Theory of the Electric and Luminiferous Medium, 260, 280  
Larsen (Captain), High Southern Latitude reached by *Jason* Whaler, 559  
Latent Heat of Steam, on the, P. G. Hartog and J. A. Harker, 5  
Latitude the Variation of, Prof. S. C. Chandler, 133  
Latitude, on Variations of, F. Folie, 376  
Latitude and Sea Level, the Variation of, Prof. Bakhuyzen, 476  
Latitude, the Definition of, F. Folie, 546  
Laurie (Malcolm), Morphology of Pedipalpi, 378  
Lausanne Municipal Council and Electrical Transmission of Power, 107  
Lavoisier, Proposed Celebration of Centenary of Death of, 603  
Lawrance (H. A.), Correlation of Magnetic and Solar Phenomena, 101  
Laws (Mr.), Distribution of Zymotic Disease by Sewer Air, 347  
Lawson (Dr. A. C.), Anorthosytes of Minnesota Coast of Lake Superior, 131; Laccolitic Sills of North-West Coast of Lake Superior, 131  
Le Chatelier (H.), General Law of Solubility of Normal Substances, 524; on the Fusibility of Mixtures of Salts, 595  
Le Sueur (H. R.), Salts of Dehydracetic Acid, 425  
Lea (M. C.), Researches on Transformation of Mechanical Work into Chemical Action, 181  
Lecher's Method, the Various Electric Wave-Systems obtained by, Signor Mazotto, 83  
Lecouteux (Prof. E.), Death and Obituary Notice of, 33  
Lecture, the Bakerian, 392  
Lecture Experiment, a, J. C. Foye, 531  
Leduc (A.), Proposed Standard of Normal Air, 272  
Léger (E.), a New Isomeride of Cinchonine, 263  
Lehmann (Prof. K. B.), Methods of Practical Hygiene, 285  
Lehmann (O.), the Artificial Colouring of Crystals and Amorphous Bodies, 376  
Leidiè (E.), Action of Heat on Potassium and Sodium Ruthenium Nitrites, 452  
Leland (G. C.), Elementary Metal Work, 554  
Lellmann (Dr. E.), Death of, 206  
Lemoine (M.), Influence of Heat on Reactions in Aqueous Solutions containing Ferric Chloride and Oxalic Acid, 65  
Lenard's (O.) Observations on the Cathode Rays in Gases with High Vacua, 509  
Lepidoptera, Vertical Distribution of British, W. H. Bath, 346  
Lepidoptera: the Butterflies and Moths of Teneriffe, A. E. Holt White, W. F. Kirby, 384  
*Lepidosiren paradoxa*, the Limbs of, Prof. E. Ray Lankester, F.R.S., 555, 601; Prof. G. B. Howes, 576  
Lepierre (Charles), New Ptomaine extracted from Damaged Cheese, 452  
Leprosy, the Bacilli of, N. Wnukow, 231  
Leslie (George D.), Letters to Marco, 170  
Letourneau (Ch.), Stone Cross found at Carnac, 330  
Letters to Marco, George D. Leslie, 170  
Leucocytosis, Dr. Goldscheider, 167  
Leverett (Frank), Further Studies of the Drainage Features of the Upper Ohio Basin, 617  
Lewes (Prof. Vivian B.), Action of Heat upon Ethylene, 424  
Lewin (Dr.), Physiology of Ureter, 43  
Ley (Rev. W. Clement), Sun-spot Phenomena and Thunderstorms, 531  
Leyden, the Ethnological Museum at, Dr. H. ten Kate, 165  
Leyden Museum, Notes from the, 161  
Libraries, Manchester Free, Forty-first Report of, 133  
Libraries, Science at the Free, Mr. Carrington, 418  
Lichen, Edible, of Japan, Dr. M. Miyoshi, 253  
Life and Rock: a Collection of Zoological and Geological Essays, R. Lydekker, 575  
Light, Effects of, on the Electrical Discharge, 226  
Light, the Unit of, Dr. Lummer, 356  
Light, Lectures on Maxwell's Theory of Electricity and, Dr. Ludwig Boltzmann, 381  
Light: an Elementary Text-book, Theoretical and Practical, for Colleges and Schools, R. T. Glazebrook, F.R.S., 432  
Light, Elliptic Polarisation of, Reflected, K. E. F. Schmidt, 547  
Light, Normal and Anomalous Changes of Phase during Reflection by Metals of, W. Wernicke, 547  
Light, the Kathodic, Prof. Goldstein, 427  
Light-Waves and their Application to Metrology, Prof. A. A. Michelson, 56  
Light-sensation, Miss C. L. Franklin's New Theory of, 394  
Lighthouses and Light-ships; Proposed Improved System of Distress Signals, 580  
Lighthouses and Lightships without Submarine Cable, Electric communication between, C. A. Stevenson, 581  
Lighting, Artificial, of Workshops, B. A. Dobson, 18  
Lightning, Method of Photographing Spectrum of, G. Meyer, 417  
Lightning? are Birds on the Wing killed by, Skelfo, 577; G. W. Murdoch, 601  
Lillienthal's Experiments on Flying, Dr. A. du Bois-Reymond, 355  
*Limnocoodium sowerbii*, Reappearance of the Freshwater Medusa, Prof. E. Ray Lankester, F.R.S., 127  
Lindet (L.), Development and Maturation of the Cider Apple, 119  
Lindvall (C. A.), Recent Local Rising of Land in the North-west of Europe, 433  
Linnean Society, 94, 166, 191, 263, 307, 378, 425, 474, 522, 595  
Linnean Society, New South Wales, 119, 168, 264, 424  
Liquid Commutator for Sinusoidal Currents, a, Prof. J. A. Ewing, F.R.S., 317  
Liquids, Viscosity of, O. G. Jones, 402  
Liquids, the Internal Friction of, Prof. T. E. Thorpe, F.R.S., and J. W. Rodger, 419  
Liquids, Methods of Determining Refractive Indices of, Mr. Littlewood, 450

- Liquids, the Decomposition of, by contact with Cellulose, C. Beadle, 457
- Liquids, the Behaviour of, under High Pressure, J. W. Rodger, 506
- Lissajous's Figures, Improved Form of Blackburn's Pendulum for Slow Production of, Prof. A. Righi, 582
- Literature, the Earliest Mention of the Kangaroo in, Baron C. R. Osten-Sacken, 198
- Littledale (St. George), Across Central Asia, 567
- Littlewood (Mr.), Method of Determining Refractive Indices of Liquids, 450
- Liver-Ferment, Note on the, Miss M. C. Tebb, 523
- Liversidge (Prof. A.), the Origin of Gold Nuggets, 415
- Livingstone (Dr.) and the Zambesi Ants, 95
- Lochner (L. J.), the Elongation of Soft Iron by Magnetisation, 160
- Lock's (J. B.) Shilling Arithmetic, Key to, Henry Carr, 480
- Lockyer (J. Norman, F.R.S.), Early Asterisms, 199
- Lockyer (N. J.), Round the Works of our Great Railways, 312; a Text-Book on Gas, Oil, and Air Engines, Bryan Donkin, 430
- Locomotion of Animals, Chrono-Photographic Study of the, 41
- Locusts, Dried, as Food for Insectivorous Cage and Game Birds, Dr. Günther, E. C. Cotes, 253
- Locusts in England, Miss E. A. Ormerod, 253
- Lodge (Prof. Oliver J., F.R.S.), Clerk Maxwell's Papers, 366
- Lommel (E. von), Objective Representation of Interference Phenomena in Spectrum Colours, 46
- London Lunatic Asylums, the Projected Pathological Laboratory in connection with, 129
- London, Map of Electric Lighting Districts of, 298
- London, University of, the Proposed Reconstruction of the, 558
- Loney (S. L.), Solutions of the Examples in the Elements of Statics and Dynamics, 122; Plane Trigonometry, 339
- Long (Prof.), Agricultural Resources of Canada, 561
- Longman's Magazine*, Science in, 156
- Loomis (E. H.), a more Exact Method for Determination of Lowering of Freezing-points, 547
- Lott (Frank E.), Micro-organisms and Fermentation, 577
- Love (A. E. H.), Stability of Certain Vortex Motions, 118; Motion of Paired Vortices with a Common Axis, 499
- Lovett (Edward), Prehistoric Man in Jersey, 487
- Low Vapour Pressures, Measurements of, J. W. Rodger, 436
- Lowe (E. J., F.R.S.), Abnormal Eggs, 366
- Lubudi River, the, 582
- Lüdtke (Herr H.), Properties of Mirror Silver chemically Precipitated on Glass, 229
- Lukuga River explored by M. Delcommune, 559
- Luminiferous Medium, a Dynamical Theory of the Electric and, Dr. Joseph Larmor, F.R.S., 260, 280
- Luminosity of Candle Calculable from Dimensions of Flame, P. Glan, 460
- Lummer (Dr.), the Unit of Light, 356
- Lunar Rainbow, a, Rev. C. W. Langmore, 321
- Lunatic Asylums, London, the Projected Pathological Laboratory in connection with, 129
- Lydekker (Richard), the Royal Natural History, 220; Life and Rock: a Collection of Zoological and Geological Essays, 575
- McAulay (A.), Utility of Quaternions in Physics, Prof. P. G. Tait, 193
- Macaulay (F. S.), Groups of Points on Curves, 498
- McConnell (W.), Gases occluded in Coal from various Durham Collieries, 232
- Macdonald's (Sir Claude) Journey up the Cross River, 346
- Macfarlane (A.), Electric Strength of Solid, Liquid, and Gaseous Dielectrics, 181
- Macfarlane (Dr. A.), on the Definitions of the Trigonometric Functions, 480
- Macgillivray (G. J.), Recognition Marks, 53
- McGregor (J. M.), Ethereal Salts of Diacetyl-glyceric Acid in relation to connection between Optical Activity and Chemical Constitution, 142
- Machine Drawing, Thomas Jones and T. Gilbert Jones, 362
- Mack (F. W.), a Comet-Finder, W. R. Brooks, 543
- McKay (Capt.), the Fate of the Björning Arctic Expedition, 85
- McKillop (Mr.), the Interaction of Hydrogen Chloride and Potassium Chloride, 118
- McLachlan (R., F.R.S.), the Postal Transmission of Natural History Specimens, 172
- Maclear (Rear-Admiral, J.P.), Aurora of February 28, 442
- Macleay Memorial Volume, the, 597
- McLeod (H.), Liberation of Chlorine during Heating of Mixture of Potassium Chloride and Manganic Peroxide, 425
- McMurtrie's (Mr. James) Collection of Fossil Plants acquired by South Kensington Museum, 415
- McNair (Capt. F. V.), U.S. Naval Observatory, 324
- Madagascar, the Silk-Spider of, Dr. Karl Müller, 253
- Madras, Wrought Iron Making in, 255
- Madras Observatory, 511
- Magazines, Science in the, 31, 155, 235, 352, 443, 543
- Magnetism: Correlation of Solar and Magnetic Phenomena, William Ellis, F.R.S., 30, 245; H. A. Lawrance, 101; Dr. M. A. Veeder, 245; Sun-spots and Magnetic Disturbances, Dr. M. A. Veeder, 503; Dr. L. Palazzo, 397; Magnetic Susceptibility of Oxygen, R. Hennig, 108; Magnetic Rotary Dispersion of Oxygen, Dr. Siertsema, 607; Magnetic Shielding of Concentric Spherical Shells, Prof. A. W. Rücker, F.R.S., 141; Magnetic Experiments in Senegambia, T. E. Thorpe, F.R.S., and P. L. Gray, 141; Elongation of Soft Iron by Magnetisation, S. J. Lochner, 160; Law of Magnetisation of Soft Iron, P. Joubin, 284, 308; Magnetic Field of Current running in Cylindrical Coil, Prof. G. M. Minchin, 190; the Hysteresis attending Change in Length produced by Magnetisation in Nickel and Iron, H. Nagaoka, 229; Prof. Knott, 230; Magnetisation of Iron and Nickel Wires by Rapid Electrical Oscillations, Prof. Klemencic, 607; Magnetic-Twist Cycles for Iron and Nickel, Prof. Knott, 230; Magnetic Rotation of Hydrogen and Sodium Chlorides and Chlorine in Different Solvents, W. H. Perkin, 239; Report for 1892 of Magnetic Observatory of Copenhagen, 298; Notes on Recent Researches in Electricity and Magnetism, J. J. Thomson, F.R.S., Prof. A. Gray, 357; a Text-Book on Electromagnetism and the Construction of Dynamos, Dugald C. Jackson, Prof. A. Gray, 429; Variations of the Peltier Effect Produced by Magnetisation, L. Houlléveig, 524; "Magnetarium," H. Wilde, F.R.S., 521; Magnetic Properties of Iron at Various Temperatures, M. P. Currie, 595, 620; New Apparatus for Absolute Measurement of the Magnetic Properties of Different Kinds of Iron, Dr. Roepel, 595
- Magnitude and Position of T Aurigæ, M. Bigourdan, 85
- Magnus (Sir Philip), Elementary Course of Practical Science, Hugh Gordon, 121; on Preparing the Way for Technical Instruction, 400
- Maize, the Original Home of, Dr. Harshberger, 298
- Mallock (A.), Insect Sight and Defining Power of Composite Eyes, 472
- Malpighi (Dr. Marcellus), 583
- Malta, the Har Dalam Cavern, 514
- Mamert (Thomas), on  $\beta$ -dibromopropionic Acid, 524
- Mammalia in North America, the Rise of the, Prof. H. F. Osborn, 235, 257
- Man, the Perfect, Dr. Topinard, 520
- Man of Mentone, the, Arthur J. Evans, 42
- Manchester Free Libraries, Forty first Report of, 133
- Manganese Nodules, the Origin of, Prof. J. W. Judd, 235
- Manganese Peroxide in Sewage, Reduction of, W. E. Adeney, 499
- Manœuvring Powers of Steamships and their Practical Applications, Vice-Admiral P. H. Colomb, R.N., 174
- Mangas, Sugar, W. Trelease, 323
- Marattiaceæ*, Development of the Mucilage-Canals of the, George Brebner, 523
- Marchal (Paul), the Reproduction of Wasps, 47
- Margerie (De), Geographical Conditions of Pyrenees, 275
- Marine Biology: the Pteropod Collections of the *Albatross*, 36; Week's Work of Plymouth Station, 37, 67, 84, 162, 323, 372, 418; some Laboratories of Marine Biology, 70; Projected Marine Biological Station at Millport, N.B., 180; the Protective Colouration of *Vibrios varians*, Prof. W. A. Herdman, F.R.S., 417; the Floor of the Ocean at Great Depths, Dr. John Murray, 426; Entomostraca and Surface Film of Water, Dr. J. Scouffield, 474; the Rovigno Station, 560; the Melbourne Exhibition Aquarium, 583
- Marine Boiler Management and Construction, C. E. Stromeyer, 410

- Marine Engine Trials, Abstract of Results of Research Committee, Prof. T. H. Beare, 350
- Marine Engineering, Effect of Reversing Screw of Steamship on Steering, Captain Bain, 208
- Marine Organisms, the Chemical Action of, Prof. J. W. Judd, 235
- Markham (Clements R., F.R.S.), the Present Standpoint of Geography, 69
- Marr (John E.), the Zoological Record, 123
- Marriott (W.): Thunder and Hailstones of July 8, 1893, 119; Comparative Observations with Two Thermometer Screens at Ilfracombe, 426; the Royal Meteorological Society's Exhibition, 579
- Mars, Melting of the Polar Caps of, Prof. W. H. Pickering, 586
- Marshall (Prof. Milnes, F.R.S.): Death of, 228; Obituary Notice of, 250; Proposed Memorial to, 368
- Martel (E. A.), Investigation of Adelsberg Grotto, 256
- Martin (T. C.), Nikola Tesla, 352
- Mascart (M.): Propagation of Electromagnetic Waves, 379; M. Blondlot's Experiment on Propagation of Hertzian Waves, 394
- Mason (A. T.): Synthesis of Piazine Derivatives, 118; Interaction of Benzylamine and Ethylic Chloracetate, 377
- Mass of the Earth, the, 575
- Massachusetts Institute of Technology, 20
- Massachusetts Coast Sea-Water and Mud, Russell's Observations on Microbial Condition of, 37
- Massachusetts, the Gipsy Moth Plague in, 231
- Massee (George), British Fungus Flora, a Classified Text-book of Mycology, 195
- Masson (M.), Sterilisation of Bread and Biscuit by Baking, 167
- Materia Medica, Chemistry in Relation to Pharmacotherapeutics and, Prof. B. J. Stokvis, 587
- Mathematics: Asymmetrical Frequency Curves, Prof. Karl Pearson, 6; Mensuration of the Simpler Figures, William Briggs and T. W. Edmondson, 28; Bulletin of New York Mathematical Society, 71, 188, 402, 497, 570; American Journal of Mathematics, 93, 449; Simple Groups as far as Order 660, F. N. Cole, 93; Instruments for Drawing Conic Sections, J. Gillett, 94; Mathematical Society, 118, 215, 284, 425, 498, 618; Stability of Certain Vortex Motions, A. E. H. Love, 118; Note on Theory of Groups of Finite Order, Prof. W. Burnside, F.R.S., 118; Solutions of the Examples in the Elements of Statics and Dynamics, S. L. Loney, 122; Formula giving all Values of Integral for Probable Error, Herr Bruno Kämpfe, 133; Regular Sections and Projections of Icosatetrahedron, Prof. Schoute, 144; a Certain Class of Generating Functions in Theory of Numbers, Major MacMahon, F.R.S., 189; French Lady Mathematicians, M. Darboux, 205; Stability of Deformed Elastic Wire, A. B. Basset, F.R.S., 215; Quaternionic Innovations, Oliver Heaviside, F.R.S., 246; Modern Mathematical Thought, Prof. Simon Newcomb, F.R.S., 325; the Applications of Elliptic Functions, Alfred George Greenhill, F.R.S., H. F. Baker, 359; Death of General J. Ammen, 368; Death of Eugène Catalan, 415; Lectures on Mathematics, Prof. Felix Klein, 456; a Treatise on the Theory of Functions, James Harkness and Frank Morley, 477; on the Definitions of the Trigonometric Functions, Dr. A. Macfarlane, 480; on a Spherical Vortex, Dr. J. M. Hill, 498; Groups of Points on Curves, F. S. Macaulay, 498; a Simple Contrivance for Compounding Elliptic Motions, G. H. Bryan, 498; on the Buckling and Wrinkling of Plating supported on a Framework under the Influence of Oblique Stresses, G. H. Bryan, 499; on the Motion of Paired Vortices with a Common Axis, A. E. H. Love, 499; Mathematical Calculating Machines, Prof. O. Henrici, F.R.S., 521; Harmonic Analysers, 521; Prof. Crum Brown on the Division of a Parallelepiped into Tetrahedra, 571; an Elementary Treatise on Fourier's Series, W. E. Byerly, 598; a Text-Book of Euclid's Elements, H. S. Hall and F. H. Stevens, 599; on Regular Difference Terms, A. B. Kempe, F.R.S., 618; on the Sextic Resolvent of a Sextic Equation, Prof. W. Burnside, F.R.S., 618
- Mather (T.), Transparent Conducting Screens for Electric and other Apparatus, 591
- Mawer (W.), Nature Pictures for Little People, 529
- Mawley (E.), Phenological Observations for 1893, 426
- Maxwell's Theory of Electricity and Light, Lectures on, Dr. Ludwig Boltzmann, 381
- Maxwell's (Clerk) Papers, Prof. Oliver J. Lodge, F.R.S., 366
- Mayall (R. H. D.), Current-Sheets, 452
- Mayer (A. M.), Recherches in Acoustics, No. 9, 305; an Apparatus to show simultaneously to several Hearers the Blending of the Sensations of Interrupted Tones, 617
- Mazotto (Signor), the Various Electric Wave Systems obtained by Lecher's Method, 83
- Measurements, Physico-Chemical, W. Ostwald, J. W. Rodger, 219
- Mechanical Engineers, Institution of, 18, 350, 608
- Mechanical Theory of Comets, Prof. J. M. Schaeberle, 84
- Medical Congress, the International, 538, 563; the Eleventh International, Piero Giacosa, 578
- Medicine: Death of Dr. S. Guttman, 251; Death of Dr. L. Krahrmer, 251
- Medicine-Men of Apache Indians, Capt. J. G. Bourke, 439
- Medusa, Reappearance of the Freshwater (*Limnocolium sowerbii*), Prof. E. Ray Lankester, F.R.S., 127
- Meek (Alexander), the Arbuthnot Museum, Peterhead, 20
- Meeres, Bionomie des, Johannes Walther, 244
- Melbourne Exhibition Aquarium, the, 583
- Melde (S.), Determination of Pitches of very High Notes, 560
- Mellus (Dr. E. L.), Experimental Investigation of the Central Nervous System of the Monkey (*Macacus sinicus*), 498
- Melting of the Polar Caps of Mars, Prof. W. H. Pickering, 586
- Memoires de la Société d'Anthropologie de Paris, 283
- Memoirs of Russian Geographical Society, 254
- Memoirs of St. Petersburg Society of Naturalists, 189
- Mendip Earthquake of December 30-31, 1893, Prof. F. J. Allen, 245
- Mendip Hills, Discovery of Petroleum on the, 346
- Mensuration of the Simpler Figures, William Briggs and T. W. Edmondson, 28
- Mentone, the Man of, Arthur J. Evans, 42
- Mentzner (R.), Action of some Metals upon Acid Solutions of their Chlorides, 119
- Mer (Emile), Means of Preventing Wood from being Worm-eaten, 119
- Mercadier's (M.), Test of the Relative Validity of the Electrostatic and the Electromagnetic Systems of Dimensions, Prof. Arthur Rücker, F.R.S., 387; Dr. G. Johnstone Stoney, F.R.S., 432
- Mercury, Discovery on Puy-de-Dôme of Ruins of Temple to, 14
- Meslans (M.), the Gaseous Fluorides of the Simpler Organic Radicals, 540; Fluoroform prepared in its Pure State, 541
- Messner's (Herr), Experiments with Bullets Infected with Micro-organisms, 16
- Metal Work, Elementary, G. C. Leland, 554
- Metallurgy: the Transformation of Iron, E. Charpy, 192; Wrought Iron Making in Madras, 255.
- Metals, Experimental Investigations concerning Elastic Longitudinal and Torsional Fatigue in, Louis Austin, 239
- Meteorology: the Climate of Chicago, Prof. H. A. Hazen, 15; Operations of the German Meteorological Office for 1892, 35; Report of Royal Alfred Observatory, Mauritius, for 1891, 35; Halo Phenomena, Prof. Hellmann, 48, 130; Wave Clouds, Prof. von Bezold, 48; Various Modes of Discriminating between Clouds, Prof. von Bezold, 427; Cloud Conditions of Various Climates, Dr. H. Meyer, 216; the Motion of Clouds, M. Pomortseff, 230; Cloud-formation, Prof. W. von Bezold, 508; the Measurement of the Highest Cirrus Clouds, Prof. C. Abbe, 508; Diurnal Range of Amount of Cloud at Paris, M. Angot, 206; Berlin Meteorological Society, 48, 216, 427, 596; American Meteorological Journal, 71, 263, 329, 428; Pilot Chart of North Atlantic for first half October, 81; United States Pilot Chart of North Pacific Ocean, 347; the Week's Weather, 81, 150, 159, 252, 321, 369, 394, 438, 460; Deutsche Seewarte Record of Observations taken in North Atlantic, No. xi., 109; Deutsche Seewarte Extra-European Observations, 540; the Fort-William Diurnal Barometric Curve, 540; the Great Drought of 1893, F. J. Brodie, 119; Thunder and Hailstorms of July 8, 1893, W. Marriott, 119; Meteorological Society, 119, 215, 307, 425, 547; the Past Monsoon in India, 130; Symons's Monthly Meteorological

- Magazine, 139, 238, 449, 520; Symons's Summary of Persian Rainfall Observations, 139; New Form of Rainfall Map, H. C. Russell, 180; Rainfall of Jerusalem, J. Glaisher, F.R.S., 297; Meteorological Council's Summary of Rainfall and Mean Temperature, 1866-93, 369; Temperature, Rainfall, and Sunshine at Las Palmas, Grand Canary, Dr. J. C. Taylor, 425; Rainfall Records in British Isles, G. J. Symons, 438; Excessive Rainfall at Lesmahagon, C. M. Irvine, 440; Montevideo Rainfall Observations, 1833-92, Rev. L. Morandi, 539; Rainfall in Edinburgh, 520; Vallot's 1887 Mont Blanc Observations, Alfred Angot, 167; Meteorological Conditions of Hamburg and the Cholera Epidemic, Captain C. H. Seeman, 180; Harvard College Observatories in Peru, Prof. W. H. Pickering, 180; Forest Fires and Drought, E. Rayet and E. Clavel, 191; the Sonnblick Mountain Observatory, 205; Report of Meteorological Council for Year ending March 31, 1893, 206; the Great Storm of Nov. 16-20, 1893, C. Harding, 215; the Transport of Heat by Aerial Currents on Earth's Surface, Dr. Arendt, 216; Snow Crystals, Prof. Hellmann, 216; Report on the Present State of Our Knowledge respecting the General Circulation of the Atmosphere, L. Teisserenc de Bort, 217; on Hail, Hon. Kollo Russell, 217; Weather Lore, Richard Inwards, 217; the Misti (Peruvian Andes) Meteorological Station, Prof. S. J. Bailey, 229; Meteorological Work in Australia, Sir Charles Todd, 229; Climate of Mexico City, Señor M. Barcena, 229; March to October, 1893, M. Symons, 238; Diurnal Variation of Tension of Aqueous Vapour, Alfred Angot, 240; Diurnal Variation of Atmospheric Electricity, A. B. Chauveau, 240; New South Wales Government Report of Observations for 1892, H. C. Russell, 252; the Climate of Torquay, A. Chandler, 253; the Winds of the Indian Ocean, W. M. Davis, 263; South American Meteorology, W. H. Pickering, 263; a South American Tornado, W. G. Davis, 263; Errors of the Psychrometer, H. A. Hazen, 263; Death of W. von Freeden, 270; Glazed Frosts of November 11-12, 1893, in Roumania, 272; the January Frost, 449; the Moon and Weather, 275; the Great Gale of November 16-20, Charles Harding, 294; Unusual Rise of Water Characteristic of Atlantic Coast Storms, M. W. Harrington, 297; the Climate of Sulina, Dr. S. C. Hepites, 297; the Climatic and National Economic Influence of Forests, Dr. J. Nisbet, 302; the Climate of Southern California, Dr. C. Theodore Williams, 307; Contribution to Daily Range of Meteorological Elements in Higher Strata of Atmosphere, Dr. J. Hann, 321; a Lunar Rainbow, Rev. C. W. Langmore, 321; History of Weather Map, M. W. Harrington, 329; Early Individual Observers in United States, A. J. Henry, 329; Recurrence of Hurricanes in Solar Magnetic 26.68 Day Period, F. H. Bigelow, 330; Eclipse Meteorology, 349; Great Storm in United States, 369; Compensating Open-Scale Barometer, Mr. Griffiths, 379; Lowest Temperature hitherto known, 394; the Commencement and End of Winter, A. Lancaster, 394; Dr. Charles Davison's "Climates of United States," 396; the Sun-spot Period and the West Indian Rainfall, Maxwell Hall, 399; Meteorology, H. N. Dixon, 412; Observations during Nocturnal Balloon Ascents at Munich, Profs. Sohncke and Finsterwalder, 416; Thunderstorms, R. de C. Ward, 416; Aspects of Town as contrasted with Country Air, Dr. G. H. Bailey, 417; the Dynamics of the Atmosphere, M. Möller, 422; the Study of Thunderstorms in Italy, R. de C. Ward, 423; Climatic Features of Maryland, W. B. Clark, 423; Ten Miles above the Earth, H. A. Hazen, 423; Mercurial Barometers compared with Boiling-point Thermometers, Colonel H. Hartl, 424; Phenological Observations for 1893, E. Mawley, 426; Comparative Observations with Two Thermometer Screens at Ilfracombe, W. Marriott, 426; Number of Dust Particles in Atmosphere of Certain Places, John Aitken, 426; the Temperatures in and outside Berlin, Prof. G. Hellmann, 460; the Texan Monsoons, Prof. M. W. Harrington, 460; Tropical Hurricanes of South Sea, E. Knipping, 463; Solar Magnetic Influences on Meteorology, Prof. H. A. Hazen, 464; Application of Meteorology to the Art of War, J. R. Plumondon, 488; Bartram's Open-Scale Barometer, J. J. Hicks, 488; Meteorologische Zeitschrift, 498; Results of the Swedish International Polar Expedition at Cape Thorsden, Spitzbergen, 1882-83, Dr. J. Hann, 498; Mild Winter Weather, 520; Six- and Seven-Day Weather Periods, H. Helm Clayton, 520; New High Temperature Thermometer, Messrs. Baly and Chorley, 538; Brilliant Aurora Borealis of March 30, 1894, Hon. Kollo Russell, C. E. Stromeyer, and Mr. Preece, 539; Dust and Meteorological Phenomena, John Aitken, F.R.S., 544; Relation between Mean Quarterly Temperature and Death Rate, W. H. Dines, 547; Remarkable Sudden Changes of Barometer in Hebrides on February 23, 1894, R. H. Scott, F.R.S., 547; the Typhoons of 1892, Rev. S. Chevalier, 560; the Royal Meteorological Society's Exhibition, Wm. Marriott, 579; the Diurnal Range in Velocity and Direction of the Wind on the Eiffel Tower, Prof. Sprung, 596; Further Observations of the Temperature and Humidity in Woods and in the Open, Dr. Schubert, 596; a Fine Aurora Australis, Hon. H. C. Russell, F.R.S., 601; Luke Howard and Cloud Nomenclature, 607; some Phenomena of the Upper Air, Richard Inwards, 619; on Mountain Observatories in Connection with Cyclones, M. Faye, 620
- Meteors: the Perseids observed in Russia in 1892, M. Bredikhin, 23; Meteor Showers during November, 39; Biela Meteors, 67; Shower of Leonid Meteors (November 17, 1893), 81; a Bright Meteor, Prof. Schur, 111; Meteor seen at Lesmahagon, N.B., C. M. Irvine, 129; Meteor Shower for December, 134; the Large Fireball of January 25, 324; a Brilliant Meteor, Dr. M. F. O'Reilly, 341; Brilliant Day-Light Meteor seen near Worcester, Lloyd Bosward, 368; Meteors of Night of November 6-7, 1893, F. Folie, 377; a Bright Meteor, 419; Fireballs, W. F. Denning, 434; Prof. Arthur Rambaut on the Great Meteor of February 8, 572; a Remarkable Meteor, Hon. R. Russell, 601
- Meteorites: on a Meteorite from Gilgoon Station, H. C. Russell, F.R.S., 325; on a Meteorite which fell near Jafferabad in India, on April 28, 1893, Prof. John W. Judd, F.R.S., 32
- Meteorite, a Tempered Steel, 372
- Metrical System adopted by United States, 393
- Metrology, Light Waves and their Application to, Prof. A. A. Michelson, 56
- Mettam (Prof. A. E.), the Os Pedis in Ungulates, 341
- Meunier (Stanislas), Relationship between Platinum and its Mother-Rock, 404
- Meyer (Dr. A. B.), Iron-framed Museum Cases, 13
- Meyer (G.), Method of Photographing Spectrum of Lightning, 417
- Meyer (Dr. H.), Cloud-Conditions of Various Climates, 216
- Meyer (Prof. Lothar), Lecture Demonstration of Electrolysis of Hydrochloric Acid, 584
- Meyer (Prof. Victor), Researches on Melting-points of Refractory Inorganic Salts, 110; Iodine as a Base-forming Element, 442; the New Iodine Bases, 467
- Michael (A. D.), Our Knowledge of the Acari, 530; Notes on the Uropodinae, 594
- Michaelis (Prof.), New Boron Compounds, 371
- Michelet (Prof. K. L.), Death of, 251
- Michelson (Prof. A. A.), Light-Waves and their Application to Metrology, 56
- Micro-Organisms and Fermentation, Alfred Jørgensen, Dr. A. A. Kanthack, 527; Frank E. Lott, 577
- Microscopy: Royal Microscopical Society, 47, 119, 263, 330, 594; a Parasitic Disease in Flounders, G. Sandeman, 119; Comparative Anatomy of Sponges, V., *Calcarea heterocala*, Dr. Arthur Dendy, 139; Points in Origin of Reproductive Elements in Apus and Branchipus, J. E. S. Moore, 139; Quarterly Journal of Microscopical Science, 139, 423; International Journal of Microscopy and Natural Science, 255; Method for Making Permanent Preparations of Particular Colonies on Gelatine Plate, Herr Hauser, 274; Our Knowledge of the Acari, A. D. Michael, 330; *Epigonichthys cultellus*, Arthur Willey, 423; *Octineon Lindahli*, Dr. G. H. Fowler, 423; Swift's New Biological Microscopes, 523; Notes on the Uropodinae, A. D. Michael, 594
- Mild Winter Weather, 520
- Milky Way, the, C. Easton, 99
- Milky Way, Photographic Nebulosities in the, Prof. E. E. Barnard, 511
- Mill (Dr. H. R.), Bathymetrical Survey of Haweswater, 540
- Miller (A. F.), Spectroscopic Examination of Light emitted by *Photinus corruscus* Beetle, 540

- Miller, Bedell, and Wagner, (Messrs.), New Form of Contact Maker, 37
- Millport, N.B., Projected Marine Biological Station at, 180
- Milne (Prof. John, F.R.S.), Earth Movements, 301
- Mimicry of Hemiptera by Lepidoptera, G. A. G. Rothney, 619
- Mimicry in Mollusca, A. H. Cooke, 426
- Mimicry by Spider, 207
- Minchin (E. A.), Foam Theory of Protoplasm, 31
- Minchin (Prof. Geo. M.), Electromotive Force from the Light of the Stars, 269; Action of Electromagnetic Radiation on Films containing Metallic Powders, 142; Calculation of Coefficients of Self-Induction of Circular Currents of Given Aperture and Cross-Action, 190; Magnetic Field of Current running in Cylindrical Coil, 190
- Mind Problem, the Status of the, Lester Ward, 510
- Mineralogy: the Iron Ores of Great Britain and Ireland, J. D. Kendall, Bennett H. Brough, 27; on a Meteorite which fell near Jafferabad in India on April 28, 1893, Prof. John W. Judd, F.R.S., 32; on a Method of Separating the Mineral Components of a Rock, Prof. W. J. Sollas, F.R.S., 211; (1) the Structures of Native Gold, (2) the Chemical Composition of Alloys, Prof. Behrens, 144; Chemical Composition of Staurolite, G. L. Penfield and J. H. Pratt, 402; Relationship between Platinum and its Mother-Rock, Stanislas Meunier, 404; the Origin of Gold Nuggets, Prof. A. Liveridge, 415; Death of Dr. F. Ulrich, 538
- Minerals, German Superstitions about, F. Klinkhardt, 230
- Minguin (M.), Two Isomeric Methylcyanocamphors, 548
- Mira Ceti, 349, 442
- Mirrors, Magic, a New Mode of Making, J. W. Kearton, 354
- Mississippi Valley, the Spermophiles of the, Vernon Bailey, 36; the Unio Fauna of the, C. T. Simpson, 64
- Misti (Peruvian Andes) Meteorological Station, the, Prof. S. J. Bailey, 229
- Mitchell (P. Chalmers), the Spencer-Weismann Controversy, 373
- Miyoshi (Dr. M.), the Edible Lichen of Japan, 253
- Modigliani (Elio), "Fra i Batacchi indipendenti," 314
- Modigliani's (Dr.) Sumatra and Engano Ethnographical Collections, Prof. Giglioli, 107
- Moissan (M.), the Artificial Preparation of the Diamond, 418
- Moissan (Henri), Crystallised Calcium Carbide prepared by means of Electric Furnace, 475; Determination of Specific Gravity of Melted Magnesia, 475; Preparation and Properties of Boron Carbide, 500; Study of Crystallised Acetylides of Barium and Strontium, 548
- Mollusca: The Tunicate, 179; the Dispersal of Shells, Harry Wallis Kew, Clement Reid, 361; Mimicry in Mollusca, A. H. Cooke, 426
- Möller (M.), the Dynamics of the Atmosphere, 422
- Möller (Herr), the Effect of Wave-length in dealing with Refraction Index in elucidation of Chemical Constitution, 582
- Monckton (H. W.), Picrite and other associated Rocks at Barnston, N.B., 191; a Variety of Whitby Ammonite, 191
- Moncrieff (Dr. D. S.), Death of, 163
- Monkey, Experimental Investigation of the Central Nervous System of the, Dr. E. L. Mellus, 498
- Mont Blanc Meteorological Observations, 1887, Vallot's, Alfred Angot, 167
- Montevideo Rainfall Observations, 1883-92, Rev. L. Morandi, 539
- Monte Iseran, Henri Ferrand, 134
- Monte Somma, Eozoonal Structure of the Ejected Blocks of, Dr. J. W. Gregory and Prof. H. J. Johnston-Lavis, 499
- Montenegro, W. H. Cozens-Hardy's Journey through, 461
- Montreal, Earthquake at, 106
- Moon Pictures, 39
- Moon, the, and Weather, 275
- Moore (F.), Improved Arrangement for "turning down" Electric Light, 108
- Moore (J. E. S.), Points in Origin of Reproductive Elements in Apus and Branchipus, 139
- Moore (Spencer), Phanerogamic Botany of Matto Grosso Expedition, 95
- Moore (Mr.), Velocity of Crystallisation in Super-cooled Substance, 130
- Morandi (Rev. L.), Montevideo Rainfall Observations, 1883-92, 539
- Morbology: the Etiology of Delirium Acutum, Dr. Rasori, 208; Epidemic Influenza, Hon. R. Russell, 210; the Influenza Epidemic in Germany, 1889-90, 569; Cholera, Dr. E. Klein, F.R.S., 492
- Moreau (G.), Magnetic Rotary Dispersion of Carbon Bisulphide in Infra-Red part of Spectrum, 370
- Morgan (Prof. C. Lloyd), Protective Habit in a Spider, 102; the Scope of Psycho-Physiology, 504
- Morley (Frank), a Treatise on the Theory of Functions, 477
- Moscou, Bulletin de la Societé des Naturalistes de, 189
- Mosses, British, Illustrated Guide to, H. G. Jameson, 479
- Mostyn (C.), Rudimentary (Vestigial) Organs, 247
- Moth, the Sugar-Cane, A. S. Oliff, 64
- Moth, Gipsy, Plague in Massachusetts, the, 231
- Moths of Teneriffe, the Butterflies and, A. E. Holt White, W. F. Kirby, 384
- Motion of Bubbles in Tubes, on the, 351
- Mountain Observatories in connection with Cyclones, M. Faye on, 620
- Mount Kenia, Dr. J. W. Gregory's Journey to, 276, 443
- Mourlot (A.), Analysis of a Vanadiferous Oil, 24
- Mühlhäuser's (Dr.) Process, Carbide of Silicon as Manufactured by, 17
- Muir (M. M. Pattison), the Chemistry of Fire, 3; Essays in Historical Chemistry, T. E. Thorpe, F.R.S., 551
- Mukhopadhyay (A.), an Elementary Treatise on the Geometry of Conics, 75
- Muller's (George) Last Exploration in Madagascar, 111
- Muller (Dr. Karl), the Silk Spider of Madagascar, 253
- Muller (P. T.), Molecular Weight of Ferric Oxide, 524
- Mummy, the, E. A. Wallis-Budge, F.S.A., 97
- Munich, Nocturnal Balloon Ascents at, 416
- Munk (Prof.), Tactile Areas of Cerebral Cortex, 380; Prof. Golz's Research on a Dog which survived for a long time Extirpation of the Cerebrum, 596
- Munro (Dr. R.), the Polado Flint-Saws, 183
- Muntz (A.), a Chemical Study of Green Colouration in Oysters, 263
- Murdoch (G. W.), Astronomy in Poetry, 434
- Murdochs (G. W.), Are Birds on the Wing killed by Lightning, 601
- Murphy (Shirley F.), a Treatise on Hygiene and Public Health, 285
- Murray (Dr. John), Columbus' First Voyage in Relation to Development of Oceanography, 39; Antarctic Exploration, 112; the Floor of the Ocean at Great Depths, 426
- Murray (T. S.), Preparation of  $\alpha$ - $\beta$ -diphenylindoles from Benzoin and Primary Benzenoid Amines, 118
- Muscle, Music, Rhythm and, Prof. T. Clifford Allbutt, 340
- Museum, the Arbuthnot, Peterhead, Alexander, Meek, 20
- Museum Cases, Iron-framed, Dr. A. B. Meyer, 13
- Museum at Chicago, Projected, 64
- Museum, Proposed Epping Forest Local, 393
- Museum, Notes from the Leyden, 161
- Museum at Pretoria, establishment of State, 12
- Music, Muscular Action the Origin of, Dr. S. Wilks, F.R.S., 271
- Music, Rhythm, and Muscle, Prof. T. Clifford Allbutt, 340
- Mycology: British Fungus Flora: a Classified Text-book of Mycology, George Masee, Dr. M. C. Cooke, 195
- Nagaoka (H.), the Hysteresis attending change in Length produced by Magnetisation in Nickel and Iron, 229
- Nivalites, the Genus, occurring in Nova Scotia Coal Formation, Sir J. W. Dawson, F.R.S., and Dr. Wheelton Hind, 475
- Nairne (Rev. A. K.), the Flowering Plants of Western India, 501
- Nansen (Dr. Fridtjof), Eskimo Life, 98
- Nansen's (Dr.) Expedition, 85, 112, 210; Hans Johannsen, 85; and the Kara Sea, 39
- Naples Zoological Station, the, 604
- Natal Observatory, 85th Report of, 562
- Natality, an Estimate of the Degree of Legitimate Natality as shown in the Table compiled from Observations made at Budapest, Joseph Korösi, 570
- Natality Table of Korösi, Results derived from, Francis Galton, F.R.S., 570
- Nativity of Rama, the, Colonel Walter R. Old, 4

- Natural History : Natural History of East Equatorial Africa, Dr. J. W. Gregory, 12 ; With the Woodlanders and by the Tide, 51 ; Recognition Marks, G. J. Macgillivray, Dr. Alfred R. Wallace, F.R.S., 53 ; Death of Dr. George Bennett, 63 ; the Postal Transmission of Natural History Specimens, Isaac J. Wistar, Edward J. Nolan, 100 ; R. McLachlan, F.R.S., 172 ; Philip P. Calvert, 314 ; Bulletin de la Société des Naturalistes de Moscou, 189 ; the Royal Natural History, Richard Lydekker, 220 ; Death of Dr. George Gordon, 251 ; Shakespeare's Natural History, Phil Robinson, 444 ; Rugby School Natural History Society, 541
- Natural Science : Death of William Dinning, 81
- Nature Lovers, a Correspondence, Geo. D. Leslie, 10
- Nature Pictures for Little People, W. Mawer, 529
- Naval Architects, the Institution of, 490
- Naval Architecture : the Manœuvring Powers of Steamships and their Practical Applications, Vice-Admiral P. H. Colomb, R.N., 174 ; Marine Boiler Management and Construction, C. E. Stromeier, 410
- Naval Observatory, U.S., Captain F. McNair, 324
- Navigation : Effect of Reversing Screw of Steamship on Steering, Captain Bain, 208
- Navigation by Semi-Azimuths, Ernest Wentworth Buller, 223
- Navigator, Prince Henry the, 443
- Nawaschin (S.), the Embryonal Development of the Birch, 23
- Nebulæ, New, 464
- Nebular Lines, the Wave-Lengths of the, Prof. Keeler, 18
- Nebulosities in the Milky Way, Photographic, Prof. E. E. Barnard, 511
- Neesen (Prof.), Method of Coating Aluminium with other Metals, 216
- Neolithic Age in Nicaragua, Evidence of Existence of Man in, J. Crawford, 107
- Neolithic Discoveries in Belgium, 227
- Neptune, the Satellite of, Prof. Struve, 324 ; M. Tisserand, 543
- Nerve Centres, the Minute Structure of the, Prof. Ramon y Cajal, 464
- Netherlands Entomological Society, 332
- Netherlands Zoological Society, 24, 264
- Neville (F. H.), Freezing-points of Alloys in which the Solvent is Thallium, 239 ; Freezing-points of Triple Alloys, 306
- New South Wales : Government Report of Meteorological Observations for 1892, H. C. Russell, 252
- New South Wales Linnean Society, 119, 168, 264
- New York Mathematical Society, Bulletin of, 71, 188, 330, 402, 497, 570
- New York State, the Finger Lakes in, R. S. Tarr, 606
- New Zealand, Beetles of, W. F. Kirby, 459
- Newall (H. F.), Combination of Prisms for a Stellar Spectroscope, 379
- Newberry (P. E.), Beni Hasan, 169, 432
- Newcomb (Prof. Simon, F.R.S.), Suggested Nomenclature of Radiant Energy, 100 ; Modern Mathematical Thought, 325
- Newhall (Charles S.), the Shrubs of North-Eastern America, 28
- Newman (Mr.), Micro Organisms in Ice, 322
- Newth (G. S.), Flame, 171 ; a Lecture Experiment, 293
- Newton (Prof. Alfred, F.R.S.), Great Auk's Egg, 412, 456
- Newton (E. T., F.R.S.), Two New Reptile Genera from Elgin Sandstone, 189 ; the Vertebrate Fauna collected by Mr. W. J. L. Abbott from Fissure near Ightham, 355
- Niagara, the Falls of, and its Water-Power, 482
- Niagara District, Inferred Rate of Terrestrial Deformation in the, 520
- Nicaragua, Evidences of Existence of Man in Neolithic Age in, J. Crawford, 107
- Nichols (Prof. E. L.), Phenomena of the Time-Infinitesimal, 113
- Nineteenth Century, a Popular History of Astronomy during the, Agnes M. Clerke, 2
- Nisbet (J.), British Forest Trees, 1 ; the Climatic and National Economic Influence of Forests, 302
- Nitrogen, Recent Investigations and Ideas on the Fixation of, by Plants, Prof. H. Marshall Ward, F.R.S., 511
- Nogués (A. C.), Fractions of Coal-Measures of Southern Chili, 47 ; Glacial and Erratic Phenomena in Cachapoal Valley, Chili, 72 ; Eruption of El Calbuco Volcano (Andes), 179
- Nolan (Edw. J.), the Postal Transmission of Natural History Specimens, 100
- Nomenclature of Radiant Energy, on the, Prof. Simon Newcomb, F.R.S., 100 ; Prof. G. F. Fitzgerald, F.R.S., 149 ; Prof. A. N. Pearson, 389
- Nomenclature, Systematic, Prof. G. F. Fitzgerald, F.R.S., 148 ; Fred. T. Trouton, 148
- Noorden (Dr. von), the Action of Quinine on Metabolism of Man, 427
- Norma, the New Star in, 85
- Normæ, the Spectrum of Nova, 162, 397
- North America, the Rise of the Mammalia in, Prof. H. F. Osborn, 235, 257
- North America, the Currents in the Great Lakes of, Prof. Mark W. Harrington, 592
- North-East Wind, the, S. H. Burbury, F.R.S., 481
- North-East Wind, the.—Devonian Schists, Prof. T. G. Bonney, F.R.S., 577
- North Sea, Geographical Evolution of the, A. J. Jukes-Browne, 32
- Norway, Bird Life in Arctic, Robert Collet, 599
- Norwegian Sealers in Antarctic Waters, 461
- Notation, New, for Lines in Spectrum of Hydrogen, 162
- Notes from the Leyden Museum, 161
- Nottingham Museum, Botanical Collection presented by Mr. H. Fisher to, 271
- Nourrisson (C.), Minimum Electromotive Force necessary for Electrolysis of Dissolved Alkaline Salts, 331
- Nova Aurigæ, 373 ; Prof. E. S. Holden, 32
- Nova Normæ, the Spectrum of, 162, 397 ; Prof. W. W. Campbell, 586
- Novitates Zoologicae, 396
- Nuovo Giornale Botanico Italiano, 424, 594
- Object-Glass, a New Achromatic, 464
- Obrecht (Dr.), Diurnal Ground-Movements at Santiago, 130
- Obrucheff's (W. A.) Journey in Ordos Region, 233
- Obrucheff (Mr.), the Plateau of Shan-si, 230
- Observatories : the *Observatory* for November, 67 ; the Natal Observatory, 85, 562 ; Solar Observations at Rome, 163 ; the Vatican Observatory, R. A. Gregory, 341 ; the Companion to the *Observatory*, 163 ; Harvard College Observatory Report, 256 ; Report of the Wolsingham Observatory, 300 ; U.S. Naval Observatories, Captain F. McNair, 324 ; Madras Observatory, 511 ; Harvard College Meteorological Observatories in Peru, Prof. W. H. Pickering, 180 ; the Sonnblick Mountain Observatory, 204 ; M. Faye on Mountain Observatories in Connection with Cyclones, 620
- Occlusion of Spica, 464
- Ocean at Great Depths, the Floor of the, Dr. John Murray, 426
- Oceanic Currents, Experiments with Floats on, 301
- Oettel's (Dr.) Researches on Phenomena of Electrolytic Deposition of Metals, 16
- Ohio Basin, Upper, Further Studies of the Drainage Features of the, T. C. Chamberlin and Frank Leverett, 617
- Oil in Calming Troubled Waters, Best Method of Using, Dr. M. M. Richter, 488
- Old (Colonel Walter R.), the Nativity of Rama, 4
- Oldenburg (Henry), First Secretary of Royal Society, Herbert Rix, 9
- Oldham (R. D.), Rock Basins in the Himalayas, 77 ; Evolution of Geography of India, 163 ; the Origin of Lake Basins, 197 ; the Origin of Rock Basins, 292
- Ophthalmology : Radius of Curvature of Cornea, Drs. Chapman and Brubaker, 229
- Optics : Optical Properties of Quartz Plate compressed Perpendicularly to Axis, F. Beaulard, 37 ; Vision of Opaque Objects by means of Diffracted Lights, M. Gouy, 72 ; some Phenomena of Diffraction, W. B. Croft, 354 ; Numerical Verifications relating to Focal Properties of Plane Diffraction Gratings, A. Cornu, 239 ; the Use of Collodion Films coloured with Fuchsin in Measurement of Light-Absorption, Salvador Bloch, 108 ; Differential Method of determining Refractive Index of Solutions, W. Hallwachs, 206 ; Change of Intensity of Light Polarised Parallel to Plane of Incidence by Reflection on Glass, Paul Glan, 239 ; a New Mode of making Magic Mirrors, J. W. Kearton, 354 ; New Photometric Method, J. B. Spurge, 355 ; the Unit of Light, Dr. Lummer, 356 ; Magnetic Rotary Dispersion of Carbon Bisulphide in Infra-Red Part of Spectrum, G. Moreau, 370 ; Instrument of Precision for producing Monochromatic Light



- of any desired Wave-Length, A. E. Tatton, 377; the Effect of Wave-Length in dealing with Refractive Index in elucidation of Chemical Constitution, MM. Jahn and Möller, 582; Vision with Compound Eyes, Dr. G. J. Stoney, 379; Miss C. L. Franklin's New Theory of Light-Sensation, 394; Relation between Epilepsy and Errors of Refraction in Eye, H. W. Dodd, 395; the Systematic Aplanatic Objective, C. V. Zenger, 426; the Kathodic Light, Prof. Goldstein, 427; Luminosity of Candle calculable from Dimensions of Flame, P. Glan, 460; Insect Sight and Defining Power of Composite Eyes, A. Mallock, 472; Elliptic Polarisation of Reflected Light, K. E. F. Schmidt, 547; Normal and Anomalous Changes of Phase during Reflection of Light by Metals, W. Wernicke, 547; Colour Vision, the Board of Trade and the Railway Companies, 558; Kirchhoff's Law connecting Absorptive and Emissive Powers of Substances tested for Glass by G. B. Rizzo, 606
- Orchid Seekers, the, Ashmore Russan and Frederick Boyle, 28
- Orchids, W. A. Styles, 352
- Orchids, Extra-Tropical, Henry Bolus, R. A. Rolfe, 50
- Ordos Region, W. A. Obracheff's Journey in, 233
- O'Reilly (Dr. M. F.), a Brilliant Meteor, 341
- Organic Chemistry, Dictionary of the Active Principles of Plants, C. E. Sohn, 385
- Orientation, on the Cardinal Points of the Tusayan Villagers, J. Walter Fewkes, 388
- Origin of Lake Basins, the, R. D. Oldham, 197; Dr. Alfred R. Wallace, F.R.S., 197; John Aitken, F.R.S., 315; R. S. Tarr, 315; Dr. A. M. Hanson, 364; T. D. La Touche, 365; Alfred C. R. Selwyn, F.R.S., 412
- Origin of Rock Basins, the, R. D. Oldham, 292
- Ormerod (Miss E. A.), Insects' Attacks on Crops and Trees, 253; Report of Observations of Injurious Insects and Common Farm Pests during the Year 1893, 480
- Orndorff (M.), Polymeric Modifications of Acetic Aldehyde, 396
- Ornithology: an Ornithological Retrospect, Dr. R. Bowdler Sharpe, 6; Frank E. Beddard, F.R.S., 31; the Apteryx Genus, Hon. Walter Rothschild, 14; the New Bird Protection Bill, 54; Death of Dr. A. K. E. Baldamus, 81; Threatened Extinction of the Great Skua, W. E. Clarke, 253; the Great Auk's Egg, 432; Prof. Alfred Newton, F.R.S., 412, 456; Great Auk's Egg sold for 300 Guineas, 415; the Ptarmigan of Aleutian Islands, W. B. Evermann, 584; Bird Life in Arctic Norway, Robert Collet, 599; Are Birds on the Wing killed by Lightning? Skelfo, 577; G. W. Murdoch, 601; the Continuous Flight of Frigate-Birds, J. Lancaster, 605
- Os Pedis in Ungulates, the, Prof. A. E. Mettam, 341
- Osborn (Prof. H. F.), the Rise of the Mammalia in North America, 235, 257
- Osmond (F.), Alloys of Iron and Nickel, 476
- Ossiferous Contents, the Har Dalam Cavern and its, 514
- Osteology: Zur Kenntniss der Postembryonalen Schadelmetamorphosen bei Wiederkauern, H. G. Stehlin, 99
- Ostwald (W.), Hand- und Hilfsbuch zur Ausführung physikochemischer Messungen, J. W. Rodger, 219
- Oudemans (Prof. J. A. C.), Accuracy of Divisions of Altazimuths of Pistor and Martin and of Repsold, 192
- Out-door World, or Young Collector's Handbook, W. Furneaux, 52
- Oxford, Human and Comparative Anatomy at, Prof. J. Burdon Sanderson, F.R.S., 6; Prof. E. Ray Lankester, F.R.S., 29
- Oxygen in Asphyxia, the Physiological Action of, 16
- Oxygen, Magnetic Susceptibility of, R. Hennig, 108
- Oxygen in the Sun, the Presence of, Dr. Janssen, 585
- Ozone, Influenza and Fever, 180
- Pacific, North, Ocean, United States Pilot Chart of, 347
- Painter's Colours, Oils, and Varnishes, a Practical Manual, Geo. H. Hurst, 194
- Palaeolithics: the Forgery of Palaeolithic, &c., Implements, Sir John Evans, 156; the Polado Flint Saws, Dr. R. Munro, 183
- Palaeontology: Dr. von Zittel's Handbook of, 64; Mammoth Remains in Canada and Alaska, Dr. G. M. Dawson, F.R.S., Sir Henry Howorth, 94; a Nothosaurian Reptile from the Trias of Lombardy, Mr. Boulenger, 95; Congenerousness of *Pteranodon*, Marsh, with *Ornithostoma*, Seeley, Prof. Williston, 109; the Diprotolon and its Times, C. W. de Vis, 159; Two New Reptile Genera from Elgin Sandstone, E. T. Newton, F.R.S., 189; the Thoracic Legs of *Triarthrus*, C. E. Beecher, 214; a Thylacine of Earlier Nototherian Period in Queensland, C. W. de Vis, 264; Complete *Plesiosaurus* found in Württemberg, 271; the Alleged Antepre-mordial Fauna of Bohemia, Dr. Jahn, 297; the *Therapsuchia*, H. G. Seeley, F.R.S., 450; *Diademodon*, H. G. Seeley, F.R.S., 450; the Har Dalam Cavern and its Ossiferous Contents, 514
- Palazzo (Dr. L.), Sun-spots and Magnetic Disturbances, 397
- Pamirs, M. de Poncins' Explorations in the, 18
- Pamirs crossed by E. Poncins, 163
- Panmixia, George J. Romanes, F.R.S., 599
- Parallelepiped into Tetrahedra, Prof. Crum Brown on the Division of a, 571
- Parasitic Theory of the Causation of Malignant Tumours, J. Jackson Clarke, 502
- Parenty (H.), Forms of Steam Jets from various Orifices, 347
- Paris: Academy of Sciences, 23, 47, 71, 96, 119, 143, 167, 191, 215, 239, 263, 283, 308, 331, 355, 379, 404, 426, 452, 475, 500, 524, 548, 572, 595, 620; Prize Awards, 215, 233; Prize Subjects of the Paris Academy of Sciences, 234; Mémoires de la Société d'Anthropologie de Paris, 283; Bulletins de la Société d'Anthropologie de Paris, 306, 330; Pasteur Institute, Statistics for November, 322; Streets named after Men of Science, 558; Paris Geographical Society Awards, 559
- Parsons (F. G.), Myology of the Hystricomorphine and Sciuro-morphine Rodents, 523
- Paschen (F.), Spectra of Hot Gases probably due to Temperature, 82
- Passarge (Dr.), the German Expedition to Delimit Hinterland of Cameroons, 68
- Pasteur Institute for India, Proposed, 13, 180
- Pasteur Institute, the Proposed Indian, and the Anti-Vivisectionists, 130
- Pasteur Institutes to be established in Turkey, 437
- Pasteur Institute Statistics for November, 322
- Pasteur Institute, Report for 1893 of, Henri Poitevin, 581
- Pastukoff's (A. V.), Ascent of the Elbrus, 515
- Pathology: the Projected Pathological Laboratory at Claybury, 129; Death of Dr. E. H. Jacob, 485; the C. C. Walker Prize for Investigation of Cancer, 505; Tetanus-Poison, Drs. Fermi and Pernossi, 540
- Paton (Dr. Noel), Hepatic Glycogenesis, 141
- Patten (Lieut. J.), Novel Method of obtaining Sinusoidal Alternating Currents of very Low Frequency, 253
- Pavement, Asphalte, Petroleum in relation to, S. P. Peckham, 306
- Pearson (Prof. A. N.), the Nomenclature of Radiant Energy, 389
- Pearson (Prof. Karl), Asymmetrical Frequency Curves, 6
- Peckham (S. P.), Petroleum in relation to Asphalte Pavement, 306
- Peddie (Dr. W.), Torsional Oscillations of Wires, 331
- Pedipalpi, Morphology of, Malcolm Laurie, 378
- Pellat (M.), the Point of Application of Electro-Magnetic Forces, 488; Point of Application of Mechanical Force experienced by Conductor conveying Current in Magnetic Field, 590
- Pendlebury (W. H.), the Interaction of Hydrogen Chloride and Potassium Chloride, 118
- Penfield (S. L.), Chemical Composition of Staurolite, 402
- Pengelly (W., F.R.S.), Death of, 486; Obituary Notice of, Prof. W. Boyd Dawkins, F.R.S., 536; Pengelly (William), J. Starkie Gardner, 554; W. Pengelly, F.R.S., and the Age of the Bovey Lignite, A. R. Hunt, 600
- Perkin (W. H.), Magnetic Rotation of Hydrogen and Sodium Chlorides and Chlorine in different Solvents, 239
- Pernossi (Signor), the Action of Sunshine upon Tetanus Filtrates, 509; Tetanus Poison, 540
- Perry (Prof.), Planimeters, 617
- Persians, a Year amongst the, Edward G. Browne, 528
- Peru, Harvard College Meteorological Observatories in, Prof. W. H. Pickering, 180
- Peshawur, Earthquake at, 106
- Peterhead, the Arbuthnot Museum, Alexander Meek, 20
- Petermann's Mitteilungen, 324

- Petroleum in relation to Asphalte Pavement, S. P. Peckham, 306
- Petroleum on the Mendip Hills, Discovery of, 346
- Pfeffer (Prof.), Irritability of Plants, 586
- Pharmaco-Therapeutics, Chemistry in Relation to, and Materia Medica, Prof. B. J. Stokvis, 587
- Philip's Systematic Atlas, Physical and Political, E. G. Ravenstein, 574
- Philipp (R.), the Suspension of Foreign Bodies from Spiders' Webs, 481
- Philology: Death of Prof. Robertson Smith, 538; Catalogue of Prince Louis Lucien Buonaparte's Library, Victor Collins, 584
- Philosophical Society, Cambridge, 143, 166, 378, 424, 452
- Phisalix (C.), Poisonous Principles of Adder's Blood, 284; Viper Poison, 380
- Phosphorus, New Method of Preparing, Messrs. Rossel and Frank, 323
- Photinus corruscus* Beetle, Spectroscopic Examination of Light emitted by, A. P. Miller, 540
- Photography: Photographs of Ascending Currents in Gases and Liquids, Herr P. Czermak's, 15; Chrono-Photographic Study of the Locomotion of Animals, 41; Photography of Aerial Vibrations, Dr. Raps, 48; Astronomical Photography, H. C. Russell, F.R.S., 111; Photography of Snowflakes, A. Sigson, 131; Photography of Rays of very short Wavelength, Victor Schumann, 254; Cloud Photography, 267; Geological Photographs, 347; Method of Photographing Spectrum of Lightning, G. Meyer, 417; Photographic Nebulosity in the Milky Way, Prof. E. E. Barnard, 511; the Solandi Sun-printing Process as applied to Botanical Technique, Prof. Byron Halsted, 370; Effect of Temperature upon Sensitiveness of Photographic Dry Plate, Dr. J. Joly, F.R.S., 379
- Photometric Method, New, J. B. Spurge, 355
- Physics; Artificial Amoebæ and Protoplasm, Dr. G. Quincke, 5; Herr P. Czermak's Photographs of Ascending Currents in Gases and Liquids, 15; Wiedemann's Annalen, 46, 117, 239, 376, 449, 547; Air Vibrations, A. Raps, 46; Application of Sound-Vibrations to Analysis of Mixtures of Gases, E. Hardy, 47; Physical Society, 46, 93, 141, 190, 354, 402, 450, 521, 617; Behaviour of Air-Cone Transformer when Frequency below certain Critical Values, E. C. Rimington, 46; Lecture-room Experiments on (1) Rings and Brushes in Crystals, and (2) Electric Radiation in Copper Filings, W. B. Croft, 47; Photography of Aerial Vibrations, Dr. Raps, 48; Berlin Physical Society, 48, 167, 216, 356, 427, 595; Spectra of Hot Gases probably due to Temperature, 82; Herr Galitzini's Experiments in Estimation of Critical Temperature, 83; "Flame," Prof. Arthur Smithells, 86, 149, 198; Prof. Henry E. Armstrong, F.R.S., 100, 171; G. S. Newth, 171; Separation of Three Liquids by Fractional Distillation, Prof. F. R. Barrell, G. L. Thomas, and Prof. Sydney Young, F.R.S., 93; Van der Waal's Generalisations regarding "corresponding" Temperatures, &c., Prof. Sydney Young, F.R.S., 93; Phenomena of the Time-Infinitesimal, Prof. E. L. Nichols, 113; Elementary Course of Practical Science, Hugh Gordon, Sir Phillip Magnus, 121; Velocity of Crystallisation in Super-cooled Substance, Mr. Moore, 130; the Freezing-points of Dilute Aqueous Solutions, Harry C. Jones, 132; a more Exact Method for Determination of Lowering of Freezing-points, E. H. Loomis, 547; Magnetic Shielding of Concentric Spherical Shells, Prof. A. W. Rücker, F.R.S., 141; Action of Electro-Magnetic Radiation on Films containing Metallic Powders, Prof. G. M. Minchin, 142; Ripples, E. Guyon, 143; Mutual Action of Bodies vibrating in Fluid Media, MM. Berson and Juppont, 143; Righi's Experiments on Hertz's Oscillations, Dr. Rubens, 167; a Text-Book of Heat, R. Wallace Stewart, 171; Heat: an Elementary Text-Book, R. T. Glazebrook, F.R.S., 386; the Theory of Heat, Thomas Preston, Prof. G. C. Carey Foster, F.R.S., 573; Mr. M. C. Lea's Researches on Transformation of Mechanical Work into Chemical Action, 181; Utility of Quaternions in Physics, A. McAulay, Prof. P. G. Tait, 193; Differential Method of determining Refractive Index of Solutions, W. Hallwachs, 206; Method of Coating Aluminium with other Metals, Prof. Neesen, 216; Physico-Chemical Measurements, W. Ostwald, J. W. Rodger, 219; Proposed Standard of Normal Air, A. Leduc, 272; Stas's Determination of Atomic Weights, E. Vogel, 283; on the Change of Superficial Tension of Solid-liquid Surfaces with Temperature, Prof. Geo. Fras. Fitzgerald, F.R.S., 293; on the Equilibrium of Vapour Pressure inside Foam, Prof. G. F. Fitzgerald, F.R.S., 316; Torsional Oscillations of Wires, Dr. W. Peddie, 331; the Compression of Fluids, Prof. Tait, 331; the Cloudy Condensation of Steam, John Aitken, F.R.S., 340; Dr. Carl Barus, 363; Shelford Bidwell, 388, 413; Forms of Steam Jets from various Orifices, H. Parenty, 347; on the Motion of Bubbles in Tubes, 351; Thermal Constants of some Polyatomic Bases, MM. Colson and Darzens, 356; Radiation of Gases, F. Paschen, 376; the Artificial Colouring of Crystals and Amorphous Bodies, O. Lehmann, 376; Condition of Interior of Earth, Rev. O. Fisher, 379; some Simple Methods in Teaching Elementary Physics, Dr. J. Joly, F.R.S., 379; Experiments in Elementary Physics, W. Rheam, 433; Viscosity of Liquids, O. G. Jones, 402; a Theorem connecting Theory of Synchronisation with Theory of Resonances, A. Cornu, 404; Interior Pressure in Gases, E. H. Amagat, 404; Straining of Earth resulting from Secular Cooling, Charles Davison, 424; on Homogeneous Division of Space, Lord Kelvin, P.R.S., 445, 469; the Attachment of Quartz Fibres, Prof. C. V. Boys, F.R.S., 450; Method of determining Refractive indices of Liquids, Mr. Littlewood, 450; Internal Pressure of Fluids, Amagat, 500; the Behaviour of Liquids under High Pressure, J. W. Rodger, 506; General Law of Solubility of Normal Substances, H. Le Chatelier, 524; a Lecture Experiment, J. C. Foye, 531; the Magnetic Rotary Dispersion of Oxygen, Dr. Siertsema, 607.
- Physiology: Physiological Action of Oxygen in Asphyxia, 16; Movements of Surface of Heart, M. Potain, 23; Berlin Physiological Society, 48, 167, 240, 380, 427, 596; Physiology of Ureter, Dr. Lewin, 48; Influence of Diffusive Processes on Transudation, Dr. Cohnstein, 48; Hepatic Glycogenesis, Dr. Noel Paton, 141; Feeding Experiment with Nucleic Acid on Dogs, Dr. Gumlich, 167; Leucocytosis, Dr. Goldscheider, 167; Experiments on Median Pharyngeal Nerve, Dr. Katzenstein, 168; New Method of Measuring Amount of Circulating Blood, Prof. Zantz, 168; Death of Dr. P. A. Spiro, 179; Institute of Physiology established at Brussels, M. G. Solvay, 180; Nucleic Acid, Prof. A. Kossel, 240; Physiological Psychology and Psycho-Physics, 252; Dr. E. B. Titchener, 457; Death of M. Quinquand, 270; Chronometric Determinations relating to Regeneration of Nerves, C. Vanlair, 283; Sugar as Food in Production of Muscular Work, Dr. Vaughan Harley, 283; Grundzüge der Physiologischen Psychologie, Wilhelm Wundt, 311; the Essentials of Chemical Physiology, Prof. W. D. Halliburton, 313; the Os Pedis in Ungulates, Prof. A. E. Mettan, 341; Effects upon Respiration of Faradic Excitation of Cerebrum in Animals, W. G. Spencer, 353; Functions of Cerebellum, Dr. J. S. R. Russell, 354; Tactile Areas of Cerebral Cortex, Prof. Munk, 380; the Kidney of the Snail, Paul Girod, 380; the Humanest Method of Slaughtering Animals, Dr. Dembo, 427; the Action of Quinine on Metabolism of Man, Dr. von Noorden, 427; Prof. Zantz's Experiments on Respiration by Skin and Intestine of Horse, 427; Human Physiology, John Thornton, Dr. J. S. Edkins, 431; Reaction Times and Velocity of Nervous Impulse, Profs. Dolley and Cattell, 462; the Minute Structure of the Nerve Centres, Prof. Ramon y Cajal, 464; Determination of Volume of Blood Corpuscles, Dr. Grijns, 476; Experimental Investigation of Central Nervous System of Monkey, Dr. E. L. Mellus, 498; the Scope of Psycho-Physiology, Prof. C. Lloyd Morgan, 504; Note on the Liver-ferment, Miss M. C. Tebb, 523; Death of Dr. Brown-Séquard, 538; Biographical Sketch of Dr. Marcellus Malpighi, 583
- Physodes, Morphological and Micro-chemical Investigations on, E. Crato, 132
- Pickering (Prof. E.), Anderson's Variable in Andromeda, 419
- Pickering (Prof. W. H.), Harvard College Meteorological Observatories in Peru, 180; South American Meteorology, 263; Melting of the Polar Caps of Mars, 586
- Pictures, Nature, for Little People, W. Mawer, 529
- Pierce (G. W.), Electric Strength of Solid, Liquid, and Gaseous Dielectrics, 181
- Pigments, Ancient Egyptian, Dr. William J. Russell, F.R.S., 374
- Piltchikoff (N.), New Method of Studying Electric Discharge, 540

- Pinkerton (R. H.), Hydrostatics and Pneumatics, 362  
 Pitt-Press Euclid, v. vi., H. M. Taylor, 52  
 Pivot-Testing, Method of, Maurice Hamy, 111  
 Plane Trigonometry, S. L. Loney, 339  
 Planet Jupiter, the, 18, 67, 85, 104, 300, 323  
 Planet Venus, the, 233, 413  
 Planimeters, Prof. Perry, 617  
 Plant Names, Kew Index of, 241  
 Plants, Dictionary of the Active Principles of, C. E. Sohn, 385  
 Plants, Flowering, of Western India, Rev. A. K. Nairne, 501  
 Plants, on the Irritability of, Prof. F. Elfving, 466; Prof. Pfeffer, 586  
 Plants, Recent Investigations and Ideas on the Fixation of Nitrogen by, Prof. H. Marshall Ward, F.R.S., 511  
 Plating, on the Buckling and Wrinkling of, supported on a Framework under the Influence of Oblique Stresses, G. H. Bryan, 499  
 Plausible Paradox in Chances, a, Francis Galton, F.R.S., 365; Lewis R. Shorter, 413  
 Pleiades, the, 366  
 Plesiosaurus, Complete, found in Würtemberg, 271  
 Plön, Forschungsberichte aus der Biologischen Station zu, Dr. O. Zacharias, 385  
 Plumandon (J. R.), Application of Meteorology to the Art of War, 488  
 Plymouth Marine Biological Station, Week's Work of, 38, 67, 84, 162, 323, 372, 418  
 Pneumatics, Hydrostatics and, R. H. Pinkerton, 362  
 Pocock (R. I.), the Zoological Record, 53, 198; further Notes and Observations upon the Instincts of some common English Spiders, 60; on the Classification of the Tracheate Arthropoda, a Correction, 124  
 Poetry, Astronomy in, 372; Rev. Edward Geoghegan, 413; G. W. Murdoch, 434  
 Poincaré (H.), Propagation of Electricity, 239  
 Poison, Serpent, Inoculation against, A. Calmette, 548  
 Poisonous Principle of Adder's Blood, MM. Phisalix and Bertrand, 284  
 Poitevin (Henri), Report of Pasteur Institute for 1893, 581  
 Polado Flint Saws, the, Dr. R. Munro, 183  
 Polar Caps of Mars, Melting of, Prof. W. H. Pickering, 586  
 Polar Exploration, the Proposed Continuous, Robert Stein, 18, 124, 256, 346  
 Polymorphous Microbe in Syphilis, on the Presence of a, Dr. Golasz, 500  
 Polyphases. Les Courants, J. Rodet et Busquet, 122  
 Pomortseff (M.), the Motion of Clouds, 230  
 Poncins' (M. de) Explorations in the Pamirs, 18  
 Poncins (E.), Pamirs Crossed by, 163  
 Port Erin, Dredging Expedition at, Prof. W. A. Herdman, F.R.S., 503  
 Port Jackson, Coal Discovered at, 64  
 Postal Transmission of Natural History Specimens, the, Isaac J. Wistar, Edward J. Nolan, 100; R. McLachlan, F.R.S., 172; Philip P. Calvert, 314  
 Potain (M.), Movements of Surface of Heart, 23  
 Potholes, Glacial, of Cooper's Island, U.S., W. O. Crosby, 160  
 Potsdam, the Earthquake of November 5 at, 159  
 Potter (M. C.), an Elementary Text-Book on Agricultural Botany, 290  
 Pouchet (H. C. G.), Death and Obituary Notice of, 538  
 Poulton (Prof. E. B., F.R.S.), Method of showing Geographical Distribution of Insects in Collections, 95  
 Powell (Major J. W.), Eighth Report of U.S. Bureau of Ethnology, 132  
 Pratt (J. H.), Chemical Composition of Stauroilite, 402  
 Precious Stones, 319  
 Preece (W. H., F.R.S.), a Manual of Telephony, 454; Brilliant Aurora Borealis of March 30, 1894, 539; Earth Currents, 554  
 Prehistoric Interments of the Balzi Rossi Caves near Mentone, Arthur J. Evans, 42  
 Prehistoric Man, Evidences of Existence of Man in Nicaragua in Neolithic Age, J. Crawford, 107  
 Prehistoric Man in Jersey, Edward Lovett, 487  
 Pressures, Measurements of Low Vapour, J. W. Rodger, 436  
 Preston (Thomas), the Theory of Heat, Prof. G. C. Carey Foster, F.R.S., 573  
 Prestwich (Dr., F.R.S.), on a Possible Cause for the Origin of the Tradition of the Flood, 594  
 Pretoria, establishment of State Museum at, 12  
 Preventive Medicine, the Directorship of the British Institute of, Prof. Chas S. Roy, F.R.S., 269; Sir Joseph Fayrer, F.R.S., 292; Prof. Victor Horsley, F.R.S., 292  
 Prideaux (R. M.), the Early Return of Birds, 578  
 Prince Henry the Navigator, Quinquecentenary of, 301  
 Prince (J. J.), Graphic Arithmetic and Statics, 28  
 Prinz (W.), the Internal Temperature of Trees, 271  
 Procacci (Dr.), Bactericidal Influence of Sunshine on Drain-water Microbes, 461  
 Proctotrypidæ, the North American, W. H. Ashmead, 182  
 Protective Habit in a Spider, Prof. C. Lloyd Morgan, 102  
 Protoplasm, Artificial Amœbæ and, Dr. G. Quincke, 5; Dr. John Berry Haycraft, 79  
 Protoplasm, Foam Theory of, E. A. Minchin, 31  
 Prudden (Herr), Vitality of Micro-Organisms on Artificial Ice, 395  
 Prunet (A.), the Propagation of *Pourridié* by Storage of Graft-Slips in Moist Sand, 24  
 Pruning, Tree, A. des Cars, Prof. W. R. Fisher, 526  
 Psychology; American Psychological Association, 252; Psychological Review, 297; Grundzüge der Physiologischen Psychologie, Wilhelm Wundt, 311; Investigations on Reaction Time and Attention, Dr. C. B. Bliss, 439; Reaction Times and Velocity of Nervous Impulse, Profs. Dolley and Cattell, 462; the Status of the Mind Question, Lester Ward, 510  
 Psycho-Physics, Physiological Psychology and, 252; Dr. E. B. Titchener, 457  
 Psycho-Physiology, the Scope of, Prof. C. Lloyd Morgan, 504  
 Ptarmigan of Aleutian Islands, the, W. B. Evermann, 584  
*Pteris serrulata* (L. fil.), Var. *Cristata*, Apogamy in, A. H. Trow, 434  
 Public, Astronomy for the, Sir Robert S. Ball, F.R.S., R. A. Gregory, 243  
 Public Health: a Treatise on Hygiene and Public Health, T. Stephenson and S. F. Murphy, 285; Public Health and Demography, Edward F. Willoughby, 285  
 Pumpelly (R.), Apparent Time-break between Eocene and Chattahoochee Miocene in S.W. Georgia, 214  
 Pumps, Steam, on Russian Railways, Alexander Borodin, 19  
 Puy-de-Dôme, Discovery of Ruins of Temple to Mercury on, 14  
 Pycroft (George), Death of, 538  
 Pygidium of Triarthrus, the Appendages of the, Charles E. Beecher, 617  
 Pyrenees: Les Pyrénées, Eugène Trutat, 122; Geographical Conditions of the Pyrenees, MM. Schrader and De Margerie, 275; Prehistoric History of the Pyrenees, 593  
 Quarterly Journal of Microscopical Science, 139, 423  
 Quarterly Review, Science in the, 352  
 Quartz Fibres, the Attachment of, Prof. C. V. Boys, F.R.S., 450  
 Quaternionic Innovations, Oliver Heaviside, F.R.S., 246  
 Quaternions in Physics, Utility of, A. McAulay, Prof. P. G. Tait, 193  
 Queensland, Progress in 1892 of Geological Survey of, R. L. Jack, 109  
 Quekett Microscopical Club, 523  
 Quincke (Dr. G.), Artificial Amœbæ and Protoplasm, 5  
 Quinquand (M.), Death of, 270  
 Race, Disease and, Jadroo, 575  
 Radiant Energy, the Nomenclature of, Prof. Simon Newcomb, F.R.S., 100; Prof. G. F. Fitzgerald, F.R.S., 149; Prof. A. N. Pearson, 389  
 Radloff (W.), the Orkhon River Archæological Expedition, 23  
 Railways, Round the Works of our Great, N. J. Lockyer, 312  
 Rain, Artificial, Influence on Plants of, Prof. J. Wiesner, 253  
 Rainbow, a Lunar, Rev. C. W. Langmore, 321  
 Rainfall: New Form of Rainfall Map, H. L. Russell, 180; the Sun-spot Period and the West Indian Rainfall, Maxwell Hall, 399; Rainfall Records in British Isles, G. J. Symons, 438; Observations of Rainfall in Edinburgh, 520  
 Rama, the Nativity of, Col. Walter R. Old, 4  
 Rambaut (Prof. Arthur A.) on the Great Meteor of February 8, 572

- Ramsay (W.), Molecular Formulæ of some Liquids as Determined by their Molecular Surface Energy, 377
- Raps (A.), Air Vibrations, 46; Photography of Aërial Vibrations, 48
- Rasori (Dr.), the Ætiology of Delirium Acutum, 208
- Ravenstein (E. G.), Philip's Systematic Atlas, Physical and Political, 574
- Kawitz (Dr.), Spermatogenesis in Hydromedusæ, 240
- Raz, a Hermaphroditical, M. Hoek, 264
- Rayet (G.), Forest Fires and Drought, 191
- Reaction-Time and Attention, Investigations on, Dr. C. B. Bliss, 439
- Reckensann (A.), Death of, 63
- Reclus (Elisée) Nouvelle Géographie Universelle, Completion of, 256
- Recognition Marks, G. J. Macgillivray, Dr. Alfred R. Wallace, F.R.S., 53
- Records of Geological Survey of India, 109
- Red Spot, Jupiter and his, W. F. Denning, 104
- Redpath (Peter), Death and Obituary Notice of, 345
- Refraction Tables, 134
- Refractometer applied to Study of Chemical Reactions, J. Verschaffelt, 546
- Reid (Clement), the Dispersal of Shells, Henry Wallis Kew, 361; Cause of Extinction of Pine in South of England, 522
- Reinach (Saloman), Le Mirage Oriental, 472
- Rejected Address, a, 555
- Remsen (Prof. Ira), on Chemical Laboratories, 531
- Renault (B.), General Character of Bogheads produced by Algæ, 47
- Renk (Heir), Vitality of Micro-organisms on Artificial Ice, 395
- Research, Scientific, the Elizabeth Thompson Fund for Advancement of, 539
- Respiration, Effect of Faradic Excitation of Cerebrum in Animals upon, W. G. Spencer, 353
- Retrospect, an Ornithological, Dr. R. Bowdler Sharpe, 6
- REVIEWS AND OUR BOOKSHELF.
- British Forest Trees, J. Nisbet, 1
- A Popular History of Astronomy during the Nineteenth Century, Agnes M. Clerke, 2
- Inorganic Chemistry for Beginners, Sir Henry Roscoe, F.R.S., and Joseph Lunt, 3
- The Chemistry of Fire, M. M. Pattison Muir, 3
- Solutions of the Exercises in Taylor's Euclid I. to IV., W. W. Taylor, 3
- Personal Recollections of Werner von Siemens, 25
- The Iron Ores of Great Britain and Ireland, J. D. Kendall, Bennett H. Brough, 27
- The Shrubs of North-Eastern America, Charles S. Newhall, 28
- Mensuration of the Simpler Figures, William Briggs and T. W. Edmondson, 28
- The Discovery of Australia, Albert F. Calvert, 28
- Graphic Arithmetic and Statics, J. J. Prince, 28
- The Orchid Seekers, Ashmore Russan and Frederick Boyle, 28
- An Examination of Weismannism, G. J. Romanes, F.R.S., 49
- Icones Orchidearum Austro-Africanarum Extra-tropicarum; or, Figures, with Descriptions, of Extra-Tropical South African Orchids, Harry Bolus, R. A. Rolfe, 50
- An Astronomical Glossary, J. E. Gore, 51
- With the Woodlanders and by the Tide, a Son of the Marshes, 51
- Pitt Press Euclid V., VI., H. M. Taylor, 52
- The Outdoor World, W. Furneaux, 52
- Worked Examples in Co-ordinate Geometry, William Briggs and G. H. Bryan, 52
- A Treatise on the Kinetic Theory of Gases, Henry William Watson, F.R.S., Prof. P. G. Tait, 73
- A History of Crustacea; Recent Malacostraca, Rev. Thomas R. K. Stebbing, 74
- An Elementary Treatise on the Geometry of Conics, A. Mukhopadhyay, 75
- The Geometrical Properties of the Sphere, William Briggs and T. W. Edmondson, 75
- A Key to Carroll's Geometry, J. Carroll, 75
- The Mummy, E. A. Wallis-Budge, F.S.A., 97
- Eskimo Life, Fridtjof Nansen, 98
- La Voie Lactée dans l'Hémisphère Boréal, C. Easton, 99
- An Elementary Treatise on Analytical Geometry, W. J. Johnston, 99
- Zur Kenntniss der Postembryonalen Schädelmetamorphosen bei Wiederkauern, H. G. Stehlin, 99
- Elementary Course of Practical Science, Hugh Gordon, Sir Philip Magnus, 121
- Les Pyrénées, Eugene Trutat, 122
- Les Courants Polyphases, J. Rodet et Busquet, 122
- Solutions of the Examples in the Elements of Statics and Dynamics, S. L. Loney, 122
- Problèmes et Calculs Pratiques d'Electricité, M. Aimé Witz, Prof. A. Gray, 145
- A Treatise on Dynamics, W. H. Besant, A. B. Basset, F.R.S., 146
- Our Household Insects: an Account of the Insect Pests found in Dwelling-houses, E. A. Butler, 147
- Text-Book of Biology, H. G. Wells, 148
- The New Technical Educator, 148
- Heat and the Principles of Thermodynamics, Dr. C. H. Draper, 148
- Beni Hasan, P. E. Newberry and G. W. Frazer, 169
- Letters to Marco, George D. Leslie, 170
- A Text-Book of Heat, R. Wallace Stewart, 171
- The Industries of Animals, Frédéric Houssay, 171
- Utility of Quaternions in Physics, A. McAulay, Prof. P. G. Tait, 193
- Painter's Colours, Oils, and Varnishes: a Practical Manual, George H. Hurst, 194
- British Fungus Flora, a Classified Text-Book of Mycology, George Masee, Dr. M. C. Cooke, 195
- Some Salient Points in the Science of the Earth, Sir J. William Dawson, F.R.S., 196
- Das Karstphänomen, Dr. Jovan Cvijic, 197
- Report on the Present State of our Knowledge respecting the General Circulation of the Atmosphere, L. Teisserenc de Bort, 217
- On Hail, Hon. Rollo Russell, 217
- Weather Lore: a Collection of Proverbs, Sayings, and Rules concerning the Weather, R. Inwards, 217
- Hand- und Hilfsbuch zur Ausführung physiko-chemischer Messungen, W. Ostwald, J. W. Rodger, 219
- Hand-Book of British Hepaticæ, M. C. Cooke, 220
- The Royal Natural History, R. Lydekker, 220
- Index Kewensis plantarum phanerogamarum nomina et synonyma omnium generum et specierum a Linnaeo usque ad annum mdccclxxxv complectens nomine recepto auctore patria unicuique plantæ subjectis, Sumptibus Caroli Roberti Darwin, ductu et consilio Josephi D. Hooker, confect B. D. Jackson, 241
- In the High Heavens, Sir R. S. Ball, F.R.S., R. A. Gregory, 243
- Practical Agricultural Chemistry for Elementary Students, J. Bernard Coleman and Frank F. Addyman, 244
- Bionomie des Meeres, Johannes Walther 244
- The Story of Our Planet, T. G. Bonney, F.R.S., Supp. iii.
- The Collected Mathematical Papers of Arthur Cayley, F.R.S., Supp. iv.
- The Pamirs, Earl of Dunmore, Supp. vi.
- Catalogue of the Madreporarian Corals in the British Museum, George Brook, Prof. Alfred C. Haddon, Supp. ix.
- Physiological Chemistry of the Animal Body, Arthur Gamgee, F.R.S., Dr. J. S. Edkins, Supp. x.
- An Essay on Newton's "Principia," W. W. Rouse Ball, Supp. xii.
- Engineering, Drawing, and Design, Sydney H. Wells, N. J. Lockyer, Supp. xiii.
- Catalogue of the Egyptian Collection in the Fitzwilliam Museum, E. A. Wallis-Budge, F.S.A., Supp. xiii.
- Horns and Hoofs, R. Lydekker, Supp. xiv.
- A Treatise on Hygiene and Public Health, T. Stephenson and Shirley F. Murphy, 285
- Public Health and Demography, Edward H. Willoughby, 285
- Methods of Practical Hygiene, Prof. K. B. Lehmann, 285
- Text-Book of Geology, Sir Archibald Geikie, F.R.S., Prof. A. H. Green, F.R.S., 287
- On the Chemistry of the Blood, and other Scientific Papers, L. C. Woolldridge, 289

- An Elementary Text-Book on Agricultural Botany, M. C. Potter, 290
- Healthy Hospitals: Observations on some Points connected with Hospital Construction, Sir Douglas Galton, F.R.S., 290
- The Vault of Heaven, Richard A. Gregory, 291
- A Journey through the Yemen, and some General Remarks upon that Country, Walter B. Harris, 291
- Chinese Central Asia: a Ride to Little Tibet, Henry Lansdell, W. F. Kirby, 309
- Collected Essays, T. H. Huxley, F.R.S., Prof. E. Ray Lankester, F.R.S., 310
- Grundzüge der Physiologischen Psychologie, Wilhelm Wundt, 311
- Round the Works of our Great Railways, N. J. Lockyer, 312
- The Essentials of Chemical Physiology, Prof. W. D. Halliburton, 313
- The Sacred City of the Ethiopians, J. T. Bent, 314
- Fra i Batacchi indipendenti, 314
- Romance of the Insect World, L. N. Badenoch, 314
- Darwinianism: Workmen and Work, James Hutchison Stirling, Dr. Alfred R. Wallace, F.R.S., 333
- Dynamos, Alternators, and Transformers, Gisbert Kapp, 337
- Golf: a Royal and Ancient Game, Robert Clark, W. Rutherford, 338
- Celestial Objects for Common Telescopes, Rev. T. W. Webb, 339
- Plane Trigonometry, S. L. Loney, 339
- Notes on Recent Researches in Electricity and Magnetism, Prof. J. J. Thomson, F.R.S., Prof. A. Gray, 357
- The Applications of Elliptic Functions, Alfred George Greenhill, F.R.S., H. F. Baker, 359
- The Dispersal of Shells, Harry Wallis Kew, Clement Reid, 361
- The Wilder Quarter-Century Book, 362
- Machine Drawing, Thomas Jones and T. Gilbert Jones, 362
- Hydrostatics and Pneumatics, R. H. Pinkerton, 362
- How to Manage the Dynamo, S. R. Bottone, 363
- Lectures on Maxwell's Theory of Electricity and Light, Dr. Ludwig Boltzmann, 381
- The Story of the Sun, Sir Robert Ball, F.R.S., A. Fowler, 382
- The Butterflies and Moths of Teneriffe, A. E. Holt White, W. F. Kirby, 384
- Dictionary of the Active Principles of Plants, C. E. Sohn, 385
- Forschungsberichte aus der Biologischen Station zu Plön, Dr. O. Zacharias, 385
- Biology as it is applied against Dogma and Freewill and for Weismannism, H. Croft Hillier, 386
- Heat: an Elementary Text-Book, Theoretical and Practical, for Colleges and Schools, R. T. Glazebrook, F.R.S., 386
- Electrical Experiments, G. E. Bonney, 386
- Handbuch der Stereochemie, Dr. Paul Walden, 409
- Marine Boiler Management and Construction, C. E. Stromeier, 410
- Chapters on Electricity, Samuel Sheldon, 411
- Meteorology, H. N. Dixon, 412
- A Text-Book on Electromagnetism and the Construction of Dynamos, Dugald C. Jackson, Prof. A. Gray, 429
- A Text Book on Gas, Oil, and Air Engines, Bryan Donkin, N. J. Lockyer, 430
- Human Physiology, John Thornton, Dr. J. S. Edkins, 431
- Light: an Elementary Text-Book, Theoretical and Practical, for Colleges and Schools, R. T. Glazebrook, F.R.S., 432
- Beni Hasan, P. E. Newberry, 432
- Der Botanische Garten "s Lands Plantentuin" 2 v. Buitenzorg auf Java, 453
- Eine Botanische Tropenreise, Indomalayische Vegetationsbilder und Reiseskizzen, Prof. Dr. Haberlandt, 453
- A Manual of Telephony, W. H. Preece, F.R.S., and Arthur J. Stubbs, Prof. A. Gray, 454
- Einführung in das Studium der Bakteriologie mit besonderer Berücksichtigung des mikroskopischen Technik für Aerzte und Studierende, Dr. Carl Günther, Mrs. Percy Frankland, 455
- Lectures on Mathematics, Felix Klein, 456
- Elementary Trigonometry, H. S. Hall and S. R. Knight, 456
- A Treatise on the Theory of Functions, James Harkness and Frank Morley, 477
- Drum Armatures and Commutators, F. W. Weymouth, E. Wilson, 478
- Illustrated Guide to British Mosses, H. G. Jameson, 479
- Report of Observations of Injurious Insects and Common Farm Pests during the Year 1893, with Methods of Prevention and Remedy, Eleanor A. Ormerod, 480
- On the Definitions of the Trigonometric Functions, A. Macfarlane, 480
- Key to Mr. J. B. Lock's Shilling Arithmetic, Henry Carr, 480
- The Flowering Plants of Western India, Rev. A. K. Nairne, 501
- Cancer, Sarcoma, and other Morbid Growths, considered in Relation to the Sporozoa, J. Jackson Clarke, 502
- The Fauna of the Deep Seas, Sydney J. Hickson, 502
- A Treatise on Elementary Hydrostatics, John Greaves, 503
- The Pharmacopœia of the United States of America, 525
- Tree Pruning: a Treatise on Pruning Forest and Ornamental Trees, A. des Cars, Prof. W. R. Fisher, 526
- Practical Forestry, Angus D. Webster, Prof. W. R. Fisher, 526
- Micro-Organisms and Fermentation, Alfred Jörgensen, Dr. A. A. Kanthack, 527
- A Year amongst the Persians, Edward G. Brown, 528
- Nature Pictures for Little People, W. Mawer, 529
- Social Evolution, Benjamin Kidd, Dr. Alfred R. Wallace, F.R.S., 549
- Essays in Historical Chemistry, Prof. T. E. Thorpe, F.R.S., M. M. Pattison Muir, 551
- The Canadian Ice Age, Sir J. William Dawson, F.R.S., 552
- Grundzüge einer Entwicklungsgeschichte der Pflanzenwelt Mitteleuropas seit dem Ausgang der Tertiärzeit, Dr. August Schulz, 553
- Elementary Metal Work, G. C. Leland, 554
- The Theory of Heat, Thomas Preston, Prof. G. Carey Foster, F.R.S., 573
- Philip's Systematic Atlas, E. G. Ravenstein, 574
- Life and Rock: a Collection of Zoological and Geological Essays, R. Lyddeker, 575
- Disease and Race, Jadroo, 575
- The Macleay Memorial Volume, 597
- An Elementary Treatise on Fourier's Series and Spherical, Cylindrical, and Ellipsoidal Harmonics, W. E. Byerly, 598
- Bird Life in Arctic Norway, Robert Collet, 599
- A Text-Book of Euclid's Elements, H. S. Hall and F. H. Stevens, 599
- Reymond (Dr. A. du Bois), Lilienthal's Experiments in Flying, 356
- Rheam (W.) Experiments in Elementary Physics, 433
- Rhinoceros in London, White, Rowland Ward, 584
- Rhone at Entrance into Lake of Geneva, Composition of Water of, A. Delebecque, 264
- Rhythm, Music, and Muscle, Prof. P. Clifford Allbutt, 340
- Riccò (Prof.), Mode of Propagation of Earthquake Shocks between Zante and Catania, 606; Speed of Perception of Stars, 608
- Richards (Mr.), Occluded Gas contained in Oxides of Copper, Zinc, Nickel, and Magnesium prepared by Ignition of Nitrate, 209
- Richards (Prof.) the Atomic Weight of Barium, 562
- Richet (C.), Influence of Metallic Salts on Lactic Fermentation, 96
- Richter (Dr. M. M.), Best Method of using Oil in Calming Troubled Waters, 488
- Riddle (Dr.), Researches on Melting-points of Refractory Inorganic Salts, 110
- Righi's (Prof. Augusto), Experiments with Electromagnetic Waves of Small Length, 15; Righi's Experiments on Hertz's Oscillations, Dr. Rubens, 167; Improved Form of Blackburn's Pendulum for Slow Production of Lissajous's Figures, 582; a very Sensitive Idiostatic Electrometer, 606
- Rimington (E. C.), Behaviour of Air-Cone Transformer when Frequency below certain Critical Value, 46
- Rink (Dr. H.), Death of, 210

- Rio de Janeiro, Anuario do Observatorio do, 299  
 Ripples, E. Guyon, 143  
 Rivers according to Size, the Classification of, Marcel Dubois, 487  
 Rix (Herbert), Henry Oldenburg, First Secretary of the Royal Society, 9  
 Rizzo (G. B.), Kirchhoff's Law connecting Absorptive and Emissive Powers of Substances tested for Glass by, 606  
 Robinson (Phil), Shakespeare's Natural History, 444  
 Rock, on a Method of separating the Mineral Components of a, Prof. W. J. Sollas, F.R.S., 211  
 Rock, Life and, a Collection of Zoological and Geological Essays, R. Lydekker, 575  
 Rock-Basins: the Erosion of, Prof. T. G. Bonney, F.R.S., 52; T. D. La Touche, 39; in the Himalayas, R. D. Oldham; 77  
 Rodet (J.), Les Courants Polyphases, 122  
 Rodger (J. W.), Hand- und Hilfsbuch zur Ausführung physiko-chemischer Messungen, W. Ostwald, 219; the Bakerian Lecture, 419; Measurements of Low Vapour Pressures, 436; the Behaviour of Liquids under High Pressure, 506.  
 Roepel (Dr.), New Apparatus for obtaining Absolute Measurements of Magnetic Properties of different kinds of Iron, 595  
 Rogers (Mr.), Occluded Gas contained in Oxides of Copper, Zinc, Nickel and Magnesium prepared by Ignition of Nitrate, 209  
 Rolfe (R. A.), Icones Orchidearum Austro-Africanarum Extra-tropicarum, Henry Bolus, 50  
 Roman Villa near Cardiff, John Storrie, 605  
 Romanes (Dr. Geo. F.R.S.) Telegony 6; an Examination of Weismannism, 49, 78; Experiments in Heliotropism, 140; Experiments in Germination, 140; Panmixia, 599  
 Rome: Solar Observations at, 67, 163; the International Medical Congress at, 538, 563  
 Roncali (Signor), Virulence of Tetanus Bacillus increased by addition of other Organic Products, 254  
 Roscoe (Sir Henry, F.R.S.), Inorganic Chemistry for Beginners, 3; the Secondary Education Movement, 203  
 Rosenfeld (Prof.), Cause of Explosion on Contact of Metallic Sodium with Water, 232  
 Ross (W. J. C.), Geology of Bathurst, New South Wales, 94  
 Rossel (Herr), New Method of preparing Phosphorus, 323  
 Rossikoff (K. N.), Lake Desiccation on Northern Slopes of Caucasus, 515  
 Rothney (G. A. G.), Mimicry of Hemiptera by Lepidoptera, 619  
 Rothschild (Hon. Walter), the Apteryx Genus, 14  
 Roumania, Glazed Frost of November 11-12, 1893, in, 272  
 Rovigno Marine Biological Station, the, 560  
 Rowland's Concave Gratings, the Astigmatism of, 489  
 Roy (Prof. Charles S., F.R.S.), the Directorship of the British Institute of Preventive Medicine, 269  
 Royal Astronomical Society, 345  
 Royal Institution, Resolution of Condolence with Mrs. Tyndall, 179  
 Royal Meteorological Society, 119, 215, 307, 425, 547, 619  
 Royal Microscopical Society, 47, 119, 263, 330, 594  
 Royal Society, 140, 189, 263, 283, 306, 353, 377, 424, 449, 472, 498, 570; Henry Oldenburg, First Secretary, Herbert Rix, 9; Medal Awards, 63; Anniversary Meeting, 134; the Royal Society, Sir John Evans, F.R.S., 576; the Royal Society Club, 79  
 Royal Society, Sydney, 332  
 Royère (W. de la), New Processes for Detection of Vegetable and Mineral Oils, 377  
 Rubens (Dr.), Righi's Experiments on Hertz's Oscillations, 167  
 Rücker (Prof. Arthur W., F.R.S.), on M. Mercadier's Test of the Relative Validity of the Electrostatic and Electromagnetic Systems of Dimensions, 387; Dr. G. Johnstone Stoney, F.R.S., 432  
 Rudimentary (Vestigial) Organs, 199, 247; C. Mostyn, 247  
 Rugby School Natural History Society, 541  
 Runge (Prof. C.), Experiments on Flying, 157; Correction, 183; the Spectra of Tin, Lead, Arsenic, Antimony and Bismuth, 509  
 Runge (Friedlieb F.), Celebration of Centenary of Birth of, 415  
 Russan (Ashmore), the Orchid Seekers, 28  
 Russell (H. C., F.R.S.), Astronomical Photography, 111; New Form of Rainfall Map, 180; New South Wales Government Report of Meteorological Observations for 1892, 252; on a Meteorite from Gilgoin Station, 325; Fine Aurora Australis, 601  
 Russell (Dr. H. L.), the Bacterial Contents of Sea-water, 559  
 Russell (Dr. J. S. R.), Functions of Cerebellum, 354  
 Russell (Hon. R.), Epidemic Influenza, 210; on "Hail," 217; Brilliant Aurora Borealis of March 30, 1894, 539; a Remarkable Meteor, 601  
 Russell (Dr. William J., F.R.S.), Ancient Egyptian Pigments, 374  
 Russell (W.), Anatomical Modifications of Plants of the same Species in the Mediterranean Region and in the Region of the Neighbourhood of Paris, 620  
 Russell's Observations on Microbial Condition of Massachusetts Coast Sea-water and Mud, 37  
 Russia: Introduction of Decimal System into, 129; Amber in, F. T. Köppen, 181; Propo-ed Tea Cultivation in, 393  
 Russian Geographical Society, Memoirs of, 254  
 Rutherford (W.), Golf: a Royal and Ancient Game, 338  
 Rutley (Frank), the Origin of Certain Novaculites and Quartzites, 547  
 Ryan (Prof. J.), the Aurora of March 30, 554  
 Saccharomycetes, Recent Researches on, Alfred Jörgensen, Dr. A. A. Kanthack, 527  
 Sacken (Baron C. R. Osten), on the Bugonia Superstition of the Ancients, 198; the Earliest Mention of the Kangaroo in Literature, 198  
 Sacred City of the Ethiopians, the, J. T. Bent, 314  
 St. Petersburg Society of Naturalists, Memoirs of, 189  
 St. Petersburg, Bulletin de l'Academie des Sciences de, 23  
 Sakhalin, the Island of, F. Immanuel, 508  
 Salazan (Señor), Micro-Organisms in Ice, 322  
 Salet, (G.), Death of, 624  
 Salient Points in the Science of the Earth, some, Sir J. W. Dawson, F.R.S., 196  
 Salt, Virulence of Cholera Bacillus increased by, Dr. Gamaleia, 132  
 Salts, on the Fusibility of Mixtures of, M. H. Le Chatelier, 595  
 Sanarelli (Dr.), Les Vibrions des Eaux et l'Étiologie du Choléra, 231  
 Sand-filtration as a Means of Purifying Water, Mrs. Percy Frankland, 156  
 Sandeman (G.), a Parasitic Disease in Flounders, 119  
 Sanderson (Prof. J. Burdon, F.R.S.), Human and Comparative Anatomy at Oxford, 6  
 Sangle-Ferrière (M.), Discovery of Abrastol in Wines, 167  
 Sanitary Conference, the International, 538  
 Sanitation: Electrical Sanitation, 469  
 Santiago, Diurnal Ground-Movements at, Dr. Obrecht, 130  
 Satellite, Anomalous Appearance of Jupiter's First, 300  
 Satellite, Period of Jupiter's Fifth, Prof. E. E. Barnard, 85  
 Satellites, Jupiter's, in 1664, 323  
 Satellite of Neptune, the, Prof. Struve, 324; M. Tisserand, 543  
 Savélief (R.), Sun-spots and Solar Radiation, 274; Solar Spots and Heat received by Earth, 284  
 Scandinavia, the Slow Ascensional Movement of, A. Badonrean, 159  
 Scandinavian Ice-Sheet, the, Prof. T. G. Bonney, F.R.S., 388  
 Schaeberle (Prof. J. M.), Mechanical Theory of Comets, 84  
 Schaefer (H. L.), the Origin of Beats, 370  
 Schardt (Hans), Sur l'Origine des Préalpes Romandes, 322  
 Scheele (Carl Wilhelm), Prof. T. E. Thorpe on, 32  
 Schenck (Prof.), the Alleged Action of Green Algæ as Water-Purifiers, 182  
 Schild (Dr.), Method of Differentiating Typhoid and Colon Bacilli, 298  
 Schlick (Otto), the Vibrations of Steamers, 491  
 Schmidt (Dr. Karl), Death of, 507  
 Schmidt (K. E. F.), Elliptic Polarisation of Reflected Light, 547  
 Schöfer (Dr.), the Bacterial Efficiency of Power Cylinders in Water-Filtration, 180

Scholtz (Dr. M.), Changes in Position of Flower-Stalk of *Cobaea scandens*, 306  
 Schoute (Prof.), Regular Sections and Projections of Ikosa-tetrahedron, 144  
 Schrader (M.), Geographical Conditions of Pyrenees, 275  
 Schubert (Dr.), Further Observations of the Temperature and Humidity in Woods and in the Open, 596  
 Schulz (Dr. August), Grundzüge einer Entwicklungsgeschichte der Pflanzenwelt Mitteleuropas seit dem Ausgang der Tertiärzeit, 553  
 Schulze-Berge (Herr F.), New Form of Rotary Air-Pump, 65  
 Schumann (Victor), Photography of Rays of very Short Wave-lengths, 254  
 Schur (Prof.), a Bright Meteor, 111  
 Science: Science in the Magazines, 31, 155, 235, 352, 443, 543; Elementary Course of Practical Science, Hugh Gordon, Sir Philip Magnus, 121; some Salient Points in the Science of the Earth, Sir J. W. Dawson, F.R.S., 196; *American Journal of Science*, 214; Revival of *Science Gossip*, 396; Science at the Free Libraries, Mr. Carrington, 418; Physiology for Science Schools, 431; *Science Progress*, 441; the Elizabeth Thompson Fund for Advancement of Scientific Research, 539; Prof. Michael Foster on the Organisation of Science, 503  
 Sclater (Dr. P. L., F.R.S.), the Zoological Record, 123  
 Scotland: Geological Survey of, 518; the Scottish Geographical Society and Antarctic Research, 257  
 Scott (D. H.), Organisation of Fossil Plants of Coal-Measures, 449  
 Scott (Dr. J. Alfred), Method for Colouring Lantern-Slides for Scientific Diagrams and other Purposes, 572  
 Scott (R. H., F.R.S.), Remarkable Sudden Changes of Barometer on February 23, 1894  
 Scourfield (D. J.), Entomostraca and Surface-Film of Water, 474  
 Screens, Transparent Conducting, for Electric and other Apparatus, Prof. W. E. Ayrton, F.R.S., and T. Mather, 591  
*Scribner's Magazine*, Science in, 352  
 Sea, the Fauna of the Deep, Sydney J. Hickson, 502  
 Sea-Level and Latitude, the Variations of, Prof. Bakhuyzen, 476  
 Sea-Water, the Bacterial Contents of, Dr. H. L. Russell, 559  
 Secondary Education Movement, the, Sir H. E. Roscoe, F.R.S., 203  
 Seeley (H. G., F.R.S.), the Therosuchia, 450; Diademodon, 450  
 Seeman (Captain C. H.), Meteorological Conditions of Hamburg Cholera Epidemic, 180  
 Seine-Saone Canal, Utilisation of Water-Power for Electrical Machinery on, M. Galliot, 272  
 Seismograph, a New Time-registering Photographic, Dr. A. Cancani, 64  
 Seismology: the Recent Earthquake, Charles Davison, 31; Diurnal Ground-Movements at Santiago, Dr. Obrecht, 130; Earth Movements, Prof. John Milne, F.R.S., 301; Mode of Propagation of Earthquake Shocks between Zante and Catania, Prof. Riccio, 606  
 Selwyn (Alfred R. C., F.R.S.), the Origin of Lake Basins, 412  
 Semi-Azimuths, Navigation by, Ernest Wentworth Buller, 223  
 Senegambia, Magnetic Experiments in, T. E. Thorpe, F.R.S., and P. L. Gray, 141  
 Separating the Mineral Components of a Rock, on a Method of, Prof. W. J. Sollas, F.R.S., 211  
*Sequoia gigantea* acquired by British Museum, Remarkable Section of, 507  
 Serpent-Poison, Inoculation against, A. Calmette, 548  
 Setchell (W. A.), the Laminariaceæ, 207  
 Sewage, the Purification of, by Bacteria, Alex. C. Houston, 246  
 Sewage, Reduction of Manganese Peroxide in, W. E. Adeney, 499  
 Sewage, M. Hermite's System of Treating Sewage Matter with Electrolysed Sea-Water, Dr. C. Kelly, 539  
 Sewer Air, Distribution of Zymotic Disease by, Mr. Laws, 347  
 Sextic Resolvent of a Sextic Equation, on the, Prof. W. Burnside, F.R.S., 618  
 Shakespeare's Natural History, Phil Robinson, 444  
 Shan-si, the Plateau of, Mr. Obrucheff, 230  
 Sharp (Dr. D., F.R.S.), White Ants, 522

Sharpe (Dr. R. Bowdler), an Ornithological Retrospect, 6  
 Sheldon (Samuel), Chapters on Electricity, 411  
 Shells, Magnetic Shielding of Concentric Spherical, Prof. A. W. Rücker, F.R.S., 141; Shells, the Dispersal of, Harry Wallis Kew, Clement Reid, 361  
 Shepton Mallet, Earthquake at, Prof. F. J. Allen, 229  
 Ships: the Loss of H.M.S. *Victoria*, Dr. Francis Elgar, 102, 124, 151; the Manœuvring Powers of Steamships and their Practical Applications, Vice-Admiral P. H. Colomb, R.N., 174  
 Shorter (Lewis R.), a Plausible Paradox in Chances, 413  
 Shrewsbury, Proposed Memorial to Charles Darwin at, 320  
 Shrubs of North-Eastern America, Charles S. Newhall, 28  
 Siam, the Upper Mekong, Warrington Smyth, 416  
 Siberia, Anadyr, a New Province in, 18  
 Siberia, a Sub-Tropical Miocene Fauna in Arctic, W. H. Dall, 36  
 Siemens (Dr. Werner von), Personal Recollections of, 25  
 Siertsema (D.), the Magnetic Rotary Dispersion of Oxygen, 607  
 Sigson (A.), Photography of Snowflakes, 131  
 Silicon, Carbide of, Manufactured by Dr. Mühlhauser's Process, 17  
 Silk-Spider of Madagascar, the, Dr. Karl Müller, 253  
 Silver, Mirror, Chemically precipitated on Glass, Properties of, Herr H. Lüdtke, 229  
 Silver on Platinum, Peculiarities of Electrical Deposit of, U. Behn, 321  
 Silvestri's (Prof.) Geodynamic Observations of Etna Eruptions of May and June, 1886, 107  
 Simpler Figures, Mensuration of the, William Briggs and T. W. Edmondson, 28  
 Simpson (C. T.), the Unio Fauna of the Mississippi Valley, 64  
 Sinuoidal Currents, a Liquid Commutator for, Prof. J. A. Ewing, F.R.S., 317  
 Skelto, Are Birds on the Wing killed by Lightning? 577  
 Skua, the Great, Threatened Extermination of, W. E. Clarke, 253  
 Slaughtering Animals, the Humanest Method of, Dr. Dembo, 427  
 Smith (Dr. Donaldson), intended Expedition to Lake Rudolph, 606  
 Smith (Prof. Robertson), Death of, 538; Obituary Notice of, 557  
 Smith (Worthington G.), Fireball, 577  
 Smithell's (Prof. Arthur) Flame, 86, 149, 198  
 Smithsonian Institution Report, the, Prof. S. P. Langley, 397  
 Smyth (Warrington), the Upper Mekong, 416  
 Snail, the Kidney of the, Paul Girod, 380  
 Snow-Crystals, Prof. Hellmann, 216, 232  
 Snowflakes, Photography of, A. Sigson, 131  
 Social Evolution, Benjamin Kidd, Dr. Alfred R. Wallace, F.R.S., 549  
 Sohn (C. E.), Dictionary of the Active Principles of Plants, 385  
 Sohneke (Prof.), Observations during Nocturnal Balloon Ascents at Munich, 416  
 Solandi Sun-printing Process as Applied to Botanical Technique, Prof. Byron Halsted, 370  
 Solar and Magnetic Phenomena, Correlation of, William Ellis, F.R.S., 30, 53, 78, 245; A. R. Hinks, 78; H. A. Lawrance, 101; Dr. M. A. Veeder, 245  
 Solar Magnetic Influences on Meteorology, Prof. H. A. Hazen, 464  
 Solar Observations at Catania, Rome, &c., 67  
 Solar Observations at Rome, 163  
 Solar Radiation, Sun-spots and, M. R. Savélieff, 274  
 Solar Spots and Heat received by Earth, M. R. Savélieff, 284  
 Solid Liquid Surfaces with Temperature, on the Change of Superficial Tension of, Prof. Geo. Fras. Fitzgerald, F.R.S., 293  
 Sollas (Prof.), Geology of Dublin Area, 36  
 Sollas (Prof. W. J., F.R.S.), on a Method of separating the Mineral Components of a Rock, 211  
 Solubility of Normal Substances, General Law of, H. Le Chatelier, 524  
 Solvay (M. G.), Institutes of Electro-Biology and Physiology established at Brussels, by, 180  
 Sonnblick Mountain Observatory, 204  
 Sorel (E.), Adaptation of Alcoholic Ferments to Presence of

- Hydrofluoric Acid, 356; Action of Water on Bicalcic Phosphates, 572
- South Kensington Museum, Mr. James McMurtrie's Collection of Fossil Plants acquired by, 415
- Space, Chemistry in, Dr. John Cannell Cain, 173
- Space, on Homogeneous Division of, Lord Kelvin, P.R.S., 445, 469
- Spectacles for Double Vision, T. J. Dewar, 433
- Spectrum Analysis: Objective Representation of Interference Phenomena in Spectrum Colours, E. von Lommel, 46; Spectra of Hot Gases probably due to Temperature, F. Paschen, 82; New Notation for Lines in Spectrum of Hydrogen, 162; Spectrum of Nova Normæ, 162, 397; Prof. W. W. Campbell, 586; Stars with Remarkable Spectra, T. E. Espin, 183; Photography of Rays of very Short Wave Lengths, Victor Schumann, 254; Magnetic Rotary Dispersion of Carbon Bisulphide in Infra-Red part of Spectrum, G. Moreau, 370; Instrument of Precision for Producing Monochromatic Light, A. E. Tutton, 377; Radiation of Gases, F. Paschen, 376; Combination of Prisms for a Stellar Spectroscope, H. F. Newall, 379; Method of Photographing Spectrum of Lightning, G. Meyer, 417; Comet-Spectra as affected by Width of Slit, 489; the Spectra of Tin, Lead, Arsenic, Antimony and Bismuth, Profs. Kayser and Runge, 509; Spectroscopic Examination of Light Emitted by *Pholinus corruscus* Beetle, A. F. Miller, 540
- Spencer (Herbert), Rejoinder to Prof. Weismann, 155; the Spencer-Weismann Controversy, P. Chalmers Mitchell, 373; Prof. Tyndall, 352
- Spencer (W. G.), Effect upon Respiration of Faradic Excitation of Cerebrum in Animals, 353
- Spermophiles of the Mississippi Valley, the, Vernon Bailey, 36
- Sphere, the Geometrical Properties of the, William Briggs and T. W. Edmondson, 75
- Spherical Vortex, on a, Dr. J. M. Hill, 498
- Spica, Occultation of, 464
- Spiders: Further Notes and Observations upon the Instinct of some Common English, R. I. Pocock, 60; Protective Habit in a Spider, Prof. C. Lloyd Morgan, 102; Mimicry by a Spider, 207; the Silk Spider of Madagascar, Dr. Karl Müller, 253; Notes on the Habits of a Jamaican Spider, Prof. T. D. A. Cockerell, 412; the Suspension of Foreign Bodies from Spiders' Webs, R. Philipp, 481
- Spiro (Dr. P. A.), Death of, 179
- Sporozoa, Cancer, Sarcoma, and other Morbid Growths considered in Relation to the, J. Jackson Clarke, 502
- Sprenger (Prof. A.), Death of, 206
- Springmann (P.), Polarisation of Solid Deposits between Electrolytes, 376
- Spruce (Richard), Obituary Notice of, 317
- Sprung (Prof.), the Diurnal Range in Velocity and Direction of the Wind on the Eiffel Tower, 596
- Spurge (J. B.), New Photometric Method, 355
- Stadl (Dr. van der), Interaction between Oxygen and Phosphuretted Hydrogen, 323
- Stars: a New Southern Star Discovered by Mrs. Fleming, 38; a New Variable Star, Rev. T. E. Espin, 67, 184; New Variable Star in Andromeda, Rev. Thomas D. Anderson, 101; Four New Variable, Discovery of, by Mrs. Fleming, 608; the New Star in Norma, 85; Otto Struve's Double-Star Measures, 111; Stars with Remarkable Spectra, T. E. Espin, 183; Electromotive Force from the Light of the Stars, Prof. Geo. M. Minchin, 269; Hydrogen Envelope of the Star D.M. + 30° 3639, Prof. W. W. Campbell, 210; Proper Motions of Stars, 349; Speed of Perception of Stars, Prof. Ricco, 608. (See also Astronomy.)
- Stas's Determination of Atomic Weights, E. Vogel, 283
- Statics, Graphic Arithmetic and, J. J. Prince, 28
- Statics and Dynamics, Solutions of the Examples in the Elements of, S. L. Loney, 122
- Staurolite, Chemical Composition of, S. L. Penfield and J. H. Pratt, 402
- Steam, on the Latent Heat of, P. J. Hartog and J. A. Harker, 5
- Steam, the Cloudy Condensation of, Shelford Bidwell, F.R.S., 212, 388, 413; Dr. Carl Barus, 363; John Aitken, F.R.S., 340
- Steam-Engine, the Grafton High-speed, E. W. Anderson, 610
- Steam Jets from Various Orifices, Forms of, H. Parenty, 347
- Steam Pumps on Russian Railways, Alexander Borodin, 19
- Steamers, the Vibration of, Otto Schlick, 491
- Steamships, the Manœuvring Powers of, and their Practical Applications, Vice-Admiral P. H. Colomb, R.N., 174
- Steamships, Effects of Reversing Screw on Steering of, Captain Bain, 208
- Stearns (Dr.), the *Albatross* Collection of Galapagos Island Shells, 82
- Stebbing (Rev. Thomas R. R.), a History of Crustacea. Recent Malacostraca, 74
- Steel Meteorite, a Tempered, 372
- Steele (W. H.), Electric Currents produced by heating various Metals, 131
- Stehlin (H. G.), Zur Kenntniss der Postembryonalen Schädel-metamorphosen bei Wiederkauern, 99
- Stein's (Dr.) Arctic Expedition, 256; Proposed Station in Ellesmere Land, 18; Plan for Exploration of Ellesmere Land, 346; the Proposed Continuous Polar Exploration, 124
- Stellar Diameters, the Measurement of, Maurice Hamy, 275
- Stephenson (T.), a Treatise on Hygiene and Public Health, 285
- Stereo-Chemistry, Recent Progress in, Prof. Victor Meyer, 348; Extension of Inorganic Elements of Stereo-Chemistry, Dr. Werner, 372; Handbuch der Stereochemie, Dr. Paul Walden, 409
- Stevens (F. H.), H. S. Hall and, a Text-Book of Euclid's Elements, 599
- Stevenson (C. A.), Telegraphic Communication by Induction by Means of Coils, 571; Electric Communication between Lighthouses and Lightships without Submarine Cables, 581
- Stevenson (J. J.), Geological use of Name "Catskill," 92; Origin of Pennsylvania Anthracite, 271
- Stewart (R. Wallace), a Text-Book of Heat, 171
- Stigmata, the, of the Arachnida as a Clue to their Ancestry, H. M. Bernard, 68
- Stirling (Dr. James Hutchison), Darwinianism; Workmen and Work, 333
- Stocks (H. B.), Coal-Balls and their Fossil Plant Contents, 14
- Stokvis (Prof. B. J.), Chemistry in Relation to Pharmacotherapeutics and Materia Medica, 587
- Stones, Precious, 319
- Stoney (Dr. G. Johnstone, F.R.S.), Vision with Compound Eyes, 379; on M. Mercadier's Test of the Relative Validity of the Electrostatic and Electromagnetic Systems of Dimensions, 432
- Storrie (John), Roman Villa, near Cardiff, 505
- Streets in Paris named after Men of Science, 558
- Stromeyer (C. E.), Marine Boiler Management and Construction, 410; Brilliant Aurora Borealis of March 30, 1894, 539
- Struve (Prof. Otto), Double-Star Measures, 111; the Satellite of Neptune, 324
- Stuart-Menteth (M. P. W.), Ophites of Western Pyrenees, 264
- Stubbs (Arthur J.), a Manual of Telephony, 454
- Styles (W. A.), Orchids, 352
- Submarine Cable between Zanzibar, Mauritius, and Seychelles, 134
- Sugar as Food in Production of Muscular Work, Dr. Vaughan Harley, 283
- Sugar-Cane Moth, the, A. S. Oliff, 64
- Sugar Maples, W. Trelease, 323
- Sulphide of Carbon, a New, A. E. Tutton, 275
- Sun, an Annular Eclipse of the, 542
- Sun, the Presence of Oxygen in the, Dr. Janssen, 585
- Sun, the Story of the, Sir Robert Ball, F.R.S., A. Fowler, 382
- Sun-spots: Sun-spots and Solar Radiation, M. R. Savélieff, 274; Sun-spots and Magnetic Disturbances, Dr. L. Palazzo, 327; Dr. M. A. Veeder, 503; the Sun-spot Period and the West Indian Rainfall, Maxwell Hall, 399; a Large Sun-spot, 419; Sun-spot Phenomena and Thunderstorms, Rev. W. Clement Ley, 531
- Superstition, on the Bugonia, of the Ancients, Baron C. R. Osten-Sacken, 198
- Suspension of Foreign Bodies from Spiders' Webs, the, R. Philipp, 481
- Swan (Prof.), Death of, 437
- Swedish International Polar Expedition, Results of, Dr. J. Hann, 498
- Swift's New Biological Microscope, 523



- Swinburne (James), Potentiometer for Alternating Currents, 190
- Switzerland, Central European Time to be adopted in, 158
- Switzerland, the Experiments upon the use of Electricity gained from Water, 182
- Sydney Royal Society, 332
- Sylvester (Prof.), 13
- Symons (G. J.), Rainfall Records in British Isles, 438
- Symons's Monthly Meteorological Magazine, 139, 238, 449, 520
- Symons (Mr.), March to October, 1893, 238
- Syphilis, on the Presence of a Polymorphous Microbe in, Dr. Golasz, 500
- Systematic Nomenclature, Prof. G. F. Fitzgerald, F.R.S., 148; Fred. T. Trouton, 148
- Tait (Prof. P. G.), a Treatise on the Kinetic Theory of Gases, Dr. William Watson, F.R.S., 73; Utility of Quaternions in Physics, A. McAulay, 193; the Compression of Fluid, 331
- Tarr (R. S.), the Origin of Lake Basins, 315; the Finger Lakes in New York State, 606
- Tasmania, the Recent Glaciation of, Dr. Alfred R. Wallace, F.R.S., 3
- Tasmania, Coming International Exhibition at Hobart, 13
- Taste among (North American) Indians, Sense of, E. H. S. Bailey, 82
- Tate (Prof. Ralph), the Geology of Australia, 277
- Taylor (H. Dennis), Colour-Aberration of Refracting Telescopes, 183
- Taylor (H. M.), Pitt Press Euclid V.-VI., 52
- Taylor (Dr. J. C.), Temperature, Rainfall, and Sunshine of Las Palmas, Grand Canary, 425
- Taylor (W. W.), Solutions of the Exercises in Taylor's Euclid, I. to IV., 3
- Tea-Cultivation in Russia, Proposed, 393
- Teaching University, the, F. Victor Dickens, 536
- Tebb (Miss M. C.), Note on the Liver-ferment, 523
- Technical Education: the Progress of, R. A. Gregory, 185; Bequest by Mr. T. H. Adam, 320; the Work of City and Guild of London Institutes for 1893, 607; the New Technical Educator, 148; Formation of Association of Technical Institutions, 321; on Preparing the Way for Technical Instruction, Sir Philip Magnus, 400
- Technology, the Massachusetts Institute of, 20
- Tegetmeier (W. B.), Abnormal Eggs, 366
- Telegony, Dr. Geo. J. Romanes, F.R.S., 6
- Telegraphic Communication by Induction by Means of Coils, C. A. Stevenson, 571
- Teleki's (Count Samuel) the Last Great Lakes of Africa, 457
- Telephone in India, the, 460
- Telephony, a Manual of, W. H. Preece, F.R.S., and Arthur J. Stubbs, Prof. A. Gray, 454
- Telescope for Greenwich, a New, 464
- Telescopes, Colour-Aberration of Refracting, H. Dennis Taylor, 183
- Telescopes, Celestial Objects for Common, Rev. T. W. Webb, 339
- Telescopes, New Form of Equatorial Mounting for Monster Reflecting, Sir Howard Grubb, 499
- Teller (F.), the so-called Granite of Bacher Mountains, 71
- Temperature: Herr Galitzini's Experiments in Estimation of Critical Temperature, 83; the Temperature of Ignition of Explosive Gaseous Mixtures, A. E. Tutton, 138; on the Change of Superficial Tension of Solid Liquid Surfaces with Temperature, Prof. Geo. Fras. Fitzgerald, F.R.S., 293; Lowest known Temperature, 394; Relation between Mean Quarterly and Death-rate Temperature, W. H. Davis, 547; Minimum Temperature of Visibility, P. L. Gray, 618; on the Magnetic Properties of Iron at different Temperatures, M.P. Curie, 620
- Tempered Steel Meteorite, a, 372
- Temple to Mercury on Puy-de-Dôme, Discovery of Ruins of, 14
- Ten Kate's (Dr. H.) Malaysian and Polynesian (Anthropological) Researches, 23
- Tenerife, the Butterflies and Moths of, A. E. Holt White, W. F. Kirby, 384
- Tennant (John), the Viscous Motion of Ice, 173
- Terrestrial Deformation in the Niagara District, Inferred Rate of, 520
- Terrestrial Refraction in the Western Himalayas, Gen. J. T. Walker, F.R.S., 498
- Tesla (Nikola), T. C. Martin, 352
- Tesu, Colouring Matter of, J. J. Hummel and W. Cavallo, 377
- Tetanus Bacillus, Virulence of, increased by addition of other Organic Products, Signor Roncali, 254
- Tetanus-Poison, Drs. Fermi and Pernossi, 540
- Tetrahedra, on the Division of a Parallelepiped into, Prof. Crum Browne, 571
- Texas, the Trinity Flora of, W. M. Fontaine, 36
- Thermal Expansion of Diamond, the, Dr. J. Joly, F.R.S., 480
- Thermodynamics: Heat and the Principles of Thermodynamics, C. H. Draper, 148; the Second Law of Thermodynamics, S. H. Burbury, F.R.S., 150; G. H. Bryan, 197; S. H. Burbury, F.R.S., 246
- Thermometer for Laboratory Ovens, Electric Alarm, M. Barelle, 355
- Thermometer, New High Temperature, Messrs. Baly and Chorley, 538
- Thessaly, the Geology of, Prof. V. Hirbel, 36
- Thiele (Dr.), Isocyanogen Tetrabromide, 110
- Thiselton-Dyer (W. T., F.R.S.), the Supposed Glaciation of Brazil, 4
- Thomas (G. L.), Separation of Three Liquids by Fractional Distillation, 93
- Thompson (Beeby), Landscape Marble, 522
- Thompson (Elizabeth) Fund for Advancement of Scientific Research, 539
- Thomson (J. J., F.R.S.), Notes on Recent Researches in Electricity and Magnetism, Prof. A. Gray, 357; Electricity of Drops, 378
- Thorne (Dr. L. T.), the New Process for Enriching Coal-Gas with Oxy-Oil Gas, 162
- Thornycroft (J. L.), the Circulation of Water in the Thornycroft Water-tube Boilers, 491
- Thornton (John), Human Physiology, Dr. J. S. Edkins, 431
- Thorpe (Prof. T. E., F.R.S.): on Carl Wilhelm Scheele, 32; Magnetic Experiments in Senegambia, 141; the Bakerian Lecture, 419; Essays in Historical Chemistry, M. M. Pattison Muir, 551
- Thudichum (J. L. W.), Formation of Benzoic Derivatives of Urochrome, 142
- Thunderstorms, Sun-spot Phenomena and, Rev. W. Clement Ley, 531
- Thwaites (C.), Aurora of February 28, 441
- Thyroid Gland, the, 270
- Tibet, the Chinese Map of, Dr. Wegener, 275
- Tidal Phenomena, Grablovitz's Mareographical Observations in Italy, 134
- Tietze (Dr. Emil), Geology of Ostrau District, 46
- Tilden (W. A.), Combination of Hydrocarbons with Picric Acid, 142
- Time, Central European, adopted in Denmark, 228
- Time, Central European, adopted in Italy, 81; Adoption of Signor G. Jervis's Improved Clock-Dial and Time-Table, 81
- Time, Central European, to be adopted in Switzerland, 158
- Time-Infinitesimal, Phenomena of the, Prof. E. L. Nichols, 113
- Tisserand (F.), Motion of Jupiter's Fifth Satellite, 239; the Satellite of Neptune, 543
- Titchener (Dr. E. B.), Physiological Psychology and Psychophysics, 457
- Titherley (A. W.), Amides of Sodium, Potassium, and Lithium, 523
- Tobias (Célestin), on Absorption by the Bile Ducts, 617
- Todd (Sir Charles), Meteorological Work in Australia, 229
- Togo, Kling and Büttner's Expedition to, 207
- Tomatoes, Dropsical Disease in, G. F. Atkinson, 298
- Tombs at Beni Hasan, the, P. E. Newberry and G. W. Fraser, 169
- Topinard (Dr. P.), Distribution of Red Hair in France, 472; the Perfect Man, 520
- Torquay, the Climate of, A. Chandler, 253
- Toxicology: Poisonous Principles of Adder's Blood, MM. Phisalix and Bertrand, 284; Viper Poison, C. Phisalix and G. Bertrand, 380

- Tracheate Arthropoda, on the Classification of the: a Correction, R. I. Pocock, 124
- Transactions of Austrian Geological Survey, 71
- Transformers, Dynamos, Alternators, and, Gisbert Kapp, 337
- Transparent Conducting Screens for Electric and other Apparatus, Prof. W. E. Ayrton, F.R.S., and T. Mather, 591
- Transvaal, Entomological Collecting in the, 12
- Traube (Dr. Hermann), General Method of Artificially Reproducing Crystallised Anhydrous Silicates, 161
- Tree Pruning, A. des Cars, Prof. W. R. Fisher, 526
- Trees, British Forest, J. Nisbet, 1
- Trees, Measurements of Growth of, J. Keuchler, 439
- Trelease (W.), Sugar Maples, 323
- Triarthrus, the Appendages of the Pygidium of, Charles E. Beecher, 617
- Trigonometry: Accuracy of Divisions of Altazimuths of Pistor and Martin and of Repsold, Prof. J. A. C. Oudeman, 192; Plane Trigonometry, S. L. Loney, 339; Elementary Trigonometry, H. S. Hall and S. R. Knight, 456; on the Definitions of the Trigonometric Functions, Dr. A. Macfarlane, 480
- Trillat (M.), New Mode of Preparing Methylamine and Ethylamine, 300
- Trilobites: Larval Form of Triarthrus, C. E. Beecher, 92; the Systematic Position of the Trilobites, H. M. Bernard, 521
- Trimen (Henry, F.R.S.), the Royal Botanic Gardens, Péradeniya, 539
- Tropical Botanic Gardens and their Uses, 453
- Trouton (Fred. T.), Systematic Nomenclature, 148
- Trow (A. H.), Apogamy in *Pteris serrulata* (L. fil.) Var. *Cristata*, 434
- Trunk, Relation of the Length of the, to the Height, Ch. Féré, 520
- Trutat (Eugène), Les Pyrénées, 122
- Tubercle Bacillus, Possible Transmission by Cigars of, Dr. Kercz, 371
- Tubes, on the Motion of Bubbles in, 351
- Tamours, the Parasitic Theory of the Causation of Malignant, J. Jackson Clarke, 502
- Tunicate, the, 179
- Turkestan, the Earthquake of November 5 in Russian, 159
- Turkey, Pasteur Institutes to be established in, 437
- Tusayan Villagers, on the Cardinal Points of the, J. Walter Fewkes, 388
- Tutton (A. E.), the Preparation and Properties of Free Hydroxylamine, 105; the Temperature of Ignition of Explosive Gaseous Mixtures, 138; a New Process for the Preparation of Ethers, 184; a New Sulphide of Carbon, 275; Instrument for Accurately Grinding Section-Plates and Prisms of Crystals, 377; Instrument of Precision for Producing Monochromatic Light of any Desired Wave Length, 377; Iodine as a Base-forming Element, 442; the New Iodine Bases, 467; Further Light upon the Nature of the Benzene Nucleus, 614
- Tyndall (Prof.), Death and Obituary Notice of, 128; Funeral of Prof. Tyndall, 158; Resolution of Condolence of Royal Institution with Mrs. Tyndall, 179; Herbert Spencer, 352
- Typhoons of 1892, the Rev. S. Chevalier, 560
- Ulrich (Dr. F.), Death of, 538
- Ungulates, the, Os Pedis in, Prof. A. E. Mettam, 341
- United Kingdom, Geological Survey of the, Sir Archibald Geikie, F.R.S., 495, 518
- United States: the Pteropod Collections of the *Allatross*, 36; Eighth Report of United States Bureau of Ethnology, 132; U.S. Naval Observatory, Capt. F. V. McNair, 324; Great Storm in United States, 369; Geologic Atlas of, Sheet i., 369; Metrical System adopted by the United States, Henry Gannett, 461; the Pharmacopœia of the United States of America, 525; Mr. F. L. Scribner appointed Government Agrostologist, 605
- Universities: University Intelligence, 22, 45, 70, 92, 117, 139, 166, 283, 329, 352, 376, 401, 422, 448, 471, 497, 546; University of Edinburgh, Recent Benefactions, 252; Report of the Gresham University Commission, 405; University College: Physiological Psychology and Psycho-Physics, 252; Dr. E. B. Titchener, 457; the Teaching University, F. Victor Dickins, 536; the Proposed Reconstruction of the University of London, 558
- Upham (Warren), Glacial Striæ of Somerville, 183; Theory of the Formation of Drumlins near Boston, U.S.A., 207; the Fishing Banks between Cape Cod and Newfoundland, 402
- Urich (F. W.), Centipedes and their Young, 531
- Uropodine, Notes on the, A. D. Michael, 594
- Uschinsky (Dr.), Cultivation of Pathogenic Bacteria in non-Albuminous Media, 83; the Tetanus Bacillus, 84; the Ferment Character of Toxic Products of Pathogenic Bacteria, 208
- Vallot's 1887 Mont Blanc Meteorological Observations, Alfred Angot, 167
- Vanda lutes*, Peculiar Method of the Development of the Axillary Buds of, Henry Dixon, 523
- Vanlair (C.), Chronometric Determinations relating to Regeneration of Nerves, 283
- Vapour Pressure inside Foam, on the Equilibrium of, Prof. G. F. Fitzgerald, F.R.S., 316
- Vapour Pressures, Measurement of Low, J. W. Rodger, 436
- Variable in Andromeda, Anderson's, Prof. E. Pickering, 419
- Variable Star, a New, Rev. T. E. Espin, 67, 184
- Variable Stars, Discovery by Mrs. Fleming of Four New, 608
- Variation of Latitude, the, Prof. S. C. Chandler, 133
- Vatican Observatory, the, R. A. Gregory, 341
- Vault of Heaven, the, Richard A. Gregory, 291
- Veeder (Dr. M. A.), Correlation of Solar and Magnetic Phenomena, 245; Sun-spots and Magnetic Disturbances, 503
- Veley (V. H.), the Interaction of Chlorine and Lime, 118
- Venus, the Planet, 233, 413
- Verney (Sir Harry), Death of, 368
- Verschaffelt (J.), Refractometer applied to Study of Chemical Reaction, 546; on the Phenomenon of Beats in Luminous Vibrations, 617
- Vesuvius, Activity of, 34
- Vibrations, on the Phenomenon of Beats in Luminous, Dr. J. Verschaffelt, 617
- Victoria*, the Loss of H.M.S., Dr. Francis Elgar, 102, 124, 151
- Victoria Institute, 594
- Victoria Regia Tank in the Botanical Gardens, Fauna of the, Frank E. Beddard, F.R.S., 247
- Vignon (Léo), Stability and Conservation of Dilute Solutions of Corrosive Sublimate, 167
- Villard (M.), Hydrate of Nitrous Oxide, 524
- Vinegar-producing Yeast, Dr. Lafar, 183
- Viper-Poison, C. Phisalix and G. Bertrand, 380
- Vis (C. W. de), the Diprotodon and its Times, 159; a Thylacine of Earlier Nototherian Period in Queensland, 264
- Viscous Motion of Ice, John Tennant, 173
- Visibility, on the Minimum Temperature of, P. L. Gray, 618
- Vision with Compound Eyes, Dr. G. J. Stoney, 379
- Vision, Spectacles for Double, T. J. Dewar, 433
- Viticulture; the Propagation of *Pourville* by Storage of Graft-Slips in Moist Sand, A. Prunet, 24; the Grape-Vine Harvest of 1893, M. Chambrelent, 47
- Vivisection; Prof. Frankland's Our Secret Friends and Foes, 34
- Vivisection Bill, the Indian, and the Anti-Vivisectionists, 130
- Vogel (E.), Stas's Determination of Atomic Weights, 283
- Voices from Abroad, Prof. Henry E. Armstrong, F.R.S., 225
- Voie Lactée dans l'Hémisphère Boreale, La, C. Easton, 99
- Volcanoes: Activity of Vesuvius, 34; Prof. Silvestri's Geodynamic Observations of Etna Eruptions of May and June, 1886, 107; Volcano Folk-Lore of India, Dr. V. Ball, 109; Eruption of El Calbuco (Andes), A. E. Noguès, 179
- Vole, Field, the Disappearance of the, Peter Adair, 14
- Vortices, Paired Motion of, with a Common Axis, A. E. H. Love, 499
- Wagner, Bedell, and Miller (Messrs.), New Form of Contact-Maker, 37
- Walden (Dr. Paul), Handbuch der Stereochemie, 409
- Wales, Earthquake in, 34
- Walker (Charles Clement) Prize for Investigation of Cancer, 508
- Walker (Gen. J. T., F.R.S.), Terrestrial Refraction in the Western Himalayan Mountains, 498

- Walker (Mr.), Experiments in Devices for Compensating Hysteresis of Iron used for Measuring Instruments, 205
- Wallace (Dr. Alfred R., F.R.S.), the Recent Glaciation of Tasmania, 3; the Ice Age and its Work, 31, 155; Sir Henry H. Howorth on Geology in Nubibus, 52, 101, 173; Recognition Marks, 53; the Origin of Lake Basins, 197, 220; Darwinianism: Workmen and Work, Dr. James Hutchison Stirling, 333; Social Evolution, Benjamin Kidd, 549; What are Zoological Regions? 610
- Wallis-Budge (E. A., F.S.A.), the Mummy, 97
- Walther (Johannes) Bionomie des Meeres, 244
- Ward (Dr. H. M., F.R.S.), Action of Light on Bacteria, 165, 353; Bacterial Photographs of Solar Electric Spectra, 353; Recent Investigation and Ideas on the Fixation of Nitrogen by Plants, 511
- Ward (Lester), the Status of the Mind Question, 510
- Ward (Rowland), White Rhinoceros in London, 584
- Ward (R. de C.), Thunderstorms, 416; the Study of Thunderstorms in Italy, 423
- Washington (H. S.), the Basalts of Kula, 402
- Wasps, the Reproduction of, Paul Marchal, 47
- Water, Sand Filtration as a Means of Purifying, Mrs. Percy Frankland, 156
- Water-Filtration; the Bacterial Efficiency of Porous Cylinders, Dr. Schäfer, 160
- Water-Power, the Falls of Niagara and its, 482
- Water-Purifier, the Alleged Action of Green Algae on, Prof. Schenck, 182
- Watson (Dr. William, F.R.S.), a Treatise on the Kinetic Theory of Gases, Prof. P. G. Tait, 73
- Watts (W. W.), Ferritic Cracks in Quartz, 547
- Wave-Lengths of the Nebular Lines, Prof. Keeler, 18
- Waves, Best Method of Using Oil in Calming, Dr. M. M. Richter, 488
- Weather, the Moon and, 275
- Weather Lore, Richard Inwards, 217
- Webb (Dr.), Death of, 129
- Webb (Rev. T. W.), Celestial Objects for Common Telescopes, 339
- Webster (Angus D.), Practical Forestry, 526
- Wegener (Dr.), the Chinese Map of Tibet, 275
- Weir (J. Jenner), Death of, 538
- Weismann (Prof.), Rejoinder to, Herbert Spencer, 155
- Weismann, the Spencer-, Controversy, P. Chalmers Mitchell, 373
- Weismannism, an Examination of, Dr. G. J. Romanes, F.R.S., 49, 78
- Weismannism, Biology as it is applied against Dogma and Freewill and for, H. Croft Hillier, 386
- Weiss (Dr. G. A.), Death of, 538
- Webs, the Suspension of Foreign Bodies from Spiders', R. Philipp, 481
- Wells (H. G.), Text-book of Biology, 148
- Welsh (F. R.), the Aurora of March 30, 576
- Werner, (Dr.), Extension of Stereochemistry to Inorganic Elements, 372
- Wernicke (Herr), Vitality of Cholera Organisms on Tobacco, 108
- Wernicke (W.), Normal and Anomalous Changes of Phase during Reflection of Light by Metals, 547
- Weymouth (F. M.), the Construction of Drum Armatures and Commutators, E. Wilson, 478
- Weyr (Prof. E.), Death of, 393
- Wheat-growing in Indiana, 15
- White (A. E. Holt), the Butterflies and Moths of Teneriffe, W. F. Kirby, 384
- White (C. A.), Relation of Fog-Signals to other Sounds, 508
- White (W. H.), Recent First-class Battleships, 490
- White (Mr.), Polymeric Modifications of Acetic Aldehyde, 396
- White Ants, Dr. D. Sharp, F.R.S., 522
- Wiazemski's (Prince Constantine) Journey through Asia, 324
- Wiedemann's Annalen der Physik und Chemie, 46, 117, 239, 376, 449, 547
- Wiesner (Prof. J.), Influence of Artificial Rain on Plants, 253
- Wilde (H., F.R.S.), Magnetarium, 521
- Wilder Quarter-Century Book, the, 362
- Wilks (Dr. S., F.R.S.), Muscular Action the Origin of Music, 271
- Willey (Arthur), *Epigonichthys cultellus*, 423
- Williams (Dr. C. Theodore), the Climate of Southern California, 307
- Williamson (W. C., F.R.S.), Organisation of Fossil-Plants of Coal-Measures, 449
- Willis (J. C.), Gynodiaceism (III.), 167; *Deherainia smaragdina*, 523
- Williston (Prof.), Congenerousness of *Pteranodon*, Marsh, with *Ornithostoma*, Seeley, 109
- Willoughby (Edward F.), Public Health and Demography, 285
- Wilson (E.), the Construction of Drum Armatures and Commutators, F. M. Weymouth, 478
- Wind, the Internal Work of the, Prof. S. P. Langley, 273;
- Wind, the North-East, S. H. Burbury, F.R.S., 481; Prof. T. G. Bonney, F.R.S., 577
- Winder (G.), Synthesis of Piazine Derivatives, 118; Interaction of Benzylamine and Ethylic Chloracetate, 377
- Wines, Discovery of Abrastol in, M. Sangle-Ferrière, 167
- Winograd-ky (M.), a Soil-Microbe assimilative of Atmospheric Nitrogen, 607
- Wires, Torsional Oscillations of, Dr. W. Peddie, 331
- Wistar (Isaac J.), the Postal Transmission of Natural History Specimens, 100
- Wiz (M. Aimé), Problèmes et Calculs Pratiques d'Électricité, Prof. A. Gray, 145
- Wnukow (N.), the Bacilli of Leprosy, 231
- Wöhrmann (Baron von), Systematic Position of Trigonidae and Descent of Nayaalidae, 46
- Wolf (Prof. Rudolf), of Zurich, Death of, 162; Obituary Notice of, 266
- Wollman (Mr.), Projected Arctic Expedition by, 416
- Wolsingham Observatory, Report of the, 300
- Wood, from being Worm-Eaten, Means of Preventing, Emile Mer, 119
- Woodlanders, with the, and by the Tide, 51
- Wooldridge (L. C.), on the Chemistry of the Blood, and other Scientific Papers, 289
- Wright (Prof. G. Frederick), Glacial Erosion in Alaska, 316; Continuity of the Glacial Epoch, 520
- Wundt (Wilhelm), Grundzüge der Physiologischen Psychologie, 311
- Württemberg, Complete Plesiosaurus found at, 271
- Wyhe (M. van), the Ventral Nerves of Amphioxus, 24
- Yeast, Vinegar-Producing, Dr. Lafar, 183
- Yemen, a Journey through the, Walter B. Harris, 291
- Yenisei Region, the Upper, Mr. Kryloff, 230
- Young (Prof. Sydney, F.R.S.), Separation of Three Liquids by Fractional Distillation, 93; Van der Waal's Generalisations regarding "corresponding" Temperatures, &c., 93
- Zaaijer (Prof.), the Sutura Condylo-Squamosa of Occipital Bone of Man and Mammalia, 192
- Zacharias (Dr. Q.), Forschungsberichte aus der Biologischen Station zu Plön, 385
- Zante, in 1893, Velocity of Earthquakes at, Dr. G. Agamennone, 439
- Zenger (C. V.), the Systematic Aplanatic Objectives, 426
- Zittel's (Dr. von) Handbook of Palæontology, 64
- Zoology: Zoological Gardens, Additions to, 17, 38, 67, 84, 110, 133, 162, 183, 209, 232, 256, 274, 300, 323, 349, 372, 396, 419, 441, 464, 489, 511, 542, 562, 585, 608; Zoological Society, 95, 166, 190, 306, 378, 425, 475, 523, 594; Netherlands Zoological Society, 24, 264; the Ventral Nerves of Amphioxus, M. van Wyhe, 24; Scheme for Mapping Geographical Distribution of Vertebrates, Miller Christy, 35; the Zoological Record, R. I. Pocock, 53, 198; F. A. Bather, 53, 198; Dr. P. L. Selater, F.R.S., John E. Marr, 123; the Rise of the Mammalia in North America, Prof. H. F. Osborn, 235, 257; Novitates Zoologicae, 396; Myology of the Hystricomorphine and Sciuricomorphine Rodents, F. G. Parsons, 523; Life and Rock, R. Lydekker, 575; the Naples Zoological Station, 604; What are Zoological Regions? Dr. A. R. Wallace, F.R.S., 610
- Zuntz (Dr.), New Method of Measuring Amount of Circulating Blood, 168; Experiments on Respiration by Skin and Intestine of Horse, 427

## INDEX TO SUPPLEMENT OF JANUARY 18, 1894.

- Ball (W. W. Rouse), an Essay on Newton's "Principia," xii.  
 Bonney (Prof. T. G., F.R.S.), the Story of Our Planet, iii.  
 British Museum (Natural History), Catalogue of the Madreporarian Corals in the, George Brook, Prof. Alfred C. Haddon, ix.  
 Brook (George), Catalogue of the Madreporarian Corals in the British Museum (Natural History), Prof. Alfred C. Haddon, ix.  
 Cambridge: Catalogue of the Egyptian Collection in the Fitzwilliam Museum, E. A. Wallis-Budge, xiii.  
 Cayley (Arthur, F.R.S.), the Collected Mathematical Papers of, Major P. A. MacMahon, F.R.S., iv.  
 Chemistry, Physiological, of the Animal Body, Dr. Arthur Gamgee, F.R.S., Dr. J. S. Edkins, x.  
 Corals, Catalogue of the Madreporarian, in the British Museum (Natural History), George Brook, Prof. Alfred C. Haddon, ix.  
 Digestion, the Physiological Chemistry of, Dr. Arthur Gamgee, F.R.S., Dr. J. S. Edkins, x.  
 Dunmore (the Earl of), the Pamirs, vi.  
 Edkins (Dr. J. S.), Physiological Chemistry of the Animal Body, Dr. Arthur Gamgee, F.R.S., x.  
 Egypt: Catalogue of the Egyptian Collection in the Fitzwilliam Museum, E. A. Wallis-Budge, xiii.  
 Engineering Drawing and Design, Sydney H. Wells, N. J. Lockyer, xiii.  
 Fitzwilliam Museum, Catalogue of the Egyptian Collection in the, E. A. Wallis-Budge, xiii.  
 Gamgee (Dr. Arthur, F.R.S.), Physiological Chemistry of the Animal Body, Dr. J. S. Edkins, x.  
 Geography: the Pamirs, the Earl of Dunmore, vi.  
 Geology, the Story of Our Planet, Prof. T. G. Bonney, F.R.S., iii.  
 Haddon (Prof. Alfred C.), Catalogue of the Madreporarian Corals in the British Museum (Natural History), George Brook, ix.  
 Hoofs, Horns and, R. Lydekker, xiv.  
 Horns and Hoofs, R. Lydekker, xiv.  
 Lockyer (N. J.), Engineering Drawing and Design, Sydney H. Wells, xiii.  
 Lydekker (R.), Horns and Hoofs, xiv.  
 MacMahon (Major P. A., F.R.S.), the Collected Mathematical Papers of Arthur Cayley, F.R.S., iv.  
 Madreporarian Corals in the British Museum (Natural History), Catalogue of the, George Brook, Prof. Alfred C. Haddon, ix.  
 Mathematics: the Collected Mathematical Papers of Arthur Cayley, F.R.S., Major P. A. MacMahon, F.R.S., iv.  
 Natural History: the Catalogue of the Madreporarian Corals in the British Museum, George Brook, Prof. Alfred C. Haddon, ix.  
 Newton's "Principia," an Essay on, W. W. Rouse Ball, xii.  
 Pamirs, the, the Earl of Dunmore, vi.  
 Physiological Chemistry of the Animal Body, Dr. Arthur Gamgee, F.R.S., Dr. J. S. Edkins, x.  
 Planet, the Story of Our, Prof. W. G. Bonney, F.R.S., iii.  
 "Principia," an Essay on Newton's, W. W. Rouse Ball, xii.  
 Story of Our Planet, the, Prof. W. G. Bonney, F.R.S., iii.  
 Wallis-Budge (E. A.), Catalogue of the Egyptian Collection in the Fitzwilliam Museum, xiii.  
 Wells (Sydney H.), Engineering Drawing and Design, N. J. Lockyer, xiii.



# NATURE

A WEEKLY ILLUSTRATED JOURNAL OF SCIENCE.

*"To the solia ground  
Of Nature trusts the mind which builds for aye."*—WORDSWORTH.

THURSDAY, NOVEMBER 2, 1893.

## BRITISH FOREST TREES.

*British Forest Trees.* By J. Nisbet, D.Cec. (London: Macmillan and Co., 1893.)

WITH the exception of Dr. Schlich's able "Manual of Forestry," of which two volumes are now before the public, the English student of arboriculture has for many years past been almost entirely dependent on French and German works for recent information as regards the progress of that part of the art of forestry which deals with the cultivation of our native and introduced trees. The present work is a praiseworthy attempt to remedy this state of dependence, and to provide British foresters with a text-book which shall give the results of modern experience in an English dress.

The plan of the work is simple and to the point. After briefly summarising the history of British forests—too briefly, perhaps, will be the opinion of some—the author proceeds to enumerate the chief forest-trees of our country. To those who miss any reference to some of the minor and unimportant woody plants growing in our hedges, it should be pointed out that the principal forms met with as underwood or coppice are treated separately at the end of the book; while those who feel any surprise at the introduction of several European (but not British) and American trees, especially conifers, should bear in mind that these have been so much planted in England and Scotland of late years, that no work on British forestry can afford to neglect them. Mr. Nisbet seems to have carefully stated what is necessary in this connection.

The next sections of the book deal with the important and very interesting subjects of forest growth in relation to soil, the growth of timber in general, and comparative considerations regarding the growth of forest trees.

It may perhaps be doubted whether the author has succeeded in stating anything new in this connection, beyond what has already been put forward in other text-books, and it is admitted that the sources of the informa-

tion are almost entirely continental, especially German. Perhaps the chief merit of these parts of the book is the author's manner of putting the facts; for, on the whole, they read well and consecutively, and no student of silviculture can fail to profit by them.

Sylviculture—and the same is true of forestry in general—is a subject about which much can be written and said, and the temptation to be prolix is great, with such materials. The author's conscientious acknowledgments of the sources of his quoted tables and experimental data may certainly be put to his credit; and although we may doubt whether any practical forester will accept all the statements unreservedly—for foresters, like farmers, are often somewhat apt to generalise too widely from individual experience in one part of a country—few will deny that Mr. Nisbet has succeeded in putting forward very plainly a large amount of information about the silvicultural aspects of forests in general. The chief fault to be found with this part of the book is, perhaps, that the experience on which the statements are based is almost entirely German, whereas there is really a great deal to be said about the behaviour and treatment of forests in this climate as well.

The principal, and by far the greater part of the book however, is concerned with the treatment of the several species of forest trees in detail. Here, again, the British cultivator will doubtless raise the objection that the author almost entirely confines himself to the experience of foresters in Germany; but it is more and more borne in upon the reader that there is reason in this, in so far that several really great authorities on the cultivation of trees have arisen in that country, whereas it would be difficult to name any in this country.

Be this as it may, there can be no question that Mr. Nisbet has succeeded in collecting a very large amount of valuable information regarding the experience of foresters as to what trees will grow in certain situations, how fast they may be expected to grow there, and how much timber they may be made to yield if properly treated; as to what trees should preferably be grown together in mixed forests, and why such and such mixtures are undesirable; and, further, to what dangers given

species are exposed when grown in quantity, and so forth.

Some of the sections are notably long, and the author gives signs of the discursive habit incidental to those who read and transcribe much from German text-books; moreover, there are sentences which betray the German method in their construction, and there is a distinctly Teutonic sound about some of the terms and short phrases, such as "soil-improving," "free enjoyment of light and air," "above-sketches method," "equal-aged crops," and so on.

With all its faults of diffuse writing, and a certain amount of repetition, the work is likely to be valuable to students of forestry in this country, as setting forth the experience of German and other continental authorities in the growth and tending of mixed and other forests. One or two misprints have come under our notice, e.g. an *f* has dropped on p. 161; and should not "prunosa" (p. 328) be *pruinosa*? Again, why adopt the antiquated term "Scots Pine"?

#### ASTRONOMY OF THE NINETEENTH CENTURY.

*A Popular History of Astronomy during the Nineteenth Century.* By Agnes M. Clerke. Third Edition. (London: A. and C. Black, 1893.)

**D**URING the six years that have elapsed since the publication of the second edition of Miss Clerke's classical history of astronomy, new light has been thrown upon a number of old ideas, and many important discoveries have been made. It became necessary, therefore, for the authoress to revise her work, to add here, and substitute there, and in all cases to incorporate the recently-acquired facts without breach of continuity. There is no suggestion of interpolation, and nothing but praise can be given for the manner in which the selected material has been assimilated.

Attention may be directed with advantage to one or two points. On p. 199 a description is given of the luminous outburst observed upon the sun in September, 1859. The occurrence is supposed to have been followed immediately by a break in the magnetic records at Kew, and every astronomical text-book instances it in evidence of the sun's ability to disturb terrestrial magnetism. Miss Clerke's words with reference to the matter are as follows, the italicised expression being her own:—"At the very instant of the solar outburst witnessed by Carrington and Hodgson, the photographic apparatus at Kew registered a marked disturbance of all the three magnetic elements." Now, at a meeting of the Physical Society in 1886, the late Mr. Whipple said that from an examination of the magnetic curves, he believed "the very slight notch in the record, many similar to which have occurred since, was of an accidental nature, and a mere coincidence." (NATURE, vol. xxxiii. p. 621.) Further, in a letter to the writer of this notice, Mr. Whipple remarked "it was merely an insignificant wriggle of the curves that was recorded at the time of the Carrington and Hodgson observation, and the great

magnetic storm did not commence for some fifteen hours later." Miss Clerke would do well to mention Mr. Whipple's contention in a future edition, and if she will look at the traces and decide the point—accepting Sabine's interpretation of a magnetic disturbance (*Phil. Trans.* vol. cliii. p. 274), she would do a good work. Possibly the coincidence will be disproved before the appearance of the next edition. Tenets of belief accepted quite as implicitly have had to be given up in the interim between the publication of the second edition and the one before us. Thus, in the former edition we read (p. 437) "the conspicuous bright line of the Draco nebula was found to belong very probably to nitrogen"; whereas the present rendering is "the conspicuous bright line of the Draco nebula, although nearly accordant in position with one belonging to nitrogen, has since proved to be distinct from it." But for the suggestion that the chief nebular line had its origin in magnesium, the nitrogen origin would, in all probability, still be accepted. The search for truth initiated by the suggestion, has thus borne good fruit in disposing of the nitrogen-origin "for ever and for aye." One begins to wonder why the idea remained above suspicion for so many years. It is well known that the green line of nitrogen is double, and it now appears that the magnesium fluting is really nearer the true position of the chief nebular line than the nitrogen double. What is more, the magnesium origin was indicated by laboratory experiments, whereas nitrogen had nothing but an approximate coincidence to support it.

In connection with the spectra of nebulae it may be pointed out that no mention appears to be made of the observation of the discontinuous character of the spectrum of the Andromeda nebula (*Roy. Soc. Proc.* vol. xlv. p. 216), and of the white nebula in Draco, G.C. 4058 (*Ibid.* vol. xlvi. p. 219). This is to be regretted, for the observations are of importance, and, in all probability, many of the spectra now classified as continuous are only irregularly so; hence a study of these minute differences of brightness may very considerably add to our knowledge of stellar constitution. We also fail to find a description of Prof. Boys' work on the heat of the moon and stars (*Roy. Soc. Proc.* vol. xlvii. p. 480).

There are seventy-two more pages in the third edition than in the previous one, and five plates have been added. An extremely useful set of tables of astronomical data has also been included. The chronological table has, of course, been brought up to date, and it gives an excellent digest of the work that has been done between March 1774 and April 1893. It can hardly be said, however, that the strict impartiality which should characterise a history of astronomy has been exercised when an event of such local interest as a "Lecture by Dr. Huggins, on Nova Aurigæ, at the Royal Institution," is recorded as having taken place on May 13, 1892, while the announcement on February 8, 1892, of the duplex nature of the lines in the spectrum of the same Nova is unmentioned in the table.

The merits of the volume are now so well known that it is quite unnecessary to expatiate upon them. It seems to us, however, that if Miss Clerke were more a historian and less a partisan, her work would be of higher value.

## OUR BOOK SHELF.

*Inorganic Chemistry for Beginners.* By Sir Henry Roscoe, F.R.S., assisted by Joseph Lunt. (London: Macmillan and Co., 1893.)

Everyone recognises the necessity for having works upon elementary science written by men in thorough touch with their subject. It is with some satisfaction, therefore, that we notice this book, in which Sir Henry Roscoe clearly expounds the elementary principles of chemistry, and describes some of the non-metallic elements and their more important compounds. The book differs from the author's well-known "Lessons in Chemistry" in arrangement and in style, and is far better suited to the tyro in chemistry. In fact, it is adapted to suit the requirements of the syllabus of the Department of Science and Art, and both teachers and students under the Department will benefit by its introduction. There are twenty-one lessons in the book, each complete in itself. At the end of each lesson is a brief summary and a set of questions bearing upon the subjects treated. Believing with all educationalists that principles only become apparent when they are reflected by facts, the author illustrates each step with an experiment. One hundred and eight illustrations elucidate the text, and though many of them are of the ordinary stock character (which is, perhaps, unavoidable in a book of this kind) a fair proportion are from new blocks. In every respect the book is a good one, and contains the kind of knowledge that should be imparted to all beginners of science.

*The Chemistry of Fire.* By M. M. Pattison Muir. (London: Methuen and Co., 1893.)

THE fact that this book belongs to a University Extension Series vouches for the popular character of the contents. Extensionists should welcome Mr. Pattison Muir's contribution to their literature, for it represents the work of a practical teacher, and combines accuracy with simplicity. It is now generally conceded that the best way to teach chemistry is to deal first with common occurrences and things, and finally to generalise. Let a student once obtain a correct notion of the changes of composition that happen in the burning of a candle, and he can comprehend all chemical changes. We therefore commend the book before us to the notice of committees and organisers of technical education, for it contains just the kind of knowledge that should be imparted to all students under their guidance. Like the majority of the volumes in the series to which this one belongs, the illustrations are few and very sketchy. On this account it will be difficult for the home-reader to get a clear conception of many of the experiments.

*Solutions of the Exercises in Taylor's Euclid I. to IV.* By W. W. Taylor, M.A. (Cambridge: University Press, 1893.)

By the publication of these solutions, Mr. Taylor has furthered very considerably the usefulness of the book written by his brother. In the book he has worked out very fully all the problems, and has arranged the text in such a form as to be thoroughly intelligible to any student. Where several problems were of a similar character, it has been thought expedient to adopt a different mode of solution, while in some cases duplicate solutions have been given. Extension of theorems have here and there been inserted, and a few additional exercises will also be found to have been interpolated. By the adoption of a simple notation, reference can be directly made to the problems in the "Pitt Press Euclid." Both teachers and taught will find that they have a very useful companion to the above-mentioned book, while the latter will be very much enlightened in the art of solving many problems.

NO. 1253, VOL. 49]

## LETTERS TO THE EDITOR.

[The Editor does not hold himself responsible for opinions expressed by his correspondents. Neither can he undertake to return, or to correspond with the writers of, rejected manuscripts intended for this or any other part of NATURE. No notice is taken of anonymous communications.]

## The Recent Glaciation of Tasmania.

IN a paper read before the Royal Society of Tasmania in June last, Mr. R. M. Johnston, F.L.S., gives a sketch of what is known of the glaciation of the island, or rather of the western portion of it, for no indications of glaciers appear to have been discovered in the eastern half. This difference is supposed to be due to the fact that on the western side of the island the rainfall is from 50 to 76 inches annually, while in the central valley it is but little over 20 inches. Indications of glaciation among the western mountains were noticed by Mr. Charles Gould, Government geologist, about forty years ago, and from information received from him through the late Chief Secretary of Tasmania, the Hon. J. R. Scott, Mr. Johnston took up the inquiry, and for many years has made explorations in the western plateaus and mountains. Mr. C. P. Sprent was another explorer who published some account of the glacial phenomena in 1886, while more recently Mr. T. B. Moore and Mr. Dunn have recorded similar observations. Mr. A. Montgomery, the present Government geologist, has also just published a paper on the same subject.

Mr. Johnston tells us that he has personally explored the whole of the western mountains, from the Picton and Craycroft Rivers, southern branches of the Huon, in the extreme south, along the mountain ranges forming the western border of the central plateau, quite through to Emu Bay on the north coast; and that he has found the clearest evidences of glaciation in almost every valley throughout this great extent of country. From the Arthur Range in the south to Mount Bischoff in the north, are numerous moraines, *roches moutonnées*, tarns and lakes in great abundance, polished and striated rock-surfaces, and numbers of true erratics. Near the sources of the Franklin River, under Mount Hugel, and only six or seven miles west of Lake St. Clair, are Lakes Dixon and Undine, of which Mr. Johnston writes:—"The valley of Lake Dixon is *par excellence*, the ideal of a perfect glacier valley. No one, however ignorant of glacial action, could in this neighbourhood gaze upon these beautiful scooped, or rather abraded lakes or tarns, the snow-white, polished, billowy, and cascade-like *roches moutonnées*, composed of quartzites, on the upper margin of Lake Dixon, together with the tumbled moraines and large erratics on the lower banks—at a level of about 2000 feet—without being impressed with the idea that its singularly characteristic features must have been produced by the slow rasping flow of an ancient river of ice."

Further north, the Murchison, Macintosh and Huskisson rivers, all branches of the Pieman River, contain similar glacial markings; and Mr. Dunn has recently described others of the same character about Lake Dora, nearer to the west coast. The latter observer lays special stress on the rounded planed and scored rocks, on hard quartzite and conglomerate rocks rounded and polished, on numerous tarns in rock-basins, on moraines covering hundreds of acres, and on numerous huge erratics and perched blocks. (See Annual Report of the Secretary for Mines, Victoria, 1893, p. 21.)

Mr. T. B. Moore states that he found the rocks polished and striated within 25 feet of the top of Mount Tyndall, or 3850 feet above the sea, a sufficient indication that the great central plateau at an average elevation of nearly 4000 feet must have been buried in ice or *névé* to a considerable depth, and have formed the feeding ground for the glaciers, whose effects are so visible in the adjacent western valleys. The Tasmanian geologists are united in the belief that the glaciers never reached the coast or descended much below the 2000 feet level, and that the ice did not extend to the central valley or the eastern side of the island. They therefore speak of it as a *glacier*, not a *glacial* period, the conditions being somewhat similar to those of the Alps at the present time; but, owing to the great difference in the rainfall, there was a more marked contrast between the western and eastern districts, while the lofty central plateau afforded a much more extensive snow-field than Switzerland now possesses.

The facts here stated on the authority of Mr. Johnston, sup-

ported by those of three other observers, two of them being the Government geologists, render more singular the statements of Messrs. Officer and Spencer (NATURE, June 29, p. 198) as to their not finding any traces of glaciation in the country around Lake St. Clair, which they explored for a month. Lake Dixon, which Mr. Johnston describes as presenting all the evidences of glaciation in their fullest development, appears to be less than ten miles from the lower end of Lake St. Clair, according to the best map I can refer to; while Lake Petrarck, which Mr. Officer describes as seeing from the top of Mount Olympus, lies between the two in the Cuvier valley, and is also mentioned by Mr. Johnston as being within the highly-glaciated region. It is quite possible that the lakes on the great plateau may be due to damming up, owing to movements of the superficial gravels and clays by the ice or *névé* sheet; but there are evidently an abundance of small valley-lakes and tarns in the western valleys so surrounded by all the marks of extensive glaciation as to render it almost certain that they are true ice-eroded rock basins. It is much to be wished that a more detailed account of this interesting district, with a good map showing all the mountains, lakes, and valleys referred to, would be given us by one of the local geologists. ALFRED R. WALLACE.

### The Supposed Glaciation of Brazil.

MR. WALLACE observes in his letter on this subject, published in NATURE (vol. xlviii. p. 589), that "no authoritative disproof has yet been given of the exceedingly strong and positive statement of Agassiz and Hartt."

I confess to my mind the matter had seemed disposed of by the interesting discussion of the subject to be found in the "Notes of a Naturalist in South America" (1887), by the late Mr. John Ball, F.R.S. This experienced and accurate observer arrived at the conclusion from a study of the phenomena on the spot, that they could be sufficiently accounted for by subaerial denudation (see, in particular, pp. 313-8).

In the following passage he rejects the agency of glacial action as definitely as his habitual caution and modesty would allow:—

"I was unfortunately not acquainted at that time with the observations made near Tijuca by Prof. Alexander Agassiz, which appear to him to give evidence of glacial action in this part of Brazil. It would be rash, especially for one who has not been able to examine the deposits referred to, to controvert conclusions resting on such high authority; but I may remark that the evidence is confessedly very imperfect, and that the characteristic striations, either on the live rock or on the transported blocks, which are commonly seen in the theatre of glacial action, have not been observed. I lean to the opinion that the deposits seen near Tijuca are of the same character as those described by M. Liais' as frequent in Brazil. The crystalline rocks are of very unequal hardness, and while some portions are rapidly disintegrated, the harder part resist. The disintegrated matter is washed away, and the result is to leave a pile of blocks of unequal dimensions lying in a confused mass." (P. 342.) W. T. THISELTON-DYER.

Royal Gardens, Kew, October 23.

### The Nativity of Rama.

I HAVE been much interested in the letter of "Kanhaiyalal," which appears in your issue of August 31. I fully agree with him in the view taken in regard to the verification of dates by astronomical methods, and it really does seem somewhat singular that the example of Sir William Jones, the pioneer of Orientalism in Europe, should have been entirely neglected by his learned colleagues and successors in this department of research. From many considerations it must be obvious that wherever mention of planetary "yogams" or conjunctions, sidereal and lunar positions, &c., are given in the text of any classical work, they are to be preferred to any arguments drawn merely from literary style and other empirical data—so much relied upon by Orientalists and scholars generally—when the question is one of a calendaric date.

I have endeavoured to work out the calculation of Rama's birth figure. In *Ramayana* is the following *sloka*, or stanza, referring to Rama's birth:—"Chutre navamike tithau Nakshatre aditi daivatye sewochha samsthesu panchasu

<sup>1</sup> See his valuable work, "Climats, Géologie, Faune et Géographie Botanique de Brésil."

*Griheshu karkate lagne.*" From this we learn that Rama was born in the ninth day of the Moon's age, and that five planets were in their exaltation signs, the rising sign (*lagnam*) being Cancer (of the Hindu Zodiac). The planets' places are given in Section 18 of the English translation of *Ramayana*, by Manmatha Nath Dutt, M.A., in the following words:—

"And then, when six seasons had rolled away after the completion of the Sacrifice, in the twelfth month, on the ninth lunar day, under the influence of the Punarvasu asterism, when the Sun, Moon, Saturn, Jupiter, and Venus were at Aries, Capricorn,<sup>1</sup> Libra, Cancer, and Pisces, and when Jupiter had arisen with the Moon at Cancer, Kaushalya gave birth to that lord of the universe, bowed unto by all the worlds, Rama, &c."

It may be well to state for the benefit of those not acquainted with the Hindu zodiac, that an asterism includes 13° 20' of the ecliptic circle, and consequently there are twenty-seven asterisms in all. Of these, Punarvasu is the seventh. The zodiac commences with the asterism *Asvini*, and the fixed star *Revati* is the point from which enumeration of longitude begins. This star is said to have been coincident with the equinoctial point *To* in the year 3600 of the Kali Yuga, *i.e.* 498 A.D.

The last conjunction of Saturn and Jupiter in the sign Libra was in K.Y. 4224, and the one previous in K.Y. 1344; and from this we must subtract three Signs to bring Jupiter into Cancer (its exaltation). This equation referred to the "period" of Jupiter, *i.e.* twelve years, gives three years to be subtracted. The year K.Y. 1341, therefore, would see Saturn in Libra, and Jupiter in Cancer as required.

The Moon being nine days old at the birth of Rama, and its motion in respect to the Sun being 12° per day, its distance from the place of conjunction must be taken as over 96°. But it is stated in the *Sloka* that the Moon is in Punarvasu, and as this asterism ends at 93° 20' from the star *Revati*, it is evident that the conjunction of the luminaries took place in the twenty-sixth degree of *Minam* or Pisces; and that on the ninth day the Moon was in the first degrees of Cancer (Hindu *Kartaka*) and the Sun in the fifth degree of Aries (Hindu *Mesham*).

To determine the date of this planetary epoch we must have recourse to the *Ayauamsha*, the distance between the fixed star *Revati* and the Vernal Equinox. The Hindus compute this to be 54° per year, and in accordance therewith their month of *Mesham* (Aries) begins on April 11. At the present time *Revati* is behind the Equinox, but in K.Y. 1341 it was in front of it, regarded by the order of the Signs. The calculation for K.Y. 1341, according to *Suryasiddhanta*, is:—

$$(3600 - 1341) \times 54'' = 33^\circ 53' 6''.$$

Referring this to the Equinox, it gives a point corresponding to the twenty-seventh degree of Aquarius in our zodiac, which was the point at which the Hindu zodiac began in the year K.Y. 1341; and from this we must take 4' to bring us to the 26th of *Minam*, wherein the Sun and Moon were conjoined at the birth of Rama. The result is the twenty-third degree of Aquarius in our zodiac.

We have already obtained the year K.Y. 1341 from the positions of the planets Jupiter and Saturn, and we may now apply this luni-solar position as a test.

On February 11, 1888, the Sun and Moon were conjoined in the twenty-third degree of Aquarius. This date corresponds to the beginning of the tenth month of the K.Y. year 4989. Applying the Metonic cycle, we find that a conjunction of the luminaries also took place in the twenty-third degree of Aquarius (Hindu twenty-sixth *Minam*) in K.Y. 1341, thus:—

$(4989 - 1341) \div 19 = 192$  exactly. I have not yet made reference to the position of Venus as given in the above *Sloka*, but I think there is strong evidence of this being the correct epoch, and I think it not unlikely that Venus had less than 30° west longitude of the Sun, in which case it would be in the Hindu sign corresponding to our Pisces, *i.e.* *Minam*, as required by the *Sloka*.

This epoch corresponds to noon (local time) February 10, 1761 B.C., disregarding the change of Style; and, if correct, may be the time of the birth of Rama; but on this point I should not care to judge too hastily, for in view of the recurrence of these positions at some earlier or later date, we have no evidence which should lead us to select one rather than another epoch.

One thing strikes me as sufficiently curious to record in

<sup>1</sup> This should be *Cancer*, not Capricorn, as is seen from the fact of the Moon's rising with Jupiter.



this connection, viz. that in Sankaravijaya of Vidyaranya, the same positions are given for the planets at the birth of Sankaracharya, with the exception of the Moon, which is in Ardra, i.e. Gemini, 6° 40' to 20° 0' of the Hindu zodiac. These positions of the Sun, Moon, Jupiter, and Saturn took place on the 1st of Mesham, Kali Yuga 4221, corresponding to March 30, A.D. 1119, without change of the present style.

I am afraid, however, that these dates will hardly suit my Hindu friends, whose devotion to these great personages gives them a sense of "distance" which is best satisfied when expressed in years! I give these notes, however, for what they may be worth.

Adyar, Madras.

WALTER R. OLD.

NOTE.—According to the Suryasiddhanta rules for computing the longitudes of the planets, I find that Mars was in Capricorn, its "exaltation" Sign, in the month of Mesham, K.Y. 1341, as required by the data given for Rama's epoch, its longitude in the Hindu zodiac being Capricornus 13°.—W. R. O.

On the Latent Heat of Steam.

SINCE the invention of M. Berthelot's extremely elegant and simple apparatus, described in his "Mécanique Chimique," vol. i. p. 288, the approximate determination of the latent heat of vaporisation of liquids has become comparatively easy. The exact evaluation of the correction due to the heating of the calorimeter from extraneous sources is, however, a matter of considerable difficulty with the original form of apparatus. The correction is necessarily calculated from data supplied by the thermometric observations made previously to, and after, the actual condensation of the liquid has taken place. For this calculation to be as simple and satisfactory as possible, it is essential that during the whole experiment the temperature of the bodies in the immediate neighbourhood of the calorimeter shall remain approximately constant. In M. Berthelot's method of determination this condition is however not strictly fulfilled. For during the "preliminary period," although the flame is lighted over the calorimeter, the liquid in the flask has not yet begun to boil, so that the radiation to the calorimeter varies, and during the "final period" the flame is extinguished and no further heat reaches the calorimeter from this source. Also during the beginning of the "middle period," a considerable amount of liquid which has been volatilised from the flask at a temperature below its boiling-point, reaches the worm and is there condensed. We therefore modified the apparatus in such a way that the flame was at a constant height and the liquid was boiling during the whole time of the experiment, including both the preliminary and final periods. We found that under these circumstances, with a rise of 3° or 4° in ten minutes, the Regnault-Pfaundler correction is perfectly accurate. We propose shortly to publish a complete description of our apparatus, and shall not therefore go into details at present. It differs mainly from that of M. Berthelot, by the insertion in the interior of the boiling flask of a glass valve, which is opened when the rise of the thermometer in the calorimeter has become steady, and closed when sufficient liquid has been condensed in the worm. The vapour during both the preliminary and final periods passes into a reversed condenser.

Our main reason for this communication is to record the somewhat remarkable results obtained with water, and to ask if any of your readers can give information as to any accurate work upon the latent heat of steam published since that of Regnault (*Mémoires de l'Académie des Sciences*, t. 21) in 1847.

We give the results of five experiments (done at pressures differing but little from 760 mm.), which are still subject to certain corrections not exceeding ± 1 unit.

|     | Wt. of water condensed in grams. | Time of condensation in minutes. | Rise of temp. in calorimeter in deg. C. | Latent heat of steam (L). |
|-----|----------------------------------|----------------------------------|-----------------------------------------|---------------------------|
| (1) | 10.122                           | 7½                               | 3.491                                   | 525.6                     |
| (2) | 12.546                           | 15                               | 4.416                                   | 524.7                     |
| (3) | 9.278                            | 8                                | 3.235                                   | 526.6                     |
| (4) | 9.854                            | 7                                | 3.439                                   | 525.0                     |
| (5) | 2.742                            | 6                                | .991                                    | 523.9                     |

It will be noticed that in experiment 5, where the amount of water condensed was purposely reduced, so as to increase as far as possible the experimental error, the result obtained differs but slightly [from the mean. This mean, 525.2 (omitting experi-

ment 5, 525.5) is over 2 per cent. lower than that of Regnault. The thermometer used was one divided into fiftieths of a degree, by Baudin, and was compared with a thermometer calibrated at the International Bureau of Weights and Measures. Every precaution was taken to ensure accuracy of reading.

We have sought for confirmation of our results in the indirect determinations of other observers. If we insert the latest values for the specific volume of steam at 99.6° given by Perot (*Ann. Chim. et Phys.* [6] 13, p. 159) and for the mechanical equivalent of heat by Griffiths<sup>1</sup> (*NATURE*, vol. xlvii. p. 476) in the thermodynamic formula,

$$L = \frac{T}{J} (S - S') \frac{d\hat{p}}{dt}$$

we find the number 527.43 for the value of L at 99.60° C.<sup>2</sup> The number given by Regnault for 100° C. is 536.7. We have also selected from the numerous results obtained by Joly (*Proc. Roy. Soc.* vol. xli. p. 358) with his steam calorimeter those relating to silver, which is a substance easy to obtain in a state of purity. If we take the number given by Regnault for the specific heat of silver, we find his own determination of the latent heat of steam confirmed. On the other hand the concordant numbers for the specific heat of silver, given independently by Kopp and Bunsen, lead to a result about 1½ per cent. lower than that of Regnault.

The complete discussion of such results, however, is a matter of great difficulty owing to the uncertainty which prevails with regard to the specific heat of water. We have not as yet succeeded in discovering any constant error capable of explaining the discrepancy between our result and that of Regnault, but further experiments are now in progress.

The question, as need hardly be pointed out, is of considerable practical importance in connection with problems relating to the steam engine.

P. J. HARTOG.

J. A. HARKER.

Physical Laboratory, Owens College, October 19.

Artificial Amœbe and Protoplasm.

IN No. 1251 of NATURE, Dr. John Berry Haycraft has written a review on Prof. O. Bütschli's investigations of microscopic foams and protoplasm.

The biological parts of the contribution I may leave my colleague, Prof. Bütschli, to answer, but as my investigations are also mentioned, and my name several times quoted, though always mis-spelled as "Nuincke," instead of Quincke, I may perhaps be allowed to call attention to the fact that I, not Prof. Bütschli, as the reviewer asserts, was the first who tried to explain the movements of amœbæ and protoplasm by physical laws, by the periodical spreading of a soap solution. In 1879 I explained the voluntary formation of an emulsion observed by Prof. Gad, and the amœboid movements of oil-drops by the periodical spreading of a soap solution upon the common surface of oil and water, and I said "that foam is an emulsion of air instead of oil, and that the durability of foam depended on the same conditions as the durability of an oil emulsion."<sup>3</sup> In a continuation of these investigations I explained in the year 1888 the movements of protoplasm by the same physical principles, making the supposition that it was intermixed with thin oil-films, and in the cells of plants, surrounded by an oil-coat.<sup>4</sup> I there fore believe I was the first to point to the foamy structure of protoplasm, which was later on further investigated by Prof. Bütschli.

Is Dr. John Berry Haycraft acquainted with my investigations, and from whence does he deduce the right of calling them "toys for the physicist"? They form the conclusion of a series of researches on capillarity which I began 37 years ago, and by which I, for the first time, showed that surface-tension is considerably altered by layers of a foreign substance of far less thickness than 1, 10, of a light-wave; for the first time, also, the

<sup>1</sup> We understand that Mr. Griffiths' number is still subject to a slight correction, but that this does not amount to 1 part in 1000.

<sup>2</sup>  $\frac{d\hat{p}}{dt}$  was calculated from Roche's formula quoted by Hirn, *Théorie Mécanique de la Chaleur*, t. I. p. 375.

<sup>3</sup> G. Quincke, "Ueber Emulsionsbildung und den Einfluss der Galle auf die Verdauung" (*Pflüger's Archiv*, 1879, p. 144).

<sup>4</sup> G. Quincke, "Ueber periodische Ausbreitung an Flüssigkeitsoberflächen und dadurch hervorgerufene Bewegungserscheinungen" (*Sitzungsber. der Berliner Akad.* 12, 7, 1888. *Wiedem. Ann.* 35, p. 580-642, 1888). "Ueber Protoplasma bewegungen und verwandte Erscheinungen" (*Tageblatt der 62. Versammlung Deutscher Naturforscher und Aerzte*, Heidelberg, 1889, p. 264-7).

sphere of molecular action was measured exactly. A number of physical problems were treated, with which in England Lord Kelvin, the late Prof. Clerk Maxwell, Prof. Reinold, Prof. Rücker, Lord Rayleigh, and others have also occupied themselves. The criticism therefore seems not justified.

I know very well that in Germany several representatives of the descriptive natural sciences do not agree with my views about the structure and the movement of protoplasm. For instance, Prof. Pfeffer<sup>1</sup> reproached me with "having, without deducing my views from admissible foundation on experience in organism, exclusively constructed them by physical experiments, and thereupon demanded, in an unwarranted manner, a periphtric oil-layer for protoplasm."

Here, too, let me remark, that I concluded the existence of this periphtric oil-layer from the globular form of the surface of protoplasm in plasmolysed cells and that I tried for months to find in living cells the characteristic periodic spreading, suspected by me, on the inner side of the hypothetical oil-layer. I have several times observed this spreading and the destruction of the globular form caused thereby. The observations of living cells have led me to fresh physical experiments, which I published in the year 1888, together with my theory of the structure and movement of protoplasm. These theories I have always found corroborated in the continuation of my researches since 1888. My adversaries, on the contrary, have as yet not given a satisfactory physical explanation for the above stated phenomena, the globular form of protoplasm surface and the movements in the vicinity thereof. Up to the present day I believe my views to be correct and irrefuted.

The facts observed and the physical conclusions inferred by me, may appear extraordinary and not very intelligible to another science, but they are none the less correct and useful. Biological science must, well or ill, take into account the fact that the development of the cell and the life of the organic nature depends on masses and layers which cannot be perceived by the microscope alone.

Heidelberg, October 22.

GEORG QUINCKE.

#### Human and Comparative Anatomy at Oxford.

IN the article which appeared in your last number under the above heading, expressions occur which may, I think, lead to misconception as to the position of the department of Human Anatomy. It is of such importance in the interest of scientific medical education that the academical teaching of human anatomy should *not* consist merely in "technical training in anthropotomy," that I cannot allow the statement that the teaching of the subject in Oxford is of this nature to pass without comment. Had the writer of the article in question taken the trouble to inquire of the University lecturer here, or of any of the University professors of human anatomy elsewhere, for instance at Cambridge, Edinburgh or Dublin, or had he consulted any of the leading text-books of the subject, he would have found that its scope is much more extended than he supposes. The misstatement having been made, however unintentionally, must be corrected.

Let me add that the department, which was founded in 1885, was not connected in its origin with the department of Comparative Anatomy, and has had no relation whatever with it since.

J. BURDON SANDERSON.

#### Asymmetrical Frequency Curves.

OWING to the haste with which I looked through the proof of my letter in last week's NATURE (p. 615) two slips escaped me, which I hasten now to correct. The ordinates in the diagram should have been marked

$$\frac{a^n}{c}, \frac{an^{n-1}}{c}, \frac{an(n-1)^{n-2}}{1.2.c}$$

&c., the factor  $\frac{1}{c}$  having been dropped. Further, the value for  $c$  should have been

$$c = \frac{\sqrt{2(\mu_2 - \mu_1)\mu_3 + 3\mu_1^2}}{\mu_2 a}$$

my  $a$  having been converted into a square power.

The method applied to Dr. Veau's curve fits it with an accuracy only surpassed by the generalised probability curve itself.

KARL PEARSON.

University College, October 28.

<sup>1</sup> Pfeffer, "Zur Kenntniss der Plasmahaut und der Vakuolen" (*Abhandl. Leipziger Akad. math. phys. Klasse*, 1890, xv., p. 270).

#### Telegony.

AS already stated in my previous letter, I have discussed this subject in my recently published "Examination of Weismannism" more fully than in NATURE. If "M. D. H." (NATURE, October 19) will consult the reference given in that letter to this work, he will find the facts to which he directs my attention are there given, together with certain reasons for concluding that they do not materially affect the point in question.

Hyeres, October 26.

GEORGE J. ROMANES.

#### AN ORNITHOLOGICAL RETROSPECT.

DURING the year 1892 there were at least three publications which are of great value to ornithologists, though from somewhat different points of view. They are Prof. St. George Mivart's little work on the "Elements of Ornithology,"<sup>1</sup> Dr. Gadow's "Classification of Birds," published in the Proceedings of the Zoological Society, and Capt. Bendire's "Life-Histories of North American Birds."

To thoroughly appreciate the value of Prof. Mivart's "Elements" one has to be the curator of a museum. Many people, like myself, must have been puzzled by the frequent demand for an elementary, but comprehensive book on birds, such as a man can carry with him on his travels, and many people about to journey abroad have asked me for a small book which would explain to them what certain birds were like. I prophesy that Prof. Mivart's book will make many collectors, and its handy size is one of its best features. There have been many introductory works on ornithology published in this country and America, notably those of Prof. Elliott Coues, but nearly all of them are too bulky, and that is the fault with the most popular works, such as the "Standard Natural History" and Cassell's "Popular Natural History." Commencing in an easy and unconstrained manner, Prof. Mivart in his Introduction leads his pupil on through the various forms of bird-life, his object being not to weight the tyro with too heavy material for study at starting. All the leading Avian types are passed in review and they are illustrated by some admirable woodcuts by Mr. Keulemans, drawn especially for the work. It is, therefore, possible for any one to understand what a particular form of bird is like, the only drawback to this mode of illustration being the impossibility of illustrating the subjects on the same scale, so that some of the smaller forms appear to be larger than they really are in comparison with the bigger birds. This was, however, unavoidable.

Three chapters (pp. 134-234) are devoted to the anatomy and osteology of birds, and a fifth chapter deals with their geological and geographical relations (pp. 235-250). That on the "Classification of Birds" summarises the chief characters for each order, sub-order, and family, and lastly there is an enumeration of the genera with the number of species in each. This is of course mainly derived from the British Museum "Catalogue of Birds," and I find that on adding up Prof. Mivart's figures, the number of known species is 11,900. The last time that a computation of the number of birds was made was in 1871, when the late Mr. G. R. Gray finished his "Handlist of Birds," and admitted 11,162 species as then known. This was probably a correct estimate, as I have generally found that the "Handlist" contained about enough false species to counterbalance the number of species described since the work was issued. For similar reasons, Prof. Mivart's estimate of 12,000 species will turn out to be approximately correct, and then by adding the number of species described since his book was published, and others discovered since the issue of the "Catalogue of

<sup>1</sup> St. George Mivart, "Birds: The Elements of Ornithology." 8vo, pp. vi.+329. (London, 1892.)

Birds," we may fairly consider that about 12,500 species of birds are known to exist at the present day.

Dr. Gadow's "Classification of Birds" is based on very careful and exact study, and certainly carries this perplexing subject several steps further as regards the higher groups. There is now a good opportunity for any naturalist, working on the same exhaustive lines, to give us a classification of the Passeries, and it is to be hoped that Dr. Gadow will some day be induced to take up this study. In my address to the Ornithological Congress at Budapest in 1891, I advocated the employment of every external and internal anatomical character, as well as the nesting habits and the geographical distribution, for the achievement of a natural classification. Dr. Gadow has not only worked upon the same lines, but has further personally examined the anatomical features on which his classification is mainly based, and he has selected some forty characters, which he considers to be of essential value in determining the various orders and families. Dr. Shufeldt will doubtless not agree with the author's conclusions regarding the *Macrochires*, and it seems to me somewhat strange to find the Hornbills allowed no higher rank than as a sub-family of the *Upupidae*, while the position of the *Striges* in the *Coraciiformes* will doubtless excite a good deal of criticism. There can, however, be no question that the amount of work which Dr. Gadow has managed to compress into some five-and-twenty pages will be found to contain some highly original ideas, and such as must materially influence the mind of the next worker on the classification of birds.

The third work alluded to above is the "Special Bulletin" of the U.S. National Museum, a goodly 40 volume of 416 pages, with 12 coloured plates of eggs. The figures are beautifully rendered by chromolithography, and the publication is altogether a notable one. The letterpress is the work of Capt. Charles Bendire, who is known to be one of the most practised oologists of the present day. He has described and figured in the present volume the eggs of all the North American game-birds, pigeons, and birds of prey, and he has used his opportunity to the greatest advantage by giving an excellent account of the life-histories of the species, together with the latest information respecting their geographical distribution. Capt. Bendire's work forms one of the most important of the recent contributions to ornithological knowledge, and the succeeding volumes will be awaited with eagerness by ornithologists.

The issue of several good faunistic works on various parts of the British Islands, brings within measurable distance the time when it will be possible to take a detailed review of the ranges and occurrences of the birds which inhabit the above-mentioned area. Some of the books alluded to are of the lighter kind, like Dr. Hamilton's "Riverside Naturalist,"<sup>1</sup> and Mr. John Watson's "Poachers and Poaching,"<sup>2</sup> wherein the authors relate their own personal experiences of animal and plant life. In Dr. Hamilton's book the birds occupy nine chapters (pp. 21-165), and he gives a series of chatty and well-written notes, giving quite a full review of the birds which come under the notice of the fisherman or stroller on the river's bank. The book is a pleasant companion for a holiday outing, and it is a pity that the illustrations are not more up to the mark, for M. Robert's woodcuts are not worthy of insertion in any book which pretends to scientific accuracy, as they are evidently drawn from stuffed birds, and in some cases it is impossible to tell what they are meant for, the illustration of the "redbreast" on p. 105 being equally suggestive

of a black redstart, while the sparrow-hawk's head on p. 153 is certainly that of a cuckoo!

Mr. Watson's collection of essays, gathered from several publications, is very good reading, and ranges over a wide field of subjects, with some of which "poaching" has nothing to do. As is inevitable in a series of articles contributed to different publications, the author travels over the same ground more than once in the course of the book, but the latter is always readable, and when Mr. Watson writes from his own first-hand experiences, he tells his story as a field naturalist should. In some of the remarks which he makes, however, we notice that he does not always acknowledge the source of his inspiration.

Some of the faunal works issued during the last year or two have been of special excellence, especially those published by Mr. David Douglas, of Edinburgh, which deal with the Zoology of Northern Britain. One of the most interesting of these is the "Birds of Iona and Mull," edited from the MSS. of the late H. D. Graham by Mr. J. A. Harvie-Brown. The work was originally edited by the late Robert Gray, the well-known author of the "Birds of the West of Scotland," whose appreciative preface is also given in the work; but he did not live to see its publication. The volume consists firstly of letters sent by Graham to Robert Gray, not only from Iona, but from his later home at Littlehampton, in Sussex, where his references to shooting at Pagham must kindle remembrances in a few of us who can still call to mind collecting in that fine old haunt of the naturalist. After some "extracts from diaries," a list of the birds of Iona and Mull is given. The book is enlivened throughout by sketches by the author, illustrating the wild country in which he lived, and the shooting experiences so well related in its pages. These little sketches are spirited and amusing enough, though sometimes the sportsman seems to be firing "in among the crowd" of his companions in the boat. From the usual position of the gun, the little dog—who was Graham's constant companion in his collecting-trips—must have had some narrow escapes, and perhaps that is why the last picture in the book represents the dog's tombstone.

Another of Mr. Douglas' excellent publications is the "Vertebrate Fauna of the Orkney Islands," by Mr. T. E. Buckley and Mr. J. A. Harvie-Brown. The birds occupy the bulk of the volume (pp. 91-264, app. pp. 297-302), and are treated in a very full manner, as might have been expected from the well-known reputation of the authors. The natural history of the Orkneys has been several times chronicled, the best-known works being those of the Rev. George Low, who wrote about 1770. and of Messrs. Baikie and Heddle, in 1848. The list of writings relating to the natural history of the islands, as given by Messrs. Buckley and Harvie-Brown, is considerable, and some excellent photographs of scenery are given, in addition to some spirited pictures of bird-life by Mr. J. G. Millais. The above-named authors have also published, in 1892, a "Vertebrate Fauna of Argyll and the Inner Hebrides," which forms a companion volume to the "Fauna of the Orkneys" and the other works on Scottish Natural History published by Mr. Douglas.

To Mr. R. H. Porter we are indebted for the publication of some very useful contributions to British Ornithology. In 1891 was published Mr. Borrer's "Birds of Sussex,"<sup>1</sup> with six beautiful coloured plates by Keulemans, illustrating the Gyrfalcon, the Honey Buzzard, the Rufous and Aquatic Warblers, the Nutcracker, and the Squacco Heron, all rare visitors to Sussex and the British Islands generally. Mr. Borrer is one of the old school of ornithologists, and has been an esteemed correspondent of

<sup>1</sup> "The Riverside Naturalist. Notes on the various forms of life met with either in, on, or by the water, or in its immediate vicinity," by E. Hamilton. 8vo. pp. i.-xviii. 1-401. (London, 1890.)

<sup>2</sup> "Poachers and Poaching," by John Watson. 8vo. pp. i.-viii. 1-326. (London, 1891.)

<sup>1</sup> "The Birds of Sussex." By William Borrer. 8vo, pp. xviii, 385, pls. i.-vi. with map. (London: R. H. Porter, 1891.)

all the well-known writers on British birds during the past fifty years, from Yarrell downwards. His notes range over a number of years, and, from his long experience as a collector, he has been able to write an exhaustive list of the birds of Sussex, on which he is undoubtedly the best living authority. Mr. Pidsley's "Birds of Devonshire"<sup>1</sup> is also a useful contribution to our local knowledge, and is accompanied by an excellent coloured figure of the Buff-backed Heron in breeding plumage, in which state, however, it does not appear to have been met with as yet in Devonshire. Mr. Pidsley's book, however, is eclipsed in size and importance by another work on the ornithology of the same county by Mr. D'Urban and the Rev. Murray A. Mathew.<sup>2</sup> Both these gentlemen have long been known as workers at the statistics of Devonshire birds, and the accounts of the species are very complete as regards their distribution in the county. A very good notion of the geography and natural features of the district is added, and some photographs of Lundy Island and other noted haunts of birds are given, as well as coloured plates, by Keulemans, of the Black Redstart, Montagu's Harrier, and a dark variety of the Rough-legged Buzzard, as well as the Great Black-backed Gull, which is one of the rarities contained in the Albert Memorial Museum at Exeter. It is a little curious that neither Mr. Pidsley nor the authors of the larger work on the "Birds of Devon" allude to the Montagu specimen of the Gull-billed Tern, which received its name of *Sterna Anglica* from the author of the Ornithological Dictionary. The specimen was taken in Sussex, and is still in the British Museum, having so far survived the decay which has overtaken a considerable portion of the Montagu collection. Several specimens from the latter no longer exist, having no doubt perished in the course of years, as none of them seem to have been properly preserved, and in most cases still have the bones of the trunk inside them. In addition to the list of the British-killed examples of the Gull-billed Tern in summer plumage, we may add to the enumeration given by Messrs. D'Urban and Mathew a beautiful bird in the British Museum from Christchurch, presented by Baron A. von Hügel.

Mr. D'Urban adds some tables showing the lines of migration of birds across Great Britain, opening up a new and fascinating branch of ornithological study to English readers.

The most recent addition to our local Avifaunæ is Mr. Whitlock's "Birds of Derbyshire,"<sup>3</sup> which is on the plan of similar works issued of late years, giving a county map and photographic illustrations of the most salient features of the district treated of. Derbyshire is a most interesting county, as it comprises within its area so many different kinds of country, each with varying characteristics. The notes on the migration of birds are good, as are also the accounts of the Ring Ouzel, Dipper, Pied Fly-catcher, and other birds which frequent the famous peak.

Amongst other books of interest to the student of British Ornithology may be mentioned a popular edition of the St. John classical work, "A Sportsman's and Naturalist's Tour in Sutherlandshire." Mr. Winttingham's "Key to the Classification of British Birds" is a small book, which gives tables of the orders, families, and species of birds inhabiting the British Islands; but it

should have been called a "List" not a "Key," as there is not a single character given whereby a species may be distinguished. When a complete analysis has to be made of all the works which deal with British Ornithology, so as to illustrate by statistics the distribution of birds throughout Great Britain, Mr. Miller Christy's little "Catalogue of Local Lists of British Birds" will be found most useful.

A recent reviewer has stated in the columns of a leading London paper, that ornithologists are the only people to whom, in the present day, the "insulting character of Dr. Dryasdust is applicable," that they, as a body, take no interest in any problems connected with the past history or evolution of birds, "like Gallio, caring for nothing of these things, and, like Gallio, acquiring a considerable reputation by their attitude!" No wonder that, to this reviewer, the volumes of the British Museum "Catalogue of Birds" appear "most terrible publications." To understand the latter a man must be an ornithologist, which the writer of the above-quoted nonsense evidently is *not*. A direct contradiction to the sage declarations of the reviewer is given by glancing at the list of ornithological works of the year 1892, when it will be seen that in every branch of the subject considerable progress has been made, and that this country is by no means behind the rest of the world, either in the number or the quality of its productions. Lord Lilford has continued his beautiful coloured figures of British birds, a work now hastening to a successful issue, and accompanied by a series of short but entertaining notes, based upon the author's wide experience as a field naturalist in younger days. On the Continent, some of the results collected from the various stations of observation in the different countries, and summarised by Drs. Meyer and Helm, Dr. von Middendorff, Mr. Winge, and others, are bound to form an important basis for reliable conclusions when a new history of European birds has to be written. One of the most complete of these summaries is to be found in Prof. Giglioli's third and concluding volume on the Italian ornis.<sup>1</sup> In this volume Dr. Giglioli summarises the general results of the observations of the corps of auxiliary naturalists who have helped him with statistics, and the migrations of birds are treated of under various headings and according to localities, while the notes on nidification of Italian birds and their food are also classified, a copious index enabling the crowd of facts relating to each species to be easily found. Four parts of the large folio work on the birds of Italy were also published in 1892 by Dr. Giglioli, with coloured figures by Signor A. Manzella.

Dr. Pleske's great work on the ornithology of Russia is making progress, and considerable addition to our knowledge of the Avifauna of Thibet and Mongolia has been achieved by the Russian travellers Grum-Grzimalo and the expedition of Prince Henri of Orleans and M. Bonvalot.

In Ethiopian ornithology there are several interesting events to chronicle. Prof. Barboza du Bocage has published a supplement to his "Ornithologie d'Angola," embodying the results of recent exploration in that province, and bringing the work up to date. The collections made by Señor Francesco Newton, for the Lisbon Museum, in the island of St. Thomas, have also been described by Prof. Bocage, and some interesting new species discovered. The writer has finished the description of Mr. F. J. Jackson's collections, formed during the latter gentleman's journey to Uganda, and Mr. H. H. Johnston, C.B., has sent several consignments from Nyassa Land, where he has an experienced naturalist, Mr. Alexander White, working for him. The visit of the

<sup>1</sup> "The Birds of Devonshire." By William E. H. Pidsley. Edited, with an introduction and short memoir of the late John Gatecote, by W. A. Macpherson. 8vo, pp. xxx. 191. 1 plate and map. (London and Exeter, 1891.)

<sup>2</sup> "The Birds of Devon." By W. S. M. D'Urban and Rev. Murray A. Mathew. With an introduction, and some remarks on the migrations of Devonshire birds. Pp. lxxviii. 453. Plates lxx. With three maps. (London: R. H. Porter, 1892.)

<sup>3</sup> "The Birds of Derbyshire." By F. B. Whitlock. Annotated with numerous additions by A. S. Hutchinson. Pp. vi. 243. (London and Derby, 1893.)

<sup>1</sup> Giglioli, E. H. "Primo Resoconto dei risultati della Inchiesta Ornitologica in Italia." Parte Terza ed. Ultima. "Notizie d'Indole Generale, Migrazioni, Nidificazione, Alimentazione, etc." 8vo, pp. vii. 518. (Firenze 1891.)

latter to the Milanji mountains resulted in the discovery of several new species, allied representatives of others inhabiting Kilimanjaro, Elgon, or even the Camaroon peaks. The collections made by Emin Pasha and Dr. Stuhlmann in Uganda resulted in the discovery of some interesting novelties, which have been described by Dr. Reichenow, at Berlin, who has also received some important collections from the Camaroons, from Dr. Preuss, and from Togoland. Mr. Johnston, at the present moment, appears to be the only patriotic Englishman who is taking pains to explore the natural history of the countries under his rule, whereas the Germans seem to have in every one of their "spheres of influence" and protectorates some well-informed naturalist who occupies himself with the natural history of the district.

The Indian region, formerly the scene of so much ornithological activity, seems, during the last few years, to have passed into a quiescent stage, and the principal work is now being done by Mr. Hose and Mr. Everett in Borneo, and Mr. Styan in Southern China. Dr. Modigliani's collections, from the Island of Nias, were described last year by Count Salvadori, and showed that some of the species found by the traveller were akin to those of the Nicobars, while, curiously enough, others were allies of Bornean forms rather than Sumatran, though the latter affinity would have been expected. The death of Mr. Davison, at Singapore, has deprived us of one of the best-known Indian naturalists. His explorations in Tenasserim gained him immortal fame as a collector, and, had his health been stronger, he would no doubt have continued his researches into the natural history of the Malay Peninsula, where much still remains to be done. His last expedition to Pahang resulted in the discovery of a very fine new starling (*Æthiopsar torquatus*).

Dr. A. B. Meyer, who has identified himself with the pursuit of Natural History in New Guinea and the Moluccas for many years, has received some collections from Kaiser Wilhelm's Land in north-eastern Papua, wherein have been some interesting new species, while in the southern portion of the great island Sir William McGregor has discovered some extraordinary new forms of birds, one of which, *Paramythia*, is such a puzzle that no one has been able to define its place in the natural system with any confidence. The completion of Count Salvadori's "Uccelli di Papuasie e delle Molucche" marks an epoch in the history of Austro-Malayan ornithology, and this wonderful work with its appendices will remain for ever a monument to its painstaking and accomplished author.

In Australia the most notable work of recent years has been Mr. A. J. North's description of the nests and eggs of the birds inhabiting that continent.<sup>1</sup> This book not only contains a vast amount of additional material on the nesting-habits of Australian birds, but is accompanied by photographic illustrations of the eggs, while a few coloured copies have been prepared, one of which has been sent to the Natural History Museum. An appendix describes the nests and eggs of the birds inhabiting Lord Howe and Norfolk Island.

In New Zealand Sir Walter Buller has been assiduously collecting additional notes to supplement his recently completed work on the birds of that country, and Prof. Hutton has given some notes on the Moas, which will have to be critically compared with Mr. Lydekker's recent determinations of these struthious birds. By far the most interesting event, however, of recent years has been the discovery by Mr. H. O. Forbes, the celebrated Malayan traveller, of the remains of *Aphanapteryx* in the Chatham Islands. *Aphanapteryx* was previously known only as a former inhabitant of the Island of

Mauritius, and the discovery of identical remains in a locality so far distant as the Chatham Islands, has opened up possibilities of speculation of the most intense interest, and Mr. Forbes' recently exploited theory of the former existence of a great Antarctic continent has changed the ideas of many zoologists with regard to the origin and geographical distribution of many forms of animals and plants. It is decidedly the most interesting episode of the year 1892.

Polynesian ornithology has undoubtedly been forcibly brought before our notice by the careful work which has been done by Mr. Wigglesworth, in his "Aves Polynesie," and a complete list of the species inhabiting the Pacific Islands, with their synonymy and geographical distribution, has been published in the "Abhandlungen" of the Dresden Museum, under Dr. A. B. Meyer's care. Mr. Scott Wilson, with the help of Mr. Evans, has reached the fourth part of the "Aves Hawaienses,"<sup>1</sup> and with one more part the work will be brought to a conclusion. Mr. Wilson gives some interesting notes on the habits of the species, but it is doubtful whether he has obtained all the material necessary for a monograph of the Hawaiian Avifauna, judging by the number of new species which the Hon. Walter Rothschild has been receiving from his collector, Mr. Palmer. These may, of course, be included in the final part of the work, thus bringing it up to date. A visible improvement is to be noticed in the plates of Mr. Frohawk, and the coloured figures of the species look something like the actual birds, instead of being a sort of map, as heretofore.

Except for the splendid paper by Dr. Gadov, before mentioned, on the classification of birds, very little anatomical work has scarcely been done, in England at least; and it is to be hoped that Mr. Beddard, who has before now written some useful ornithological papers, and on whom the mantle of Garrod and Forbes is supposed to have fallen, will give us some further results from the splendid opportunities which he enjoys as prosector at the Zoological Gardens.

R. BOWDLER SHARPE.

#### HENRY OLDENBURG, FIRST SECRETARY OF THE ROYAL SOCIETY.

"SIR, you will please to remember that we have taken to taske the whole Vniverse, and that we were obliged to doe so by the nature of our Dessein. It will therefore be requisite that we purchase and entertain a commerce in all parts of ye world w<sup>th</sup> the most philosophical and curious persons, to be found everywhere." So writes Henry Oldenburg to Governor Winthrop of Connecticut on October 13, 1667. And in these words he briefly expresses what was the chief aim of the best years of his life. It was mainly by his immense correspondence that Oldenburg forwarded the cause of science, or, as it was then called, of the "new experimentall learning," by that and by his assiduous discharge of secretarial and editorial work. Without being a man of brilliant genius, he was just such an intelligent, reliable, energetic, and conscientious worker as was needed at that time to form a centre for the new movement. In the history of literature Henry Oldenburg is a familiar figure as the friend and correspondent of Milton; in the history of philosophy, as the friend and correspondent of Spinoza; but neither literature nor philosophy is indebted to him to the same extent as science.

It is somewhat remarkable that, although the name of Henry Oldenburg is so familiar in the history of the seventeenth century, no complete life of him has ever been written. The only attempt at a con-

<sup>1</sup> North, A. J. "Descriptive Catalogue of the Nests and Eggs found breeding in Australia and Tasmania." (Catalogue No. 12 of the Australian Museum, Sydney, N. S. W.)

<sup>1</sup> Scott B. Wilson, assisted by A. H. Evans. "Aves Hawaienses: the Birds of the Sandwich Islands." Parts iii. iv. 4to. (London: R. W. Porter, 1892, 1893).

nected biography is that of Dr. Althaus, of University College, London, who, in 1888, contributed to the *Allgemeine Zeitung*, published in Munich, a series of very interesting articles upon the life and correspondence of this remarkable man. These he supplemented at a later date by many new facts as to Oldenburg's birth, parentage, education, and early life, the results of researches undertaken at his instance by Dr. von Bippen, Archivist of Bremen. Until these facts were published by Dr. Althaus, we knew nothing whatever of Oldenburg's early life. He appears suddenly upon the scene as the agent for Bremen with the English Commonwealth and a correspondent of Milton's, but who this friend of Milton's was, and from what pit he was dug, no one seems to have taken much trouble to inquire.

We did not, as it now turns out, know so much as the date of his birth, for it is evident from Dr. von Bippen's researches that the date 1626 usually given in biographical dictionaries as the date of Oldenburg's birth is altogether wrong, and that as a matter of fact he must have been born about 1615, a date which puts the whole of his life and correspondence in an entirely new perspective. He was, according to this, only seven years Milton's junior, which accords much better with the tone of their correspondence, and he was seventeen years older than Spinoza, which perhaps partly accounts for the somewhat fatherly manner in which he encouraged that philosopher to publish certain of his works. Equally at sea are the biographical dictionaries (and other works too) as to his descent. The statement copied from book to book that he was descended from the Counts of Oldenburg appears to have been a pure "shot," inferred partly from his name, and partly from the fact that in his matriculation entry at Oxford he is called "nobilis Saxo," which means nothing at all. What we do now know about him is that he was the son of Heinrich Oldenburg (d. 1634), a tutor in the Gymnasium at Bremen, the grandson of another Heinrich Oldenburg (d. 1603), Professor of Mathematics in the same Gymnasium, and great-grandson of Johann Oldenburg, who came from Münster in 1528 to be the first rector of the Evangelical school at Bremen; and that he was one of a large family who lived in somewhat narrow circumstances.

As to Oldenburg's education, we learn that he studied first at the Evangelical school and afterwards at the Gymnasium illustre in Bremen, and that on November 2, 1639, he took there the degree of Master in Theology, the subject of his thesis being "De ministerio ecclesiastico et magistratu politico." Whether, like Gotthold Lessing at a later day, he was intended by his parents for a theologian, we do not know. He did not break with theology so completely as Lessing did, for throughout his life there was a certain theological flavour about him, and, in his interesting "commonplace book" preserved among the archives of the Royal Society, there is an entry of fifteen pages headed "Sensa Animi mei de Deo et ejus cultu naturali"; but he revolted from the *a priori* methods of the current teaching, and in the same MS. we find accordingly many vigorous passages directed against "the vain shadows of scholastic theology and nominalist philosophy." These outbursts, however, belong to a later date. It was as a theologian that he graduated at Bremen, and then, for some unknown reason, he went to England.

In England he lived for eight years, probably in the capacity of a tutor, probably, too, in royalist families. Some evidence, at any rate, exists in the Bremen archives that during this first English residence he took the king's side against the Parliament. Then comes a gap of four years, during which there are hints that he was travelling upon the continent of Europe and cultivating those numerous acquaintances with learned men, which afterwards stood him in such good stead when his life-work

was to gather scientific information from all parts of the world.

From June, 1653, however, his life becomes clear. In that month he was, as I have said, appointed agent for Bremen, in which capacity he had audiences with Cromwell, and made the acquaintance of Cromwell's Latin secretary, John Milton. The acquaintanceship ripened into friendship, and an elegant but somewhat ponderous Latin correspondence followed. Oldenburg's political mission came to nothing, and then we find him in a country village in Kent waiting in uncertainty as to public events and as to his own future career. That career was, however, very soon determined, for in 1656 he went to Oxford, and was immediately caught in that current of "experimental learning" which had already begun to flow. Boyle, Wilkins, Wallis, Petty were his constant associates, and his letters at this time show the strong scientific impulse which his mind had received.

The passage in Anthony à Wood's "Fasti Oxonienses," which records Oldenburg's Oxford residence, is as follows:—"1656. In the beginning of this year studied in Ox. in the condition of a sojourner Henry Oldenburg, who wrote himself sometimes Grubendole, and in the month of June he was entered a student by the name and title of Henricus Oldenburg, Bremensis, nobilis Saxo; at which time he was tutor to a young Irish nobleman called Henry ó Bryen, then a student also there." Besides Henry O'Brien he had another young nobleman as his pupil during his Oxford residence, namely Richard Jones, son of Catherine Lady Ranelagh and nephew to the Hon. Robert Boyle, and after remaining at Oxford for about eighteen months he accompanied young Ranelagh upon a journey to the Continent. For a year they remained at Saumur, and while there letters continued to pass between him and Milton. It is rather amusing, to read that Milton had entrusted to Oldenburg a packet of his latest politico-theological writings for distribution to foreign savants, a task which the cautious Oldenburg did not half like, and which he executed, as he informed Milton, by giving copies of the writings "to no one who did not ask for them." How many asked for them he does not say. It was not in truth with the fierce political and theological controversies of the time that Oldenburg's mind was now engaged. He had gained a new interest and was travelling with a new object. His scientific observations were certainly very mixed, many of them trivial, and some of them superstitious, but they serve to show the direction in which his mind was travelling. From Saumur he sends to Boyle "noteworthy observations concerning the existence and the working of animal poison," and a chemical recipe for an invisible ink, and says that if his travels take him to Italy it will be a satisfaction to give Boyle "news of the industrious Kircher's subterraneous world, his strange Grotta de' Serpi, his story of the growth of pulverised and sowne cockles irrigated by sea-water, his thermometre by a wild-oats-beard, his vegetable phoenix's resurrection out of its owne dust by ye warmth of ye sun, his pretended ocular confutation of Kepler's magnetical motions of ye Planets about the Sun, and of Gilbert's magnetical motion of ye Earth and of twenty other remarkable things."

At a later date he sends Boyle from Paris the recipe of a wonderful oil which he had picked up in the course of his travels, which was supposed to heal "migraines, palsies, lamenesses, crookednesses, and all ricketing diseases." More wonderful even than this wonderful oil is another of his discoveries, for Samuel Hartlib, in a letter dated April, 1659, informs Boyle that Oldenburg has written to him from Paris that he has in that city discovered a "clever, but very secretly acting" physician, who had spoken to him of a method by means of which one can prepare a drink from sunbeams!

Meanwhile Boyle and the other Oxford worthies con-

tinued their pursuit of the "new philosophy," meeting generally at that time in "Dr. Wilkins's lodgings in Wadham College." The London branch of the same movement, too, was now becoming active, meeting usually at Gresham College "at the Wednesday's and Thursday's lectures of Dr. Wren and Mr. Rorke." After the Restoration many of the Oxford professors lost their positions and came to London, and on the 28th November, 1660, at the close of a lecture of Wren's at Gresham College, it was resolved to reconstitute the Society, which had hitherto been somewhat amorphous, as a "Society for promoting the physical-mathematical experimental sciences." Oldenburg, who had just returned from abroad, was elected a member of the first Council, and he and Dr. Wilkins were chosen the first secretaries of the Society. From that moment Oldenburg threw himself heart and soul into the work of the Society. Its interests he regarded as his own, and Prof. Masson gives it as his opinion, and with justice, that without his endeavours and those of Hooke, the Society would scarcely have held together. The great difficulty, of course, was the want of money. Charles II., the so-called "Founder," had promised to endow it, but he broke his promise and only gave it a mace. The Society could not afford to pay its secretary, and yet the secretary must live. In the British Museum is preserved a rough memorandum in Oldenburg's handwriting, quoted, but not very accurately, by Weld in his "History of the Royal Society," which gives a very vivid idea of the secretary's labours and poverty. It runs as follows:—

*The Business of the Secretary of ye R. Soc.*

He attends constantly the meetings both of ye Society and Council; noteth the observables, said and done there; digesteth y<sup>m</sup> in private; takes care to have y<sup>m</sup> entered in the Journal and Register-books; reads over and corrects all entrys; solicites the performances of tasks recommended and undertaken; writes all Letters abroad and answers the returns made to y<sup>m</sup>, entertaining a corresp. w<sup>th</sup> at least 30 psons; employes a great deal of time, and takes much pains in satisfying forran demands about philosophical matters; disperseth farr and near store of directions and inquiries for the Society's purpose, and sees them well recommended, etc.

Qy. Whether such a person ought to be left vn-assisted?

In connection with this may be mentioned another memorandum of Oldenburg's. It is preserved in the same MSS. (Birch MSS. 4441), and is headed as follows:—

*Liste of Members y<sup>e</sup> are likely to promote ye  
desein of ye R. S.*

|                                                                                                                  |                                                                               |
|------------------------------------------------------------------------------------------------------------------|-------------------------------------------------------------------------------|
| Members y <sup>t</sup> will probably<br>both pay and give yearly one<br>entertainment to y <sup>e</sup> Society. | Such, as will pay, and pro-<br>cure an entertainment to be<br>made by others. |
|------------------------------------------------------------------------------------------------------------------|-------------------------------------------------------------------------------|

In the first column occur among others the names of Boyle, Petty, Wren, Evelyn, Wallis, Croon, Grew, Pell, Mercator, Hook, Collins, Newton, and Smethwick. Against the names of Newton, Grew, Pell, Mercator, Hook, Collins, and Smethwick are written the words "no pay."

The "no pay" element was one main difficulty of the new Society. Even those who promised to pay, frequently neglected to do so. In 1666 the arrears amounted to £600 sterling, and in 1673 to £1957, and this, notwithstanding strenuous efforts on the part of the Secretary to collect the contributions. In fact, at that time, out of 156 Fellows, only 53 paid regularly.

At the beginning of 1664 Oldenburg was authorised to make what he could by publishing the Transactions of the Society, but they were printed at his own risk, and seldom brought him in as much as £40 a year. The very next year the Plague appeared in London and drove away the book-purchasers, and the year after occurred the Great Fire of London, which ruined the booksellers,

and made publication still more difficult. Besides all this, the sale of the Latin edition in foreign countries was greatly hindered by the war with Holland. And to crown all, in 1667, the very year after these great disasters, Oldenburg himself, who had stuck to his post through Plague and Fire, was imprisoned in the Tower of London. The warrant, which is signed by the Prime Minister, Lord Arlington, charges him with "dangerous plans and practices"; but the fact appears to be that the immense number of his foreign letters had attracted attention, and since the Government of that time did not understand a man who had, as he wrote in the letter quoted above, "taken to taske the whole Vniverse," this voluminous correspondence excited suspicion. He was kept in prison for two months, "during which comitment," as he afterwards wrote to Boyle, he "learned to know his reall friends." Among these friends was Evelyn, who visited him in the Tower on August 8. After his discharge he waited upon Lord Arlington, and then went down into the country to recruit. "I was so stifed by the prison-air," he writes on September 3, "that, as soon as I had my enlargement from the Tower, I widen'd it, and took it from London into the country, to fann myself for some days in the good air of Craford in Kent. Being now returned, and having recovered my stomach, which I had in a manner quite lost, I intend, if God will, to fall to my old trade, if I have any support to follow it."

He fell to his old trade with his old energy, and how indispensable that energy was to the Royal Society is shown by the fact that during his imprisonment the Society did not meet. Besides his purely official work and his voluminous scientific correspondence, he was ready at all times to do battle for the Society. For in those early days it was far from being plain sailing. The Society had to meet much odium, especially on the score that it was "an enemy of the established religion and destroyer of the ancient well-grounded learning"; and it is with reference to these charges that Oldenburg breaks out in the fifth volume of the *Philosophical Transactions*: "Let envy snarle, it cannot stop the wheels of Active Philosophy, in no part of the known world. Not in France, either in Paris, or at Caen. Not in Italy, either in Rome, Naples, Milan, Florence, Venice, Bononia, or Padua. In none of the Universities, either in this or that side of the seas. Madrid and Lisbon, all the best spirits in Spain and Portugal, and the spacious and remote dominions to them belonging; the Imperial Court, and the Princes of Germany; the Northern Kings and their best luminaries; and even the frozen Muscovite and Russian have all taken the Operative ferment, and it works high, and prevails every way, to the encouragement of all sincere Lovers of Knowledge and Virtue."

Oldenburg died suddenly in September, 1677, at Charlton, in Kent. In the Archives of the Royal Society there are no less than 405 of his autograph letters and drafts, besides ninety-four letters to Robert Boyle in a separate guard-book, and many rough drafts in his own private Liber Epistolaris. One letter in this last-named MS. book, which has not hitherto been published, I cannot forbear to mention in concluding this article, since it shows Oldenburg, even at that early date, as an advocate of the higher education of women. The letter is written to Lady Frances Jones, and is dated August 28, 1660. "I wish heartily," he writes, "that that sexe, which is thus advantaged by Nature with a choyce structure of body, and thereby gives cause to conclude, that the guest thereof must be more than ordinary, would not suffer themselves to be diverted from those nobler improvements they are, to speak the truth, as capable of as men; nor be contented to have their innate capacity in their education stifled or debased to the needle or the making of sweet meats." Many such passages, full of sound sense, might be quoted from his letters did the limits of this article permit, but at present we can only express a

hope that an interesting man who lived in a most interesting period may yet find a biographer who will adequately bring him into the light out of the shadow of the giants who were in the earth in those days—Cromwell, Milton, Newton, Spinoza, Boyle—in the midst of whom he moved, and by whose great names his own has hitherto been too much obscured.

HERBERT RIX.

### THE NATURAL HISTORY OF EAST EQUATORIAL AFRICA.

THE geology of East Equatorial Africa has been recorded in a very general way in the maps of the region published by Mr. Jos. Thomson in his "Through Masai Land," and in the more recent one of Prof. Toulia; from these it was known that the area consists of a basal plateau of gneiss and schists, covered by a series of lavas in the interior and marked along the coast by patches of Jurassic rocks. My work therefore lay in the main in the examination of the gneisses and schists with a view to the determination of the method of their formation; also to the study of the volcanic rocks—which range from basalts to quartz trachytes—and of the relations of the old lava plateaus and sheets to the craters of various ages which play such a striking part in the scenery of the district. The most interesting part of the work consisted in the examination of the great "Graben" or valley of subsidence which runs north and south across the district; on the floor and on the sides of this are many old lake deposits now buried by lava flows, while the walls are also marked by terraces formed by the existing lakes when at a higher level than at present, or by old ones that have long since disappeared. In some of these terraces are shells with Nilotic affinities, though the localities are now far from the Nile basin. The collections made from the coast Jurassics will allow the age of these beds to be definitely settled, and the fossils—*Ammonites*, *Lytoceras*, *Belemnites*, &c.—suggest that they are probably Callovian. An interesting addition to the geology of tropical Africa has been the discovery of some Palæozoic shales, more than 130 miles from Mombasa, which have yielded a fairly good fauna, though richer in individuals than species.

The evidence collected proves the existence of a former race of men who used obsidian implements, and who lived in a period long prior to any existing tribes; and also, that the glaciers on Mount Kenia once extended several thousand feet further down the mountain than at present; in fact, a regular sheet or cap glaciation preceded the existing valley glaciation.

Zoologically the district is somewhat barren, and in many parts only animals with great powers of migration or hibernation are to be seen. In some of the country most famous for its game, none can be found, as it was killed off by last year's drought. Cattle disease is responsible for the disappearance of many species; thus, whereas buffalo used to be extremely common, only three were seen; only one herd of giraffes was met with. Zebra and ostriches are abundant in places, while the commonest antelopes seen were the hartebeest, mpalla, and water buck; topi are numerous on the Tana. The sparseness of dense forest, except on the higher parts of the district, accounts for the rarity of monkeys. *Colobus guerazi* was seen at over 9000 feet on Kenia, and some baboons amid the rocks of one of the ridges of the basin of Lake Kibibi. Hyena and a small bush buck range up into the lower Alpine zones on Kenia, while a small rat, Hyrax, and elephants occur in the woods of *Senecio johnstoni* in the upper Alpine zone. Another high record is the occurrence of fresh water crabs (*Telephusa*) in some swamps on Leikipia at the height of about 8000 feet.

The rarity of limestones doubtless helps to the scarce-

ness of mollusca. As is well known, most of the species live on trees, whether in river valleys, such as the Sabaki, or among the forests of Kenia, where some small delicate species are common from 8000 to 10,000 feet.

Botanically also, the country is somewhat barren and monotonous; vast areas are covered by nothing but low, umbrella-shaped acacias. The country may be roughly divided into seven zones. The first includes the coastal plain and river valleys, characterised by the abundance of palms, such as the Dum palm (*Hyphane thebaica*) and the Borassus palm (*B. flabelliformis*); the former is abundant along the coast and fringes the rivers, being found up the Tana as far as south of Kenia, and up the Sabaki to Tzavo. The Screw palm (*Pandanus*) is rarer, but has a similar range. The salt marshes and lagoons are bordered by the mangrove, while the she-oak, or *Casuarina*, occurs on the ends of exposed promontories on the coast. These have doubtless grown from cones carried by currents from Australia, just as the Krakatão pumice, which now forms banks along the shore, has floated from Malaysia. This zone is succeeded by great sandy steppes covered with mimosa and acacia scrub, with large baobabs, which occur also on the coast. The most typical plants have large and white flowers, a species of *Convolvulus* being the commonest. Aloes, and especially the species known to the Suahili as "nkonge," are abundant. The two next zones are the steppes and woods of the high plateaus; the most striking feature of the former is the high grass, which, when the seeds are ripe and yellow, reminds one of the great cornfields of Dakota.

In places the forests of the plateaus pass upward gradually into those of the flanks of the higher mountains, such as Kenia and Settima. The prevalence of lofty junipers which replace the trees of lower horizons, and the dense jungles of bamboos, with a carpet of *Selaginella* characterise the fifth or bamboo zone.

Above this are the Alpine pasturages. In the lower part there are numerous orchids, *Gladiolus*, &c. With the upper zone there appear species of the "everlasting plants" of the Cape, while the only trees are *Senecio johnstoni*. Beyond this is the zone above the snow line, where except for a few diminutive yellow composites and lichens, we have passed beyond the realms of plant or animal life.

J. W. GREGORY.

### NOTES.

DR. POTAIN has been elected a member of the Paris Academy of Sciences (Section of Medicine and Surgery), in the place of the late Prof. Charcot.

WE are sorry to learn of the death of Dr. H. H. Ashdown, on October 10, at the age of thirty-four. He was a Fellow of the Royal Society of Edinburgh, and published several memoirs on his physiological investigations.

WE regret to announce that Mr. T. C. Bain, the Government surveyor and geologist at the Cape, died at Rondebosch, Cape Town, on September 28. He was born in 1830, and his father was the engineer of the well-known Mitchell's Pass Road, at Cape Colony. Mr. Bain was appointed irrigation and geological surveyor in 1888. The British (Natural History) and Cape Museums contain a number of geological specimens collected by him, among which may be mentioned the collection of reptilian remains from the lacustrine beds of the Karoo.

A STATE MUSEUM is now in course of formation at Pretoria. Mr. P. Krantz has been appointed a curator, and he has, with an entomological assistant, just started on a collecting expedition, which may probably occupy a space of two years. Their mode of transit is in a large wagon drawn by twenty donkeys, these animals having been chosen as best able to withstand the



vicissitudes of climate and attacks of "fly" pertaining to some parts of the country proposed to be visited. This wagon has been fitted inside and outside with shelves and other paraphernalia for holding specimens, cork, medicaments, &c. When not travelling, accommodation is found in a large marquee fixed to the side of the wagon, from which step-ladders, dissecting-tables, &c., may be let down. A lighter and rougher wagon, suited to more inaccessible country, also accompanies the party. Everything has been done to favour the success of this expedition, and the Raad has passed a resolution specially exempting those engaged in it from the provisions of the game law. The nucleus of a good general collection should thus surely be obtained, whilst the idea of collecting the Transvaal fauna is highly to be commended.

AN appeal for subscriptions to found a Pasteur Institute for India is about to be made (says the Allahabad *Pioneer*). It is proposed to locate the institution in some convenient place near Simla. There the necessary laboratories, fitted with the best scientific appliances, quarters for the officials, and accommodation for patients will be provided. The expenses will be very considerable, but the Government of India, besides giving their cordial approval to the scheme, have contributed notable help by promising the services of a selected medical officer. India has hitherto taken very little interest in bacteriological work, though almost every European nation, America, and Japan are devoting a large amount of attention to it. It is hoped that in addition to its anti-rabic work, the Indian institute may be put on such a footing as to enable it to carry on original research in this and other directions. The institute should also serve as a training school in practical bacteriology for medical men in India. The scheme is full of promise, and there should be little difficulty in obtaining the funds necessary to carry it out.

AT the Institution of Electrical Engineers, on Thursday, November 9, Prof. George Forbes, F.R.S., will read a paper on "The Electrical Distribution of Power."

ACCORDING to the *Pretoria Press*, and from a Blantyre source, a very large supply of ivory has come down from the Lake, in the Lake Company's possession. Huge 6 feet and even 7 feet tusks were to be seen at Mandala, and several thousand pounds must have been paid the Arabs in exchange for this valuable commodity.

AN International Horticultural Society was founded at the recent congress of horticulturists held at Chicago. The chief object of the society is to facilitate the exchange of plants, seeds, books, &c. The following officers have been nominated:—President, P. J. Berchmans; Vice-President, Henry L. de Vilmorin; Secretary and Treasurer, Mr. George Nicholson, the Curator of Kew Gardens. We are informed, however, that Mr. Nicholson is unable to undertake the work that this office would impose upon him.

AN International Exhibition of Industry, Science, and Art will be opened at Hobart, Tasmania, on November, 1894, and will continue open for a period of about six months. The exhibits will be arranged into twenty-four classes. Class X. is Chemistry, Apparatus and Processes, Philosophical Instruments: XI. is devoted to Electricity; Gas and Lighting, other than Electricity, is the subject of Class XII. The following classes are also of scientific interest: XVI.—Machinery, Machine Tools, Hydraulic Machines, and Machines for raising heavy weights, Elements of Machines, Furnaces; XVII.—Prime Movers, and means of distributing their power, Railway plant; XVIII.—Naval Architecture and Engineering; XIX.—Civil Engineering, Construction, and Architecture, Sanitary Appliances, Aeronau-

tics, &c.; XX.—Mining and Metallurgy, Minerals, Quarrying, and Fuel; XXI.—Agriculture, Horticulture, Arboriculture; XXII.—Fisheries.

A CORRESPONDENT writes: "There seems still little recorded as to the maximum or average size of the flying fish, *Exocoetus* sp. On my voyage to the Cape, on board the R. M. S. *Drummond Castle*, in about the longitude of Greenwich and the latitude 11° S., and on September 9 last, a specimen flew, or was blown, on board, where the bulwarks were 19 feet to 20 feet above the water, which measured 18 $\frac{3}{4}$  inches long, with an expanse of 22 $\frac{1}{2}$  inches across the wings. This was the largest specimen that has ever passed through my hands. It only weighed 1 lb. 6 oz., but a development in weight would clearly be disadvantageous to its power of flight."

IN the notice of Prof. Sylvester's life which appeared in NATURE for January 1889 (vol. xxxix. p. 217), it is mentioned that after coming out at Cambridge as Second Wrangler, "he was incapacitated by the fact of his Jewish origin from taking his degree," and it is added that in "more enlightened times (1872) he had the degrees of B.A. and M.A. by accumulation conferred upon him." The learned librarian of Trinity College, Dublin, Rev. Dr. Abbott, calls our attention to the fact, which should not be overlooked, that though unable to take the degree at Cambridge, he actually passed *ad eundem* to Dublin University, and had the degrees of B.A. and M.A. conferred upon him there (in virtue of his Cambridge qualification) in 1841. The honorary degree of LL.D. was also conferred upon him by Dublin in 1865. It may not be without interest to mention that the first Jew to obtain a degree in the United Kingdom was Nathan Lazarus Benmohel, who graduated B.A. at Dublin in 1836, and M.A. in 1846.

SIX years ago Hofrath Dr. A. B. Meyer, Director of the Natural History Museum at Dresden, published in the *Abhandlungen und Berichte des K. Zool. Museum Zu Dresden*, a series of descriptions and drawings of iron-framed cases, and of other museum fittings and apparatus introduced by him in Dresden. Since then a good deal of attention has been directed to the subject of metal instead of wooden framing in museum cases; and in 1891 Dr. Meyer gave further details as to his experience in a communication to the Museums Association meeting at Cambridge. In the *Abhandlungen* of the Dresden Museum for the year 1892-3, just published, Dr. Meyer returns to the subject of iron-framed cases, on the details of which his recent experience has suggested several improvements. In a series of twenty lithographic and photographic plates, accompanied by elaborate specifications, measurements, &c., he deals with several forms of case, with store cabinets and their fittings, with trays for eggs and nests, sheet iron trays for shells, supports for skeletons and crania, craniometers, and several other varieties of museum appliance and case fittings. In truth Dr. Meyer has, with real German patience and industry, drawn and described in an exhaustive manner a range of museum cases and appliances which every curator more or less works out for himself, and of which, having by rule-of-thumb or otherwise attained his object, he thinks no more. But, as Dr. Meyer points out, museum officials are much given to experimenting at a loss of both time and money, and there is no reason why the results of well-matured experience should not be authoritatively laid down and generally accepted as a basis from which to reach forward to further improvements. The only other means than publication by which museum officials can obtain the results of mutual experiments and experiences is by visits to museums, but by that means alone the observer cannot get the precision of information and the working details which are conveyed by Dr. Meyer's monograph. The publication indeed confers a signal benefit on all interested in museum work, and it is much to be desired that

others having like valuable experience should follow Dr. Meyer's example, and put down with precision what they know and have accomplished for the benefit of the ordinary museum officer.

DR. KARL DOVE, in a letter addressed to the President of the Berlin Gesellschaft für Erdkunde, gives some interesting particulars regarding the climate and vegetation of South Pamaraland. The numerous larger rivers, or rather water-courses, of the country contain water almost throughout the year, which in the dry season, however, is found underneath the superficial layer of sand. In August of last year Dr. Dove even found a strongly flowing brook, about ten feet broad, in the hot and dry valley of the lower Swakop. He attributes the permanence of the rivers to the profusion of strong inclines and the scarcity of purely horizontal plains, which has the effect of diminishing evaporation. The great efficiency of the protection afforded by the soil even in that dry country is shown by the fact that in places where moisture could only be due to rain, traces of it were found in samples at the depth of three feet after five months of the dry season. The amount of atmospheric precipitation was abnormally large during the last rainy season, and the sky was clouded very much like a north European rainy sky. During January over 11.8 inches were recorded in the vicinity of the higher mountains of Windhoek and the Sheep River. At Windhoek itself the mean rainfall is estimated at 15.8 inches. The discovery that the rainfall does not show a further increase from lat. S. 22° to 19° is of special importance.

At a recent meeting of the British Ornithologists' Club, the Hon. Walter Rothschild read some notes on the genus *Apteryx*, and exhibited a very extraordinary number of living specimens of these "wingless" birds of New Zealand. He recognises the following as a complete list of the species at present known:—*A. australis*, Shaw, from the South Island; *A. lawryi*,\* sp. nov. from Stewart Island; *A. mantelli*,\* Bartl. from North Island; *A. oweni*,\* Gould, the east coast, South Island; *A. oweni occidentalis*,\* sub-sp. n., the North Island, and west coast, South Island; *A. haasti*,\* Potts, central South Island and west of the North Island; and *A. maximus*, Verr. (sp. dub.), South Island. Males and females of those marked with an asterisk were exhibited, and also a female specimen of the new sub-species. Mr. Rothschild is engaged on a monograph of these strange birds.

DURING the construction of the Pay-de-Dome Observatory in 1872, the ruins of a large temple were discovered (says M. Plumondon in *La Nature*). From a tablet bearing a well-preserved inscription it appeared that the temple was consecrated to Mercury, and, according to historians, it was destroyed towards the end of the third century. Near the middle of the ruins of the temple, in the part that was originally the most highly decorated, there stands a small vertical wall, about one and a half yards high and rather more than two yards long, built of rectangular blocks of stone four inches high and about six inches in length. The blocks are of two different colours, one kind being of light dolomite, while the other is a black lava. The two colours are alternated in each horizontal row, and the rows are arranged so that the vertical joint between any two blocks falls at the middle points of the blocks above and below it. Proceeding, therefore, from the bottom to the top of the wall, or *vice versa*, the faces of the blocks of each colour form a zigzag pattern of which the lines are inclined about 60° to the horizontal lines separating the successive layers of stone. In fact, the mosaic constitutes a system of parallel lines cut by oblique lines of precisely the same kind as that which is frequently figured in illustration of optical illusions. When the wall is viewed from a short distance the horizontal layers seem to lose their parallelism, and appear to converge towards the interior of the angles formed by two consecutive series of obliques. Zöllner first called attention to

the apparent loss of parallelism which truly parallel lines undergo when they are cut by oblique lines, but it is possible that the mosaic was designedly constructed to deceive the eye, and played an important part in the ceremonial of the temple on the Pay-de-Dome one thousand seven hundred years ago. *Nihil novum sub sole*.

MR. E. A. ANDREWS describes in the last (October) number of the *Studies from the Biological Laboratory of the Johns Hopkins University* an undescribed Acraniate, *Asymmetron lucayanum*, found in considerable numbers between North and South Bemini, Bahamas, in June and July 1892. They were taken in the tow-net while swimming at or near the surface, most abundantly at the early part of the ebb-tide when it had been high tide about nine o'clock in the evening, rarely in the daytime, or late at night, or on the rising tide. They were also obtained buried in the sand flats, but not very abundantly. The specimens taken in June were larger, often sexually mature, while those taken later were generally immature or larval forms. In captivity their habits were like the European lancelet, the largest was 16 mm. in length and sufficiently translucent to enable one to trace the food or carmine granules to be traced through most of the digestive tracts. The peculiarities of this form, and those which induced the author to venture to refer it to a new genus, are briefly: the gonads being present only on the right, instead of on both sides as in Branchiostoma, the ventral fin having no fin rays, and there being a long caudal process.

A PAPER was read lately by Mr. H. B. Stocks to the Edinburgh Royal Society (Proc. Roy. Soc. Edin. p. 70), "On Certain Concretions from the Lower Coal Measures, and the Fossil Plants which they contain." The interest which attaches to these concretions, or "coal-balls," is the remarkably perfect state of preservation of the fossil contents, in many cases fine plant-cells and fibres being preserved even without complete petrification. Chemically analysed, the petrified wood yields mainly carbonate of lime and iron pyrites, each in the proportion of 48 per cent. The late Mr. Binney suggested that the carbonate of lime was dissolved from shells in the marine strata overlying the concretionary beds and re-deposited on the plants, but, as Mr. Stocks points out, this assumes the lapse of a considerable period of time between the beginning of vegetable decay and the process of petrification, a period which would be under ordinary conditions fatal to the preservation of the delicate vegetable tissues. Mr. Stocks thinks that decay and petrification went on simultaneously, and hopes to prove the following explanation of the mode of petrification: by the process of osmosis water containing the usual quantity of carbon sulphate in solution, passes through the vegetable tissues of the plant, and sets up a series of chemical changes resulting in the formation of carbonate of lime and iron pyrites. The sulphuretted hydrogen combines then with more iron. The spheroidal shape of the nodules is, he believes, merely due to the deposition of calcium carbonate from a solution heavily charged with organic matter.

THE October number of the *Annals of Scottish Natural History* contains several interesting articles, amongst them being one by Mr. Peter Adair, on the disappearance of the short-tailed field vole (*Arvicola agrestis*), and on some of the effects of the vole plague. This destructive rodent began to be observed in the infested area a few years before 1890; it multiplied with rapidity until the summer of 1892, when the numbers began to decrease, and by the summer of the present year the pest had disappeared. Mr. Adair finds that the disappearance has been general over the whole infested area. On some farms the normal numbers remain, but on others scarcely a vole is to be seen. Various causes have been suggested to account for the disappearance. The drought of last spring and winter may have had some good effect, for the animal is partial to damp

ground. There is, on the other hand, evidence that an epidemic caused the plague to come to an end. But it is the general opinion of the farmers and shepherds of the district from which Mr. Adair obtained his particulars, that the disappearance is due in a great measure to the work of such natural enemies as the owl, kestrel, rook, blackhead gull, and buzzard, the stoat, and the weasel.

The Weather Bureau of Washington has published an elaborate discussion of the climate of Chicago, by Prof. H. A. Hazen, being No. 10 of the valuable *Bulletins* now being issued by that department. The city of Chicago is situated at the south-west of Lake Michigan, whose elevation is about 580 feet above the level of the sea. The earliest observations available were made in 1832, and continued until 1836, after which time they were of a very fragmentary character until November, 1859, since which a continuous series of observations has been maintained, at least as far as regards the temperature. The lake has naturally great influence upon the climate, and this has been investigated in great detail for each separate element. With regard to the winds, the tables show that for the year there is a maximum from the south-west, and a secondary maximum from the north-east. During the cold months there is a marked preponderance of land winds, while in the warm months there is a slight preponderance of lake winds. The mean temperature deduced from twenty years' observations is  $48^{\circ}6$ , and occurs about the third week in April and October. The highest temperature occurs about the middle of July, and the lowest the third week in January; for 174 days the temperature is rising, and during 191 it is falling. The cold spell about the middle of May, which is generally observed in the northern hemisphere, is well marked in the 5 - day means. The highest temperature observed was  $99^{\circ}6$  on July 17, 1887, and the lowest  $-23^{\circ}$  on December 24, 1872. The maximum temperature was  $90^{\circ}$  or over on 121 days during 20 years, and a minimum temperature of  $-15^{\circ}$  or below was only reached 16 times. Accurate rainfall observations can scarcely be said to begin at Chicago before 1867. The annual rainfall from this series is 34.4 inches, and is fairly well spread over each month. A fall of 2.5 inches in a day only occurred 15 times in 20 years. The work contains an abstract of the observers' *Journal* since the occupation of the station by the Weather Service, which includes an interesting account of their experience of the great fire of October 8-9, 1871.

We learn from the report on the administration of the Meteorological Department of the Government of India that the valuable series of meteorological observations which were taken by the late Mr. J. Allan Broun at Trevandrum during the years 1853-64 are being prepared for publication by that department, owing to the action taken by the Royal Societies of London and Edinburgh, and by the Meteorological Council with that view. It is proposed to publish them in three volumes containing (1) hourly observations, (2) comparative observations at various stations on the Travancore Hills, and (3) discussion of the observations. The report shows great activity in the collection of observations from ships entering the Hooghly; these observations are used in the construction of daily charts of the Indian land and sea area, the publication of which began with January this year. The growing usefulness of ordinary weather forecasts is exemplified by the fact that they have been extended to expeditions in the field, and they have been pronounced by the military authorities to have been very successful.

HERR P. CZERMAK publishes, in *Wiedemann's Annalen*, some beautiful photographs of ascending currents in gases and liquids. For the former a box of rectangular section was used, consisting of plate-glass sides firmly cemented together. At the centre of

the bottom was placed a flat spiral, the escape spring of a large spindle clock. The spiral could be heated by the passage of an electric current. A glass tube opened into the box at the bottom, directed towards the centre, for the introduction of smoke. A second glass tube led in at the top, for ventilation or the introduction of a light gas. Tobacco smoke blown in through the lower tube was seen to spread out on the bottom in a uniform layer, provided all parts of the box were at the same temperature. The touch of the hand on one side was sufficient to produce an ascending current and a motion of the smoke towards the warmer side. It was therefore necessary to perform the experiments in a room kept at a uniform temperature. On sending a current through the spiral, the mushroom-like figure first described by Vettin was observed to rise in faultless symmetry. This was photographed by flash-light, and the reproductions show the spiral convolutions to great perfection. Since the contours reflected the greatest amount of light, they stand out well from the dark background, and clearly exhibit the interior structure of the stream-figure. In order to imitate more closely the actual condition of the atmosphere during the ascent of warm air currents, the upper part of the box was filled with coal-gas. The stream-figure then ascended in the usual manner until its vertex reached the lighter stratum. It then became stationary, expanded in the diffusion stratum, and part of the smoke trickled back to the bottom. Sometimes it was found possible to obtain a cloud-like structure, with a dome in the centre and wavy outlines. The figures were more easily produced and photographed in the case of liquids, but the general type remained the same.

INVESTIGATIONS are carried on at the Agricultural Experiment Station, Purdue University, Indiana, on much the same lines as at Rothamsted. *Bulletin* 45 of the Station contains information of interest and importance concerning wheat-growing in Indiana. From field experiments extending over ten years it appears that none of the varieties of wheat tried have any tendency to deteriorate or "run out," provided proper care is exercised. No wheat proved to be "rust-proof," but early wheats were generally less injured by rust than later kinds. Eight pecks of seed per acre gave the best returns at the Station, the average yield for nine years being 30.35 bushels per acre. The best results came from sowings made not later than September 20. The value of crop rotation in maintaining yields of grain has been strongly emphasised, for a comparison of rotating crops with constant grain-cropping for seven years showed an average gain of 5.7 bushels per acre in favour of the former. Another important result obtained was that wheat may be harvested at any time from the dough stage to the dead-ripe condition, without appreciably affecting the weight or yield of the grain. Finally, a comparison of forms of nitrogen as fertilisers for wheat indicated that sulphate of ammonia is better than nitrate of soda or dried blood.

IN a former note (June 22, 1893) we have given a short account of the means employed by Signor Augusto Righi to obtain electro-magnetic waves of small wave-lengths (about 8 cm.), and also on p. 299, vol. xlviii. we have described some of the experiments he has performed, using waves of this small wave-length. Since then Righi has continued his researches, and has published in the Proceedings of the Royal Academy of Lincei an account of his experiments on the question as to whether the electric force is perpendicular to, or in the plane of polarisation. Trouton, from his experiments on the reflection of electro-magnetic waves from the surface of non-conductors, such as glass and paraffin, has come to the conclusion that the electric force is perpendicular to the plane of polarisation. The reflection of these waves from paraffin, and also from metals, has been studied by Righi, who finds a marked difference in the two cases. In the

case of paraffin his results agree with those obtained by Trouton ; when, however, a metal is used as the reflector he finds that the plane of polarisation is parallel to the electric force. The author has measured the refractive index, for oscillations having a wave length of 7.5 cm. of the paraffin used in his experiments. He employed for this purpose an equilateral prism, each face being 20 cm. high and 37 cm. broad, and found 1.4 for the refractive index. The paraffin employed was not of the highest quality, although it was quite white and homogeneous, and had a melting point of 50°.5 C.

DR. OETTEL has continued his researches on the phenomena of the electrolytic deposition of metals see NATURE, July 6, 1893). In the present paper, which is published in the *Chemiker Zeitung*, he gives the results he has obtained in his investigation of the condition of an auxiliary electrode placed between the two principal electrodes in a copper voltameter. For an auxiliary electrode 86 by 131 mm. in size, being a little smaller than the principal electrodes, he finds that copper is deposited on the side next the anode, and dissolved at the side next the cathode ; the quantity dissolved being larger than the quantity deposited in nearly the same proportion as at the principal electrodes. This difference is caused by the electrodes not being composed of pure copper. The deposit on the auxiliary electrode attains as much as 87 per cent. of the deposit on the cathode ; but depends on the following conditions :—(1) The relative dimensions of the auxiliary electrode and of the chief electrodes. (2) The absolute size of the electrodes ; for, since the copper tends to be deposited chiefly at the edges, the proportion increases when the plates are small.

IN order to ascertain if rifle bullets are capable of carrying infection, Messner (*Munchener med. Wochenschrift*, 1892, No. 23, has been making careful experiments with bullets purposely infected with particular micro-organisms. Bullets thus treated were discharged into tin boxes at a distance of from 225 to 250 metres. These boxes were filled with sterile gelatine peptone, and the channel in the latter made by the passage of the bullet was carefully watched and examined. It was found that in all cases the infected bullets had produced growths of those organisms in the gelatine with which they had originally been brought in contact. In some experiments the boxes, whilst filled with sterile gelatine, were covered over with flannel previously infected with particular bacteria, so that before reaching the gelatine the bullet would first have to pass through the former. Ordinary uninfected bullets were used, but in every instance bacterial growths made their appearance in the subjacent gelatine corresponding to the particular organisms present on the flannel. On the other hand, ordinary bullets, when discharged direct into the gelatine, occasioned only the appearance of moulds and other bacteria usually found in the air. Thus the heat communicated to the bullet during its discharge is not sufficient to destroy any bacteria which may be present upon it ; the temperature produced is also wholly inadequate to sterilise any portions of clothing with which the bullet may come in contact, the latter, on the contrary, carrying with it into the wound those bacteria which may be present on the former.

WITH regard to the physiological action of oxygen in asphyxia, more especially in coal mines, a committee of the British Association has arrived at the following conclusions :—

(1) In the case of rabbits asphyxiated slowly or rapidly, oxygen is of no greater service than air, whether the recovery be brought about in an atmosphere contaminated by carbonic acid or completely free of carbonic acid, and whether artificial respiration be resorted to in addition or not. (2) Pure oxygen, when inhaled by a healthy man for five minutes, produces no appreciable effect on the respiratory rate and volume, nor on the pulse rate or volume. (3) Oxygen, whether pure or somewhat

diluted, produced no effect on one particular patient, who suffered from cardiac dyspnoea of moderately severe type, in the direction of ameliorating the dyspnoea, and, compared with air inhaled under the same conditions, produced no appreciable effect, either on the respiratory rate and volume or on the pulse rate and volume. (4) An animal may be placed in a chamber, the general cavity of which contains about 50 per cent. of carbonic acid, and retained there for a long time without super-vention of muscular collapse, provided a gentle stream of a respirable air gas or oxygen, indifferently, be allowed to play upon the nostrils and agitate the surrounding atmosphere.

THE *Quarterly Journal of the Geological Society* (No. 196) has been issued.

MESSRS. DULAU AND CO. have issued a catalogue of works on Lepidoptera, Neuroptera, and Orthoptera.

MESSRS. WHITTAKER AND CO. have published a pamphlet, by Capt. M. P. Nadieine, on a new system of sanitary drainage and treatment of sewage matter.

THE Matabele War has induced Mr. E. P. Mathers to issue a "Map of Mashonaland and Matabeleland." A few facts about the Matabeles and their country give the map additional interest.

WE have received a paper on "Rainmaking," read before the Texas Academy of Science in December 1892, in which Dr. A. Macfarlane discusses professional rain-makers (not the medicine men of the Indians, but their civilised prototypes) and disposes of their theories seriatim.

THOUGH Mr. A. T. Burgess's "First Stage Agriculture" (Joseph Hughes and Co.) is adapted to the Elementary Syllabus of the Department of Science and Art, it should be valuable to all students of agriculture. The author is concise in his statements, so he has been able to give a large amount of information in a small book. A scarcity of illustrations is the book's only fault.

"THE Birds of Michigan," by Mr. A. J. Cook, are described in *Bulletin* No. 94 of the Michigan State Agricultural College. The bulletin is illustrated and contains a bibliography. In the text are recorded the food habits of the birds ; so that the economic importance of the various species can be judged. A section is devoted to a statement of the laws that obtain in Michigan for the protection of game. The list is a useful contribution to the ornithology of an interesting region.

A USEFUL book on the "Analysis of Milk and Milk Products," by Prof. Henry Leffmann and Dr. William Beam, has been published by Messrs. P. Blakiston, Son and Co., Philadelphia. The book appeals particularly to American agriculturists, but it may be introduced with profit into the dairy schools springing up in various parts of the country, and professional chemists will be interested in some of the analytical methods described.

MR. HUGH GORDON'S "Elementary Course of Practical Science," part 1, belonging to the series of Science Primers published by Messrs. Macmillan and Co., is worthy of introduction into all elementary and continuation schools. The experiments described are of a very simple nature, and refer to every-day phenomena. The pupil who conscientiously works through the little book will certainly have impressed upon him the importance of exactness, and will thus be given the best foundation of a scientific education.

ANOTHER book on practical physics is "Lessons and Exercises in Heat," by Mr. A. D. Hall (Rivington, Percival and Co.) The book contains a series of lessons and exercises, and is

suitable for use as a supplement to lectures and demonstrations. The experiments described will impress the student with the fact that "science is measurement," hence they are of the right kind, for it is doubtful whether showy experiments are of any educational value. Schools and university classes requiring a good and accurate handbook of heat for the physical laboratory would do well to adopt Mr. Hall's work.

MESSRS. LONGMANS AND CO. have just published, for Dr. F. Clemow, of the English Hospital, Cronstadt, "The Cholera Epidemic of 1892 in the Russian Empire." The author states in his preface that to the English medical world Russia is almost a closed book. The reason of this is that, in consequence of the difficulties of the Russian language, medical news from that country is rarely taken from the original source. Dr. Clemow, therefore, having a knowledge of Russian, set himself to give a plain, unvarnished account of the epidemic of cholera which last summer swept over the Russian Empire, and to bring together information bearing upon the subject *directly* from the most authentic Russian sources. He seems to have spared no pains to get the statistics as full and trustworthy as possible, and was assured by the authorities that, notwithstanding the difficulties attending their efforts to obtain proper returns from regions such as Central Asia and Siberia, in no case did the error exceed 10 per cent.

CARBIDE of silicon, SiC, the beautifully crystalline sapphire-like substance whose preparation by M. Moissan with the aid of the electric furnace was described in our note of October 12, p. 572, forms the subject of a communication to the current publication of the *Zeitschrift für Anorganische Chemie*, by Dr. Mühlhäuser, of Chicago, whose preparation of the carbide of boron formed the subject of our last week's chemical note. It appears that Dr. Mühlhäuser had already completed a long and very elaborate research upon the preparation of this interesting compound upon a scale of considerable magnitude, for the ultimate purpose of its manufacture, before the communication of M. Moissan appeared. The mode by which it may be obtained in large quantities was perfected some time ago by Mr. Acheson, and Dr. Mühlhäuser now gives details of the process, together with considerable additions to our knowledge of its chemical and physical nature. The process essentially consists in heating a mixture of silica and carbon to the temperature of 3500° by means of the electric furnace, when carbon monoxide escapes and silicon carbide is produced.

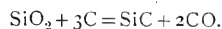

Silicate of alumina may be employed instead of silica with equally good results. The crystals obtained possess many of the properties, particularly the hardness, of the diamond. According to the purity of the materials employed in their manufacture they are colourless, or coloured yellowish green, bluish green, or pale blue. The name carborundum is suggested for the substance. Upon the large scale the cheaper materials sand and coke are employed, with the addition of common salt as a flux. The latter acts mechanically, causing the unattacked portion of the ingredients to bake together, thus facilitating the separation of the crystals; it also prevents loss of carbon by surface oxidation. One hundred parts of the powdered coke are mixed with one hundred parts of sand and twenty-five parts of salt. The mixture is placed in an electric furnace built of highly refractory fireclay. The electrodes are inserted through apertures at the ends of the furnace, and are connected with a central bar of carbon, the high resistance, round which the mixture is closely packed. The electrodes are in immediate connection with a powerful current transformer, which is connected in turn with an alternating current dynamo. The carbon high resistance bar is raised by the current to an intense white

heat, which is in turn communicated to the mixture. Gas is rapidly evolved from the mass, and yellow and blue flames dart out in all directions. As the heat increases the flame concentrates about one position until the fused salt rises to the surface, when an energetic action occurs, the gases eventually forcing their way through the liquid crust and heaping it up in the form of a crater, from which a high flame shoots up surrounded at its base by dense white clouds of vapour of salt, and eventually the remainder of the salt wells forth from the crater like veritable lava, carrying the dark impurities along with it. The interior of the crater, where the reaction is proceeding, is now seen to be white hot. The eruption soon commences to subside, the flames cease to appear, the outer crust hardens, and the reaction is complete.

THE product of this remarkable reaction is an ellipsoidal hardened mass, surrounding the carbon high resistance, and is found upon making a section to consist of six distinct layers. The first, close against the carbon bar, is a zone of graphite, which occurs in the form of hollowed hexagonal plates, pseudomorphs of silicon carbide, from which they are produced by dissociation at the extremely high temperature in the neighbourhood of the bar, silicon escaping as vapour. The second and by far the largest zone consists of the crystals of silicon carbide. They are largely found in elongated aggregates, radiating in all directions from the axis of the ellipsoid; the individuals forming the aggregates are bluish or yellowish-green, and of all sizes up to crystals a centimetre in diameter. Numerous isolated and highly perfect crystals of considerable size and great beauty are likewise found between the aggregates. Surrounding this zone of crystals is a narrow zone of amorphous carbide of silicon, outside which is found a layer of nodules of minerals produced from the impurities during the reaction; the fifth layer consists of the remains of uncombined mixture, and the sixth the crust of common salt. The crystals obtained by employing silicate of alumina are usually colourless or pale blue, and have been employed by M. Nikola Tesla in his new lamp for the transformation of electrical waves into waves of light. The powdered crystals explode violently when heated with potassium and lead chromates, but burn quietly with chromate of lead alone, forming dioxides of carbon and silicon. The powder exhibits a vivid greenish-yellow luminosity when heated in a platinum crucible. It is only very slightly attacked by the oxygen of the air under these circumstances, only 0.5 per cent. uniting in an hour. The fine powder, moreover, remains suspended in water for months without subsiding, although the specific gravity of the carbide at 15° is 3.22.

THE additions to the Zoological Society's Gardens during the past week include a Macaque Monkey (*Macacus cynomolgus*, ♂) from India, presented by Mr. Robert Gallon; a Chestnut-eared Finch (*Amadina castaneotus*) from Australia, a De Filippi's Meadow Starling (*Sturnella defilippi*) from South America, presented by Mrs. Kemp-Welch; two Laughing Kingfishers (*Dacelo gigantea*) from Australia, presented by the Executors of the late Mr. Fred Burgess; a Punctured Salamander (*Amblystoma punctatum*) from North America, presented by Mr. J. H. Thomson, C.M.Z.S.; four Common Toads (*Bufo vulgaris*) from Jersey, presented by Mr. J. Stanton; two White-handed Gibbons (*Hylobates lar*, ♂ & ♀), a — Bulbul (*Hypsipetes* —) from the Malay Peninsula, a Red and Yellow Macaw (*Ara chloroptera*) from South America, five Green Lizards (*Lacerta viridis*), three Black-spotted Toads (*Bufo melanostictus*), four Slagintweit's Frogs (*Rana cyanophlyctis*) from Ceylon, two Slow-worms (*Anguis fragilis*), three Fire-bellied Toads (*Bombinator igneus*) European, deposited; a Bar-tailed Godwit (*Limosa lapponica*), two Dunlins (*Tringa alpina*) British, purchased.

OUR ASTRONOMICAL COLUMN.

BROOKS' COMET.—Dr. F. Bidschof has computed the following elements and ephemeris for the comet discovered by Mr. W. R. Brooks, on October 16:—

$$\begin{aligned}
 T &= 1893 \text{ September } 19^{\text{h}} 6^{\text{m}} 29^{\text{s}} \text{ Berlin mean time.} \\
 \beta &= 175^{\circ} 1' 0'' \text{ Mean} \\
 \omega &= 348^{\circ} 30' 7'' \text{ eq.} \\
 i &= 129^{\circ} 54' 6'' \text{ } 1893^{\circ} 0' \\
 \log q &= 9^{\circ} 91335
 \end{aligned}$$

Ephemeris for Berlin Midnigtit.

| 1893.      | R.A. app.<br>h. m. s. | Decl. app.<br>° ' " | log r  | log Δ  | Brightness |
|------------|-----------------------|---------------------|--------|--------|------------|
| November 2 | 12 45 59              | +24 35 9            | 0'0600 | 0'1913 | 0'88       |
| 6          | 12 53 13              | 27 51 8             | 0'0782 | 0'1788 | 0'85       |
| 10         | 13 1 12               | 31 21 1             | 0'0961 | 0'1662 | 0'83       |
| 14         | 13 10 2               | +35 4'6             | 0'1137 | 0'1539 | 0'81       |

The brightness of the comet on October 18 has been taken as unity.

THE PLANET JUPITER.—At the present time Jupiter is a fine object for observation, his declination being between 18° and 19° north of the equator. Coming into opposition on November 18, telescopes of moderate power can be used effectively for observing the belts, small spots, and other fine details. Large instruments—that is, those having an aperture of 15 or 16 inches or more—may be used also for observations of the 5th satellite. Assuming the period of this satellite to be 11h. 57m. 21'88s, with a probable error of about a second of time according to Mr. Marth, the following are the approximate times of elongation:—

Greenwich T.me.

|            | East.<br>h. m. | West.<br>h. m. |
|------------|----------------|----------------|
| Nov. 2 ... | 9 9 p.m.       | 3 8 a.m.       |
| 6 ...      | 8 47           | 2 46           |
| 10 ...     | 8 24           | 2 23           |
| 14 ...     | 8 2            | 2 1            |
| 18 ...     | 7 40           | 1 39           |
| 22 ...     | 7 18           | 1 17           |
| 26 ...     | 6 56           | 12 55          |
| 30 ...     | 6 34           | 12 33          |

THE WAVE LENGTHS OF THE NEBULAR LINES.—Last week we referred to Prof. Keeler's paper, read at the congress of Astronomy and Astro-Physics at Chicago, and we may add here a few words with regard to the results it included, as they are of importance. This paper, on "The Wave-lengths of the two Brightest Lines in the Spectrum of the Nebulae" is the outcome of a series of measurements made with the 36-inch refractor and the large spectroscope of the Lick Observatory, the dispersion employed being equivalent to twenty-four 60° flint prism. The "normal position" of a nebular line is defined as the position of the line in the spectrum of a nebula at rest relatively to the observer. The results with respect to the two chief nebular lines are—

|                                                               |        |                 |
|---------------------------------------------------------------|--------|-----------------|
| Normal position of the chief nebular line on Rowland's scale  | ... .. | λ 5007'05 ± '03 |
| Normal position of the second nebular line on Rowland's scale | ... .. | λ 4959'02 ± '04 |

Prof. Keeler considers the greater part of this probable error to be due to comparisons with the third line, which could not be observed so accurately. From all the observations he finds that the motion of the Orion nebula referred to the sun is + 11'0 ± 0'8 miles per second, and the wave-length of the chief line in this nebula, corrected for the earth's orbital motion, is 5007'34 ± '013.

GEOGRAPHICAL NOTES.

YET another plan for polar exploration is announced with no definite purpose of pushing on to the pole, although that may incidentally be reached. Mr. Robert Stein, of the U.S. Geological Survey, proposes establishing a station at the south end of Ellesmere Land, which will be kept in touch with the outer world by the whalers hunting in Baffin Bay. Here a number of observers will live gaining experience in Arctic travel, and from this base "a fan of secondary stations" will be pushed out a hundred miles or so further north, where com-

fortable houses will be built and frequent communication kept up with headquarters. From each secondary station the staff of five hardy observers will travel northwards, combining science with sport, and even when tracking the musk-ox or white bear each explorer will carry his "four-pound aluminium theodolite" and "make game of the heights and bearings of the mountain peaks." We fear that if this expedition, or rather system of exploration, is really set on foot, its difficulties will become much more real than they now appear. In any case it would be wise to postpone work on so large a scale until the two well-equipped expeditions already in the field have added their contribution to our knowledge of Arctic conditions.

M. E. DE PONCINS, who is travelling in Central Asia, has written some interesting letters to the Paris Geographical Society. In the latest, dated from Chajan, in the Pamirs, on July 9, he mentions the curious fact that while in Europe he has repeatedly suffered from mountain sickness on Mont Blanc and Monte Rosa, he eats and sleeps at 4500 metres in the Pamirs just the same as at sea-level. In crossing snow-passes at 5750 metres his horses caused some trouble, but with this exception he found the Pamirs a pleasant region where it was easy to get about in summer.

THE Russian Government has organised a new province in Siberia under the name of Anadyr. It occupies the extreme north-east of Asia, and is very thinly peopled, mainly by natives, Koriaks, Kamchadales, Chuchis, &c., the last named being the most numerous and the least uncivilised.

DR. E. V. DRYGALSKI, who has spent eighteen months in North-West Greenland studying the phenomena of Arctic glaciers, has returned to Europe, and his report of the work done by his expedition will be expected with much interest.

A NOVELTY in political boundary lines is reported in *La Géographie*, which states that the frontier between Turkey and Servia is to be marked throughout its length by a wire fence.

THE November number of the *Geographical Journal* is rich in new contributions to geography and exploration. The Earl of Dunmore's paper on the Pamirs and Central Asia occupies the first place.—The Rev. J. A. Wylie gives an account of a journey through Central Manchuria, with many interesting notes on places and people, and a detailed itinerary which must prove valuable to subsequent travellers.—Lieut. B. L. Sclater writes a detailed report on routes and districts in Southern Nysaland, illustrated by a new map of the district east of the Shire as far as the Milanji Mountains, largely compiled from his own prismatic compass surveys.—Mr. Theodore Bent communicates a letter from Mr. Swan, who is now in Mashonaland, giving an account of fresh ruins recently visited on the Lotsani and Lundi Rivers, the "orientation" of which to the setting solstitial sun he believes he has established.—Mr. W. S. Bruce and Dr. C. W. Donald publish a preliminary report of their observations during a voyage toward the Antarctic Sea, and Dr. Schlichter gives his paper on the determination of geographical latitudes by photography.

INSTITUTION OF MECHANICAL ENGINEERS

ON Wednesday and Thursday of last week, October 25 and 26, a general meeting of the Institution of Mechanical Engineers was held in the theatre of the Institution of Civil Engineers, in Great George-street, Westminster; the President, Dr. William Anderson, occupying the chair. Dr. Anderson retires in rotation this year, and Prof. Alexander B. W. Kennedy, F.R.S., is proposed as his successor. There were two papers down for reading, as follows:—"On the Artificial Lighting of Workshops," by Mr. Benjamin A. Dobson, of Bolton; and "On the Working of Steam Pumps on the Russian South-Western Railways," by Mr. Alexander Borodin, Engineer-Director.

Mr. Dobson's contribution was an interesting and valuable paper, in which he described the results of inquiries he had made with a view to obtaining the best mode of artificial illumination for the large workshops of his engineering establishment at Bolton. Mr. Dobson's works are engaged in producing textile machinery, more especially that for cotton-spinning. Many parts of such machinery require to be finished

in the highest manner, and with mathematical accuracy. In order to accomplish this a good light is necessary, but unfortunately that is a thing Mr. Dobson can seldom get from natural sources at his works. We do not as a rule expect to find engineers and manufacturers exclaiming against the smoke nuisance; we rather look to hear such things from those who cultivate the gentler arts. It is therefore, perhaps, worth while to quote a few passages from Mr. Dobson's paper, in which he speaks of the state of the atmosphere in Lancashire:—

"Although Lancashire coal has a number of excellent qualities, yet it is one that makes the most smoke of any. A large portion of the Lancashire manufacturing industries, great and small, date from a number of years back, when smoke-consuming and smoke-preventing apparatus had not yet been devised; and many of the factories are working at the present day under pretty much the same conditions as when they started. Hence the atmosphere in all manufacturing towns in Lancashire is heavily charged with unconsumed carbon, producing an excess of cloud and fog, which, while inducing an excess of rain, acts also as a screen against the rays of the sun, and thus does a double injury to the neighbouring agriculturist, the producer of the country's native wealth. A circle of thirty miles radius around Manchester is said to include a larger population than an equal circle around any other place in the world; and within this circle, about twelve miles north-west of Manchester, lies Bolton, the town with which the author is best acquainted, where all winds, except the west and north-west, bring the surcharged atmosphere from other manufacturing districts, producing at any season of the year, if the wind happens to be slight, a sky ranging from dull lead to dark brown. For four years in succession it has occurred at the writer's works, that on June 21, the longest day, the gas in every room, amounting to nearly 7500 jets, has had to be lighted by eleven o'clock in the morning, and has remained lighted until work ceased; and this has occurred also in other towns, in weather that ought to have secured abundant sunshine. To such an extent does gloom prevail that in clear weather the effect of bright sunlight becomes even distressing to the eyesight, simply from the rarity of the contrast."

In endeavouring to improve the lighting of his shops, Mr. Dobson naturally turned to electricity. Incandescent lamps were tried, but these were not a very great improvement in illuminating power over gas; whilst with the arc lamp the shadows were so hard and strongly defined that the workmen preferred a very much weaker illumination, if more diffused. When travelling on the Continent, Mr. Dobson visited some cotton mills, and here he found what seemed a very perfect system of illumination. Arc lamps were used, but they were placed in an inverted position to that which is usual, the negative carbon being above, and the positive carbon below. This, of course, threw the greater part of the light rays upwards, as most of the illuminating power proceeds from the crater of the positive carbon. The ceiling is kept well white-washed, so that the light thrown up is again reflected downwards. The sides of the rooms are also white-washed, in order that a reflection may come from them. The result is that, without any definite source of illumination being observable, the whole room is flooded with a well-diffused light. Mr. Dobson had very kindly arranged to have one of these lamps in the large visitors' room of the Institution of Civil Engineers, so that members were able to judge of its efficiency for themselves. The result was very perfect in regard to absence of shadows. One could stand in any part of the room, facing any way, and read a book or paper without any very perceptible shadow being thrown; indeed, the diffusion of light appeared to us as good as in the open air. Such a result is of the greatest importance, and it is to be hoped that libraries and reading-rooms especially will in future largely adopt this system; or at any rate, that it will be introduced to the exclusion of the direct arc lighting, like that adopted with such unpleasant results in the reading-room of the British Museum. In regard to the cost, Mr. Dobson cannot speak positively on the subject, not having vet sufficient data to go upon, but he anticipates that it will be higher than gas at 2s. 8d. per thousand, which is the price in Bolton. There will, however, be a much larger volume of light than when the gas was used, and the advantages of the system, in his opinion, altogether outweigh any possible additional cost. In the discussion which followed, Mr. A. P. Trotter gave a good popular explanation of the advantages of a dead white surface for reflecting light, as compared to that of a looking-glass or bright

surface. Good white blotting-paper, he said, reflects back 82 per cent. of the light cast upon it. Many persons are under the impression that looking-glass must be a better reflector than paper or a white-washed surface, because, with looking-glass, a strong shadow can be cast, while from a dead surface no heavy shadow is obtained. The reason, of course, is not so much that the reflected light is less from the dead surface, but that the reflection is concentrated in the case of the looking-glass; with paper or whitewash it proceeds from a vast number of points.

A modification of this system of reflected light, which is of interest, has been adopted by Mr. Aspinall, the chief engineer of the Lancashire and Yorkshire Railway, at the Horwich shops, where the rolling-stock for the line is produced. In these shops the roof is not adapted for putting in large white-washed reflectors above the lamps, the jibs of travelling cranes, belting, shafting, &c., being in the way; but Mr. Aspinall, having seen the very perfect illumination obtained by Mr. Dobson at Bolton, determined to see if he could not obtain a modified result. He therefore inverted his arc lamps so as to get the positive carbon below, as in the case of the Bolton installation, and the major part of the light would be thrown towards the ceiling. Above the lamp, and therefore not shielding it from view, was a white-washed screen of boards, acting as a reflector. The effect was far superior to that of the ordinary method of arc lighting, where the dazzling stream of light pours upon the spectator to the derangement of his eyesight, and at the same time casting heavy and impenetrable shadows. This arrangement, however, is inferior to the complete system, as described by Mr. Dobson, but may be taken as a very good substitute where, from local causes, the entirely reflected principle cannot be adopted.

Mr. Borodin's paper on Steam Pumps was read on the second day of the meeting, and led to a fairly long discussion. The author gives details of a number of pumps tested in order to find their efficiency under ordinary working conditions. The paper has a commercial rather than a scientific interest, to this extent—that it shows the manufacturers how badly machinery may work; for instance, a pump manufactured by an English firm of very good repute only gave 2953 foot lbs. of work done per lb. of steam, when pumping against a head of 33 ft. and the steam pressure being 90 lbs. Supposing the trial conditions to be properly observed—which there is no reason to doubt they were in the present instance—such a result could only be due to the pump being in extremely bad condition, owing to neglect or ill-usage. It had been in use for a number of years. One meets with the same thing—perhaps to a greater extent—in steam engines where the fuel consumption of 30 or even 40 lbs. per one horse-power per hour has been recorded. Mr. Borodin's paper is useful as supplying awful examples for pump users, and at the same time it opens up the very wide question of the value of trial trip efficiencies. To take another instance, that of war ships, a very high speed may be obtained on trial with picked coal, picked stokers, engines thoroughly overhauled, and, in fact, every possible precaution taken to procure efficiency. Naval captains are apt to say, "We would like to know what our ship will do under fair working conditions in action, rather than what she may be made capable of by tuning her up to concert pitch." That is a very good argument for the captains, but where are we to draw the line? It is impossible to lay down what are the fair conditions of ordinary service for any class of vessels—how bad the coal should be, how inefficient the stokers, how rough the weather. Our only course is to get the highest possible result in every case, and then make such allowance as experience, or common sense, would dictate. The same thing may be said with regard to the pumping machinery dealt with by the author. For instance, a pulsometer referred to in the paper was stated to require 860 lbs. of steam per hour for a certain duty; whilst experiments made by Prof. T. Hudson Beere, with a pulsometer in good order, gave the pounds of steam required for a similar duty as 147.6. Now, it will be obvious that if a contractor requires a convenient pump like the pulsometer, and is prepared to pay somewhat for the suitability in the matter of economy, he need not take 860 as his figure of merit, when 147.6 is the trial trip efficiency, although he may undoubtedly have to make some allowance upon the latter figure.

The paper was favourably received by the meeting, and will no doubt add to the attractiveness of the volume of Transactions in which it will appear.

The meeting concluded with the usual votes of thanks.

*THE ARBUTHNOT MUSEUM, PETERHEAD.*

THE visitor to Peterhead in past years may have had his or her attention directed to the Arbuthnot Museum, and may have ventured into the hall which then contained the very interesting but well-mixed collection.

The founder of this museum, Mr. Adam Arbuthnot, was born in September 1773. During his years of business as a merchant in Peterhead, and after he retired, he kept gathering at objects of antiquity and natural history, and amassed an immense and valuable collection, all of which he bequeathed to the town at his death in 1850. Some years later the museum of antiquities, minerals, &c. collected by the members of the Peterhead Institute, was added. This last contained a very fine and extensive collection of local shells by the late Mr. Dawson, who was a schoolmaster in Cruden. Since then many smaller but important donations have been made, notably by whaling captains. The Rev. Mr. Yuill, late Free Church minister of Peterhead, contributed the large majority of the invertebrate fauna.

It had become apparent that better accommodation was required, and a complete revisal of the whole collection. There is no necessity here of detailing how this was gradually arrived at. With bazaars, and by means of a handsome contribution made by Mr. Carnegie, Peterhead was enabled to adopt the Free Library Act, and on a site obtained, a very handsome and suitable building was erected, with provision for a free library and reading-room, museum, and art gallery. The two rooms devoted to the museum are large and well-lighted, and the collection has been completely rearranged. The whole building was opened on Wednesday, October 11.

The museum is now in a very different condition. One of the rooms contains the antiquities and ethnographical exhibits, the other the natural history collection. Local and foreign objects have been separated in both rooms as far as was possible. And now the visitor may begin in the antiquities room and see the stone implements, the urns, and the mediæval finds of a local character, and the curiosities from different parts of the world, all placed in a rational order. The rich collection of domestic and other articles from Greenland are all together at the far end of the room. A very valuable collection of coins is also arranged in excellent order in this room. It may be interesting to note that the British coins are so arranged in movable glass panels that the visitor can see both sides by turning the panels round. The ancient swords, African spears, and the like have been grouped on the walls. Not only is the room in the manner of its arrangement worthy a visit, but many of the objects are of considerable value and interest.

The same is true of the larger natural history room. There is a very good collection of minerals, polished granites from many localities, local seaweeds, lichens, mosses, and the invertebrate division of the zoological collection is also rich in many of the orders. These specimens are all arranged in large double-floor cases, a feature in which is the upright middle case. Spirit and branching specimens are thus shown to an immense advantage from both sides. Lightness of effect is secured by using plate-glass shelves.

It may be interesting, moreover, to point out that one or two of the Sertularians and a Ray's bream have been obtained, prepared, and presented by Mr. C. W. Peach.

The fishes are arranged in a wall case, and surmounted by a group of the "saws" of the saw-fish. The amphibia and reptiles are arranged in a corresponding case, which is surmounted by turtle shields. The crocodiles, &c., are arranged on the wall near this, above the very handsome case of birds. In this last case, as in the rest of the museum, all the foreign specimens are made to keep company. The mammals are arranged in one of the old cases, and near them all the Greenland specimens are grouped together. Plate-glass shelves have been used throughout.

Very many valuable objects claim the attention in this section. There is a group, for instance, of deers' horns (mostly red deers') over the door, which have been picked up in the mosses around Peterhead, and which measure more in diameter than the recent ones. Among the fishes are many that could be mentioned as occurring at Peterhead. There are several fetuses of whales, walrus and seals, including a large one of the Greenland whale. Two very nice cases, exhibiting the characteristics of foxes and badgers, are the work of the Aberdeen naturalist Mr. Sim. A similar case of sea birds was made by a local naturalist, Mr. McBoyle, from whom, too, many of the

local birds have been procured. It is to be hoped that some of the groups, such as the Crustacea, will not be lost sight of by the members of the Buchan Field Club, whose interest in the museum should be a direct and helpful one.

This is not the only collection in Aberdeenshire. It has been my pleasure to meet some enthusiasts who have more or less exhaustive collections of antiquities, insects, birds, &c.; but it is to be regretted that there is no good public museum in Aberdeen itself; its situation is one that would be unequalled almost in interesting such collectors in a very large district. Moreover such a museum, if ever formed, would require to provide for a good technical display illustrating agricultural, fishery, and granitic industry.

ALEXANDER MEEK.

*THE MASSACHUSETTS INSTITUTE OF TECHNOLOGY.*

THIRTY years ago Dr. William Barton Rogers, the then Director of the Geological Survey of Virginia, and a Professor in the University of that State, founded the Massachusetts Institute of Technology, Boston. Dr. Rogers has since died, but the Institute has grown, and is now the largest scientific and technical school in the United States, and one of the largest in the world. By the catalogue of 1892-93, the number of students was 1060, and the number of teachers 125.

An account of the character, equipment, and work of the Institute has recently been published, and from it the following facts have been obtained. The prospectus is illustrated by a number of fine pictures, three of which have been sent to us for publication.

The Institute is remarkable for the great variety of its courses. In it are taught the sciences and their applications to the arts, the studies being divided into thirteen four-year courses, as follows:—(1) Civil engineering, including railroad engineering, highway engineering, bridge building, and hydraulic engineering; (2) mechanical engineering, including steam engineering, mill and locomotive engineering; (3) mining engineering and metallurgy; (4) architecture; (5) chemistry; (6) electrical engineering; (7) biology; (8) physics; (9) general studies; (10) chemical engineering; (11) sanitary engineering; (12) geology; (13) naval architecture. Agriculture is not included in this list, on account of its being provided for in a State College at Amherst.

In the four years required for graduation, it is sought:—

- (1) To make the pupil observant, discriminating, and exact.
- (2) To develop in him a taste for research and experimentation on the one side, and for active exertion on the other.
- (3) To give him the mastery of the fundamental principles of mathematics, chemistry, and physics, which underlie the practice of all the scientific professions.
- (4) To equip him with such an amount of practical and technical knowledge, and to make him so familiar with the special problems of the particular scientific profession at which he individually aims, as to qualify him immediately upon graduation to take a place in the industrial order.

The chief and dominating feature of the Institute, from the material point of view, consists of its numerous large and well-equipped laboratories. The buildings of the Institute, in addition to drawing, recitation, and lecture rooms and libraries, comprise eight laboratories, or groups of laboratories. The Rogers Laboratory of Physics comprises seventeen separate rooms. It includes a laboratory of general physics devoted to instruction in the principles of physical measurement, a laboratory of electrical measurements, devoted chiefly to advanced electrical work; a laboratory of acoustics, one for optical work, and another for photography. In addition to these, there is a dynamo-room and several laboratories of electrical engineering.

The dynamo-room (Fig. 1) is provided with a Westinghouse engine of 75 horse-power, the sole use of which is to furnish the power to drive the plant of dynamos. This plant, besides a number of smaller machines, comprises a 500 light alternating current Thomson-Houston dynamo, with transformers, a 150 light Edison dynamo, a 200 light Thomson-Houston direct current dynamo, a 60 light Weston dynamo, a 3 arc-light Brush dynamo, a United States 300 ampere low voltage dynamo for electrolytic work, and a Siemens' alternating arc-light dynamo. From time to time other large machines are temporarily placed here for purposes of study by the students. The wires from



this room are carried to all parts of the building for experimental purposes, as well as for use in illumination.

nected with a steam pump, with a rotatory pump, and with the city supply. On the sides of the large tank are the connections for the various hydraulic apparatus, including apparatus for measuring the flow over weirs; through various sizes and shapes of orifices: through hose-nozzles; through different sizes of pipe, with the several varieties of obstructions that occur—namely, diaphragms, couplings, elbows, T's, bends, valves, &c. Also connected with the tank, or with a centrifugal pump, is a Swain turbine, so arranged that measurements can be made of the power transmitted under various heads and with different openings of gate.

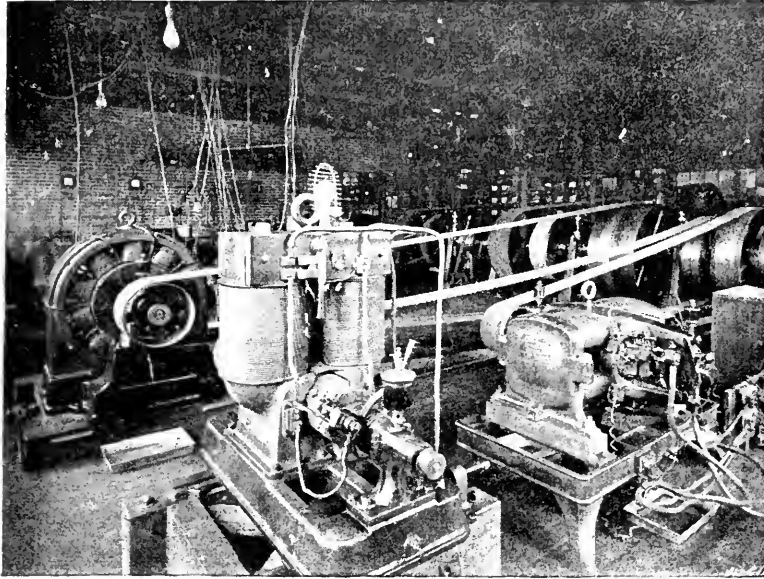

FIG. 1.—Dynamometer Room.

The most important feature of the biological laboratory of the Institute is the opportunity of studying ferments, fungi, algae, bacteria, and other low forms of life. Courses are also provided in general biology, microscopy, comparative anatomy and embryology, physiology and histology.

The Institute possesses a laboratory of mineralogy, lithology, structural geology, and economic geology, but it is neither so extensive nor so well equipped as most of the laboratories already named.

A praiseworthy feature of the Institute's curriculum is that during the last term of his course every student who is a candidate for a degree spends a large portion of his time in the preparation of a thesis upon some chosen subject. This is always of a nature of an experimental research, and may be either purely

The Kidder Chemical Laboratories are just as well-equipped as the Rogers Laboratory of Physics. They comprise laboratories, four lecture-rooms, a library and reading-room, balance-rooms, &c.; in all, thirty rooms. There is a laboratory of general chemistry with 133 working tables, each of which has under it three complete sets of drawers and cupboards; a laboratory of analytical chemistry, with 108 benches; an organic laboratory having benches for twenty-six students; two laboratories of sanitary chemistry, in which, since 1887, 10,000 samples of water have been analysed for the Massachusetts Board of Health; a laboratory for gas analysis, and three for industrial chemistry, besides a number of smaller ones.

The John Cummings Laboratory of Mining Engineering and Metallurgy comprises laboratories for milling, for concentrating, and for smelting ores, as well as for testing them by an assay and by the blowpipe, and a library comprising the most important literature of the subject.

The engineering laboratories comprise laboratories of steam engineering, of hydraulics, a laboratory for testing the strength of materials, and a room containing cotton machinery.

The most prominent feature of the steam laboratory (Fig. 2) is an Allis triple-expansion engine, having a capacity of about 150 horse-power when running triple, with 150 lbs. initial pressure in the high-pressure cylinder.

The laboratory also contains a 16 horse-power Harris-Corliss engine, and an 8 horse-power engine used for giving instruction in valve-setting. In addition to these, there is a great variety of apparatus, including condensers, calorimeters, injectors and ejectors, steam pumps, &c., directly connected with studies in steam, also apparatus for testing the efficiency of transmission of power and for measuring the power transmitted.

The hydraulic laboratory (Fig. 3) contains a closed tank, 5 feet in diameter and 27 feet high, extending from the basement under the lower floor to the upper part of the room on the second floor. This is connected with a stand-pipe, 10 inches in diameter and over 70 feet high, so arranged that the water may be maintained at any desired point, glass gauges along the stand-pipe serving to measure the height. The stand-pipe is con-

of a thesis upon some chosen subject. This is always of a nature of an experimental research, and may be either purely

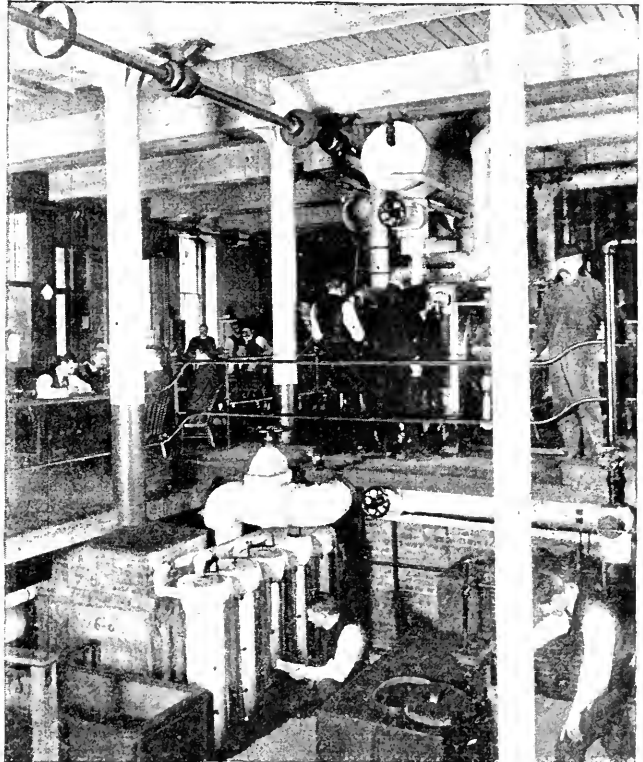

FIG. 2.—Engineering Laboratory: an Engine Test.

scientific or technical in its nature. In many cases the results of this work have been of such a character as to merit

publication, and a considerable number of such papers have appeared in scientific and technical journals.

A high value is attached to the thesis work; and rightly. In it the student is placed in the attitude of an independent investigator. He is thrown to a large extent upon his own resources in devising methods of investigation and in finding means of overcoming the difficulties that always arise in original work. Such individual aid is given to each student as is necessary to keep him from too great loss of time from using wrong methods of procedure, without, on the other hand, giving him such specific directions as would entirely deprive his work of originality. He thus acquires a knowledge of the patience, care, and time which it is usually necessary to spend upon the experimental solution of any new and untried problem. This early training of investigators has produced excellent results. A register of the publications of the Institute and of its officers, students, and alumni, between 1862 and 1882, was compiled by

electd President for the current term. Mr. E. S. Godrich exhibited some recent additions to the University Museum, including a specimen of *Palæospondylus*, a specimen of *Indrilevicandatus*, and the brain of "Sally," the chimpanzee, who was so well known at the Zoological Gardens. Mr. Wynne-Finch, of New College, read a paper on mining; and Mr. Gordon, of Keble College, read a paper on the effects of temperature on the incubation of eggs.

The Ashmolean Society held a meeting on Monday, October 30, when Mr. A. G. Vernon Harcourt read a paper on the properties of ferrous chloride, and Dr. W. B. Benham one on the effects of sedentary life on certain annelids.

The Junior Scientific Club seems to have ousted the older and more senior Ashmolean Society almost completely. At the meetings of the latter, which offers communications of at least equal, perhaps of greater, interest than the Junior Society, the attendance seldom reaches a dozen, and of these a large proportion consists of ladies who are more or less directly interested in the lecturer. The attendance at the Junior Scientific Club, on the other hand, is always large, and frequently exceeds fifty. The reason of this disparity is not easily found. Some people attribute it to the lesser formality of the proceedings of the younger society, and to the fact that smoking is permitted during the meetings.

The Sherardian Professor of Botany announces a course of six lectures on forestry, to be given by Dr. J. Nisbet, at the Botanic Garden, daily from Monday, November 6, to Saturday, November 11, inclusive.

CAMBRIDGE.—The Engineering Laboratory Syndicate ask for a grant of £1000 to enable them to complete the buildings required for the accommodation of the department. From private sources nearly £5000 have been subscribed for the purpose, but this is insufficient for the whole of the work in contemplation. Prof. Ewing reports that no less than seventy-four students have entered for courses in engineering during the present term; and it is very desirable that their work should not be hampered by delay in providing the necessary rooms for their accommodation. It had been hoped that subscriptions towards so valuable an extension of the scientific equipment of the University would flow in liberally, but the stream of benefaction seems for the present to have dried up.

The scheme for examinations in agricultural science will come before the Senate for decision on November 9. Already a note of dissent has been sounded by a well-known theological graduate.

Mr. R. A. Sampson, Fellow of St. John's, has been appointed Professor of Mathematics at the Newcastle College of Science.

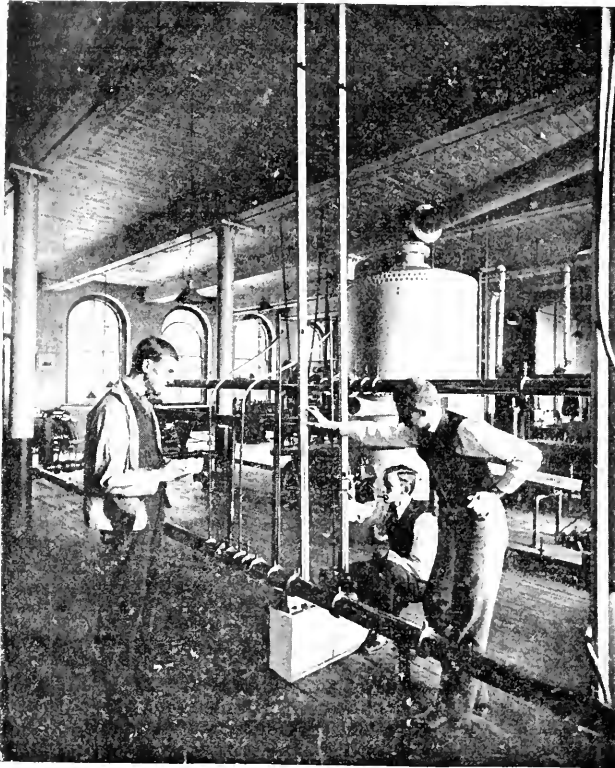

Fig. 3.—Hydraulic Laboratory.

Prof. W. R. Nichols, and has been brought up to date by the late Prof. L. M. Norton and Prof. A. H. Gill. The list includes books, pamphlets, reports, contributions to periodicals—everything, in fact, except contributions to daily newspapers—made by the teaching staff during their connection with the school, and by students during their connection with the school and in after life. As Prof. Gill remarks, no truer index of the value of an educational institution can be found than the work which its alumni have done and are doing, and when we say that the total number of titles of communications given in the list is nearly 2,900, thirteen hundred of which have been added since 1888, it will be agreed that the system of training at the Massachusetts Institute of Technology is one that gives a love of investigation to the students; and to the man of science this desire to extend natural knowledge should be the end and aim of all scientific education.

#### UNIVERSITY AND EDUCATIONAL INTELLIGENCE.

OXFORD.—At a meeting of the Junior Scientific Club, on Friday, October 27, Mr. M. D. Hill, of New College, was  
NO. 1253, VOL. 49]

#### SCIENTIFIC SERIALS.

*L'Anthropologie*, tome iv. No. 3.—The current number contains four papers of much interest. Dr. R. Collignon contributes an article on the proportions of the trunk among the French, whom he divides into three classes: (1) the Celts, in the sense in which Broca used that term, that is to say, a short, dark, brachycephalic and mesorhine people, such as those found in Auvergne, Limosin, and the centre of France generally; (2) the tall, fair, dolichocephalic Kymris, found in the north-eastern or Belgic departments of France; and (3) those who are really cross-breeds. The measures of the trunk are five in number:—(1) The total height, in the sitting position, from the inter-clavicular notch to the seat; (2) the maximum bi-acromial diameter; (3) the maximum bi-humeral diameter; (4) the maximum bi-iliac diameter; (5) the maximum bi-trochanteric diameter. The following measures of the thorax are also taken: (1) the distance from the superior border of the clavicle to the inferior border of the false ribs, measured on a perpendicular line passing over the nipple; (2) the transverse width, and (3) the antero-posterior width, at the height of the nipples; (4) the circumference just below the nipples; (5) the circumference about 3 c.m. below the nipples. Observations were made on sixty Celts, seventy Kymris, and eighty Celto-Kymris. It appears that there is a regular gradation between the three classes. Among the brachycephalic Celts, the trunk and thorax are shorter than amongst the dolichocephalic Kymri, whereas in all other respects the measurements of the Celt exceed those of the Kymri. The people of mixed blood occupy an intermediate position. When the total height or the length of the

trunk is taken as a standard, the same general results are obtained, but the length of the thorax as compared with that of the trunk is greater in the Celts than in the Kymri. A comparison with similar measurements of various races of Tunis, negroes of the Soudan, and a single bushman, leads the author to the conclusion that in any given race all the measures of the body increase in absolute length and diminish in relative length as the stature increases, and *vice versa*.—In a paper on the Matriarchate in the Caucasus, Maxime Kovalevsky adduces facts which tend to prove that the ancestors of the mountaineers who live in the high valleys of the Caucasus at the present time practised what Morgan and Fison have called "group marriage."—Dr. H. Ten Kate gives an account of his researches in Malaysia and Polynesia during a scientific mission promoted by the Royal Geographical Society of the Netherlands, in the course of which he examined 999 Malaysians of different races, and 314 Polynesians. The predominant colour of the skin among the Malaysians is brown and dark brown, while among the Polynesians it is light brown and yellow. The Malaysians have generally wavy or curly hair, but straight hair is a characteristic of the Polynesians. The Malaysians are mesocephalic; the Polynesians brachycephalic. Among the Malaysians the nose is concave or *retroussé*, while the Polynesian noses are straight and aquiline in about equal proportions. As regards stature, the Malaysians are below middle height and the Polynesians tall.—Dr. P. Topinard gives an interesting account of Anthropology in the United States, where the subject has received so much attention during the last few years. The question of the antiquity of man in North America is discussed at some length, and the general conclusion arrived at is that it does not exceed 15,000 years. Dr. Topinard proposes to continue the examination of American questions in future numbers of *L'Anthropologie*.

*Bulletin de l'Académie des Sciences de St. Pétersbourg*, New Series, vol. iii. No. 3.—Preliminary report on the results of the archæological expedition to the Orkhon River, by W. Radloff. The ruins of Khara-Calgasun, the old city of the Ugurs, close by which lie the ruins of a palace of the Mongol Khans, have been explored, as also the Tükkie monuments in the valley of Tsaidamin-nor. In the monastery of Erdeni-dsu, about 27 miles south-east of Kosho-tsaidam, and 20 miles south of Khara-balgasun, the expedition has discovered several stones, covered with Mongolian, Tibetan, and Persian inscriptions which, in Prof. Radloff's opinion, prove that the old town of Karakorum stood at this spot. This position would agree with the Chinese indications which give to Karakorum a position of 100 *li* south of Ughel-nor. Many maps, plans, photographs, and casts of inscriptions have been brought in by the expedition.—Reports of MM. Clements, Dudin, Yadrintseff, and Lewin, relative to the same expedition.—Photographic spectrum of Nova Aurigæ, 1892, observed at Pulkova, by A. Belopolsky. Full details of the observations and measurements made on [the photographs are given. In his conclusions the author considers an eruption of the star as not probable, and concludes in favour of a superposition of the spectra of two or more bodies in the spectrum of the Nova.—On a group of peculiar rocks brought from the Taimyr-Land by A. Middendorff, by Dr. K. Chrustschoff.—On a new species, *Felis pallida*, from China, by Eug. Büchner. The species is near to *Felis chaus*, Güld., but partially differs in coloration, as also in the length of the tail. The specimens described were brought in by Przewalski in 1884 from the south Tetung ridge in Gan-su.—On the state of the basin of the Black Sea during the Pliocene Age, by N. Andrussoff. The following conclusions are arrived at: The now deep part of the Black Sea remained submerged since the Sarmatian epoch, and was covered with brackish lakes of the Caspian type; however, it was separated from the Mediterranean by a continent which occupied the place of the Archipelago and the Egean Sea. This continent was submerged, and a communication between the Mediterranean and the Black Sea was established at a very recent epoch, when the Black Sea already had its present shape.—On the differential equation of Lamé-Hermite, by F. Brioschi.—On the Perseids observed in Russia in 1892, by Th. Bredikhin. Observations, with the view of determining the decrease of the inclination of the orbits of the meteors, in proportion to the time-interval from August 10.5, have been made throughout the duration of the shower at Moscow, Pulkova, and a place in the district of Kineshma. All observations, including 339 meteors, are embodied in seven lists, or charts, published in full. The radiant has been deduced from each chart separately,

and given for eight different dates, from July 29 to August 29. The surface of radiation has a circular form, its diameter having a length of nearly 45°, and the radiant point really suffered displacement.—On the embryonal development of the birch, preliminary communication, by S. Nawaschin. It has two phases in common with the development of the Casuarine, which therefore cannot be separated from other Angiosperms. They are evidently connected, through the birch, with the lower Angiosperms (Apetales).—On the representation of the daily change in the temperature of the air by means of Bessel's interpolation formula, by H. Wild. Critics of conclusions, opposed to those of the author, and arrived at by Dr. Paul Schreiber, director of the Chemnitz Meteorological Institute.

## SOCIETIES AND ACADEMIES.

• LONDON.

Entomological Society, October 18.—Henry John Elwes, President, in the chair.—Mr. R. Adkin exhibited two *Leucania vitellina* and one *L. extranea*, taken in the Scilly Islands, in August 1893.—Mr. R. South exhibited a specimen of *Polyommatus balticus*, and a number of varieties of *Chrysophanus phlaaz*, captured in Kent, in September last, by Mr. Sabine; also a curious variety of *Argynnis euprosyne*, taken in Lancashire in May 1893; a pallid variety of *Vanessa urticae*, taken in Monmouthshire, in July 1893; and a *Triphena pronuba*, the right wings of which were typical, and the left wings resembled the variety *innuba*, caught at sugar, in Dovedale, Derbyshire, in July 1893.—Mr. G. H. Verrall exhibited a specimen of the Tsetse (*Glossina morsitans*), and also one of the common European allied species (*Stomoxys calcitrans*). He also exhibited a specimen of *Hamatobia serrata*, Dsv., which he stated was not uncommon on cattle in England, but believed to be harmless; while in North America the dreaded "horn-fly" is said to be the same species.—Mr. Elwes exhibited a larva which he had found three days previously under stones on a moraine, apparently quite destitute of vegetation, in the Austrian Tyrol, at an elevation of about 7000 feet. He remarked on the number of Alpine butterflies, some of them in fresh condition, which he had seen whilst chamois-hunting in the Austrian Tyrol during the last week, and he suggested that in such a fine autumn as the present one collectors might find more novelties among the larvæ of Alpine species than in the summer.—Col. Swinhoe read a paper entitled "A List of the Lepidoptera of the Khasia Hills" (pt. 2). The President said he thought all entomologists would be grateful to Col. Swinhoe, Mr. Hampson, Mr. Meyrick, and others for the work they had recently been doing in describing the moths of India; but as the district of the Khasia Hills was probably richer in species than any other part of India, except Sikkim, and new species were being received almost daily, it was impossible to make any list complete. Mr. Jacoby, Mr. McLachlan, Mr. Jenner Weir, and Col. Swinhoe continued the discussion.—Mr. E. Meyrick communicated a paper entitled "On a Collection of Lepidoptera from Upper Burma." The author stated that the species enumerated in the paper were collected by Surgeon-Captain Manders whilst on active service in the Shan States and their neighbourhood, shortly after the British annexation of the territory. A discussion followed, in which the President, Surgeon-Captain Manders, and Col. Swinhoe took part.

PARIS.

Academy of Sciences, October 23.—M. de Lacaze-Duthiers in the chair.—Observations of Brooks' Comet (1893, October 16), made at the great equatorial of the Bordeaux Observatory, by MM. G. Rayet and L. Picard.—On the movements of the surface of the heart, by M. Potain. The object of this investigation was to obtain the interpretation of the cardio-pulmonary sounds resulting from the movements communicated to the lung by the heart, and the local inspiration phenomena produced by these movements. The movements were recorded by an instrument capable of tracing simultaneously at several points of the surface the displacements in all directions. From these traces the actual trajectories of the points were constructed, the points being five taken on the accessible surface of the ventricle of an animal with an open chest. The general movement thus indicated is, during systole, a rapid retreat of the surface and an equally rapid translation to the right; this is, in fact, the well-known torsional motion. At the end of the ventricle, the retreat is only effected towards the end of the systole. At the beginning

of diastole, the whole wall rapidly collapses; it then rises, slowly at first, as the blood gradually enters the ventricle, and then rapidly, when the systole of the auricle takes place. On comparing these trajectories with the sounds heard in man and sometimes also in animals, it is found that their amplitude is greatest where these sounds are most intense and frequent, that their direction is that calculated to produce upon the lung a rapid aspiration during systole, and that the rhythm of the sound is itself in correspondence with the variations of speed of the movement. The relation thus discovered solves a complex problem of auscultation.—Observations of the new comet Brooks (1893, October 16), made at the Paris Observatory (west equatorial), by M. G. Bigourdan.—On certain families of gauche cubics, by M. Lelievre.—On the kinetic interpretation of the function of dissipation, by M. Ladislas Natanson.—Determination of the velocity of propagation of an electric disturbance along a copper wire, by means of a method independent of any theory, by M. R. Blondlot.—Analysis of a vanadiferous oil, by M. A. Mourlot. This oil, of slight density varying between 1.15 and 1.20, is of a fatty appearance, and contains 51.52 per cent. of volatile matter. The percentage of hydrogen is much lower than that of the vanadiferous oil recently discovered in Argentina by Mr. Kyle, and carbon and nitrogen show a larger percentage. The most interesting feature of this oil is the presence, in the ashes, of a large proportion of vanadic acid in the shape of alkaline and metallic vanadates. It also occurs free in this oil, and may be extracted by washing with ammoniacal water. A quantitative analysis gave a percentage of 0.24 of vanadic acid in the oil, and 38.5 per cent. in the ashes. As the oil is abundant, some important applications of vanadium may be looked for if the properties of the metal are found to be commercially valuable.—On the perfume of the violet, by MM. Ferd. Tiemann and P. Krüger. This is an account of the success so far obtained in the analysis of the perfume-oil contained in the fresh flower of the violet or the dry root of the iris, and its synthesis from lemon-juice.—New synthesis of erythrite, and synthesis of an isomeric erythrite, by M. G. Griner.—Influence of organic solvents upon rotatory power, by M. P. Freundler.—On certain chemical conditions of the activity of brewers' yeast, by M. J. Effront. It was found by a series of experiments that various kinds of yeast, after treatment with gradually increasing quantities of ammonium fluoride, acquired a very considerable fermenting power, estimated at about ten times that developed before this treatment. It also imparted properties which some physiologists had up to now considered as the privilege of certain species.—On the propagation of the *Pourridié de la Vigne* by slips and graft-slips placed in sand "in stratification," by M. A. Prunet. The storage of grafting slips in moist sand for the next season encourages the growth of small fungi upon them, which give rise to a fatal disease of the vine.—On a dislocation in the shape of a mushroom in the Alps of Haute-Savoie, by M. Maurice Lugeon.—On a halo observed at Créteil, on October 22, 1893, by M. Georges Pouchet.

GÖTTINGEN.

Royal Society of Sciences.—The following papers of scientific interest appear in the *Nachrichten* of July to September 1893:—

July 26.—E. Ehlers: On the morphology of the Bryozoa. W. Nernst: Dielectric coefficients and chemical equilibrium. W. Holtz: On direct impressions of magnitude in artificially induced optical illusions. W. C. Röntgen: On the influence of pressure on the electric conductivity of electrolytes.

August 2.—O. Wallach: On compounds of the camphor series. W. Voigt: Observations on rigidity under homogeneous deformation. Also, on an apparently necessary extension of the theory of elasticity. W. Meyer: G. F. Grotefend's first announcement of his decipherment of the cuneiform character.

AMSTERDAM.

Academy of Sciences, September 30.—Prof. van de Sande Bakhuisen in the chair.—Mr. Bakhuis Roozeboom described the method for the determination of oxygen dissolved in water studied by Dr. Romyn. This method unites simplicity and accuracy, and can be executed outside the laboratory. Its use in hygiene was indicated by two series of researches, the first aiming at the determination of the quantity of pure water necessary to improve that of the canals of Leyden, whilst the other concerned the analysis of the oxygen in different parts of the water-con-

ducts in Arnhem, in view of the corrosion of the iron tubes.—Prof. Schoute treated on sections and projections of tessaract and hexadecassaract.—Prof. Korteweg dealt with the classification of the curves of the third class or the third order, and a graphical representation of the totality of these curves and their division in three tribes by the points of a plane, every point representing all the projective and reciprocal transformations of the same curve.

Netherland Zoological Society, September 30.—M. Lubrecht in the chair.—M. van Wyhe contributed a paper on the ventral nerves (ventral roots) of Amphioxus. With the help of Golgi's method the author was able to state that the ventral nerves are furnished with true terminal organs, Ketzius not having succeeded to observe them. The author then discussed the question as to why the ventral part of the motor nerves lies within the myotome, and not, as with the dorsal part is the case, at its medial side. Finally, the same author pointed out that in Amphioxus the ventral nerves contain sensory nerves also.—M. J. T. Oudemans exhibited specimens of *Alytes obstetricans*, taken by him for the first time in the Netherlands, viz. near Valkenburg (Limburg).—M. Horst exhibited a new gigantic European earthworm, obtained near Arcachon (France), and which he referred to a new species (*Allolobophora Savignyi*). The same author observed the larva of a dipterous insect within the mouth of a Perichæta from Java.—M. Hoek made remarks on the spawning of the Anchovy in the Zuiderzee. Another communication from the same author contained an account of trawling experiments in the North Sea.

CONTENTS.

PAGE

|                                                                                    |    |
|------------------------------------------------------------------------------------|----|
| British Forest Trees . . . . .                                                     | 1  |
| Astronomy of the Nineteenth Century . . . . .                                      | 2  |
| Our Book Shelf:—                                                                   |    |
| Roscoe: "Inorganic Chemistry for Beginners" . . . . .                              | 3  |
| Muir: "The Chemistry of Fire" . . . . .                                            | 3  |
| Taylor: "Solutions of the Exercises in Taylor's Euclid I. to IV. . . . .           | 3  |
| Letters to the Editor:—                                                            |    |
| The Recent Glaciation of Tasmania.—Dr. Alfred R. Wallace, F.R.S. . . . .           | 3  |
| The Supposed Glaciation of Brazil.—W. T. Thiselton-Dyer, C.M.G., F.R.S. . . . .    | 4  |
| The Nativity of Rama.—Colonel Walter R. Old . . . . .                              | 4  |
| On the Latent Heat of Steam.—P. J. Hartog and J. A. Harker . . . . .               | 5  |
| Artificial Amœbæ and Protoplasm.—Dr. G. Quincke . . . . .                          | 5  |
| Human and Comparative Anatomy at Oxford.—Prof. J. Burdon Sanderson, F.R.S. . . . . | 6  |
| Asymmetrical Frequency Curves.—Prof. Karl Pearson . . . . .                        | 6  |
| Telegony.—Dr. George J. Romanes, F.R.S. . . . .                                    | 6  |
| An Ornithological Retrospect. By Dr. R. Bowdler Sharpe . . . . .                   | 6  |
| Henry Oldenburg, First Secretary of the Royal Society. By Herbert Rix . . . . .    | 9  |
| The Natural History of East Equatorial Africa. By Dr. J. W. Gregory . . . . .      | 12 |
| Notes . . . . .                                                                    | 12 |
| Our Astronomical Column:—                                                          |    |
| Brooks' Comet . . . . .                                                            | 18 |
| The Planet Jupiter . . . . .                                                       | 18 |
| The Wave-Lengths of the Nebular Lines . . . . .                                    | 18 |
| Geographical Notes . . . . .                                                       | 18 |
| Institution of Mechanical Engineers . . . . .                                      | 18 |
| The Arbuthnot Museum, Peterhead. By Alexander Meek . . . . .                       | 20 |
| The Massachusetts Institute of Technology. ( <i>Illustrated</i> ) . . . . .        | 20 |
| University and Educational Intelligence . . . . .                                  | 22 |
| Scientific Serials . . . . .                                                       | 22 |
| Societies and Academies . . . . .                                                  | 23 |

THURSDAY, NOVEMBER 9, 1893.

## DR. WERNER VON SIEMENS.

*Personal Recollections of Werner von Siemens.* Translated by W. C. Coupland. (Asher and Co., 1893.)

WERNER VON SIEMENS was a representative man of this nineteenth century, the century in which "the art of directing the great sources of power in nature for the use and convenience of man" has been more studied and applied than in any other, we were almost saying than in all others. And no other century has produced quite such a man—a man in whom the ability to apprehend the secrets of nature was united with the ability to apply them to industrial purposes. Many circumstances combined to favour him, both of a personal and public character. His father was evidently a man of strong common sense; his mother was refined in her tastes, cultured in her mind, and devoted to her children. The children were fortunate in having such parents to guide and watch over them. At that time, as now, first-rate schools and colleges existed throughout what now forms the German Empire, and in these a good mathematical and scientific education was to be obtained, which was taken advantage of by the Siemenses, both as boys and young men. Another matter which was specially favourable to Werner Siemens was his military training; regular drill, strict discipline, endurance, and implicit obedience, learnt and practised in his own person, helped to make a man of him. Besides this, these young men were born just at the right time, if we may say so, to take advantage of the recent discoveries in, and formulation of the principles of, the natural sciences of heat and electricity and magnetism. These sciences were at that period in the active, nascent state. Galvani and Volta, Gauss and Weber, Oersted and Faraday had set the world wondering, and themselves, the philosophers, thinking, analysing, and systematising, and the men of imaginative minds, the poets of industry, inventing. Great discoveries had been made in former days, but these were in the realms of the Cosmos; they were not suitable for application to the daily uses of men, and were not, as those were, startling and impressive.

One of the first applications of electricity was to electro-plating, the covering of the baser metals with a thin layer—almost a film—of the nobler metals. And when in 1842 Werner Siemens applied for and obtained a Prussian patent, no process of galvanic gilding or silvering was known in Germany. He tells us that he had experimented with all the gold and silver salts known to him, and besides the hyposulphites had also found the cyanides suitable. The use of the latter had been made and patented by the Messrs. Elkington of Birmingham, so that a patent was only granted to Werner Siemens for the former. His brother William was despatched to England, where he took out a patent which he succeeded in selling to the Messrs. Elkington for £1500, and this money helped the young men on their road to independence and fame.

Whether it is that the minds of those engaged on the problems connected with the application of the forces of

nature to industrial purposes are necessarily turned towards the measurement and regulation of these forces, we would not say, but meters and governors seem to have a special fascination for them. And so it was with these men. The problem of the regulation of the steam-engine seems to have proposed itself to the mind of William; both brothers, however, were engaged in its solution, and the differential regulator or chronometric governor was the result.

In the work we are reviewing there are few dates, but fortunately Dr. Pole's "Life of Sir William Siemens," and the scientific and technical papers of the brothers themselves, already published by Mr. John Murray, supply these. Quoting then from a paper by C. William Siemens on the progress of the electric telegraph, we find that "in the year 1845, when the practical utility of electric telegraphs had been demonstrated in England, several continental governments had determined upon their establishment." A Royal commission was appointed in Prussia, of which Dr. Werner was the most active member. They favoured an underground system, and charged him to institute experiments.

Here we stand on the threshold leading to, and opening up on, one of the greatest achievements of modern days. The underground system was only a stepping-stone to submarine telegraphy, and was not in itself a permanent although a temporary success. But there in Germany just at this time something was wanted, and here in England it existed; and these two brothers—the elder there, the younger here—were the means of completing the circuit. In the winter of 1844-45, "I recollect well seeing the first specimen of gutta-percha exhibited at the Society of Arts, I think by Mr. Montgomerie. . . . He was kind enough to give me a piece, which I forwarded to my brother, Dr. Werner Siemens. . . . I sent him this piece of gutta-percha in order that he might try whether it was not superior to india-rubber for insulation purposes. He did so, and after some time, having procured for him at his request a further supply, he made experiments, and in the course of about twelve months he proposed to the Prussian Government the use of gutta-percha for insulating telegraphic land wire." Dr. Werner constructed a screw press, by which the heated gutta-percha was cohesively pressed round the copper wire under the application of high pressure; this was well insulated, and permanently retained its insulation. And so, just at the time that it was wanted, a substance hitherto unknown came to light!

In the summer of 1847 the first long subterranean wire from Berlin to Grossbeeren was laid, and the telegraph commission had under consideration the employment "both of the wires coated with gutta-percha by pressing; and also of my dial and printing telegraph in the telegraph system about to be introduced into Prussia." On October 12, 1847, the factory of Siemens and Halske was started, but Dr. Werner still retained his military commission. In June, 1849, he requested his discharge from the military service, and soon after also resigned his office as technical manager of the Prussian State telegraphs.

We are not attempting in any detail to survey the whole field of Dr. Werner von Siemens's activity; we are

simply drawing attention to the most prominent landmarks, which may be used as points from which to carry out the triangulation, and as stations on which to set up the necessary delicate instruments of observation. Dr. Werner von Siemens was a remarkable man; he had a most successful career; he left indelible marks on the progress, both scientific and industrial, of his day, and there are lessons to be learnt from his work, and from his systems and methods.

Let us rest here a moment. This factory was just the very thing that was required at the time. The two members of the firm were—the one, Dr. Werner Siemens, a man possessing clear scientific views of natural forces and phenomena, and an inventive mind; the other, Mr. Halske, a man thoroughly acquainted with mechanics, the use of machines and tools, and possessing the skill to make, and to teach others how to make, delicate mechanism. There was a demand in Germany, in Russia, in England, and elsewhere, for what they could make; their work was thoroughly to be relied upon, and orders streamed in on them.

Dr. Siemens says somewhere in this volume that everything he has done for natural science has been due to a claim made upon him by applied science. It was the absolute necessity under which he was to make accurate measurements that set him to work to invent an exact standard of resistance, possessing which he was afterwards able to elaborate a rational method for testing the electrical condition of submarine cables. Previously to this, Jacobi's standard, which was a determined length of copper wire of a determined section, was used at the Berlin factory, but copies of these standards were found to differ so much that Dr. von Siemens set to work to introduce a standard of his own. In revolving this matter in his mind he came to the conclusion that "it was both desirable and convenient to be able to combine a definite geometrical notion with the unit of resistance." He therefore used mercury, the only metal fluid at ordinary temperatures, whose resistance cannot be affected by molecular variations, made a series of important experiments, and finally having defined his unit as a metre length of mercury of a square millimetre section at  $0^{\circ}$  C., he sent copies of his standard to physicists and telegraph engineers suggesting their use in determinations of resistance. We refrain from entering into a discussion as to the relative values of units, whether Weber's absolute unit, the B.A. c.g.s. unit, the ohm, or others; the main point is that Dr. von Siemens wanted a clearly defined unit, he had found the absolute necessity for it in his electrical work, and now possessing it he was able to press forward to other achievements. Here was a decided step in advance. Measurements which had previously been variable were now uniform, tests which formerly could not have been made could now be applied, and work which was formerly carried on more or less by rule-of-thumb, could now be done with a certainty of result.

We have referred to submarine telegraphy as one of the great achievements of this century, and the brothers Siemens, Werner, William and Carl, have taken a share in it. Almost every submarine cable of importance has been shipped from the Thames. The first tentative efforts were made in England, and the final successful results have been achieved here. Cable-laying is now one of the

scientific arts, and our author has had a large share in making it so.

We are here brought face to face with the two sides of the question, the scientific and the technical, and at the same time with two national characteristics, the combination of which has produced these results: English enterprise, German investigation. And there is yet another link in this chain of events, which it is difficult to see how we could have done without, the finally unsuccessful but at the time needful and useful practical experiment of underground cables in Prussia. "My friend Halske" . . . "was the first to encounter these phenomena." "Halske found, first of all, that with shorter lines our self-interrupting indicator telegraphs acted with much greater speed than corresponded to the resistance of the line. When communication between Berlin and Cöthen had been established, a distance of about 95 English miles, the giving apparatus ran with double velocity, whilst the receiving apparatus stopped altogether. This at the time inexplicable phenomenon occurred the earlier the better the lines were insulated, which induced Halske purposely to impair the insulation of the line by the addition of artificial watery by-passes." "When the underground line had been extended to Erfurt, Halske's watery by-passes were no longer sufficient. But meanwhile I had become convinced that the peculiar behaviour of the underground wires could only be ascribed to the electrostatic charge already observed at the testings in the factory, the wire namely forming the inner, the damp soil the outer coating of a Leyden jar." "The very surprising and disturbing phenomena of electrical charges in underground conductors required thorough study. Further, it was necessary to establish a system for the determination of the situation of faults in the conduction and insulation of underground wires by measuring currents at the end of the wires. The uncertainty of the measurements of currents led to the necessity of replacing them by resistance measurements, and thereby to the setting up of fixed reproducible standards of resistance and scales of resistance. For this purpose the methods and instruments for current and resistance measurements had also to be improved and adapted for technical use; in short, a whole series of scientific problems had cropped up, the solution of which was called for by technical needs."

And so later on, when the actual problems of submarine telegraphy had to be solved, Dr. Werner took his share in their solution all the more ably because of the experience he had already gained, and of his system of studying the science on which the art was founded. His narrative, especially in this connection, is full of adventures, not unaccompanied with danger, the description of which is always interesting and often graphic.

The lesson of the life, of which a few personal recollections are given in this volume, appears to be this: Find out the work you were sent here to do, and do it with your might. All the work that has to be done is not great work, but may be good work for all that; it may not lead to honour and fortune; but it has to be done, and if you are the one who has to do it, do it well.

Dr. von Siemens had a work to do; it matters little, it seems to us, whether others were engaged on the same work or not; he did his share. As to who the person is

that first made a particular discovery is often a difficult question to settle; it is, after all, perhaps a matter of accident, or shall we say rather a matter of gift. But the man who follows his guiding star, and is led by it to honour, and success, and fortune, is one whose example others may well follow, even though it may not lead those others there. A great work or a very little work has to be done; set to work and do it. There is your guiding star shining clear and bright; follow it. There may be bright scintillations to the right and left; they may be merely *ignes fatui*, or they may be other men's guiding stars; they have nothing to do with you. You may have to work hard, but any way try to work wisely!

### IRON ORES.

*The Iron Ores of Great Britain and Ireland.* By J. D. Kendall, F.G.S. With numerous illustrations. (London: Crosby Lockwood and Son, 1893.)

ALTHOUGH numerous works relating to mineral deposits of particular districts have appeared at different times, besides larger treatises dealing with the subject generally, such as the late John Arthur Phillips' "Ore Deposits," the want of a systematic account of our present knowledge of the origin and occurrence of British iron ores, and of the means of working these ores, has long been noticed. This want will be supplied by the volume under consideration. The author is a mining engineer of thirty years' experience, and he has been able to supplement a careful study of the available literature by unpublished information derived from his own observations. The result is a volume that will prove of substantial value as a work of reference to all interested in the iron industry of this country, more especially as the published information can only be found by a laborious search through the volumes of the Journal of the Iron and Steel Institute, and of the Transactions of other societies.

Mr. Kendall has broken up his volume, which covers 430 pages, into four parts. In the first, he gives some interesting information regarding the early working of iron ores, of which there is indirect evidence in nearly all the valleys of the Lake district. The presence of Roman coins, some of them as early as Trajan, found in heaps of iron cinder in Sussex and near Monmouth, proves that iron was made at a very early period from the red and brown oxides. Indeed, it is possible that these beds were worked at an even earlier period, for flint flakes and rough unturned pottery were found by Boyd Dawkins on the surface of a slag heap near Battle. In the second part, the author discusses the geological position and mineralogical characteristics of iron ore deposits. The third section deals with the age and origin of the deposits, and the last describes the method of searching for and working iron ores, with useful information on working costs, selling prices, and conditions of leases.

The author's task is not a light one. Within the limits of 430 pages to describe even the main features of the long list of mines which give the United Kingdom (1891) its 12,777,689 tons of iron ore, valued at £3,355,860 at the pit's mouth, is by no means easy. With the aid of

forty-one illustrations and five folding plates, he has, however, been enabled to compress a large amount of information within a comparatively small compass, the value of the descriptions being increased by the insertion of bibliographies for each district.

As would naturally be expected, all the ores noticed in the volume are not treated with equal fulness, preference having been given to those of the greatest commercial or scientific importance. It is to be regretted that the great lode of Perran, near Truro, should have been dismissed in a single line. The late Sir Warrington Smyth made many attempts to introduce this curious deposit to the notice of ironmasters, and it has formed the subject of numerous important memoirs. The most interesting descriptions given by Mr. Kendall are perhaps those relating to the district with which he is specially acquainted—the hæmatite district of West Cumberland and Furness, a district which has received less attention from geologists than any other of equal importance in the British Isles. The ores are of special value for the part which they play in admixture with the poorer qualities of ironstone, as well as for the production of Bessemer pig-iron. So irregular, however, are these deposits that the boring-tool may easily pass within a few inches of a mass worth thousands of pounds without discovering a trace of it. There can be no doubt that the acquirement of an accurate practical knowledge of these irregular deposits, of which the surface tells no tale, is the most difficult subject with which the mining engineer has to deal, and yet in many cases the difficulty is entirely ignored, with the result that the cost of exploration is enormously increased.

The chapter on the ironstones of the carboniferous rocks contains little that is new, the bulk of the information being contained in the "Memoirs of the Geological Survey." The analyses given relate to the iron ores collected by S. H. Blackwell, and the author might with advantage have mentioned the fact. The formation of this collection marked an epoch in the history of metallurgy, for, notwithstanding the magnitude of the interests involved in the iron and steel industries, no systematic collection representing the workable ores of the kingdom had been made until the Great Exhibition of 1851. The want was then supplied by the liberal exertions of Mr. S. H. Blackwell, a Dudley ironmaster, who, after the exhibition, presented this extensive and interesting series to the Museum of Practical Geology, munificently placing a sum of £500 at the disposal of Dr. Percy towards defraying the cost of their analysis. The results were subsequently published at Government expense in the "Memoirs of the Geological Survey."

The perplexing and fascinating subject of the genesis of iron ore deposits is treated by the author with great fulness, and his conclusions deserve attentive consideration. He brings forward a large amount of evidence in support of the views propounded by Sorby and by Huddleston that the ores of Cleveland and Northamptonshire were produced by the replacement of an ordinary limestone, and extends the theory to all deposits occurring in the secondary rocks. The source of the iron, he believes, may have been in the clays, with which all these deposits are closely connected. In the case of the red hæmatites, he is of opinion that the most likely

source of the iron is to be found in volcanic emanations of ferric chloride, a theory that appears more ingenious than sound. The author does not appear to have consulted the writings of recent foreign workers in this field. A study of the memoirs of R. D. Irving, Kimball, Van Hise, and H. V. Winchell, on the genesis of American iron ores, might have induced him to modify some of his views.

The author's remarks on the value of geology to the mining engineer deserve attention. It is undoubtedly of urgent importance for the economical utilisation of the iron ore resources of the kingdom, that those entrusted with the management of mines should have a more extended knowledge of the nature of irregular deposits than is too often the case. In these days of technical education, it is surprising to see money wasted in searching for these deposits in situations where some knowledge of stratigraphy would have shown that there was no chance of finding them. It is surely not too much to ask that mineral explorers should understand the elements of their work.

BENNETT H. BROUGH.

#### OUR BOOK SHELF.

*The Shrubs of North-Eastern America.* By Charles S. Newhall. Svo, pp. 249, with 116 woodcut figures. (London: G. P. Putnam's Sons, 1893.)

THE author of the present volume had previously written a similar book on the trees of the same region, which he defines as "Canada and the United States east of the Mississippi and north of the latitude of Southern Pennsylvania." This region is peculiarly rich in both trees and shrubs, most of which are hardy and will flourish in this country; and, as a matter of fact, many are familiar here in cultivation. Therefore a work of this kind appeals to amateurs on this side of the Atlantic as well as the other, and, although an unpretentious production, we can recommend it as a useful aid to those interested in the subject, especially to such as already possess some general knowledge of shrubs. The descriptive part is as free from technicalities as it could well be, and intelligible to any person whose knowledge of botany does not go beyond the veriest rudiments. The figures are for the greater part merely outlines, and so far accurate; yet hardly sufficiently detailed for use in our gardens, where American plants are associated with those of all other temperate climes. In the fields and forests of America they would be more serviceable. Botanical and popular names are given, and the derivation of the former, at least as to genera. The descriptive matter is here and there enlivened by appropriate poetical quotations; and the properties and uses of the more important plants are given. The Ericaceæ are perhaps the most numerous and attractive among the shrubs of Eastern America. No fewer than ten genera of this family are enumerated. Missing the Rose Acacia, *Robinia hispida*, we had almost convicted the author of omitting a favourite shrub; but we find it does not reach quite so high a latitude as 40° in America, though it is quite hardy in most parts of the British Islands. We also missed the *Menispermum*, *Wistaria*, and other climbers; but we suppose they will be included in the "Vines" of North America, to be dealt with in a third volume, announced by the author.

W. B. H.

*Mensuration of the Simpler Figures.* (Univ. Corr. Tutorial Series.) By William Briggs and T. W. Edmondson. (London: Clive Univ. Coll. Press, 1893.)

THOSE students who have acquired a fair knowledge of algebra, trigonometry, and Euclid, will find in this

book a most excellent guide to the mensuration of most of the more simple figures generally met with. Instead of presenting the reader with the stereotyped "rule and example" system, the authors have treated them as just a series of problems giving proofs of the formulæ used and numerous examples. That the book throughout is clearly and yet not too fully written speaks well for the student, and its scope is intended to meet the requirements of candidates for such examinations as the Intermediate B.A. and B.Sc. of the University of London. The measurement of rectilinear figures and the circle are first treated, followed by chapters on the geometry of the rectilinear solids and their surface-areas. This is succeeded by the methods of measuring the volumes of the rectilinear solids, and the last two chapters deal conclusively with the cylinder and cone and the sphere. The definitions throughout are well expressed, and the problems neatly worked out, while the figures could hardly be improved. We may mention that in the chapters relating to the rectilinear solids all figures have been drawn in perspective and shaded, giving the student a clearer idea of the forms of the various figures.

*The Discovery of Australia.* By Albert F. Calvert. (London: George Philip and Son, 1893.)

MR. CALVERT describes his book as "a simple statement of such historical facts as I could collect; and a reproduction of certain maps which more or less illustrate the gradual progress of knowledge regarding the great island continent, now called Australia." From this it will be inferred that there is nothing strikingly novel in the production. Mr. Calvert has found many tracings on old charts indicating a knowledge of the existence of a great southern continent, and he thinks that probably some individual navigator landed on the western coast of Australia in the fifteenth or sixteenth century, afterwards bringing the news of his discovery to Europe. A large portion of the book is devoted to the voyages of Capt. Cook, the reason being that "he was really the discoverer of Australia in its present geographical configuration." The volume is well printed, and the maps are finely reproduced. It is doubtful, however, whether the author has added much to elucidate the subject which he treats.

*Graphic Arithmetic and Statics.* By J. J. Prince. (London: Thomas Murby, 1893.)

IN addition to questions in Practical Geometry, the Science and Art Department has given notice that in the future questions in Graphic Arithmetic and Statics will be included. The issue of this small book is intended to supply students with information on these two subjects, sufficient for both the elementary and advanced stages. In forty-eight pages the author has brought together all the important problems, working them out clearly for beginners with the help of diagrams. In addition to those of the more elementary kind, a graphical determination of the square roots of numbers, the resolution of forces, resultant of parallel forces, &c., are also dealt with. Nothing that the reader will find in this book will be found superfluous, though it could with advantage be slightly extended.

*The Orchid Seekers.* By Ashmore Russan and Frederick Boyle. (London: Chapman and Hall, 1893.)

UP the Sarawak river to Kuching, and thence to Sirambau, went a small party in search of a blue orchid reported to exist in that region, and supposed to be *Vanda carulea* or *V. carulescens*. The leader of the party was a German botanist well versed in orchidology, who identified each plant as it was found, and delivered botanical discourses whenever an opportunity occurred. The story



is mainly one of adventure; nevertheless, much of scientific interest is weaved into it, and the boy who reads it without skipping the closely-printed portions will obtain some useful knowledge of the natural history of Borneo.

### LETTERS TO THE EDITOR.

[The Editor does not hold himself responsible for opinions expressed by his correspondents. Neither can he undertake to return, or to correspond with the writers of, rejected manuscripts intended for this or any other part of NATURE. No notice is taken of anonymous communications.]

#### Human and Comparative Anatomy at Oxford.

I AM sorry that Prof. Burdon Sanderson should state that a "misstatement" occurs in the article written by me in your issue of October 26, and still more so that whilst making such a charge he altogether omits to cite the "misstatement" which he sets out to correct.

My knowledge both of the University of Oxford and of the teaching of anatomy is, as a mere result of individual history, far more intimate than is that of my colleague, Prof. Sanderson, a fact which may account for some difference in our opinions on these topics.

When in 1885 the Convocation of the University was asked to sanction the payment of a small salary for a limited period to a lecturer in Human Anatomy—out of University funds already taxed to an inconvenient extent—there existed four ancient foundations in Oxford assigned to the support of teachers of "Anatomy," viz.: the Linacre Professorship of Human and Comparative Anatomy, the Tomlinian Lectureship of Anatomy, the Aldrichian Professorship of Anatomy, and the Lee's Readership in Anatomy. The small Tomlinian and Aldrichian endowments had been united in 1803 by Parliamentary authority, and the salary arising from them was in 1858 assigned to the payment of a demonstrator or demonstrators nominated by the Linacre Professor. There were thus, as teachers of anatomy in the University, the Linacre Professor and his Aldrichian demonstrator, and the Lee's Reader. Whatever may have been the conceptions of the ancient founders as to the nature of that study which they designated "Anatomia," or the intentions of University Commissioners who gave the title of "Professorship of Human and Comparative Anatomy" to Linacre's revived readership in medicine, or by whatever conditions the result may have been determined, it is certain that in 1885 the holders of the Linacre, Aldrichian, and Lee's professorships were not giving that "technical training in anthropotomy," that "topographical knowledge of the human body," which forms a part of medical professional education, and is administered in every hospital-medical school throughout the country. What these Oxford teachers were doing was to teach anatomy in its broad academic sense. They taught the anatomy of man and of animals as a branch of biological science, and I venture to assert that they taught the anatomy of man and of vertebrate animals with as ample material illustration, and in as complete and detailed a way, as is desirable for the training of University students intending to pursue the study of any one of the great branches of biology as a science. What they did not do was to furnish the professional medical student with that special acquaintance with the arrangements of tendons, nerves, and blood-vessels in each little tract of the human body which might be the seat of a surgical operation or a medical exploration.

Both the teaching and the acquirement of these details is tedious and uninteresting, although necessary for the surgeon. The subject-matter is called "human anatomy," or the "anatomy of man"—as distinguished from "anatomy" in its wider sense, and more especially as distinguished from comparative anatomy. Human anatomy is not a branch of science; it is topographical information. In order to render it less uninteresting than it would be (and under some teachers is) when strictly taught, it is customary for the teacher of human anatomy to introduce scraps of the various branches of science which bear upon the significance of animal structure into his text-books and lectures. He thus imports a little physiology and mechanics, a little comparative anatomy or animal morphology and embryology into his teaching. The real significance, however, of the facts learnt by the medical student in his course of "human

anatomy" is in their application to surgical and medical practice, and it is in referring to these applications that the teacher of human anatomy finds the legitimate and most successful leaven for his dead weight of detail.

Such being the somewhat repellent character of the pursuit of human anatomy considered apart from the science of morphology or comparative anatomy, it is not surprising that the Oxford teachers of "anatomy" in 1885 had all devoted themselves to the latter study, and left the technical topographical human anatomy uncared for.

But unattractive and uninteresting as it is, this human anatomy has to be "gone through" by the medical student. Oxford had been roused to a sense of her obligations to medical study by a movement, in which I took a somewhat prominent part, and accordingly when in 1885 it was represented to Convocation that although the University had three professorships of anatomy and splendid collections illustrating the structure of animals (including man), yet there was no provision for carrying on the instruction in anthropotomy necessary for technical students of medicine, that body generously and deliberately consented to provide a new professorship for the specific purpose of filling this gap in the machinery of the Oxford Medical School.

I should be very sorry to see any tendency to frustrate the excellent purpose of Convocation, and I feel confident that the renewal of the periodic grant made by that body to pay the salary of a lecturer in human anatomy must depend on the lectureship being strictly restrained within its original boundaries. We do not want at Oxford a fifth professorship of anatomy added to the four which have somehow slipped away from "anthropotomy" into pleasanter and more philosophic regions. The University ought not to be asked for more money with the object of effecting once more such a transformation. But this will certainly be the case if vague theories about "the academical teaching of human anatomy" are allowed to pass without protest.

Oxford, November 4.

E. RAY LANKESTER.

P.S. It is strange that Prof. Sanderson (himself an Edinburgh man) speaks in his letter of the University professor of *Human Anatomy* in Edinburgh. There is no such professorship in Edinburgh. Sir William Turner is professor of *Anatomy* in Edinburgh, as is the eminent comparative anatomist Gegenbaur in Heidelberg. The separation of human anatomy from comparative anatomy has not been carried out in these Universities as it has been deliberately in Oxford. Anthropotomy is taught in the former by demonstrators and assistants acting under the direction of the professor of anatomy. That was the intention of the late University Commissioners with regard to Oxford when they constituted the Linacre Professorship of Human and Comparative Anatomy. Some persons, however, thought it best (I am not now discussing the merits of the arrangement) that the example of Edinburgh, Heidelberg, and other European Universities, should be departed from in Oxford, and that the functions of the Edinburgh Professor of Anatomy and his staff should in Oxford be divided between the Linacre Professor of Comparative Anatomy and an independent lecturer in Human Anatomy.

The Monros, Goodsir, Allen Thomson, and other distinguished Scotch teachers were, like Gegenbaur, Kölliker, and others in German Universities, professors of "Anatomy," not exclusively of "Human Anatomy."

The Oxford plan of relieving the titular Professor of Human and Comparative Anatomy of an important but technical branch of his teaching, by the appointment of a lecturer *ad hoc*, has not a precise parallel in other Universities. Moreover, in Germany the subject of microscopic anatomy or histology is very usually undertaken by the Professor of Anatomy (e.g. Kölliker, Waldeyer, His), although in Oxford the Professor of Physiology is by statute called upon to give instruction in histology. It would probably not meet with unanimous approval were the present Oxford lectureship in Human Anatomy—in imitation of "academical teaching" elsewhere—to be diverted wholly or partly to the subject of histology.—E. R. L.

"Geology in Nubibus." An Appeal to Dr. Wallace and others.

IN his timely and important letter to you, Dr. Wallace congratulated us all on having got rid of a *real* glacial nightmare by sweeping away the tropical glaciation which has been favoured

by some high authorities, including himself, Mr. Darwin, and Mr. James Geikie. While we may all share in this congratulation, it must be remembered what it involves.

It has been the fashion with an extreme and aggressive school of glacialists to postulate an excavating tendency in ice to which the formation of lake basins and valleys-without-outlets in mountain districts has been attributed. They will not allow that rock basins are due to any other cause than "omnipotent ice." They scoff at explorers of the mechanics of ice in Alpine countries, like Prof. Bonney and Mr. E. Hill. They jeer at those who have devoted much patience to unravelling the mysteries of Plutonic action, like Prof. Judd and others, who attribute a large number of lakes to dislocations and to foldings of the subjacent rocks. It is no use, in arguing with them, to refer to mechanical difficulties like those involved in conveying thrust of more than a certain amount through a substance like ice, which is known to crush under a moderate pressure, nor to produce any number of mechanical arguments against the capacity of ice to erode lake basins such as those in question; nor is it any use appealing to the stupendous geological difficulties against their conclusions which have been accumulated by quite a number of skilled geologists at home and abroad. All these efforts are futile, for we are told that the ice to which appeals must be made is quite a different thing to any ice we can experiment upon or examine, and that it must not therefore be measured by the ordinary laws that govern ice such as we know it, and this appeal to transcendental ice is considered to be orthodox science in the nineteenth century, an age when induction is supposed to have become a supreme law to us all, and when *a priori* postulates are generally discarded from the realm of physical research. Let this pass, however, and let us test the question in another way. Let us test it, in fact, by this very case of Brazil.

There has never been a glacial period in, nor are there traces of glacial action in the highlands of, Brazil, we are told by Dr. Wallace. Granted. How then can Dr. Wallace, and those who agree with him in this matter, explain the existence on the plateau of Bahia of perhaps the largest and most remarkable collection of rock basins in the world, rock basins existing, too, in close juxtaposition with most perfect examples of giants' cauldrons on the largest scale. This is assuredly a dilemma for the transcendental school of geologists.

Let me quote from Mr. Allen's graphic descriptions of these rock basins. Speaking of the plateau of Bahia, he says: "Over this whole region there is an almost entire absence of loose materials on the surface. . . . slight knolls and shallow basins alternate which rarely differ more than 20 or 30 feet in elevation. In the rainy season many of these basins become filled with water, forming shallow lagoas varying in area from less than one to more than 50 acres, from most of which the water evaporates in the dry season. . . . So numerous were these lagoas for more than 50 miles that it seemed natural to speak of this region in my notes as the "Lake Plain." Almost everywhere the elevations are evenly rounded, indicating that the rocky crust has been exposed to rain and probably long continued abrasion. But the absence of abraded materials seemed most remarkable; very rarely were even loose boulders observed, though a few such were repeatedly noticed. At frequent intervals there were irregular holes in the rocks, usually nearly filled with water, to which the inhabitants give the name of 'caldeiraos.' These caldeiraos are of frequent occurrence. . . . Nearly all of the considerable number examined proved to be genuine pot-holes, and some of them were of great size. The largest one I measured was elliptical in outline, 18 feet long, 9 or 10 in width, and 27 deep, with smoothly worn sides. . . . These pot-holes often occur on the plain, far away from any high land, and they are sometimes found excavated on the summits of slight bulgings in the plain, or even on the top of a hill."

I would ask, in all seriousness, whether, if phenomena like these had been described from the Alps or from Nova Scotia, they would not assuredly have been pointed to by extreme glacialists as the unerring footprints of great ice-sheets, and yet Dr. Wallace, who is a champion of the school, repudiates the former glaciation of Brazil altogether.

What is to be said in regard to this dilemma then? It is quite clear that either the facts must be disputed (and who is to dispute them?), or else the champions of ice at all-hazards must concede that rock basins and giants' cauldrons can be made by other agencies than ice. If so, they can be made as well in one

place as in another. If they could be made by other causes on the plateau of Bahia, why not in the highlands of Tasmania?

I am bound to say I was taken aback by Dr. Wallace's comments on a letter from one of your correspondents, which appeared in NATURE a short time ago. That gentleman professed to make an exploration of certain parts of Tasmania with another experienced geologist. They were both champions of the glacial theory. They both went prepared to find traces of glacial action there, and certainly in our latitudes no evidence seems more easily discriminated, and they came back convinced that in the districts where the rock basins of Tasmania abound, there are no traces of glacial action to be seen. They could find none. Mr. Johnstone, who has written an elaborate and detailed geological memoir on the island, and who has explored it in many directions, could find none either, save on the western flanks and in the valleys of the Tasmanian Alps in the western part of the island, where it has been long known that traces of former local glaciers exist. There is absolute unanimity among the native geologists that nothing in the shape of ice-sheets existed there, and there is no ice-spoor in the central districts where the great Tasmanian lakes occur. Dr. Wallace's answer to all this was certainly unexpected. He has not himself visited the island, and yet he disputed not only the inferences but the facts and the observations. Why should the voice of Esau be listened to and approved in Brazil, and that of Jacob be repudiated in Tasmania? Mr. Johnstone and the other observers in Tasmania are assuredly to be trusted in such an issue quite as much as Prof. Branner. I cannot see on what ground the discrimination is made, except the desperate inconvenience of postulating a glacial nightmare in the tropics.

Assuredly the whole difficulty lies in championing a theory of the origin of lakes, unknown in geology until introduced by Ramsay, whose extravagance at times may be measured by some of his phrases addressed to the British Association when he presided over the geological section. From all sides there comes a revolt against this theory, which is based on no empirical evidence, and is at issue with the mechanical properties of ice so far as we know them, and with the observations of practised observers of the first rank. I am bound to say that those geologists who habitually make appeals to forces in Nature, and to properties of matter which are purely hypothetical and unwarranted by experience, are leading us back to times when Aristotle and deductive reasoning dominated European thought, and when Bacon had not yet taught us better things.

My attention has been called to an oversight in my previous letter. Among those who many years ago did good work in dissipating the particular glacial monster that was generated in the valley of the Amazons, was my old friend Dr. Woodward, whose papers on the subject in the volume of the *Ann. and Mag. of Nat. Hist.* for 1871, pp. 59 and 101, I had overlooked.

HENRY H. UGORTH.

30 Collingham Place, Cromwell Road, October 27.

#### Correlation of Solar and Magnetic Phenomena.

I WAS glad to see (NATURE, vol. xlix. p. 2) in the notice of Miss Clerke's "Popular History of Astronomy," that attention was drawn (1) to the correspondence in time between a certain luminous outburst seen on the sun on September 1, 1859, by Carrington and Hodgson, and a disturbance of the magnets at the Kew Observatory; and (2) to the statement of the late Mr. Whipple that the magnetic movement was really a small one, and that in his opinion the observed correspondence was a mere accidental coincidence. Those who have read Carrington's original account (Monthly Notices of the Royal Astronomical Society, vol. xx. p. 13) will remember that at the time he himself did not lean towards hastily connecting the phenomena, remarking that "one swallow does not make a summer." But authors of text-books on astronomy, who may be only to a partial extent observers, are too apt to state the matter in such a way as to give an impression that we have here an undoubted instance of direct connection, instead of a case of apparent connection, to be taken merely for what it is worth, seeing that the occurrence has remained to the present time without corroboration. I should like to take the opportunity to support, in the fullest manner, the opinion of Mr. Whipple, which acquaintance with the Greenwich magnetic registers tells me to be a true one. The magnetic movement in question, as recorded at Greenwich, was similarly small.

But the erroneous impression lives long. May I therefore be

further allowed to give some reasons for the opinion expressed. That there exists a relation between sun-spots and magnetism is undoubted. And although those who are able to study the variations of sun-spots side by side with the variations of magnetism can very well see to what extent the relation definitely holds, it is difficult adequately to convey to others a due impression of all the circumstances of the case. Periods of maximum sun-spots are periods of great magnetic activity and energy, whilst periods of minimum sun-spots are periods of magnetic quiet. But it has not yet been found possible to trace direct correspondence in details. Thus, when a large spot is present there may occur one or more considerable magnetic disturbances or storms, some enduring it may be for a few hours only, others it may be for several days, but, assuming direct solar influence, what it is that precisely determines when such disturbances shall arise is unknown. Further, at times of sun-spots being numerous, there is also considerable general magnetic irregularity. Now, in these magnetic disturbances and irregularities there will be innumerable individual motions far exceeding in magnitude that accompanying the Carrington sun outburst, and yet during all the many years that have elapsed since 1859, through which period the solar surface has been continuously scrutinised by hundreds of observers in different lands, no second occurrence similar to that of 1859 has come to light. But if there be so close a connection between solar and magnetic phenomena as the occurrence in question would seem to indicate, the fact that we have no corroboration of the solitary observation of 1859 is surely remarkable, considering that, of late years, it is very much to correspondence in details that attention has been to a great extent directed. If irregular magnetic movements were comparatively few, the observation of 1859 might possess some significance, but they are, on the contrary, multitudinous, many at times occurring during the course of a single day, and often of considerable magnitude, but yet without any recorded accompanying solar manifestation.

To sum up, the points of the matter may be thus stated:—

- (1) The solar outburst in 1859 was seen independently by two observers: the fact of its occurrence seems therefore undoubted.
- (2) The corresponding magnetic movement was small.
- (3) Many greater magnetic movements have since occurred.
- (4) No corresponding solar manifestation has been again seen, although the sun has since been so closely watched.

The solar outburst of 1859 would thus appear to have been a rare phenomenon, and its observed occurrence at the time of a recorded magnetic movement quite an accidental coincidence.

This conclusion in no way invalidates the question of general relation between sun-spots and magnetism, whatever may be the true explanation of that relation.

Greenwich, November 6.

WILLIAM ELLIS.

#### The Recent Earthquake.

AFTER the Pembroke earthquakes of August 1892, you were good enough to insert a letter from me (vol. xlv. p. 401) asking for observations from different places. In reply to this letter, I received so many and such valuable records, that I should be greatly obliged if you would allow me to make a similar request for accounts of the recent earthquake of November 2, in Wales and the West of England. I should be very grateful for descriptions from any place whatever. The questions printed below indicate the points on which information is chiefly desired, but if any observers are able and willing to give further details, I shall be pleased to send them my fuller list of questions, which I may remark are somewhat different from those given in the letter referred to above.

- (1) Name of the place where the earthquake was observed.
- (2) Time at which it was felt, if possible to the nearest minute.
- (3) Nature of the shock. (a) Were two or more distinct shocks felt, separated by an interval of a few seconds? (b) If so, which was the stronger? (c) What was the duration (in seconds) of each, and of the interval between them? (d) During this interval was any tremulous motion felt or rumbling sound heard?
- (4) Duration in seconds of the whole shock, not including the accompanying sound.
- (5) Was the shock strong enough (a) to make doors, windows, fire-irons, &c., rattle; (b) to cause the chair, &c., on which the observer was resting to be perceptibly raised or moved; (c) to make chandeliers, pictures, &c. swing, or to stop clocks?
- (6) (a) Was the shock accompanied by any unusual rumbling sound, and, if so, what did it resemble? (b) Did the beginning of the sound precede, coincide with, or follow the beginning of

the shock, and by how many seconds? (c) Did the end of the sound precede, coincide with, or follow the end of the shock, and by how many seconds? (d) Were the strongest vibrations felt before, at, or after the instant when the sound was loudest, and by how many seconds?

CHARLES DAVISON.

373 Gillott Road, Birmingham, November 6.

#### "An Ornithological Retrospect."

I HAVE been interested in reading "An Ornithological Retrospect," by your correspondent, Dr. Sharpe. His reference to myself by name in the concluding paragraph is partly my excuse for troubling you with a few remarks upon this article. Dr. Sharpe, in one long breath, depletes (pleonastically) the fact that "very little anatomical work has scarcely been done" recently in ornithology, and exults over a reviewer in a "leading London paper," who apparently took the same view—tomahawking him with the remark that "in every branch of the subject considerable progress has been made." I think that the opinion of the minority in this case is correct, and that our knowledge of bird anatomy is progressing. But those of us who are occupied with this study have frequently to regret the ignoring of anatomical facts by systematists: this is particularly discouraging, since by far the larger proportion of papers upon bird anatomy are purely of systematic interest, dealing with the resemblances between bird and bird. Dr. Sharpe evidently feels that the British Museum Catalogues of Birds are not beyond criticism from this point of view. In one or two volumes there is a conspicuous absence of any arrangement in accordance with anatomical fact. Dr. Sharpe, therefore, is rather imprudently candid in saying that to understand these catalogues a man must be an ornithologist.

Zoological Society's Gardens.

FRANK E. BEDDARD.

#### The Foam Theory of Protoplasm.

IN your issue of October 19 there appeared, under the title "Bütschli's Artificial Amœbe," a review, by Dr. John Berry Hayercraft, of Prof. Bütschli's work upon protoplasm. I venture to think that in many places Dr. Hayercraft has misrepresented entirely Prof. Bütschli's researches, while other objections or criticisms which he brings forward are answered in the book itself. Since I have been engaged for some time upon a translation of Prof. Bütschli's work, which is now in the press, I must ask your readers to suspend their judgment until they have a better opportunity of forming an opinion for themselves.

2 Blackhall Road, Oxford.

E. A. MURCHISON.

#### SCIENCE IN THE MAGAZINES.

AMONG the magazines received by us, the *Fortnightly* is well to the front as regards articles having a scientific interest. Dr. Alfred R. Wallace writes on "The Ice Age and its Work," with the object of explaining "the nature and amount of the converging evidence demonstrating the existence of enormous ice-sheets in the northern hemisphere, to serve as a basis for the discussion of the glacial origin of lake-basins, which will form the subject of another article." After briefly describing the foundation of the science dealing with glaciers and their action, and the early school of glacialists, Dr. Wallace states the phenomena which points to the former existence of glaciers in regions where the mountain-tops are at present below the snow-line. These are classified as follows:—(1) Moraines and drifts; (2) Rounded, smoothed or planed rocks; (3) Striæ, grooves, and furrows on rock-surfaces; (4) Erratic and perched blocks. As a good example of a moraine, that in Cwm Glas, on the north side of Snowdon, is mentioned, together with those in Glen Isla (Forfarshire), and the Troutbeck alley near Windermere. In Cwm Glas, also, smoothed and rounded rocks are to be seen above the moraine. Striated, grooved, and fluted rocks are exemplified by those near the lakes of Llanberis, and by the remarkable effects exhibited at Kelly's Island, at the western end of Lake Erie. The enormous block near St. Petersburg, and the mass of Swedish red granite found at Fürstenwalde, south-east of Berlin, are given as in-

stances of erratic blocks. The erratic blocks from the higher Alps, which are found on the flanks of the Jura Mountains, are also shown to point conclusively to the former existence of glaciers stretching down the Rhone Valley as far as the Jura. The distribution of erratics in North America are next considered, and the crowning example of boulder transportation is said to be afforded by "the blocks of light grey gneiss discovered by Prof. Hitchcock on the summit of Mount Washington, over 6000 feet above sea-level, and identified with Bethlehem gneiss, whose nearest outcrop is at Jefferson, several miles to the north-west, and 3000 or 4000 feet lower than Mount Washington." After giving instances in Great Britain and Scandinavia of boulders carried above their source, Dr. Wallace says:—

We thus find clear and absolute demonstration of glacier ice moving up-hill and dragging with it rocks from lower levels to elevations varying from 200 to 2700 feet above their origin. In Switzerland we have proof of the same general fact in the terminal moraine of the northern branch of the Rhone glacier being about 200 feet higher than the Lake of Geneva, with very much higher intervening ground. As it is universally admitted that the glacier of the Rhone did extend to beyond Soleure, all the *à priori* objections to the various cases of rocks carried much higher than their origin, in America, the British Isles, and Scandinavia, fall to the ground. We must either deny the existence of the ice-sheet in the great Swiss valley, and find some other means of accounting for the travelled blocks on the Jura between Geneva and Soleure, or admit that the lower strata of a great glacier *can* travel up-hill and over hill and valley, and that the ice-sheets of the British Isles, of Scandinavia, and of North America merely exhibit the very same characteristics as those of Switzerland, but sometimes on a larger scale. We may not be yet able to explain fully how it thus moves, or what slope of the upper surface is required in order that the bottom of the ice may move up a given ascent, but the fact of such motion cannot any longer be denied.

Prof. T. E. Thorpe contributes a chatty paper on "Carl Wilhelm Scheele," whose life's work is summed up as follows:—

We owe to Scheele our first knowledge of chlorine and of the individuality of manganese and baryta. He was an independent discoverer of oxygen, ammonia, and hydrochloric acid gas. He discovered also hydrofluoric, nitrosulphonic, molybdic, tungstic, and arsenic acids among the inorganic acids; and lactic, gallic, pyrogallic, oxalic, citric, tartaric, malic, mucic, and uric among the organic acids. He isolated glycerin and milk-sugar; determined the nature of microcosmic salt, borax, and Prussian blue, and prepared hydrocyanic acid. He demonstrated that plumbago is nothing but carbon associated with more or less iron, and that the black powder left on solution of cast iron in mineral acids is essentially the same substance. He ascertained the chemical nature of sulphuretted hydrogen, discovered arsenetted hydrogen and the green arsenical pigment which is associated with his name. He invented new processes for preparing ether, powder of algaroth, phosphorus, calomel, and *magnesia alba*. His services to quantitative chemistry included the discovery of ferrous ammonium sulphate, and of the methods still in use for the analytical separation of iron and manganese and for the decomposition of mineral silicates by fusion with alkaline carbonates.

To this long list of successful labours must be added the memoir on "Air and Fire," which appeared in 1777, and the experimental material for which was partly collected in Malmö and Stockholm before 1770, and partly during Scheele's stay at Upsala, that is, prior to 1776. These dates, Prof. Thorpe reminds us, are important in view of Scheele's relations as a discoverer to Priestley and Lavoisier.

"The Geographical Evolution of the North Sea" forms the subject of an article by Mr. A. J. Jukes-Browne in the *Contemporary*. In the course of the paper the following conclusion is arrived at:—

The North Sea—that is to say, a sea lying east of Britain and opening northward—had no existence until after the formation of our Coralline Crag. The great change which submerged

the northern land-barrier and permanently lowered the temperature of eastern England by letting in the waters of the Arctic Ocean took place during the formation of the newer "Crag" which overlies the Coralline Crag in Suffolk, and extend northward through Norfolk.

In proof of this statement, two salient facts may be mentioned: (1) the incoming and gradual increase in the number of northern species among the mollusca of the newer Crag; (2) the occurrence of Crag shells in the glacial sands of Aberdeen, showing that marine Pliocene deposits once existed at no great distance from the Scottish coast and were destroyed by the ice of the Glacial Period.

According to Mr. Jukes-Browne, towards the close of the Pliocene period the whole area between East Anglia and the Netherlands appears to have become dry land. The estuary of the Rhine then lay off the coast of Norfolk, and the Thames was one of its tributaries. During the glacial epoch, the whole bed of the North Sea was dry land. The subsidence that afterwards submerged the North Sea floor and filled the valley of the English Channel with water, led to the silting up of the English river-valleys, and to the formation of the modern delta of the Rhine. Mr. Jukes-Browne believes that by it England was separated from the Continent; for there is no proof that a continuous sea separated England and France at any earlier Pleistocene epoch.

The *Forum* (October) contains a contribution by Prof. E. S. Holden, the object of which is "to detail the history of the remarkable 'new star' of 1892, in the constellation Aurigæ." On this side of the Atlantic, a detailed account is understood to mean a more or less minute narration of particulars; but Prof. Holden's paper shows us that in writing the history of a new star in detail, reference to some of the most important communications on the matter may be omitted. "The *Nova* was, no doubt, a star like our sun . . ." says Prof. Holden. ". . . Let us imagine what fate ours would be, if our sun should suddenly increase in light and heat some hundreds of times, and then fall off some thousands," and so on. The learned Director of the Lick Observatory will find that there is very little, if any, evidence that *Nova Aurigæ* "resembles our sun" in physical constitution, which is the inference naturally put upon his remarks. We read that, "Nothing can be clearer than the identity of the 1893 spectrum of the *Nova* and that of the nebula"—a pill which some spectroscopists have had great difficulty in swallowing. Prof. Holden describes Prof. Seeliger's hypothesis of the genesis of the *Nova*, but inclines to Prof. Vogel's modification of it; for he remarks, "We can at least say that up to the present time the new star has behaved as if it had entered a system of distant planets, rather than a swarm of cosmical meteorites." This, however, is simply an expression of opinion, and the statements that might justify it are not discussed, for the reason that "they relate to the minutia of observation."

The *Quarterly Review* (October) contains an excellent account of Vedic mythology, which should be of interest to astronomers, since it deals chiefly with the relation of the sun and moon to mythological thought and language.

An article on "Waves," in *Good Words*, and one on "Electricity and Health," in the *Humanitarian*, deserve mention, though neither contain much of scientific importance.

The *Medical Magazine* contains Part I. of an article on "Heredity and Disease."

#### ON A METEORITE WHICH FELL NEAR JAFFERABAD IN INDIA ON APRIL 28, 1893.<sup>1</sup>

PARTICULARS have recently reached this country concerning the fall of a meteorite near Jafferabad in the south-east of Kathiawar, a native State adjoining the

<sup>1</sup> Note read at the meeting of the Mineralogical Society, October 14, 1893.

Bombay presidency. Dr. J. W. Evans, the geologist to the State of Kathiawar, has kindly forwarded to me a translation of the report sent in by the local official. It is curious that a fall of Nagali Jaowar (a kind of seed used as food by the poorer people of the country) is said to have occurred at the same time as the fall of the stone. As suggested by Dr. Evans, the seed may have been carried a short distance by the wind, which is very strong on the coast of Kathiawar at the time of year when the fall occurred. The spot where the fall took place is a flat region of recent limestone. Dr. Evans adds that the official report is interesting, as it is the account of a man who never heard of a meteorite, and to whom the fall of grain is as probable as that of stones. The report is as follows:—

“There was thunder which lasted for a quarter of an hour on the southern side at between a quarter to eight and eight o'clock in the morning of April 28, 1893. At that time the sky was clear enough. It has been known that the thunder was heard in nearly all the villages of Babariawad. The reason for my giving you this trouble is that Nagali Jaowar has rained with thunder on a small piece of ground near the outskirts of a village called ‘Wad,’ situate on the eastern bank of a river named ‘Dhatarwadi,’ and about two kosh (miles) distant from this place, but there was not a drop of rain-water. A specimen of Jaowar that has come down is sent herewith. A coolie, named Hamo Shiyal, while working in his field on the same day and at the same time, saw a stone about five or seven tolas (a tola = 180 grains) in weight falling on to the ground, about two fields distant, on the southern side of a village called Covaya, situated south-west of, and three kosh distant from this place, with the noise of thunder. He picked it up, and came to the village with it. While showing it to the people of the village, they broke it to pieces. As a specimen, one piece of the stone, out of the two pieces found by inquiry, is also sent herewith. There was not a drop of rain, and the sky was clear enough. Notwithstanding the clearness of the sky, it has been said that there was a thunderbolt. Such were the details of the occurrence on the morning of Friday, at between a quarter to eight and eight. If any further details come to notice, they will be reported to you.”

The original stone was shown by Dr. Evans' investigations to have been 37 centimetres long, 29 centimetres broad, and 23 centimetres thick. It was broken up by the villagers, and only the two largest portions have been recovered by the officials. These weigh respectively 17.4 and 16.3 grammes. The stone is said to have been cold when picked up, and no hole in the ground made by its fall was noticed. The larger fragment of this meteorite has been entrusted to me by my friend Dr. Evans, and Mr. L. Fletcher, F.R.S., of the British Museum, has kindly made a preliminary examination of it, the results of which I give in his own words:—

“The fragment of stone weighing 17.42 grams (3 5ths of an ounce), sent by Dr. Evans, is undoubtedly part of a true meteorite, as is seen at once on examination of the crust and the fractured surface. The crust formed during the passage of the stone through the earth's atmosphere is dull black in colour, and in parts so rough as to be scoria-like in texture. On direct comparison with the stones from other falls preserved in the British Museum it is seen that in these respects the Jafferabad stone is very similar to parts of Pavlograd, Bachmut, Middlesborough, Tourinnes-la-Grosse, Pohlitz, and Gross-Lieenthal. The crust, however, is very remarkable for its thickness, which a little exceeds a millimetre, and at one part even reaches two millimetres: in most meteoric stones the thickness of the crust does not exceed half a millimetre, and in very few cases reaches a millimetre: the thickness in this instance surpasses that of the crust of any specimen preserved in this collection: of the above-mentioned meteorites, Pavlograd approaches most

nearly in this respect. The broken surface of the stone is very white in colour, and shows the usual metallic spangles of nickel-iron and troilite, white and tomback brown respectively: the thin black veins, beginning at the crust and traversing the stone in various directions of former fracture, are unusually conspicuous, even more than in the case of the stone which fell at Gross-Lieenthal in Russia on November 19, 1881, and which is very similar in its general characters. The aspect of the fracture is very uniform, and no round enclosures (chondrules) are to be distinguished. This, however, is often the case, even when chondrules are actually present, and in all probability a microscopic section of the Jafferabad stone, when allowed by the owner to be made, will reveal their presence. The specific gravity of the stone with crust is 3.55, and has an average value; that of Pavlograd, for instance, is 3.58.”

It will be seen from the foregoing account that the Jafferabad meteorite presents some features of considerable interest; and it is to be hoped that, in the interest of science, his Highness the Nawab of Junagadh may permit the specimen now in this country to be subjected to a full microscopical and chemical examination.

JOHN W. JUDD.

#### NOTES.

THE following is a list of names recommended by the President and Council of the Royal Society for election into the Council for the year 1894, at the anniversary meeting on November 30 (the names of new officers are printed in italics):—President: Lord Kelvin. Treasurer: Sir John Evans, K.C.B. Secretaries: Prof. Michael Foster and Lord Rayleigh. Foreign Secretary: *Sir Joseph Lister, Bart.* Other Members of the Council: Prof. Isaac Bayley Balfour, *Dr. Andrew Ainslie Common, Dr. Andrew Russell Forsyth, Richard Tetley Glazebrook, Prof. Alexander Henry Green, Sir John Kirk, K.C.B., Prof. Oliver Joseph Lodge, Sir John Lubbock, Bart., William Davidson Niven, Dr. William Henry Perkin, The Marquis of Salisbury, K.G., Prof. J. S. Burdon Sanderson, Adam Sedgwick, Prof. Thomas Edward Thorpe, Prof. William Augustus Tilden, Prof. W. Carew H. Unwin.*

It is with deep regret that we announce the death of Sir Andrew Clark, Bart., on November 6, at the age of sixty-seven.

By the death of Prof. E. Lecouteux, France has lost one of its foremost agriculturists. Lecouteux was born at Créteil (Seine) in 1819. He was one of the founders, and afterwards a vice-president, of the Société des Agriculteurs de France. He was also at one time president of the Société Nationale d'Agriculture. Many important additions to agricultural literature were made by Lecouteux, and the effects of his beneficial influence will be apparent in France for many years to come.

THE Municipal Council of Paris has had an elegant album designed for M. Pasteur, containing the address presented to him in the name of the city of Paris at the celebration of his seventieth birthday in December of last year.

BRUSSELS UNIVERSITY will shortly have a laboratory of Psychological Physics, endowed by private munificence. The Rector, Prof. M. H. Denis, has nominated Drs. G. Dwelshauvers and P. Stroobant to take charge of the researches and practical work.

DR. JOHN ANDERSON, F.R.S., who for the past two years has been collecting materials in Egypt for a work on the mammals and reptiles of that country, is, we understand, again returning to Egypt to continue his researches, proceeding in the first instance to Suakin.

PROF. GUIDO CORA, of Turin, in 1886 a gold medallist of the R.G.S., has received this year a special gold medal from the Imperial Russian Geographical Society of St. Petersburg.

MR. CHARLES STEWART has been elected Fullerian Professor of Physiology to the Royal Institution of Great Britain, the appointment to date from January 13, 1894.

DR. VON JHERING has been appointed Director of the Natural History Museum, Sao Paulo, Brazil.

DR. WOLDRICH, Vienna, has been nominated Professor of Geology in the Bohemian University of Prague.

DR. T. PLESKE has been elected to the Directorship of the Zoological Museum of the St. Petersburg Academy of Sciences, in the place of the late Prof. A. Strauch.

DR. CARL BERG has been reappointed Professor of Zoology at the University of Buenos Ayres, a chair he occupied between 1875 and 1890, and which remained vacant after he went to Monte Video.

PROF. G. E. HALE is expected to be present at the meeting of the Royal Astronomical Society to-morrow, and to give an address on the subject of his solar researches.

IN NATURE of July 20 (vol. xlviii. p. 268) we published a communication from Prof. P. F. Frankland, calling attention to certain objections which had been raised by some members of the Society for Promoting Christian Knowledge against the publication of his little book, "Our Secret Friends and Foes," in the Romance of Science Series. The objections were stated formally by the Secretary of the Victoria-street Anti-Vivisection Society, and endorsed in most forcible terms by Lord Coleridge, as set forth in the correspondence published in our issue referred to. The protest calling upon the S.P.C.K. to withdraw the book from circulation, on the ground that it favoured "experiments upon living animals," was handed in last July with some fifty signatures attached, and in accordance with a rule of the Society was submitted to the Standing Committee, whose judgment in matters of this kind is considered final. This Committee has just passed the following resolution:—"The Standing Committee having taken into consideration the statement of objections, made under Rule xxxvi., against the book entitled "Our Secret Friends and Foes," by Prof. P. F. Frankland, and the remarks thereon submitted respectively by the author and the General Literature Committee, are unable to see sufficient reason for withdrawing the book from the Society's list." The decision arrived at will give general satisfaction to English men of science, and forms a fitting sequel to the correspondence forwarded to us by the author of the book.

At last there is a possibility that a scientific method of identification will become part of our prison system. The Home Secretary has appointed a committee to consider the means at present available in this country for the identification of habitual criminals, and to report to him whether they could be improved by the adoption either of the Bertillon method of identification in use in France, or of Mr. Galton's finger-print method, or in any other way. The report will be awaited with interest.

THE Exhibition of the Photographic Society of Great Britain will close on Wednesday, November 15.

An International Congress of Applied Chemistry will be held at Brussels on August 4, 1894.

THE Russian Chemical Society will celebrate its twenty-fifth year of existence by a special meeting at St. Petersburg on November 18.

THE Newcastle-on-Tyne and Northern Counties Photographic Association propose to hold an international photographic exhibition next April.

AN "Exposition Universelle" will be opened at Lyon on April 26, 1894, and will remain open until the following November. Sections will be devoted to electricity, hygiene, and agriculture.

At the meeting of the Museums' Association, held in July last, under the presidency of Sir W. H. Flower, K.C.B., F.R.S., the following officers were elected by the Council:—Dr. V. Ball, C.B., F.R.S., to be president, Prof. D. J. Cunningham, F.R.S., and Mr. Walter Armstrong vice-presidents. The Association will meet in Dublin next year, about the end of June or the beginning of July.

THE new session of the Royal Geographical Society will commence on November 13, when the president, Mr. Clements R. Markham, C.B., F.R.S., will discourse on "Geographical Desiderata, or Exploring Work to be done and Geographical Problems to be solved." On November 27, Dr. John Murray will read a paper on "The Antarctic Region and the Scientific and Commercial Results of its Exploration."

THE seventy-fifth session of the Institution of Civil Engineers will be commenced on November 14, and the meetings before Christmas are likely to be occupied, in addition to an address from Mr. Giles, president, with the design and construction of impounding reservoirs for water-works at Tansa (Bombay), Baroda, and Jeypore, with machinery for the manufacture of casks, and with the development of hydraulic power-supply in London.

THE first meeting of the 140th session of the Society of Arts will be held on Wednesday, November 15, when the opening address will be delivered by Sir Richard E. Webster, M.P. A course of Cantor lectures will be given by Prof. Frank Clowes in January and February next, his subject being "The Detection and Measurement of Inflammable Gas and Vapour in the Air." Captain Abney will deliver three Cantor lectures on "Photometry" in April. The following are among the papers down for reading after Christmas:—"London Coal Gas and its Enrichment," by Prof. Vivian Lewes; "Experiments in Aeronautics," by Mr. Hiram S. Maxim; "Pewter," by Mr. J. Starkie Gardner; "Electric Signalling without Wires," by Mr. W. H. Preece, F.R.S. Two juvenile lectures on "Plants: their Foes and Defences," will be delivered by Mr. W. Gardner, F.R.S., in January.

It is reported that Vesuvius is in a state of activity, and streams of lava are distinctly visible at night.

AN earthquake was distinctly felt in various parts of Wales and the West of England on Thursday, November 2, about 5.45 p.m. From reports of the occurrence we gather that at Milford Haven the tremor lasted about twelve seconds, and appeared to travel from north to south. In the St. Helens district of Swansea the shock lasted about five seconds. A distinct upheaval of the earth is reported from Carmarthen, where the shock is said to have lasted thirty seconds. Two successive shocks were felt at Cardigan, accompanied by a rumbling noise travelling from the sea in a south-easterly direction. In Pembroke there was a heavy rumbling sound, and the earth was felt to tremble for about seven seconds. The wave appeared to be travelling from south-east to north-west. Very faint shocks were felt at Cardiff and along the Rhondda Valley. In North Wales, however, the tremor was of a very pronounced character. Both shores of the Mersey seem to have been affected. From correspondents of the *Times* it appears that at Aigburth, just south of Liverpool, the vibration was felt at 5.44. At Woodside, on the Cheshire side of the Mersey, the time was

5h. 45m. 30s. : at Crosby, about five miles to the north of Liverpool, 5.47; at Shrewsbury 5.48, the duration in this case being estimated as three seconds. In Bristol it is reported that the tremor was distinctly felt along a course from north-west to south-east for forty seconds. Mr. H. Courtenay, writing to us from Waterford, says that the disturbance was experienced there at 5.25. Mr. Lloyd Bozward, of Worcester, describes the occurrence as follows:—"On Thursday last, at 5.45, a smart shock of earthquake was experienced. At this house the shock was vertical: no noise was heard, but in a second or two after the first shock a feeble one followed. Persons on the ground-floor observed nothing. The shock was felt at Boughton Park, southwards a mile hence, and there also the servants on the ground-floor felt nothing. These places are on the west side of the Severn. It is somewhat rare for the same shock to be felt on both sides of the Severn, but on this occasion it was somewhat severely felt at some large ironworks on the eastern side of the river. There the motion is described as a swaying one, and a rumbling like the passing of a heavy waggon was heard. At Boughton and the ironworks the time given is 5.48 p.m. I took the hour at the time of the shock from a clock, a good time-keeper, in the room with me. At Callow End, Dermstone, a farmstead ten miles north-east of Worcester, no shock was felt, but a loud noise was heard."

DR. N. M. GLATFELTER reprints from the fifth annual report of the Missouri Botanic Garden "A Study of the Venation of *Salix*." Photographic reproductions are given of the leaves of twenty-four American species of willow, and an attempt is made to classify them according to their venation.

THE Deby collection of diatoms now in possession of the British Museum, and open for reference by students in the Cryptogamic Herbarium, is the finest in existence, both as regards the number of species, the authority of the nomenclature, and the beauty of their preparation and preservation. Besides those collected by M. Deby himself, it includes a large number of type-slides prepared by other eminent diatomists. The collection of diatoms in the British Museum is now estimated to amount to about 50,000 slides.

DR. H. WILD, Director of the Central Physical Observatory at St. Petersburg, has published in German a summary of the decisions of the various international meteorological conferences, from that held at Leipzig in 1872 until that held in Munich in 1891. The arrangement is first under subjects, and secondly according to chronological order, and the work will be found very useful for reference by persons who may be seeking for information upon any particular subject, instead of having to consult some thirteen different volumes.

WE have received the report on the operations of the German Meteorological Office for the year 1892, which closes an important period in the history of that institution, owing to the completion of the organisation of the rainfall stations which began with the year 1885, and the establishment of a first-class meteorological and magnetical observatory at Potsdam. The rainfall stations now number nearly 1900, and the stations which send special reports of thunderstorms exceed 1400. The report contains not only a list of the official publications for the year, but also a list of the contributions of the officials to both German and foreign periodicals. We also note that, in order to keep up an interest in the work, the office issues no less than 200 copies of the popular meteorological journal *Das Wetter* to its observers.

THE report of the Director of the Royal Alfred Observatory, Mauritius, for the year 1891 has just reached this country. The maximum shade temperature during the year was 95°·4 on December 8, and the minimum 51°·0 on August 3. The highest temperature in the sun was 162°·7, and the lowest on

the grass 46°·0. The rainfall amounted to 44°·63 inches, being 3°·15 inches below the average, but at some other stations in the island the rainfall was much greater than at the Observatory. Dr. Meldrum collects observations from ships visiting the island, for the preparation of meteorological charts of the Indian Ocean; the number of days' observations tabulated during the year amounted to 9,600, taken between 23° N. and 46° S. latitude.

COLONEL A. T. FRASER has sent us an interesting note from Bellary with regard to two Hindoo dwarfs which he photographed in the Kurnool district of the Madras Presidency, not far south of the river Kistna. In speech and intelligence the dwarfs were indistinguishable from ordinary natives of India. From an interrogation of one of them, it appeared that he belonged to a family all the male members of which have been dwarfs for several generations. They marry ordinary native girls, and the female children grow up like those of other people. The males, however, though they develop at the normal rate until they reach the age of six, then cease to grow, and become dwarfs. These stunted specimens of humanity are almost helpless, and are quite unable to walk more than a few yards.

MR. MILLER CHRISTY outlines a scheme for mapping the geographical distribution of vertebrate animals in the *Zoologist* for November. He proposes to construct a map showing, by means of different colours, the following points for each species:—(1) Its present (indigenous) area of permanent residence throughout the world; (2) its summer and winter ranges throughout the world (if migratory); (3) its relative abundance in different parts of its area; (4) its lines of migration (if any); (5) the additional area (if any) over which any species, now partly or wholly extinct, can be traced within historic times; (6) the additional area (if any) over which it has been naturalised by human agency; and (7) other points of interest, such as isolated occurrences, erratic movements, areas of hybridization, &c. Though it may be some years before a scheme of this kind is well under weigh, authors of monographs of genera or families would do well to systematise their works, so that they could easily be used in the compilation of a topographical catalogue or bibliography.

THE extensive and increasing demand for india-rubber renders it possible that the supply will eventually become exhausted, so attempts at artificial cultivation of rubber trees are being made in various rubber-producing countries. Mr. Hart remarks, in the June *Bulletin* of the Royal Botanic Gardens, Trinidad, that rubber has been procured in the Gardens from *Castilloa elastica*, and that trees of a mature size will produce it in paying quantities. It has also been proved that *Heveas* of several species will thrive well in Trinidad. In this connection a paper by Dr. Ernst, on the caoutchouc of the Orinoco, published in the first number of the *Revista Nacional de Agricultura*, and included in the *Bulletin*, is of interest. Dr. Ernst says that the rubber of the Orinoco is extracted from the juice of the *Hevea brasiliensis*, Müll, a tree belonging to the family *Euphorbiaceae*, and not to that of the *Hevea Guayanensis*. The milky juice obtained from the trees, through incisions made in the bark, has the consistency of cream, and the rubber existing in it in minute globules constitutes from thirty to thirty-three per cent. of the weight. The rubber collectors of the Amazons employ the slow, primitive, and contaminating process of evaporating the juice in the dense smoke of a wood fire, in order to separate the rubber from it. A far better method of obtaining coagulation is to add a six per cent. solution of alum to the juice, and then submit the coagulated rubber to pressure in order to extract the water it contains. Dr. Ernst thinks that every effort should be made to extend and conserve the forests, thickets, or groves of rubber trees, suggesting, among other things, that

when the collectors work a grove they should be made to plant a certain number of trees. Only by such means, and by adopting a chemical mode of coagulation, can the rubber production of the Amazon territory be increased in quantity and improved in quality.

MR. VERNON BAILEY has prepared a report, for the U.S. Department of Agriculture, on the haunts and habits of the spermophiles, known in America as gophers or ground squirrels, inhabiting the Mississippi Valley region. Five distinct species of the genus *Spermophilus* inhabit this region, and four are restricted to it. On account of the immense damage done to crops by these mammals, several States have endeavoured to exterminate them, and they have formed the subject of investigation at a number of agricultural colleges and experimental stations. The increase of the pest is probably due to the thoughtless destruction of its natural enemies. We learn that no less than sixteen of the seventy-three species and sub-species of hawks and owls found in the United States are known to prey on the various members of the genus *Spermophilus*. Among mammals, the spermophile's enemies include the badger, fox, coyot, wild cat, and weasel, all of which are hunted and killed for sport or because of poultry-yard depredations. In several States immense amounts of money have been paid as bounties for the destruction of the pest, but the results are far from satisfactory; and it is evident that a bounty is only a temporary expedient for the extermination of these or any other animals. Mr. Bailey says that in many ways spermophiles render valuable service to the farmer, so he does not recommend a complete destruction of them. The evil which they do to crops, however, is very considerable over more than two-thirds of the United States; hence there is a general demand for some economical means of destroying them. The animals can, of course, be shot, and in this way limited areas may be freed from their ravages. Fumigation and trapping have also been employed with more or less success; but the most effective and quickest results have been obtained by placing in the burrows a bunch of rags or waste saturated with carbon bisulphide, and closing up the hole. The information on this point given by Mr. Bailey should be of use to agriculturists; indeed, the whole of the bulletin is of high importance.

AT the request of the Royal Academy of Science in Vienna, Prof. V. Hirbel undertook a geological tour this season in Thessaly. One or two short reports from him are published in the journal of the *Mathematisches naturwissenschaftliche Classe* (No. 20, October 12). Respecting the geology of Northern Greece, he writes that calcareous formations of the Flysch have the most extensive outcrop on the three parallel chains of the Pindus range. Dykes of serpentine intrude through the Flysch, and occur as flows interbedded with the overlying Cretaceous limestones. The age of the much larger intrusive masses of serpentine in the sandstone zone of the upper Peneus has not yet been definitely ascertained.

IN the "Proceedings of the U.S. National Museum" (vol. xvi. pp. 471-478, pl. 56), Mr. William Healey Dall describes a "Sub-tropical Miocene Fauna in Arctic Siberia." This fauna consists of a few well-preserved specimens of molluscan genera, *Ostrea*, *Siphonaria*, *Cerithium*, &c., which were found in 1855 by a member of the "Ringgold and Rodgers Exploring Expedition in the North Pacific." The fossils occur in Miocene sandstones of the Sea of Okhotsk, which are exactly like those of the Alaskan coast, and they are of interest chiefly because they prove beyond doubt strong affinities of the Miocene mollusca of these northern seas with species now living in the warm seas of Japan and China. According to Mr. Dall, the annual mean temperature of the waters in the Okhotsk area has diminished by at least 30° to 40° F. since Miocene time.

THE U.S. National Museum has also published a report by Mr. James I. Peck, on the pteropods and heteropods collected by the U.S. Fish Commission steamer, *Albatross*, during the voyage from Norfolk, Va., to San Francisco in 1877-8. The pteropod collections of this voyage are, for the most part, from the Caribbean and Panamæic provinces, and the material belongs almost exclusively to the family Cavoliniidae. From none of the deeper dredgings in the Pacific were pteropod deposit shells reported, though at times the surface collections in the same regions showed an abundance of the live animals. Mr. Peck agrees with Agassiz that bottom distribution is largely determined by the course of the ocean currents, so that by means of pelagic fauna and their bottom distribution, light may be thrown upon the course of the currents. To this cause Agassiz ascribed the presence of Arctic pteropods along the New England coast, from the course of the Labrador currents, and Mr. Peck believes that the differences between the bottom and surface collections of the *Albatross* on the voyage in the Gulf of Panama and at the Galapagos Islands may be similarly explained.

SOME years ago, a discovery of fossil plants was made for the first time in the Trinity Division of the Comanche series of Texas. These have now been worked out in detail by Mr. Wm. Morris Fontaine, who has published his results, together with a series of illustrative plates, in the "Proceedings of the U.S. National Museum" (vol. xvi. pp. 261-282, pl. 36-43). There are twenty-three species described; by far the greater number are conifers belonging to the genera *Abietites*, *Laricopsis*, *Pinus*, *Frenelopsis*, *Sequoia*, &c., a few Cycad genera, and a new species of *Equisetum* are also present; ferns are of exceedingly rare occurrence, and angiosperms entirely wanting. Seven of the species have been identified with forms from the Lower Potomac deposits (Lower Cretaceous) of Virginia, and several others show striking points of similarity with the same flora; four species agree with Wealden types. The whole character of the "Trinity" flora, more especially the absence, so far as known, of angiosperms, seems in favour of Jurassic as well as Cretaceous affinities. It certainly does not bear the distinct Cretaceous impress of the flora in the Potomac or Wealden formations. Mr. Fontaine refers the "Trinity" flora, therefore, to the base of the Cretaceous deposits in Texas, occupying a slightly lower horizon than the very similar flora in the Potomac deposits of Virginia.

THE recent geological history of the Arctic lands is discussed by Sir Henry Howorth in the *Geological Magazine*. The general conclusions to which he arrives are as follows:—(1) During the Pleistocene period the Arctic lands, instead of being overwhelmed by a glacial climate, were under comparatively mild conditions, and were the home of a widely-spread and homogeneous fauna and flora, constituting, perhaps, the best defined life-province in the world. (2) Since Pleistocene times the climate of these Arctic lands has been growing more and more severe, resulting in the extinction of a portion of their vegetable and animal inhabitants. (3) While one portion of this Pan-Arctic fauna and flora still remains largely homogeneous, another portion has become differentiated by evolution in Northern America and Northern Europasia, into the Nearctic and Palearctic regions respectively. (4) The true and the only glacial climate which we know to have prevailed in the Arctic lands was not during the so-called glacial age of geologists, that is during the Pleistocene period, but in that which is now current, and which is the product largely, if not entirely, of changes of level in the earth's crust which have occurred since Pleistocene times.

THE "Geology of Dublin and its Neighbourhood" has found a clear interpretation at the hand of Prof. Sollas, of Dublin University (*vide* Proceedings of the Geologists' Association, August,



pp. 91-121). Prof. Sollas discusses the origin of the ancient quartzites, granwacks, and slates in that district, and gives drawings from microscopic sections to illustrate the evidence in favour of their originally sedimentary nature. Palæontological evidence is present in the form of numerous worm-tubes and the doubtful organic remains known as *Oldhamia radiata* and *antiqua*. The whole group is regarded as a deposit in the tranquil sea of a period, probably Cambrian or pre-Cambrian, which he rather happily characterises as the "Age of Worms." Just as in the Highlands of Scotland, this Irish area has been subjected to great earth-movements, not only once, but several times. First, in later Cambrian age, the sedimentary rocks were rolled up into a series of anticlinal and synclinal folds. Ordovician time saw the rocks once more below sea level, and a second elevatory movement set in with extreme slowness in Upper Ordovician time. The third period of movement is of post-Carboniferous date, and of simpler character than the two preceding, the flexures having in the main followed those of the Ordovician movements. In his concluding pages Prof. Sollas briefly refers to the absence of mesozoic and tertiary deposits, the general characters of the glacial period, and the distribution of the boulder-clay over the Dublin area. Sketch maps and diagrams illustrate the paper.

THE effect upon the optical properties of a plate of quartz of compressing it in a direction perpendicular to its axis has been investigated by M. F. Beaulard, who publishes his results in the *Journal de Physique*. A quartz plate was cut normally to the axis and compressed laterally, thus superimposing a double refraction, varying with the pressure, upon the rotatory power. Allowing a beam of plane-polarised light to fall normally on to the plate, he obtained inside the crystal two elliptic vibrations propagated with different velocities and exhibiting after emergence a certain difference of phase. These two vibrations interfered and gave an ellipse whose elements could be experimentally determined. The pressures were obtained by means of a Perreanx dynamometer, varying from 0 to 530 kgr. per square cm. The quartz was placed between two jaws which could be made to approach each other by turning a screw. One of the jaws was fixed firmly in a frame, the other moved on guides which communicated the pressure to an elliptical pair of springs, the amount being indicated on a dial through a rack and pinion arrangement. The dynamometer was mounted on two wooden platforms allowing of the orientation of the quartz plate normally to the incident ray. The rest of the apparatus consisted of a polariser, a quarter-wave mica plate, a pair of quartzes with two different rotations, an analyser, and a spectroscope with eye-piece slit. It was found that the rotatory power remains constant; that the difference of phase due to double refraction alone is proportional to the pressure, and that the angle between the major axis of the emergent ellipse and the original incident vibration increases at first with the pressure (for plates of given thickness), then oscillates, and at particular pressures the two directions are the same, so that at some points the major axis turns in a direction contrary to the natural rotation of the quartz plate.

AT a recent meeting of the Académie des Sciences (Paris), M. Poincaré communicated an account of the experiments on the velocity of propagation of an electric disturbance along a wire, which have been carried on by M. Blondlot at Nancy. The wires used were of "high conductivity" copper, 3 mm. in diameter, and were fixed to the telegraph posts between the Préfecture and the Maxeville Asylum, a distance of about one kilometre. The method employed was very like that used by Wheatstone in his attempt to measure the velocity of the passage of an electric discharge, only instead of a rotating mirror M. Blondlot uses a rotating photographic plate. Matters

are so arranged that two sparks pass between two knobs, one direct and the other after travelling round the 2 kilometre circuit. The mean of five experiments gives a velocity of 296 kilometres per second, the retardation being  $\frac{1}{100}$  of a second. On a line 2 kilometres long, that is, one where the electricity has to travel over 4 kilometres, the velocity obtained was slightly greater, namely 298 kilometres per second.

IN a paper read before the American Institute of Electrical Engineers, Messrs. Bedell, Miller, and Wagner give an account of a new form of contact-maker which they have employed in their experiments on transformers. The contact-maker was required to connect for an instant a voltmeter with the circuit of the transformer at any required part of the cycle. The instrument consists of discs carried by a spindle which was connected to the shaft of the dynamo. A needle projects from the face of this disc and forms one of the electrodes for making contact, the other being formed by a fine water-jet issuing from a nozzle which is insulated from the rest of the instrument. The water-jet is supplied by a jar of water, several feet above, the connection being through a rubber tube. The nozzle of the water-jet is carried by a disc which is capable of being rotated, and has its edge graduated in degrees. The needle cuts the water-jet near the nozzle before the continuous column has had time to break up into drops. It was found necessary to put a little salt in the water, as pure water does not work, while acidulated water corroded the nozzle. This form of contact-maker the authors find far superior to any of the usual mechanical devices, the contact being perfectly constant and reliable.

IN the *Zeitschrift für physikalische Chemie*, vol. xii. No. 4, Herr Humberg gives an account of a significant piece of work which was undertaken for the purpose of obtaining additional evidence as to whether the magnetic rotatory polarisation of solutions gave any support to the hypothesis of electrolytic dissociation. Measurements were made on solutions of the lower fatty acids in water, benzene, and toluene. The molecular rotation of the dissolved substance was calculated on the supposition that the value found for the solution was the sum of those given by the amounts of solvent and dissolved substance which it contained. The numbers thus obtained were found to be practically independent of the concentration and of the chemical nature of the solvent, and were identical with the values given by the free acids. Not only was this the case with acids such as acetic, propionic, and butyric, which are held to be but feebly dissociated in aqueous solution, but also of the chlor-acetic acids, which are supposed to be much more strongly dissociated. Similar results were obtained from observations on solutions of various inorganic salts, such as potassium iodide, sodium bromide, ammonium nitrate, and barium bromide in water, and in methyl alcohol. Although the molecular conductivity of the aqueous solution of any of the salts was invariably much greater than that of the alcoholic solution, nevertheless the molecular rotation of the salt was the same in both cases. In conjunction with the work of Schönrock on this subject (see Notes, vol. xlviii. p. 239), the above results indicate that the effect of electrolytic dissociation on the magnetic rotatory polarisation of solutions (if such an effect really exists) is too small to be detected by ordinary methods of measurement.

ALTHOUGH such a large number of investigations have been made on the bacterial contents of waters derived from such different sources as lakes, rivers, springs, and wells, only a few observations have been made on the microbial condition of sea-water. Giaxa's are the earliest recorded examinations, and exhibit the poverty in this respect of sea-water. Thus, in the Bay of Naples, at about a mile and a half from the shore, only ten organisms were found in 1 c.c. Russell, also working in this bay at distances of 2½ to 9 miles from the coast, obtained

from 64 to 6 n 1 c.c. respectively. Very different is, however, the bacterial condition of sea-mud, as many as 245,000 microbes being found in 1 c.c. of slime at a depth of 164 feet, and 12,500 at 1,640 feet, whilst sea-water examined at such depths contained 121 and 22 respectively. Russell has been recently extending his observations (*Botanical Gazette*, vol. xvii. 1892) to the sea-water and mud on the Massachusetts coast. The number of bacteria, both in the water and slime, was very much less in these more northern and cooler waters than in the Mediterranean at Naples. The microbes present in the mud from Buzzard's Bay average from 10,000 to 30,000 per c.c., being but a very small fraction of the number found in Mediterranean mud at equal depths. Samples of mud were also obtained about 100 miles from the shore at a depth of 100 fathoms, on the edge of the great continental platform skirted by the Gulf Stream. These samples are the farthest from land that have ever been bacteriologically examined, and bacteria were found in large numbers; moreover, the two prevailing varieties present were identical with those obtained near the Massachusetts coast. As in his earlier researches, Russell also here found but few varieties of bacteria in the mud, mostly two or three, and curiously one form, *Cladothrix intricata*, isolated from Mediterranean mud and frequently met with, was only rarely found in this Atlantic slime.

ETHYL and methyl derivatives of hydroxylamine, in which the alkyl radicles replace an atom of the hydrogen in the amido group, and are therefore directly linked to nitrogen, have been isolated by Dr. Kjellin, of Heidelberg, and their mode of preparation and properties are described in the current number of the *Berichte*. They have been obtained by the decomposition with hydrochloric acid of the esters of meta-nitro-benzaldoxim, which oxim was merely selected on account of its ready preparation in a state of purity. The process consisted in boiling the ester with seven times its volume of concentrated hydrochloric acid in a flask to which a reflux condenser was attached, subsequently cooling, saturating the liquid with hydrochloric acid gas, and again boiling for a few minutes. A large quantity of meta-nitro-benzaldehyde is deposited and removed by filtration, after which the hydrochloride of the substituted hydroxylamine is obtained by evaporation, first over a water bath, and finally over sulphuric acid. In order to isolate the free bases from the hydrochlorides, the same method was adopted as proved so efficacious in the isolation of hydroxylamine itself, namely, decomposition with sodium alcoholate, and subsequent fractional distillation of the resulting liquid *in vacuo*. The hydrochloride was dissolved in the minimum quantity of methyl alcohol, and a little less than the calculated quantity of sodium methylate added, the large evolution of heat being controlled by extraneous cooling. The deposited sodium chloride was removed by filtration through asbestos: filter paper cannot be employed on account of the strongly corrosive properties of these methyl and ethyl derivatives of hydroxylamine. Upon distillation *in vacuo* in the case of the methyl compound, after the greater portion of the methyl alcohol has passed over and at a temperature of 35-40°, an alcoholic solution of the base distils, then finally the free base admixed with a small proportion of alcohol. Upon submitting this last fraction to redistillation, at a temperature of 62° and a pressure of 15 m.m., the pure  $\beta$ -methyl hydroxylamine,  $\text{CH}_3\text{NH.OH}$ , distils as a colourless liquid, which solidifies to a solid composed of colourless and odourless prisms upon cooling with ice or agitation of the receiver. The crystals melt sharply at 42°, but do not resolidify until the much lower temperature of 20° is reached. Upon distillation *in vacuo* in the case of the ethyl compound, after the methyl alcohol has largely passed over an alcoholic solution of the base distils for a short time, then lastly the ethyl compound itself commences to sublime and condenses in the

receiver in the form of large leafy crystals, filling the whole receiver. After pressing the crystals on porous plates to remove any superficial oil, pure  $\beta$ -ethyl hydroxylamine  $\text{C}_2\text{H}_5\text{NH.OH}$  is obtained; the crystals are quite colourless and odourless, and exhibit a mother-of-pearl lustre. They melt sharply at 59-60° without decomposition.

THE  $\beta$ -methyl and  $\beta$ -ethyl derivatives of hydroxylamine are substances which are readily soluble in water and lower alcohols, but only very slightly in ether and benzene. The crystals of both deliquesce in moist air. In the case of the methyl compound the deliquesced substance rapidly volatilises; but in the case of the ethyl compound the deliquescence can only be observed in badly-stoppered bottles, for in the open air the spontaneous volatilisation is so rapid that the substance has not time to deliquesce before it entirely disappears. Both compounds react strongly basic, and reduce alkaline copper and silver solutions as energetically as hydroxylamine itself in the cold. They strongly attack organic substances, but do not etch glass, nor do they appear to be explosive substances like free hydroxylamine. Both compounds are rapidly destroyed by halogens with production of halogen acids; concentrated hydriodic acid converts them to amines. When heated for some time in a sealed tube with concentrated hydrochloric acid, the methyl compound suffers an interesting change, being converted into ammonia and formaldehyde— $\text{CH}_3\text{NH.OH} = \text{NH}_3 + \text{HCOH}$ .

NOTES from the Marine Biological Station, Plymouth.—Last week's captures include another living specimen of *Lima Loscombii*, the Holothurian *Thyone fusus*, and the rare Nemeritines *Carinella polymorpha* (second specimen), *Cerebratulus marginatus* (first record), and a large *Lineus bilineatus* (16 cm. long). The tow-netstings have been of a uniform character. The diatom *Coccinodiscus* has been present in remarkable profusion for several weeks past. Medusæ have been scarce. The most plentiful larvæ are those of Polychætes, of Cirrhipedes, the *Mysis* stages of several Decapods, and *Scyphonantes*. Veligers are present in small numbers; and isolated specimens of the larvæ of *Cephalothrix*, *Porcellana* and *Carcinus* (*Megalops*) have also been observed. Very few individuals of *Crangon vulgarius* are now to be found bearing ova.

THE additions to the Zoological Society's Gardens during the past week include a Black-handed Spider Monkey (*Ateles Geoffroyi*) from Nicaragua, presented by Mr. T. E. M. Rymer-Jones; a Rhesus Monkey (*Macacus rhesus*, ♀) from India, presented by Miss G. A. Gollock; two Macaque Monkeys (*Macacus cynomolgus*, ♂ ♂) from India, presented respectively by Mr. W. Wylde and the Hon. Mrs. E. Yorke; a Philippine Deer (*Cervus philippinus*, ♀) from Manila, presented by Capt. T. E. Saunders; seven Common Quails (*Coturnix communis*), two Common Terns (*Sterna hirundo*), two Common Toads (*Bufo vulgaris*) European, two Ball Frogs (*Rana catesbiana*) from North America, a Grey-headed Porphyrio (*Porphyrio poliocephala*) from India, presented by Mrs. Rickards; a Smooth Snake (*Coronella lewis*) British, presented by Mr. A. Green; a Bay Wood Owl (*Phodilus badius*) from Java, deposited; two Rose-Hill Parrakeets (*Platyercus eximius*) from Tasmania, a Purple Sandpiper (*Tringa striata*) British, purchased.

#### OUR ASTRONOMICAL COLUMN.

A NEW SOUTHERN STAR.—Prof. Krueger has received a telegram from Prof. E. C. Pickering to the effect that a new star was discovered by Mrs. Fleming on October 26. Its Right Ascension is given as 230° 34', and its North Polar Distance = 140° 14'. The magnitude on July 10 = 7.0. No further details have been received, but from the date for which the magnitude is given it is probable that the star was detected by

Mrs. Fleming upon a photographic plate taken in July. The telegram has been communicated to the observatories in the southern hemisphere.

"ASTRONOMICAL JOURNAL" PRIZE.—Owing to the fact that during the past six months only one comet has been discovered, and that its period of visibility was unusually short, and also to the probable prevalence of a bad time of observing weather during the winter, the period specified in the offer of this prize for observation of comets has been extended by six months. The closing time for this prize will now take place September 30, 1894.

COMET BROOKS (OCTOBER 16).—Last week we gave Bidschof's elements and ephemeris for this comet. This week, for the sake of comparison (*Astronomischen Nachrichten*, No. 3194), we give the elements of the comet as obtained from the observations made at Hamburg, October 17; Greenwich, October 18; Pola, October 19; Strassburg, October 23, and Vienna, October 24. They are as follows:—

Elements.

$T = 1893$  September 19<sup>209</sup> M.T. Berlin.

$$\begin{aligned} \omega &= 347^{\circ} 20' 50'' \\ \Omega &= 174^{\circ} 53' 20'' \\ i &= 129^{\circ} 45' 77'' \end{aligned} \left. \begin{array}{l} \\ \\ \\ \end{array} \right\} 1893.0$$

log  $q = 9.90992$

The current ephemeris is for 12h. Berlin mean time.

| 1893.  | a App. | h. | m. | s.  | δ App. | Br.               |
|--------|--------|----|----|-----|--------|-------------------|
| Nov. 9 | ...    | 12 | 58 | 50  | ...    | +30 27.2 ... 0 82 |
| 10     | ...    | 13 | 0  | 53  | ...    | 31 20.6 ...       |
| 11     | ...    | 2  | 59 | ... | ...    | 32 14.8 ...       |
| 12     | ...    | 5  | 9  | ... | ...    | 33 9.9 ...        |
| 13     | ...    | 7  | 22 | ... | ...    | 34 5.8 ...        |
| 14     | ...    | 9  | 39 | ... | ...    | 35 2.6 ... 0 80   |
| 15     | ...    | 12 | 0  | ... | ...    | 36 0.4 ...        |
| 16     | ...    | 13 | 14 | 25  | ...    | 36 59.1 ...       |

Unit of brightness occurred on October 17.

MOON PICTURES.—In an article on the "Origin of the Lunar Craters," which has appeared in the last two numbers of *Prometheus* (Nos. 212, 213), the writer has been able to secure some excellent illustrations. These pictures are copies from photographs taken at Paris by the Brothers Paul and Prosper Henry, and illustrate regions near the South Pole. The current number of *Knowledge* also contains two fine reproductions of lunar photographs obtained by MM. Henry, illustrating an article by Mr. A. C. Ranyard, on the tints of the lunar plains.

METEOR SHOWERS DURING NOVEMBER.—During this month, in addition to some minor showers, Mr. Denning's table informs us that there are two which are above the usual brilliancy. The positions of the radiant points are as follows, the two most brilliant being printed in heavier type:—

| Date.   | Radiant. | Meteors.          |
|---------|----------|-------------------|
|         | α δ      |                   |
| Nov. 13 | 150 + 22 | Swift; streaks    |
| 16      | 154 + 41 | Swift; streaks    |
| 17      | 53 + 71  | Slowish           |
| 20      | 62 + 23  | Slow; bright      |
| 27      | 25 + 44  | Very slow; trains |
| 30      | 190 + 58 | Swift; streaks    |

GEOGRAPHICAL NOTES.

SOME anxiety may have been caused amongst Dr. Nansen's friends by reports published in an evening paper from the slender testimony of some Samoyedes, that the Kara Sea was unusually hampered by ice this season. The *Nouvelles Géographiques*, it is satisfactory to see, reports on the authority of the captains of the Russian vessels carrying railway material to the Yenesei, and of Captain Wiggins, that the navigation of the Kara Sea was particularly easy this summer, the ice being thin and not compact. The Hammerfest whalers also reported that never within human memory has the sea been so free from ice. At the end of December one vessel saw not a single ice-

berg between Nova Zemlya and Franz Josef Land. In the Kara Sea the current, which is usually westerly at that season, was this year running north-north-west, at the rate of a mile an hour. The note indicates that Captain Wiggins entertained no doubt of Dr. Nansen having easily reached the New Siberian Islands, which were to be his real starting-point.

IN continuation of the soundings of the English lakes recorded in this column from time to time during the summer, Mr. E. Heawood, assisted by Mr. Shields, has last week made bathymetrical surveys of Ennerdale, Buttermere, and Crummock Waters.

THE annual report of the Tyneside Geographical Society shows that there is now a membership of 1011, and the society generally in a flourishing state. From its headquarters in Newcastle the Tyneside Society extends its operations over a considerable area, and has established a regular branch in the city of Durham.

DR. JOHN MURRAY, of the *Challenger*, has written an elaborate paper on the first voyage of Columbus in relation to the development of oceanography. It is published in the current number of the *Scottish Geographical Magazine*, illustrated by reproductions of a number of ancient maps. Dr. Murray deals incidentally with the origin of the name America, rejecting Horsford's fantastic guess that it came from the name of the Norse explorer Erik the Red, and inclining towards Marcou's theory of its native origin from the Amerrique tribe of Indians in South America. As to Amerigo Vespucci's connection with the name, the author views it as a playful nickname given to him on account of the similarity of his Christian name, which was superseded by *America*, just as he himself is frequently called "Challenger Murray" for the sake of distinction.

THE EROSION OF ROCK-BASINS.

IN a recent letter to *NATURE* (vol. xlviii. p. 247, July 13, 1893), Sir II. Howorth attacks the views of those extreme glacialists who hold that a glacier is able, by means of the fragments of rock frozen into its under surface, to excavate rock basins; and with justice, so far as the larger basins, such as those of the great Swiss and Italian lakes are concerned, for it has been frequently shown, especially by Prof. Bonney, that such a cause is quite inadequate to account for the excavation of those basins. It seems inconceivable that a glacier which is barely able to move the loose *débris* lying in its path, should be able to plough out hard rocks to any depth whatever below the general valley level. On the other hand, the frequent occurrence of rock basins in regions which are now, or were in former times, subjected to glaciation, is so remarkable, that it appears as though there must be some connection between the two sets of phenomena.

Sir II. Howorth says that, "so far as we know, the mechanical work done by ice is limited to one process. The ice of which glaciers are formed is shod with boulders and with pieces of rock which have fallen down their crevasses. These pieces of rock abrade and polish and scratch the rocky bed in which they lie when they are dragged over it by the moving ice. Without this motion they can of course effect nothing either as burnishers or excavators." But there is another agent of erosion which is only called into play under the peculiar circumstances afforded by glaciers, and one which, I venture to think, is sufficient to account for the formation of these hollows. This is, briefly, the action of the water, derived from the melting of the surface of the glacier. It is now some five years since I had the good fortune to be able to explore some of the large glaciers in the higher regions of the Himalayas, and formed the conclusions which I am now about to put forward; but it seemed to me so likely that they had occurred to others, and probably been dismissed as unsatisfactory—though of this I could not assure myself, as it is long since I have had access to any library in which papers relating to such questions might be found—that I hesitated to publish them. It seems, however, from the remark in Sir II. Howorth's letter, quoted above, that no weight has hitherto been attached to this cause of erosion, however slight it may be, and therefore my observations may possibly be of some value.

Before going into details, I wish to draw attention to one or two facts which have been overlooked by Sir II. Howorth, and which have an important bearing on the discussion. In the first place, whatever be the cause of motion, it is an undoubted

fact that the lower portions of large glaciers do move over level or nearly level ground, and that for considerable distances. Whether the bottom layers of the glacier move at all under such circumstances does not matter much, but that the surface layers move is proved by the manner in which stones are carried down and deposited in a moraine often several miles distant from the foot of the steep slopes at the head of the valley. I am inclined to think that the amount of plasticity attributed to ice, founded on laboratory experiments, has been considerably underrated, and that under the conditions in which it exists in a large glacier it does actually flow, though very slowly, like a viscous body. Why gravity should cease to do any work on the ice, when it rests on a level surface, as Sir H. Howorth states, I cannot see, and when we consider the enormous thickness and weight of ice in a large glacier, there seems nothing strange in its spreading out or flowing in the only direction in which motion

posits, the stream which rushes out from beneath the glacier is unable to cut down into the solid rock. Therefore, supposing the end of the glacier to remain at or about the same position for a long period, and allowing for a moment that there is *any* erosion whatever going on beneath the glacier higher up, there is undoubtedly a tendency towards the formation of a hollow, closed at its lower end by a rock barrier.

Having clambered over the masses of moraine matter which conceal the lower end of the glacier, we enter upon a broad expanse of ice comparatively free from boulders. Here the surface of the ice usually lies at a very gentle inclination, and may continue in this manner for several miles, until the foot of the steep snow-covered slopes, riddled with crevasses, forming the third stage alluded to above, is reached. It is to this middle, gently sloping portion of the glacier that I wish especially to draw attention, as it is here that the agent of



Glacier at head of Bhutra Valley Zan-ka-rang, Keshmir. *a*, Old Moraine; *b*, present termination of glacier.

is possible, if we allow any degree of plasticity whatever. In the second place, that erosion of some kind, and that to a large amount, does go on beneath a glacier is proved by the turbid state of the water which issues from the end of it, and it must be remembered that this turbidity of the water is not occasional like that of a river in flood, but is continuous, or at least is recurrent every twenty-four hours, throughout a great portion of the year.

In ascending one of the larger Himalayan glaciers we notice at least three well-defined stages. First, at the foot of the glacier, and for a considerable distance up, perhaps a mile or more, the ice is almost completely concealed by the burden of moraine stuff brought down from above, which, as the ice melts away, is continually being deposited on the floor of the valley. As a result of the continued renewal of these loose de-

erosion, to which I refer the digging out of the hollows, is alone effective. And it is in such positions—that is, immediately below a point where the inclination of the valley decreases more or less abruptly—that in a formerly glaciated region rock-basins are most commonly found.

The ice in this portion of the glacier is traversed by occasional narrow crevasses, into which the streams, often of considerable size, arising from the melting of the surface ice under a hot Indian sun, plunge sooner or later, carrying down numerous pieces of rock with them. Even if the crevasse does not originally extend to the bottom of the glacier, a shaft must quickly be worn out, so that the falling water is enabled to exert the whole of its force directly on the solid floor of rock. These waterfalls are, of course, well known under the name of "moulin," but I do not think that sufficient weight has been

attached to them as an agent of erosion. They must act like so many gigantic drills upon the rock surface, and dig out hollows similar to those found at the foot of an ordinary waterfall. It may be objected that, when the glacier has retreated, we ought to find, instead of one large hollow, a series of pits corresponding to the position of each moulin; but here the peculiar conditions afforded by the presence of the ice come into play. Any particular moulin never keeps the same position for any length of time, not only because a new crevasse may open at any point in the course of the stream, but also because the water is continually cutting back the edge of the fall, as in an ordinary waterfall, but much more quickly. Thus the drills, in course of time, work backwards and forwards over the whole of the area occupied by this portion of the glacier. Indeed, their action may be compared to that of a rapidly revolving drill moved slowly over the surface of a piece of wood, which would ultimately be cut out to any desired depth, or to the action of a sand-blast directed on a piece of plate-glass.

It may be noted that none of the streams find their way down the glacier as far as the mass of moraine matter near its lower end, so that they can have no effect on the rock barrier, which, as I have pointed out, has a tendency to form beneath that portion of the glacier. Moreover, the majority are swallowed up before they reach the lower third or so of this middle portion of the glacier, and thus the well-known section of the bed of those rock basins which have been attributed to glacial action, deepest near their upper ends, and gradually shallowing lower down, is simply and easily accounted for.

It is a curious fact that, in the Himalayas, true rock basins are of very rare occurrence, although the conditions for their formation on the above hypothesis are conspicuously present. It is not, however, difficult to account for their absence if we consider the enormous amount of *débris* carried down by the Himalayan glaciers as compared with that borne by most European glaciers, to judge from pictures and photographs of the latter. It is only the lower portion of the Himalayan glaciers that is so entirely covered by *débris*, and the difference may be partly due to the fact that the hill-sides above this portion of the glacier are much less protected by ice and snow than in the case of the northern glaciers. On the retreat of the glacier this burden of moraine stuff would be quite sufficient to fill up any hollow that may have been formed beneath it. This is well shown in the accompanying illustration, where there is a well-defined old moraine at *a*, the present termination of the glacier being at *b*. Between these two points stretches an almost level plain, some four or five miles long, in which we should have expected to find a lake, supposing a hollow had been worked out beneath the glacier; but in place of it we find this broad stony plain covered with *débris*, evidently derived from the main glacier and from the side valleys. But suppose the glacier were to advance again, all this loose material would in course of time become frozen into the bottom of it, and carried out. Then if a rapid retreat of the glacier were to occur, leaving no time for the hollow—if any exists—to be filled up again, we might have a lake where the plain now is. Or, the contrast may perhaps be accounted for by a difference in the rate of change of climate since the glacial period, which may have been more slow in these southern latitudes than further north, so that the northern glaciers had not sufficient time during their retreat to fill up the hollows formed beneath them. If, as has been supposed, the extension of the European glaciers was partly due to a diversion of the Gulf Stream, might not the rapid breaking down of the barrier which caused that diversion have given rise to the rapid amelioration of climate required?

It would not, I think, be difficult to carry out a few measurements of the erosion that goes on beneath a glacier, which might throw much light on the question. If one visits the mouth of one of these glaciers early in the morning, the stream which issues from it is seen to be nearly, but never quite, free from sediment. This amount of sediment might, I think, be taken as that due to the rasping action of the ice itself, aided by the rocks frozen into its under surface. As the day proceeds, and the surface of the glacier begins to melt, the volume of water issuing at its foot quickly increases, and at the same time it becomes thick with mud. It would be easy to measure the velocity of the stream, and the amount of sediment at intervals during the day, and from this, knowing the area of the glacier, we could estimate the erosion due respectively to the rasping action of the ice and to the drilling action of the moulins. That the latter would be enormously in excess of the former I have

no doubt whatever, and I think that it is worth considering whether this may not be an adequate cause of those hollows which do undoubtedly occur in positions that seem to connect them with a former extension of glaciers.

T. D. LATOUCHE.

#### CHRONO-PHOTOGRAPHIC STUDY OF THE LOCOMOTION OF ANIMALS.<sup>1</sup>

THE chief interest in the study of organised beings is to look for the similarity which exists between the special conformation of each species, and the particular characters of the functions in this species.

The union of comparative anatomy and physiology is becoming more and more close, and will, without doubt, lead to the discovery of the fundamental laws of morphology—laws by means of which the inspection of an organ will permit us to foresee the particularity of its function.

These relations begin to be comprehensible in the case of the organs of locomotion of vertebrates. The size and length of the muscles, the relative dimensions and form of the bony supports of the members, the extent and the form of the articulating surfaces enable us to infer the character of the movements of mammals; and, on the other hand, the accuracy of these deductions can be proved by controlling them by chrono-photography, which gives the geometrical character of these movements.

Attempts have been made to extend this method of analysing the movements of a number of different animal species by chrono-photography, and they have been successful not only with mammals, but also with birds, reptiles, fishes, molluscs, and arthropods.

It will no doubt be a lengthy enterprise to collect the numerous series of pictures necessary for this comparison, but we have been able to assure ourselves that it is nearly always possible to obtain such pictures by varying the conditions according to the kind of animal studied.

Reptiles, for example, must be put in a kind of circular canal, where they can run at their ease; the chrono-photographic apparatus is placed above the path in which the animal runs, and thus photographs the successive attitudes during the course.

The fish swim in similar troughs filled with clear water, and illuminated underneath, in order that their silhouettes should appear on a clear background. At other times the animal is lighted from above, and thus appears light on a dark background. Similar arrangements are employed for insects. It is not necessary to have here the dark background which served for the study of mammals and birds. The principal difficulty is to ascertain whether the animal under experiment is moving in its normal fashion. With the domestic and tame kinds this is not considerable, but with wild species it requires much patience and many attempts to secure the natural movement.

On comparing some of the types of which chrono-photographic images have been obtained, very interesting analogies are found. Thus, for locomotion on land, as well as in water, it is possible to follow the gradual transitions between simple reptation and the more complicated kinds of locomotion. An eel and an adder put in water, progress in the same way; a wave of lateral inflexion runs continually from the head to the tail of the animal, and the velocity of the retrograde progression of this wave is slightly greater than the rate of movement of the animal itself.

If an eel and an adder are placed on the ground, the manner of reptation is modified in the same way with both species. The undulatory movement has here and there a greater amplitude, and this amplitude increases with the smoothness of the surface on which the animal moves.

With fish, provided they have fins, and with reptiles which have feet, there remains, in general, a more or less pronounced indication of the undulating movements of reptation.

With the dog-fish, for instance, the retrograde wave which goes the length of the body is very pronounced; it is much less with salmon, and exists hardly at all, except at the end of the tail, with fish with thicker bodies.

The retrograde wave during the terrestrial movements of the Gecko is plainly visible, but is less pronounced with the grey lizard and green lizard.

The batrachians present, during the successive phases of

<sup>1</sup> Translation of a communication by M. Marey to the Paris Academy of Sciences.

their evolution, varied types of locomotion, familiar to every one, of which the chrono-photographic analysis is very interesting. The tadpole of the toad, for example, exhibits progression in the first stage by the undulation of the fin, when the feet appear there is a mixed type of locomotion; the tail undulates, and on both sides the posterior members execute the movements of swimming which is usual to them. These movements of the posterior limbs alone remain some time after the tail has disappeared. Of these movements, which resemble so much those of human swimming, one is especially notice-

Did they belong to the same age as those of the Reindeer Period of the Dordogne? Or should they, on the other hand, be referred to some still living race of men already settled on that Ligurian coast in the "Polished Stone Period"? Other inquirers, again, have sought a third alternative, and referred them to an intermediate period, to which the name "Miolithic," or, better, "Mesolithic," has been speculatively given.

In view of these differences of opinion, the discovery in February of last year of fresh human remains in one of these grottoes associated with relics that throw a clearer light on the

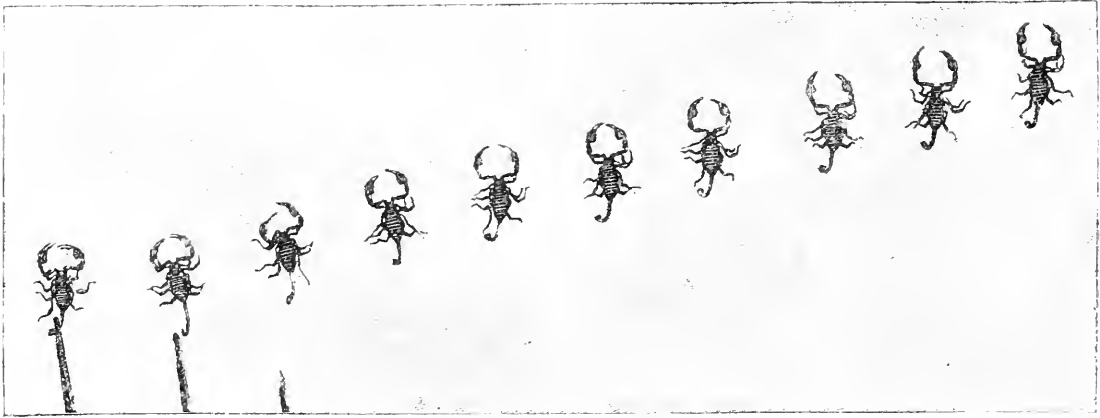

FIG. 1.—Movements of the Scorpion.

able; in this the anterior limbs do not take any part, and the posterior, after having formed a right angle with the axis of the body, approach each other till they become parallel, then bend and stretch themselves again to begin anew. The movements of the lizard's limbs escape direct observation on account of their rapidity, but on the chrono-photographic images, taken at the rate of forty to fifty a second, one can easily follow the successive movements of the limbs in front and behind. With the grey lizard, as well as the Gecko, the normal pace is that of a trot, that is to say, the limbs move diagonally. The great

culture and surroundings of those deposited with them than any hitherto discovered there, has naturally created considerable interest.

The caves in which these discoveries have been made are formed in the sea-face of the promontory of lower cretaceous limestone that rises just across the Italian frontier on the Ventimiglia side of Mentone, and which, from its red bastions, is locally known as Baoussé Rousse, or, in its Tuscan shape, Balzi Rossi. As early as 1858 the Swiss geologist, M. Forel, had obtained from a superficial layer of one of these caves various animal bones associated with implements. Subsequently Mr. Moggridge dug a section in the grotto known as the Barma dou Cavillou, revealing five floors "formed in the earth by long-continued trampling," with traces of a hearth in the centre of each, and around flint flakes, axes, hammer-stones, and bones of animals. The animal bones were, however, of existing species, and this evidence clearly pointed to Neolithic habitation. But later, M. Rivière, whose patient exploration of these caverns deserves our warm recognition, whatever may be thought of the conclusions drawn by him, unearthed in the same cave, only a foot or two from the point where Mr. Moggridge's excavations had ceased, the perfect skeleton of a man. The skeleton lay on its left side in the attitude of sleep. A stone lay beneath its head and another behind the loins. An ornament composed of bored shells—which may recall the trochus-studded nets still worn by Venetian peasants—was found adhering to the skull, their adherence being due to a ferruginous substance, fragments of which lay near, and which gave a ruddy colour to the whole. Evidently this ochreous substance had been used by the departed in his life-time to paint his face and body, and the whole character of the deposit clearly points to careful interment. From the discovery of bones of extinct animals mixed with the ashes in the overlying stratum, M. Rivière concluded nevertheless that the skeleton was palæolithic.

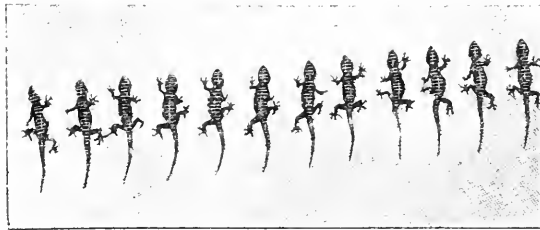

FIG. 2.—Movements of the Gecko.

amplitude of the movements of the limbs, combined with the undulation of the axis of the body, causes the limbs to approach one another very much on one side, and the next instant to separate. The Gecko carries its hind foot nearly under the armpit on the side where the body becomes concave; the instant afterwards, this side becomes convex, the anterior limb advances very much, and the two limbs (the body presenting on this side a convex arc) will be wide apart.

Many other very interesting observations can be made relating to the movements of insects and arachnids.

#### THE MAN OF MENTONE.<sup>1</sup>

FEW groups of prehistoric finds have provoked a more persistent controversy as to their date and character than those of the Mentone Caves. Were they Palæolithic or Neolithic?

<sup>1</sup> "On the Prehistoric Interments of the Balzi Rossi Caves near Mentone, and their Relation to the Neolithic Cave-Burials of the Finalese." By Arthur J. Evans. A résumé of a paper communicated to the Anthropological Institute. (The cuts are kindly lent by the Institute.)

The fact that the skeleton of the Barma dou Cavillou was undoubtedly embedded amongst Quaternary remains lent some weight to M. Rivière's opinion, and his view of the matter found acceptance from such competent judges as Mr. Pengelly and others. But the presence of the Neolithic hearths, noted by Mr. Moggridge, in an adjacent part of the cave, combined with other circumstances, led M. De Mortillet and Prof. Boyd Dawkins from the first to take a different view. They saw only the evidence of a Neolithic interment in a Palæolithic stratum.

The annexed diagram (Fig. 1) will give an idea of the general conformation of the cave or cleft known as the Barma Grande,

in which the most recent discoveries have been made. From the data that I was able to gather on the spot from quarrymen who at one time or another had taken part in its excavation, the original floor of the cave, at its mouth, over the spot—that is, where the skeletons were found—was 7.50 metres above the stratum in which they lie. But this depth only includes what has been artificially removed from the cave. There are reasons for believing that the deposit had originally been somewhat higher, but that the original level of the floor had been previously lowered by natural agencies.

In 1884 a discovery of a human skeleton had already been made in this cave by Louis Julien, the foreman of the men employed in quarrying the cliff; and so far as the details of this

many *nassa neritea*, and on the legs a little below the top of the tibiae were two *Cypraea*s.

Immediately behind this lay a skeleton, recognised by Dr. Verneau as that of a woman. It rested on the left side with the knees slightly drawn up, and its right hand almost resting

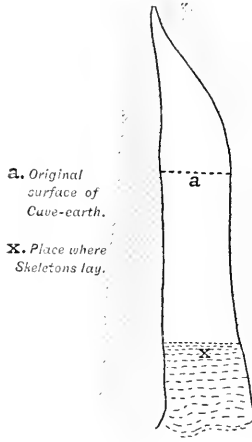

FIG. 1.

find have been preserved, they answer very closely to that of the Barma dou Cavillou. The discovery of 1892 was made close to the spot where the skeleton of 1884 had been unearthed.

Unfortunately, as in the former case, it was not made by a scientific excavator, but by men engaged in quarrying the limestone cliff. I visited the spot shortly afterwards on more than one occasion, but the ornaments and implements had been removed by the owner of the quarry to his house, and there was some difficulty in ascertaining the exact position in which the several relics were discovered.

The subjoined sketch (Fig. 2) will give a fair notion of the position in which the bodies were found. They lay across the present mouth of the cave, with their heads to the east. The

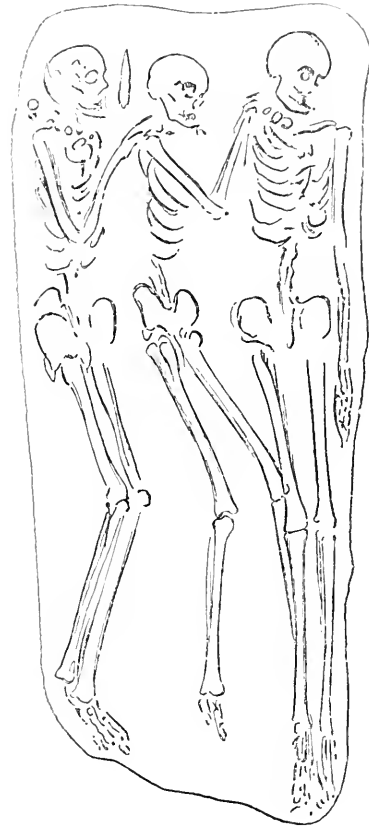

FIG. 2.

on the giant's shoulder. It is said to have held another flint knife. This female skeleton was not so richly decked with ornaments as the other two, the bone and tooth pendants being absent in this case. The third skeleton, of a youth, lay in much

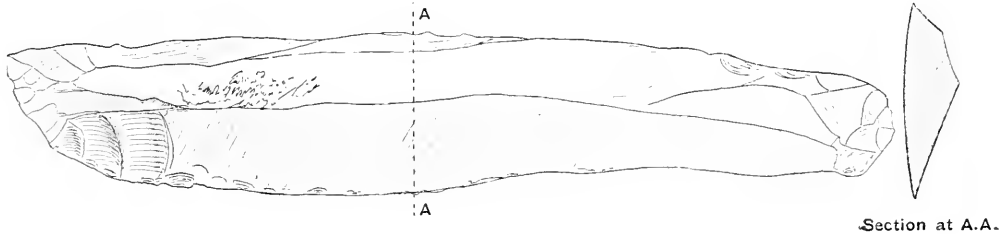

FIG. 3.—Flint knife found with first skeleton.  $\frac{1}{2}$  linear (23 x 5 cm.).

outermost skeleton was that of a man apparently well on in life. Unfortunately the skull was broken with a blow of a pick at the moment of discovery, and the length of the skeleton can therefore be only approximately given. From his heel to his shoulder he measured 1.85 metres, so that he was probably at least as tall as the taller of the three adult skeletons found in 1872-1873, which reached the length, according to M. Rivière, of 2 metres. This gigantic frame was somewhat turned to the left, but it lay more on its back than the other two. By his left hand, laid close to his femur, lay a long flint knife (Fig. 3). About the neck and on the skull were remains of ornaments of teeth and bone, fish vertebrae and pierced shells, among them

the same attitude as the second, with its right hand raised as if to be laid on the shoulder of the individual in front of it. Under or near its head a third flint knife was discovered. Both the two inner skeletons, though of tall stature, were distinctly smaller than the first discovered.

From the position in which the bodies lay it seems natural to conclude that the two smaller individuals here interred were in a position of dependence on the old giant. Amongst the objects found, chiefly, as far as I could gather, about the heads and necks of the skeletons, were remains of necklaces or head ornaments of shell and bone, amongst which may be mentioned bored shells, fish vertebrae, and teeth—apparently canines of

deer—which had been much rubbed down and in some cases adorned with incised lines and nicks (Fig. 4). Of the bone ornaments discovered, the most remarkable were some curious objects like double eggs or acorns connected by a common stem (Fig. 6). These, too, were incised in a similar manner. Amongst the bored shells found I was shown specimens of small *Cypræa* (millepunctata), *Cerithium*, and a kind of *Trochus*, and a quantity of *Nassa neritoides*—the same shell that formed the head ornament of the skeleton excavated by M. Rivière in the Barma dou Cavillou.

Another interesting correspondence between the present discovery and that of the Barma dou Cavillou was the presence, in the earth about the skeletons, of lumps of a ferruginous substance, which in this, as in the other cave, had partly stained the bones. There can be no doubt that this had been placed with the departed that he might have the wherewithal to paint his face and body for entry into the Spirit World.

On the osteological characteristics of the skeletons I cannot speak as an expert. They have, however, been examined by competent authorities, whose accounts in the main agree. The skulls were decidedly dolichocephalic. The large skull has prominent supra-orbital ridges, the smaller skull has these prominences less marked and is narrower across the frontal bones, but, still, stronger, thicker, and more definitely ridged than the Neolithic skulls of the Finallese. Professor Issel, M. Rivière, Mr. A. V. Jennings, and more recently Dr. Verneau have been independently led to compare the Cro-Magnon skulls—M. Rivière especially laying stress on the curious rectangular orbits. Prof. Issel, in a communication read before the Natural History of Genoa, although himself in favour of the Palæolithic date of the interments, was yet led to the conclusion that the crania and skeletons presented on the whole the same racial

Laugerie Haute and Basse, but there were included quartzite and other forms peculiar to the still earlier art of Le Moustier. In the same way the bones of extinct animals found lead us on this showing to the conclusion that the "Man of Mentone" dated back to the days of the earliest group of Pleistocene mammals. But as a matter of fact among several cases of bones of animals found in the immediate neighbourhood of the skeletons that have been recently examined all are of recent species, and not a single characteristic Quaternary form occurred. It is to be observed, moreover, that the mere fact that these were interments, implying as it does previous excavation, makes the appearance of Pleistocene remains, and even Palæolithic implements at higher levels in the cave-earth, of no value for determining the age of the skeletons.

The careful laying out of the dead in the attitude of sleep with his flint knife in his hand, his necklace and head ornaments, and the ochre beside him wherewith to paint his face and body in the other world—all this shows a development in religious custom which has hitherto in no single well-authenticated instance been carried back to Palæolithic times. It is characteristically "Neolithic." We may go further and say that the special forms of sepulture discovered here fit on in a suggestive way to the burial rites still practised at a later date on this same coast by the Neolithic people of the Finallese. There too we find the body laid out in the same attitude of sleep, with the legs partially drawn up, an attitude which, as distinguished from the still more contracted posture of the Northern races in primæval times, we may perhaps venture to regard as characteristic of a less severe climate, and the less habitual necessity for drawing up the legs under the shelter of whatever served them as a mantle. There too we find the same bored shells and teeth hung round the neck, and the same ferruginous substance laid

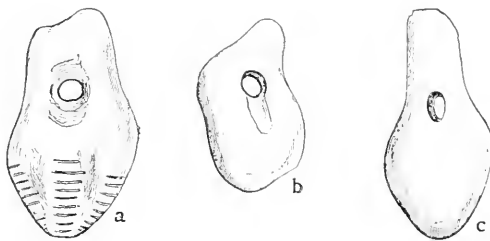

FIG. 4.—Deer's-tooth pendants.

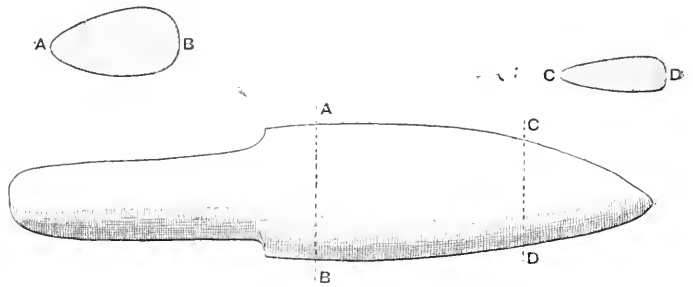

FIG. 5.—Bone arrow-head.

characteristics as the undoubtedly Neolithic skeletons of the caves of the Finallese further along the same Ligurian coast.

The great depth at which these skeletons occurred, and the absence, in this whole group of finds, of pottery, polished stone implements, and the bones of domestic animals, must be certainly taken to show that they date from a considerably earlier period than the Neolithic interments of the Finallese caves—in which all these elements of more developed culture are abundantly represented.

But are we therefore to conclude that the Balzi Rossi remains are of Palæolithic date?

It seems to me that there are other circumstances to be considered in connection with these latter finds, which do not admit of such a conclusion—unless, indeed, the word "Palæolithic" is to be given a sense different from its usual acceptation.

When we come to examine the views as to the extreme antiquity of the instruments, such as M. Rivière has not hesitated to put forward in the most unqualified manner, we find, in fact, a curious illustration of the danger of proving too much. The skeletons lie in all cases beneath a vast mass of cave-earth in which the remains of extinct animals are undoubtedly associated with implements of flint and bone that may justly be regarded as the work of Palæolithic man. Therefore we are told the interments themselves must belong to the same age. Long flint knives such as those discovered, may, it is true, find parallels in some of the later Palæolithic caves such as that of La Madeleine, though like implements were also in common use in Neolithic times. But the argument invoked by M. Rivière leads us to consequences far beyond this. In the cave-earth of the overlying stratum implements occurred not only of types characteristic of the Magdalenian group, of Solutré, and of

beside the departed to deck his person in the Spirit World; there too flint and bone objects (some of these latter of very similar forms) were placed ready to his hand. In the caves of Balzi Rossi, however, the skeletons were at most propped up or pillowed by large stones; in the Finallese interments, such as those of the grotto of the Arene Candide, we find, in the case of the adults, stones placed round and over the skeletons so as to form a rude cist, though the children were still simply buried in the cave-earth. In these later interments, moreover, the polished axes and pottery placed beside the dead as well as the remains of domesticated animals attest the higher stage of culture amidst which they had lived. Still the points of similarity in the sepulchral rites practised in both groups are unmistakable. And in view of these points of resemblance the conclusion arrived at by Prof. Issel, that the Balzi Rossi skeletons, in spite of some more primitive characteristics, belong essentially to the same race as the skeletons of Finalmarina, gains additional force.

The bone implements supply us with some fresh points of relationship. The bored pendants, formed of canines of deer much worn down, found with the skeletons both in the Barma Grande and the Barma dou Cavillou are identical even to their notched decorations with ornaments of the same kind found by Prof. Issel in the Caverna delle Arene Candide near Finalmarina associated with undoubtedly Neolithic remains. Identical pendants have also been found in the Neolithic deposit of the Grotta di Sant' Elia in Sardinia. It is to be observed that very similar deer's tooth ornaments, though without the notches, were found in the caves of La Madeleine, Laugerie Basse and Les Eyzies, where they are ascribed to the Reindeer Period. A stumpy bone punch also found near the Barma Grande skeletons, in the possession of Mr. A. V. Jennings, is of the same type as a bone implement from the excavations of the Neolithic deposit



in the grotto of the Arene Candide. Another very close parallel is afforded by the cusped bone instrument represented (Fig. 5), which the Rev. J. E. Somerville, of Mentone, obtained from the neighbourhood of one of the last discovered skeletons of the Barma Grande. Though blunter and thicker, it greatly resembles some of the bone arrow-heads from the Neolithic burial-place in the Arene Candide cave.

Of all the bone objects, however, discovered with the present interments the most interesting are those already referred to as

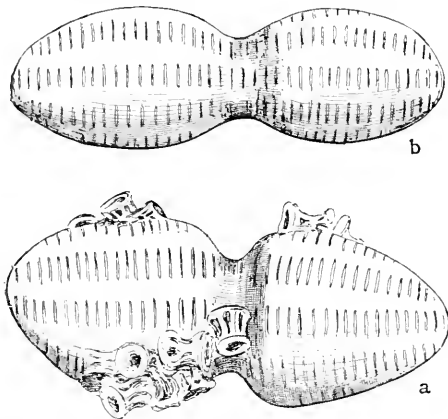

FIG. 6.—Bone ornaments, (a) with fish-vertebræ adhering.

resembling two small eggs, or acorns, with their big ends united with a connecting stem. The bossy part of these ornaments was decorated with rows of parallel lines running up the sides like the rungs of so many ladders. Seven or eight of these are said to have occurred in all, but, like other relics found, most of them have since disappeared. The shape of different specimens varied slightly, some being more elongated than others.

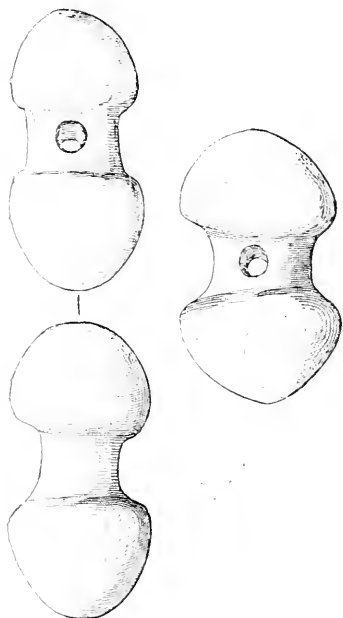

FIG. 7.—Scandinavian amber beads.

But what at once struck me on seeing these objects was the great resemblance they presented to certain amber ornaments discovered with early Neolithic skeletons in the galleried tombs of Scandinavia and North Germany. The objects in question are certain double-bossed ornaments of amber, in Scandinavia generally known as "hammer-shaped" beads, and which, from their supposed resemblance to the stone-hammers of the same period, have been by many supposed to have been worn as amulets. (Fig. 7.)

The geometrical system of ornamentation from the Mentone Cave seems to be found on bone and horn relics of the "Reindeer" period; on the other hand, like the bone ornaments themselves, it presents the closest analogy to a style of ornamentation very characteristic of the Later Stone Age in Northern Europe.

The conclusion, then, to which we are led by these converging lines of evidence is that the interments of the Barma Grande and the other caves of the Balzi Rossi cliffs, though embedded in a Palæolithic stratum, are themselves of Neolithic date. On the other hand, however, the entire absence of pottery, of polished implements, of remains of domestic animals, as compared with the abundance of all these features in the Neolithic interments of the Finale Caves further up the same Ligurian coast, is on any showing a most remarkable phenomenon. A greater degree of petrification is also observable in the bone and other objects discovered. *In all probability, therefore, we have here to deal with an earlier Neolithic stratum than any of which we have hitherto possessed authentic records.* If the evidence of these Balzi Rossi interments is to count for anything, it must henceforth be recognised that a race representing the essential features of the later population of the polished Stone Age was already settled on the Ligurian shores of the Mediterranean at a time when many of the civilised arts, which have hitherto been considered as the original possession of Neolithic Man on his first appearance in Europe, were unknown. It will no longer be allowable to say that these supposed immigrants from Asia brought with them at their first coming certain domestic animals, and had already attained a knowledge of the potter's art, and of the polishing of stone weapons. And, if this is the case, something at least will have been done towards bridging the gap between the earlier and later Stone Age in Europe. Till such time, however, as remains of extinct animals are found in such association with human interments as to prove their contemporaneity we must still allow for a vast interval of years between the latest remains of the "Reindeer Period" and interments, such as those of the Mentone Caves.

The racial characteristics of the skeletons of the Balzi Rossi, while linking them at one end with the later Neolithic occupants of the Finalese, show that they had essentially the same physical type as the early skeletons found in Cro-Magnon Cave with very similar ornaments of bored shells and teeth. The same features occur again in the skeletons from the Neolithic grotto of the Homme Mort, in Lozère, and in some of the French dolmens, as that of Vignettes. The type recurs East of the Apennines and in Central Italy, Sicily, and Sardinia; and the field of comparison extends to Southern Spain and the Canaries.

The physical connection with the Dolmen people derives additional interest from the comparisons established between the bone ornaments found with the Barma Grande skeletons and the amber hammer-beads of the Scandinavian Gallery Graves, and the decorative system of the pottery found in the same. It looks as if in the polished Stone Age the Neolithic settlers in the North of Europe had transferred to the new materials, such as amber and earthenware, forms and ornamentation which had already been an ancient possession of a race settled on European soil in still more primitive times.

Two shells found with the Balzi Rossi interments, *Pecten maximus* and *Cypræa millefucata*, seem to point to Atlantic connexions. In the later Neolithic interments of the Finalese, on the other hand, which may represent the same race in a more advanced stage of development, we see new influences coming in from a very different direction. Some of the shells found with these seem to have been derived from the Southern Mediterranean, and one, the *Mitra oleacea*, found by Prof. Issel in Caverna della Arene Candide, must have made its way by some primitive line of intertribal barter from the Indian Ocean.

UNIVERSITY AND EDUCATIONAL INTELLIGENCE.

OXFORD.—Mr. Theodore J Pocock, of Corpus Christi College, has been elected to the Burdett-Coutts Scholarship in Geology. For the Merton Biological Fellowship a strong list of candidates is reported, including among others Messrs. F. E. Beddard, M. S. Pembrey, E. A. Minchin, P. C. Mitchell, and R. T. Günther.

As the result of a memorial addressed to them by the demonstrators in the various departments of Natural Science, the Hebdomedal Council have appointed a committee, consisting of Mr. T. Raleigh, of All Souls, and Mr. T. H. Grose, of Queen's College, to inquire into the position and status of the demonstrators at the museum.

CAMBRIDGE.—Dr. Forsyth has been appointed chairman of the Examiners for the Mathematical Tripos, Part II., and Mr. Welsh, of Jesus College, for Part I.

Prof. Ramsay, of University College, London, has been elected Examiner in Chemistry for the Natural Sciences Tripos.

At St. John's College, Mr. E. W. Macbride, Hutchinson Research Student, and University Demonstrator in Animal Morphology, has been elected to a Fellowship. Mr. Macbride took a first class in both parts of the Natural Sciences Tripos (zoology and botany) in 1890-91, and is the author of various morphological papers based on researches conducted in Cambridge and at the Zoological Station at Naples. He has been President of the Union Society, and is well known as a vigorous debater. At the competition for Fellowships on this occasion there were no less than seven candidates in Natural Science, who had all taken first class honours in the Tripos as students of St. John's.

### SCIENTIFIC SERIALS.

Wiedemann's *Annalen der Physik und Chemie*, No. 10.—On air vibrations, by A. Raps. The changes of density at the nodes of open and closed organ pipes were recorded by allowing a beam of strong white light to fall upon the mirror of a Jamin interference refractor. One of the reflected beams was sent through a pipe at the node, the other through a box containing undisturbed air. After reunion by the second mirror, these two beams gave rise to interference fringes, which were displaced during the changes of density accompanying the sound of the pipe. A section across these fringes, consisting of bright and dark points, was received upon a revolving drum carrying sensitive paper, and the oscillation of the points gave rise to a series of curves representing the sound vibrations with very fair accuracy. A series of eighty-eight photographs are reproduced, which give valuable hints concerning the structure of the various notes, and also some vowels and consonants produced in the open air.—Luminous phenomena in electrode-less vacuum tubes under the influence of rapidly alternating electric fields, by H. Ebert and E. Wiedemann. This paper, a sequel to the general investigation published in No. 9, deals with the details of the phenomena observed between the condenser plates of a Lecher wire system in the case of spheres, cylinders of various lengths, conaxial double cylinders, and glass parallelepipeds with plane ends.—Heat of dissociation in electro-chemical theory, by H. Ebert. Calculations based upon heat of dissociation and electrolytic work show that the forces of chemical affinity are chiefly of an electric nature, that the forces due to "valency-charges" are the most powerful of any atomic forces, and that any additional chemical forces are, in comparison, infinitesimal.—Equipotential lines and magnetic lines of force, by E. von Lommel. Some further photographic tracings of these lines are given, and their bearing upon the Hall effect is discussed.—Objective representation of interference phenomena in spectrum colours, by the same author. Simple arrangements are described for exhibiting Newton's rings, gypsum fringes, convergent polarised light phenomena, and fringes produced by the rotation of the plane of polarisation in quartz prisms, upon a screen. For Newton's rings the light from the heliostat is reflected by a colour plate, and falls upon a lens which produces an image of the sun at its focus. By placing a slit at this focus and a prism between slit and lens, the rings in all the spectrum colours may be thrown upon the screen by shifting the slit.—Papers by Kayser and Runge, P. Czermak, and R. J. Holland have already been mentioned.

THE pages of the *Botanical Gazette* for September contain but little except reports of the proceedings of the Botanical Section of the Madison meeting of the American Association for the Advancement of Science, of the Madison meeting of the Botanical Club, and of the Madison Botanical Congress. That for October contains several important papers:—On the fructification of *Juniperus*, by Mr. J. C. Jack, who states that in America the fruit of the English species of juniper does not

mature until the autumn of the third year after blossoming; on the development of the embryo-sac of *Acer rubrum*, by Mr. D. E. Mottier; on the achenial hairs of *Compositae*, by Miss M. A. Nichols; and on the bacterial flora of the Atlantic Ocean in the vicinity of Woods Holl, Mass., by Mr. H. L. Russell. The results obtained by the author accord in a general way with those previously made in the Mediterranean. While the water and underlying sea-flow are filled with bacterial life, they are by no means in an entirely quiescent condition. Both water and mud are peopled with micro-organisms which are undergoing their cycle of development here as elsewhere.

THE Nos. of the *Journal of Botany* for October and November are almost entirely occupied by papers on local and descriptive botany, including the completion of Mr. E. G. Baker's synopsis of Geneva and species of *Malvea*, and a sketch of the botany of Ireland, by Mr. A. G. More.

THE summer number of the *Fahrbuch* (Austrian Geological Survey) contains contributions by Drs. Emil Tietze, von Wöhrmann, Bittner, Skuphos, and others. Dr. Emil Tietze writes on the "Geology of the Ostrau District." Great hopes were raised in this neighbourhood by the discovery of coal near Wagstadt, in the Upper Oder valley, but Dr. Tietze informs us that the coal occurs only locally and in mere fragments. With regard to the age of the Ostrau beds, he argues that they should be grouped with the upper and not with the lower carboniferous series. They rest unconformably on the Culm grits and shales and are conformably succeeded by the Schatzlar beds, a deposit closely resembling the Ostrau beds in general character. Another paper by Dr. Tietze discusses the prospects of the salt industry in East Galicia.—Baron v. Wöhrmann contributes an article on the "Systematic Position of the Trigonidae and the Descent of the Nayadidae." He shows that both the Trigonidae and the Nayadidae have true heterodont hinges, and that therefore the classification into schizodont and heterodont bivalves suggested by Neumayr cannot be carried out. Taking the fresh-water bivalve *Unio* as type-form of the Nayadidae, v. Wöhrmann traces the phylogenetic relationship of this family with the genus *Trigonodus* (Up. Triassic shore deposits), and through *Trigonodus* with the ancient ancestral type, *Myophoria* (Devonian to Rhenic).—Dr. Theodor Skuphos completes his survey of the Partnach beds in the Northern Alps. He found in the Vorarlberg deposits of this age a new fossil Saurian, which he names *Partanosaurus Zitteli*. Dr. Skuphos thinks it probable that this Saurian is identical with certain remains found in extra-alpine deposits of Upper Muschelkalk age in Württemberg.

### SOCIETIES AND ACADEMIES.

LONDON.

Physical Society, October 27.—Prof. J. Perry, F.R.S., vice-president, in the chair.—Mr. E. C. Rimington read a paper "On the Behaviour of an Air-Core Transformer when the Frequency is Below a certain Critical Value." Taking the ordinary differential equations for two circuits having self and mutual induction, and assuming sinusoidal E.M.F.'s and constant coefficients, the author shows that although the difference of phase between the primary P.D. and primary current is always diminished on closing the secondary circuit, yet under certain circumstances this closing increases the impedance of the primary. With constant P.D. this means that closing the secondary decreases the primary current, a phenomenon not usually observed. The critical conditions necessary for increased impedance are fully worked out in the paper, as well as those under which this increase becomes a maximum. In the case of two identical coils with no magnetic leakage, the critical value of  $\alpha$  ( $\alpha = \frac{L}{r_1}$  where  $L = 2\pi$  times the frequency,  $L$  the inductance of the primary, and  $r_1$  its resistance) is  $\sqrt{2}$ , whilst that to give maximum impedance is  $\frac{1}{\sqrt{2}}$ . The maximum increase possible is  $15\frac{1}{2}$  per cent. The corresponding values are given for various amounts of magnetic leakage in tabular form, and curves were exhibited at the meeting showing how the impedance, current, power, and magnetising effect vary for different values of  $\alpha$ . To test his conclusions the author made experiments on two coils close together, the observed increase in impedance amounting to 3·2 per cent. In addition to the analytical

investigation, the subject is treated geometrically at considerable length. Prof. Minchin showed that the impedances might be represented by two hyperbolas, having  $f^2$  as abscissæ and the squares of the impedances as ordinates. These could be readily constructed from the data given. A line representing the primary inductance drawn on the same diagram intersects one hyperbola, showing that the impedance has always a maximum value. By a simple construction the phase angle between the primary and secondary currents could be determined for any given conditions. Dr. Sumpner observed that increased impedance on closing the secondary necessarily meant a decrease in the lag of the primary current behind the primary P.D. Mr. Blakesley was pleased to see the geometrical method of such service, and thought it much simpler than the analytical one. The reason why increased impedance on closing the secondary of ordinary transformers had not been noticed was because their lag angles were very large. In a figure published some years ago to represent the actions of transformers, the angles he had chosen were such as would make the primary impedance increase on closing the secondary. Giving an expression connecting the primary currents on open and closed secondary respectively, he now showed that to get increased impedance, the sum of the lag angles in primary and secondary must exceed  $90^\circ$ . To get large power in the secondary the primary lag should be nearly  $90^\circ$ , and the secondary about  $45^\circ$ . He also pointed out that some of the figures in the paper might be simplified considerably. Prof. Perry said he had long had the impression that if a sufficiently small current were taken from the secondary, increased impedance would be observable in all cases, and he quoted some numbers he had given in the *Phil. Mag.*, for 1891, showing a decided increase. Mr. Rimington, in reply, said he was not aware that the effect he had now brought forward had been observed previously. The result was completely worked out analytically before using geometrical methods.—Mr. W. B. Croft showed "Two lecture-room experiments." One, on "The Rings and Brushes in Crystals," was performed by very simple apparatus in two ways. In the first, a bundle of glass plates was used as a polariser, and a Nicol prism as analyser. When a Nicol could not be conveniently obtained, a glass plate could be used as a reflecting analyser. For a convergent system two glass card-counters were used, the crystal being placed between them. Very good results were produced by this simple apparatus. In the second arrangement the crystal was placed on the eye-piece of a microscope (whose objective was removed), and covered by a tourmaline. On reflecting light up the tube by means of a piece of glass held at the proper angle excellent results were obtained. Another experiment, on "Electric Radiation in Copper Filings," was similar to those described by Dr. Dawson Turner at the Edinburgh meeting of the British Association. A battery, galvanometer, and glass tube containing copper filings were joined in series. Under ordinary circumstances no current passed, but immediately an electric spark was produced by an electric machine many feet away, the galvanometer was violently deflected, and remained so until the tube was tapped. On trying different materials, aluminium and copper seemed about equal, but iron not so good; carbon allowed the current to pass always. Prof. Minchin said the phenomena were strikingly like those exhibited by his "impulsion cells," for the moment a spark passed, even at a distance of 130 feet, they became sensitive to light. Very minute sparks were capable of producing the change, but by adding capacity to the sparking circuit the effect could be greatly modified. Replying to a question from Mr. Rimington, he said the change was due to electromagnetic vibrations, and not to light emitted by the sparks. Mr. Blakesley inquired if lengthening the sparks produced greater effect on the copper filings. Mr. Lucas asked if the resistance of a tube ever became infinite again if left for a long time. In reply, Mr. Croft said the current sometimes passed before the spark actually occurred between the knobs. He had not left tubes for very long, and had not found the resistance reappear without tapping.

Royal Microscopical Society, October 18.—A. D. Michael, President, in the chair.—Mr. J. G. Grenfell described some marine diatoms, recently found at Plymouth, belonging to the genera *Melosira* and *Surirella*, which were of interest owing to the presence of pseudopodia. Mr. A. W. Bennett objected to the term pseudopodia being applied to these processes unless it could be shown that they were actual prolongations of the internal protoplasm. Mr. T. Comber said that

Prof. Grunow was of the opinion that the processes were spines.—Mr. E. M. Nelson exhibited and described a new model of a microscope by Messrs. Watson.—Mr. F. Chapman read Part V. of his paper "On the Foraminifera of the Gault of Folkestone."—Prof. Bell gave a *résumé* of a paper by Dr. R. L. Maddox, "On Progressive Phases of *Spirillum volutans*." The author had traced the development of this organism, and had discovered some points which appeared to be entirely new in the history of bacteria.

PARIS.

Academy of Sciences, October 30.—M. de Lacaze-Duthiers in the chair.—The grape vine harvest of 1893 and the produce of the Camargue, by M. Chambrelent. In spite of the severe drought the vineyards of the Gironde have given the richest yield in the century. This has been due to a unique combination of favourable circumstances during their development. The facility with which they withstood the drought may be attributed to the fact that vine-leaves have a peculiar power of absorbing dew, which has been very abundant. This year has also witnessed the earliest date of harvest known in the century. In 1822 it took place on August 31, whilst this year it was eight days earlier. The quality of the harvest, which improves with the quantity, may be expected to prove very good.—On the application of sound vibrations to the analysis of mixtures of two gases of different densities, by M. E. Hardy. The apparatus, called the formenophone, consists of two organ pipes, one of which is filled with pure air, the other containing the mixture of gases to be analysed. The pipes are of the same dimensions, and give the same note when blown under the same circumstances. If one of them is filled with air containing 1 per cent. of formene, the unison is disturbed and one beat is heard every three seconds. With 2 per cent. there are three beats in two seconds, with 3 per cent. two beats per second, and so on. Similar results may be obtained with carbonic acid as an impurity. The figures given apply to pipes sounding  $C_4$ . For mixtures whose density closely approaches that of air  $C_5$  is more suitable. Each determination is finished in a few seconds. The apparatus is well suited to the determination of the amount of fire-damp in mines.—Observations of Comet Brooks (1893, Oct. 16) made at the Algiers Observatory by MM. Rambaud and Sy.—Observations of the sun made at the Lyon Observatory (Brunner equatorial) during the first half of 1893, by M. J. Guillaume. This is a summary of the observations made of sunspots and facule, with particulars of their positions and areas.—On a new theorem of mechanics, by M. N. Seiliger.—On carboxyl derivatives of dimethylaniline (dimethylamidobenzoic acid) by M. Charles Lauth.—On the baking temperature of bread, by M. Aime Girard. Numerous experiments have proved that  $101^\circ C.$  is the normal temperature in the interior of bread and biscuit during baking if the product is to be satisfactory.—Study of the reproduction of wasps, by M. Paul Marchal. Careful observations of the physiological function of the workers, miscalled neuters, of a common wasp's nest have proved parthenogenetic reproduction by the workers, without the cooperation of the males, and the exclusively male sex of the individuals thus produced. It appears that there is a division of labour between the queen, who produces mainly females and workers, and the workers themselves, which are only capable of producing males.—On the localisation of the active principles in *Tropæolum*, by M. Léon Guignard. In the *Tropæolum* family, all the organs enclose myrosine, localised in cells distinct from those which contain the glucoside, which it decomposes to produce the essence. The latter does not pre-exist in the tissues and cannot be formed without the intervention of the ferment. The family shows in this respect a complete analogy with the Crucifers and Capparidæ.—On the existence of gismondine in the geodes of a basalt of the environs of Saint-Agrève (Ardèche), by M. Ferdinand Gonnard.—Fractures of the coal measures of southern Chili, by M. A. E. Nogués. In the lignite region extending from the Bay of Talcahuano to Lebu, there is found a large fault running from east to west, which it is proposed to call the Lebu-fault. To the north of this fault the strata incline towards the west; to the south, they incline towards the east. Between San Rosendo and Lebu may be traced a system of parallel north-to-south faults which have affected the older strata; a system of parallel east-to-west faults, which have dislocated the arenaceous lignite territory; and a system of secondary faults, which have brought about changes of level in this same formation.—General

characters of the *bogheads* produced by Algæ, by MM. C. E. Bertrand and B. Renault. A study of the *boghead* of Autun, the kerosene shale of Australia, and the brown torbanite of Scotland show that these deposits are due to the thalli of a single species of alga, that of Autun containing *Pila bibractensis*, the kerosene shale *Reinschia australis*, and the Torbanite another *Pila*.

BERLIN.

**Meteorological Society, October 15.**—Prof. von Bezold, President, in the chair.—Prof. Hellmann spoke on the frequency of halo phenomena, after having first described their typical features and their causation by reflection and refraction from hexagonal ice-prisms. From observations at Upsala extending over seven years he had ascertained that the 22° halo is most frequently observed, then mock suns and moons, then the 46° halo, and least frequently the vertical pillars of light. On the whole the phenomena are five times more frequent in connection with the sun than with the moon. During the course of a year the phenomena follow a regular course; solar-halos are at a maximum in May and a minimum in December, whereas lunar-halos are at a maximum in December and a minimum in May. If snow-crystals were equally plentiful in the air at all periods of the year, then solar-halos would be most frequently seen in June, at the time when the sun is above the horizon for the longest period on each day. But inasmuch as there are fewer snow-crystals in the air in the summer, the maximum is put back to May. The maximum for lunar-halos occurs when the nights are longest and there are most snow-crystals in the air. Statistics from the polar stations for 1882–83 show that only solar phenomena occur during the period of midnight sun, and only lunar phenomena during the polar night, their frequency being solely dependent on the occurrence of clouds. An account was given of a stroke of lightning in Heligoland which had smitten two persons near the railroad, killing one and stunning the other. Photographs were exhibited of the latter as showing the characteristic marks on the arm, chest, abdomen, and legs. After a member of the Society had suggested a new method of estimating clouds—which, however, requires further working out and testing—the President drew attention to wave-clouds as described by Von Helmholtz in his most recent theoretical work on the dynamics of the atmosphere. They occur when two layers of air travelling with different velocities pass one over the other, in which case waves are formed and clouds at the junction of the layers. These clouds are then drawn out into long strips, formerly called polar-bands. They occur not only in the layers of cirrus clouds, but also at lower levels. A wish was expressed that these clouds might be photographed.

**Physical Society, October 20.**—Prof. Kundt, President, in the chair.—Dr. Raps gave an account of his work on the photography of aerial vibrations. The method is based on the use of a Jamin's refractometer, which produces interference phenomena by means of reflection and refraction of a ray of light at the surfaces of two parallel glass plates. When the air between the two plates is transmitting waves of condensation and rarefaction, the interference bands are displaced, and if they fall on a slit behind which a sensitized paper is kept in motion on a drum, the waves of aerial vibration may be recorded. The experiments were first made on a closed organ-pipe, near whose upper end were two openings facing each other but closed with glass. Through these the two rays of light passed before they were made to interfere. When the pipe was gently blown, sine curves alone were obtained, corresponding to the fundamental note of the pipe. As the pressure was increased, the overtones became more and more prominent, until at last they alone determined the shape of the curve. Further experiments were made with closed reed pipes, after it had been ascertained that the tongue of the reed vibrates like a pendulum. The phenomena were the same as in the first case. Experiments with open pipes were found to be much more difficult, but even in this case good photographs of the vibrations were obtained. Dr. Raps had also been able, by the same method, to photograph the vibrations resulting from the singing of vowels, and to show that definite harmonic overtones are characteristic of each vowel. Similarly photographs had been taken of the vibrations due to a hunting-horn. Dr. Raps further exhibited an Ampère apparatus for lecture purposes, in which the current was supplied by means of metallic instead of mercury contacts.

**Physiological Society, October 27.**—Prof. du Bois Reymond, President, in the chair.—Dr. Lewin gave an account

of researches on the physiology of the ureter, carried out in conjunction with Dr. Goldschmidt. These had shown that the entry of urine into the upper end of the ureter is due to pressure exerted by the kidney; that the peristaltic waves of contraction of the ureter either pass right down to the bladder, or occasionally stop short in their course along the ureter; that the point of entry of the ureter into the bladder is possessed of a sphincter, but that notwithstanding this it is occasionally possible for fluid to be driven back out of the bladder into the ureter.—Prof. Senator spoke briefly about the experiments he made some seventeen years ago, on the results of varnishing the skin in men, defending their validity, and the conclusion that varnishing does not affect the health, against objections which had recently been brought forward.—Dr. Cohnstein described experiments on the influence of diffusive processes on transudation. When salt solutions were allowed to flow under a constant pressure through a ureter or jugular vein surrounded by fluid, it was found that the amount of salt passing through into the outer fluid increased with the pressure on the latter. Similarly a solution of egg-albumen diffused more copiously into an external fluid than could be observed when it was forced by filtration into a space filled with air; but the amount of albumen which passed through was independent of the external pressure. This diffusion must play a very important part in the transudation of fluid from the blood-vessels, and in the tissue-cells of the living organism, and may suffice to explain many as yet incomprehensible phenomena.

## CONTENTS.

|                                                           | PAGE |
|-----------------------------------------------------------|------|
| Dr. Werner von Siemens . . . . .                          | 25   |
| Iron Ores. By Bennett H. Brough . . . . .                 | 27   |
| Our Book Shelf:—                                          |      |
| Newhall: "The Shrubs of North-Eastern America."—          |      |
| W. B. H. . . . .                                          | 28   |
| Briggs and Edmondson: "Mensuration of the Simpler         |      |
| Figures" . . . . .                                        | 28   |
| Calvert: "The Discovery of Australia" . . . . .           | 28   |
| Prince: "Graphic Arithmetic and Statics" . . . . .        | 28   |
| Russan and Boyle: "The Orchid Seekers" . . . . .          | 28   |
| Letters to the Editor:—                                   |      |
| Human and Comparative Anatomy at Oxford.—Prof.            |      |
| E. Ray Lankester, F.R.S. . . . .                          | 29   |
| "Geology in Nubibus." An Appeal to Dr. Wallace            |      |
| and others.—Sir Henry H. Howorth, M.P.,                   |      |
| F.R.S. . . . .                                            | 29   |
| Correlation of Solar and Magnetic Phenomena.—             |      |
| William Ellis, F.R.S. . . . .                             | 30   |
| The Recent Earthquake.—Charles Davison . . . . .          | 31   |
| An Ornithological Retrospect.—Frank E. Beddard,           |      |
| F.R.S. . . . .                                            | 31   |
| The Foam Theory of Protoplasm.—E. A. Minchin . . . . .    | 31   |
| Science in the Magazines . . . . .                        | 31   |
| On a Meteorite which fell near Jafferabad in India        |      |
| on April 28, 1893. By Prof. John W. Judd, F.R.S. . . . .  | 32   |
| Notes . . . . .                                           | 33   |
| Our Astronomical Column:—                                 |      |
| A New Southern Star . . . . .                             | 38   |
| "Astronomical Journal" Prize . . . . .                    | 39   |
| Comet Brooks (October 16) . . . . .                       | 39   |
| Moon Pictures . . . . .                                   | 39   |
| Meteor Showers during November . . . . .                  | 39   |
| Geographical Notes . . . . .                              | 39   |
| The Erosion of Rock Basins. ( <i>Illustrated.</i> ) By T. |      |
| D. LaTouche . . . . .                                     | 39   |
| Chrono-Photographic Study of the Locomotion of            |      |
| Animals. ( <i>Illustrated.</i> ) . . . . .                | 41   |
| The Man of Mentone. ( <i>Illustrated.</i> ) By Arthur J.  |      |
| Evans . . . . .                                           | 42   |
| University and Educational Intelligence . . . . .         | 45   |
| Scientific Serials . . . . .                              | 46   |
| Societies and Academies . . . . .                         | 46   |

THURSDAY, NOVEMBER 16, 1893.

## ROMANES ON WEISMANN.

*An Examination of Weismannism.* By G. J. Romanes, M.A., LL.D., F.R.S. (London: Longmans, Green, and Co., 1893.)

DR. ROMANES is a most competent hurler of hard words, and in this volume is concerned at least as much to convince the reader that Weismann is an uncertain guide as to be to him himself a certain guide. In the preface he states his intention to publish his criticisms "in separate form and in comparatively small editions, so that further chapters may be added with as much celerity as Prof. Weismann may hereafter produce his successive works." In the text, writing of the relations between the views of Galton and Weismann, he talks of those immense reaches of deductive speculation, which, in his opinion, merely "disfigure the republication of stirp under the name of germ-plasm" (!) The mention of certain occurrences which are believed in by Dr. Romanes, but the admission of which he considers illogical on the part of Weismann, "seemed attributable to mere carelessness on the part of their author." Another consideration is "made by Weismann for the sole purpose of saving as much as he can of his previous theory of variation." Another is "an obvious equivoque." The mechanism of heredity is planned out (in Weismann's latest volume) "in such minuteness of detail and assurance of accuracy that one is reminded of that which is given by Dante of the topography of the Inferno."

Of the actual criticism the last chapter and the two appendices alone require special treatment, as they alone were written after the publication of "Amphimixis" and "The Germ-plasm."

It does not seem useful to insist with Dr. Romanes that the continuity of the germ-plasm is the inverse of the basis of the theory of pangenesis. The most important part of the continuity theory has no parallel in Darwin's provisional hypothesis. It is the attractive suggestion of a material basis of heredity which can be identified with structures visible under the microscope; which can be seen, in some cases, to separate immediately from the fertilised ovum to form the foundation of the germ-cells of the new individual, or, in other cases, to move along "germ-tracts" to the foundation of the germ-cells of the new individual. What is directly comparable in the two theories is the picture each gives of the phenomena of inheritance viewed in pangenesis as a rolling up of gemmules from an existing body to form germ-cells; in the germ-plasm as the unrolling of germ-plasm to form a developing body. In this, as Dr. Romanes points out, the one theory is the inverse of the other, and very naturally similar groups of facts may appear in the one as stages of rolling up, in the other as stages of disintegration. But here again Weismann, aided no doubt by the vast advance in microscopical science, constantly is more in touch with observed facts of microscopical detail than was Darwin.

Dr. Romanes uses a good deal of space for a minute and interesting comparison of Weismann's germ-plasm with the "stirp" of Galton. He urges that natural

selection, so potent in the organic world, probably does not cease in the separate parts of a body during development, and therefore supports Galton's view of a competition among many gemmules of the same order as to which shall actually cause development. But natural selection is not a force: it is merely an aspect of certain occurrences, and while there may be many (as Galton thinks) or few (as Weismann thinks) units of germ-plasm each capable of causing development, and only one of which does cause development, the aspect of the occurrences on which Weismann wishes to direct attention is that the process of development goes on by an orderly disintegration of the germ-plasm through various stages of units, and that the order is determined by the "historic architecture" of the germ-plasm. This "historic architecture" is the material representation (on Weismann's theory) of the observed fact that ontogeny does to some extent repeat phylogeny. A continual struggle among innumerable units would account for too much variation, and would leave unrepresented the habitual fixedness of heredity.

In his criticism of Weismann's view of evolution Dr. Romanes first states how recent further investigations (those of Maupas and others) into the conjugation of Protozoa have led to an identification of conjugation with sexual reproduction, so far as they both result in a mingling of germ-plasm, but he quarrels with Weismann for not abandoning the potential immortality of the Protozoa. But whether Protozoa conjugate or not, on the broad average they divide by fission. That means that Protozoa alive to-day have come down in a continuous chain of cell-life from primeval Protozoa, unless indeed there have been continual re-creations of Protozoa. Even if it were proved that spore-formation invariably interrupted at long or short intervals chains of simple fission, still practical immortality may be held by regarding spore-formation as merely multiple fission.

In a more important criticism Dr. Romanes seems to me to misinterpret Weismann's position. When the continuity of germ-plasm first presented itself to Weismann's mind, and brought with it the idea that the somas of each generation were mere pendants of the chain of germ-plasm, it became difficult to see how the impression of outside nature on the soma could be impressed in turn on the germ-plasm. This led to an examination of a new kind into acquired characters, and the result of that examination satisfied Weismann and many others that there was no sufficient reason for supposing that characters acquired by the individual were transmitted to the progeny. Of course this is still a matter of argument, and as Dr. Romanes in this book refers to a full treatment of the question, the publication of which has been delayed by his regrettable illness, it may well be that he will adduce fresh and important considerations. But the fact remains that Weismann, driven back from acquired characters as a cause of phylogenetic variation, came to regard the mingling of germ-characters in amphimixis (traceable back to the direct influence of the environment upon organisms antecedent to amphimixis) as the source of all variation. The germ-plasm lived as a parasite within the soma, and was related to it only by the fact that it got food from the soma. In the more developed doctrine

Weismann retains the original conception. But the germ-plasm is now a particulate substance, and *inequalities of nutrition affecting the separate elements cause variations in it*. The original conception has now become more definite, and this increase in definition has effected a reconciliation with some strong objections to the generalised idea. It seems to me extraordinary that a critic so acute as Dr. Romanes, not in the heat of controversy but in a deliberate book, should call this "removing stone by stone, his doctrine of descent," and "turning upside down the fundamental postulate." In order to reach such a view he has had to be much more certain than Weismann, about what Weismann meant, and to attribute to "mere carelessness" the inclusion in Weismann's earlier writings of indications pointing in this direction.

In Appendix I. the germ-plasm is discussed specially in so far as Weismann considers pangenesis a less conceivable and a more formal explanation. I think the key to the criticism is again to be found in a misconception by Dr. Romanes. He quotes from Weismann:—

"How can such a process (*i.e.* the passage of gemmules into growing germ-cells) be conceivable when the colony becomes more complex, when the number of somatic cells becomes so large that they surround the reproductive cells with many layers, and when, at the same time, by an increasing division of labour, a great number of different tissues and cells are produced, all of which must originate *de novo* from a single reproductive cell?"

He goes on:—

"Here again the obvious answer is that no one has ever propounded such a statement. Far from supposing that 'all the different cells and tissues of a complex organism must originate *de novo* from a single reproductive cell,' the theory of pangenesis supposes the very contrary—*viz.* that somatic changes in the past history of the phyla had *not* thus originated in *any* reproductive cell. The idea of somatic changes originating in reproductive cells belongs to the theory of *germ-plasm*; but even this theory does not suppose all the great number of different cells and tissues which compose a complex organism to have ever originated *de novo* from a single reproductive cell."

What Weismann means seems clear enough, although it is dark to Dr. Romanes. The whole of a complex organism grows out from an ovum, and this origin occurs *de novo* in each generation. Pangenesis supposes that gemmules from each cell in the body somehow come together to form the ovum, and they come together so that they unroll in proper order. For this process there is no trace or shadow of evidence: to many it seems *à priori* inconceivable.

According to Weismann's theory the germ-plasm has been slowly built up in phylogeny, and slowly unrolls in the individual development. On any supposition the process is wonderful: on Weismann's hypothesis the evolution of germ-plasm has actually followed the evolution of living things from simple to complex, and there is no new wonder in its complexity, nor is the unrolling of the historically elaborated germ-plasm more wonderful than the actual development of the historically elaborated soma. The hypothesis of pangenesis supposes that in each living organism there is a new wonder, the giving off of gemmules, and their building up into an ovum

which reproduces not only the structures which gave off gemmules, but many an embryonic structure dating far back in phylogenetic history.

Appendix II. deals with Telegony, and practically consists of Dr. Romanes' recent controversy with Herbert Spencer. In the mass of confused data about this subject it seems fairly established that at least it is very rare. The influence of a first sire does not as a rule affect children to a second sire. Herbert Spencer thinks that the established cases are fatal to Weismann's theory, inasmuch as they prove that influences impressed on the soma can be transferred to the offspring. Romanes thinks that they are not fatal, inasmuch as germ-plasm from spermatozoa of the first sire coming in contact with the ovary when a spermatozoon caused impregnation, might, as they disintegrate, allow some of their germ-plasm to penetrate the ovary and reach other ova. The actual explanation seems, to the present writer, a much simpler one, but as he is collecting facts he will only mention it. In the best established cases, as for instance Lord Morton's mare, and the sow quoted by Mr. Spencer, the first sire was of a more ancestral type than the second sire, and the characters in the progeny attributed to the influence of the first sire were atavistic, and in ordinary cases would have been simply referred to as throw-backs. But as at present Dr. Romanes' criticism of Weismann is the matter in hand, it is enough simply to point out that in this most difficult case for followers of Weismann, Saul also is among the prophets—Dr. Romanes agrees with Weismann! P. C. M.

#### EXTRA-TROPICAL ORCHIDS.

*Icones Orchidearum Austro-Africanarum Extra-tropicarum; or Figures, with Descriptions of extra-tropical South African Orchids.* By Harry Bolus, F.L.S. Vol. i. Part 1. (London: William Wesley and Son.)

THIS is an excellent work, devoted to the orchids of extra-tropical South Africa, and arranged on the lines of the "Refugium Botanicum" of Mr. Wilson Saunders. The first part includes fifty plates, containing figures and dissections (partly coloured) of fifty-one species. The text comprises descriptions in Latin and English, references to original descriptions, synonymy, geographical distribution, with critical and explanatory notes. The author's many years of careful study of South African orchids, as well as his previous writings on the subject, are sufficient guarantee of the quality of the work; and as regards the plates, a decided improvement is noticeable, both in the drawings and lithography, as compared with his previous "Orchids of the Cape Peninsula" (reviewed in *NATURE*, vol. xxxix. p. 222). The work will be of great use to the systematic botanist, for, as Mr. Bolus has well pointed out, few orders of plants stand more in need of illustration from living specimens than orchids, because of the high degree of specialisation of many of the parts, some of which are very fleshy, and seldom recover their shape after soaking or boiling. Nine new species are described in the present part, *Angræcum caffrum*, *A. Maudsl.*, *Habenaria Galpini*, *Satyrium Guthriei*, *S. ocellatum*, *Pachites Bodkini*, *Disa sabulosa*, *D. conferta*, and *Brown*

*leca Galpini*. There are strong grounds, however, for suspecting that *Satyrium Guthriei* is not a true species, but a natural hybrid. It was described from a single living specimen found growing with *S. candidum*, Lindl., in burnt-off places on the Cape Flats, Tokai, near Cape Town, by Mr. F. Guthrie. Mr. Bolus remarks that the column "resembles in some degree that of *Satyrium bicallosum*, Thunb., while both are in this respect very different from that of any other *Satyrium* known. In every other character this differs greatly from *S. bicallosum*, and I very much doubt if it is a natural hybrid." This remark shows that Mr. Bolus had suspicions about the matter. It is a remarkable fact, however, that in every character in which *S. Guthriei* differs from *S. bicallosum* it approaches *S. candidum*; in fact, with the exception of the column, it bears a much closer resemblance to the last-named species, and as the organs generally are intermediate in character between those of the two species, there seems little doubt that it is a natural hybrid between them. Many such organisms are now known, and as both the species grow in the district, there is nothing improbable about the matter.

There are several points of interest about the work, one or two of which may be mentioned here. The discovery of a new species of *Pachites* is very interesting, as the original one has only been met with on four occasions. Burchell found a single specimen in 1815; Krauss met with another twenty-four years later; and now, after a lapse of fifty years, Mr. Schlechter has discovered two more specimens. Mr. Bolus hopes to publish a figure in the next part of his work. It is a curious coincidence that the new species is only known from a single specimen. An interesting note is given as to the affinities of *Schizochilus*. Sonder had indicated it as a member of the *Habenariæ*, but Bentham transferred it to *Diseæ*. Mr. Bolus again places it near *Habenaria*, and his drawings unmistakably show that this is its real position. Mr. Bolus calls attention to a very curious character found in *Satyrium pumilum*, Thunb., which Lindley referred to a separate genus. The flowers are transversely striped with brown, like a *Stapelia*, and to make the resemblance more complete, they also have a heavy odour of putrid flesh. As it differs so markedly from its allies in these characters, it is evident that we have here an adaptation to secure the visits of the insects which fertilise the *Stapelias* of the same region. And this reminds us that scarcely anything is known of the fertilisation of South African orchids. Mr. Bolus figures a beetle on the plate of *Disa elegans* (t. 35), which he found upon one of its flowers, with a pollinium attached to its thorax. It is said to be a species of *Peritrichia*, belonging to a group of well-known fertilisers. "This being only the second instance," remarks the author, "of an insect actually carrying orchid pollen which I have seen during many years' study of Cape orchids, I have thought it desirable to figure it with the plant." Among the undoubtedly handsome species may be noted *Disa ferruginea*, Swartz, and *D. graminifolia*, Ker. The former is noted as "abundant on Table Mountain," and its dark orange-vermillion flowers are "largely sold in bouquets in the streets." The latter was called *Herschelia graminifolia* by Lindley, though Mr. Bolus considers *Herschelia* as only a section of *Disa*. We are told that

"it is one of the commonest species within our limits, has a rather long flowering period, and attracts universal observation by its beauty and brilliancy: so much so, that Lindley, in dedicating it to the great astronomer Herschel (who also was a great orchid-lover and cultivator), felicitously speaks of it as "species hæc pulcherrima colore calii australis intense cæruleo superbiens!" Future parts of this useful work will be awaited with interest.

R. A. KOLFE.

#### OUR BOOK SHELF.

*An Astronomical Glossary.* By J. E. Gore. (London: Crosby Lockwood and Son, 1893.)

FIFTY years ago it was the fashion to insert a glossary or dictionary of astronomical terms in every work on astronomy, but few of the books published in late years include these helpful explanations. Mr. Gore endeavours to supply the need in the volume before us. And if the science of astronomy had made no advances during the last half-century, we should have been able to give the highest commendation to his compilation. But since celestial science has had its limits considerably extended, and the old astronomy is giving place to the new, we naturally expect to find the new terms defined in a glossary which pretends to contain "an explanation of all the terms and names generally used in books on astronomy." We were greatly surprised therefore, upon looking through the book, to notice the omission of many common and important words to be found in almost every work on astronomy. Among other omissions are the words corona, prominences, chromosphere, photosphere, spectroscope, and prism. Zones are correctly described, and are exemplified by "torrid zone," "frigid zone," and "temperate zone," but the term "sun-spot zone" is unexplained. No mention is made of spectroscopic binaries, or of motion in the line of sight, or of zodiacal constellations. Stereograms are defined, but not spectrograms—that useful word coined for spectroscopic negatives. Neither meridian instrument, nor meridian circle are indexed. In fact, so many words constantly employed in astronomy at the present time are omitted, that we have come to the conclusion that Mr. Gore has only attempted to include in his glossary words used when he was a schoolboy. The tables of data merely refer to members of the solar system, and their value would be increased if the solar parallax were given which formed the basis of their computation. Lists of remarkable red stars, variable stars, and stars for which orbits have been computed, conclude the book—a book that might have been very handy to latter-day astronomers, but which in its present form is of no use whatever.

*With the Woodlanders and By the Tide.* By "A Son of the Marshes." Edited by J. A. Owen. (Edinburgh and London: William Blackwood and Sons, 1893.)

THE author of this book is well known as a close observer of nature; and a more enthusiastic lover of natural creatures and things for their own sake it would be difficult to find. To look at flocks of bramble finches feed in some particular old beech-woods at sunrise, he trudged for five miles through snow-covered woodlands; and the book is filled with accounts of similar sights observed at all times of the day and seasons of the year. In fact, "A Son of the Marshes" is imbued with the true spirit of a naturalist—the spirit that leads men to sacrifice everything in order to obtain a clearer insight into nature.

An interesting instance of protective colouration is given on p. 163. Some broken egg-shells of the fern-owl having caught the author's eye, he looked closer into the fragments, and saw what appeared to be a short, crooked

bit of dead furze stem. As he was bending over it, the supposed withered stem moved slightly, and gave him the impression that he was looking at the back of a large viper that had half buried itself in the furze. A still closer scrutiny showed that the semblance of a crooked piece of furze was two fern-owls about three days old.

We have read the book from cover to cover, and have been interested throughout. The author has looked to animate nature for his facts; hence his work possesses the sterling ring which every student of science delights to hear.

*Pitt Press Euclid, V.-VII.* By H. M. Taylor, M.A. (Cambridge: Univ. Press, 1893.)

WE have previously had occasion to refer to the earlier issues of this series of books on the elements of Euclidian geometry. The present publication is quite up to the standard of the former ones, and contains some important variations from the usual mode of treatment. In dealing with the fifth Book, Mr. Taylor rejects altogether the use of figures, since, as he rightly says, the book is not essentially geometrical. With a general knowledge of proportion as derived from treatises on algebra, a student is sufficiently equipped to follow its applications in Book vi. The numbering of the propositions is somewhat altered owing to the omission of some of the propositions in the Greek text. With regard to Book vi, Mr. Taylor has made some modifications in the treatment of similar figures, and many theorems are more briefly proved by adopting the definition of similar polygons there enumerated. The additional theorems which are inserted have been arranged in series—one, for instance, giving the student a sketch of the theory of transversals, harmonic and anharmonic ranges and pencils, leading up to Pascal's theorem; another of nine propositions, concluding with Gergonne's neat solution of the problem to describe a circle to touch three given circles. The method of inversion, Casey's extension of Ptolemy's theorem, properties of coaxial circles, and some porismatic problems follow next in order, the book concluding with a capital set of exercises and an index for the first six books.

*The Out-door World, or Young Collector's Handbook.* By W. Furneaux, F.R.G.S. (London: Longmans, 1893.)

A GREAT deal of information useful to the young collector, for whom Mr. Furneaux has prepared this handbook, is to be found in its four hundred pages. There are sixteen coloured plates, some of which are excellent and none bad, and more than five hundred illustrations in the text. Those of birds are somewhat unequal; some indication of relative size would have been helpful. The linnets and the cuckoo are placed side by side, and the former is apparently the larger of the two, while on the opposite page the great tit is considerably bigger than the lark, and rivals the cuckoo in apparent proportions. If the length of the bird had been given in brackets after the name under each figure, it would have prevented misapprehension. We have dipped here and there into the letterpress, and found the information accurate and clearly put.

*Worked Examples in Co-ordinate Geometry.* (Univ. Corr. Coll. Tutorial Series.) By William Briggs and G. H. Bryan. (London: W. B. Clive and Co., 1893.)

THE examples which are here brought together are intended to serve as a graduated course on the right line and circle, forming thus a useful companion to the book on Co-ordinate Geometry already published by the same authors. The work line is specially designed for the private student, and this is why the problems have been dealt with in such detail, every step in their solution

being clearly explained. The examination papers may fairly be taken as good test papers, for the questions seem to have been carefully selected, and the more important ones on book work are not lacking. For those teaching themselves this subject by working out the problems given, a good insight should be obtained, while the references to the author's work on co-ordinate geometry, above referred to, will be found very useful to those possessing that book.

#### LETTERS TO THE EDITOR.

[The Editor does not hold himself responsible for opinions expressed by his correspondents. Neither can he undertake to return, or to correspond with the writers of, rejected manuscripts intended for this or any other part of NATURE. No notice is taken of anonymous communications.]

#### Sir Henry H. Howorth on "Geology in Nubibus."

HAVING given my views on glacial geology in the current issue of the *Fortnightly Review*, to be followed by one dealing at some length with the ice-origin of lake-basins, I should not have thought any reply to Sir Henry Howorth's "Appeal" necessary except for the consideration that my articles may not be seen by many readers of NATURE. And first, I would remark, that the mental attitude which Sir H. Howorth imputes to extreme glacialists I have myself been unable to detect in their writings. In fact, I was under the impression that the "scoffing" and "jeering" was chiefly from the other side; but it seems I was mistaken, and I must apologise for my ignorance. Those who read my articles will see that I make no appeal to "transcendental ice," but judge of its powers and properties by its admitted effects. Sir H. Howorth says that "ice is known to crush under moderate pressure," implying that a glacier a mile or perhaps half a mile thick is impossible. But will he or anyone else tell us what happens to the ice after it is crushed, and the pressure that crushed it is continued and slowly increased? Will it not suffer re-gelation and become denser ice; and if by sudden increase of pressure it is again crushed, will it not by still further pressure again suffer re-gelation? He stops at the first "crushing," as if that were the end of all things so far as a glacier is concerned. All this, however, is beside the question from my point of view. The work of ice on the rocks is as clear as that of palæolithic man on the flints; all the difficulties that may be suggested as to how he lived, or how he shaped the flints do not in the slightest degree affect our conclusion that the palæolithic flint implements are the work of man; and there is equally clear evidence that ice *did* march a hundred miles, mostly uphill, from the head of Lake Geneva to Soleure, whatever transcendental qualities it must have possessed to do so.

As to "perhaps the largest and most remarkable collection of rock-basins in the world"—the largest being of 50 acres and the deepest 30 feet deep—I must really decline to occupy your space in showing how simply these may have been produced by ordinary denuding agencies, or in denying that any glacialist, even of "the most extreme and aggressive school," would claim them as proofs of glaciation. As regards the question of Tasmanian glaciation, my last communication to NATURE (Nov. 2) seems to me to render any further observations unnecessary. No doubt the conclusions of the various writers will be fully harmonised by a more complete study of the whole region.

The last point touched on by Sir H. Howorth—whether the advocates of the ice-origin of certain groups of lakes are "extravagant" in their views, following the methods of Aristotle rather than those of Bacon, and founding their beliefs on "purely hypothetical properties of matter and forces of nature"—I will leave to the judgment of those who do me the honour of reading my forthcoming article in the *Fortnightly Review*.

ALFRED R. WALLACE.

#### The Erosion of Rock-Basins.

MR. T. D. LATOUCHE's letter (page 39) is very interesting as a more than usually independent contribution (for the reason given therein) to the interesting question of glacial



erosion, and as showing how similar (allowing for the difference in size) are the phenomena of the Himalayan and the Alpine glaciers. But I think that moulins, as a rule, are not likely to be very important agents in the formation of the rock-basins in which lakelets and tarns are often lodged. So far as my experience goes, the range over which the moulin-torrents can act is very restricted; for the crevasse, which gives the opportunity to the water, is generally formed very nearly at the same part of the glacier. Thus after the moulin has travelled for a very short distance down the glacier, a new crevasse opens out behind it and cuts off the torrent. I have frequently seen four or five dry shafts in advance of the working moulin. The lateral range also of the moulin must be small. Hence I think that the giant's-kettle (as is usually supposed) more accurately represents the ordinary product of a moulin. An excellent illustration is afforded by the well-known "glacier-garden" at Lucerne. I think, also, that the rock-basins, of which we speak, are more commonly found in situations where moulins would not be numerous or large, viz. in cwms and corries. It is, however, true that in certain undulating rock districts, as parts of Scandinavia and the Scotch Highlands, lakelets are common. The form of these, however, does not appear to bear much relation to the hollow produced by a moulin. So that I doubt whether we can regard a moulin as an agent of primary importance in the production of an ordinary rock-basin, though it may sometimes be a minor contributory. As I have more than once discussed the question of the probable cause of the formation of tarns as well as of large lake-basins, it is needless to repeat what has appeared in print. T. G. BONEY.

23 Denning Road, N.W., November 13.

"The Zoological Record."

In your Notes for October 26, on p. 621, you follow the Editor of the *Zoological Record* in suggesting that, under the present financial conditions, palæontology should be removed from the volume issued by the Zoological Society, and provided for by the palæontologists themselves. Against such retrogression we desire to protest. "Everyone knows," as you say, "that an incomplete record is of very little use"; and how absurdly incomplete a record would be that took no account of palæontology! The objectors probably spring mostly from the ranks of systematic zoologists. We will deal with them on their own ground. The systematic position of *Limulus* has long been a vexed question, which no one can attempt to solve without consulting the work of Malcolm Laurie on the fossil Eurypterids. The classification of the Crinoids has troubled zoologists since the days of Johannes Müller; but neither he nor anyone ever dreamed of settling it without reference to palæontology. Students of recent Bryozoa will not be grateful to those who keep them in ignorance of J. W. Gregory's lately published work on the Bryozoa of the early Tertiary rocks. And so we might go on *ad infinitum*. Another argument that may affect the systematists is that if they reject all names of fossil genera and species from the record, they will have no means of knowing whether the new names they may wish to propose have been used before or not. It is even possible that some of them may unwittingly describe as new forms already described by some unknown palæontologist. It is hardly necessary to remind the morphologists, embryologists, and zoiogeographers of the help that they constantly receive from the palæontologists; they, at least, will not wish to have the record made incomplete.

It is suggested that every branch of science should have a record, and that palæontologists should undertake the compilation of a separate one. This would as good as double the work, both for recorders and students. What we have said above shows that palæontology is not a separate science. Zoologists and palæontologists ought to be the same people, and when they have strength enough they are so, as the names of Cuvier, Owen, and Huxley sufficiently testify. The palæontological recorder would still have to work through the writings of the zoologists, while even the pure neontologists would have perpetually to refer to the palæontological record.

What is really wanted is to complete the *Zoological Record*, not to make it incomplete—to go forward, not backward. It is admitted that some of the recorders do tackle the palæontological literature. Why should not all? If a group is too large for one man, then give it to two, and if a second man cannot be got to work on half-pay, then double the pay.

To prevent the record becoming too big, make it merely an index, and cut out the abstracts, which are rarely correct. If more money is wanted, appeal to other societies which might naturally be supposed interested in the work. It is unfair that a single society should bear the burden of a work that is of value to all, and one can hardly suppose that it would refuse kindly offers of help. We believe, indeed, that the only reason why some of the recorders abstain for the present from the palæontological work is because they feel that part, at least, of the expense ought to be borne by the society more directly interested.

R. I. POPOCK,  
F. A. BATHER,  
B. B. WOODWARD.

British Museum (Nat. Hist.), October 30.

Recognition Marks.

A QUESTION in natural history has occurred to me, which, I think, might with advantage be discussed in your columns.

It is usual to account for the white tail of the rabbit (*Lepus cuniculus*) by saying that it is useful as a danger signal to others of the species. Wallace, in his "Darwinism," speaking of rabbits, says that "the white upturned tails of those in front serve as guides and signals to those more remote from home."

Now, there appear to me to be two objections to this theory. The first is that the tail of the hare (*Lepus timidus*) is also white, and is turned up in precisely the same manner when running; but it is obvious, from the habits of this animal, that in its case it would be quite unnecessary for such a purpose.

And in the second place, if this were so, how could it have been produced by evolution? The object of the white tail is said to be to assist other rabbits to escape, not the possessor of the white tail itself. But the principle of evolution is the survival of the animal fittest to preserve its own life, not of the fittest to preserve the lives of others of the same species.

G. J. MACGILLIVRAY.

3 Belford Park, Edinburgh, November 6.

MR. MACGILLIVRAY has failed to grasp the principle of natural selection when he thinks that it cannot produce a character useful to other animals of the same species. The action of natural selection is to preserve the *species*, as well as each individual separately; and, consequently, every character useful to the species as a whole would be preserved. This is obvious when we consider such characters as nest-building in birds, and milk-secretion in mammals, which do not benefit the individual possessors, but their offspring; and the same principle applies to every character which is mutually useful to individuals of the same species, as are what I have termed "recognition characters." Neither can I admit that the habits of the hare render the white upturned tail "quite unnecessary." The hare is a nocturnal feeder, and a mark which readily distinguishes a friend from an enemy, and enables the young during their short period of infancy to keep within sight of the mother, must be of considerable importance.

ALFRED R. WALLACE.

Correlation of Solar and Magnetic Phenomena.

IN writing on this subject (NATURE, vol. xlix, p. 30), to save space I omitted to refer to one other case of resumed connection. But as such omission might be misunderstood, may I here briefly allude to it? M. Trouvelot, on June 17, 1891, observed changes going on in connection with a luminous appearance near the western limb of the sun, such as he had not before seen. But the magnetic movement was in this case insignificant (see *The Observatory*, vol. xiv, pp. 326-328). The same reasoning as before may be applied. If the smaller magnetic motions do really directly depend on solar changes of so marked a character, how does it happen that many greater recorded magnetic movements remain without corresponding solar change having been seen? It is a very interesting, indeed critical point, but much more information is necessary to prove that such close connection really exists.

The appearance was seen by Trouvelot near the sun's limb. There is a significant sentence ending a letter from the Rev. Walter Sidgreaves, of Stonylhurst (*The Observatory*, vol. xiv, page 326), as follows:—"But there are no indications of magnetic disturbance accompanying the solar eruptions seen through the spectroscope. Even the brilliant display on the western limb, of the 10th [September 10, 1891], has left nothing that

can be considered a record of itself on the magnetograph curves."

WILLIAM ELLIS.

Greenwich, November 9.

[With regard to the case cited by Mr. Ellis, it is worth remark that at the time of Trouvelot's observation, the writer of our "Astronomical Notes" asked Mr. Whipple whether the eruption was accompanied by any anomalous magnetic movements. Mr. Whipple replied: "There was not the slightest magnetic disturbance on June 17, 1891, at the hour you mention, or for days before or since." The point was again raised at the beginning of last year, and to make assurance doubly sure, Mr. Whipple again referred to the Kew curves, but failed to find any trace of what could be termed a magnetic disturbance at the hour in question. (See NATURE, February 25, 1892.)—ED.]

#### THE NEW BIRD-PROTECTION BILL.

SENTIMENT is a beautiful thing in its way, and when that way happens to coincide with the way of common sense, the man must be a brute who defies it. But unluckily that does not always happen, as is testified by several instances that could but here shall not be cited, for they will come uncalled to the recollection of many of our readers, and indeed to some they are ever present. These need not to have the difference between a sound and an unsound sentiment pointed out. But there is also a sentiment that is perfectly sound at the start, and yet, chiefly through want of knowledge—we hesitate to call it ignorance, because that might imply blame—sooner or later begins to betray symptoms of running on the wrong track, when, if the brakes cannot be applied, it comes into violent collision with common sense. As the latter is the weightier mass the harm it gets from the impact is not often very serious, and the injuries received seldom cause more than delay, however annoying that may be; but the effect on the lighter body is apt to be destructive, and though in some cases it may be only repelled with slight damage, in others it may be shattered. In either event, seeing that it set out with good intentions, the result is to be regretted.

Of this kind of sentiment is that which actuates the extreme advocates of Bird Protection. Time was when the sickening slaughter of sea-fowl at their breeding-stations around our coast appealed alike to sentiment and to common sense—to say nothing of science—to interfere. First carried on for what was called "sport," but soon for the sake of mere lucre, the feathered denizens of our cliffs and beaches were shot down by the thousand, to do nobody any good but the "plume-trader." The Act of Parliament which received the Royal Assent in June 1869, and is always to be remembered in connection with the name of Mr. Christopher Sykes, was just in time to save from extinction the population of many a thronged resort which has always presented, and we trust always will present, a spectacle of delight to the large and increasing class of our fellow-countrymen who appreciate the harmonies of nature, even if the resorts on the English coast cannot compare with those

—where the Northern Ocean in vast whirls  
Boils round the naked melancholy isles  
Of sea-girt Thule, or the Atlantic surge  
Pours in among the stormy Hebrides.

That Act may have had its shortcomings: few Acts are without them; but nobody can doubt it was effective to do good, and it was followed by other Acts, based on the same principle, and tending to relieve persecuted beings from persecution. An exception indeed must be made as regards one of them, but that one (which was commented upon at the time in these columns<sup>1</sup>) only serves to support the allegation in our introductory paragraph. In 1872 some enthusiasts followed the line of sentiment regardless of common sense, and succeeded in converting a well-considered and practical measure into one that

was specious and useless. They had their reward, for in the next session their parliamentary leader obtained a Select Committee of the House of Commons to enquire into the subject, and the result of the investigation showed every reasonable person the baselessness of the points for which the extreme party had contended, while three years later the very Bill which they had mutilated and mauled passed through Parliament almost exactly in the form in which it had been originally introduced. The enthusiasts, however, had the satisfaction of stopping useful and much wanted legislation for four years in order to gratify their own gushing and unintelligent sentiment, while their Act, always a dead letter, was superseded by the Act of 1880 which consolidated all previous legislation. Still the spirit that moved the enthusiasts is not dead. In one way or another it shows itself every year—sometimes, though not often, it confines itself within the bounds of common sense, but of late it has become we may say rampant. None of the former Acts had done anything to stay the taking of birds' eggs. Indeed, birds' eggs had been, and that purposely, wholly left out of consideration, and this in the eyes of many excellent people has seemed to be a glaring defect—even a crime. Let us stop birdsnesting, say they, and the number of our birds will be indefinitely increased. Nightingales will multiply, Goldfinches will be as plentiful as Sparrows, and Skylarks will swarm. Little do these good people realise the state of things. Let us grant that in the immediate neighbourhood of towns and large villages, where birds are already at a disadvantage, boys will emerge, and successively rob nest after nest as it is built with an effect that may be called devastating. The case, however, is very different in the country at large. There the first species of those we have just named already enjoys a protection incidentally yet almost invariably conferred upon it by the law of trespass. We can believe almost any act of folly or stupidity on the part of some game-keepers, and the widely-told story that one of that profession once declared that he destroyed Nightingales because their singing disturbed the nights' rest of his pheasants may have some foundation; but nearly all observers who have informed themselves by experience will agree that the part of England which Nightingales choose to occupy is generally as fully stocked with them as the place will hold. It is certain to those who watch that the number of Nightingales which return to this country with each returning spring is greater than that which can find room. Hence those ever-recurring contests of melody that we hear from rival cock birds on their first coming, to say nothing of the actual conflicts, often ending in the death of one of the combatants, that take place between the competitors. And it is only natural that it should be so. That if a Nightingale's nest be taken the same birds immediately build a second, and if need be a third, is a perfectly well-known fact, and it would be a very unlucky pair of Nightingales to have their nest robbed thrice in a season. At a very moderate computation the number of young Nightingales that must annually attain their full growth in this country doubles that of their parents, since from five to six are commonly reared in each nest; and, with a large allowance for casualties in youth, it is safe to calculate upon four of each brood having reached maturity when the time of emigration arrives. What happens during their absence from this country is of course beyond our ken, but the certainty with which migratory birds return to their home is now well-recognised; and it is not less certain that of this species more return to England in spring than are able to find accommodation in our woods, coppices, and shrubberies, as the conflicts just mentioned testify. Hence it would follow that were the taking of a Nightingale's egg made a capital offence, we should not have, one year with another, more Nightingales, though, to retain the number we have, it is impera-

<sup>1</sup> NATURE, viii., p. 1. (May 1, 1873).

tive that the old birds should have protection at the breeding season.

To take the second case we have cited, that of the Goldfinch, the details are not the same, though the final result be so. Until some fifteen or twenty years ago the diminution in the numbers of this species was notorious; but the reasons of that diminution are easily revealed to any enquirer, though it may be hard to say which of them be the stronger. The practice of netting in spring time, now illegal though probably still used in some places, was carried on to an extent that if it were not supported by the clearest evidence people would hardly believe. Combined with this disastrous practice was the fact that so much heath and common land had been brought under the plough, and the mode of agriculture so much improved, as sensibly to affect the Goldfinch's supply of food, for its fare was truthfully termed by the poet "the thistle's downy seed," combined however with that of other weeds hated by good farmers. But no doubt, at the hands of the bird-catchers, the Goldfinch, being so great a favourite for the cage, still suffers severely, and it may be true that enough do not leave this country at close of summer to satisfy the waste of life that occurs during its migration and in its winter-quarters; though as to any considerable diminution in its numbers being caused by birdnesting, the notion of such a thing will be scouted by all who have had opportunities of observing its breeding-habits. Our third instance, the Skylark, is without doubt one of those birds that needs protection least. Nobody persecutes him so soon as he ceases to flock and settles with his mate in their chosen spot. Their nest in the growing corn, or the wide pasture, is safe from even the predatory rat, and the open country they haunt is no place for the Sparrow-hawk, that deadly foe to so many small birds. There, in the course of the season, they make their three or four nests, and rear in each as many young, so that the annual increase of the species may be safely computed as five-fold, and when we also consider that thousands if not tens of thousands arrive every autumn on our shores and spread over the whole country, with a safe conscience the most devoted lover of birds may, if he has a mind to it, eat lark-pudding in winter without compunction.

We have cited these three cases—the Skylark, the Goldfinch, and the Nightingale, because we have them so frequently put forward by sentimentalists as birds that all right-minded people would wish to see more numerous. We should like to count ourselves among the right-minded, but the sentimentalists must forgive us for refusing to believe that the number can be increased in the way they advocate—visiting with punishment the schoolboys who would take the nests of any one of them. Far otherwise, however, is it with many birds of which the enthusiasts never think. Those, for instance, that habitually breed in places open to all comers, and especially on islands near our coast, on the sea shore, and by the side of inland but navigable waters. In such places there is no law of trespass; and, as all who have been at the pains to inform themselves know, these birds suffer from the way their exposed nests are ravaged, and are surely decreasing in number. Yet by the general public they are little heeded, chiefly because the general public knows nothing about them—not even their names—and moreover encourages the ravages by blindly buying the booty of the ravagers. Thus it is that many a beach, and many a heath, and many a marsh and mere, is made desolate, for the ravage is continued throughout the whole of the breeding-season, with the result that scarcely an egg is left from which a young bird—be it Duck or Gull, Tern or Plover can be hatched. Yet it is obvious that it would not be so very difficult to stop this destruction, and that without interfering with the long-established practice, which we hold to be no more detrimental to their species than it is illegitimate, of taking toll of their

eggs. Pick out the places at which the practice is carried on, and limit the time during which the eggs may there be lawfully gathered, so as to give each pair of birds the opportunity of bringing off their brood.

Early in the present Session a "Bill to amend the Wild Birds' Protection Act, 1880," was brought into the House of Commons by Sir Herbert Maxwell, which Bill, owing to the well-deserved popularity of its introducer, ran its course unchallenged, and achieved the almost unexampled success of being read a third time and passed with scarcely an alteration of importance. The scope of the Bill was to enable any County Council to prohibit "the taking or destroying of any species of wild bird or the eggs of any species of wild bird." This Bill, of course, attracted the attention of the Committee which had been appointed the year before by the British Association "to consider proposals for the Legislative Protection of Wild Birds' Eggs," and in the opinion of that Committee, as subsequently reported at the late meeting of the Association at Nottingham, the Bill was declared to have been framed on a mistaken principle "in that it sought to effect the desired object by empowering local authorities to name the species," the eggs of which were to be protected, thus requiring in every case of prosecution proof of identity, which in the majority of cases would be difficult, if not impossible to supply."

The House of Lords at first took almost precisely the same view as the British Association Committee; and, chiefly at the instance of Lord Walsingham, than whom there could scarcely be a more competent peer, amended the Bill accordingly, producing what would, in the opinion of many experts, be a very workable measure. But unhappily in the subsequent process of passing the Standing Committee of the Upper House, their lordships were induced, by those who were not experts, to go a great deal further, and nobody acquainted with the facts of the questions involved, can doubt that on this occasion the efficacy of the Bill was not a little damaged in various ways. In this condition it in due course returned to the House of Commons, where the British Association Committee, as stated in their report, hoped it would, in spite of its transformation, still find favour; but its original parent, Sir Herbert Maxwell, would have none of it, and consideration of the Lords' Amendments having been adjourned on August 21 for three months, it stands by the accidental prolongation of the Session, for further discussion in a few days. In the meanwhile the British Association Committee has been reconstituted and strengthened by the substitution of several ornithologists of repute in place of some naturalists who had never paid any special attention to the matter, while Sir John Lubbock has accepted the post of chairman, and Mr. Dresser, who was for many years Secretary to the Old "Close-Time" Committee of the Association that effected so much good, undertakes the same duty in the new body, the other members of which are Mr. Cordeaux, Mr. W. H. Hudson, Prof. Newton, Mr. Howard Saunders, Mr. T. H. Thomas, Canon Tristram, and Dr. Vachell. With a chairman at once so conciliatory and so influential, and a secretary of so much experience, it may be hoped that the difficulties, great as they are—for they involve a contest between the two Houses of Parliament—will not prove insuperable, and that some way may be found of saving this Bill, for all will admit that if it be not passed this Session a long while may elapse ere a House of Commons is good-humoured enough to let a measure of the kind slip through its entanglements, as did that of Sir Herbert Maxwell at the beginning of this year. This is surely a case where sentiment should yield to common sense.

1 It may be remarked that the Bill was so carelessly worded as to leave it open to doubt, though this was certainly not the intention of its supporters, whether a County Council could by one act make it apply to all Wild Birds, or only to some that should be named.

LIGHT-WAVES AND THEIR APPLICATION  
TO METROLOGY.

EVERY accurate measurement of a physical quantity depends ultimately upon a measurement of length or of angle: and it will readily be admitted that no effort should be spared to make it possible to attain the utmost limit of precision in these fundamental quantities. At present, lengths are measured by the microscope, and angles by the telescope; and the extraordinary degree of accuracy already attained by the use of these instruments depends entirely on the properties of their optical parts in their relation to light-waves; so that, in fact, light-waves are now the most convenient and universally employed means we possess for making accurate measurements. It can readily be shown that this high degree of accuracy is especially due to the extreme minuteness of these waves.

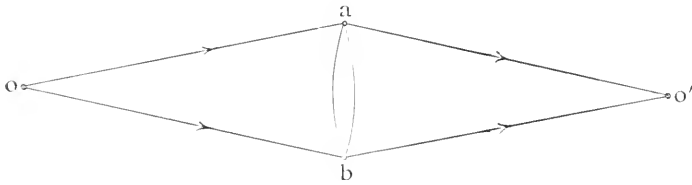

FIG. 1.

Thus it is well known that the image of a luminous point consists of a series of concentric coloured rings surrounding a bright central disc which is smaller the smaller the ratio of the wave-length of the light to the diameter of the objective employed. In fact, it can be shown that the radius of the bright central disc contains as many wave-lengths as the distance of the image from the objective contains the diameter of the objective. Thus in a telescope twenty diameters long, the diameter of the bright disc is forty wave-lengths or 0.02 mm. If the image be magnified by increasing its distance from the objective, or otherwise, these diffraction rings are magnified in the same proportion; so that nothing is gained thereby in *distinctness*, beyond the point where the rings are just large enough to be visible. But, were it not for the inevitable loss of light, it would be advan-

vibration; but to determine the position of  $o$  with respect to  $a b$ , this is not at all necessary; and in fact, if we disregard the possible inconvenience due to the dissimilarity between the phenomenon observed and the object whose position is to be measured, it would be as well to entirely annul the central portions of the lens, leaving only an external annular ring, or better still, only two small portions at opposite ends of a diameter.

This involves no sacrifice of accuracy, but on the contrary a very considerable gain; for it is now possible to increase the size of the interference fringes up to any desired limit without diminishing the intensity of the light, the result being the same as could be obtained with a perfect microscope of unlimited magnifying power with a source of unlimited intensity.

For this purpose the two small portions to which the lens is reduced are replaced by plane mirrors or prisms, whose office is simply to bring the two interfering pencils into coincidence. Further, the pencils, instead of starting from a point or a line, may be separated by a plane transparent surface; and a second similar surface may be used to reunite the pencils after reflection. Thus the telescope or microscope will have been converted into a refractometer. The exact nature of the analogy will be apparent by a comparison of Figs. 1 and 2.

It may be assumed that under the most favourable circumstances the utmost attainable limit of accuracy of a setting of the cross-hair of a microscope on a fine ruled line is about  $\frac{1}{50}$  of a micron. Now, it is usually admitted that the middle point of an interference fringe, if it be sufficiently broad and clear, can be determined within about  $\frac{1}{30}$  of the width of a fringe. In the refractometer this would mean only  $\frac{1}{150}$  of a light-wave, or about 0.01  $\mu$ , from which it would follow that the refractometer is about five times as accurate as the microscope. But a number of trials with the form of refractometer shown in Fig. 3 gave as the mean error of a series of ten observations:

|               |                      |              |
|---------------|----------------------|--------------|
| Fr.           | Fr.                  | Fr.          |
| Morley 0.0036 | ... Nicholson 0.0059 | ... X 0.0110 |

The third observer had no previous practice in this kind of measurement.

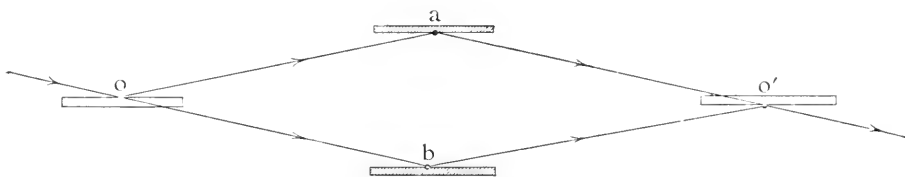

FIG. 2.

tageous for *measurements of position* to increase the magnification much further.

This can be accomplished by an extremely useful instrument which has been misnamed the "interferential refractometer." It will be interesting to note that notwithstanding the apparent difference in form, this apparatus, when used as a measuring instrument, differs in no essential particular from the microscope or the telescope, or (what is perhaps a trifle unexpected) the spectroscope; and it is possible to change any one of these instruments into the other by unimportant modifications.

Thus, let  $o$ , Fig. 1, be a source of light,  $ab$  a lens which forms an image of  $o$  at  $o'$ . The operation of the lens, when used to distinguish minute objects, depends upon the accuracy with which all its parts contribute to make the elementary waves reach the focus in the same phase of

It is evident from these results that  $\frac{1}{30}$  of a fringe is too large an estimate of the average error of a setting, and that it is, in fact, less than 0.01 of a fringe, corresponding to an error in distance of about 0.003  $\mu$ .

For angular measurements the microscope is replaced by the telescope.

Fig. 3 represents a disposition sometimes adopted for observing minute angular displacements of the mirror  $d c$ : the light starts from  $o$ , is reflected by the plane parallel glass plate  $b$  to the objective  $a b$  of a telescope, whence the now parallel rays proceed to the mirror  $c d$ . Thence they retrace their path to the plate  $b$ , through which they are transmitted, forming an image of the source at  $o'$ , which is viewed through the eyepiece.

Fig. 4 is the exact analogue in the form of a refractometer; and Fig. 5, though slightly different in aspect, is still essentially the same instrument. The path of the

rays is  $o p a c a p o'$  for one of the pencils, and  $o p b d b p o'$  for the other.

From considerations quite analogous to those employed in the former case, it can be shown that the

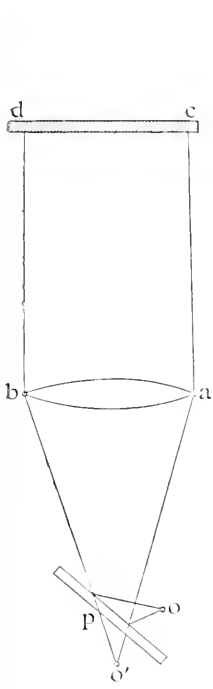

FIG. 3.

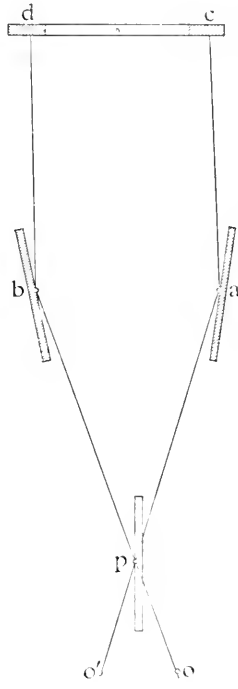

FIG. 4.

limit of accuracy attainable in the estimations of angles involves an error of about one-fifth of the angle subtended by a light wave at a distance equal to the diameter of the objective. This is halved by the fact that the angular motion of the beam is twice that of the mirror; so that

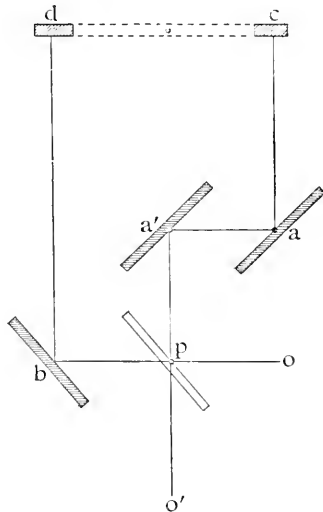

FIG. 5.

with a telescope of 10 cm. aperture the limit of accuracy may be estimated at  $\frac{1}{20000000}$ , or say 0.1". But taking 0.01 fr. as the smallest perceptible displacement of the mirrors  $c d$ , the corresponding angle of rotation of the

line  $c d$  (10 cm. long) would be only  $\frac{1}{20000000}$ , or say 0.01".<sup>1</sup>

It is not at first evident that there is any relation between the refractometer and the spectroscope. A comparison of Fig. 6 and Fig. 7 shows, however, that there is a strict analogy. Fig. 6 represents a disposition sometimes adopted to observe the spectrum by means of a concave grating, and Fig. 7, with unimportant modifications, is the arrangement actually employed in the analysis of radiations by means of their "visibility curves," as will be explained below.

Exactly as in the case of mirrors and lenses, we may here, too, sacrifice "resolution" and "definition" by using only the extreme portions of the surface, with an actual gain in "accuracy." To compare numbers, it appears that the average error in the comparison of

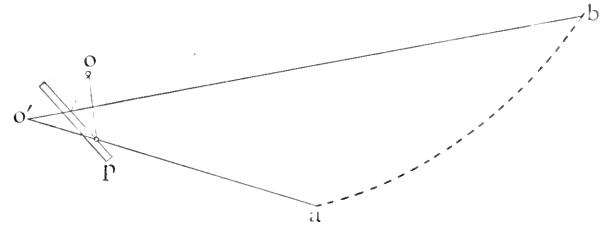

FIG. 6.

wave-lengths by a grating with 250,000 lines is about one part in half-a-million. With this number of waves in the difference of path of two interfering pencils, the corresponding error in the refractometer observations are of the order of one twenty-millionth.

The name "interferential refractometer" seems rather inappropriate to an instrument which has so many important applications beside the measurement of indices of refraction; but as it has been sanctioned by long usage it will be retained.

Among the many forms of the apparatus which have been rendered classic by the works of Arago, Fresnel, Fizeau, Jamin, and Mascart, and which are so admirably adapted to the work for which they were designed, there are none which are not open to serious objections when applied to the solution of such problems as the measure-

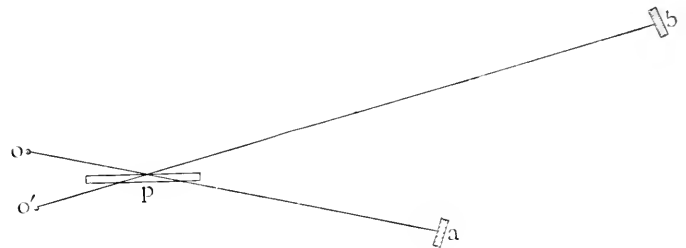

FIG. 7.

ment of lengths and angles, for the analysis of the constitution of the light of spectral lines, and especially for the determination of wave-lengths in absolute measure. For these, the form of instrument shown in Fig. 8 has many important advantages, among which the following may be mentioned:—It is simple in construction, and is easily adjusted; it may be used with a broad luminous

<sup>1</sup> In the use of the revolving mirror as in galvanometers, gravity and torsion balances, &c., the accuracy can be increased by enlarging the surface of the mirror; but the moment of inertia is thereby increased, and in greater proportion. But in the refractometer the mirrors  $c d$  may be made insignificantly small, and yet, with the same distance between the outer edges, the accuracy may be increased at least tenfold. It is important to note that any linear motion of the line joining the mirrors, or even a rotation about this line, has no effect on the fringes. It seems probable that this form of instrument may be of service in such problems as the measurement of the moon's attraction, constant of gravitation, variations of the vertical, &c.

surface as source of light; the pencils may be separated as far as desired: its range of difference of path between the interfering pencils is unlimited; and when properly adjusted the position of the interference fringes is perfectly definite, so that there is no uncertainty on account of parallax, and no difficulty in counting the number of fringes passing a given point. Finally, it may be added, that this is probably the only form of instrument which permits the use of white light (and consequently of the identification of the fringes) in the determination of the position or inclination of a surface without risk of disturbance due to contact or close approximation.

As shown in Fig. 8, the refractometer consists essentially of a plane parallel plate of optical glass  $G_1$  and two plane mirrors  $M_1, M_2$ . The beam of light to be examined falls on the plate  $G_1$  at an angle, usually  $45^\circ$ , part being reflected and part transmitted.<sup>1</sup> The reflected portion is returned by the mirror  $M_2$ , and passes back through the inclined plate. The transmitted portion is returned by the mirror  $M_1$ , and is reflected by the inclined plate, and from

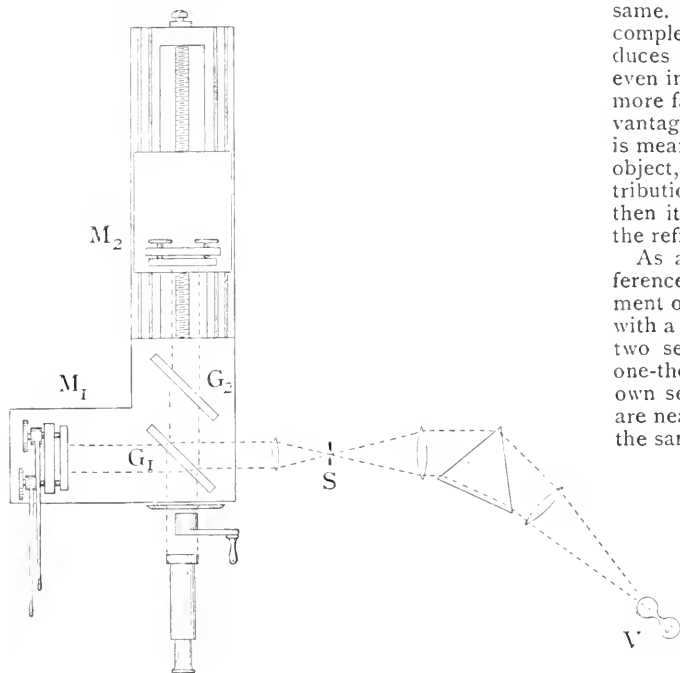

FIG. 8.

this point it coincides with the other beam, so that the two are in condition to produce interference fringes.<sup>2</sup>

A little consideration will show that this arrangement is in all respects equivalent to an air-film or plate between two plane surfaces. If the virtual distance between these surfaces is small, white light may be employed, and interference fringes may be observed similar in all respects to those between two plates of glass pressed nearly into contact.<sup>3</sup>

<sup>1</sup> The front surface of the plate  $G_1$  is lightly coated with silver. The light which leaves the refractometer is a maximum where the thickness of the silver film is such that the intensities of the transmitted and reflected portions are equal. The silvering has another important advantage in diminishing the relative intensity of the light reflected from the other surface; and for this reason the thickness of the film may be advantageously increased, which permits also a more uniform surface. The ultimate ratio of intensities of the two pencils is not affected, for what is lost by transmission on entering the plate is made up by reflection on leaving it.

<sup>2</sup> One of the beams has to pass twice through the thickness of the glass plate  $G_1$ , and in order to equalise the two paths, a similar plate  $G_2$  is introduced in the path of the other beam.

<sup>3</sup> If the plate  $G_1$  be not silvered, the colours follow the same order as those of Newton's rings, but if the silvering be sufficiently heavy, the colours are complementary; this, if the plates  $G_1$  and  $G_2$  are exactly equal and parallel. Otherwise, the excess of path in glass of one of the pencils disturbs the order of colours by the effect of achromatism due to the dispersion of the glass, as was first pointed out by Cornu.

If, however, the distance exceeds a few wave-lengths, monochromatic light must be employed. In this case the fringes are in general invisible, unless they be viewed through a small aperture. If, however, the two surfaces are very accurately parallel, the fringes are always distinct, and it follows from the symmetry of the conditions that they are concentric rings. Their diameters increase as the square root of the order of the ring.

These rings are not formed at the surface of the mirrors (as is the case when the distance between them is small), but are perfectly distinct when the eye or the observing telescope is focussed for parallel rays.

In the preceding comparison between the refractometer and the telescope, microscope, or spectroscope, the "accuracy" has been increased at the expense of "definition." When, however, the object viewed is beyond the "limit of resolution" of the instrument, its form and distribution of light can no longer be inferred from that of the image. Thus, if the object be a disc, a triangle, or a double star, the appearance in the telescope is the same. Similarly in the spectroscope, a source of great complexity cannot be distinguished from one which produces a single spectral line. So that for such objects, even in the ordinary sense of the word "definition," the more familiar optical instruments cannot claim any advantage over the refractometer; but if by "definition" is meant not the actual resemblance of the image to the object, but the accuracy with which the form or the distribution of light in a minute source may be inferred, then it can be shown that all the advantage rests with the refractometer.

As an illustration of such an application of interference methods, let us consider the celebrated experiment of Fizeau, in which Newton's rings are observed with a sodium flame as source. The light, consisting of two separate systems of radiations differing by about one-thousandth in wave-length, each system produces its own series of interference fringes. When the surfaces are nearly in contact, the difference of path is very nearly the same for both systems, and the fringes coincide, and the clearness is a maximum. When, however, the difference of path reaches about 500 waves for one of the systems, it is a half wave more for the other; and the maxima of intensity of the one coincide with the minima of the other; hence at this point the fringes are faintest. But when the difference of path of the first system is about 1000 waves, it is a whole wave more for the second, and the fringes coinciding, there is again a maximum of distinctness. M. Fizeau has counted 52 such periods, corresponding roughly to a difference of path of 50,000 waves.

Suppose, now, that this double line were so close that it could not be resolved by the spectroscope; then from the evidence furnished by the variations in distinctness of the interference fringes as the difference of path increases, the duplicity of the line could be readily detected. But beside this, it can be shown that the relative intensities of the components, their distance apart, and even the distribution of intensities within the component lines can be inferred.

Thus it has been shown (*Philosophical Magazine* for September, 1892) that among some twenty radiations which were examined (though all give simple lines in the spectrum) the great majority are shown to be highly complex. Thus, the red hydrogen line is a double whose components have the intensity ratio 7:10, and whose distance is about a fiftieth of the interval between the sodium lines. Each component of the yellow sodium lines is itself a double whose components are in the ratio 7:10, and whose distance is about one-hundredth of that between the principal components. Thallium gives a double line whose components are in the ratio 1:2, at a distance of about a fiftieth of that of the sodium lines,

while each component has a small companion whose intensity is about a fifth of that of the principal lines, at a distance of about one three-hundredth of that of the sodium lines. The green mercury line is made up of a group of five or six lines, the strongest of which is itself double (or perhaps triple) the distance of the components, being less than a five-hundredth part of that between the sodium lines.

These distances, small as they are, can be measured within about a twentieth part, so that by this means it is possible to detect a change of wave-length corresponding to the ten-thousandth part of that between the two sodium lines.

The red line of cadmium is the simplest of all the radiations thus far examined, consisting of a single narrow line whose intensity falls off symmetrically according to an exponential law, its width (at the points where its intensity is reduced to half its maximum value) being only 0.002 ( $D_1-D_2$ ). The green and the blue cadmium lines are also comparatively simple, and all three of these lines give interference fringes clearly visible at a difference of path of 100 mm., and under appropriate conditions they all satisfy the requisites for a definite and inalterable standard of length.

The most important of these conditions is that the radiating vapour be so rare that the molecules may vibrate freely: in other words, that the time occupied in the collisions between the molecules be so short relatively to

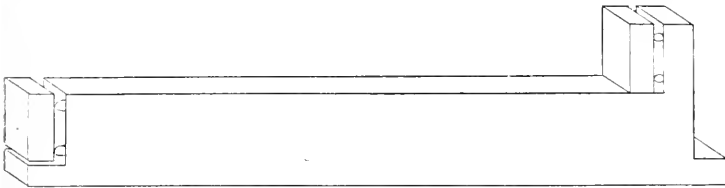

Fig. 9.

that of the free path, that its influence in disturbing the free vibration may be neglected. Experience shows that in general this limit corresponds to a pressure of one or two thousandths of an atmosphere.

It may be noted that at atmospheric pressure—even when the radiating substance is introduced in quantity barely sufficient to colour a Bunsen flame—the greatest difference of path attainable is only one or two centimetres, whereas with mercury vapour in a vacuum tube interference fringes have been observed with a difference of path of 47 centimetres, or about 850,000 waves.

In order to make any practical use of these minute quantities for standards of length, it is necessary to employ an intermediate standard, such as that shown in Fig. 9, consisting of a bronze bar carrying two plane-parallel glasses, silvered in front, the distance between which can be compared on the one hand with the fundamental standard in actual use—the metre or the yard—and on the other with the length of a light-wave.

The former process is accomplished by moving the standard (whose length it is convenient to take at 10 centimetres) ten times through its own length, the coincidence and the parallelism of the surfaces being controlled at every step by the interference fringes in white light formed between these surfaces and that of the reference plane (the virtual image of the mirror MM in  $G_1$ , Fig. 8). The position of a fiducial mark on this standard is compared by means of two micrometer microscopes with the lines defining the standard metre at the first and last steps.

In the second process the only difficulty encountered is due to the very great disproportion between the length of a wave and that of the 10 centimetre standard, and the consequent difficulty in keeping the correct count of

the very large number of waves which pass as the reference plane is moved from one surface to the other.

This problem has been solved in the following manner. Nine standards were constructed similar in all respects to that of ten centimetres, save that each succeeding one was half as long as the preceding. The last of the series is thus approximately 0.39 mm. long, corresponding to a difference of path of 0.78 mm. The number of waves in this distance in red cadmium light is 1212 plus a fraction, which is corrected by direct observation of the difference of phase of the circular fringes on the upper and the lower (front and rear) surfaces of the standard. This verification is also made with the green and the blue radiations.

It is important to note that the measurement of these fractions alone is sufficient to fix the whole number, even if there be an uncertainty of several waves. Thus, the relative wave-length of the three radiations being known, the number of green and of blue waves corresponding to the observed number of red waves can be readily calculated, as is shown in the following table:—

| Wave-length. | Number of Waves. |             |
|--------------|------------------|-------------|
|              | Observed.        | Calculated. |
| 0.64389      | 1212.34          | 1212.34     |
| 0.50863      | 1534.76          | 1534.76     |
| 0.48000      | 1626.16          | 1626.13     |

If the whole number assumed as the basis of this calculation were in error by one or more waves, there would be no correspondence between the observed and the calculated fractions. The length of this standard and the succeeding one are now compared as follows:—The two standards being placed side by side in the refractometer II on a fixed support, and I on a movable carriage, the reference plane (R, Fig. 10) is moved until it coincides with A, the lower (or front) surface of II, and the interference fringes in white light are adjusted to the proper distance and inclination by adjusting the inclination of the reference plane. Next, C, the lower surface of I is brought to coincidence with the reference plane, and similarly adjusted, and then all the adjusting pieces are released from the carriages, so that these rest undisturbed on the ways. This completes the first stage of the comparison.

Second Stage.—The reference plane R' is now moved back till it coincides with D, the upper surface of I and

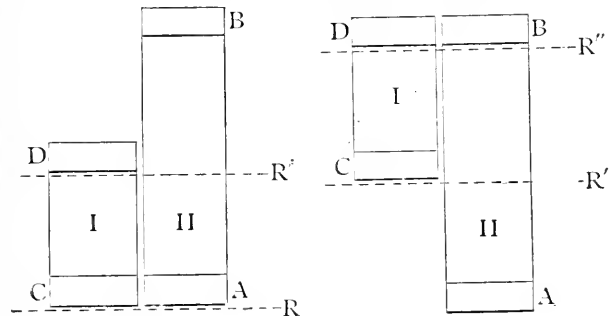

Fig. 10.

Fig. 11.

the adjustment of the interference fringes carried out as before.

Third Stage.—The standard, I, is moved back till its lower surface (C, Fig. 11) once more coincides with the reference plane, R', and its inclination is again adjusted by the interference fringes.

Fourth Stage.—The reference plane is finally moved back till it coincides with D, the upper surface of I, and its inclination is again adjusted. If now the standard II

is just twice as long as  $\lambda$ , the fringes will appear simultaneously on *both* upper surfaces, D and B.

The adjustment of the length of the standards is usually made to within a few waves, and the outstanding difference is measured by a compensating device.

This is furnished by the rotation of the compensating plate,  $G_2$ , Fig. 8. The plate is held in a metal frame which is supported at one end by a short thick rod firmly fixed to the bed. At the other end a delicate spiral spring is attached; the tension of the spring *twists* the rod through a minute angle, and thus alters the thickness of glass traversed by one of the interfering pencils. The other end of the spring is attached to a flexible cord passing over a pulley which is connected with a graduated circle. The angular motion is thus reduced about 100,000 times, and yet the proportionality is preserved.

Suppose the outstanding difference is  $\epsilon$  a fraction of a wave-length known to within one or two tenths, then

$$11 = 21 + \epsilon$$

and consequently the number of red waves should be  $2 \times 1212'34 + \epsilon$ . This fraction is corrected by direct observation, as in the case of standard 1, and the same control is furnished by the concordance of the results for the three colours; so that an error in the whole number of waves is well-nigh impossible.

The process of comparison and correction is repeated in the same way with the other standards, until we finally arrive at the whole number of waves and approximate fraction in the 10 centimetre standard. Up to this point the question of temperature and pressure is of minor importance, for the comparisons and corrections are made while both standards are under the same conditions; and being all made of the same material, it is sufficient to know that the temperature is the same for both. In the measurement of the fractions on the 10 centimetre standard, however, it is necessary to know the temperature and pressure with all possible accuracy, and it is also important that the comparison of this standard with the metre should be made, as nearly as may be, under the same conditions as that of the determination of the standard in light-waves.

The author having been honoured by an invitation from the International Bureau of Weights and Measures to undertake a series of experiments upon the lines here briefly indicated, the necessary apparatus was constructed in America, and shortly afterward installed in the Bureau International des Poids et Mesures at Sèvres.

Two complete and entirely independent determinations were made. These have not yet been completely reduced, but an approximate calculation gives for the number of waves of red light in one metre of air at 15° C. and 76 mm.

|                   |           |
|-------------------|-----------|
| 1st series ... .. | 1553163·6 |
| 2nd series ... .. | 1553164·6 |

The difference from the mean is half a wave, or about one fourth of a micron.<sup>1</sup>

From these results it follows that we have at hand a means of comparing the fundamental standard of length with a natural unit—the length of a light-wave—with about the same order of accuracy as is at present possible in the comparison of two metre bars.

This unit depends only on the properties of the vibrating atoms of the radiating substance, and of the luminiferous ether, and is probably one of the least changeable quantities in the material universe.

If, therefore, the metre and all its copies were lost or destroyed, they could be replaced by new ones, which would not differ from the originals more than do these among themselves. While such a simultaneous destruction is practically impossible, it is by no means sure that,

<sup>1</sup> The error in the determination of the *relative* wave-lengths of the three radiations is very much smaller, probably less than one twenty-millionth.

notwithstanding all the elaborate precautions which have been taken to insure permanency, there may not be slow molecular changes going on in all the standards; changes which it would be impossible to detect except by some such method as that which is here presented

A. A. MICHELSON.

#### FURTHER NOTES AND OBSERVATIONS UPON THE INSTINCTS OF SOME COMMON ENGLISH SPIDERS.

MANY of what would otherwise be most interesting anecdotes respecting the habits of spiders have been related by persons who, being unacquainted with the immense number of "kinds" of this group that there are in England, not to mention the rest of the world, have apparently considered that all needful information in the way of the animal's identity has been supplied by the simple statement that it is a spider.

Such anecdotes have of course a certain value, inasmuch as they furnish some general information respecting the instincts of the class as a whole. But to those who are anxious to compare together the instincts of individuals of the same or different species, genera, and families, who are anxious to acquire in short some little knowledge of the comparative psychology of the group, they are distressingly incomplete.

To remedy in part these deficiencies, to verify the experiments of others, and to make fresh observations upon some points that are open to dispute, I took the opportunity, during a recent visit to North Cornwall, of compiling a set of notes upon the habits of some of the commonest spiders in the neighbourhood.

In the following paper, which is based upon these notes, I have added some brief accounts of the webs, habitats, or general appearance of the spiders, so that those persons who are not acquainted with the animal by name, may yet, with but little trouble, ascertain what the species are that are under discussion.

*Agalena labyrinthica*.—This spider may be looked upon as the country cousin of the common house spider, *Tegenaria atrica*, which being essentially a lover of bricks and mortar, is found in lofts, disused rooms, &c., where it spins in corners and other angles a horizontal, triangular sheet of web, a familiar structure which must be associated in all minds with the word cobweb.

The snares of *Agalena* are essentially like those of *Tegenaria*, consisting of a short silken tube or funnel, one end of which is buried in the bush that the spider has chosen to build in, while the other opens upon, and is continuous with, a widely extended horizontal sheet composed of fine closely woven silken threads. During the daytime the spider, if cautiously approached, may usually be seen squatting at the entrance of her funnel. She is, however, remarkably wary, and this, coupled with her equally remarkable agility, makes the task of capturing her by no means an easy one. For, by means of the further open extremity of the tube, she can make her escape into the bush beyond. Wherever I have had an opportunity of observing this spider, I have noticed that it appears to have a special liking for furze bushes; and it seems reasonable to suppose that this selection of so prickly a site for the building saves the young and also the nest from destruction at the hands, or rather the noses and legs, of cattle.

Upon examining the *débris* of prey, with which the orifice of the funnel was usually strewn, I was surprised to find that it consisted more often of the remains of bees than of flies—generally, indeed, the limbs, wings, &c., were those of some species of Bumble-bees (*Bombus*). Being curious to see how the spider would manœuvre to overcome so redoubtable an adversary, I captured upon one occasion a small specimen of a bumble-bee and



placed it upon the snare. The *Agalena* immediately darted forth; but upon touching the insect with her fore-legs, quickly drew back as if to keep out of harm's way. Meanwhile, the bee, by making vigorous efforts to escape, had nearly succeeded in breaking away the web with which its legs were entangled—a fact of which the spider seemed well aware. For, rushing at it once more, she rapidly, and, by some dexterous movement that I could not follow, attached a thread either to the insect or to a portion of the web hard by, and then started to run rapidly round and round her prey, letting out the thread as she went, and literally winding the insect up. Having by this safe and satisfactory process speedily put a stop to all immediate likelihood of escape, and having also achieved the desired end of hampering the bee's movements, she again rushed two or three times at it, although still evidently bearing in mind the desirability of not coming to close quarters, and ultimately succeeded in inflicting a bite on one of its legs. From that moment all anxiety on her part respecting the probability of the escape of her prey seemed to disappear, for instead of keeping madly on the move, as she had done up to the time of dealing the wound, she quietly retreated to her funnel and sat down to wait. Nor was an explanation of this behaviour long in presenting itself. For the bee's struggles became more and more feeble, and in about one minute ceased altogether. There was very little doubt in my mind that this was attributable to poisoning: but to make sure that its quiescence was not due to exhaustion from its efforts, I took it from the web for examination, and found that it was to all intents and purposes dead, the only perceptible movement that it made being a slight twitching of the extremities of the antennæ. Whilst I was examining it I noticed the *Agalena* issue from her funnel and return to the spot where she had left her victim.

Subsequently to discover to what extent the spider's behaviour on this occasion was to be explained by her knowledge of the formidable nature of the bee, I placed a blue-bottle fly in the web of another specimen. The spider immediately rushed out, touched the insect with her fore-feet, and falling upon it without further delay, dragged it to the entrance of her tube, and proceeded to devour it.

As a further experiment I introduced an example of the drone-fly (*Eristalis*) into the web of a third example of this species; but, curiously enough, instead of instantly slaughtering the harmless insect, as the second one had the blue-bottle fly, this spider treated it with the same caution that the first had shown towards the bee. She did not, however, wind it up, but, keeping at a respectful distance, and watching for an opportunity, she ultimately bit it in the foot and killed it by this means in a few moments.

From these observations I think three conclusions may be legitimately drawn:—(1) That the first spider avoided contact with the bee for fear of being stung; (2) that the other mistook the *Eristalis* for a bee, as ninety-nine uninitiated human beings out of a hundred would also do; and (3) that the spider's bite rapidly compassed the death of the insects owing to the injection of poison. I wish to draw special attention to this last conclusion, not but that the others are more interesting, because Dr. McCook, when recently investigating the question of spider-venom, was inclined to reject the conclusion that the mandibular fluid of these Arthropods possesses any poisonous property.

His suggestion that the death of an insect results from mutilation caused by the bite clearly will not apply in the present instances where only a leg was bitten. For myself, I do not doubt that the fluid in question is poisonous, although probably in a varying degree to the insects upon which the spiders prey, and that the use of the poison is—as it also is, I think, in the case of scorpions—to put a speedy end to struggles, so as firstly to remove

all chance of escape on the part of the prey, and secondly to lessen the probability of injury being done to the Arachnoid by a captive which might also be armed with jaws or stings.

When watching a couple of *Agalenas* pairing I was much struck by the extreme pertinacity with which the operation was carried on. As above stated, specimens of this species are usually exceedingly shy and very difficult to approach, but at this period both male and female seemed utterly oblivious to all their surroundings. They even permitted me to tear away portions of the web, and even to touch them without flinching. A cloud of tobacco smoke made them separate for a short time, but no sooner had it dispersed than they resumed operations as before. I repeatedly pulled the male from the female with my forceps; whereupon she would in alarm retreat to the further extremity of her tube, but he, seemingly, very little disconcerted by the compulsory interruption, would, when placed again in the web, quickly follow her, and presently both would appear again at the entrance of the tube, she lying perfectly passive and he hoisting her along with the patellæ of a pair of her legs grasped in his mandibles. Nor was she apparently much less eager than he, for on two occasions, when he was a little longer than usual in following her, she came forth herself apparently in search of him. It was noticeable that they invariably took up the same position in the same spot at the entrance of the tube, the female lying on her right side with her head towards the posterior extremity of the tube, the male standing over her facing the opposite way. A sketch made of them in this position agrees almost exactly with a figure that Dr. McCook has given of the attitude assumed under similar circumstances of the North American species, *Agalena navia*. When I left this interesting couple the female had retired to the back of the tube, while the male sat on guard at the entrance. I say on guard, because when touched with my forceps he, instead of running away, raised high his forelegs, striking the instrument with them, and snapping at it with his mandibles. The way in which all the instincts for the preservation of the individual were overridden in this instance by the instinct for the preservation of the race brought very vividly before me the force of Prof. Lloyd Morgan's happy paraphrase of Shakespeare—"To breed or not to breed, that is the question."

*Amaurobius similis*.—This spider is very common in Cornwall, as elsewhere. It belongs to the same great group of tube-weavers as *Agalena*, spinning a tubular web in ivy, holes in walls, &c., and surrounding the aperture with a tissue of irregularly interlacing somewhat loosely woven threads which present a white thickened appearance, owing to the presence of flocculent tufts of silk that are produced by the agency of those interesting spinning organs, the *cribellum* and *calamistrum*. Like *Agalena* and *Tegenaria*, *Amaurobius* runs with agility on the upper surface of its web. *A. similis* is much smaller than *Agalena labyrinthica*, but does not appear to be so timid. I could never be sure of attracting *Agalena* to a vibrating tuning-fork, but *Amaurobius* would always come and even climb along the instrument. I have enticed this species from its hole by holding the vibrating-fork near the aperture, although not in contact with any part of the web. And all the specimens that were noticed on the external sheet of the web responded invariably when the vibrating-fork was held above them at a distance of about half an inch. But instead of running away from the instrument, or reaching up at it as the *Epeiridae* do, *Amaurobius* moved excitedly about, apparently searching for the cause of the vibration. One specimen while thus searching came across and instantly seized the old dried-up carcass of a blue-bottle fly, as if perfectly satisfied with the result of its investigation. Another example, discovered away from her web, made no response whatever when the fork was held close to

her back. This circumstance, coupled with the fact that no specimen of this spider ever gave the smallest sign of knowing the direction whence the sound proceeded unless its web was actually touched with the tuning-fork, is in favour of Dr. McCook's view, that the *Epeiridæ*, which respond readily to a tuning-fork that is held near them, are only aware of the proximity of the vibrating instrument through the responsive vibration of the web. This may be the true explanation with regard to *Amaurobius*, but there are several reasons, as will shortly be seen, which lead me to think it is not so where the *Epeiridæ* are concerned.

*Pholcus phalangoides*, belonging to a group by itself, is a common spider in many parts of the south of England. It frequents kitchens and outhouses, where it spins a very untidy-looking web, composed of irregularly interlacing loosely-woven threads. The species cannot be readily mistaken for any other true British spider, on account of the extreme length and thinness of its legs. Owing to this peculiarity, it is probably largely responsible for the popular but erroneous idea that the Opiliones—the harvest-men or long-legged spiders *par excellence*—can spin webs. Whenever any part of the web of a *Pholcus* was touched with a vibrating tuning-fork, the occupant would come clumsily and leisurely up to the instrument, and when it was held close to the back of the spider, the latter would show its perception of the vibration by slowly lifting its legs. One specimen away from its web responded in exactly the same manner as the others did when hanging in the midst of their snares, thus showing that it is not the vibration of the web that informs this species of the proximity of the instrument.

*Epeira diademata*, *Meta segmentata*, and *Zilla x-notata*, are three very common spiders belonging to the group of Orb-weavers. The first-named—the common garden or cross-spider of England, one of the largest of our species—is known to every one. *Meta segmentata*, too, is very abundant, spinning its web in hedges and bushes; it may be easily recognised from *E. diademata* by its much smaller size and more graceful build. *Zilla* is more like *Meta* than *Epeira*, being a smallish, rather graceful species, which spins its web very commonly in the angles of windows, &c. The structure of its web also affords another clue to its identity: for while in *Epeira* and *Meta* the snare is a complete orb, the concentric lines extending across all the radii from the centre to the circumference, in *Zilla*, as a very general rule, two of the inter-radial spaces in the upper half of the web are not crossed by the concentrics: the circle of the web thus lacks one sector, and the resulting triangular space is traversed by a free radius, which is continued beyond the circumference of the snare, and connects its centre with a second small irregular web, which is spun in a crevice or beneath some leaf.

Like most other spiders these three species will usually come to a vibrating tuning-fork, if the web be touched with it. And if it be held over the centre of the web where the spider is hanging, the three will readily respond to the sound; but not in the same way. As Mr. and Mrs. Peckham and Prof. Boys<sup>1</sup> have shown, an adult *Epeira diademata* raises its forelegs and snatches at the instrument, while *Meta*<sup>2</sup> *segmentata* instantly drops by a thread from her snare; but *Zilla*, so far as my experience goes, instead of dropping like *Meta*, nearly always climbs quickly along the free radius back to the upper web. One example, however, repeatedly dropped from its web, and two others, one adult and one young, moved excitedly about as if in search of the cause of the sound, exactly as described in the case of *Amaurobius*. Curiously enough the sound affects the examples of *diademata* differently according to their age. Thus quite small examples

drop by a thread, but half-grown examples either drop as the young do, or strike at the fork like the adults. It appears therefore from these facts, that as a general rule the small English *Epeiridæ* fear the sound of a vibrating tuning-fork, while the large ones do not. What is the explanation of this? Prof. Boys, who has previously noticed this same fact in connection with *E. diademata* and *Meta*, thinks that it is perhaps to be explained on the grounds that the vibrating tuning-fork is mistaken for an approaching wasp—an insect which, to use Dr. McCook's words, "is the most persistent enemy of spiders." But a full-grown *E. diademata* is too formidable an opponent for a wasp to attack, and it seems well aware that anything buzzing can be overcome and eaten, or at least repulsed. Not so, however, is it with a *Meta*. A wasp can take one of these small spiders out of its snare while still on the wing, and the spider's life depends upon the quickness with which it can perceive the approach of its enemy and act upon the perception by dropping out of harm's way.

This ingenious suggestion is further borne out by the behaviour of *Zilla* and of the young *diadematas*, for these spiders would have no more chance against a wasp than *Meta* has. Moreover, my friend Mr. Henderson, of Madras, has informed me that he has repeatedly seen examples of a common Indian house spider<sup>3</sup> drop from their webs at the approach of the mason-wasps.

Such a habit, then, of falling or running away would clearly give a spider that possessed it an advantage in life over others of the species in which it was not developed, and the elimination of the latter and the survival of the former, with the consequent chance of breeding, would foster the habit and bring it to the state of perfection in which we now see it.

On the other hand, the loss of the habit in the adult *E. diademata*, may perhaps be explained on the hypothesis that the act of dropping entails the expenditure of energy in the form of waste of silk and of muscular tissue; moreover, it might at the same time on occasions lead to the escape of an insect that would have served for prey if the spider had remained *statu quo*. The two instincts are seen in a state of transition in half-grown *diadematas*. But the acquired one of fearlessly fighting the enemy would be prevented from appearing too early in life by the destruction of those individuals which, with over-confidence on their growing powers, stayed in the web when they ought to have dropped from it; or, in other words, the runaway instinct would be preserved as long as the spider was too small to cope with a wasp.

Another interesting question connected with this behaviour of the *Epeiridæ* is the means whereby the vibration of the fork is perceived. The obvious answer is that the sound is heard. But Dr. McCook has recently objected to this explanation on the grounds that the Lycosidæ, which spin no web, and which, in Dr. McCook's opinion, have more need of an auditory sense than the *Epeiridæ*, make no response when the vibration is brought near them.

It has been objected (*Ann. Mag. Nat. Hist.* Ser. 6, viii. p. 103), however, to this opinion of McCook's that the *Epeiridæ* which spin their webs in places where flies are likely to be caught, must of necessity at the same time expose themselves to the attacks of wasps. We can therefore imagine that it is of the highest importance to them to be able to perceive the approach of their enemy—of more importance to them, in fact, than to those spiders, which like the Lycosidæ spin no exposed and conspicuous snare, and are therefore more likely to escape the notice of the wasps.

To account for the behaviour of the *Epeiridæ* when a vibrating fork is brought near them, Dr. McCook has suggested that the vibration of the instrument causes

<sup>1</sup> Mr. Henderson kindly procured examples of this spider for me, and they proved to belong to the genus *Pholcus*.

<sup>1</sup> NATURE, vol. xliii. pp. 40-41.

<sup>2</sup> This is probably the small unidentified orbicular spider that Prof. Boys speaks of.

the threads of the web to vibrate in turn, and that the spider is informed of the nearness of the instrument by the delicate sense of touch in the feet. But so far as my experience goes this hypothesis is not sufficient to account for the facts; for it is difficult to understand how the sense of touch in the feet can merely by being in contact with the threads, which by hypothesis are in a state of vibration, inform the spiders of the position of the fork and of the direction whence the sound proceeds. For of this, to judge by their actions, they appear to have a full knowledge. For instance, one adult example of *E. diademata* that I observed, responded in the manner above described when the fork was held over her back; but when the instrument was brought towards her ventral surface on the other side of the web she drew her body away from it, standing as it were on the tips of her toes. Again, when the fork was brought from below to within a distance of an inch and a half or two inches of a *Mela* suspended by a thread from her web, she instantly dropped again. In this case it is hard to believe that from such a position the fork could throw the web into a state of vibration. On the other hand, no example of the Epeiridæ could ever be attracted along one of the radii of the web, however close the fork was held to it, unless the two were actually in contact. In view of these facts, it seems to me probable that Mr. and Mrs. Peckham's explanation of the behaviour of the Epeiridæ—namely, that they hear the vibration—is the true one.

R. I. POCKOCK.

#### NOTES.

THE Royal Society's medals have this year been adjudicated by the President and Council as follows:—The Copley Medal to Sir George Gabriel Stokes, Bart., F.R.S., for his researches and discoveries in physical science; a Royal Medal to Prof. Arthur Schuster, F.R.S., for his spectroscopic researches, and his researches on disruptive discharge through gases and on terrestrial magnetism; a Royal Medal to Prof. Harry Marshall Ward, F.R.S., for his researches into the life history of fungi and schizomycetes; and the Davy Medal to Messrs. J. H. van't Hoff and J. A. Le Bel, in recognition of their introduction of the theory of asymmetric carbon, and its use in explaining the constitution of optically active carbon compounds. Her Majesty the Queen has been graciously pleased to approve of the award of the Royal Medals. The medals will, as usual, be presented at the anniversary meeting on St. Andrew's Day (November 30). M. Le Bel has promised to attend in person, and it is hoped that all the medallists will be present. The Society will dine together at the Whitehall Rooms on the evening of the same day.

By the death of Sir Andrew Clark, on the 6th inst., the medical profession has lost one of its most prominent members. The Royal College of Physicians has to mourn the decease of its President, and, outside the faculty, a large and distinguished section of the community is affected by it. Sir Andrew was born on October 28, 1826, at Aberdeen, and pursued his medical career there and at Edinburgh. Subsequently he entered the Royal Navy as a surgeon, and, after making a few voyages, became pathologist to the Royal Naval Hospital at Haslar. There he met Prof. Huxley, who was then professor of biology at the hospital school. In 1853 he accepted the curatorship to the museum of the London Hospital, and was afterwards appointed pathologist to the hospital, then lecturer on physiology, and in 1866 full physician. After this Sir Andrew rapidly came to the front, and from the first his connection was composed largely of men distinguished in science, art, and literature. In 1883 Her Majesty recognised his position in the profession, and his services to medical science, by conferring upon him the honour and title of a baronetcy. Five years

later he was elected to succeed Sir William Jenner as President of the Royal College of Physicians, an honour that he valued even more highly than Royal favours. He was a Fellow of the Royal Society, an LL.D. of Aberdeen, Cambridge, and Edinburgh, and honorary M.D. of Dublin. The respect in which he was held is shown by the influential and representative character of the assembly at a commemorative service in Westminster Abbey on Saturday. The pall-bearers included the Prime Minister, Sir Henry Acland (Regius Professor of Medicine at Oxford), Sir James Paget (Vice-Chancellor of London University), Mr. John Whitaker Hulke (President of the Royal College of Surgeons), Sir Richard Quain (President of the General Medical Council, representing by request of the Provost the University of Dublin), and Sir Edward Sieveking. Following these, with the officers of the Royal College of Physicians, came representatives of the Universities, State departments, and various institutions. Prof. Clifford Allbutt attended for Cambridge, Sir Joseph Fayrer for Edinburgh, Dr. Farquharson, M.P., for Aberdeen, Mr. J. N. Dick for the Navy Medical Department, Sir William Mackinnon for the Army Medical Department, Dr. Thorne Thorne for the Medical Department of the Local Government Board, Sir William Flower for the British Museum, and Prof. Michael Foster for the Royal Society. Among the large congregation were Prof. Huxley, Sir Spencer Wells, and Sir Walter Phillimore. Honoured in life, Sir Andrew Clark's memory will be cherished by all acquainted with his wonderful energy, devotion to duty, and self-sacrifice—attributes worthy of emulation by all followers of his noble profession.

THE death of Dr. H. A. Hagen, a well-known entomologist is announced from New York. He was born in Königsberg in 1817, and became an assistant to Agassiz in 1867. Three years later he was appointed Professor of Entomology at Harvard College. It can truly be said that his works furnish a monument to his memory, for he made more than four hundred contributions to scientific literature.

WE have to record that Mr. A. Reckenzaun died on November 11, at the age of forty-three. His name is familiar in connection with papers on accumulators, electric traction, and electric locomotives, for certain of which he was awarded medals by the Society of Arts and the Institution of Electrical Engineers.

WE regret to learn from Sydney of the death of Dr. George Bennett, a distinguished naturalist, and the author of "Wanderings in New South Wales" and other works. He was ninety years of age.

THE death is announced of Mr. J. G. Barford, the author of a number of papers on physiological chemistry.

IN January next, the Botanical Society of Italy will take over the *Nuovo Giornale Botanico Italiano*, at present edited by Prof. T. Carnel, and publish it as the official organ of the Society. No modifications will be made, however, in the character of the journal, which will continue to be issued in quarterly numbers.

A meeting of representatives of technical schools was held at Manchester on the 4th inst., and it was resolved "that it is desirable that an Association of Technical Institutions be formed." With a view to formally constituting the proposed Association, a meeting will be held at the Society of Arts, on Friday, January 26, 1894.

THE new institute of science, art, and literature, established by the corporation of Carlisle at a cost of about £20,000, was opened by the mayor of that city on November 8. The institute includes a museum, a school of science and art, and a free library. In addition to a valuable collection of antiquities, the

museum contains a good collection of stuffed birds, the late Prof. Harkness's collection of fossils, and a number of specimens of rocks of the English Lake district.

It is reported that a seam of good coal has been discovered at Port Jackson, at a depth of 3000 feet below the surface.

At the second meeting of a conference of the General Light-house Authorities of the United Kingdom and their engineers, together with representatives of the Admiralty and Board of Trade, held at the Trinity House on November 10, it was decided to publish in the official list of lights the candle-power of each light as determined by the engineers. By this means mariners will be informed of the relative illuminating powers of all the principal lights on the coast.

A CORPORATION has been formed at Chicago for the purpose of creating and sustaining a museum (says the *American Naturalist*). Prof. F. W. Putnam has been appointed managing director of the scheme. It is expected that he will organise the museum into departments, and will place over each a competent head, who will make it a medium of original research as well as of exhibition.

At the annual meeting of the New York Mathematical Society, to be held on December 28, Prof. Simon Newcomb will deliver an address on "Modern Mathematical Thoughts."

The fifth of the Gilchrist Lectures, in connection with the Bethnal Green Free Library, will be given on Thursday, 23rd, in the Great Assembly Hall, Mile End Road, by Dr. R. D. Roberts, his subject being "The Evolution of the British Isles."

The Christmas course of lectures for juveniles will this year be delivered at the Royal Institution by Prof. Dewar. The subject will be "Air, Gaseous and Liquid," and the first lecture will be delivered on Thursday, December 28.

The following science lectures will be delivered at the London Institution during the ensuing session: "Birds—Ancient and Modern," by Dr. B. Bowdler Sharpe; "When and Why an Electric Spark Oscillates," by Prof. C. V. Boys; "Crabs," by Prof. W. F. R. Weldon; "The Pond and its People," by the Rev. Dr. Dallinger. Mr. Shelford Bidwell will discourse on "Some Optical Phenomena"; Mr. J. J. H. Teall, on "The Life History of a Mountain Range"; Dr. Klein, on "Cholera," and Prof. Vivian Lewes, on "The Chemistry of Cleaning." The Christmas course for juveniles will be given by Mr. H. J. Mackinder.

In an interesting report, presented to the Department of Agriculture of New South Wales, Mr. A. Sidney Oliff, the Government Entomologist, deals with the injuries inflicted on the sugar-cane crops in the Clarence River district by the ravages of insects. He finds the larger part of the injury to be due to the attacks of the larva of a moth, the sugar-cane moth borer, *Nonagria exitiosa*, but that its increase is kept in check by two minute hymenopterous parasites, both hitherto undescribed; one, *Apanteles Nonagriæ*, belonging to the Ichneumonidae, the other, *Euplectus Howardi*, to the Chalcididae.

Two recent publications of the Board of Agriculture deal with experiments in checking potato disease in the United Kingdom and abroad. The history and cause of the potato disease are first explained, and a great variety of experiments are described in detail. They form a useful manual for agriculturists in their fight against the *Peronospora*.

MR. J. H. HART, the Superintendent of the Royal Botanic Gardens, Trinidad, has recently been successful in transporting to Nicaragua a selection of the best varieties of Trinidad "cacao." Cacao seed soon loses its vitality, and can only be safely transported long distances by placing it in a suitable

position to germinate and grow on the voyage. On April 25 of this year, Mr. Hart left Trinidad with a number of specially-prepared cases containing plants, and seeds planted on the day of departure. The boxes in which the seeds were sown had not glass roofs, but were strongly latticed and covered with a movable sail-cloth cover which could be easily and rapidly fastened or unfastened, to give light, or to protect from wind, rain, and sun. A frame covered with wire-netting was fastened inside each case, so as to press upon the surface of the soil to prevent it shifting and causing the seeds to be disturbed. The seeds germinated ten days after planting, and on June 10, Mr. Hart reached his destination with more than 26,000 healthy plants, which were successfully put out in nurseries. A number of cacao seeds were sown at Nicaragua to develop during the return voyage, and, upon arriving at Trinidad, good healthy plants were obtained from ninety-eight per cent. of the seeds planted. These plants included two species entirely new to Trinidad, and their introduction may eventually prove of great benefit to the colony.

DR. KARL A. VON ZITTEL, Professor of Palæontology in the University of Munich, has at length completed the final volume of his comprehensive "Handbook of Palæontology." The first three volumes are already familiar to all students of palæontology, the fourth volume is devoted to the group of Mammalia. In the *Geological Magazine* for the months of September, October, and November, Dr. G. J. Hinde gives a translation of the concluding chapter, entitled, "On the Geological Development of the Mammalia." The palæontological record from Triassic to recent time is there summarised for the various continents, and Prof. von Zittel advances many additional data in support of Huxley's opinion that the four zoogeographical kingdoms of A. R. Wallace, the Palæarctic, Nearctic, Ethiopic, and Indian, form in point of fact but one great area of development—the Arctogean. This is the youngest of three areas of mammalian development; the oldest is the "Australian," which was separated from other continents as early as Mesozoic time, while the "South American" area dates as far back as early Tertiary.

A PAPER, by Mr. C. T. Simpson, on some fossil Unios and other fresh-water shells from the drift at Toronto, Canada, is contained in the Proceedings of the U.S. National Museum, vol. xvi. Mr. Simpson finds that the Unio fauna of the Mississippi Valley is remarkably distinct, being nearly related only to a part of that of North-Eastern Asia. It can be traced back to the Laramic group of the Cretaceous in an almost unbroken line of species. Glacialists will be interested in the following conclusion:—"The theory founded by Agassiz and elaborated by Dawson, Upham, Gilbert, Tyrrell, and others, that during the glacial period the archæan region of Canada was elevated from 1,000 to 2,000 feet above its present level, and that it was covered with an ice mantle from 3,000 to 6,000 feet thick, a mantle which in the eastern part of the United States extended down to latitude 38° or 40°; that in the Champlain period which followed there was a subsidence over this area, during which great lakes were formed by the melting ice, whose northern shores were the yet remaining wall of ice, and whose southern borders were the land that sloped northward; and that they drained into the Mississippi system, is most strongly confirmed by the evidence of these fossil Unios, and by every fact of the distribution of the Naiades in this general region to-day. It is believed that the entire system of the present Great Lakes was united, and that at one time it covered a considerable part of Lower Michigan, and extended well into Ohio, Indiana, and Illinois."

The great importance attaching to an accurate knowledge of the precise instant at which an earthquake shock is felt at a

given station, has led Dr. A. Cancani, of the Rocca di Papa Geodynamic Observatory, to construct a seismograph which registers the time of the occurrence by an instantaneous photograph of a chronometer. From its description in the November number of *L'Electricista*, it appears that the face of the chronometer is photographed by the light of an incandescent lamp, lighted for about a quarter of a second by a current established automatically by the shock. A lever of the first order carries on one arm nine small vessels containing potassium bichromate solution, whilst the other arm rests on the armature of an electro-magnet. The latter is connected to all the seismoscopes of the observatory, any one of which may establish the circuit and cause the armature to be attracted down. This raises the bichromate vessels and immerses the zinc-carbon couples fixed above them, thus supplying the lamp with a current. The closing of the circuit releases the lever, and the apparatus is automatically rearranged for the next shock.

An improved form of rotary air-pump has been constructed by Herr F. Schulze-Berge, and is described and illustrated in *Wiedemann's Annalen*. That chief difficulty in rotary air-pumps, the air-tight junction between the rotating and the stationary parts, has been overcome in a manner which is simple, ingenious, and very efficient. The tube from the vessel to be exhausted is led through the bottom of an inclined cylindrical vessel filled with mercury. A somewhat larger tube, forming the shaft of the rotating pump, reaches nearly to the bottom of the vessel, and surrounds the end of the first tube in such a manner that there is free communication between the two tubes, whilst all communication with the outer air is intercepted by the mercury. This mercury stuffing, while causing no friction, is found to be effective even at the highest vacua. The rotating tube is surrounded by another, which embraces the cylindrical vessel, and revolves on it with an air-tight junction formed by an ordinary stuffing-box or another mercury junction. The interior of this outer tube is exhausted by an auxiliary pump, so as to keep the difference of level in the mercury vessel small. The shaft carries a circular tube rotating in an inclined plane, about one-third of the tube being filled with mercury. This mercury forms a kind of piston for drawing the air out of the inner shaft, and driving it into the outer one and into the auxiliary pump. The tubular ring is interrupted in one place by a mercury valve, consisting of a U-tube or two concentric tubes parallel to the shaft, one of which communicates with the inner shaft and the recipient, the other leading into the space between the two shafts. In an improved form of the apparatus two concentric tubular rings are used, so that the space to be exhausted is separated by the mercury valve from another exhausted to nearly the same extent. The vacua obtained with this pump are beyond the limits of accurate measurement by McLeod's apparatus, and they are obtained much more rapidly than by other mercury pumps. A pump with rings of 60 cm. diameter and a capacity of 0.9 litre could be driven mechanically at a speed of 15 revolutions per minute. The inventor is constructing a pump of 8.5 litre capacity for industrial purposes.

The *Electrician* contains a description of a method for comparing the capacities of two condensers when they are of so small capacity that it is impossible to obtain, by the ordinary direct deflection method, readings sufficiently large to be accurately measured. The apparatus used consists of an electrically driven tuning-fork, performing about 280 double vibrations per second, one limb of which is provided with a platinised style vibrating between two light platinised springs, whose movements are damped so that their individual vibrations may not conflict with those of the fork. These springs are adjusted relatively to the style on the fork, so that contact shall be made with them alternately, but that when the fork is at rest it shall not be in contact with

either. One spring is connected to one pole of a battery, the other to one terminal of a galvanometer, and the fork to one terminal of the condenser, the other terminals of the battery, galvanometer and condenser being connected together. When the fork vibrates, it first charges the condenser, and then discharges it through the galvanometer. The succession of impulses being so rapid (280 per second), the effect upon the galvanometer is nearly that of a continuous current, and the deflection is steady. It is possible with this arrangement to measure the capacity of a person who is insulated from the floor, and to note the increase of capacity due to the approach of other (uninsulated) persons to him.

*L'Electricista* for November contains a paper, by Signor G. Brucchiotti, on the effect of the absorption of hydrogen on the thermo-electric power and electrical resistance of palladium. The author finds that the resistance of a wire of palladium containing hydrogen increases in proportion to the quantity of hydrogen absorbed, and that when it is saturated the resistance is 1.55 times as great as it was before being charged with the hydrogen. If the same wire is repeatedly saturated with, and freed from hydrogen the resistance seems to tend towards a constant value (whether hydrogen is present or not, which is intermediate between the resistance before being charged, and that after being charged for the first time. In the experiments on thermo-electric force the author used a couple consisting of palladium and nickel, and found that the thermo-electric force of this couple increased with the amount of hydrogen absorbed by the palladium. When the palladium is saturated, the thermo-electric force of the couple is 1.66 times as great as it was before the palladium was charged. In a thermo-electric couple formed of charged and uncharged palladium the current at the cold junction was found to go from the charged to the uncharged palladium. This result is contrary to that obtained by Knott, and the author supposes the divergence to be due to impurity in one or other of the samples of palladium employed.

An exhaustive study of a problem belonging to the mathematical side of chemistry appears in the current number of the *Annales de Chimie et de Physique*. Here M. Lemoine investigates the influence of heat, unaffected by that of light, on the reactions which take place in aqueous solutions containing ferric chloride and oxalic acid. When these substances are present in equivalent proportions, the interaction is irreversible, and proceeds according to the equation,  $2\text{FeCl}_3 + \text{H}_2\text{C}_2\text{O}_4 = 2\text{FeCl}_2 + 2\text{HCl} + 2\text{CO}_2$ . At any temperature the rate at which decomposition takes place is found to follow the well-known law of mass action, which states that the amount of substance which is being decomposed at any instant is proportional to the amount of unchanged substance contained in unit volume of solution. The rate of change, concentration remaining the same, is found to vary to a most marked extent with variation in temperature. Thus at 100°, in one hour 16 of the original amount of substance was decomposed, whereas at ordinary temperatures after six years only 0.19 equivalents had reacted. The presence of water accelerates the velocity of change according to a law which varies slightly with the temperature, a slight excess of oxalic acid accelerates the rate, a large excess of oxalic acid or of ferric chloride retards it. Excess of concentrated hydrochloric acid almost completely arrests the reaction. The effects which these and other materials exert upon the course of the simple reaction, the author studies both by chemical and thermochemical methods, and shows that they may be explained by the occurrence of secondary reactions. The communication, which extends over more than 100 pages, serves to give some idea of the patient labour involved in elucidating the mechanics of what appears at first sight to be a comparatively simple case of chemical decomposition.

THE Calendar of the University College of Nottingham for the thirteenth session, 1893-94, has just been issued.

A "BIBLIOGRAPHY of the Chinookan Languages" (including the Chinook jargon) has been prepared for the Bureau of Ethnology, Washington, by Mr. J. C. Pilling.

MESSRS. PERKEN, SON, AND RAYMENT have published the eighteenth edition of a little book on "Intensity Coils," and the second edition of "The Magic Lantern: its Construction and Use." Both books are suited to the wants of the scientific amateur.

MR. ALBERT F. CALVERT presents, in his "Mineral Resources of Western Australia" (George Philip and Son), an array of facts of particular interest to the capitalist and emigrant. Beneath the surface of that country lie belts and reefs of gold-bearing rocks sufficient to satisfy the most avaricious, and Mr. Calvert is desirous that the profuseness of these and like mineral deposits should convince people that the country offers "mighty possibilities" to enterprise.

DR. M. C. COOKE'S "Romance of Low Life among Plants," published by the Society for Promoting Christian Knowledge, is an interesting and very readable book on cryptogamic vegetation. Though written in language "understood of the people," and full of romantic beliefs connected with plants in a bygone age, scientific accuracy is not sacrificed, and scientific words are not strictly tabooed, as they usually are in the diffuse books designed for the popular palate. A larger number of illustrations would render the book still more interesting and valuable.

DR. A. R. C. SELWYN, C.M.G., F.R.S., the Director of the Geological Survey of Canada, has had a catalogue prepared of the fine stratigraphical collection of Canadian rocks exhibited by the Survey Department at the Columbian Exposition. The collection comprised 1500 specimens, illustrating all the formations known to occur in the Dominion of Canada, from the Laurentian to the Pleistocene. Mr. W. F. Ferrier gives a few explanatory notes with regard to the rocks represented in the collection.

If the number of books published on a particular subject can be regarded as an indication of the interest taken in that subject, we are led to the gratifying conclusion that physical laboratories are rapidly increasing. Books dealing with practical physics are constantly being published, and the last received by us—"Practical Work in Heat," by Mr. W. G. Woolcombe (Clarendon Press)—shares the generally excellent character of works of its kind. It is now believed by all men of science that physics cannot be properly taught by lectures alone, any more than chemistry, and the belief is slowly but surely causing our schools and colleges to give facilities for such necessary practical work. Mr. Woolcombe's book includes sections on thermometry, expansion, calorimetry, evaporation, and radiation. Excellent experiments are described in each section, and their performance does not necessitate the use of expensive apparatus. In fact, the book contains a practical course in heat that we should like to see introduced into every school which includes physical science in its curriculum.

COMPOUNDS of carbon monoxide with potassium and sodium respectively have been obtained by M. Joannis, by the action of gaseous carbon monoxide upon solutions in excess of liquefied ammonia of the peculiar compounds which potassium and sodium form with ammonia. M. Joannis has for several years been investigating the nature and reaction; of these latter compounds, potassammonium and sodammonium, and the results of his researches have been referred to in previous notes (see NATURE, vol. xliii. p. 399, and vol. xlv. p. 158). The reactions which

occur between these substances and carbon monoxide are of a most interesting character, throwing light as they do upon the nature of the dangerously explosive compound of potassium and carbon monoxide which formerly produced such deplorable accidents during the commercial production of metallic potassium by the method of Brunner. A considerable number of investigations have been carried out with the object of obtaining a complete knowledge of this explosive substance, but the results arrived at can scarcely be termed concordant. Most of the investigators agree in assigning to it the simple formula KCO, but the descriptions of its properties are very diverse. Liebig and likewise Lerch describe it as a black powder, while Brodie endows it with a red colour. The latter chemist found it to react in a most violent manner with water, while Liebig's substance was much more gentle in its demeanour towards that solvent, and actually permitted of the application of a moderate heat with no more serious result than quiet inflammation. More recently Nietzki and Beuckiser have described it as not only explosive but as detonating, when exposed to the moist atmosphere, under the influence of the least concussion in its neighbourhood. The potassium compound now described bears most resemblance to the unstable substance of Brodie and of Nietzki and Beuckiser, although differing in several particulars. The analogous sodium compound does not appear to have been previously obtained.

WHEN dry carbon monoxide is allowed to bubble through a solution in liquefied ammonia of potassammonium, the blue substance of the probable composition  $(\text{KNH}_3)_n$  produced by dissolving metallic potassium in liquefied ammonia, the containing vessel being cooled to  $-50^\circ$ , the deep blue colour gradually diminishes in intensity, and is eventually supplanted by a pale rose tint, the attainment of which signifies the completion of the interaction. Upon removal from the cooling mixture the liquefied ammonia gradually vaporises, depositing as it does so a rose-coloured powder which upon analysis proves to be pure potassium carbonyl KCO. When left undisturbed in a sealed tube for some time this pink powder darkens in colour, then answering very closely to the description of Brodie's substance. It cannot be heated to the temperature of boiling water, explosion ensuing considerably below that temperature. Detonation likewise occurs if the merest trace of air is admitted, and instantly when touched with a drop of water. Air and water both appear to act by causing such an elevation of temperature by their reaction with a small portion as to bring about sudden decomposition of the whole. It is, however, possible to study the reaction with water by admitting a drop of that liquid into an exhausted tube containing potassium carbonyl in such a manner as not to come into direct contact with the substance; the aqueous vapour then slowly reacts with the apparent production of deliquescence and the eventual formation of a yellow viscous liquid. The nature of this liquid is reserved for a future communication.

SODIUM does not resemble potassium in directly uniting with carbon monoxide. Sodammonium  $(\text{NaNH}_3)_n$  is, however, readily decomposed by carbon monoxide with formation of sodium carbonyl, NaCO, a substance which may be isolated in a manner similar to that employed for the isolation of the potassium compound. It is a pale lilac-coloured substance which is powerfully explosive like its potassium analogue. Detonation ensues under the influence of small quantities of either air or water. Under the influence of heat its colour darkens, no gas is evolved, but about  $90^\circ$  sudden explosion occurs, and with such force that no glass has yet been found to withstand it. It also explodes like the potassium compound under the influence of percussion, although not quite so readily as the latter substance. The nature of the changes occurring in

the explosion by percussion were ascertained by performing the reaction in a sealed tube of strong glass, also containing a few glass beads. The rattling of the beads was sufficient to induce explosion, and in one experiment out of a large number the tube remained intact. It was found that the products were all solid substances. The main reaction proceeds in accordance with the equation  $4\text{NaCO} = \text{Na}_2\text{CO}_3 + \text{Na}_2\text{O} + 3\text{C}$ . A small quantity of sodium cyanide was also produced. When a drop of water is introduced into a similar tube detonation immediately occurs, and the whole tube is filled with a red flame, the colour of which may perhaps be accounted for by the fact that a considerable quantity of hydrogen gas is liberated. The other products of the reaction are sodium carbonate, free carbon, and a small proportion of carbon monoxide. Water vapour, however, reacts in a quiet manner, as in the case of potassium carbonyl, the substance successively changing colour to brick-red, reddish-brown, and dark violet, until at length a viscous liquid of a deep red colour is produced, whose nature, together with that of the liquid derived from the potassium compound, M. Joannis is now investigating.

NOTES from the Marine Biological Station, Plymouth.—Last week's captures include a specimen of the fine Nemertine *Cerebratulus rosaceus*, now first recorded for the British Isles. There are clearly hosts of interesting forms in the deeper water off the Devon and Cornish coasts, if only we had a stout steamboat from which to dredge this rich locality. The floating fauna has not been rich, owing to the prevalence of northerly and easterly winds. The presence of *Radiolaria*, in spite of this, has been an interesting feature. Terebellid and Polynoid larvæ, *Sagitta*, and a few Ophiuroid *Plutei* have also been observed.

THE additions to the Zoological Society's Gardens during the past week include a Bonnet Monkey (*Macacus sinicus*, ♀) from India, presented by Mr. James Kendal; a Hairy-nosed Wombat (*Phalascornis latifrons*, ♂) from South Australia, two Marabout Storks (*Leptoptilus crumeniferus*), a White-necked Stork (*Dissura episcopus*) from West Africa, a Javan Adjutant (*Leptoptilus javanicus*) from Java, presented by Mr. E. W. Marshall, F.Z.S.; a Macaque Monkey (*Macacus cynomolgus*, ♀) from India, presented by Mrs. B. E. F. Stevens; two and three Hedgehogs (*Eriaceus europæus*) British, presented respectively by Mr. W. Chatterton and Mr. A. S. Bird; two Herring Gulls (*Larus argentatus*) British, presented by Mr. B. Tremble; a Blossom-headed Parrakeet (*Palæornis cyanocephalus*, ♂) from India, presented by Mrs. Osmond Barnes; a White-handed Gibbon (*Hylobates lar*, ♀) from the Malay Peninsula, deposited; a Mona Monkey (*Cercopithecus mona*, ♂) from West Africa, two Lapwings (*Vanellus vulgaris*), a Common Curlew (*Numenius arquata*) British, purchased; three Dingoes (*Canis dingo*) born in the Gardens.

#### OUR ASTRONOMICAL COLUMN.

BROOKS'S NEW COMET (1893c).—In the *Astronomical Journal* (No. 306), Prof. E. E. Barnard briefly describes a photograph of this new comet, which he was able to obtain with a 6-inch Willard lens. The exposure was made under conditions not very conducive to good results, owing to the low position of the comet and the presence of the zodiacal light. The negative exhibits, however, many points of interest, and its characteristic features are described as similar to those shown in the photographs of Swift's comet 1892 I. Prof. Barnard's description is as follows:—"The plate shows the tail to a distance of  $3\frac{1}{2}^\circ$ . This tail irregularly divides into two slightly divergent branches. There are two narrow straight rays springing out from the head on opposite sides, and nearly symmetrical with the main tail. The north ray, which seems to leave the

region of the nucleus, is inclined to the body of the comet by about  $45^\circ$ ; the southern, which leaves the comet  $10'$  or  $15'$  back of the head, is inclined about  $30^\circ$ . They are both about  $\frac{1}{2}^\circ$  long. There are faint evidences of several other rays from the southern side of the comet."

BIELA METEORS.—The return of the "Andromedes" this year is looked forward to with special interest, owing to their great abundance last year. It will be remembered that in 1892, instead of arriving on November 27 or 28, as was expected, the maxima occurred about the 23rd, or four days in advance of the predicted time, so that observers this year must be on the *qui vive* early. The director of the Pulkova Observatory, M. Bredichin, accounts for this retrograde motion by supposing it to be caused by the perturbations of Jupiter, which during 1890 were very great. Besides a retrogradation of the node amounting to  $4'$ , the inclination of the orbit has largely diminished.

THE PLANET JUPITER.—Jupiter's red spot, although preserving its oval form, is very dim, and is less sharp than in preceding years. The general aspect of the disc seems to have sensibly undergone changes and shows many more details, as if the cloudy atmosphere of the planet had been more than usual disturbed. Numerous observers are now scanning his disc, and some recent results are contained in the current number of *L'Astronomie* (No. 11). M. Guiot has made a series of drawings which are there produced; they show how the equatorial belt has gradually advanced to the west relatively to a small black spot indicated in the drawing, and has consequently made the latter appear to have a motion in the opposite direction, *i.e.* eastwards. The motion is clearly shown by a change of inclination in a line connecting the same two spots in the series.

A NEW VARIABLE STAR.—The Rev. T. E. Espin announces from the Wolsingham Observatory that a red star (anonymous) at R.A. 19h. 7m. 16s., Decl. +25° 46', is variable. Its magnitude on August 21 was 9.0, but it has diminished to 11.0 mag. Photographs taken with the Compton telescope have confirmed the variability of Es. 329 (R.A. 19h. 59m. 6s., Decl. +36° 25').

THE "OBSERVATORY" FOR NOVEMBER.—In the current number of this monthly, Mr. T. Lewis concludes his interesting survey on the various methods of computing double-star orbits. Mr. H. H. Turner describes briefly a short method of obtaining a star's right ascension and declination from a photograph, the results being correct to less than a second of arc. Mr. Dunkin, in a letter to the editors, gives the text of the "Adams Memorial," lately placed in the north transept of Truro Cathedral, and erected at the expense of a few Cornish friends and admirers, both resident and non-resident, as a mark of their high esteem for him as an astronomer and mathematician, and also for the strong affection he always entertained to the end of his life for the hills and dales of his native county. The translation is as follows:—

In this place, as is his due,  
We commemorate our own [West] countryman  
John Couch Adams

Tracing his way  
By the sure clue of Mathematics  
Through the boundless night of space  
He found the outermost of the planets.

Faithfully pursuing the paths of the Sciences  
With single-hearted modesty and clearness of intellect,  
He loved God Whom he saw in the Face of Christ;

For him, as well as for Henry Martyn,  
Cornwall and Cambridge  
Owe each other mutual debts.

He died, dearly loved by all who knew him,  
On the 21st of January 1892,  
Aged 72 years, 7 months, 16 days.

SOLAR OBSERVATIONS AT CATANIA, ROME, &c.—Prof. Ricco, in the August number of the *Memoire della Societa degli Spettroscopisti Italiani*, gives a detailed account of the observations of solar protuberances observed at the Royal Observatory of Catania during the year 1892. The same number contains two of the large diagrams showing the sun's limb as observed at Catania, Palermo and Rome, one for February-March 1892, and the other for March-April of the same year.

THE STIGMATA OF THE ARACHNIDA, AS A CLUE TO THEIR ANCESTRY.

IF on a diagram of an Arachnidan body we mark every segment on which stigmata are said to occur, the result is somewhat remarkable.

The subjoined figure is such a diagram, and stigmata, functional or vestigial, are known on all the segments except the second and third. On the left hand of the diagram I have recorded the form which the tracheal invaginations from each pair of stigmata assume, *i.e.* whether they are tubular or laminate; and on the right hand I have noted the genera in which the stigmata occur, with a straight underline if their tracheæ are tubular, and a wavy underline if their tracheæ are laminate. The marks which represent the stigmata are not intended to denote their real positions on the segments, but only to indicate their presence, although there is reason for thinking that they may well represent their primitive positions.

On the first segment we have stigmata recorded on the dorsal surface at the bases of the mandibles in some Acaridæ. This remarkable position may be in some way connected with the formation and dorsal arrangement of the "cephalic lobes,"<sup>1</sup> which accompanies the translocation of the mandibles from a post-oral to a pre-oral position. All the other tracheæ of the Arachnida are associated with limbs, the Arachnida agreeing in

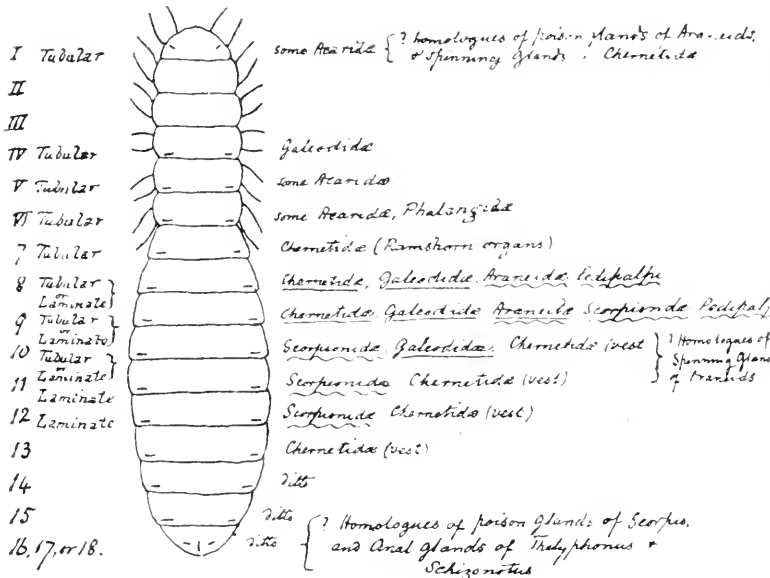

his point with the Hexapoda and Myriapoda, but differing from the Peripatidæ.

On the sixth segment we have stigmata both in Acaridæ and Phalangidæ behind the last pair of legs. This position may mean either on the last cephalothoracic or on the first abdominal segment. I do not wish to lay special stress on this one case; but, considering the general absence of stigmata on the abdomen in Acaridæ, owing to the rudimentary condition of this region of the body, I think there is something to be said for the position indicated in the diagram. The same argument applies to the Phalangidæ, in which animals also the abdomen is but feebly developed.

On the first abdominal segment (7) we have the remarkable ram's-horn organs which I have elsewhere<sup>2</sup> suggested may be a primitive form of tracheal invagination, from which either laminate or tubular tracheæ may be very easily deduced.

On the following two abdominal segments (8 and 9) we have tubular and laminate tracheæ equally distributed, all those hitherto described having been tubular.

On the tenth segment we have functional laminate tracheæ in Scorpio, tubular tracheæ descending to a medium (? closed) stigma in Galeodes, and vestigial stigmatic scars in the Chernetidæ. These scars are repeated segmentally on all the remaining abdominal segments in the Chernetidæ, and repre-

sent the closed stigmata of vanished tracheæ, which tracheæ, if we may judge from the ram's-horn organs and the functional tracheæ on the second and third abdominal segments, were all most certainly tubular.

From these facts we are justified in concluding (1) that the tracheal invaginations of the ancestor of the Arachnids were strictly segmental, and (2) that these invaginations were of some simple tubular type, from which the laminate forms could be easily developed. The ram's-horn organs of the Chernetidæ, with the simple air chambers in their epithelial cells as recently described (*l.c. supra*), might well represent such primitive invaginations.

An impartial review of the facts must convince everyone that the laminate form is the more specialised. The tubular form is by far the most widely distributed, being not only universal among the Hexapoda and Peripatidæ, but far more common among Arachnids than the laminate. Tubular tracheæ occur universally in the Acaridæ, which have some claim to be considered as fixed larval forms (*Fourc. Linn. Soc. Zool.* vol. xxiv. p. 279); in the Phalangidæ, which are so specialised that they must have branched off very early from the main Arachnidan stem; in the Chernetidæ, which again are very difficult to class, and may claim to be an independent group; and lastly in the Galeodidæ, which in many respects are the most primitive of all Arachnids.

The Araneidæ, with their highly specialised abdomen, possess both laminate and tubular forms, while the Scorpionidæ and related Pedipalpi are the only Arachnids, and indeed the only Arthropods (except a few Myriapods, which have exclusively laminate tracheæ. The laminate tracheæ of the Myriapods cannot possibly be deduced from the laminate tracheæ of the Arachnids, but both forms of laminate tracheæ can be deduced from a primitive tubular organ.

Returning to the diagram, the facts therein epitomised presuppose the existence in the ancestor of the group of simple limbs on every segment. In addition to the six pairs of limbs on the first six segments, clear traces of limbs are well known either in a persistent or a vestigial disappearing form on the first six abdominal segments. Further, we can conclude from the stigmatic scars on the Chernetidæ, that there must originally have been limbs on all the remaining segments of the abdomen. The character of these limbs may perhaps be gathered from those of the nymphs of many Acaridæ, which probably represent the earliest developmental stages in the Arachnida now traceable, and perhaps also from the legs of the Silurian Scorpion, *Pulcocephalus nuncius*.

We can thus trace the Arachnids back to a segmented ancestor with a pair of limbs and a pair of tracheæ on every segment—*i.e.* to an ancestral form resembling those of the Myriapoda and Hexapoda, but differing from these in having the rows of stigmata ventral instead of lateral, apart, of course, from the profound difference in the specialisation of the oral appendages.

Among the later modifications of this primitive Arachnid we have the differentiation of the body into the cephalothorax and the abdomen. The former consists of the first six segments which have retained their limbs. The segments of the latter have lost their limbs almost completely, rudiments, however, persisting as genital opercula, pectines, and spinning mammillæ. In the former the great development of limbs and musculature and the fusing of the segments together has led to a general suppression of the tracheal invaginations. One pair, however, persists in the Galeodidæ, which, with the exception of *Schizognathus*, are alone among Arachnids in retaining the original jointing of the posterior cephalothoracic segments, and in the Acaridæ and Phalangidæ, in both of which the abdominal region is not fully developed.

The second and third segments appear to be the only ones on which hitherto no traces of stigmata have been found. This may be due to the fact that in the formation of the mouth parts the first three segments early fused together.

The general disappearance of tracheæ from the cephalothorax

<sup>1</sup> "The 'Head' of Galeodes," &c. *Zool. Anz.* No. 426, 1893.  
<sup>2</sup> "Notes on the Chernetidæ." *Linnean Society's Journ.* (in press).



necessarily confined the respiratory organs to the abdominal region. Further, those on the anterior segments of the abdomen would be gradually preferred for specialisation, as being nearer to the cephalothoracic musculature, and to the shelter of the limbs for the protection of the open stigmata. The Scorpionidae alone, having highly developed musculature in the posterior abdominal segments, have the respiratory invaginations nearly evenly distributed along the middle of the abdominal region.

On the diagram I have further indicated a few suggested homologies. I have elsewhere<sup>1</sup> brought forward evidence in favour of the derivation of tracheæ from setiparous glands. The derivation of poison and spinning glands from similar structures is generally admitted. The consequent homology between the spinning glands and tracheæ requires a slight modification. When, as in the Hexapoda, most Myriapoda, and the Arachnida, the tracheæ are strictly segmental, and intimately associated with limbs, they have probably arisen from the large bristle sacs which secrete the specialised parapodial acicula; spinning glands, on the other hand, are more generally to be deduced from groups of ordinary bristle sacs, although they may also be deduced from acicular glands as well. It is important to bear this qualification in mind, as it helps to throw light on a difficult point in the morphology of the Araneids. While the two pairs of spinning glands on the two pairs of mammillæ are referable to setiparous glands on rudimentary limbs, and probably homologous with tracheæ, there are also, in the majority of spiders, median spinning glands between the mammillæ, which cannot be brought into connection with any rudimentary limbs. This difficulty is, however, fully explained by the position of the abdominal cement glands in the Chernetidae, which serve to stick the eggs to the abdominal surface, in which position they are carried about by the parent. In these animals we have, on the second and third abdominal segments, median glands (originally paired) occurring *between* the two pairs of tracheal invaginations. In this case I should refer the tracheæ to acicular glands, and the cement glands on the same segment to groups of setiparous glands lying ventrally to the acicula. In the genus Galeodes, rows of short powerful bristles actually occur in the corresponding position, *i.e.* close to the median line on the second and third abdominal segments, and form the stigmatic combs, which are quite distinct from the stigmata themselves. According to this derivation we might have two pairs of spinning glands on each segment, one pair placed laterally on mammillæ, and one pair close to the median line between the mammillæ. This arrangement is actually found in the rare spider Liphistius, which has four pairs of spinning glands arranged as here described. This is especially interesting, because in addition to other primitive features Liphistius is alone among known spiders in retaining at least nine distinct abdominal tergites.<sup>2</sup>

The facts and suggestions here briefly set forward are a small instalment of the results obtained during my researches on the comparative morphology of the Galeodidae, which I hope shortly to have ready for publication. I may, perhaps, add that the net results of these investigations so far to establish that classification which ranks the Arachnids as an independent group of the tracheate Arthropods, as distinguished from that which would deduce them from the specialised Crustacean Limulus through the specialised Arachnid Scorpio.

Huxley Research Laboratory. H. M. BERNARD.

### THE PRESENT STANDPOINT OF GEOGRAPHY.

MR. CLEMENTS R. MARKHAM, C.B., F.R.S. inaugurated the evening meetings of the new session of the Royal Geographical Society, on Monday night, by a presidential address on the present standpoint of geography. He gave a survey of the state of our actual knowledge of the earth's surface, and pointed out the regions where exploration may still be done. Viewing exact delineation by trigonometrical measurement as the crowning work of geography, he pointed out how incomplete the exact mapping of the land surface of the globe still was, while the delineation of the bed of the ocean had hardly been begun. In the Polar regions, of course, lay the

greatest unknown areas, and the two expeditions now in the field, Nansen's and Peary's, were referred to with some confidence as to their probable success. Mr. Markham himself believed that land exists between Prince Patrick Island and Siberia, which ought to be discovered, and was inclined to accept Lieut. Hovgaard's theory of extensive land north of Cape Chelyuskin. He indicated the delineation of the north coast of Franz Josef Land as one of the more important pieces of Arctic work for the near future. Consideration of the vast Antarctic field was postponed until Dr. Murray's paper at the next meeting.

In Europe there remained scope for detailed survey in many countries, and Mr. W. H. Cozens-Hardy's recent labours on the frontiers of Montenegro are only a foretaste of what has to be done in the Balkan Peninsula. The Cantabrian mountains on the west, and the Caucasus on the east, contain still many isolated unknown patches.

In Africa the unknown had been diminishing within his memory more rapidly than anywhere else, and the days of suddenly-planned expeditions discovering features of the first magnitude had altogether passed. What remain unknown are two great areas in the Sahara, in the Tibesti, and Ahaggar highlands, the negro kingdom of Wadai, and the region stretching from Southern Abyssinia into the Somali Peninsula. In countless places detailed work has to be done, such as Dr. Gregory's study of Mount Kenia, and Mr. Scott-Elliott's similar detailed survey of the Ruwenzori region, just undertaken. The best future work for geography in Africa lies in surveying rather than exploring, and lines of survey should be run across the continent in defined and well-thought-out directions.

Asia has also new ground to break into. The valleys of Hadramant, in Arabia, are almost as little known as the Antarctic regions, and Mr. and Mrs. Bent will shortly endeavour to explore that district. In Asia Minor and Persia much detailed surveying must be done. In Central Asia there is Khasa, unvisited by an Englishman for generations, and a vast region in north-western Tibet, between 34° and 36° N., and 82° and 90° E. is a blank upon our maps, in spite of the magnificent journeys recently made by Bower, Rockhill, and the Russian explorers. Nearer India, Nepal is little known; Kafiristan is absolutely secluded from the European, and there could be no nobler ambition for a young geographer than to be the first to explore Kafiristan. The maze of mountain ranges and river valleys east of the Himalayas has yet to be unravelled, and the whole interior of Indo-China is full of opportunities for research. Korea, in the far east, is yet far from being fully known. The great Malay Archipelago must receive much more attention, and the problems of western New Guinea alone, with the grand range of the Charles Louis mountains, are well worthy of being seriously attacked. Upraised coral atolls in the Solomon Islands have been reported but not visited. As regards new discovery, however, there is probably no undiscovered islet remaining in the whole Pacific.

Australia, except some desert patches in the west, has been practically explored, although immense areas have still to be surveyed, and the development of colonial geographical societies gives good promise of that continent being thoroughly studied from within.

In North America, Dr. George Dawson enumerates a number of great stretches of land, aggregating several hundred thousand square miles, absolutely untraversed by any intelligent white man. These lie mainly north of the Arctic circle, between the great rivers that flow into the Arctic Sea and in Labrador. Alaska also has its unknown tracts, and even in the United States there is much room for detailed surveys.

Central America is not well known, and in South America much of the Colombian Andes, the basins of the Japura and Putumayo, the whole tract between the Andes and the Orinoco and Rio Negro, are practically unknown. In Peru whole provinces are unexplored, and many peaks unmeasured.

Oceanography is only beginning to yield results, and other departments of generalised physical geography are of growing importance. The better instruction of intending travellers, inaugurated by the Society, and carried out by Mr. Coles, has done much to confer value on the observations of officials, traders, and missionaries, while the more thorough study of theoretical geography, now beginning, requires great extension and elaboration before its work would be thorough.

<sup>1</sup> *Zool. Jahrb.*, vol. v. p. 511, and *Ann. and Mag.*, January, 1893.

<sup>2</sup> *Cf.* "Liphistius," R. I. Pocock, *Ann. and Mag.*, N. H., October, 1892.

SOME LABORATORIES OF MARINE  
BIOLOGY.

THE description of some of the Marine Biological Laboratories of Europe, contributed by Mr. Bashford Dean to the *American Naturalist* for July, and reprinted in *NATURE*, August 24, was continued by the author in the August number of our transatlantic contemporary. Some of the most important laboratories were omitted in the first article, but they are included in the second, from which the following account has been taken:—

“The Stazione Zoologica at Naples during the past twenty years has earned its reputation as the centre of marine biological work. Its success has been aided by the richness of the fauna of the Gulf, but it is due in no small degree to careful and energetic administration. The director of the station, Prof. Dohrn, deserves no little gratitude from every worker in science for his untiring efforts in securing its foundation and systematic management. Partly by his private generosity and partly by the financial support he obtained, the original or eastern building was constructed. Its annual maintenance was next assured by the aid he secured throughout (mainly) Germany and Austria. By the leasing of work tables to be used by representatives of the universities, a sufficient income was maintained to carry on the work of the station most efficiently. A gift by the German government of a small steam launch added not a little to the collecting facilities.”

After commenting upon the attractiveness of the Naples station, and the general air of quietness which results from the excellent system that prevails in every branch of the station's organisation, Mr. Dean goes on to describe the aquarium room, which is lighted only through wall-tanks. “There are in all about two dozen large aquaria embedded in the walls of the sides and of the main partition of the room. The water is clear and blue. The background in each aquaria, built of rockwork, catches the light from above and throws in clear relief the living inmates.”

“There is no more interesting department of the station than that of receiving and distributing the material. . . . Neapolitan fishermen have learned to bring all of their rarities to the station. The specimens are quickly assorted by the attendants; such as may not be needed for the immediate use of the investigators are retained and prepared for shipment to the universities throughout Europe. The methods of killing and preserving marine forms have been made a most careful study by Cav. Lo Bianco, and his preparations have gained him a world-wide reputation. Delicate jelly-fish have to be preserved distended, and the frail forms of almost every group have been successfully fixed. The methods of the Naples station were kept secret only until it was possible to verify and improve them, as it was not deemed desirable to have them given out in a scattered way by a number of investigators.”

There are at present two American tables at Naples, one supported by the Smithsonian Institution, and the other by gift of Agassiz.

“The entire Italian coast is so rich in its fauna that it is due perhaps, only to the greatness of Naples, that so few stations have been founded. Messina has its interesting laboratory well known in the work of its director, Prof. Kleinenberg. The Adriatic, especially favourable for collecting, has at Istria a small station on the Dalmatian coast, and at Trieste is the Austrian station. Trieste possesses one of the oldest and most honoured of marine observatories, although its station is but small in comparison with that of Naples, Plymouth, or Roscoff. Its work has in no small way been limited by scanty income; it has offered the investigator fewer advantages, and has, therefore, become outrivalled. During a greater part of the year it is but little more than the supply station of the University of Vienna, providing fresh material for the students of Prof. Claus. Its percentage of foreign investigators appears small; its visitors are usually from Vienna and of its university.”

Dr. Græffe is the director of this station. With regard to laboratories of marine biology in Germany, Norway, and Russia, Mr. Dean says:—

“The German universities have contributed to such a degree to the building up of the station at Naples that they have hitherto been little able to avail themselves of the more convenient but less favourable region of German coasts. The collecting resources of the North Sea and of the Baltic have perhaps been not sufficiently rich to warrant the establishment

of a central station. On the side of the Baltic, the University of Kiel, directly on the coast, may itself be regarded a marine station. At present the interest in founding local laboratories has, however, become stronger. At Plön, not far from Flensburg, is established a small station under the directorship of Prof. Zacharias, and the first number of its contributions has recently been published. In addition the newly-acquired Heligoland has become the seat of a well-equipped Governmental station, under the directorship of Dr. R. Heincke. The island has been long known as most favourable in collecting regions, and its position in the midst of the North Sea fisheries gives it especial importance.

“Norway, like Germany, is strengthening its interest in local marine laboratories. It has succeeded in establishing two permanent stations, one near Bergen, the other, most recently, on an out-jutting point of the North Sea almost westward of Christiana. The former is interested especially in matters relating to the North Sea fisheries, and is supported partly by the contributions of a learned society and partly by a subsidy from the Government in view of its relation to the practical fisheries. The second and smaller station is devoted almost exclusively to research in morphology. It is a dependency of the University of Christiana, and is under the directorship of one of its professors, Dr. Johan Hjört. With the richest collecting resources these new stations may naturally be expected to yield most important results.

“Russians have ever been most enthusiastic in marine research, and their investigators are to be found in nearly every marine station of Europe. The French laboratory on the Mediterranean at Ville Franche, as has previously been noted, is supported essentially by Russians. At Naples they are often next in numbers to the Germans and Austrians. The learned societies of Moscow and St. Petersburg have contributed in no little way to marine research. The station at Sebastopol on the Black Sea has become permanent, possessing an assured income. That near the convent Solovetsky on the White Sea, though small, is of marked importance. It is already in its thirteenth year. Prof. Wagner, of St. Petersburg, has been its most earnest promoter as well as constant visitor. He in fact caused the Superior of the convent to become interested in its work and secured a permanent building by the convent's grant; he was then enabled by an appropriation from Government to provide an equipment. Its annual maintenance is due to the Society of Naturalists of St. Petersburg. The matter of the appointment of a permanent director for the summer months is now being agitated. The station Solovetskaia is said to possess the richest collecting region of the Russian coasts. It is certainly the only laboratory which has at its command a truly Arctic fauna.”

The article concludes with a brief description of the Swedish zoological station on the west coast near Gothenberg. The station was founded by Dr. Regnell about fifteen years ago, and Dr. Hjalmar Theel is its present director. The students are mainly from the university of Upsala; indeed, no foreigners are admitted to it.

UNIVERSITY AND EDUCATIONAL  
INTELLIGENCE.

OXFORD.—The accommodation for students in the Radcliffe Library has been improved by the removal of the sub-librarian's office to the room under the central tower and the provision of several new reading tables in the space thus created. But as the numbers of scientific students continue to increase, it is clear that some more extensive and permanent addition will very soon be necessary. The number of regular readers in the library this term is seventy-nine; ten years ago it was only thirty-one, and in the previous decade it was seldom that more than five or six students made use of the library in a single day. These figures give some idea of the gradual growth of scientific studies in the University. A proposal has been set on foot, which, if it is carried out, is likely to affect scientific studies in Oxford very beneficially. It is, that besides the existing means of obtaining a degree by examination, facilities shall be given for obtaining a degree for research in any recognised subject. It is proposed that a residential qualification of two years shall be imposed on any candidate for such a degree, and that evidence must be brought forward of continuous research and study, to the satisfaction of the board appointed for the purpose. At

present the scheme has merely been brought before the Hebdomadal Council, and has, as yet, assumed no definite shape.

CAMBRIDGE.—The Local Examinations and Lecture Syndicate have presented to the Senate their twentieth annual report. The most important event of the year has been the establishment of the University Extension and Technical College at Exeter. The college has been established by the co-operation of the Town Council of Exeter, the University Extension Committee of Exeter, and the Syndicate, and Mr. A. W. Clayden, of Christ's College, has been appointed principal. The work done for County Councils under the authority of the Syndicate has been continued during the past year. There has been a considerable diminution in the area covered, as County Councils have been able to utilise to a greater extent than before the services of local teachers, and have spent a larger proportion of their available funds in grants in aid of permanent institutions for technical teaching. On the other hand, the reports received from lecturers indicate considerable improvement in the quality of the work done. About 650 students attended the summer meeting, of whom 150 were men and 500 women. On the whole the work done was satisfactory, though a certain number of students attempted too many subjects. It is not considered desirable to hold such meetings oftener than once in two years, but classes on a smaller scale may satisfactorily be held in the alternate long vacations. From Mr. Arthur Berry's report to the Syndicate it appears that the stimulus given to the work of the local lectures last year by the activity of the County Councils in the matter of technical education has lost a good deal of its effect, as more permanent institutions for educational purposes are gradually being organised. Not only have literature and history thus suffered, but courses on branches of science not of obviously practical utility (such as astronomy) have tended to be displaced by more "technical" subjects. It is satisfactory to learn that such engagements as have already been made for the ensuing winter indicate a distinct reaction against the exclusive study of "bread and cheese" subjects.

In resigning office on September 30, the late Vice-Chancellor, Dr. Peile, called attention to the lack of funds for research in several of the scientific departments. He is now able to announce that an anonymous member of the Senate has placed in his hands £100 for the support of higher work in the Pathological Department during the coming academical year.

A fire, which took place at the Pitt Press last week, has necessitated the temporary evacuation of the room occupied by the Registrar. The Old Library of Pembroke College has been placed at his disposal by the Master and Fellows, and the business of the office will be carried on there during the present term.

The scheme for examinations in agricultural science under a managing syndicate was non-placeted on November 9, but was carried by a very large majority. The proposal to postpone the conferring of Honours degrees to the Long Vacation, in order to give more time for the Tripos examinations, was rejected.

The *University Reporter* of November 14 contains notices of scholarships in Natural Science open for competition to non-residents at Peterhouse, Clare, Pembroke, King's Queen's, St. John's, and Sidney Sussex. The examinations will be held in December and January next.

TRINITY COLLEGE, DUBLIN.—There is during this term a large increase in the number of students interested in the study of biology; so large, in fact, that the accommodation in the Botanical Laboratory has had to be increased. This is a pleasing feature in a university so long devoted to classical pursuits.

At the recent Moderatorship Examinations, three candidates, C. J. Patten, F. K. Boyd, and N. H. Alcock, obtained Senior Moderatorships, and were awarded gold medals in Natural Science (Botany, Zoology, Geology, and Physiology). During the week the University Experimental Science Association held its opening meeting, when a very large audience assembled to hear Dr. Joly, F.R.S., deliver a lecture on "Some Applications of Photography." The Provost, Dr. Salmon, occupied the chair.

The *British Medical Journal* says that steps are being taken to arrange for a deputation representing the university colleges in England to wait, shortly, upon the Chancellor of the Exchequer, to urge upon him the propriety of increasing the annual parliamentary grant. A sum of £15,000 has been

granted annually since 1890, and when this sum was first placed upon the estimates, it was understood that the question would be reviewed at the end of five years. A Treasury Committee, consisting of Sir Henry Roscoe, Mr. George Curzon, Prof. Bryce, Mr. R. G. C. Mowbray, and Mr. W. J. Courthope, have reported recently in favour of the grant being doubled, pointing out that all educational work connected with science is increasing yearly in cost, and that the growth in the number of students and the enlargement of the teaching staff have contributed to strain the resources of the colleges.

### SCIENTIFIC SERIALS.

*Bulletin of the New York Mathematical Society*, vol. iii. No. 1. (New York: Macmillan, October, 1893).—A congress of mathematics and astronomy was opened at Chicago on August 21, and this number commences with Dr. Felix Klein's inaugural address. It is brief but not witty, and merely sketches some of the papers to be read, and closes with the remark that mathematicians must go farther than to form "mathematical societies." "They must form international unions, and I trust that this present congress at Chicago will be a step in that direction." Prof. T. H. Safford narrates briefly, in his remarks on "instruction in mathematics in the United States," the history of the noteworthy rise in the general standard of mathematical teaching within the last few years. Prof. Ellery Davis reviews four recent geometries, viz. those by Hopkins, Dupuis, W. B. Smith, and Halsted. Prof. Tyler analyses the papers read at the Chicago congress, and Prof. Waldo gives a brief account of the American Association meeting at Madison on August 16-23. Three pages of notes of mathematical doings, and eight pages of new publications follow. This last feature of the *Bulletin* is a very prominent and highly valuable one.

The *American Meteorological Journal* for November contains an account of the second annual meeting of the American Association of State Weather Services, held in Chicago, on August 21-23, 1893. The meeting was well attended, and resolutions were adopted on various subjects, among which may be mentioned the issue of weekly crop bulletins. It was also recommended that the bottom of thermometer screens should be four and a half feet above the ground; this would make the thermometers about a foot higher than is recommended in this country. It is stated that experiments made during the past year prove the former elevation to give the best results.—Mr. C. E. Linney read a paper on the value of frost predictions, and the best method of making them locally. The author is of opinion that with a knowledge of the ordinary weather signs an observer can, by the aid of the wet and dry bulb thermometers, form a good idea of what minimum temperature to expect during the night.

In the *Transactions of the Austrian Geological Survey* we remark an important communication, made by Mr. Friedrich Teller, "On the so-called Granite of the Bacher Mountains in South Steiermark." It seems that the familiar term, "granite of the Bacher," has been entirely misapplied. In the eastern part of these mountains the rock is granitic *gneiss*, forming a dome-shaped core beneath the crystalline schists; while the so-called granite in the western part is an intrusive *porphyrite*, younger than the whole series of schists and phyllites, and possibly of the same age as the porphyrite which penetrates Triassic and Jurassic strata in the neighbouring district.—Dr. A. Kornhuber gives the name of *Carsosaurus Marchesetti* to a new Saurian genus from the Karst district. It was found in the same cretaceous shales as *Acteosaurus*, a genus described thirty years ago by Hermann Meyer, and was erroneously thought to be merely a larger specimen of Meyer's genus.

### SOCIETIES AND ACADEMIES.

PARIS.

Academy of Sciences, November 6.—M. Lœwy in the chair.—On Goubet's joint and its application to marine screw-propellers, by M. H. Resal. This is a mathematical investigation of the action of a joint capable of making the propeller act as supplementary steering gear, and of adapting it to submarine navigation. It is shown to possess several advantages over the

similar American Clemens joint.—On a class of differential equations whose general integral is uniform, by M. Emile Picard.—Significance of the variety of organs in the gradation of vegetable species, by M. Ad. Chatin.—On a Nymphæa bed recently found and explored in the Aquitanian of Manosque, by M. G. de Saporta.—On equations of the second order with fixed critical points, and univocal correspondence between two surfaces, by M. Paul Painlevé.—On certain ordinary differential equations, by M. Alfred Guldberg.—On certain families of gauche cubes, by M. Lelievre.—On the nature of the reflection of electric waves at the end of a conducting wire, by MM. Kr. Birkeland and Ed. Sarasin.—Observations upon the preceding communication of MM. Birkeland and Sarasin, by M. H. Poincaré. This is an application of Maxwell's theory to the phenomena of propagation of energy into space round the end of a conducting wire along which electric waves are passing. It is shown that the deductions from the theory are in general accord with the facts observed.—On the measurement of coefficients of induction, by M. H. Abraham. The employment of a differential galvanometer in these measurements permits of an accurate determination within 1 per cent., and a reading to within 0.1 per cent. without much difficulty. The induced currents from a commutator regulated by a stroboscopic method are sent through one circuit of a differential galvanometer, the deflection being compensated by a continuous current derived from the same battery. The commutator is then stopped, and a current equivalent to the induced current is derived from the primary circuit through a resistance  $r$ , and sent through the secondary circuit,  $r$  being chosen so as to establish equilibrium in the differential galvanometer. Then this actual resistance  $r$  may be put equal to the fictitious resistance  $r/M$  obtaining while induction was going on, and we have  $M = \frac{r}{n}$  where  $M$  is the co-

efficient of mutual induction, and  $n$  the frequency of the commutator. The resistance  $r$  may be constituted by a standard ohm coil. M. Abraham has found by this method that the coefficient of mutual induction is reciprocal in the case of two circuits free from iron, but that this reciprocity is disturbed if they contain iron cores.—On vision of opaque objects by means of diffracted light, by M. Gouy. If an opaque and non-reflecting object is examined by means of a microscope or telescope, the object being placed in the path of a beam of light, the image is formed both by the rays following geometrical paths and by those diffracted by the outlines of the object. If the former are intercepted, the diffracted rays only form the image. This may be done by placing a small screen at the focus of the object-glass inside the telescope, so as to intercept the rays from a very distant source which converge there. The outline of the object is then seen as a thin bright line on a dark background, and with sufficient enlarging power this line is seen to consist of two, very close together, and separated by a very sharp black line. This black interval disappears on intercepting the diffracted rays either inside or outside the geometrical shadow, thus showing that it is due to the interference of these two beams. They possess a difference of phase of half a wave-length, and equal amplitudes. An arrangement such as this may prove useful when the outlines of an object require to be sharply defined.—On a new method of preparing methylamine and on the constitution of hexamethylene-tetramine, by MM. A. Trillat and Favollat.—On the alkaline methyl-tartrates and ethyl-tartrates, by M. J. Fayollat.—Researches on the homologues of gallanilide; preparation of galloparatoluide, by M. P. Cazeneuve.—Experimental hereditary influences, by MM. Gley and Charin.—On a phenomenon of inhibition in Cephalopoda; paralytic constriction of chromatophores, by M. C. Phisalix.—On the serial craniological continuity in the genus *Lepus*, by M. Remy Saint-Loup.—On the genus *Polydora* Bosc (*Leucodora* Johnston), by M. F. Mesnil.—The *Callibryachion*, a new reptile of the Permian of Autun, by MM. M. Boule and Ph. Glaizeau.—On the glacial and erratic phenomena in the Cachapoal Valley (Andes of Chili), by M. A. F. Nogués. The phenomena of transport by water and glaciers have contributed to the formation of the erratic system in the valleys of the Chili Andes. There must have existed lakes or deep terrace ponds. The glaciers must formerly have descended further than they do at present, and at the Cachapoal they are actually retreating now.—An earthquake shock at Grenoble, by M. Kilian. This happened at 4h. 13m. 40s. A.M., Paris time, on November 5, in a direction from N. to S., and was recorded by the seismometer of the Geological Laboratory of the Faculty of Sciences.

## BOOKS, PAMPHLETS, and SERIALS RECEIVED:

BOOKS.—Social England: edited by H. D. Traill, vol. i. (Cassell).—New Technical Educator, vol. ii. (Cassell).—Guelphs and Ghibellines: O. Brown (Methuen).—Intensity Coils, 18th edition (Perken). The Magic Lantern, 2nd edition (Perken).—British Fungus Flora: G. Masee, vol. 3 (Bell).—Weather Lore: compiled, &c., by R. Inwards (Stock).—Les Courants Polyphases: J. Rodet et Busquet (Paris, Gauthier-Villars).—Pour Devenir Financier: R. Chevrot (Paris, Gauthier-Villars).—Golf: a Royal and Ancient Game: edited by R. Clark, 2nd edition (Macmillan).—Aberration Problems: Prof. O. J. Lodge (K. Paul).—Eighth Annual Report of the Bureau of Ethnology: J. W. Powell (Washington).—Diamonds and Gold in South Africa: T. Reunert (Stanford).—The Incandescent Lamp and its Manufacture: G. S. Ram ("Electrician" Co.).—Eine Botanische Tropenreise. Prof. Dr. S. Haberlandt (Leipzig, Engelmann).—Der Botanische Garten "s Lands Pluutentuin" zu Buitenzorg auf Java (Leipzig, Engelmann).—Grundzüge der Physiologischen Psychologie: Prof. W. Wundt, Zweiter Band (Leipzig, Engelmann).—Die Altmacht der Naturzüchtung: Prof. A. Weismann (Jena, Fischer).—Australasia, vol. i.:—Australia and New Zealand: Dr. A. R. Wallace (Stanford).

PAMPHLETS.—Fenomeni Geodinamici che precedettero, accompagnerono e Seguirono l'eruzione Etnea del Maggio Guigno 1893. S. Arcidiacono.—Electro-Culture: P. de Puydt (Bruxelles).—Ethnography of the Arap Islands, Co. Galway, A. C. Haddon, and C. R. Browne (Dublin).—Bibliography of the Chinook Languages: J. C. Pilling (Washington).—Catalogue of a Stratigraphical Collection of Canadian Rocks prepared for the World's Columbian Exposition, Chicago 1893: W. F. Ferrier (Ottawa).—Das Karstphänomen: Dr. J. Cvijic (Wien, Hölzel).—Die Biologie als selbständige Grundwissenschaft: H. Driesch (Leipzig, Engelmann).—Tafel des Integrals: B. Kämpfe (Leipzig, Engelmann).—On the Volcanoes and Hot Springs of India: Dr. V. Ball (Dublin).

SERIALS.—Kansas University Quarterly, October (Lawrence, Kansas).—American Journal of Science, November (Newhaven, Conn.).—Bulletins de la Société d'Anthropologie de Paris, Nos. 8 and 9, 1893 (Paris).—L'Astronomie, November (Paris).—Zeitschrift für Wissenschaftliche Zoologie, lvi. Band, 4 Heft (Williams and Norgate).—American Naturalist, October (Philadelphia).—Morphologisches Jahrbuch, 20 Band, 3 Heft (Williams and Norgate).—Physical Society of London, Proceedings, vol. xii. Part 2 (Taylor and Francis).—American Journal of Mathematics, vol. xv. No. 4 (Baltimore).—Proceedings and Transactions of the Queensland Branch of the Royal Geographical Society of Australasia, vol. 8 (Brisbane).

## CONTENTS.

PAGE

|                                                                                                             |    |
|-------------------------------------------------------------------------------------------------------------|----|
| Romanes on Weismann. By P. C. M. . . . .                                                                    | 49 |
| Extra-Tropical Orchids. By R. A. Rolfe . . . . .                                                            | 50 |
| Our Book Shelf:—                                                                                            |    |
| Gore: "An Astronomical Glossary" . . . . .                                                                  | 51 |
| A Son of the Marshes: "With the Woodlanders and By the Tide" . . . . .                                      | 51 |
| Taylor; "Pitt Press Euclid, V.—VI." . . . .                                                                 | 52 |
| Furneau; "The Out-door World, or Young Collector's Handbook" . . . . .                                      | 52 |
| Briggs and Bryan: "Worked Examples in Co-ordinate Geometry" . . . . .                                       | 52 |
| Letters to the Editor:—                                                                                     |    |
| Sir Henry H. Howorth on "Geology in Nubia."—Dr. Alfred R. Wallace, F.R.S. . . . .                           | 52 |
| The Erosion of Rock-Basins.—Prof. T. G. Bonney, F.R.S. . . . .                                              | 52 |
| "The Zoological Record."—R. I. Pocock; F. A. Bather; B. B. Woodward . . . . .                               | 53 |
| Recognition Marks.—G. J. Macgillivray; Dr. Alfred R. Wallace, F.R.S. . . . .                                | 53 |
| Correlation of Solar and Magnetic Phenomena.—William Ellis, F.R.S. . . . .                                  | 53 |
| The New Bird-Protection Bill . . . . .                                                                      | 54 |
| Light-Waves and their Application to Metrology. (With Diagrams.) By Prof. A. A. Michelson . . . . .         | 56 |
| Further Notes and Observations upon the Instincts of some Common English Spiders. By R. I. Pocock . . . . . | 60 |
| Notes . . . . .                                                                                             | 63 |
| Our Astronomical Column:—                                                                                   |    |
| Brooks's New Comet (1893c) . . . . .                                                                        | 67 |
| Biela Meteors . . . . .                                                                                     | 67 |
| The Planet Jupiter . . . . .                                                                                | 67 |
| A New Variable Star . . . . .                                                                               | 67 |
| The Observatory for November . . . . .                                                                      | 67 |
| Solar Observations at Catania, Rome, &c. . . . .                                                            | 67 |
| The Stigmata of the Arachnida, as a Clue to their Ancestry. (With Diagram.) By H. M. Bernard . . . . .      | 68 |
| The Present Standpoint of Geography . . . . .                                                               | 69 |
| Some Laboratories of Marine Biology . . . . .                                                               | 70 |
| University and Educational Intelligence . . . . .                                                           | 70 |
| Scientific Serials . . . . .                                                                                | 71 |
| Societies and Academies . . . . .                                                                           | 71 |
| Books, Pamphlets, and Serials Received . . . . .                                                            | 72 |

THURSDAY, NOVEMBER 23, 1893.

## WATSON'S KINETIC THEORY OF GASES.

*A Treatise on the Kinetic Theory of Gases.* By Henry William Watson, D.Sc., F.R.S. Second Edition. (Oxford: at the Clarendon Press, 1893.)

THE rather pointed reference to myself, which Dr. Watson makes at the end of this new edition of his work, seems to call for an answer. Had this call come some five or six years ago, when the questions once again at issue were debated in a somewhat lively way, I should have had little difficulty in rising to it:—but I have in the interval been so busy with questions of a totally different nature that I am taken at a disadvantage, especially as I cannot at present find time to read up again the discussions of that period. I remember enough about them, however, to make the very positive assertion that the questions then raised turned on points of logic, relevancy, and consistency, much more than upon physical ideas or mathematical processes; and a perusal of Dr. Watson's volume shows me that he has reproduced from Boltzmann and others much of what I then objected to. I believe that I gave, in 1886 (*Trans. R.S.E.* vol. xxxiii.), the first (and possibly even now the sole) thoroughly legitimate, and at least approximately complete, demonstration of what is known as Clerk-Maxwell's Theorem, relating to the ultimate partition of energy between or among two or more sets of hard, smooth, and perfectly elastic spherical particles. And I then pointed out, in considerable detail, the logical deficiencies or contradictions which vitiated Maxwell's own proof of 1859, as well as those involved in the mode of demonstration which he subsequently adopted from Boltzmann. Dr. Boltzmann entered, at the time, on an elaborate defence of his position; but he did not, in my opinion, satisfactorily dispose of the objections I had raised. Of course I am fully aware how very much easier it is for one to discover flaws in another man's logic than in his own, and how unprepared he usually is to acknowledge his own defects of logic even when they are pointed out to him. But the only attacks which, so far as I know, have been made on my investigation, were easily shown to be due to misconception of some of the terms or processes employed.

Dr. Watson's little work has been for many years the recognized text-book on the kinetic theory of gases:—and there can be no doubt that, considered in the fierce light of the Examination Hall, it is well adapted to the wants alike of actual Moderators and of would-be Wranglers. It is so framed as to be easily dissected into compact and thoroughly self-contained pieces of book-work:—from "easy" up to "rather stiff":—and, were these to be answered at all nearly in the words and formulæ of the text, few Examiners would venture to refuse full marks. From this point of view nothing more could be desired; for incorrect historical notices, such as the ascription of the origin of the theory to J. Bernouilli (properly D. Bernoulli) instead of R. Hooke, will injure no man's place in the *Tripes*. The purely mathematical part, mainly a series of exercises in the transformation (by functional determinants) of differential elements from one system of variables to another,

though elegant enough, presents an aspect of sameness. *Toujours perdrix!* To this point we will recur.

Considered as a scientific treatise, however, and as practically the only one in Britain which deals at all fully with the subject, the work is not quite so deserving of commendation. Much of course has, in all cases, to be allowed for the almost necessary defects of a book which deals in any way with questions of probability. It has been the good fortune of but a very few, even among the most gifted of mathematicians, to be able to thread their way in safety through the countless traps and pitfalls which lurk unnoticed, often undiscoverable till they have done their worst, in every part of every region of this fascinating domain:—not, as in other subjects, in the partially explored nooks and crannies alone. But probability is only one application of logic:—and, in the passages we most object to, it is in general ordinary logic which we think is somewhat lightly treated. We do not require to go far in search of an example.

At the very commencement of the work, while dealing with Maxwell's well-known result for the permanent distribution of velocities among a number of equal, smooth, spherical particles, Dr. Watson says:—

"We assume that in the permanent state the distribution of the spheres throughout the space occupied by them is homogeneous in all respects; that is to say, on an average of any long time there are the same number of spheres in a given volume wherever that volume may be situated, and the law of distribution of velocities is the same throughout that volume as in the whole region under consideration."

On this statement we would remark that it is rather vague and incomplete:—for surely it is meant that the distribution is isotropic as well as homogeneous; and the word "long" has absolutely no meaning until the time-unit is assigned. Dr. Watson then proceeds to investigate the circumstances of an individual (but typical) collision. Here, however, logic steps in, and says:—"Halt! You have already *assumed* all that you need learn from collisions, so far at least as concerns the solution of the problem before you." In fact the assumption, read as above, leads at once to Maxwell's Law, by the very process which its discoverer first employed; a process depending on principles freely used throughout the text of this book. When Dr. Watson has found the state of motion (F), of two spheres after collision, in terms of the state (E) before it, he proceeds thus:—

"For permanence of distribution . . . it is sufficient that the number of collisions of pairs of spheres in state E during the time  $dt$  should be equal to the number of collisions of pairs in the state F during the same time."

This leads, of course, to Maxwell's result. But it is not hypercritical to ask whether the above-mentioned requirement is not merely "sufficient" but *much more than sufficient*:—so exacting, in fact, as to be absolutely unattainable. Note the consequences of it. From the very nature of the data, the whole motion in the present case is strictly *reversible*, so as exactly to retrace its entire history. But, if we were to reverse it, we should still have the "permanent" state:—*i.e.* one which could never have been otherwise than as it is! This principle of reversion underlies a great part of the theory; and a mere reference to it would, in many of the later pages of

the book usefully take the place of a multitude of imposing but superfluous symbols.

Another notable point in the investigation, to which attention should be drawn, is the mode of obtaining the expression for the probability of collision. This is given as proportional to the component of the relative speed along the line of centres at impact; and *not* to the relative speed itself, though this is *proved* to be the case in § 5. The final result, however, is rendered correct by means of a compensating error in the specification of the element of space really involved. This procedure cannot fail to bewilder a thoughtful reader.

All these remarks, it is to be observed, are made on the very first proposition in the work:—the “green tree,” as it were! What might not be expected in the “dry”; *i.e.* the demonstration of Boltzmann’s Theorem, to which the book gradually leads up? But I must not now recapitulate the objections which I made (about 1886-8) to Boltzmann’s methods, nor the modes in which he defended them. Those who are curious about the matter may be referred to the *Phil. Mag.* for that period. All I need here say is that I do not think that Dr. Watson’s book meets any of my objections.

From the experimental point of view, the first great objection to Boltzmann’s Theorem is furnished by the measured specific heats of gases; and Dr. Watson’s concluding paragraphs are devoted to an attempt to explain away the formidable apparent inconsistency between theory and experiment. In particular he refers to a little calculation, which I made in 1886 to show the grounds for our confidence in the elementary principles of the theory. This was subsequently verified by Natanson (*Wied. Ann.* 1888) and Burbury (*Phil. Trans.* 1892). Its main feature is its pointing out the absolutely astounding rapidity with which the average amounts of energy per particle in each of two sets of spheres in a uniform mixture approach to equality in consequence of mutual impacts. Thus it placed in a very clear light the difficulty of accepting Boltzmann’s Theorem, if the degrees of freedom of a complex molecule at all resemble those of an ordinary dynamical system. P. G. TAIT.

#### A HISTORY OF CRUSTACEA.

*A History of Crustacea. Recent Malacostraca.* By the Rev. Thomas R. R. Stebbing, M.A. With numerous illustrations. (The International Scientific Series, Vol. lxxiv.) (London: Kegan Paul, Trench, Trübner, and Co., Ltd., 1893.)

“THE ambition of this volume,” writes the author in his preface, “is that it shall be one to which beginners in the subject will naturally have recourse, and one which experienced observers may willingly keep at hand for refreshment of the memory and ready reference.” A most laudable ambition, and one that the author, we doubt not, set out with an intention to fulfil. The want of a volume of this very sort upon this subject had been often felt by both the student and the expert. The advance in our knowledge of the group had made it impossible to annotate effectively that model “History of the Crustacea,” written by Milne Edwards, and Mr. Stebbing’s painstaking, excellent memoir on the Amphipods of the

*Challenger* Expedition had pointed him out as a possible author of a useful manual. To write, however, a useful manual or history requires that one should take a wide and all-sided view of the subject, so as to secure a fair symmetry in its treatment; once the amount of detail to be given has been determined upon it should be rigidly adhered to, and, needless almost to add, no useless or unnecessary matter should be allowed to obtrude itself. Therefore, to a knowledge of the subject there must be added certain powers of judgment, to which it would be well to join certain gifts of style, in order that a satisfactory result might be obtained.

None will deny to the author of this history of Crustacea a knowledge of his subject, and the immense amount of facts that he has condensed into the four hundred small pages of this volume will astonish those who peruse it. But for all this there is abundant evidence that it was begun without any sort of judicious calculation as to its scope, and the reader will be as sorry on the discovery as we fancy its author was, that the dire necessity of space has made what purports to be a history of the Crustacea into only a manual of the Malacostraca, and not even a complete manual of this sub-class, for at page 436 we read: “To complete the sketch of the Malacostraca, the sub-order of the Amphipoda *remains to be described.*” Chapters describing this sub-order had been written, when it appeared they overflowed the utmost space that could be allowed, and with this statement the “History of the Crustacea” ends. Our sympathies are with the author, for might we not have expected something excellent about a sub-order that he had made so peculiarly his own, and had we not a right to expect, after reading the first fifty pages, some information about the vast swarms of Entomostraca and Cirripedia. Apparently it was all ready, but the author was met with a “to so far you may print, and not a page further.” The promises of what may be in the future seem too uncertain to depend upon.

Having thus expressed our disappointment about what we have not been given, we proceed to record our opinions as to what the publishers have allowed. The volume opens with an introduction of some fifty pages, which treats of the classification of the Crustacea in outline, giving us brief details of the sub-classes and orders, notes on the geographical distribution, hints as to collecting, statements about size and description of the segments and their appendages. This is followed by a table of the sub-classes, orders and sub-orders, and the account of the Malacostraca, as far as the end of the Isopoda. The plan adopted is to give a short diagnosis of the orders and sub-orders, the tribes and families; under these last, the principal genera and some of the more important species are given.

While dates are appended to the genera, and the names of the describers are given, yet there are only in two or three instances any indications as to where the descriptions are to be found. It would have added much to the value of the work had it been possible to have given these, but of course it would have added (whatever scheme was adopted) very greatly to the amount of the text. Possibly a little more information of this sort might have been squeezed in had the pen been struck through a number of useless sentences which rather

detract from the scientific aspect of the volume; such as the statement of the views of the "very intelligent student" on the subject of the eyes of the shrimp (p. 225); the suggestion that the "Sea-devil" of the Mediterranean might well be the "great fish" referred to in the Book of Jonah (p. 222); the criticism on Spence Bate's description of *Parathanas immaturus*, apparently only given to afford the opportunity of quoting an ungallant saying about women (p. 233), and several such like; or we could have been spared three pages about *Birgos latro*, or the half-page of a justification for giving Hansen's most excellent synoptic table of the Cymothoid group. Indeed, the author's desire not to make this manual a "dry and repulsive catalogue" has made him write a number of sentences which the seriously-minded reader will find it better to pass over with a very cursory eye. To conclude all we have to say on this aspect of the volume, we have strong objections to urge to the page headings, as being an attempt not to help but to confuse. Possibly the author may not be accountable for these; they have often so little to do with the subject of the matter in the pages, that it is not unlikely that they were selected by some one as ignorant of the subject as of good taste; as examples we quote the following: "The tail unique," "A box of branchiæ," "An affectionate squeeze," "Perils of baby-farming," "Looking like a buffoon," "How genera are generated," and many such like.

With all these little defects, which might so easily have been avoided, this volume will be indispensable to the student of this class of Arthropods; it brings together in an intelligible form an immense mass of literature. In some of the orders most complete lists of genera and species are given, notably among the Isopods. Those species interesting either for their morphological, geographical, or bathymetrical distribution, are invariably mentioned, and so far as we can judge, all the British species are named. Most useful will this volume, compact in size and well-packed with information, be to collectors. There is at present no one work that can compete with it. Perhaps the day may come when our great National Museum may publish a revised list of all known Crustacea, as they have done of the fishes, reptiles, and birds; till then Mr. Stebbing's volume will not lose its value, a value that would be greatly increased should a companion volume be published giving the history of the remainder of this interesting group. The work is embellished by nineteen plates and thirty-two illustrations in the text.

#### OUR BOOK SHELF.

*An Elementary Treatise on the Geometry of Conics.* By A. Mukhopadhyay. (London: Macmillan, 1893.)

THIS work is well adapted for junior students. It treats of the principal properties of the curves, and may well be read after a pupil has mastered his six books of Euclid. The starting point is from the focus and directrix definition, and no modern methods (as projections) are employed, nor are the curves shown to be obtainable from plane sections of the cone. Each curve has a chapter allotted to its discussion, which is conducted, as far as possible, on uniform lines. To the parabola are

assigned twenty-five propositions, to the ellipse thirty-five propositions, and to the hyperbola thirty-seven propositions, with an additional five for the rectangular form. The order of treatment is mechanical description, chord properties, and then tangent properties. The proofs should be readily mastered by a boy who knows his Euclid, for they are clearly and simply put, and the author does not assume the truth of a converse proposition, as we have noticed some writers do. Mr. Mukhopadhyay has read far and wide in his subject, and has brought together in his 800 exercises a large collection of the most interesting problems. Many of these he accompanies with full solutions, and to very many more he furnishes suggestive hints. The figures are white on a black ground. The book appears to be very correctly printed; at any rate, we have detected very few (easily corrected) misprints. The book appeals successfully to a larger public than the students of the Indian colleges.

*The Geometrical Properties of the Sphere.* (Univ. Coll. Tutorial Series.) By William Briggs and T. W. Edmondson. (London: W. B. Clive, 1893.)

IN these fifty pages the authors have brought together most of the chief geometrical properties of the sphere, intending the book to be used as a companion to their larger one, on mensuration of the simpler figures, by students preparing for the intermediate examinations in Arts and in Science of the University of London. The three chapters into which the subject is divided lead the reader from the elementary definitions relating to great and small circles, poles, lunes, &c., through the numerous geometrical properties of spherical triangles and their antipodal triangles, polar triangles, supplemental triangles, and finally to the determination of the area of lunes, spherical triangles, spherical polygons, and the spherical excess. The definitions and theorems are expressed quite clearly throughout, while the figures leave nothing to be desired. As an introduction to works on spherical trigonometry, students will find this book a most helpful guide. Two minor slips in construction will be found: one on page 6, line 6, where for CT read TC; and the other on page 18, line 9, where for *oa* and *ob* read *ao* and *bo*.

*A Key to Carroll's Geometry.* By J. Carroll. (London: Buns and Oates, Ltd., 1893.)

THIS key contains the solutions of the exercises in orthographic projection and solid geometry, which are given in the author's book on geometry. The solutions seem to have been thoroughly and carefully worked out. The figures are generally drawn to full scale, but sometimes half-scale has been employed. Lines of projection are clearly indicated—an important factor in some of the more complicated figures. The key should prove a help to beginners, who should study well the questions and their accompanying figures.

#### LETTERS TO THE EDITOR.

[The Editor does not hold himself responsible for opinions expressed by his correspondents. Neither can he undertake to return, or to correspond with the writers of, rejected manuscripts intended for this or any other part of NATURE. No notice is taken of anonymous communications.]

"Geology in Nubibus."—A Reply to Dr. Wallace and Mr. LaTouche.

DR. WALLACE has taught us a great deal, and among those lessons is the supreme virtue in scientific controversy of courage and candour. He must forgive me therefore for answering promptly, and I hope frankly, his last letter in NATURE. In this letter he appeals from your columns to a non-scientific

magazine in which he is writing, and where, like the sermon from the pulpit, what is said cannot be answered. This appeal is not to my taste, for I agree with the late Lord Tweeddale, that truth is never so free from difficulty as when the good grain has been thrashed out by the flails of controversy.

The position we are fighting about is too important, however, to go by default, for upon it rests a vast deal of induction in other fields besides geology.

My contention is, and I am speaking to every man of science, geologist or otherwise, that before Dr. Wallace can appeal to ice as the excavator of lake basins on level, or nearly level, plains far away from the slopes where glaciers grow, he must establish two postulates. (1) That ice can convey thrust for more than a very moderate distance. (2) That glaciers such as we can examine and report upon are anywhere at this moment doing the excavating work which he postulates. Without these postulates, his appeal to ice seems to me absolutely outside science altogether, and to be a mere resort to some *Deus ex machina*, such as the mediæval schoolmen based their reasoning upon.

In regard to the first postulate the experimental evidence seems to me to be conclusive, and I have quoted it in my work on the glacial nightmare. Mallet, writing on the modulus of ice, says: "A few experiments have been made which show that the height of this modulus cannot exceed a few hundred feet." "Let it be assumed, however, that it is as great as 5000 feet, or a mile. It is then obvious that a mass of ice, no matter how deep or wide, lying in a straight, smooth, frictionless valley, cannot be pushed along by any extraneous force, in the line of the valley, through a distance of more than a single mile, for at that point the ice itself must crush, and the direct force cease to be transmitted further. This, of course, is far from being the whole of the question of the transmission of force through ice, for when and wherever crushing takes place, a certain portion (though a small one) of the direct pressure is transmitted laterally by the crushed fragments, especially if mixed with water. For this to take place however, in the direction of the length of the ice-filled valley, supposes the ice must be considerably more than a mile in vertical depth." Mr. Oldham has carried the question further, and I have quoted his arguments and experiments on pages 596-597 of my book. His conclusion, after postulating a quite transcendent modulus, as tested by observation, is: "The greatest distance to which a glacier could be forced *en masse* is about five miles, so that a glacier debouching on a plain could not exert any erosive power on that plain for more than five miles from the commencement of its level course, and consequently could not scoop out a lake basin of more than that length, whatever its depth might be."

Not only does this conclusion involve the postulating of quite an impossible modulus for ice, but it also supposes that the whole thrust of the ice coming down a slope is available, which it clearly is not. A great deal of this thrust, as Mr. Irving has shown, is expended in overcoming cohesion, in causing the differential motion of a glacier, in forming crevasses which largely intercept the thrust, and in causing the well-known Bergschrund. To quote my own words, "a considerable amount of the force of the gravity contained in a glacier is used up within the glacier itself, and is not available either to give it a forward thrust along a horizontal surface, or for eroding purposes."

So far as I know, this is a perfectly candid statement of the available evidence. Regelation has nothing whatever to do with it. Directly ice crushes, the thrust is dissipated, the greater part of it passing off in the direction of least resistance. To me the case seems conclusive, but, says Dr. Wallace: "All this is beside the question from my point of view. The work of the ice on the rocks is as clear as that of palæolithic man on the flints . . . and there is clear evidence that ice *did* march a hundred miles, mostly uphill, from the head of Lake Geneva to Soleure, whatever transcendental qualities it must have possessed to do so."

This form of dogmatic argument is assuredly incomprehensible. I wonder Dr. Wallace is not afraid of the ghosts of his own recent emphatic pronouncement on the glaciation of Brazil, which he has now entirely abandoned, namely: "If the whole series of phenomena here alluded to have been produced without the aid of ice, we must lose all confidence in the method of reasoning from similar effects to similar causes which is the very foundation of modern geology."

No, true geology is not founded upon hypotheses outside

the laws of nature; its secrets, when properly read, must be consistent with those laws. Nor can the geologist who hopes to see his work live, base his reasoning upon a peculiar scheme of mechanics which experiment refuses to verify.

If glaciers travelled further in former days, it was doubtless because glaciers were larger in former days, because they descended longer slopes, and had larger gathering grounds; that is to say, because the country where they grew was more elevated. All this I, of course, admit was the case. That ice could travel then any more than it can travel now over a considerable distance of level ground, or excavate hollows in its track, by virtue of the *vis a tergo* given it in its sloping cradle, is, it seems to me, a subjective dream, and not an empirical conclusion.

So much for the first postulate necessary to establish Dr. Wallace's conclusion. In regard to the second, I have little to say. Glaciers exist in many countries. In some they have retreated in historical times; in others, we can travel underneath them for some distance. I know of no case, under any conditions, where it can be shown that they have excavated rock basins, small or big. If Dr. Wallace can quote any, it would be an important addition to the case he makes. I must therefore conclude that, so far as our evidence goes, ice cannot excavate lake basins on level plains, and that it is contrary to the laws of the mechanics that it should do so.

Dr. Wallace says, "No glacialist of the extremest school would claim the rock basins of Bahia as proofs of glaciation." This is an extraordinary statement. Why, the report on these basins made by Mr. Allen, and incorporated by Hartt, was among the most powerful pieces of evidence adduced by the latter for the former glaciation of Brazil, which evidence Dr. Wallace urged upon us a short time ago was completely unanswerable. Lastly, in regard to Tasmania I do not quite follow him. He says, "No doubt the conclusions of the various writers will be fully harmonised by a more complete study of the whole subject." They are harmonised already. *They all agree* that on the plateaus and in the central district of Tasmania, where the lakes abound, there are no traces of glaciation. So far as I know, the only person who disputes it is Dr. Wallace himself, who has never been there. What needs to be harmonised is his theory with the facts as observed by all observers.

I have replied at some length to Dr. Wallace's letter, not only because I consider the issue a most critical one, but also because of the distinction of its writer, who on so many questions has taught us lasting lessons, but who on this one seems determined to set himself against the general conclusions of those geologists who have most closely and laboriously studied ice at work.

I must now turn to Mr. LaTouche, whose courteous criticism of my views appeared in a previous number of NATURE. I am not quite sure how far we differ, for he apparently repudiates the theory favoured by Ramsay and by Dr. Wallace, that the great Alpine and Scotch lakes were excavated by glaciers. He limits himself to certain rock basins in highly glaciated regions. In regard to these having been excavated by ice, Mr. LaTouche reminds me that ice is a viscous body, and moves, as Principal Forbes argued that it does, almost entirely as a viscous body. If Mr. LaTouche had favoured me by looking into my last book, he would have found a long and very laborious chapter devoted to establishing this very conclusion, but I do not see how it assists his position. A viscous body, unless the viscosity approaches that of a liquid, cannot move by mere hydrostatic pressure, since the internal friction and the resistance and mutual support of its particles prevent it. The viscosity of ice is very slight indeed, hence we cannot postulate for the nether layers of a glacier with an uneven surface the movements we should postulate in a liquid under the same conditions. With the forces known to be requisite to make it shear, it seems to me that ice cannot be supposed to move by hydrostatic pressure.

Its actual motion is due almost entirely to its layers rolling over each other as they do in pitch and other viscous bodies. Now this movement in thick ice we know is appreciable at the surface, but the same conditions of friction and of drag, already quoted, retard each successive layer as we go down, until when we reach the lowest layers the motion due to viscosity is exceedingly slight if it is even appreciable. Hence I cannot see where the mechanical agent is to come from to excavate basins, and how it is to work.

When ice is moving on a slope, and the viscous movement is helped by gravity, then no doubt the ice-foot shod with stones becomes a tolerable *eroding* agent; but I cannot under-



stand under what conditions it can become an excavating one, and how it can hollow out basins, &c.

When ice moves away from the slope which gives impetus to a glacier, the motion rapidly slackens and presently stops. The distance travelled over the level ground is a function of the weight of the glacier, of the amount of the slope, the friction of its bed, &c., *i.e.* of the elements making up the *vis a tergo*; but in the very largest glaciers, so far as observation goes, the motion rapidly ceases on level ground. This is the evidence wherever the phenomenon has been observed and reported upon.

This being so, I altogether question not only the arguments of those who champion the excavation of lake basins by ice, but also of that larger school who invoke movements of ice over level plains of many hundreds of miles in extent in order to explain the drift phenomena. They do it, so far as I know, on the ground that they cannot appeal to any other cause without doing injustice to that modern metaphysical bogey, "The Doctrine of Uniformity." My small boy might just as well, on the same principle, attribute the excavation of his porringer to the porridge in the bowl. True rock basins were no doubt very largely due to the weathering of rocks which exfoliate, and whose structure is not homogeneous. This is a very old explanation, but like many sober old inductive truths it is not so attractive nowadays as an appeal to the imagination, combined with a good, sturdy, consistent loyalty to some *à priori* postulate, which would have won the hearts of the old schoolmen.

HENRY H. HOWORTH.

30 Collingham Place, Cromwell Road, November 16.

### Rock Basins in the Himalayas.

THERE is one statement in the interesting communication of my colleague, Mr. T. D. LaTouche, which seems to require qualification. After a tolerably extensive experience of the Himalayas, I should be inclined to say that rock basins are of fairly frequent occurrence, of all sizes from the largest to the smallest, but they are almost without exception filled with stream deposits, and only occasionally can their formation have been due to glaciers; for they are usually found where there are no traces of glacial action to be seen, and at levels to which we have no reason to suppose that glaciers ever reached. In the hills of eastern Baluchistan, where the rainfall is much less than in the Himalayas, rock basins more or less filled by recent surface deposits are even more common, and here their origin by deformation of the surface can generally be established. The same cause probably accounts for the Himalayan rock basins, as there are abundant proofs that the elevatory movement has been far from uniform, and that the variations in its intensity have been both extensive and often extremely local. There are frequent occurrences of surface deposits which appear to have originally been formed in rock basins, but have since been cut into by the streams, owing to the corrosion of the barrier, and we may attribute the absence of lakes in the Himalayas to the rapid current and large burden carried by the streams, in consequence of which they have been able to fill up the basin, and often to corrade the barrier, as fast as it was formed.

R. D. OLDHAM.

### "Composite" Dykes.

PROF. JUDD'S excellent paper in the current issue of the *Quarterly Journal of the Geological Society* (p. 536) calls to my mind some common and similar examples among the "elvans" of Cornwall (which are dykes in the ordinary acceptation of the term), and but little has been published offering some explanation of their bearing on surrounding rocks. I have observed, notably in the district of Cligga Head (nine miles N.W. of Truro), the marked difference between the structures exhibited by dykes in the parts in contact with the rock through which they intrude (in the Cligga instance Devonian slate), and their centre, amounting almost to a rock distinction.

In the appended sketches I have endeavoured to illustrate my meaning from actual instances.

Fig. 1 represents a section of an elvan or dyke outcropping slightly to the north of Cligga promontory, and from its position apparently connected with the main mass of Cligga Head granite. It bursts through the slate. The centre (*b*) of the dyke consists of a rock of homogeneous texture, quartzo-felspathic base, and some scattered porphyritic felspar crystals. The sides (*a a*)

in contact with the slate (*s s*) show a rock of apparently similar base, but shot with long acicular crystals of schorl, the whole rock being of a very dark colour, due probably to the presence of wolfram.

Fig. 2 is a section of a very common form of Cornish elvan, consisting of alternate laminae of granite (*d d*) and "schorl rock," that is, rock consisting of schorl and quartz, generally in about equal proportions (*c c*).

These bands are very common in the slates and in the granitic bosses. Further, an analysis of a typical "schorl rock" of this class showed a silica percentage of 67.6 (*vide* Judd's paper,

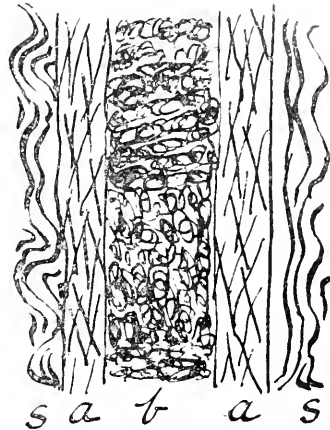

FIG. 1.

p. 545), and of a typical granitic band of 74.8 (De La Beche, "Report on Geology of Cornwall, Devon, and West Somerset," p. 189). It is very doubtful, however, if either of the above instances is a case of a dyke putting on such differences in mineralogical and chemical character in its several parts as to amount to a difference of rock species.

As De La Beche points out, the schorl rock may be simply a granite in which the felspar and mica are replaced by schorl. An instance, however, of a rock one may call "a dyke within a dyke" is the Cligga mass itself, which is nothing but a gigantic dyke. De La Beche, in his work above cited (p. 164), has figured it. The dyke is so strikingly split into layers as to

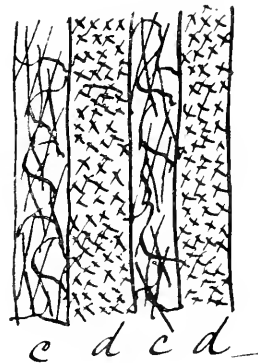

FIG. 2.

appear stratified, the hard comparatively small-grained layers standing out in bold relief from the contiguous layers of more easily decomposed rock with their large porphyritic felspar crystals.

Besides the difference in size of the felspar crystals, the harder rock is much darker in colour (being of a red hue) than the softer, which is pale pink and in places whitish. These physical differences, however, count for little in drawing a distinction of rock species between the layers, and I was unfortunately unable to avail myself of any published analyses of the different parts, but their superficial characters are so distinct as

to render the stratified appearance of the rock very marked at comparatively great distances from them.

There is in many cases a crack marking the junction of contiguous layers.

As an illustration of these "composite" dykes, I append a diagrammatic sketch representing a section of the coast about 200 or 300 yards south of the Cligga promontory, which is very difficult of approach.

*A* has all the appearance of a bed of sandstone, the strata curved, owing to the intrusion of the dyke *B* (granitic); *C* is an

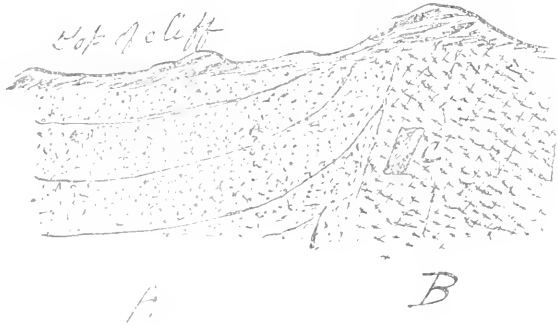

FIG. 5.

old tin burrow. As a matter of fact, each is a granitic dyke, *A* finer grained than *B*, and very like sandstone in all petrological features.

The remarkable fact is the apparent stratification of the beds *A*, which are really bands of several dykes—a continuation of those figured at p. 164 in De La Beche's book. He does not seem to have observed this instance, or at any rate does not mention it; his figure is from the cliff immediately in contact with the Cligga promontory, and north of that I have figured.

Further instances of this very interesting kind of composite dyke would help in many cases to unravel the seeming complexity of such geological features as those I have touched upon in Cornwall.

HENRY E. EDE.

45 Walker Terrace, Gate-head-on-Tyne, October 4.

### Weismannism.

I NEVER answer reviews, save in so far as they may be misleading on matters of fact. As this is the case with "P. C. M.'s" notice of my "Examination of Weismannism" (*NATURE*, November 16), I should like to say a few words touching the more important of such matters.

It seems that in seeking to do justice to all sides in the heredity question, I have been too careless in expressing my own view. At all events, any one reading the review must gather from it that I am a Lamarckian engaged in fighting the theories of Prof. Weismann. In the book, however, it is stated that I have been an adherent of the theory of Sturp ever since it was published by Mr. Galton in 1875. It is also stated that this theory is, in my opinion, identical, as regards all main principles, with that of Complanism in the present phase of its numerous metamorphoses. Therefore, far from fighting the Weismannian theory of heredity, I see in all its main features, as it now stands, a "republication" of the one which I have held for close upon twenty years.

It is further stated that the only points of much secondary importance wherein I can perceive the two theories to differ are, (*a*), that while Galton confined himself to publishing a theory of Heredity, Weismann proceeded to rear upon this basis (*i.e.*, the hypothesis of "continuity"), a further and elaborate theory of organic evolution; and (*b*), that Weismann has not gone so far as Galton did in expressly recognising the possibility of an occasional transmission of acquired characters, in faint though presumably accumulative degrees. As regards these two points of difference, I have endeavoured to show, (*a*), that Weismann has now himself withdrawn nearly all his previous generalisations with regard to organic evolution, while largely modifying his theory of Heredity; and, (*b*), that he has only to expand certain hints which he has already given—and which, if expanded, would entail much less modification of his original system than those which he has now made in other parts thereof—in order as

fully to recognise as Galton did the possibly occasional transmission of acquired characters.

Hence, such opposition as I have found any reason to express with regard to Weismann's system in the late phase of its development arises, almost exclusively, against the inordinately speculative character of his method. The history of science furnishes no approach to such a disproportion between deduction and induction.

Thus it seems to me that any writer on Weismannism who aims at impartiality must fail in his aim, if he does not give due prominence to this the most distinctive feature of Weismann's method. And, unless the reviewer is prepared to defend such a method as scientific, he has no reason to quarrel with what he calls my "hard words," since they all have reference to it, and are statements, not of opinions, but of facts.

On the other hand, I have endeavoured by "soft words" to fully recognise the great merit of Weismann's work in constituting the heredity question one of world-wide interest. And any bias that I may have with regard to this question is assuredly on the side of "continuity," although I cannot hold that the subordinate question is closed—*i.e.*, as to whether such continuity can never, under any circumstances or in any degrees, be interrupted.

GEORGE J. ROMANES.

Hyères, November 20.

### Correlation of Solar and Magnetic Phenomena.

MR. ELLIS, in his letter (*NATURE* November 9), has discussed the coincidence between Carrington's observation of a solar outburst in 1859 and the magnetic movements observed at Kew and Greenwich. He comes to the conclusion that the disturbance of the magnets corresponding to this outburst was small, and that, although many greater magnetic movements have occurred since, no corresponding manifestation has been seen, although the sun has been so closely watched.

He appears to have overlooked an observation made at Sherman, by Prof. Young, which shows a very striking series of coincidences, and which is described in his work, "The Sun" (p. 156), in the following words:—"On August 3, 1872, the chromosphere in the neighbourhood of a sun-spot, which was just coming into view around the edge of the sun, was greatly disturbed on several occasions during the forenoon. Jets of luminous matter of intense brilliance were projected, and the dark lines of the spectrum were reversed by hundreds for a few minutes at a time. There were three especially notable paroxysms at 8.45, 10.30, and 11.50 a.m., local time. At dinner the photographer of the party, who was making our magnetic observations, told me, before knowing anything about what I had been observing, that he had been obliged to give up work, his magnet having swung clear off the scale. Two days later the spot had come round the edge of the limb. On the morning of August 5, I began observations at 6.40, and for about an hour witnessed some of the most remarkable phenomena I have ever seen. The hydrogen lines, with many others, were brilliantly reversed in the spectrum of the nucleus, and at one point in the penumbra the C line sent out what looked like a blowpipe jet, projecting toward the upper end of the spectrum, and indicating a motion along the line of sight of about 120 miles per second. The motion would die out and be renewed again at intervals of a minute or two. . . . The disturbance ceased before eight o'clock, and was not renewed that forenoon. On writing to England, I received from Greenwich and Stonyhurst, through the kindness of Sir G. B. Airy and Rev. S. J. Perry, copies of the photographic magnetic records for those two days. . . . On August 3, which was a day of general magnetic disturbance, the paroxysms I noticed at Sherman were accompanied by peculiar twitches of the magnet in England. Again, August 5 was a quiet day, magnetically speaking, but just during that hour, when the sun-spot was active, the magnet shivered and trembled. So far as appears, too, the magnetic action of the sun was instantaneous. After making allowance for longitude, the magnetic disturbance in England was strictly simultaneous, so far as can be judged, with the spectroscopic disturbance seen on the Rocky Mountains."

These observations of Prof. Young seem to invalidate Mr. Ellis's statement that "no second occurrence similar to that of 1859 has come to light," and that although there undoubtedly exists a relation between sun-spots and magnetism, "it has not yet been found possible to trace direct correspondence in details."

Cambridge, November 12.

A. R. HUXKS.

THE circumstances spoken of by Prof. Young, as alluded to in the accompanying letter, tell of special solar activity at the time of magnetic disturbance, observed solar paroxysms occurring apparently in correspondence with magnetic movements; but the question whether definite connection exists, is the really critical point, as in the Carrington observation of 1859. Prof. Young himself says ("The Sun," p. 159):—"So far as appears, the magnetic action of the sun was instantaneous. After making allowance for longitude, the magnetic disturbance in England was strictly simultaneous, so far as can be judged, with the spectroscopic disturbance seen on the Rocky Mountains." (The italics are mine.) Without being over-critical, it may be remarked that the terms "instantaneous" and "strictly simultaneous" are somewhat strong, in the circumstances of the case.

Feeling that too much importance had been by various writers attached to the Carrington observation, I may have been led to the expression of a too pronounced opinion thereon. Rather it might be said that direct connection is not proved. It is to be remembered that the cases of recorded occurrence together of solar and magnetic phenomena are few, whilst solar change (such as is sometimes actually observed, or as is remarked in the changed solar appearance from day to day) without magnetic action, and very frequently magnetic action without recorded solar change, both occur in greater degree than, on the supposition of direct connection between the two classes of phenomena, would be expected. Prof. Young, indeed, further says:—"No two or three coincidences such as have been adduced are sufficient to establish the doctrine of the sun's immediate magnetic action upon the earth, but they make it so far probable as to warrant a careful investigation of the matter—an investigation, however, which is not easy, since it implies a practically continuous watch of the solar surface." One main difficulty is here pointed out. Continuous magnetic registration is easily maintained, but how far the observation of solar change is adequate (in spite of the numbers of observers) for the purposes of such an inquiry is possibly somewhat doubtful. The problem of a sufficiently comprehensive and satisfactory comparison of the irregularities in solar and magnetic changes is evidently one of very considerable difficulty.

Greenwich, November 14.

WILLIAM ELLIS.

#### Artificial Amœbæ and Protoplasm.

I REVIEWED in NATURE, No. 1251, Prof. Bütschli's recently published work "Mikroskopische Schäume und das Protoplasma." The book is distinctly polemical, and on pages 5 and 6 the author refers to his own, and his colleague Prof. Quincke's work, and states his indebtedness to the latter's investigation upon physical emulsions, but accuses him of having adopted his own view as to the structure of protoplasm, and that without acknowledgment.

"Ich habe Herrn Collegen Quincke, bevor er seine Hypothese der Plasma-bewegungen veröffentlichte, mehrfach meine Ansicht über die wahrscheinliche Structur dieser Substanz gesprächsweise mitgeteilt und betont, dass gewisse Eigenschaften des Plasmas wohl mit dieser Bau-irect zusammenhängen dürften. Quincke hat in seiner Mittheilung von 1888 das Plasma noch als einfache Flüssigkeit behandelt, von einer Schaumstructur des-ellen nirgends gesprochen; wenn er später (1889), nach Veröffentlichung meines ersten Berichtes (1889) die Schaumstructur betont, so kann ich darin nur den Einfluss meiner Erfahrungen erkennen, auch wenn er derselben in dieser Publication, welche über das Plasma und seine Bewegungser-scheinungen handelt, nirgends gedenkt."

(*Trans.*)—In the course of conversation, and before he published his hypothesis of protoplasmic movement, I frequently mentioned my view as to the probable structure of this substance to my colleague Quincke, and I emphasised the probability of a direct relation between certain properties of the plasma and this structure. In his note of 1888 Quincke still treated the plasma as a simple fluid, and nowhere made mention of the foam-like structure. When, later on, in 1889, after the publication of my first report, he emphasises the foam structure, I cannot but recognise the influence of my own experiences, though he makes no mention of them in this publication, which treats of the plasma and of the phenomena of its movement.

In NATURE, No. 1253, a letter appeared from Prof. Quincke, stating that he "was the first to point to the foamy nature of protoplasm, which was later on further investigated by Prof. Bütschli."

Prof. Quincke is evidently annoyed that his prior claim to the discovery, if discovered it be, was not made clear by me in the review. But my duty as a reviewer was with Prof. Bütschli, whose views as to the foamy nature of protoplasm I sketched to the best of my ability, and I ventured to criticise them adversely. If Prof. Bütschli was not the first to describe the foamy nature of protoplasm, and if he was anticipated by Prof. Quincke, then it is the latter's duty, not mine, to make this clear. I could not possibly be expected to deal with such a controversy in a review, for such an extended historical inquiry as this would imply, would hardly have found acceptance.

As Prof. Bütschli distinctly states that before 1889 Prof. Quincke looked upon protoplasm as a simple fluid, the latter, in order to establish his position, has only to send definite quotations from one of his publications prior to this date, in which it is clear that the foamy nature of protoplasm was described by him.

I scarcely think that Prof. Quincke can himself have read my review, for had he done so he would hardly have accused me of slighting his well-known and valued scientific work. Prof. Quincke charges me with calling "his investigations" "toys for the physicist." I never referred to him at all in this connection, but spoke definitely of the preparations of foam as manufactured by Prof. Bütschli. I moreover would point out to Prof. Quincke that we cannot compare an "investigation" with a "toy," for one is an *action*, the other a *thing*.

I regret exceedingly that the "Q" in Prof. Quincke's name appeared as "N," and take to myself the sole responsibility. I write the capital "Q" not unlike an "N," and omitted to notice the mistake in the proofs. JOHN BERRY HAYCRAFT.

Physiological Laboratory, University College, Cardiff.

#### THE ROYAL SOCIETY CLUB.

THERE are not many social institutions which can point to an antiquity of a century and a half, and this is what the Royal Society Club was able to celebrate on Thursday, the 16th instant.

The club is almost, if not quite, the oldest club in existence. The Dilettanti Society, which was founded a year earlier, in 1742, is not a club, and has, from the first, imposed a fine on any of its members who should apply that designation to it.

The Royal Society Club was formally inaugurated on October 27, 1743, but its very act of inauguration recognises the existence of a still earlier body. This "Memorandum of Association" is headed as follows: "Rules and Orders to be Observed by the Thursday's Club, called the Royal Philosophers."

We hear of the Virtuoso's Club, meeting on Thursdays, among the clubs of London in 1709, and in the year 1742 the club was described by Hutton as "Dr. Halley's Club." It is possible that the inaugural meeting of October 27, 1743, may have been the reorganisation of the club after Dr. Halley's death in the previous year.

The title of "Royal Philosophers" lasted till 1786, when the dinner bills were charged to "the Royals." The full title Royal Society Club was adopted later.

The history of the club was drawn up in 1860 by Admiral W. H. Smyth, and privately printed, under the title of the "Rise and Progress of the Royal Society Club." Many interesting particulars may be gathered from this compilation.

At the very first, Fellowship of the Society was not a necessary condition of membership of the club, as it now is. Mr. Colebrooke, who was treasurer of the club in 1743, was not elected into the Royal Society till 1755.

The meetings were at first held at the Mitre Tavern in Fleet Street, for forty years from 1743. The club then moved to the "Crown and Anchor" in the Strand, where it remained until 1848, when it went to the Freemasons' Tavern. On the removal of the Society to Burlington House in 1857, the club followed it westwards to the Thatched House Tavern, and subsequently to Willis's Rooms. On the final closing of the last-named

establishment, in 1889, the club migrated to Limmer's Hotel, where it now meets.

As the club grew older, the price of its dinners grew with it, from "one shilling and sixpence, for eating," in 1743, to ten shillings in 1843, at which latter price it has remained ever since. The time of dinner has also changed first from 1 o'clock to 2, and then successively to 3, 4, 4½, 5, 5½, 6, and 6½, the time of serving now.

The bill of fare for the commemorative dinner last Thursday was copied, spelling and all, from the earliest *menu* preserved, that of March 28, 1748, and the price to the members was 1s. 6d., the same as in the earliest days of the club.

The bill of fare was as follows:—

Two dishes Fresh Salmon, Lobster Sauce.  
Cod's Head.  
Pidgeon Pye.  
Calve's Head.  
Bacon and Greens.  
Fillet of Veal.  
Chine of Pork.  
Plumb Pudding.  
Apple Custard.  
Butter and Cheese.

The members are indebted to the managers of Limmer's Hotel for the readiness with which they entered into the project of reproducing a dinner on the ancient model.

As the month was November, salmon was not to be had, so that other fish was substituted. An important addition was made to the *menu*, for a haunch of venison was presented to the club by one of its members.

In early days whole bucks, haunches of venison, turtles, and barons of beef were not unfrequently presented, the donors being in each case elected honorary members for the then current session.

These contributions became rather inconvenient, and on July 29, 1779, it was "resolved that no person in future be admitted a member of this Society in consequence of any present he shall make to it."

The club consists of fifty ordinary members, and this number is increased by *ex officio* members (present or past office-bearers in the Royal Society) and by a few honorary (octogenarian) and supernumerary members, until the total in 1893 has reached sixty-one. Of these forty-four were present on the 16th, with twenty-three guests, making a total of sixty-seven.

From the earliest times each member of the club has had the privilege of bringing one guest with him, the President for the day being not limited to one. This practice of bringing guests has been generally carried out, and a study of the list of visitors given in Admiral Smyth's "History" shows that many of the leaders of European science have at various times entered their names in the club records. Berzelius, Cuvier, Gay-Lussac, Linnæus, and Volta were guests of which any club may justly be proud.

We may also fairly assert, in conclusion, that since the middle of the last century, there are but few names really prominent in British science which do not appear in the list of ordinary members of the Royal Society Club at some time of its existence.

#### THE DE MORGAN MEDAL.<sup>1</sup>

THE duty has this year devolved upon the Council of making the fourth triennial award of the medal which was instituted in memory of our first President, the distinguished logician and mathematician, Augustus De Morgan. In making their award, the Council are not restricted in their choice to mathematicians of this country, or to the recognition of excellence in any

<sup>1</sup> Address to the London Mathematical Society, on the occasion of the presentation of the De Morgan Medal, November 10, 1893, by the President, A. E. Kempe, F.R.S.

particular branch of mathematical science. It will scarcely, however, be imputed to them that they have been influenced by feelings of patriotism rather than by scientific impartiality in having selected as the first three recipients of the medal, Prof. Cayley, Prof. Sylvester, and Lord Rayleigh. The position of those eminent mathematicians suffers no depreciation, if our survey is extended beyond the borders of our own country. On the other hand we shall, I think, be equally exempt from adverse criticism in the choice we have this year made of Felix Klein, Professor of Mathematics in the University of Göttingen, as the next recipient of the honour which we are privileged to confer.

Prof. Klein, who has for many years been enrolled in our books as an honorary member of our Society, has attained the highest distinction as a mathematician. In estimating the value of his work, a mere consideration of the advance due to him in our knowledge of the details of special subjects would be sufficient to place him in the first rank; the wide influence of his work must be apparent to anyone who studies the memoirs of writers, of whatever country, on those subjects to which he has set his hand. Let me in particular refer to his contributions to the geometry of complexes, and to non-Euclidean geometry, to his memoirs on the theory of equations, on the transformation of elliptic functions, on the general theory of functions, especially in exposition and development of Riemann's theory, to his discussion of Riemann's surfaces, and, in more recent times, his researches on Abelian and Hyperelliptic functions, to his treatment of the polyhedral functions, automorphic functions, and of the elliptic Modular functions, the last of which is expounded in the treatise by Fricke on the subject. One must not forget to record the fact that his important memoir on the transformation of elliptic functions in the *Mathematische Annalen*, vol. xiv., was preceded by a communication made to our Society in 1878: Prof. Klein thus doing us the honour of indicating in advance the principal results he had obtained (*Proceedings*, vol. ix. p. 23).

But, in the necessarily brief remarks to which I must limit myself this evening, to indicate Prof. Klein's claims to distinction by dwelling upon individual subjects which he has treated, would, I think, be wanting in perspective and proportion. Great as is the reputation which he has acquired in connection with particular branches of mathematical research, that which would seem to be his especial merit is the comprehensiveness of his view, and the uniformity of his treatment. For him the study of one of his special subjects is the study of all; the binding influence being the theory of discrete groups, a theory he has made his own. With this unity of conception he combines a great power of simple, elegant, and interesting expression. The expositions of his method contained in his early "Comparative Review of Recent Researches in Geometry," and his more recent "Lectures on the Icosahedron," in which the formal identity of investigations apparently the most diverse is made apparent, belong to the romance of mathematics. The important influence which his mode of investigation has had and is destined to have on the progress of the higher mathematics, the encouragement of largeness of view, rather than the elaboration of minutiae, and the stimulating influence he exercises upon pupils who now hold positions of eminence in Germany, must take a foremost place among the grounds upon which we honour Prof. Felix Klein to-day by the award to him of the De Morgan Medal.

#### NOTES.

THE agricultural exhibit of Sir John Lawes and Sir Henry Gilbert at Chicago appears to have been much appreciated by our American cousins. The Association of American Agri-

cultural Colleges and Experiment Stations have passed a special resolution expressing the value they attach to the exhibit, and the Director-General of the Exposition has forwarded the same to England, with the added thanks of the Exposition, for "the great benefit done to American agriculture by this excellent and instructive exhibit."

A PASTEUR Institute has been opened in New York, with Dr. Paul Gibier as its director.

M. O. CALLANDREAU, of the Paris Observatory, has been appointed Professor of Astronomy at the *École Polytechnique*.

DR. TREADWELL has been appointed Professor of Analytical Chemistry in the University of Zurich.

DR. A. K. E. BALDAMUS, known for his work in connection with ornithology, died on October 30, at the age of eighty-two.

MR. J. BAILEY DENTON, whose name has long been known to agriculturists and civil engineers, died on November 19, at Stevenage, Herts, in his seventy-ninth year.

WE regret to announce the death, at the age of eighty-one, of M. Chambrelent, a member of the Rural Economy Section of the Paris Academy of Sciences.

MR. WILLIAM DINNING, of Newcastle, a lover of natural science and a promoter of its interests, died on November 13. Shortly before his death, he offered his collection of fossils from the coal measures to the Newcastle Natural History Society, on the condition that the society would provide cases to properly exhibit it and the collection already existing in the local museum. The society was without the necessary means, but Lord Armstrong has promised to contribute a sum of £1500 for this purpose. Mr. Dinning was an engineer by profession, but all his leisure was devoted to scientific pursuits. His death will be greatly felt in local circles.

It is reported that a severe shock of earthquake was experienced on November 17 in Kashan, Western Asia, a large part of the town being destroyed. Great damage was also done at Samarcand.

MR. LLOYD BOZWARD, Worcester, informs us that on November 17 a fine shower of Leonid meteors was seen throughout the night. The meteors are said to have been so numerous that several persons unacquainted with their nature mistook the display for an exhibition of fireworks.

THE Swiney prize of a cup, value £100, and money to the same amount, to the author of the best published work on jurisprudence, will be awarded by the Society of Arts and the College of Physicians in January next. The prize is awarded every fifth year, the recipient in 1889 being Dr. C. Meymott Tidy, for his work entitled "Legal Medicine."

AT the beginning of next year the first number of an "Index der gesamten chemischen Litteratur" will be published by H. Bechhold, Frankfort. The index will appear monthly, and after the end of each year an index comprising all the papers published during the year in pure and applied chemistry will be issued. The editor of the forthcoming publication is Dr. Julius Ephraim.

MESSRS. W. H. ALLEN AND CO. have in preparation a series of volumes founded upon Jardine's Naturalist's Library. The editor of the series, Dr. Bowdler Sharpe, will undertake several of the ornithological volumes. The authors of other sections are Mr. R. Lydekker (Mammalia), Mr. H. O. Forbes (Mammalia and Birds), Mr. W. R. Ogilvie Grant (Birds), Mr. W. F. Kirby (Insects), Prof. R. H. Traquair, F.R.S. (Fishes). The first volumes will be issued early in 1894, and will consist of British Birds, vol. i., by Dr. R. Bowdler Sharpe; Monkeys,

by H. O. Forbes; and Butterflies (with special reference to British species), by W. F. Kirby.

WE have previously referred to the fact that on the first of this month Italy adopted the time of Central Europe. All the Italian time-tables have, by order of the Minister of Public Works, been printed with the hours marked up to twenty-four from midnight to midnight. The railway clocks have also been modified, and the hours from 13 to 24 printed in red Arabic characters in a circle interior to the old one. It may be well to remember that at the Paris Exhibition in 1867, Sig. G. Jervis, the Keeper of the Royal Industrial Museum of Turin, exhibited a clock face having a double series of hours, the higher numbers being placed on the exterior circle on account of the greater space there available. He also exhibited a time-table drawn up on the 24-hour plan, and possessing many advantages over those in use even at the present time. Mr. Jervis has thus had the satisfaction of seeing the adoption of the improved clock-dial and the 24-hour time-table, proposed by him nearly a third of a century ago.

DURING the past week this country has experienced some of the most destructive, if not the most violent storms that have occurred for some years. The reports received by the Meteorological Office on Thursday morning, the 16th instant, showed that a deep disturbance was approaching our shores, and storm signals were hoisted on our coasts. On the afternoon of that day the storm broke with great violence over the west of Ireland, the direction of the wind being south-easterly with a moderately high temperature, while the barometer was below 29.5 inches. The centre of the storm passed across England and Scotland, taking the ordinary north-easterly course, and by 6 p.m. on Friday it lay off the extreme north-east coast of Scotland, and the barometer had fallen to 28.5 inches; the wind, as usual in the rear of storms, shifted to the north-westward, causing a sudden fall of temperature with heavy snow and hail in many places. At this point the track of the disturbance took a very unusual direction, and during Friday night the centre moved quickly to the south-eastward down the North Sea, and at 8 a.m. on Saturday, the 18th instant, the centre lay off the north-east coast of England, while the pressure rose rapidly over the western portion of the kingdom, causing steeper gradients and bitter northerly and north-easterly winds. The storm first broke over London and the southern parts of the country on Saturday afternoon, and blew in terrific squalls during the whole of Saturday night, the centre again resuming an easterly course across the North Sea to the Dutch and North German coasts. The greatest strength of the wind appears to have been experienced near Holyhead, where the force on Saturday morning was reported as 12 of the Beaufort scale, while force 11 was reported from Wick and Scilly. In the neighbourhood of London the heaviest gusts were experienced in the early part of Saturday evening; the anemometer at Greenwich recorded a pressure of 17 pounds on the square foot at about 6 p.m. On Sunday and Monday the wind force was still high in the south-east of England, as well as in the English Channel, and a very high sea was running on our coasts. The storms were also very violent on the other side of the Channel, and were accompanied by heavy falls of snow in many parts of the Continent.

THE Pilot Chart of the North Atlantic Ocean shows that the first half of October was marked by much bad weather north of latitude 45° between Newfoundland and the British Isles. One of the storms caused immense loss of life and property in Louisiana, owing to a tidal wave encroaching over the low-lying lands. A supplement issued with the chart shows clearly the actual weather conditions between the 23rd and 28th of

August last, west of longitude 50° W. During this period two severe storms occurred; the first struck the coast in the vicinity of New York, where much damage was done to shipping, the second struck the coast near Savannah, and occasioned frightful loss of life along the coasts of South Carolina and Georgia, the barometer falling to 28.29 inches at 6 a.m. on August 28. This was the storm referred to in our issues of 31st August and 7th September.

THE annual meeting of the Royal Geological Society of Cornwall was held at Penzance on November 10, when the president, Mr. Howard Fox, delivered an address, in which he reviewed the past history of the society. In the course of his remarks, he said that the rocks of West Cornwall had been subjected to precisely the same conditions as those of Moffat and Girvan, in South Scotland, described by Prof. Lapworth. They show, in fact, a repetition of the same phenomena, except that as yet no band of fossiliferous rock characteristic of a special geological zone has been discovered as a horizon of reference. It is, therefore, worth consideration whether the radiolarian cherts of Mullion Island, described in the *Quarterly Journal of the Geological Society* for this year, will not answer the same purpose. The Mullion Island cherts consist of easily-recognised bands of mostly black flint-like rock, generally reticulated with thin but conspicuous white quartz veins. They are extremely hard and resistant of both atmospheric and subterranean agents of destruction. They are of sufficient thickness to form a distinctly marked feature in the ascending sequence, and having been originally deposited on the floor of a deep ocean as radiolarian ooze, they necessarily occupy a wide horizontal extent of country. They occur in distinct bands, mostly in shales or crushed dark slates; they break with a conchoidal fracture, and when sheared or impure the microscope can generally determine their nature. The fossils are radiolarian deep-sea forms like those of the present day. Messrs. Teall and Lapworth have traced these cherts with Mr. Fox for 800 yards in the cliffs and on the foreshore north of Porthallow in-Menage, and during the past summer they have been traced at intervals through the parishes of Veryan, Gorran, and Caerhayes. Pebbles have been found on the north coast, which under the microscope show radiolaria with their structure still visible, but the parent rock has not yet been found *in situ*. It will therefore be agreed that these cherts most certainly should be traced wherever they appear in Cornwall. Their age is undoubtedly Ordovician, yet the precise zone to which they belong can only be determined by discovering some typical fossils in the shales and slates associated with them. In South Scotland officers of the geological survey have recently traced such cherts with radiolaria from sea to sea just beneath the Llandeilo rocks, fixing horizons exactly. The cherts in Cornwall, possibly of the same age, and certainly of the same character, are equally promising in the midst of the entangled rocks around, to form the datum line, or clue to the succession.

A COLLECTION of land and marine shells of the Gala pogo Islands was made during the voyage of the U.S. Fish Commission steamer *Albatross* in 1887-88. A report on this mollusc fauna, prepared by Dr. R. E. C. Stearns, has recently been issued from the U.S. National Museum. It is not an exhaustive review of the collection, but includes the principal collections previously made, and also a few notes of interest. The extreme tenacity of life of land snails in every stage of growth is well known. Dr. Stearns gives the following instances that came under his own observation:—"In December, 1865, the Stearns collection, now in the National Museum, was enriched by the acquisition of several examples of *Helix Veatchii*, Newcomb, now regarded as a variety of *H. arcolata*, that were

collected by Dr. Veatch on Cerros or Cedros Island off the coast of Lower California in 1859. The specimens were given by Dr. Veatch to Thomas Bridges, and upon the death of the latter came into my possession with the remainder of the Bridges shells. One day, upon a careful examination, I discovered that one of the specimens was apparently still alive, and placed it in a box of moist earth; after a while it protruded its body from the shell and commenced moving about, and seemed to be no worse for its long fast of at least *six years*. *H. Veatchii*, it will be observed, beat the time of the famous British Museum example of *H. desertorum*, which lived without food within a few days of *four years*. In March, 1873, Prof. George Davidson, of the United States Coast Survey, while at San José del Cabo, Lower California, collected a number of specimens of *Bulimus pallidior*, and subsequently gave me a part of them, which I put in a box, where they remained undisturbed until June 23, 1875, when they were placed in a glass jar with some chick-weed and a small quantity of tepid water. They soon woke up and began to move about apparently as vigorous as ever after their long nap of *two years, two months, and sixteen days*."

THE delicacy of the sense of taste among Indians has been tested by Mr. E. H. S. Bailey, and the results compared with those obtained from whites (*Kansas University Quarterly*). The method of testing was by solutions of different strengths, the substances quinine sulphate (bitter), sulphuric acid (sour), bicarbonate of soda (alkaline), cane sugar (sweet), and common salt (salt) being selected as representing classes of the common familiar substances most likely to be recognised. The only one of these that experience has shown is not familiar is the alkaline taste. From an examination of the results it appears that the order of delicacy is about the same for the two races. By this it is meant that the smallest proportion of quinine was detected; acid solutions come next in the order of action upon the organ of taste, and then salt. In the case of whites, sweet solutions were more detectable than alkaline ones, but the reverse was the case with the Indians. This does not count for much, however, as the Indians had great difficulty in distinguishing between the alkaline and salt solutions. As might have been expected, the ability to detect the different substances when they are in very dilute solution is less in the Indians than in the whites. The males of both races are able to detect a smaller quantity of salt than the females, but in all other cases the females appear to have the more delicate organ of taste.

THE question as to whether gases are capable of emitting heat has been investigated by many physicists, most of whom have come to the conclusion that the characteristic spectra of glowing gases are chiefly, if not solely, due to some chemical action going on within the gas. Hittorf heated air in platinum tubes a few centimetres long over a Bunsen, and Siemens treated air, carbonic acid, and steam in a similar manner, using longer tubes and higher temperatures. Both were unable to discover any radiation by the gases when thus simply heated, and Pringsheim, after more recent work, came to the conclusion that emission spectra cannot be obtained by simple heating. Mr. F. Paschen has, however, quiet recently (*Wied. Ann.* No. 11) succeeded in discovering and mapping such spectra by a modification of Tyndall's experiment with gases rising from an incandescent body, substituting the bolometer for Tyndall's thermopile. The hot body employed was a spiral band of platinum forming a narrow tube, which was heated by passing an electric current through the platinum. The gases were sent through this spiral, and thus acquired a temperature of about 1000° C. The temperature was measured by means of a platinum: platinum-rhodium thermocouple with an excessively small junction. The spectrum was formed by a flourspar prism

and two concave mirrors, adjustable automatically to minimum deviation for any wave-length. The gases examined were air, oxygen, carbon dioxide, and steam. Only the last two gave positive results, some small deflection in the first two being due to slight traces of moisture. Carbonic acid showed a very sharp maximum far in the infra-red. The bolometer strip was too broad to determine whether it was a line or a band, but it is most probably a somewhat ill-defined line. Steam showed about eight maxima, which must be described as bands. A comparison of the spectrum of the Bunsen flame with that of the hot products of combustion arising from it showed that the spectra obtained are similar and of almost equal intensity; so that it is very probable that the spectra of hot gases are chiefly due to temperature, and not to chemical action. A curious and hitherto unexplained observation is that of a slight shifting of the maxima towards the more refrangible end of the spectrum when the temperature is lowered.

To determine correctly the values of the critical constants of a substance is a matter of considerable difficulty: the estimation of the critical temperature, however, is generally believed to be both expeditious and accurate. The usual method of taking an observation of the critical temperature consists in heating the liquid in contact with its saturated vapour in a closed space to a temperature above the critical temperature, allowing the substance to cool, and noting the temperature  $t_c$  at which the meniscus of the liquid just appears in the misty contents of the closed space. In the current number of *Wiedemann's Annalen*, Herr Galitzini gives evidence to show that  $t_c$  thus determined, although it is independent of the amount of substance contained in the closed space, is lower (it may be considerably lower) than the true critical temperature, or the temperature at which liquid and saturated vapour have the same density. By very slow and regular cooling he also finds that the peculiar misty appearances which are usually held to be invariably associated with the critical state are not observed. Amongst other conclusions, his experiments, which it is to be noted were made on ether, lead him to believe that at temperatures even considerably higher than the critical temperature a substance at constant pressure may have different densities, different in some cases to the extent of 25 per cent. This last result the author attributes to the presence of molecular complexes in the substance: if its validity is established, it will of course overthrow the generally accepted idea that at any temperature above the critical temperature for a given value of the pressure there is only one value of the volume.

AN interesting paper on the various electric wave systems obtained by Lecher's method has been communicated to the R. Accademia della Scienza di Torino by Signor Mazotto. The effect of varying the lengths of the primary and secondary wires, and the distance apart of the plates of the condensers, has been studied. As an indicator of the points of maximum difference of potential along the wires, the author uses two short wires partly coiled round india-rubber tubes, which slide along the secondary wires, the ends of the wires being brought to within about 2 cm. of each other. If, when the apparatus is working in the dark, the fingers are brought near the platinum tips of these wires, two small luminous stars appear at these tips when the bridge over the secondary is in the vicinity of a node. When at a node these sparks become very conspicuous, even without the presence of the fingers. This indicator is said to have the advantage over the Geissler tube used by Lecher, that it shows more distinctly the maxima and minima, is less fatiguing to the eyes, and less capricious in its action. The number of nodal systems formed when, the primary system being kept constant, the bridge on the secondary wires is moved to different parts, were found to be more numerous than Lecher's observations

would seem to indicate. The "harmonics" of the fundamental system were not the only higher systems that were produced, it being found possible, by altering the position of the bridges to produce any system intermediate between two harmonics. It was also found, when the second bridge was placed at a fixed point, that the nodal systems obtained by moving the first bridge were independent, in position and intensity, of the state of the system beyond the second bridge. The wave-lengths obtained experimentally were compared with those given by the formula of Salvioni, and found to agree fairly well. The curves obtained by the author, and a full account of his method, has been published in the *Electrician*, vol. xxxii. p. 60.

THE following translation of a reply given by Prof. Galileo Ferraris to a young lady who asked what electricity was, is given by the *Electrician*. Prof. Ferraris has conferred a great benefit on all those who are supposed to have any knowledge of that magic science electricity, and are therefore continually being asked this question, though whether the reply satisfied the questioner is rather doubtful. His reply was:—"Maxwell has demonstrated that luminous vibrations can be nothing else than periodic variations of electro-magnetic forces; Hertz, in proving by experiments that electro-magnetic oscillations are propagated like light, has given an experimental basis to the theory of Maxwell. This gave birth to the idea that the luminiferous ether and the seat of electric and magnetic forces are one and the same thing. This being established, I can now, my dear young lady, reply to the question that you put to me: What is electricity? It is not only the formidable agent which now and then shatters and tears the atmosphere, terrifying you with the crash of its thunder, but it is also the life-giving agent which sends from heaven to earth, with light and heat, the magic of colours and the breath of life. It is that which makes your heart beat to the palpitations of the outside world, it is that which has the power to transmit to your soul the enchantment of a look and the grace of a smile."

THE current *Comptes Rendus* contains an important correction to the numbers given by M. Blondlot for the velocity of an electric disturbance in high conductivity copper (*Comptes Rendus*, October 23). The values were expressed in kilometres per second instead of thousands of kilometres per second, so each of the velocities given in our issue of November 9 (p. 37) must be increased by one thousand, in order to be correct.

A VERY important paper, by Dr. Uschinsky, on the cultivation of pathogenic bacteria in media, devoid of all albuminoids, appears in the *Archives de médecine expérimentale*, No. 3, 1893. Pathogenic organisms thus grown do not lose their virulent properties and, moreover, elaborate toxic substances, for on passing the media in which they have been cultivated through a Chamberland filter, the filtrate was found to be toxic. In a more recent paper, published in the *Centralblatt für Bakteriologie*, vol. xiv. No. 10, 1893, Dr. Uschinsky states that in order to obtain more satisfactory growths of the bacteria in question, he has introduced some modifications into the composition of the culture medium, which now affords as suitable a pabulum for their cultivation as ordinary bouillon. The following is the composition of this non-albuminous medium:—Water, 1000; glycerine, 30-40; sodium chloride, 5-7; calcium chloride, 0.1; magnesium sulphate, 0.2-0.4; dipotassium phosphate, 2-2.5; ammonium lactate, 6-7; sodium aspartate, 3.4. The organisms of cholera, diphtheria, tetanus, typhoid and others have all been grown successfully in the above. The poisonous substances elaborated by bacteria are, therefore, not necessarily due to their decomposition of the albumen contained in the ordinary culture media employed, but must rather be regarded as the result of synthesis; the materials produced, says Dr.

Ushinsky, belonging in all probability to the proteid bodies, and bearing much resemblance to ferments.

DR. USCHINSKY has made a special study of the tetanus bacillus when grown in this medium, and has examined in some detail the nature of the toxic products thus elaborated. A more satisfactory growth of this organism was procured by adding from one to two per cent. of grape-sugar to the solution, and the anaërobic conditions necessary for its cultivation were obtained by pouring liquid paraffin on the surface. The filtrate of such tetanus cultures was about equal in virulence to that derived from ordinary broth-cultivations of the bacillus. On the other hand, the poisonous properties of the former were far more easily removed than was the case with the broth-cultures, being destroyed by precipitation with alcohol, and also frequently by evaporation *in vacuo* at 33-36° C., this being especially the case when the latter was carried out in the presence of light. By addition of strong alcohol a precipitate was obtained, in which, besides salt, small quantities of albuminous bodies were present, as indicated by Millon's reagent and the xanthoproteic reaction. This precipitate was, however, without any toxic properties.

THE second edition has been issued of a general guide to the Manchester Museum, by Mr. W. G. Hoyle, Keeper of the Museum. The book should be useful in directing attention to the most important specimens, and explaining their character. Its value would be greatly increased, however, by the addition of an index.

"A BIBLIOGRAPHY of Vertebrate Embryology," by Mr. C. S. Minot, has been published by the Boston Society of Natural History. The titles are grouped into subjects, and the subjects are alphabetically arranged, so there is no difficulty in finding the original source of any paper, the title of which is known. An index of authors is also given to facilitate reference. Biological investigators will find the bibliography of great assistance.

THE volume of selections from the philosophical and poetical works of Miss Constance C. W. Naden, compiled by the Misses E. and E. Hughes, and published by Messrs. Bickers and Son, is one of the daintiest that we have seen for some time. The selections from her essay on induction and deduction contain some remarkably fine expressions, and many other parts of the book are of great interest.

MR. P. ANDERSON GRAHAM'S "All the Year with Nature" (Smith, Elder, and Co.) contains a number of reprints of articles originally contributed to various magazines. The author has a chatty style, and his heterogeneous collection will serve to while away an hour or two. The connection of many of the articles with the seasons is not very apparent, and some of the statements are not scientifically accurate, but, taken as a whole, the book is well worth reading.

PART I. of the sixth edition of Prof. Michael Foster's well-known "Text-Book of Physiology" has been published by Messrs. Macmillan and Co. It comprises the first book of the original volume, and deals with the blood, the tissues of movement, and the vascular mechanism. A number of important modifications have been made in the section devoted to the phenomena and mechanism of the heart-beat, but with this exception few changes have been introduced. Since the publication of the first edition, seventeen years ago, Prof. Foster's work has been recognised to be the best of its kind, and the issue of a new edition shows that it retains its position as a physiological "classic."

THE fourth volume of Alembic Club Reprints, published by Mr. W. F. Clay, Edinburgh, is before us. It deals with the foundations of the molecular theory of gases, and comprises

papers and extracts of papers by Dalton, Gay-Lussac, and Avogadro. There is no better way of studying the development of an idea than by reading such reprints as those issued under the auspices of the Alembic Club, for they enable the student to see the many difficulties that have to be overcome before a theory crystallises into shape. We therefore welcome this last addition to an excellent series of books.

THE Cambridge University Press has published the first volume of the series of manuals of biological science edited by Mr. Arthur E. Shipley. The book to which we refer is "Elementary Palæontology," by Mr. Henry Woods. In it the author gives a concise account of invertebrate palæontology, chiefly considered from a stratigraphical point of view. The plan of the book is excellent, the zoological features of each group being first described, then the genera of importance geologically are classified, and with this knowledge the student is able to understand the following section dealing with the distribution of the group. Instead of giving archaic illustrations of genera, Mr. Woods includes figures required to explain structure and terminology. The student will benefit by this change. Remarkable pictures of perfectly preserved fossils may suit the popular mind, but the student must study fossils in collections, and he needs more detailed instruction concerning their characteristics. As an introduction to the study of palæontology, Mr. Woods' book is worthy of high praise.

NOTES from the Marine Biological Station, Plymouth.—The past week has been one of the stormiest of the year. Work outside the Sound was quite impossible in our small boats, and even within the harbour was attended with difficulties. The captures included specimens of the Actinian *Cylista viduata*, and of the Dærididæ *Platydoridæ planata*, *Ægirus punctilucens* and the scarlet *Rostanga coccinea* upon the red incrusting sponge on which it feeds. From several hauls of *Antedon rosacea* a small number of the Polychæte commensal *Myzostomum* were obtained. The dogfish in the aquarium (*Scyllium catulus* and *canicula*) have begun to breed.

THE additions to the Zoological Society's Gardens during the past week include a Mozambique Monkey (*Cercopithecus pygerythrus*, ♂) from East Africa, presented by Mr. Bayes; a Rhesus Monkey (*Macacus rhesus*, ♀) from India, presented by Mr. C. E. Morris; two — Jerboas (*Alectaga jaculus*) from Persia, presented by Capt. R. A. Ogilby, F.Z.S.; a Tuatera Lizard (*Sphenodon punctatus*) from New Zealand, presented by Mr. Chas. Smith; a Lion (*Felis leo*, ♀) from West Africa, an American Bison (*Bison americanus*, ♀) from North America, deposited; a Cunning Bassaris (*Bassaris astuta*) from Mexico, purchased.

#### OUR ASTRONOMICAL COLUMN.

MECHANICAL THEORY OF COMETS. — Prof. J. M. Schaeberle, in the *Astronomical Journal*, No. 306, communicates a "preliminary note on a mechanical theory of comets," this being "a strictly logical consequence of the mechanical theory of the corona." The principles which serve as a basis may be said very briefly to be the following. Any given solar eruption gives rise to both prominences and streams. The ejective force being the same, the mass of a given volume of coronal stream is less than that of a prominence. Assuming mean density of coronal stream to be one-seventh of that of accompanying prominence, the same explosive force which during the last eclipse sent prominences to a height of 80,000 miles, will send coronal matter forming the streams to an infinite distance. Coronal streams extend far, then, into space. The densest portion of the stream is located at the point of minimum velocity, and the coronal streams visible in the last total eclipse were, Prof. Schaeberle says, according to his photographs, apparently most dense in the higher regions,



proving that the matter was in rapid movement. The mechanical theory of comets supposes coronal streams to issue from the sun at all angles. These streams will penetrate far into space (some crossing one another). The atmosphere of a comet on striking these streams will in projection be in the form of luminous, nearly concentric, arcs, the greatest brilliancy being near the most advanced part of each stratum. More than one coronal stream will produce in the comet multiple tails, the angles between the tails being a function of the velocities of motion, and the inclinations of the streams. An examination of the cases where a tail is turned towards the sun is explained by a coronal stream, having a less velocity than that of the receding comet, thus producing such a phenomenon the moment the stream is entered. Prof. Schaeberle, at the conclusion of the papers, refers to a satisfactory explanation of the "Gegenschein," and also to a plausible explanation of the Aurora, both based on the coronal streams.

THE NEW STAR IN NORMA.—When the announcement of the discovery of this star by Mrs. Fleming reached Prof. F. C. Kapteyn, a search was made by him through his manuscript of his photographic Durchmusterung for this region, with the result (*Astronomische Nachrichten*, No. 3196) that he found the following star, which is "wohl fast ohne Zweifel" identical with Mrs. Fleming's. Its position is

|            |                 |                |
|------------|-----------------|----------------|
| Phot. Mag. | R.A. 1875° 0    | Decln. 1875° 0 |
| 9.2        | 15h. 21m. 0.5s. | -50° 9' 7"     |

The plates which he had that contained this part of the heavens were taken in 1887, on June 25, July 25, and August 2; and in 1890, on April 29 and May 2. An examination of these showed that on the first three dates the star was not visible, but the last two distinctly indicate it as a star a whole magnitude brighter than the faintest star on the plate. A comparison of its brightness with the following three stars in its neighbourhood was made.

|     | Mag. in<br>Phot. Diam. | R.A. 1875° 0 | Decln. 1875° 0 |
|-----|------------------------|--------------|----------------|
|     |                        | h. m. s.     | ° ' "          |
| (a) | 9.2                    | 15 20 51.0   | -50 21.4       |
| (b) | 9.1                    | 20 59.0      | 21.5           |
| (c) | 9.1                    | 21 35.0      | 9.4            |

The results show that Mrs. Fleming's star is brighter than (a), scarcely dimmer than (b), and a little dimmer than (c). Its magnitude then in July and August, 1887, could not have been more than 9.2.

THE NATAL OBSERVATORY.—Mr. Nevill, the Government Astronomer for Natal, has to work under great difficulties. The grant of £800 per annum, made by the Natal Government to the Observatory, is certainly not enough to keep the establishment efficient. When the Observatory was first erected it was a substantially built, rectangular red brick edifice, carrying a light wooden upper structure, which formed equatorial and transit rooms, but there was only one room below, and this had to serve the double purpose of a computing room by day and sleeping room by night. Mr. Nevill has asked the Government to give him more accommodation, but his application has not been granted, the plea being shortness of funds; so he has had extra rooms built entirely at his own expense, and even now the four assistants of the Observatory work in a room which is nothing more than an enclosed verandah. The principal points under investigation at the Observatory are: the parallactic inequality in the motion of the moon, the lunar diameter, the effects of irradiation and its variations upon the moon's apparent semi-diameter, and lunar libration.

MAGNITUDE AND POSITION OF T AURIGÆ.—The current *Comptes Rendus* (November 13) contains a number of observations of Nova Aurigæ, made by M. Bigourdan, at the Paris Observatory. The star's magnitude was compared with that of neighbouring stars on October 10 and 12, and on November 8, 11, and 12. The observations show that from the middle of October to the 8th inst. the light diminished very definitely, and afterwards increased, but on the date of the last observation it had not attained the magnitude observed on October 10. In 1892 M. Bigourdan micrometrically measured the position of the Nova with respect to a neighbouring star, and a repetition of his measurements, after an interval of eighteen months, shows that no change of position has taken place.

PERIOD OF JUPITER'S FIFTH SATELLITE.—Prof. E. E. Barnard's new measures (*Astronomy and Astro-Physics* for Novem-

ber) for the times of elongation of the fifth satellite give a period

$$P = 11h. 57m. 22.56s.$$

The value obtained from his last year's value was

$$P = 11h. 57m. 23.06s.$$

While Mr. A. Marth, from the same observations, derived a period of

$$P = 11h. 57m. 21.88s.$$

The new determination falls, as will be noticed, nearly midway between the two values quoted, and covers a period of 743 revolutions of the satellite.

### GEOGRAPHICAL NOTES.

THE fate of the Bjorling exploring expedition, concerning the safety of which much anxiety has been felt in Sweden, has now been ascertained. Messrs. Bjorling and Kalstennius, two young Swedish naturalists, hired a small schooner, the *Riffle*, at St. John's, in June, 1892, and set out for a collecting trip along the west Greenland coast, accompanied by a crew of three men. After leaving the Danish settlements on the west coast last summer, no further news was received from the expedition, and the captains of the whaling vessels at work in Davis Strait this summer were specially requested to look for traces of the *Riffle* and her party. Captain McKay, of the Dundee whaler *Aurora*, who returned last week, reports that he visited the Carey Islands at the entrance to Smith's Sound on June 17 this year, and found there the wreck of the *Riffle*, a number of documents, and the body of one of the ill-fated crew. One of the papers written by Bjorling on August 17, 1892, on which day he had visited the Carey Islands to get provisions from the cache left by Sir George Nares, stated that on leaving the schooner ran aground, and the party had to land. A later note, dated October 12, shows that they attempted to reach Foulke's fjord to winter there, but after reaching Northumberland Island circumstances compelled their return. At the date of writing Bjorling intended to start immediately to endeavour to reach the Eskimo settlements at Cape Faraday or Clarence Head in Ellesmere Land, with the hope of returning to Carey Islands by July 1, 1893, to meet any whaler. In case of not finding a vessel he intended to push on to the Danish settlement. On receiving this news Captain McKay at once headed for Ellesmere Land, but the ice closed in, and he had to turn back. As the provisions would only last until January 1, it is to be feared that the whole party has perished, unless they were successful in reaching the Eskimo. If they did so, and were subsequently able to make their way to the Danish settlements, there may still be hope, but no news can be received until next summer.

THE *Times* announces that the Peruvian Government has awarded a gold medal to Mr. Clements R. Markham, F.R.S., President of the Royal Geographical Society, for the great services he has rendered to Peru in elucidating its geography, and in giving expression "with upright impartiality" to the facts of its history.

MR. W. H. COZENS-HARDY, who has just returned from a summer spent in exploration on the borders of Montenegro and Albania, has succeeded in making a number of observations of high geographical value. He has been able to lay down on a map for the first time the present frontiers of the principality, and from his knowledge of Slavonic languages and the free access accorded to him to the Montenegrin archives, he can also give a most interesting account of the past changes in the boundaries, furnishing, in fact, a chapter in the historical geography of the Balkan peninsula.

THE Arctic skipper Hans Johannsen, of Hammerfest, Norway, has heard from old Yakutsk that from the highest points of the northern shores of the New Siberian Islands a lofty land has been discerned to the north-west, at a distance of about fifteen nautical miles. He thinks, therefore, that should Nansen not steer too close to the coast, this new land might be seen from the masthead. And should the state of the ice be at all favourable, Nansen will, in all probability, attempt to take up his winter quarters there instead of the New Siberian Islands.

FROM a recent number of the *Kölnische Zeitung* we learn the somewhat remarkable fact that Cologne is the largest city in Germany, taking account of the area it covers, Berlin coming only fourth in order. In Cologne, however, only eight per cent.

of the area is built upon, the remainder being streets and open spaces.

THE Paris Geographical Society has awarded the grand prize for geographical research to M. Maistre, for his great journey from the Congo to the Shari.

### FLAME.<sup>1</sup>

THE subject on which I have the honour to address you this evening is, I am aware, one of the most hackneyed among the topics that have served for popular scientific lectures. I can only hope that it has not quite lost its charm. The chemist is often twitted with having to deal with mere dead soulless things, which at the best only set themselves into angular and unpalpating crystals. There may be a certain amount of truth in this, but in flames we surely have phenomena of some liveness. Our flame must be fed; it has its anatomy and varied symmetry; it is vigorous, mobile, and fleeting. I do not wish to make extravagant claims, but I do think that one may be excused for feeling almost as much interest in the study of flame as, for example, in the contemplation of the somewhat torpid evolutions of an amoeba or the circulation of water in a sponge. To our guileless ancestors, at any rate, flame was a phenomenon of the rarest mystery; unable as they were to discriminate between the material and the immaterial, unable to track the solid or liquid fuel to its gaseous end, this radiant nothingness called flame became to them one of the primary inscrutable, irresolvable things of Nature—an all-devouring element, often of peculiarly divine significance.

The essential nature of flame appears to have been discovered at the beginning of the seventeenth century by the Belgian, Van Helmont. This remarkable man is well known to chemists as one of the acutest and least superstitious of the whole band of alchemists. He was somewhat speculative in the domain of physiology, but in chemistry Van Helmont made discoveries of fundamental importance. From our immediate point of view, one of the most important things he did was to sweep away the mystery that had so long attached to the gaseous state of matter. In so far as he distinguished between different gases obtained from different sources, he may be said to have been the first to bring aciform matter within the range of substantial things that might be submitted to experimental investigation. It was in consequence of this that he was led to the discovery of the nature of flame. I will quote the important passage from his writings.

"But the flame itself, which is nothing but a kindled smoke, being enclosed in a glass in the very instant perisheth into nothing.

"The flame indeed is the kindled and enlightened smoke of a fat exhalation: be it so; but as the flame is such and true fire it is not another matter, being kindled and not yet kindled, neither doth it differ from itself; but that light being united in its centre, hath come upon a fat exhalation which is the same as to be inflamed.

"Let two candles be placed which have first burned awhile, one indeed being lower than the other by a span: but let the other be of a little crooked situation; then let the flame of the lower candle be blown out; whose smoke, as soon as it shall touch the flame of the upper candle, behold the ascending smoke is enlightened, is burnt up into a smoky or sooty gas, and the flame descends by the smoke even unto the smoking candle. Surely there is there, the producing of a new being, to wit, of fire, of a flame, or of a connexed light; yet there is not a procreation of some new matter or substance.

"For the fire is a positive artificial death but not a privative one, being more than an accident and less than a substance."

We can best understand the meaning of this somewhat oracular statement by repeating Van Helmont's experiment. We take a bundle of lighted tapers so as to get a large flame, we hold over "in a little crooked situation" another lighted taper, and now blow out the lower flame. We note the ascending column of smoke, and observe that when it touches the upper flame it ignites, and the flame descends several inches through the smoke to the bundle of tapers. Flame therefore, says Van Helmont, is burning smoke; it is not a new substance nor a mere chance occurrence, but the incandescence of a vapour or smoke that already existed.

Van Helmont only recognised in a vague way the important part played by the atmosphere in the phenomenon. This was

realised much more perfectly soon afterwards by Hooke, who speaks of "that transient shining body which we call flame," as "nothing but a mixture of air and volatile sulphureous parts of dissoluble or combustible bodies which are acting upon each other whilst they ascend," an action so violent, he says, "that it imparts such a motion or pulse to the diaphanous parts of the air" as was requisite to produce light.

Without entering further into early historical details I may say that it was only towards the end of last century that the essential chemistry of the phenomenon was fully expounded by the great Lavoisier. He showed that, as Hooke had surmised, flame is the region in which combination attended by the evolution of light takes place between the components of a gaseous substance and the oxygen of the air.

The next step in the history of our knowledge of flame brings us to the memorable researches of Humphry Davy, whose name more than that of any other man is associated with this subject. Of Davy's work I shall have more to say presently; but at this moment I will only make one allusion to it, an allusion which will provide us with a proper starting-point this evening. It is interesting to note that Davy's discoveries concerning flame were the consequence and not the cause of the discovery of the miners' safety-lamp. In this case practical application preceded purely scientific discovery.

I need not describe the safety-lamp to you in Nottingham, where it has recently received such important improvements at the hands of Prof. Clowes. When the lamp is placed in an explosive mixture, you know what happens—the explosive mixture burns with a quiet flame within the lamp, but the flame cannot pass through the wire gauze to ignite the mixture outside the lamp. I can demonstrate this by means of this large gas-burner, which is primarily a Bunsen burner, that is, a burner which by means of holes at the base of the tube draws in sufficient air to enable the gas to burn with a practically non-luminous flame. If I turn on the gas and apply a light to the top of the burner, you observe that I get a flash and a small explosion within the tube, but no continuous flame. The fact is that the mixture of gas and air within the tube is highly explosive. Placing a gauze cap over the burner and applying a light, I now get a steady flame. The explosive mixture made in the tube passes through the gauze and is inflamed, or, if you like, exploded; but the explosion cannot pass through the gauze, because the metallic wires withdraw the heat so rapidly that the mixture below it never reaches the temperature of ignition. Above the gauze we have the continuous flame.

"These results are best explained," says Davy, "by considering the nature of the flame of combustible bodies, which in all cases must be considered as the combination of an explosive mixture of inflammable gas or vapour and air; for it cannot be regarded as a mere combustion at the surface of contact of the inflammable matter."

Davy, then, regarded flame as being essentially the same as explosion: it was, in fact, a kind of tethered explosion.

Since Davy's time we have learned much about the nature of gaseous explosions, and we now know that such explosions, when fully developed, proceed with enormous rapidity and are of great violence, incapable of arrest by such simple means as we have just used. Still there is not much to correct in what I have said. I think I cannot do better than show you the transition of flame into explosion by an experiment which was first shown by Prof. Dixon in the lecture which he gave at the meeting of the British Association in Manchester in 1887.

The apparatus before you consists simply of a Bunsen burner surmounted by a long glass tube. If I turn the gas on and light it I obtain at the top of the glass tube a steady flame. The mixture ascending the tube can scarcely be called explosive at present, but if I alter the proportions of gas and air suitably it becomes distinctly explosive. Observe what happens when this is the case. The flame can no longer keep at the top of the glass tube; it passes within it, and descends with uniform velocity till at a certain point it flickers and then shoots down almost instantaneously to the bottom. This sequence of events is exhibited in all cases when flame develops into explosion. We are concerned only with the first phase, viz. that of comparatively slow inflammation and a flame, we may say, is a gaseous explosion brought to anchor in the period of incubation.

There is one other point connected with explosion that we must note on account of its important bearing on the chemistry of flame. When we are dealing with explosive mixtures of gas and air, we find practically that the composition of the

<sup>1</sup> An evening discourse to the British Association at the Nottingham meeting, September 13, 1893, by Prof. Arthur Smithells.

mixture may vary considerably and still retain its explosive properties. There is, of course, a certain mixture which presents the greatest explosive power; a further quantity of the combustible gas or of the air will diminish the explosibility, but not entirely destroy it till a large excess is used. With hydrogen, for example, two and a half times the volume of air (which contains exactly the oxygen requisite to combine with the hydrogen and produce water) is the right quantity for the maximum explosive effect, but we still get explosion when we have much more than two and a half times as much air as hydrogen, or when, on the other hand, we have much less. In one case there will be oxygen left uncombined, in the other case hydrogen. I dwell upon this in order that we may be prepared to find the same thing in flames, in order that we may not be surprised to find combustion taking place in mixtures where either gas or air is in excess of the quantity actually required for the purpose of chemical combination. Bearing this in mind, let us revert to the experiment that I have just shown. It consists, you remember, in mixing air with gas before burning it, to such an extent that the flame strikes down the tube. On a close examination we find that this is not quite a correct statement, for when I regulate the air with nicety you see that it is only part of the flame that strikes down the tube. There remains all the while at the top of the tube another part of the flame which is not mobile. With a little care I can adjust the proportion of air and gas so that the part of the flame which is mobile shall move up and down the tube like a piston. All the while you see the pale steady flame at the top of the tube. When in this critical condition a little more air determines the descent of the movable part of the flame, a little less sends it to the top.

Let us now turn to the explanation of this phenomenon. It is clear, in the first place, that coal-gas and air form an explosive mixture long before there is enough air to burn all the gas. For it is only part of the flame that descends the tube, and there is enough gas passing through this part to form a second flame as soon as it reaches the outside air at the top of the tube. There is, as a matter of fact, only about two-thirds as much air entering the tube at the bottom as would be necessary to burn the whole quantity of gas. We see, in the next place, that the explosibility varies greatly according to the proportions of gas and air. For what is the cause of the descending flame? It is simply that we have an explosive mixture in process of inflammation. The inflammation is tending downwards; opposed to it is the movement of the explosive mixture upwards. If the upward movement of the unburned mixture is more rapid than the downward tendency of the inflammation, the flame cannot descend. We can only make it descend by making the downward tendency greater. This we do by adding more air, and making the mixture more explosive. We see that we can balance these two opposite velocities with the greatest nicety by a careful adjustment of the proportions of the explosive mixture.

In order to ascertain what proportion of gas is being burnt in this movable flame, and what is the chemical character of the products there formed, it is necessary to keep the two parts of the flame separate, and to take out some of the gases from the intervening space.

This is very easily done. The flame descends, we have seen, because its rate of inflammation is greater than the rate of ascent of the combustible mixture. If now we can make this rate of ascent more rapid at one part of the tube than it is anywhere else, we may expect to stop the descent of the flame at that point and keep it there. We can do this simply by choking the passage, for just as a river must flow rapidly where its banks are close, so must the stream of gas rush more rapidly where the tube is choked than either below or above, where there is a wide passage. If, then, I replace the plain glass tube by one that has a constriction in one part, and if I cause the inner cone of the flame to descend as before, it stops, as you see, at the constriction, and will remain there any length of time. Its rate of descent is greater than the rate of ascent of the gas where the tube is wide, but not so great as that where it is narrowed by the constriction. We have now got the two cones of flame widely separated. In this state of things we can, if we choose, draw off the gases from the space between the two cones by putting in a bent glass tube and aspirating. We could then analyse these gases and see what has happened in the first cone. (Fig. 1, A.)

I will now show you another method in which the two cones

can be separated. It is based on the same principles as the one just used. I have here a two-coned flame burning at the top of a glass tube. I shall let the air supply be liberal, but not quite sufficient to cause the descent of the inner cone. The rate of ascent of the gas is now just a trifle greater than the rate of descent of the flame. If now I retard the rate of ascent of the gas, the balance will be disturbed and the inner cone will descend. I can easily do this by laying an obstacle *above* the stream of gas, for at the end of it there will be no more current than you would find over the stern of a boat anchored in mid stream. I take this obstacle, then, in the form of a glass rod fixed centrally along the current of gas; I push it up until it touches the tip of the inner cone, and then pull it down again. You observe what has happened. The cone has followed the rod into the tube, and remains attached to it. You will notice, too, that the cone is inverted. That is easily understood. It is only at the tip of the rod that the current is slowed down; there only is the rate of ascent of the stream less than the rate of inflammation. The tendency in every other part of the stream is for the cone to go to the top; hence the inversion. (Fig. 1, B.)

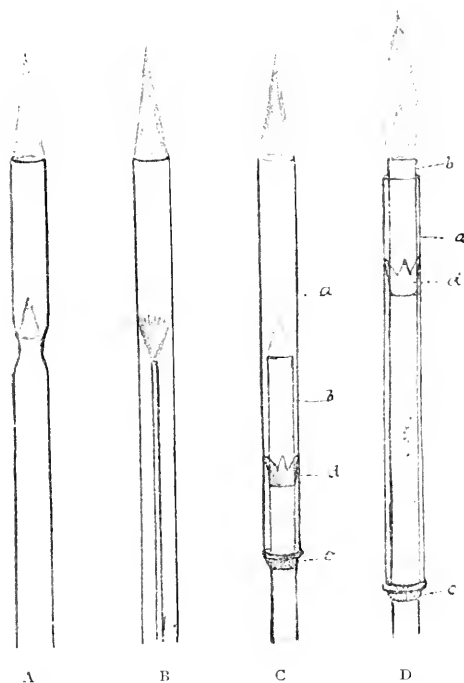

FIG. 1.—Methods of separating the two cones of an air coal-gas flame.

We can get a still more convenient apparatus by a modification of the first method. Instead of choking the bore of the single tube by a constriction, we may use two tubes of different diameter, one sliding within the other. This apparatus is shown in Fig. 1, C; *a* is the wider tube, *b* the narrower one. The two tubes are connected by an india-rubber collar (*c*), and kept steady by the brass guide (*d*). The outer tube can be slid up and down the inner one as desired. If we place this apparatus over a Bunsen burner and turn on the gas, we shall have a tolerably rapid upward current in the inner tube, but as soon as the gas emerges into the wider one its velocity will of course diminish. The consequence is that if we now light the gas and gradually increase the air supply, the inner cone will descend until it reaches the orifice of the narrower tube; but at that point, meeting with the rapid stream, its progress is arrested, and it remains perched on the end of the tube. By sliding the tubes we can thus separate the cones any desired distance, or we can bring their orifices level and restore the original flame. Lastly, we can reverse the experiment, for we can begin with a two-coned flame burning at the protruding end of the narrower tube, and by sliding up the wider tube detach the outer cone and carry it upwards. (Fig. 1, D.)

Having now learnt the relation of flame to explosion, having

discovered that flames have separable regions of combustion, and having armed ourselves with an appliance for dissecting the flame, we may proceed to discuss the main question.

I do not intend this evening to enter seriously into chemical details, but there are one or two simple points to which I must draw your attention. Flame, we see, is a region in which chemical changes are taking place with the evolution of light. It is to be expected, therefore, that the character of a flame, its structure and appearance, will vary according to the chemical changes that give it birth; and we should naturally anticipate that the more complex the chemical changes the more complex would be the flame. The kind of complexity to which I refer is illustrated by the diagram.

| Name              | Composition         | Products                                          |                             |
|-------------------|---------------------|---------------------------------------------------|-----------------------------|
|                   |                     | Partial Combustion                                | Complete Combustion         |
| Hydrogen          |                     | water                                             | water                       |
| Carbon monoxide   | carbon and oxygen   | carbon dioxide                                    | carbon dioxide              |
| Carbon            |                     | carbon monoxide                                   | carbon dioxide              |
| Cyanogen          | carbon and nitrogen | carbon monoxide and nitrogen                      | carbon dioxide and nitrogen |
| Hydrogen sulphide | hydrogen & sulphur  | (c)                                               | water and sulphur dioxide   |
| Hydrocarbons      | hydrogen & carbon   | carbon monoxide, carbon dioxide, hydrogen & water | carbon dioxide and water    |

In the first column are the names of five combustibles; their chemical composition is stated in the second column. All these substances in burning combine with the oxygen of the air. The case of hydrogen is the simplest. This gas, when it burns, unites with half its volume of oxygen, and forms steam. The process is incapable of any complication. We might predict, therefore, a very simple structure for a hydrogen flame. The same is true for the next gas carbon monoxide, which, although a compound, unites at once with its full supply of oxygen and burns, forming carbon dioxide. The third combustible, carbon, presents a new feature; in burning it can combine with oxygen in two stages, forming in the first instance carbon monoxide, which, as we have just seen, can itself combine with more oxygen to form carbon dioxide. We cannot vaporise carbon and use it as a gas, so that we shall not actually deal with this example. But the next combustible on the list, cyanogen, will serve almost as well, for it is a compound of carbon with nitrogen, and nitrogen is, under ordinary circumstances, practically incombustible. To use cyanogen is thus much the same as to use carbon vapour. We may expect some complexity in the cyanogen flame in consequence of the fact that carbon can burn in two steps. The next combustible, hydrogen sulphide, presents a further degree of complexity. It is composed of two elements, each of which is combustible on its own account. Lastly, we come to the great class of hydrocarbons, which includes all ordinary combustibles, oil, tallow, wax, petroleum, and coal-gas. The carbon and hydrogen are both separately combustible elements, and one of them—carbon—is, as we have seen, combustible in two steps.

We will now consider the problem in its simplest aspect. For this purpose I choose the gas carbon monoxide. I should choose hydrogen were it not for the fact that its flame is almost invisible. We will allow a stream of carbon monoxide to issue from the circular orifice of this glass tube. Lighting the gas we get a blue flame. On examining this flame closely we perceive that it is simply a hollow conical sheath of pretty uniform character. I need scarcely demonstrate that it is hollow, but I may do so in a moment by using Prof. Thorpe's simple device of thrusting a match-head into the centre of the flame—a pin passing through the stick of the match, and its ends resting on the tube. The match-head is now thrust well up inside the flame, and you observe that it remains there sufficiently long without burning, to make it quite clear that there is no combustion within the cone. The conical form of the flame is easily explained. As the stream of gas issues from the tube the outside portions become mixed with the air and burn. The inner layers must successively travel further upwards, like the successive tubes of a tele-cope, before they can get enough air to burn, and in this way we arrive at the conical form.

There still remains one thing to account for, and that is the luminosity and colour of the flame. The questions here involved are perhaps the most interesting of all, but they are complicated, and I will not say more than a few words about them. The most obvious answer to the question, "Why is the flame luminous?" is to say that the heat developed during the chemical

combination raises the product of combustion to a temperature at which it glows—a "blue heat" in the present case. Now if we put a thermometric instrument into the carbonic oxide flame, it does not register at any point as high a temperature as 1500° C., but if we take carbon dioxide and heat it in a tube by external heating to 1500° C. we get no signs of luminosity whatever. On these grounds several eminent investigators have been led to abandon the simple explanation above given, and to say that the luminosity of a carbon monoxide flame must depend not on the heat of chemical combination, but on something in the nature of electrical discharges between the combining substances, which discharges produce the disturbances of the ether perceptible as light. This view seems to be fraught with a fundamental error. The temperature registered by any instrument introduced into a flame is an *average* temperature, uncorrected for losses by conduction. It is not the temperature of the newly-formed gas, but of the mixture of that and the unburned gases. If we had a very small instrument which we could apply to the particles of newly-formed gas, we should undoubtedly find them at a very much higher temperature than any indicated by the ordinary thermometric apparatus, and it is not unlikely that the temperature would be several thousand degrees, approximating indeed to the temperature at which we arrive by calculation from the heat of combustion of the gas and the heat capacity of the product. We cannot say that the flame is luminous from some other cause than simple hotness, for we have no means of seeing whether carbonic acid glows when raised by external heating to a temperature of several thousand degrees.

At the same time one cannot help remarking on the similarity between such a flame as that of carbon monoxide and the appearance presented by an attenuated gas when submitted to the



FIG. 2.—Typical Flames. (a) Carbon monoxide, single coned; (b) Cyanogen, two coned; (c) Small coal-gas flame.

electrical discharge in a Geissler tube. I have here such a tube, containing carbon dioxide, and I have placed a mask over it, so that we see a long triangular piece of it. When I pass the discharge you see it lights up and presents an appearance strikingly like that of our conical flame of carbon monoxide. There may be a close relationship between the phenomena, but we cannot affirm it yet. No doubt we shall soon learn a good deal more about both phenomena.

We have now done with the simplest kind of flame. We see that it consists of a single conical sheath of combustion, at every point of which the same chemical change is taking place, and every point of which in consequence has the same appearance.

We pass to the cyanogen flame. This flame is one of remarkable beauty; it consists, as you see, of two distinct parts: one a rose or peach-blossom coloured cone, surrounded by a paler cone, which is bright blue where it is near the inner cone, and shading off to a kind of greenish grey. What is the cause of this double structure? It might be that part of the gas is burning round the orifice, the rest further out in the second cone; but a similarity of the chemical processes in the two parts of the flame is here rendered improbable by the difference in colour. The only satisfactory way of answering the question is to separate the cones, and analyse the gases in the intervening space. This we can easily do in the cone-separating apparatus.

I now form the flame at the top of our cone-separating apparatus, and supply a certain amount of air along with the cyanogen. You observe the rose-coloured cone contracts somewhat. The gas burning there now gets its air supply easily, and has not to wander outwards. If I still further increase the air supply, and make the ascending mixture explosive, you see the inner cone begins to descend into the tube, and passes down until its progress is checked at the narrow tube, where the up-rush of gas is more rapid. We have now got the cyanogen flame dissected, and by taking out a sample of the gases from this interconal space and analysing it, we shall find what chemical change has taken place in the inner rose-coloured cone. The analysis shows that what takes place is the combustion of the carbon of the cyanogen to form carbon monoxide almost exclusively; the carbon monoxide then ascends, and when it meets with more oxygen in the outer air, burns in a second cone to form carbon dioxide.

Reverting then to the flame of the pure unmixed gas burning at the top of a tube, we see that the gas and air will interpenetrate. When there is just enough oxygen to burn the gas to carbon monoxide, we get the rose-coloured cone, and outside it, where this carbon monoxide gets more air, we have a second cone. The two-coned structure corresponds then to two chemical stages of combustion.

Now we might go further and anticipate that if we supplied a very large quantity of air to the cyanogen, as in a blow-pipe, the two-coned structure would disappear, for the carbon should be burnt up at once to the ultimate product, carbon dioxide. We can easily try this. I will separate the two cones again in our apparatus, and increase the air supply still further. When I do so you observe that the second cone gradually fades away, and now the whole of the combustion is taking place at the end of the inner tube. Though this is so, the flame is not quite a simple cone. It is, as you see, surrounded by a greenish halo. This halo is due, I believe, as Prof. Dixon has suggested, to the fact that the nitrogen of the cyanogen is not, strictly speaking, incombustible. This has been proved by Mr. Crookes in his beautiful air flame, and besides, the greenish halo is frequently noticeable in cases of combustion where oxides of nitrogen are present.

Keeping to our list we ought next to deal with the combustible hydrogen sulphide or sulphuretted hydrogen. This gas, you remember, is composed of two separately combustible elements, each burning in one stage. The flame is, as you might expect, two-coned, but I will not dwell upon this case—partly because it is not yet fully worked out, and partly because any prolonged experimenting with this gas would, I feel sure, be resented even by the most indulgent audience.

I am obliged, therefore, to pass to compounds of carbon and hydrogen, in which there are not only two combustible elements, but one of them, as we have seen, combustible in two chemical stages. Here we have an almost unlimited choice of materials, for we come amongst the combustibles which ordinarily supply us with light. I shall, for the sake of convenience, use coal-gas. This is really a very complex combustible, consisting one half of hydrogen, the other half of at least a dozen different compounds of carbon and hydrogen. But experience has shown that the chemical phenomena attending its combustion are quite of the same character as those to be observed with a single compound of hydrogen and carbon.

It will, I imagine, be scarcely necessary for me to point out the various parts which are to be seen in the flame of a candle or of coal-gas. There is on the diagram (Fig. 2, c) before you the picture of a somewhat small coal-gas flame, produced at a circular orifice. It is, of course, enormously enlarged in the diagram. Four distinct parts are to be recognised. First, the central and darkest part; this contains the unburnt gas, just as we saw in the case of the carbon monoxide flame. Perhaps it is wrong to speak of this at all as part of the flame, for it is really a region of no flame. At the base of the flame are two blue strips embracing the lower portion of the flame. This appearance you will understand results from the mode in which we view the flame. The strips are really due to a sheath which goes right round the flame like an uninterrupted calyx. It looks bright where we view it edgewise. When we look through, as in the middle of the diagram, it is very pale indeed. Next we have to notice the bright yellow patch, so bright in the reality as to mask the other parts. Though it looks bright and dense, it is merely a hollow sheath. Lastly, there is surrounding the whole flame a pale mantle of flame of very slight luminosity,

and of an almost indescribable tint, which perhaps we may call lilac. These parts are discernible in all ordinary flames. They do not always occupy the same relative space. In the flame given by a good gas-burner the yellow part is made by intention as large as possible: in the flame of a piece of string or a spirit-lamp you will see the outer investing mantle very distinctly developed.

If we are to understand flame, then, we must find an intelligible explanation of the existence of these distinct parts of its anatomy. One important point we can settle at once. An ordinary flame owes its differentiated structure to the slowness with which it gets the oxygen necessary for combustion. If there is an immediate and sufficient supply of air, the characteristic structure disappears. This we can secure by making the stream of gas sufficiently rapid. I have here a steel cylinder containing coal-gas at very high pressure. If I allow the gas to escape slowly, we get a flame in which we should find the ordinary parts. But if now I allow the gas to issue rapidly, the admixture with air is so rapid, and, as you see, we have a pale flame quite undifferentiated in structure. We reach the same result by introducing a strong current of air into an ordinary flame, as in the blast blow-pipe. The flame, you see, is then homogeneous, as in the previous case.

We see then that the structure of an ordinary gas flame is largely dependent upon the slowness with which the gas gets the air necessary for combustion. There is still one other evidence of this. It is obvious that a very small flame will have a much better chance of getting its oxygen quickly than a larger flame. It is, I am sure, within everyone's knowledge that a very tiny gas flame is blue, and, as a matter of fact, we can learn a great deal about flame structure by carefully watching the development of a very small flame. I am going to show you on the screen a series of photographs of actual flames. The photographs have been tinted as faithfully as possible.

The first slide (Fig. 3, a) shows a tiny gas flame burning at the end of a glass tube; it consists of a bright blue cone surrounded by a fainter one. Both are quite continuous. By putting in another slide, and using the "dissolving view" arrangement of the lantern, I will show you the effect of turning on the gas. The flame (Fig. 3, b) you see is larger, and now is observed a third region in the flame—namely, a patch of bright yellow at the tip. The original cones are still there, but are slightly interrupted at their apices. Turning on more gas, the flame (Fig. 3, c) again enlarges, the yellow patch increases in size, and the original cones are further broken into. But you see the yellow patch is indented at points corresponding to the inner cone, which, as it seems, is striving to maintain its integrity. Turning on still more gas, we have now a great preponderance of yellow, the original blue cone is reduced to mere vestiges, and the outer cone forms a faint surrounding to the whole flame (Fig. 3, d). This is flame as we ordinarily know it. I wish now to show you another series of changes. We must suppose the gas supply fixed, and the photographs I will show represent the changes which take place in the flame when air is gradually added beforehand to the coal-gas. The supply of coal-gas is, I repeat, the same in all cases. The first change seen is, you will notice, that the yellow patch diminishes in extent (Fig. 3, e). If I add more air it diminishes still more, and the inner cone is growing in distinctness (Fig. 3, f). If I add a trifle more air, the yellow patch disappears altogether, and we have now complete and distinct inner and outer cones (Fig. 3, g). I think you will admit that these two sets of photographs show a close correspondence, and you can see it more plainly if I throw them on to the screen in a group. There is really nothing surprising in this similarity. The smallest gas flame has obviously the best chance of getting air, and when it gets enough it burns in a two-coned flame. The same effect is reached by adding air to the gas before it is burned. If we have a larger gas flame it has, of course, less chance of getting its oxygen rapidly, and we see that in whatever way we starve the flame of oxygen, we lose the simple structure, and come upon the yellow patch.

Now, when we come to inquire into the chemical changes occurring in such a flame, we may, I think, feel confident that the chemical actions which determine the existence of the blue cone and the outer cone are the same, whether these cones are complete, as in a small flame, or fragmentary, as in a larger one.

If that is so we can soon make progress, for, as I have shown you, we can easily separate these cones and find what is going on in each. I again use the cone-separating apparatus. First we have an ordinary luminous gas flame at the top of the outer

tube. I pass in air, the flame loses luminosity, and rapidly becomes an ordinary two-coned Bunsen flame. I push the air supply further; the inner cone enters the tube, and descends until it rests on the end of the inner tube. The two cones of a hydrocarbon flame are thus widely separated; we can aspirate a sample of the gases, and see what changes have taken place in the first region of combustion. The result is one that we might await with curiosity, for we have now a competition. There are both carbon and hydrogen to burn, and not enough oxygen to burn both: the question is, which will have the preference? I think I may say that the off-hand opinion of any chemist who has not had his attention drawn specially to this point would be that the hydrogen would easily have the preference. But, as a matter of fact, this question was settled long ago by Dalton, and in the opposite sense, and in the present case analysis would confirm this conclusion. If we analysed

About two-thirds of the carbon is burnt to form carbon monoxide, one-third to form carbon dioxide, whilst rather less than two-thirds of the hydrogen is burnt, and more than one-third remains altogether unburnt. We need not dwell on the details, especially as the analysis of the gases was made after they had cooled. The four gases—carbon monoxide, carbon dioxide, steam, and hydrogen—act upon one, as a matter of fact, while they are cooling down, and the distribution of the oxygen that we find in our analysis of the cold gas is not precisely that which exists in the gases as they just leave the inner cone. We shall only draw a general inference, and it is one that has been recently verified in a very complete manner by Prof. Dixon and his pupils. This inference is simply that the carbon in the inner cone is for the most part burnt to carbon monoxide, and that the hydrogen to a considerable extent is set free. So much then for the inner cone. The outer cone is

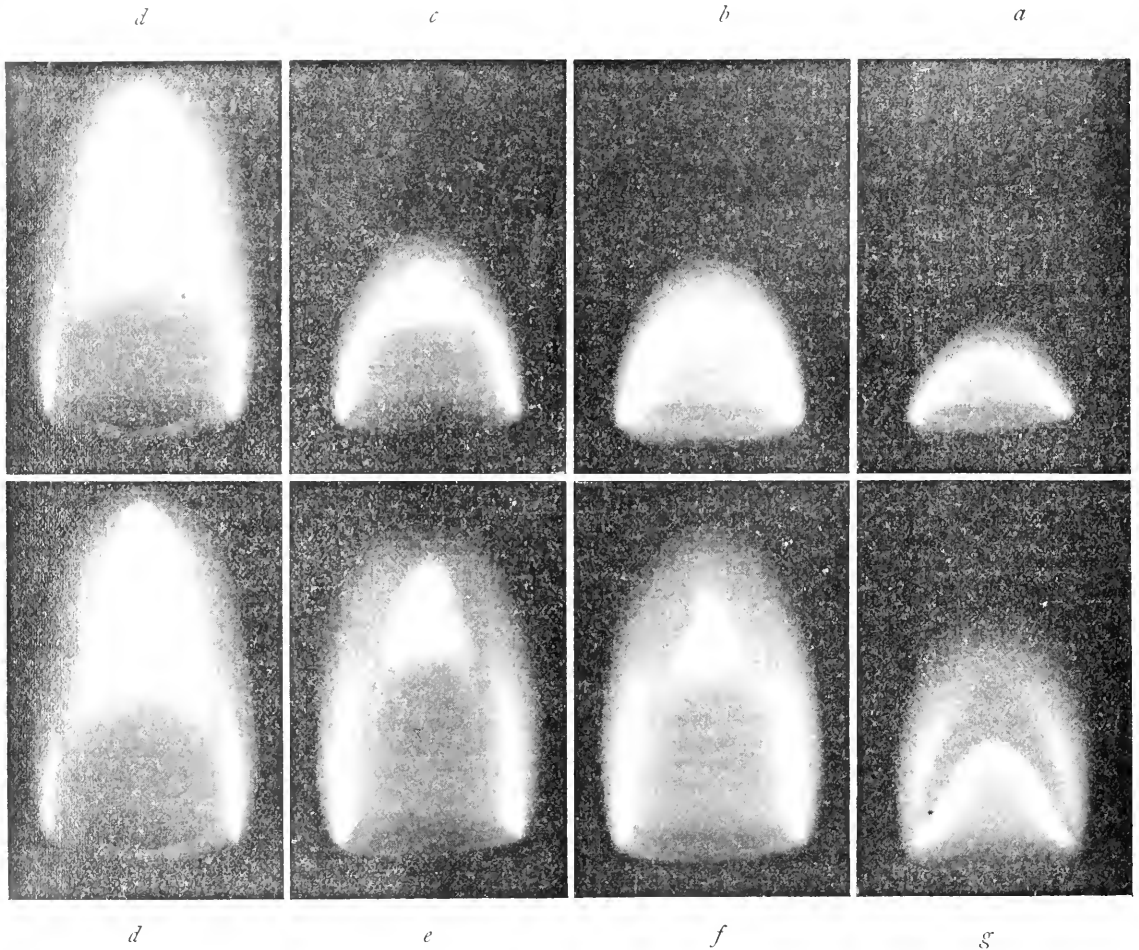

FIG. 1.—*a, c, e, d*, flames with successively increasing quantities of coal-gas. *d, e, f, g*, flames with fixed supply of coal-gas and successively increasing quantities of air.

the gases we should find that all the carbon is burnt in the first cone, whilst a considerable part of the hydrogen passes through unburnt. The change is not quite so simple as these words might imply, as you will see from the actual figures of analysis.

ANALYSIS OF INTERCONAL GASES FROM A COAL-GAS AIR FLAME.

|                               |       |                                            |                                           |
|-------------------------------|-------|--------------------------------------------|-------------------------------------------|
| Carbon monoxide.....          | 8.7   | } 17.9 combustibile gases.                 |                                           |
| Hydrogen.....                 | 9.2   |                                            |                                           |
| Carbon dioxide.....           | 4.1   |                                            |                                           |
| Water.....                    | 15.0  |                                            |                                           |
| Nitrogen.....                 | 62.0  | } 20.1 burnt gases.                        |                                           |
|                               | 100.0 |                                            |                                           |
| Amount of air used.....       | 7.5   | } { Oxygen..... 16.5<br>Nitrogen..... 62.0 |                                           |
| Amount of air still needed... | 4.0   |                                            |                                           |
|                               |       |                                            | } { Oxygen..... 9.0<br>Nitrogen..... 33.0 |
|                               |       |                                            |                                           |

due simply to the burning of the carbon monoxide and hydrogen which escape from the inner cone. When they meet with oxygen in the free air their combustion is completed. We are now in possession of the explanation of the two-coned gas air flame. Applying this to the tiny gas flame to which no air has been previously added, we see that the inner core will be formed where the air has penetrated the gas sufficiently to produce such a gaseous mixture as we had in the lower cone of our separator. The gases coming from this burn further out when they meet with more air, and form a second cone.

The last thing we have to explain in the ordinary gas flame is the production of the yellow luminous patch, which, from the illuminating point of view, is the most important feature of all.

Now I need scarcely remind you that the general opinion is

that this yellow patch in the flame is due to glowing carbon in a solid and very finely-divided state. The very familiar fact that a cold object introduced into the yellow part becomes coated with a black solid deposit, composed almost wholly of solid carbon, confirms this view. That this carbon or soot is solid in the flame, is shown by the fact that it is deposited as a solid even when a highly-heated object is placed in the flame, and there are other proofs—some of them very pretty—which I cannot show for lack of time and of a means of magnifying.

This explanation is due to Davy, and constitutes his most celebrated discovery on the subject of flame. He describes it in the following words:—

“When a wire-gauze safe-lamp is made to burn in a very explosive mixture of coal-gas and air, the light is feeble and of a pale colour, whereas the flame of a current of coal-gas burnt in the atmosphere, as is well known by the phenomena of the gas-lights, is extremely brilliant. . . . In reflecting on the circumstances of the two species of combustion, I was led to imagine that the cause of the superiority of the light of the stream of coal-gas might be due to the *decomposition* of a part of the gas towards the interior of the flame where the air was in smallest quantity, and the deposition of solid charcoal which, first by its *ignition*, and afterwards by its *combustion*, increased in a high degree the intensity of the light; and a few experiments soon convinced me that this was the true solution of the problem.

“I held a piece of wire-gauze of about 900 apertures to the square inch over a stream of coal gas issuing from a small pipe, and inflamed the gas above the wire-gauze which was almost in contact with the orifice of the pipe, when it burned with its usual bright light. On raising the wire-gauze so as to cause the gas to be mixed with more air before it inflamed, the light became feebler, and at a certain distance the flame assumed the precise character of that of an explosive mixture burning within the lamp, but though the light was so feeble in this last case, the heat was greater than when the light was much more vivid, and a piece of wire of platinum held in this feeble blue flame became instantly white hot.

“On reversing the experiment by inflaming a stream of coal-gas and passing a piece of wire-gauze gradually from the summit of the flame to the orifice of the pipe, the result was still more instructive, for it was found that the apex of the flame intercepted by the wire-gauze afforded no solid charcoal, but in passing it downwards solid charcoal was given off in considerable quantities, and prevented from burning by the cooling agency of the wire-gauze; and at the bottom of the flame, where the gas burnt blue in its immediate contact with the atmosphere, charcoal ceased to be deposited in visible quantities.”

Only one attempt has been made to disturb the conclusion here drawn by Davy. In 1868 Prof. Edward Frankland, to whom we are indebted for many important discoveries respecting flame, came to the conclusion that the light-giving agency in flames was not solid carbon, but certain complex vaporous compounds of carbon and hydrogen. I regret very much that time will not admit of my detailing the evidence in favour of this view, or the counter evidence by means of which most chemists have been persuaded that Davy's explanation was, after all, the correct one. It is, however, right to remark that Prof. Frankland not only adheres to his own view, but promises to adduce further evidence in its favour.

Let us for the present, at any rate, stick to the opinion of the majority, and admit that the bright light of ordinary flames is due to incandescence of particles of solid carbon. The next question is, How does this carbon become separated?

This question is dealt with by Davy, but in language of some ambiguity. He says, “I was led to imagine” . . . that it “might be due to the *decomposition* of a part of the gas towards the interior of the flame where the air was in smallest quantity, and the deposition of solid charcoal which first by its *ignition*, and afterwards by its *combustion* increased in a high degree the intensity of the light.”

Whatever these words may have been intended to mean, or whatever interpretation is the fair one, it is certain that Davy's explanation was soon presented as if it implied lack of air to be the chief cause of carbon separation. As there was a large quantity of hydrocarbon, and only a small amount of oxygen in the central parts of flame, the hydrogen, it was said, being the more inflammable element, will seize upon this oxygen and leave the carbon uncombined. The fact that this view was given by Faraday lends some countenance to the belief that it was a fair representation of Davy's view.

Now this doctrine was really incompatible with facts known, though apparently not widely known, at the time. I have already referred to the fact that Dalton at the beginning of the century showed that when a hydrocarbon is exploded with a supply of oxygen insufficient to burn both the hydrogen and the carbon, it is the carbon, and not the hydrogen, which has the preference. If, therefore, we follow Davy in regarding flame as a tethered explosion, we cannot explain the separation of carbon as being due to the preferential combustion of the hydrogen. This fact was clearly pointed out by Kersten in 1861, but notwithstanding this, and other investigations tending to the same conclusion, the old view has somehow kept its ground down to the present day.

We must now turn to the alternative explanation. It is supplied by the words, and I think, by the intention, of Davy. He says that the carbon separation might be due to the *decomposition* of the gas towards the interior of the flame. If this decomposition be not due to chemical action, it must be due to heat; and certain it is that hydrocarbons when strongly heated do decompose, and do deposit carbon. Here is a result of this action occurring on the large scale. This gas-carbon, as it is called, is deposited in gas-retorts owing to the action of intense heat on the hydrocarbons of the gas.

In another place Davy says: “I have shown in the paper referred to in the introduction, that the light of common flames depends almost entirely upon the deposition, ignition, and combustion of solid charcoal, but to produce this deposition from gaseous substances demands a high temperature.”

This explanation of carbon separation in flames seems perfectly adequate and free from objection. There is, as we have seen, surrounding all ordinary hydrocarbon flames a shell of almost non-luminous combustion. The gas which passes upwards within this shell must be highly heated, and in the absence of air will be decomposed so as to deposit solid carbon. This carbon is intensely heated, and glows, and as it reaches the air will burn to form carbon dioxide. The fact that the upper parts of flame are the most luminous in itself indicates that the more we roast the gas the more do we separate the carbon; and there are other proofs, which I cannot stop to explain.

We have now got pretty well to the end of the explanation of the structure of ordinary luminous flames, and I will show you an experiment which epitomises the explanations that have been given.

We turn once more to the cone-separating apparatus, and use as fuel a substance particularly rich in carbon. This substance, benzene, is a liquid, so I shall have to vaporise it by means of a current of air. When I apply a light to this current of air strongly impregnated with benzene, we get, as you see, a very bright flame. This flame exhibits the usual structure. This is one extreme. Now I will reduce the amount of benzene vapour very rapidly without altering the air, and we shall get the other extreme, that is, a scarcely luminous flame consisting of one single cone. The whole of the combustion is now taking place in a single cone of flame. If I still further reduce the benzene, this flame enlarges slightly and becomes paler. There is now excess of air. A little less benzene still, and you see the flame rises from its perch and disappears; we have got past the limit within which combustion is possible. Let us next move in the other direction, and gradually increase the supply of benzene to the single cone. It becomes smaller and brighter as we proceed up to a certain point. At length we have evidently got more benzene than there is air to burn, and now appears the second cone at the top of the tube. By sliding the tubes we can unite the flame and make a Bunsen flame. Separating the cones again, let us add still more benzene. The result is very remarkable. The two cones remain intact, but stretching between them are thin luminous streaks of glowing carbon. The excess of benzene is being decomposed by the heat, so that the carbon separates and glows. The more benzene I add the broader do these streaks become, until eventually the inner cone ascends, the luminous streaks coalesce, and we have the ordinary luminous hydrocarbon flame.

I have now put before you the considerations and methods which will serve, I believe, for the elucidation of all problems of flame structure. I am not aware, at any rate, of any flame which does not accord with the general principles which I have explained to you.

There are many other flame problems besides that which relate to mere structure. Of these one of the most interesting concerns the colouration of flame. I will refer to it for a moment

only to show how closely that question is connected with the points we have been discussing. I have here a gas flame to which I feed air until its yellow luminosity has disappeared. If I add to the air supply the fine spray of a dissolved copper salt, the flame assumes a green tint characteristic of the metal. This green tint seems to belong to the whole flame, but if we dissect it by the apparatus already so often used, we find that the green tint is developed only in the outer cone. It is due, in fact, to oxide of copper, which can only exist on the outside of the flame. Similar peculiarities are noticed with some other coloured flames, and it is hoped that their study, which leads us into the domain of spectrum analysis, will yield some interesting information on points which are at present very obscure.

I have directed your attention this evening to terrestrial flames of small dimensions, but in conclusion I should like to remind you that at one time there were probably quite other flames upon this earth. The globe we inhabit is in the process of cooling and of oxidation; at one time we believe, in fact we know, that it was incandescent. If we take a chemical retrospect and imagine as we recede in time our present cool earth becoming hotter, we may follow out some interesting changes. We should soon reach a temperature too high for the persistence of liquid water; our oceans would be evaporated and surround the globe as an envelope of steam. In remoter times and at higher temperatures this steam could not exist even as steam, but would be dissociated into hydrogen and oxygen. At that time, too, many of the elements now existing as oxides in the solid crust of the earth would be floating in a gaseous state in the vast atmosphere. Let us stop our retrospect at this point, and look towards the present with a cooling earth. At a certain point chemical combination must have begun in the fringe of the ancient atmosphere, and it must have been the scene of colossal chemical activities, the hydrogen and vaporous metals flashing into their oxides. On gravitating to hotter regions, these combinations may have been again undone, the elements sent again into circulation. How long such a period may have lasted we need scarcely stop to ask. If the retrospect is reasonable, it is enough. It is interesting to think how such an earth as we have pictured must have resembled the sun as we know it at the present day.

There was formerly a chemical theory of the sun, which ascribed both its heat and light to the act of chemical combination. That theory has long since been refuted and discarded, and with it ordinary laboratory chemistry banished from that luminary as altogether unsuited to its high temperature. There is cause, I think, to ask if this is quite warrantable. We know extremely little of chemistry at high temperatures, but if the sun could be shown to have its reasonable share of oxygen, we might well ask if its surface phenomena were not largely ascribable to ordinary chemical activities and of the nature of flames. It is certainly remarkable, when we consider the unity of plan in which heavenly bodies are seen more and more to move and have their being, that the sun should not exhibit the possession of its fair share of that element—oxygen—which has ruled the chemistry of the earth throughout all geological time and long precedent ages of its evolution. But this is ground which the terrestrial chemist must tread with care. He still has many unsolved problems lurking in the flame of a common candle, and flame, wherever we find it, is still a mystery.

"The power of *Fire or Flame*," says Carlyle, "which we designate by some trivial chemical name, thereby hiding from ourselves the essential character of wonder that dwells in it as in all things was with the old northmen *Loke*, a most swift subtle *Demon* of the brood of the *Jötnuns*. The savages of the *Landrones Islands* too (say some Spanish voyagers) thought *Fire*, which they never had seen before, was a devil or god, that bit you sharply when you touched it, and that lived upon dry wood. From us, too," adds Carlyle, "no Chemistry, if it had not stupidity to help it, would hide that *Flame* is a wonder."

#### UNIVERSITY AND EDUCATIONAL INTELLIGENCE.

OXFORD.—On Monday, the 20th inst., Prof. E. B. Poulton, the President of the Ashmolean Society, gave a *conversazione* in the University Museum, which was numerous attended by members of the city and University, who were specially invited to meet the Local Executive Committee of the British Association. The features of the entertainment were: an interesting

lecture on features in the past history of science in Oxford, by Mr. Falconer Madan; physical experiments, by Prof. Clifton and Mr. J. Walker; exhibits of various entomological specimens from the Hope Collection; glass-blowing, by Herr Zitzmann; living animals and museum preparations, by Dr. Benham and Mr. Goodrich; physiological exhibits, by Messrs. Pembrey, Gordon, and Howard; and many other exhibitions which cannot be noticed for want of space.

The Junior Scientific Club, whose proceedings have been hitherto published in a somewhat haphazard manner, have decided to issue a series of fortnightly numbers, each of which contains an account of the papers read at the previous meeting. The first of these was published on the 17th inst., and is in all respects a credit to its editor. It contains, besides abstracts of papers read by Messrs. M. H. Gordon, S. A. Simon, and W. J. Waterhouse, a syllabus of all the papers read before the club during the past year, an obituary, and notes on the distinctions gained during the past year, by present and former members of the club.

At a meeting of Convocation held on Tuesday last, Dr. Arthur Thomson, University Reader in Human Anatomy, was appointed Professor of Human Anatomy.

CAMBRIDGE.—Mr. M. R. James, of King's College, has been appointed Director of the Fitzwilliam Museum in succession to Prof. Middleton.

An election to an Isaac Newton studentship in astronomy, astronomical physics, and physical optics, will be held in the Lent Term 1894. The candidates must be B.A.s and under the age of twenty-five. The studentship is worth £200 a year for three years. Applications to be sent to the Vice-Chancellor by January 26, 1894.

A syndicate has been appointed for the purpose of obtaining specifications and tenders for the erection of the Sedgwick Memorial Museum of Geology, in accordance with the plan of Mr. T. G. Jackson.

An influential deputation waited upon the Chancellor of the Exchequer on Tuesday in order to place before him the necessity for continuing, and, if possible, increasing, the Parliamentary grant of £15,000, which was conceded to the University Colleges in 1889. Sir W. Harcourt said that though he was prepared to recommend the renewal of the grant, the present condition of public finances would not permit him to propose its increase.

#### SCIENTIFIC SERIALS.

*American Journal of Science*, November.—On New England and the Upper Mississippi basin in the glacial period, by James D. Dana. During the recent discussions concerning the unity or otherwise of the glacial epoch in North America, it has appeared that workers in the central and western portions have mostly advocated two glacial epochs, while New England geologists have been the chief advocates of unity. The author has not found any facts in New England geology that require for their explanation an appeal to two glacial epochs, but has found an explanation of the appearances which have led western geologists to that opinion. The cause of this sectional divergence is mainly meteorological. Even at the present time, the precipitation in the east is far above that of the west, and in the glacial epoch the difference must have been still greater, owing to the greater elevation of the east. The conditions of the ice-sheet in the interior being near the critical point, a small meteorological change, if long continued, might carry off the ice for scores or hundreds of miles from a southern limit, while the eastern border was all the time gaining in ice, or was making only a short retreat.—On the use of the name "Catskill," by John J. Stevenson. Mr. Darton's suggestion that the term Catskill should be applied to the whole of the Upper Devonian period is inappropriate, since Catskill has been shown to belong to an epoch only, whereas "Chemung" carries with it the conception of those physical and biological characteristics which mark the great closing period of the Devonian.—The finite elastic stress-strain function, by G. F. Becker. This is an investigation of finite stress and strain from a kinematical point of view, and of the function which satisfies the kinematical conditions consistent with the definition of an isotropic solid. The bearing of the theory upon finite sonorous vibrations is compared with the corresponding deductions from Hooke's incomplete law.—A larval form of *Triarthrus*, by C. E. Becher. Since the discovery of antennæ and other appendages of this



trilobite by Mr. W. D. Muttew, it has been possible, with the new material supplied to the Vale Museum, to trace its development back to the earlier stages. Larval specimens have been found in which the thorax is undeveloped and the cephalon predominates, while the other parts are not clearly differentiated. The larva is ovate in outline. The frontal margin is marked by a convex fold of the test. The axis is annulated. Near the lateral anterior margins are two slight elevations which may represent the palpebral lobes of the eyes.

*American Journal of Mathematics*, vol. xv. No. 4.—On toroidal functions, by A. B. Basset (pp. 287-302). The theory of these functions was first investigated by Prof. W. M. Hicks, in his discussion of the motion of circular vortex rings (*Phil. Trans.* 1881). The author considers that Prof. Hicks presented the subject in a somewhat complicated form, and the object of his own communication is to develop the subject, and to correct errors which he attributes to Prof. Hicks. The memoir appears to be on the lines of a communication Mr. Basset made to the London Mathematical Society (April 13, 1893).—Simple groups as far as order 660, by F. N. Cole (pp. 303-315). This is a continuation of a paper in vol. xiv., in which it was shown that the orders of simple groups between the limits 200 and 500 are restricted to two possibilities, 360 and 432. In the present memoir the order 432 is shown to be inadmissible, and the order 360 to furnish only one type of a simple group. Two other simple groups are shown to present themselves, of orders 504 and 660 respectively. The order 504 "seems hardly to have been recognised hitherto." It was a singular fact, pointed out at the November meeting of the London Mathematical Society, that this memoir anticipated some results in Prof. W. Burnside's notes on the theory of groups of finite order. The latter had evidently arrived at his result quite independently of Dr. Cole.—On the expansion of functions in infinite series, by W. H. Echols (pp. 316-320).—The elliptic inequalities in the lunar theory, by E. W. Brown (pp. 321-338). This is a resumption of the author's paper from p. 263.—On the multiplication of semi-convergent series, by F. Cajori (pp. 339-343). The writer's object is to extend results given by A. Voss, in the *Math. Ann.* (vol. xxiv. p. 44).—On certain ruled surfaces of the fourth order, by T. F. Holgate (pp. 344-386). An introductory section is historical, and refers to previous memoirs on the subject. The author considers those species of the surface of the fourth order which may be generated by two projective sheaves of planes of the second order. These admit of a trinodal quartic section, and are consequently of deficiency zero. The volume concludes with a note on the so-called quotient  $G/H$  in the theory of groups by Prof. Cayley, (pp. 387-8), and the index of contents.

## SOCIETIES AND ACADEMIES.

LONDON.

Physical Society, November 10.—Prof. A. W. Rücker, F.R.S., President, in the chair.—A paper on the separation of three liquids by fractional distillation, by Prof. F. R. Barrell, G. L. Thomas, and Prof. Sydney Young, F.R.S., was read by Prof. Young. Accepting the results obtained by F. D. Brown in his experiments on the variation in the composition of the distillate from a mixture of two liquids, viz. that the relative quantities of the two substances in the vapour at any instant are proportional to the weights of the substances in the still, multiplied by the ratio of their vapour pressures, the authors write Brown's equation in the form  $\frac{d\xi}{d\eta} = c \frac{\xi}{\eta}$ , where  $\xi$  and  $\eta$  are the weights of the two liquids in the still, and  $c$  the ratio of their vapour pressures. Taking  $c$  as constant, the above equation is integrated, and from the resulting expressions curves are plotted showing the changes in composition that take place during the distillation. Assuming that a similar law holds for three liquids, A, B, and C, viz.  $\frac{1}{a} \frac{d\xi}{\xi} = \frac{1}{b} \frac{d\eta}{\eta} = \frac{1}{c} \frac{d\zeta}{\zeta}$ , the composition of the distillate at any instant is calculated. Taking  $a = 4$ ,  $b = 2$ , and  $c = 1$  (numbers nearly proportional to the vapour pressures of methyl, ethyl, and propyl acetates), numerous curves are plotted showing the progress of the separation at various stages of fractionation. These curves show distinctly that although fractions containing large proportions of the liquids

A and C, of lowest and highest boiling points respectively, can be easily separated, the middle substance, B, is much more difficult to obtain in a state of purity. Consideration of these curves led the authors to see that by carrying out the fractionation in a particular way, it was possible to separate the mixture into two portions, one containing only A and B, and the other B and C. These mixtures of two liquids could then be fractionated in the usual manner. This process was carried out on a mixture of methyl, ethyl, and propyl acetates, the results of which are given in considerable detail in the paper. The remarkable agreement between the densities of the ethyl acetates obtained respectively from the mixtures A and B, and B and C, as well as the fact that the densities of the separated liquids were the same as before the mixing, show conclusively that the method employed was highly successful. Prof. Ramsay said the paper was a most valuable one, and would be a great aid to chemists. Distillations were usually carried out by mere "rule-of-thumb," with the result that absolutely pure liquids could rarely be obtained. The President inquired whether curves representing the progress of distillation could be constructed from the very complete experiments made, and so test the assumed law. Prof. Young thought this not possible from the numbers obtained. To test the law in this way would be very laborious.—A note on the generalisations of Van der Waals regarding "corresponding" temperatures, pressures, and volumes, was read by Prof. S. Young. In November 1891 the author read a paper on the same subject (*Phil. Mag.* February 1892), and gave the critical molecular volumes of some twelve substances as calculated by M. Mathias. Since then a few small errors have been found in the calculation, and the authors' corrected values are now given. The vapour pressures, molecular volumes and critical constants of ten esters (methyl formate, acetate, propionate, butyrate, and isobutyrate, ethyl formate, acetate and propionate, and propyl formate and acetate) have recently been determined (*Trans. Chem. Soc.* lxxiii. p. 1191). In the present paper the absolute temperatures and volumes of the twelve substances are given in terms of their critical constants, and tables given showing, respectively, the ratios of boiling points (abs. temps.) at corresponding pressures, to absolute critical temperatures; the ratios of volumes of liquid at corresponding pressures to the critical volumes, and ratios of volumes of saturated vapours at corresponding pressures to critical volumes, for the halogen derivatives of benzene, carbon tetrachloride, stannic chloride, ether; methyl, ethyl, and propyl alcohols, and acetic acid; and the extreme values for the ten esters previously mentioned. Whilst showing fair agreement with each other, the differences between them exceed errors of experiment. The ratios also indicate that the substances can be arranged in four groups, thus tending to show that molecular weight and chemical constitution have some influence on the results. The differences found would probably result from the presence of complex molecules, such as are known to exist in acetic acid.

If Van der Waals's generalisations were strictly true, the ratio  $\frac{p}{T}$  at the critical point should be constant for all substances, as also the ratio  $\frac{D}{D_0}$  of the actual to the theoretical density (for a perfect gas) at the critical point. On comparing these quantities only a rough approximation is found, but the grouping of the compounds is again well marked. Prof. Ramsay was not sure that the existence of complexes would alter the molecular volume in the liquid state, for liquids seem very compact. Experiments on the surface energy of liquids had proved that complex molecules do exist in the alcohols and acetic acid. Dr. Young's conclusions were therefore confirmed by experiments of an entirely different nature. Prof. Herschel was gratified to see Van der Waals's theory so well borne out in liquids, and hoped to see it extended to solids. The recent researches of Prof. Robert Austen on alloys seemed to point in this direction. Mr. Rogers said molecular complexes do exert an influence on the properties of substances, as had been shown by Prof. Thorpe's viscosity experiments. Van der Waals's generalisations should therefore be looked at from a chemical as well as a physical point of view. The President thought the number brought forward showed fair agreements, especially when it was remembered that Van der Waals took no account of complex molecules. Contrary to Prof. Ramsay, he would rather expect aggregation to affect the molecular volumes in the liquid state, for only about one-fifth the space was supposed to be occupied by matter. On the other hand, the relatively

small contraction of liquids on cooling did not support this view.—An instrument for drawing conic sections was exhibited and described by Mr. J. Gillett. This consists of a spindle inclined to a plane board, and a tube fixed to the spindle at an angle. A pencil which passes through the tube traces out a cone in space as the spindle is turned, and on sliding the pencil through the tube, so as to keep its point against the plane, the point traces out a conic, the section of the cone made by the plane of the board. A circle, ellipse, parabola, or hyperbola, can be drawn according to the inclination of the spindle to the board. Prof. Henrici said a similar instrument had been described in an Arabian manuscript a thousand years old, and has been independently re-invented by both a German and an Italian mathematician. He thought the fact of the angle between the spindle and the tube in Mr. Gillett's instrument not being adjustable was a disadvantage. Mr. Inwards and Prof. Herschell also took part in the discussion, to which Mr. Gillett replied.

Geological Society, November 8.—W. H. Hudleston, F.R.S., President, in the chair.—The following communications were read:—The geology of Bathurst, New South Wales, by W. J. Clunies Ross. After sketching the physiography of the Bathurst district, the author described in detail its stratigraphy. The oldest sedimentary rocks are Silurian, but the floor on which they rest is unknown, and the author stated that it was probably fused up and incorporated in the granite, which is described in the paper. The Silurian rocks may have been folded before the granite was erupted; in any case, the granite produced a zone of contact-metamorphism, whilst almost all the Silurian rocks may be considered to be examples of regional metamorphism, though the agents producing the metamorphism were least active to the east of Bathurst, where the Silurian limestones are very little altered. An anticlinal was probably produced at the time of the granitic intrusion. After a time there was subsidence, but at first it need not have been very extensive, since the Devonian conglomerates, sandstones, and shelly limestones were probably deposited in a comparatively shallow sea. They contain *Lepidodendron australe*. At Rydal they abut against the uplifted Silurian rocks of the Bathurst area. At the end of Devonian times there appears to have been a long interval, during which both Silurian and Devonian rocks were greatly denuded, and the granite exposed in places. The Upper Carboniferous and Permian rocks were deposited in the Lithgow district, but it is doubtful if they ever extended to Bathurst. There is nothing to show what happened in this region during Mesozoic and early Tertiary times. The Hawkesbury Sandstone (probably Triassic) may have approached nearer to Bathurst than it does now. In late Tertiary times stream-deposits were formed on the granitic rocks, and afterwards covered with thick basaltic lava-flows, which have since undergone much denudation. A discussion followed, in which the President, the Rev. H. H. Woodward, and Mr. J. E. Marr took part.—The geology of Matto Grosso (particularly of the region drained by the Upper Paraguay), by Dr. J. W. Evans. The district includes a portion of the Brazilian hill-country, and also of the low-lying plains to the south-west. The rocks principally dealt with are unfossiliferous, and of unknown age, except that they appear to be older than the Devonian. They may be classified as follows:—(5) Matto Shales (relations not shown); (4) Rizama Sandstone (perhaps some unconformity); (3) Curumá and Arara Limestones (very marked unconformity); (2) Cuyabá Slates (strong unconformity); (1) ancient crystalline rocks. The Devonian and later rocks were briefly described. The President, Mr. Spencer Moore, fellow-traveller with Dr. Evans in Matto Grosso, Mr. H. Bauerman, and Mr. R. D. Oldham spoke on the subject of the paper.—Notes on the occurrence of mammoth-remains in the Yukon district of Canada and in Alaska, by Dr. George M. Dawson, C.M.G., F.R.S. In this paper various recorded occurrences of mammoth-remains were noted and discussed. The remains are abundant in, if not strictly confined to, the limits of a great unglaciated area in the north-western part of the North American continent; whilst within the area which was covered by the great ice-mass which the author has described as the Cordillerian glacier, remains of the mammoth are either entirely wanting or are very scarce. At the time of the existence of the mammoth the North American and Asiatic land was continuous; for an elevation of the land sufficient to enable the mammoth to reach those islands of the Bering Sea, where these bones have been found, would result in the obliteration of Bering Straits. The bones occur, along

the northern coast of Alaska, in a layer of clay resting on the somewhat impure "ground-ice formation" which gives indications of stratification; and above the clay is a peaty layer. The author considered this "ground-ice" was formed as a deposit when more continental conditions prevailed, by snow-fall on a region without the slopes necessary to produce moving glaciers. The mammoth may be supposed to have passed between Asia and America at this time. At a later date, when Bering Straits were opened and the perennial accumulation of snow ceased on the lowlands, the clay was probably carried down from the highlands and deposited during the overflow of rivers. Over this land the mammoth roamed, and wherever local areas of decay of ice arose bogs would be produced which served as veritable sink traps. The author considered it probable that the accumulation of "ground-ice" was coincident with the second (and latest) epoch of maximum glaciation, which was followed by an important subsidence in British Columbia. In the discussion of the paper, Sir Henry Howorth remarked upon the long and careful survey of North-West America which has been made by the author, and upon the value of the conclusions which he has come to: firstly, in regard to the absence of ancient glaciation in Alaska and its borders; secondly, in regard to the existence of a great glacier in the Cordilleras, whose products are quite independent of and have nothing to do with the Laurentian drift; and thirdly, in regard to the distribution of the mammoth. It was a new fact to him, and one of great importance, that mammoth-remains had occurred in Unalaska and the Pribilof Islands in Bering Straits, proving that in the Mammoth age there was a land bridge here, as many inquirers had argued. It would be very interesting to have the western frontier defined where the mammoth-remains cease to be found. It would be very interesting to know how far south on the west of the Cordilleras the true mammoth, as distinguished from *Elephas Columbi*, has occurred. Regarding one conclusion of Dr. Dawson's, Sir Henry could not agree with him, namely, about the age of the strata of ice sometimes found under the mammoth-beds in Alaska as they have been found in Siberia. The speaker was of opinion that this ice had accumulated since the beds were laid down, and was not there when the mammoth roamed about in the forests where he and his companions lived. Humus and soil cannot accumulate upon ice except as a moraine, and there are no traces of moraines or of great surface-glaciation in Alaska and Siberia. Nor could either the flora or fauna of the mammoth age have survived conditions consistent with the accumulation of these beds of ice almost immediately below the surface, or consistent with their presence there. The speaker considered that these beds were due to the filtration of water in the summer down to the point where there is a stratum of frozen soil, through which it cannot pass and where it consequently accumulates, freezes, raises the ground, and in the next season grows by the same process until a thick bed of ice has been formed. The evidence goes to show that the present is the coldest period known in recent geological times in Siberia and Alaska, and that the period of the mammoth and its companions was followed and not preceded by an Arctic climate where its remains occur. Dr. H. Woodward remarked that the most interesting point in Dr. Dawson's paper was the mention of the remains of mammoth on the Aleutian Islands, proving that this was the old high road for this and other mammals from Asia into North America in Pleistocene times.

Linnean Society, November 2.—Prof. Stewart, President, in the chair.—The secretary having read a list of the donations to the library since the last meeting, the President moved that the thanks of the society be given to the donors and to Lady Arthur Russell for the valuable collection of engraved portraits of naturalists which she has been so good as to present to the society in the name of her husband, the late Lord Arthur Russell, a motion which was passed unanimously. The President then referred to the improvement which had been carried out during the recess in the society's apartments by the introduction of the electric light, for which they were indebted to the liberality of the treasurer, Mr. Crisp, who on former occasions had shown himself so generous a benefactor, and moved that the hearty thanks of the society be given to Mr. Crisp for his munificent present. The resolution was carried by acclamation. Referring to the deaths of Fellows of the society which had occurred since the last meeting, the President alluded especially to the Rev. Leonard Blomefield, whose connection with the society, extending over seventy years, had recently been made the subject

of a congratulatory address, to Mr. F. Pritchard, the distinguished entomologist, and to Mr. George Brook, whose lamented decease had caused the vacancy in the Council which they now had to fill. The ballot having then been taken for the election of a new councillor in the place of Mr. George Brook, deceased, Mr. Henry Seebohm was declared to have been elected.—Mr. George Murray exhibited and made remarks on a series of slides mounted on lantern slides, some of which were new to Great Britain. He also showed some specially prepared slides which were recommended for collecting purposes, but which in the opinion of some present would be likely to become speedily useless from oxidation.—Mr. Holme showed some new British marine algae, and made remarks on their affinities.—Dr. Prior exhibited the fully developed fruit of *Pyrus japonica* from Rogate, Sussex, seldom seen, although the plant is common, and alluded to its use as a conserve if it could be obtained in sufficient quantity.—Mr. Spencer Moore read a paper on the phanerogamic botany of an expedition to Mato Grosso, upon which he acted as botanist. Starting from Cuyaba, the expedition first visited the Chapala Plateau, to the east of that city, where many plants were collected. Thence a journey was made to the new settlement of Santa Cruz, on the Parana, about half-way between Villa Maria and Diamantina. The flora here is of mixed character, nearly 37 per cent. of the plants being common to tropical South America, upwards of 27 per cent. occurring in the N. Brazil Guiana province of Engler, with 20·5 per cent. common to that province and the S. Brazilian, and only 13 per cent. of S. Brazilian types. From Santa Cruz a party penetrated through the primeval forest lying to the north, and reached the Serra de Sapirapan. The forest flora is markedly Amazonian in character, nearly 50 per cent. of the plants being natives of Amazonia or of the neighbouring countries within the N. Brazil Guiana province, or related thereto, while the proportion of species common to tropical America falls to rather more than 28 per cent. the S. Brazilian element being present only to the extent of 9·5 per cent. Returning to Santa Cruz, the Rio Braçisto was partly explored, and the Parana ascended to the neighbourhood of Diamantina. The party then came down the Parana to the Corumbá, where many plants of interest were found. The expedition was partly disbanded at Asuncion. Among the Amazonian plants found at Santa Cruz, or in the forest, may be mentioned *Randia Ruiziana*, *Bertiera guianensis*, the Loranthid *Oryctanthus rufi-aulis*, *Cattleya superba*, *Epidendrum imitabile*, *Rodriguezia scruvula*, &c. The collections comprise close upon 700 species, of which rather more than 200 were considered to be new, and referable to eight new genera. The southward extension of the Amazonian flora to a latitude well within the Parana River system was regarded as a noteworthy feature.—On behalf of Mr. G. M. Thomson, of Dunedin, N.Z., Mr. W. Percy Sladen read a paper on a new freshwater Schizopod from Tasmania, illustrating his remarks with graphic sketches on the blackboard to indicate its affinities and differences.

**Entomological Society, November 8.**—Henry John Elwes, President, in the chair.—Mr. F. Merrifield exhibited some low-temperature forms of *Vanessa atalanta*, artificially produced, which showed a great reduction in the area of the scarlet bands on the wings, and a great increase in the area of the white and bluish markings.—Prof. E. B. Poulton, F.R.S. described and illustrated, by means of a map, a simple method for showing the geographical distribution of insects in collections. Below the name label of the genus, and of each species, were placed coloured slips of such a size as to be distinctly visible at a distance, and the colours, with one exception, corresponded with those made use of in the map at the beginning of vol. i. of Dr. A. R. Wallace's "Geographical Distribution of Animals." The exception referred to was the Palearctic region, which was coloured blue, instead of pale brown as in the original. Framed maps of the same kind, and coloured in the same way as the one he exhibited, were to be placed in museums, so as to be readily seen from various groups of cabinets. In these maps the names of the regions, and numbers of the sub-regions, were distinctly printed, so that they could be read at a considerable distance. Prof. Poulton added that the method he had described was being gradually introduced into the Hope Collections at Oxford. Mr. McLachlan, F.R.S., stated that a somewhat similar plan to that described for showing the geographical distribution of insects has been adopted in the Brussels Museum by M. Preudhomme de Borre. Mr. W. F. H. Blandford, Dr. D. Sharp, F.R.S., Mr. C. J. Gahan,

Mr. C. O. Waterhouse, Mr. Osler Salvin, F.R.S., Prof. Poulton, and the President continued the discussion.—Dr. Sharp read the following extract from Dr. Livingstone's "Narrative of an Expedition to the Zambesi" and stated that he was indebted to Mr. Gahan for calling his attention to it:—"We tried to sleep one rainy night in a native hut, but could not because of attacks by the fighting battalions of a very small species of *Formica*, not more than one-sixteenth of an inch in length. It soon became obvious that they were under regular discipline, and even attempting to carry out the skillful plans and stratagem of some eminent leader. Our hands and necks were the first objects of attack. Large bodies of these little pests were massed in silence round the point to be assaulted. We could hear the sharp, shrill word of command two or three times repeated, though until then we had not believed in the vocal power of an ant; the instant after we felt the storming hosts overhead and neck."—Prof. Poulton read a paper entitled "On the sexes of larvae emerging from the successively laid eggs of *Smerinthus populi*." Mr. Merrifield, Dr. Sharp, and the President took part in the discussion which ensued.—Mr. W. L. Distant communicated a paper entitled "On the Homopterous genus *Pyrops*, with descriptions of two new species."—The President read a paper, written by himself and Mr. J. Edwards, entitled "A revision of the genus *Eneis*," which he characterised as the most cold-loving genus of butterflies. He also exhibited his complete collection of species of this genus. A long discussion ensued, in which Prof. Poulton, Mr. McLachlan, Mr. Salvin, Mr. Bethune-Baker, the Rev. Dr. Walker, Mr. Kirby, Mr. Merrifield, Mr. Barrett, Mr. Blandford, Dr. Sharp, and Mr. Jacby took part.

**Zoological Society, November 7.**—Sir W. H. Flower, K.C.B., F.R.S., President, in the chair.—Mr. Selater read some notes on the most interesting animals he had seen during a recent visit to the Zoological Gardens of Stuttgart, Frankfurt and Cologne.—An extract was read from a letter addressed to the Secretary by Mr. J. G. Millais relating his endeavours to obtain specimens of the White Rain-forest (*Rainforest sinus*) in Mashanaland.—A communication was read from Babu Ram Bamba Saayal, describing a hybrid monkey of the genus *Semnopithecus*, born in the Zoological Gardens, Calcutta.—Mr. Tegetmeier exhibited a specimen of a hybrid grouse between the blackgame (*Tetrao tetrix*) and the red grouse (*Lagopus scoticus*).—Mr. Boulenger read a paper on a Nothosaurian reptile from the Trias of Lombardy, apparently referable to *Lariosaurus*. His description was based on a small, nearly perfect specimen from Mount Perledo, showing the ventral aspect, belonging to the Senckenberg Museum in Frankfurt-on-Main, which had been entrusted to him by the directors of that institution, and was exhibited before the meeting. The author pointed out the presence of a series of minute teeth on the pterygoid bones, and of an entepicondylar (ulnar) foramen in the humerus. The number of phalanges was 2, 3, 4, 4, 3 in the manus, and 2, 3, 4, 5, 4 in the pes; the terminal phalanx was flattened and obtusely pointed, not claw-shaped. In discussing the affinities of this reptile the author stated that the *Lariosaurus* described by Diecke did not appear to be generically distinguishable from the *Neusticosaurus* of Seelye, which he referred to the *Lariosauridae*, regarding that family as intermediate between the *Mesosauridae* and the *Nothosauridae*, though nearer the latter. The *Mesosauridae*, in his opinion, formed one sub-order, the *Lariosauridae* and *Nothosauridae* together a second sub-order, of the order *Phososauria*.—Dr. A. Günther, F.R.S., read a second report on specimens of reptiles, batrachians, and fishes transmitted by Mr. H. H. Johnston, C.B., from British Central Africa. Dr. Günther also read descriptions of some new reptiles and fishes, of which specimens had been obtained on Lake Tanganyika by Mr. E. C. Cole-Hore.—Mr. Edgar A. Smith gave an account of a collection of land and freshwater shells transmitted by Mr. H. H. Johnston, C.B., from British Central Africa. The specimens in this collection, obtained by Mr. R. Crawshaw from Lake Mweru, were almost all new to science.—Mr. Edgar A. Smith also read descriptions of two new species of shells of the genus *Ennea*.—A communication was read from Dr. Arthur G. Butler, containing an account of two collections of Lepidoptera sent by Mr. H. H. Johnston, C.B., from British Central Africa.—A communication was read from Mr. Edwyn C. Reed, containing a list of the Chilian Hymenoptera of the family *Odyneridae*, with descriptions of some new species.—A communication from Prof. Newton, F.R.S. contained the description of a new species of

bird of the genus *Drefanis*, discovered by Mr. R. C. L. Perkins in the island of Molokai, Sandwich Islands.

PARIS.

**Academy of Sciences, November 13.**—M. Lœwy in the chair.—On the new star of 1892, T Aurigæ = 1953 Chandler, by G. Bigourdan (see our Astronomical Column).—Observations of the comets 1893 II. (Rordame) and 1893 c (Brooks, 1893, October 16), made at the Paris Observatory, by the same author. Observations of position are given, extending from November 6 to 8.—Elements of Brooks's comet, by M. Schulhof. The elements of this comet closely resemble those of the comet 1864 I.—Control of the trunnions of a meridian instrument by Fizeau's interferential method, by Maurice Hamy.—Measurement of the absorption of light by thin laminae possessing metallic reflection, by M. Salvador Block.—Determination of the true atomic weight of hydrogen, by M. G. Hinrichs. Taking as abscissæ the weights of hydrogen employed by Keiser, Dittmar, and Morley, in their respective determinations of the atomic weight of hydrogen, and as coordinates the values found, the author has obtained a diagram which indicates that the values vary according to the weight of gas used in the experiments. In his opinion this proves that the ratio of H to O is absolutely as 1 is to 16.—On baryta emetic, by M. E. Maumené.—On the production of sucrose during the fermentation of barley, by M. L. Lindet. The experiments described indicate that sucrose and invert sugar increase proportionally to the decrease of starch during the fermentation of barley.—On the nitrification of prairie lands, by MM. J. Dumont and J. Crochetelle. The following conclusions seem to be justified by the experiments: (1) Nitrification is forwarded in soils rich in humus by the addition of small quantities of potassium carbonate (2 or 3 parts per 1000); on the other hand, large quantities of the carbonate are hurtful. (2) Potassium sulphate is efficacious, and favours the production of nitrates when about seven or eight parts per thousand are used. (3) Chloride of potassium only exercises mediocre action. (4) Sodium carbonate does not appear to favour nitrification.—On the influence of mineral poisons on lactic fermentation, by MM. A. Chassevant and C. Richet. This paper is in continuation of a previous one. The authors divide the toxic action of metallic salts on lactic fermentation into two parts, terming the dose that retards the reproduction and pullulation of the ferment *antigénétiq.ue*, while that which arrests functional activity is called *antibiotique*. It appears that the antigentive dose may be as much as three times greater than the antibiotic dose, though for certain metals the two quantities are the same.

DIARY OF SOCIETIES.

LONDON.

THURSDAY, NOVEMBER 23.

ROYAL SOCIETY, at 4.30.—On the Photographic Arc Spectrum of Electrolytic Iron: Prof. Lockyer, F.R.S.—Magnetic Observations in Senegambia: Prof. Thorpe, F.R.S., and P. L. Gray.—Alternate Current Electrolysis: Dr. Hopkinson, F.R.S., E. Wilson, and F. Lydall.—A Certain Class of Generating Functions in the Theory of Numbers: Major MacMahon, F.R.S.—On the Whirling and Vibration of Shafts: S. Dunkerley.—On Plane Cubics: Charlotte Angus Scott.

INSTITUTION OF ELECTRICAL ENGINEERS, at 8.—The Electrical Transmission of Power from Niagara Falls: Prof. Geo. Forbes, F.R.S. (Discussion).

SANITARY INSTITUTE, at 8.—Metallic Dusts, Cutlery, Tool Making, and other Metal Trade: Dr. Sinclair White.

FRIDAY, NOVEMBER 24.

PHYSICAL SOCIETY, at 5.—The Magnetic Shielding of Concentric Spherical Shells: Prof. A. W. Rücker, F.R.S.—The Action of Electro-Magnetic Radiation on Films containing Metallic Powders: Prof. G. M. Minchin.

A 44 FEET SCIENTIFIC SOCIETY, at 7.—Exhibition of Lantern Slides of Recent Photographs of Volcanoes: L. W. Fulcher.—At 8.—The Dawning of Life: J. Wilson Wiley.

SATURDAY, NOVEMBER 25.

ROYAL BOTANIC SOCIETY, at 3.45.

SUNDAY, NOVEMBER 26.

SUNDAY LECTURE SOCIETY, at 4.—Curiosities of Bird Life: Dr. R. Bowdler Sharpe.

MONDAY, NOVEMBER 27.

ROYAL GEOGRAPHICAL SOCIETY (at the University of London, Burlington Gardens, W.), at 8.30.—Arctic Exploration: Dr. John Murray.

TUESDAY, NOVEMBER 28.

INSTITUTION OF CIVIL ENGINEERS, at 8.—The Tansa Works for the Water-Supply of Bombay: William J. B. Clerke.—The Paroda Water-Works: Jagannath Sadasejee.—The Water-Supply of Jeypore, Rajputana: Colonel S. S. Jacob.—On the Design of Masonry Dams: Prof. Franz Kreuter. (Discussion.)

THURSDAY, NOVEMBER 30.

SANITARY INSTITUTE, at 8.—Textile Manufactures, Silk, Cotton, Woollen, and Linen Industries: Dr. J. T. Arlidge.

FRIDAY, DECEMBER 1.

GEOLOGISTS' ASSOCIATION, at 8.—Notes on a Discovery of Fossils at Little Stairs Point, Sandown Bay, Isle of Wight: Thos. Leighton.—Notes on the Sharks' Teeth from British Cretaceous Formations: A. Smith Woodward.—The Breaking-up of the Ice on the St. Mary River, Nova Scotia, and its Geological Lessons: Geoffrey F. Monckton.

INSTITUTION OF CIVIL ENGINEERS, at 7.30.—Forms of Tensile Test-Pieces: Leonard H. Appleby.

BOOKS, PAMPHLETS, and SERIALS RECEIVED.

Books.—Alembic Club Reprints, No. 4:—Foundations of the Molecular Theory: J. Dalton, &c. (Edinburgh, Clay).—Practical Agricultural Chemistry: J. B. Coleman and F. T. Addyman (Longman).—Methods of Practical Hygiene, 2 Vols.: Prof. Lehmann, translated by W. Crookes (K. Paul).—Suicide and Insanity: Dr. S. A. K. Strahan (Sonnenschein).—Mechanics of Hoisting Machinery: Dr. J. Weisbach and Prof. G. Herrmann, translated by K. P. Dahlstrom (Macmillan).—In the High Heavens: Sir R. S. Ball (Isbister).—Collected Mathematical Papers of Arthur Cayley, vol. vi. (Cambridge University Press).—Cancer, Sarcoma, and other Morbid Growths considered in Relation to the Sporozoa: J. J. Clarke (Baillière).—International Maritime Congress, London, 1893, Sections 1 to 4. Minutes of Proceedings and General Report (Unwin Brothers).—Report of the Commissioner of Education for the Year 1889-90, v. 1s. 1 and 2 (Washington).—Royal Natural History, vol. 1, part 1: edited by R. Lydekker (Waine).—The Beauties of Nature: Sir J. Lubbock, 5th edition (Macmillan).

PAMPHLET.—Owens College Museum Hand-books—General Guide to the Contents of the Museum, 2nd edition (Manchester, Cornish).

SERIALS.—Bulletin Astronomique, October (Paris).—Meteorological Record, vol. xiii. No. 49 (Stanford).—Quarterly Journal of the Royal Meteorological Society, October (Stanford).—Journal of the College of Science, Imperial University, Japan, vol. 6, part 3 (Tokyo).—Journal of the Franklin Institute, November (Philadelphia).—Proceedings of the Aristotelian Society, vol. 2, No. 2, Part 2 (Williams & Norgate).—Brain, Part 63 (Macmillan).—Boletín de la Sociedad Geográfica de Madrid, Tomo 35, Nos. 1, 2, 3 (Madrid).—Journal of Marine Zoology and Microscopy, No. 1 (Jersey, Sinel and Hornell).—Journal of the Polynesian Society, vol. 2, No. 3 (Wellington).

CONTENTS.

PAGE

|                                                                                                                    |    |
|--------------------------------------------------------------------------------------------------------------------|----|
| Watson's Kinetic Theory of Gases. By Prof. P. G. Tait . . . . .                                                    | 73 |
| A History of Crustacea . . . . .                                                                                   | 74 |
| Our Book Shelf:—                                                                                                   |    |
| Mukhopadhyay: "An Elementary Treatise on the Geometry of Conics" . . . . .                                         | 75 |
| Briggs and Edmondson: "The Geometrical Properties of the Sphere" . . . . .                                         | 75 |
| Carroll: "A Key to Carroll's Geometry" . . . . .                                                                   | 75 |
| Letters to the Editor:—                                                                                            |    |
| "Geology in Nubius"—A Reply to Dr. Wallace and Mr. La Touche.—Sir Henry H. Howorth, K.C.I.E., M.P., F.R.S. . . . . | 75 |
| Rock Basins in the Himalayas.—R. D. Oldham . . . . .                                                               | 77 |
| "Composite" Dykes. (Illustrated).—Henry E. Ede . . . . .                                                           | 77 |
| Weismannism.—Dr. George J. Romanes, F.R.S. . . . .                                                                 | 78 |
| Correlation of Solar and Magnetic Phenomena.—A. R. Hinks; William Ellis, F.R.S. . . . .                            | 78 |
| Artificial Amœbæ and Protoplasm.—Dr. John Berry Haycraft . . . . .                                                 | 79 |
| The Royal Society Club . . . . .                                                                                   | 79 |
| The De Morgan Medal . . . . .                                                                                      | 80 |
| Notes . . . . .                                                                                                    | 80 |
| Our Astronomical Column:—                                                                                          |    |
| Mechanical Theory of Comets . . . . .                                                                              | 84 |
| The New Star in Norma . . . . .                                                                                    | 85 |
| The Natal Observatory . . . . .                                                                                    | 85 |
| Magnitude and Position of T Aurigæ . . . . .                                                                       | 85 |
| The Period of Jupiter's Fifth Satellite . . . . .                                                                  | 85 |
| Geographical Notes . . . . .                                                                                       | 85 |
| Flame. (Illustrated.). By Prof. Arthur Smithells . . . . .                                                         | 86 |
| University and Educational Intelligence . . . . .                                                                  | 92 |
| Scientific Serials . . . . .                                                                                       | 92 |
| Societies and Academies . . . . .                                                                                  | 93 |
| Diary of Societies . . . . .                                                                                       | 96 |
| Books, Pamphlets, and Serials Received . . . . .                                                                   | 96 |

THURSDAY, NOVEMBER 30, 1893.

## THE MUMMY.

*The Mummy.* By E. A. Wallis-Budge, LL.D., F.S.A.  
(Cambridge: University Press, 1893.)

TEN years ago, and even less, the English readers of hieroglyphs might be counted on the fingers of one hand, without the thumb. They may now be reckoned by the score. The reasons for this movement—we can hardly term it a revival—are partly the opening of the Nile to any English tourist who can afford to travel at all. This is chiefly due to the ubiquitous Mr. Cook. But it would not be fair to mention it without also mentioning such authors as Dr. Budge, who have made what used to be a sort of secret knowledge, a sort of occult science, into one of the easiest branches of learning any one, especially an Englishman, can study. Hieroglyphs appeal to several different kinds of minds. People pictorially disposed find the representations of all kinds of common objects easy to remember, and very interesting to copy. The naturalist finds these curious old birds, beasts, fishes, and reptiles well worth learning, if only to find out why they stand for letters. The astronomer must work a little at them, on account of the light they throw upon the stars of a time so remote that a *Draconis* was then the Pole Star, and not a *Ursæ Minoris*. To the ordinary lover of languages the grammar of ancient Egypt is full of delightful surprises, as well as pitfalls, while he unravels a tongue spoken by Aryans, with Semitic inflections and Hamitic roots. We might go through the whole catalogue of 'isms and 'ologies, and yet find none in which hieroglyphs would not give some help; and, above all, they are so absurdly easy. The ancient Egyptian was quite determined that whensoever people did learn to read his inscriptions, there should be no kind of mistake as to his meaning, and one result is that many beginners find it possible, without knowing the pronunciation of more than a dozen words, to ascertain the sense of whole passages. There is one thing more. At the very root of all literary learning lies this marvellous invention of the Egyptians. Hieroglyphs are the parents of the writing of the Phenicians, Hebrews, Syrians, Greeks, and Romans; and consequently they are the by no means remote ancestors of our own alphabet, every letter of which is itself a modified hieroglyph. It is therefore curious to remark that the printing and publishing of Dr. Budge's book is the first effort on the part of any university in the three kingdoms to encourage the study of Egyptology. A kind of exception may be made in favour of University College in Gower Street, which accepted a legacy left by the late Miss Edwards to found the chair now occupied by Prof. Flinders Petrie. But the work now accomplished by the Syndics of the Cambridge University Press, must be followed in the sister universities, and there are signs already of a movement in this direction. Dr. Mahaffy of Trinity College, Dublin, is known to have acquired a share in the wisdom of the Egyptians, and the university of Oxford has given the honorary degree of D.C.L. to Mr. Petrie. Under these circumstances, therefore the appearance of Dr. Budge's book is opportune. Only a few

weeks ago a young gentleman was found trying to learn hieroglyphs from Sir Gardiner Wilkinson's six volumes of mingled learning and ignorance. Even in Dr. Birch's great three-volume edition of Wilkinson, there is nothing practical to be gleaned. From this time there will always be a handy work, which can be recommended to the would-be student, a work as profound in linguistic learning as it is easy and simple in communicating it. There are points in which we differ with Dr. Budge, yet we cannot exactly impute them to him as errors. For example, we do not always like his transliterations, in which he is loyal to the system now long in vogue among the best class of scholars on the continent. He has not gone in for the recent French absurdities in this respect, nor, on the other hand, has he followed Herr Erman into his impossible quests after exact pronunciation. This is not the only point on which we are inclined to quarrel with that learned and whimsical German; but it must not for a moment be supposed that there is anything controversial about the calm pages of Dr. Budge's "Mummy." On the contrary, when we consider that there is not a statement in the book that has not at one time or another been called in question, not a chapter that has not been fiercely debated, we must concede to the author a credit for moderation very remarkable. True, he has disdained even to mention the difficulties to which such books as the French catalogue of the Gizeh Museum, or M. Maspero's later works, expose a student. The method pursued by Dr. Budge is the safest. Conceivably, better systems may be constructed, but we must remember that it is by the present system that the great discoveries of Lieblein, Lepsius, Mariette, Birch, and so many others have been made.

Dr. Budge tells us in the preface that this volume was originally written to form the introduction to the *Catalogue* of the Egyptian collection in the Fitzwilliam Museum. It is, however, a complete book in itself, and forms, in a series of condensed, but perfectly clear essays, a very handy encyclopædia of all branches of Egyptology. The first five chapters are historical, and are followed by a list of the dynasties and the dates assigned to them by different authorities. The divergences here are startling. Champollion Figeac placed the first dynasty at B.C. 5867; Wilkinson at B.C. 2320. Dr. Budge evidently prefers the B.C. 4400 of Brugsch. Lists of nomes and of cartouches follow, and then we have one of the most interesting chapters in the book, that on the Rosetta stone and the recovery of the Egyptian alphabet. The priority of Young to Champollion is clearly made out, though Herr Erman is doubtful; and Mr. Renouf prefers the claims of Champollion. But Dr. Budge clearly proves that, though Young has precedence of Champollion, Akerblad, a Swede, has precedence of both. Some fifty pages are occupied by this interesting discussion, and then we come to the "piece of resistance," the title rôle of the whole book, namely, the Mummy. An Egyptian funeral is minutely described. Next, we are told how the mummy was prepared; a subject to which we must briefly return when we have described the rest of the contents. Mummy cloth, embroideries, canopic jars and chests, come next. Eight pages are devoted to the Book of the Dead, and then we have a careful description of the different amulets, such as inscribed

scarabs, figures, hearts, and so on, which are found in tombs. The names and figures of forty-six gods are next identified, and after them twenty-eight sacred animals. There are some interesting notes on coffins, followed by accounts of pyramids, mastabas, and tombs. A chapter contains particulars of Egyptian writing; and after some minor articles the book concludes with two lists, one of common hieroglyphic signs, and one of the determinatives most frequently observed. As the determinative is always the beginner's surest guide, this last list will probably be taken first by many readers. The scope and probable usefulness of this remarkably complete treatise will have been gathered from the above summary.

We now turn back to the middle of the volume. Dr. Budge cannot decide whether the art of mummifying was known to the aboriginal inhabitants of the lower Nile valley, or was imported from Asia by the first Aryan settlers. He speaks of the venerable stele of Shera, a dignity of the court of Sent, the fifth king of the second dynasty, whose date is placed at about B.C. 4000. This monument is preserved at Oxford, but Dr. Budge ought to have mentioned here that a portion of it is in the Gizeh Museum. The French cataloguer of that collection omits all mention of the Oxford stele. So they are even; but each portion gives different items of information. On this monument Shera prays the gods "to grant sepulchral meals," from which Dr. Budge infers "that the art of elaborate sepulture had reached a high pitch of perfection in those early times." He notes incidentally that a redaction was made in the reign of this king Sent of a medical papyrus, from which it is clear that the Egyptians were already possessed of anatomical knowledge sufficient to enable them to preserve the human body as a mummy or otherwise. Manetho, the Ptolemaic chronicler, expressly states that Teta, the second king of Egypt, wrote a book on anatomy, and also studied the properties of drugs. His mother, Shesh, invented a hair-wash. Although, then, some form of mummifying must have been in use at a very early period, it does not follow that it was always practised. Bodies were sometimes preserved in honey, as, for example, that of Alexander the Great; and Dr. Budge quotes a gruesome story from Abel el Latif, about the body of a child found in a jar of honey. The body of Mycerinus, now in the British Museum, seems to have been wrapped in cere-cloth—if the Egyptians had honey, they also had wax. Skeletons of this ancient period usually fall to pieces when exposed to the air. The oldest mummy, strictly so called, which has been identified, is that of Seker-em-sa-f, B.C. 3200, a king of the sixth dynasty, which is now at Gizeh. A few fragments of the mummy of Unas, of the fifth dynasty, are in the same collection—part of the skull, only, and a hand. As to mummy cloth, Dr. Budge corrects a prevalent error. Almost all the older writers asserted that mummies were wrapped in cotton. Jomard thought linen was also used; but a learned Fellow of the Royal Society, having obtained, in 1834, four hundred specimens of bandages, ascertained that they were all of linen. A piece of fine texture was found to have five hundred and forty threads to the inch in the warp, and one hundred and ten in the woof. Nobody who has seen the wrappings, of a delicate salmon colour, which were in the coffin of Thothmes III., can forget that they were as fine as the finest lady's handker-

chief of the present day. Dr. Budge's views on the subject of pyramids will not tally with those of numerous very worthy persons now, we may hope, of a more reasonable mind. In Cairo, a very short time ago, the only book on pyramids to be had by tourists was that of the late Scottish Astronomer Royal, which was written to prove that the Great Pyramid was erected to embody the truths of revealed religion. Dr. Petrie's book was nowhere to be seen. Now all is changed. Messrs. Cook and Son employed Dr. Budge to write a little book on the Nile voyage, a copy of which is in the hands of every tourist, and the pyramid inch and the great passage theory have become curiosities of history. Dr. Budge says briefly, "the royal tombs of the early dynasties were built in the form of pyramids, and they are, to all intents and purposes, merely mastabas."

#### ESKIMO LIFE.

*Eskimo Life.* By Fridtjof Nansen. Translated by W. Archer. 350 pp. (London: Longmans, Green and Co., 1893.)

WHEN Dr. Nansen reached the west coast of Greenland, after his memorable journey across the continent, he found that the last ship of the year had left for Europe, although he had altered his plans and steered for Godthaab instead of the more northerly Christianshaab, partly in order to avoid being detained in the country during the winter. He was, however, compelled to spend the winter among the Eskimos, and his observations and reflections on the character and everyday life of the race are embodied in the book before us.

Dr. Nansen admits the impossibility of attaining a complete and thorough knowledge of so peculiar a people in so short a time as one winter, but his own experiences and impressions have been supplemented by reference to the writings of all the most competent authorities—the Egedes, Crantz, Rink, Holm, and others.

The early history of the Greenland Eskimo is obscure, and anything like certainty dates back no further than 1721, when Hans Egede, the Norwegian missionary, took his wife and children, and settled on the west coast with a view of improving and civilising the native race. From that time to the present, however, the history of the people is well known, and a study of this period affords one of the best examples of the development and changes which so-called lower races undergo, when subjected to the influence of western European civilisation.

The first part of Dr. Nansen's book is concerned with the daily life of the modern civilised Greenlander, and the chapters on the kaiak, or skin-boat, and the weapons used in hunting the seal and other characteristic game of the Arctic seas are excellent.

It is interesting to note that this section of the Eskimo race use the throwing-stick, which enables them to throw the harpoon and bird-dart with greater force and accuracy than with the unaided arm alone. This instrument is only met with among two or three races of men, so widely separated from each other as to preclude the idea of a common origin of the invention.

The character and social life of the people is portrayed in three or four of the succeeding chapters. [Little

acquaintance with the writings of Nansen is necessary before it is seen that he possesses a flexibility of mind and deep sympathies which enable him to enter into peculiar touch with a race of this character.

Chapter xiii. deals with the religious ideas and myths of the Eskimo. This part of the volume is necessarily second-hand; but so far as the facts are concerned, nothing remains to be desired. It seems to us, however, that there is too great a tendency to look upon these legends and tales as matters derived from foreign influence, notably that of the early Scandinavian explorers, from the time of Erik the Red (986 A.D.) to about 1400 A.D. There is some similarity between the legends of the Scandinavian and the Eskimo, but Dr. Nansen, in dealing with the origin of those possessed by the latter, does not apparently allow enough for the possibility of spontaneous growth of the same idea in two widely separated races. The Vikings have had little influence upon the daily life of the Greenlander, and it is very improbable that the latter would borrow recondite philosophy, or lore of any kind, from the former.

If true similarity does exist in such cases, it is more likely to be due to the inherent similarity of the powers of the human mind to invent explanations for incorrectly understood phenomena.

In the concluding chapters are given the results which have been achieved since the introduction of Christianity 150 years ago. The first European settlement found a people who were nearly blameless, full of practical socialistic sentiment, generous and open-hearted, truthful, private property almost unknown, poverty non-existent, able to live peacefully and contentedly in surroundings in which Europeans, with all modern resources, are taxed to the utmost to exist through winter, healthy and full of patience. To-day disease, poverty, and distress are abundant. These changes, which must be looked upon as bad for the Eskimo, whatever the intentions of the settlers may be, are brought about by causes which are to a large extent obvious, and Dr. Nansen's advice to all those who have the welfare of the native race at heart, is to leave the country, and allow the people to make the shortest cut back again to their pristine state.

The translator's work has been admirably done.

J. P.

#### OUR BOOK SHELF.

*La Voie Lactée dans l'Hémisphère Boréal.* By C. Easton. With a preface by Prof. H. G. van de Sande Bakhuizen. (Paris: Gauthier Villars et Fils, 1893.)

THE Milky Way, "that broad and ample road, whose dust is gold and pavement stars," almost defies accurate delineation. Its irregular outlines and indefinite structure tease the eye of the artist, and renders his task most difficult. In all probability the largest amount of information with regard to this celestial zone "powdered with stars" will be obtained from photographs taken by means of portrait lenses having a wide field, similar to that employed by Prof. Barnard for his beautiful pictures. There is much to be gained, however, by the multiplication of maps such as those of M. Easton, in which the aspect of the Galaxy to an observer having normal eyesight is shown. The maps are finely drawn and reproduced, and well show the delicate gradations of galactic light. A detailed descrip-

tion and historical notice give the atlas additional interest, while a catalogue of the patches and streams of luminosity, and the dark regions, will be of use to those who theorise on the structure of the stellar universe. A comparison of the maps with those drawn by Boeddicker reveals many differences, but it cannot be said on this account that either of the observers is wrong. No two observers have eyes exactly alike, or are favoured with precisely the same observing conditions, hence drawings of the Milky Way, like those of nebulae, simply represent the appearances presented to certain visions, and are only approximations to the truth. M. Easton's maps are published in a very handy form, and may be added with advantage to every astronomical library and observatory.

*An Elementary Treatise on Analytical Geometry.* By W. J. Johnston, M.A. (Oxford: Clarendon Press, 1893.)

IN these 400 pages Mr. Johnston has ably succeeded in producing a very excellent treatise which leads the beginner by easy stages from the first principles of the subject to the more complicated theorems in trilinear coordinates. In the first ten chapters the student is made thoroughly familiar with the properties of the Ellipse, the Parabola, and the Hyperbola, after having been well exercised in the more preliminary parts of the subject as regards co-ordinates, the straight line, loci, &c. In these chapters it seems that the beginner can hardly fail to obtain a thorough grip of their contents, unless indeed he goes out of his way to do so, for more details could hardly be added. The numerous worked-out exercises should also be valuable, as they show him how to apply the knowledge gained from the various theorems learnt as book work. The next three chapters deal with the general equation of the second degree, conical conics, and abridged notation, the last-mentioned including a large number of miscellaneous exercises; in these may be mentioned some additional methods of tracing a conic whose Cartesian coordinates are given, and an investigation of the equation of a diameter due to Prof. Purser. The remaining chapters treat of trilinear coordinates, envelopes, and methods of transformation. Here may be noticed Prof. Genese's proof of Feuerbach's theorem, Pascal's theorem, and many others of interest.

As an elementary book one may say that, from a beginner's point of view, we have here a sound and clearly written volume that will be sure to find favour with students and teachers. Perhaps it may be better for those commencing the subject to pursue the limited course recommended to them by the author, but a little more of an insight will show them what to read. Advanced students will also find much of interest in the latter chapters, and to them we can specially recommend the working out of some of the numerous and well-chosen examples.

*Zur Kenntniss der Postembryonalen Schädelmetamorphosen bei Wiederkauern.* By H. G. Stehlin. (Basel: Benno Schwabe, 1893.)

THIS publication deals with a branch of osteology which up to the present time possesses no special literature of its own, and is an attempt to trace the changes which take place in the skulls of ruminants from the time of birth up to adult age. The skulls of Bos, Capra, and Portax are studied in a most exhaustive manner at different ages, and comparisons drawn; elaborate measurements being given in every case. Special attention is paid to the effects produced by the development, final size, and position of the sinuses, teeth, and horns; also, the differences between the skull at birth and at adult age are considered in relation to rate of growth of the animal, and its length of life. In the last chapter the three types, Bos, Capra, and Portax, are contrasted with each other, and a number of other forms described, their relations to these types being indicated.

The plates illustrate most fully the points made out, in many cases a longitudinal section of the skull of the animal at birth being printed in red over a drawing of one of adult age, both drawings having been reduced to scales which render comparisons of form possible.

### LETTERS TO THE EDITOR.

[The Editor does not hold himself responsible for opinions expressed by his correspondents. Neither can he undertake to return, or to correspond with the writers of, rejected manuscripts intended for this or any other part of NATURE. No notice is taken of anonymous communications.]

#### Suggested Nomenclature of Radiant Energy.

HAVING recently had occasion to develop the first principles of the theory of inter-stellar radiation, I soon felt the want of some short and convenient word to express that form of ethereal wave-effect known as "radiant energy," "radiant heat," "light," "rays of the spectrum," &c. Radiant energy is doubtless the most accurate of these expressions, but it is subject to the objection of being a description rather than a name. The nomenclature of the subject has come down from a time when it was supposed that there were three distinct kinds of rays in the spectrum, severally known as light, heat, and actinic rays. It is, I believe, not much more than half a century since several eminent physicists and teachers supposed that the heat rays of the spectrum could be separated from the light rays having equal refrangibility by the absorption of a transparent medium: and that even the light rays of different colours might be separated in the same way. I cannot but think that the general understanding and application of the now received theory of the subject, which recognises in this form of energy no differences of kind except wave-length, has been materially retarded by the want of a corresponding nomenclature.

The use of the word "light" for ethereal waves having a length between certain definite limits, while there is no corresponding word for other waves, is evidently unscientific. Notwithstanding the great practical usefulness of light, its distinctive property of affecting the optic nerve in a certain way can claim only a secondary place in physics. Indeed, it has long seemed to me that the banishment of the word "light" from physics was a desideratum.

After various attempts I hit upon the very simple term *radiance*, as one which seemed well-fitted to supply the want in question. The vague and poetic idea hitherto associated with it is an advantage, because it enables us to adapt it to the case in hand with greater readiness than we could adapt a word which already had some well-defined meaning. Shakespeare speaks of the "sacred radiance of the sun"; while Milton describes the Deity as "Girt with omnipotence, with radiance crowned." We can thus adopt the word to express scientifically what we now consider to be electro-magnetic waves, or ethereal waves, without that clashing of ideas which might arise from making a new application of an old word, and without the awkwardness of coining a new one.

The necessary derivatives and compounds of the word can be formed with as much ease as we should expect in the case. The verb "radiate" will mean to emit radiance. I do not think any confusion will arise if we use the word "illuminate" to signify the throwing of radiance upon a material body, although in ordinary language it implies light. Possibly the extent to which it is used in a tropical sense may facilitate the widening of its literal meaning. *Radiometry* would mean the measure of radiance, and an instrument for effecting such a measure would naturally be called a radiometer. It is perhaps unfortunate that the instrument in question should then assume the name of Crookes' beautiful little instrument, but an apology may be found in the fact that the latter has not been used for the purpose of exact measurement. The use of the word "radiometry" offers no such difficulty.

I am still a little perplexed for a word which shall express the quality hitherto called transparency, diathermancy, &c. Apparently we have no alternative but to continue the use of one of these objectionable words, or invent some such new word as *transradiant*, or *transradious*.

The proper measure of radiance, and the only measure which can be regarded as of real importance in physics, should be the amount of energy radiated in unit time. This measure is equivalent to

that of heat generated in unit time in the absorption of radiance by a perfectly black body. If we reflect that this, and this alone, measures the actual loss of internal energy by a radiating body of any kind, whether ball of iron in a laboratory, planet, star, or nebula, the importance of some simple nomenclature of measurement will be evident. I should be much pleased if physicists would find by actual trial whether the use of the proposed words comes as natural to them as it has to me.

SIMON NEWCOMB.

#### The Postal Transmission of Natural History Specimens.

IT has always been recognised that scientific research is greatly furthered by the exchange of the various objects with which that research is concerned. For the transmission of objects of Natural History from one country to another, the mails have offered a cheap, speedy, and trustworthy means. Heretofore, through the laxity with which the regulations on the subject have been enforced, it has been possible to enter such objects in the mails of the Universal Postal Union as samples of merchandise and under the rates of postage therefor. From official information lately received from the Post Office Department of the United States it appears that such a rating is entirely unauthorised by existing provisions, and that objects of Natural History may be mailed to countries of the Union only, at the rates required for letters. The United States Post Office Department also stated that it had recently submitted a proposition to the countries composing the Postal Union to modify the regulations so that such specimens might be received into the mails at the same rates as samples of merchandise, but that a sufficient number of those countries had voted against the proposition to defeat it.

This Academy has therefore resolved to address the various scientific bodies, with which it is in communication, in those countries whose Governments have voted against the proposition, and to request those scientific bodies to memorialise their respective Governments in favour of the same.

The Governments of Austria, Bolivia, British India, Canada, Germany, Great Britain, Guatemala, Hungary, Japan, Norway, Portugal, Russia, Spain, Sweden, Tunis, Uruguay, and Venezuela having voted in the negative, this Academy respectfully requests the favourable consideration of this question by scientific societies, and begs that they take such steps as they deem advisable to inform the Postal authorities of their respective Governments of the manifest advantages to scientific research which would result from the adoption of the proposed modification, and to request those authorities to take such steps as may result in the adoption of the same.

The letter rate for postage (Universal Postal Union) is ten times that required for samples of merchandise; such a rate for specimens of Natural History is virtually prohibitive.

This Academy would respectfully urge upon scientific societies prompt action in this matter, if it meets with that approval which we so strongly desire.

ISAAC J. WISTAR, *President*.

EDW. J. NOLAN, *Recording Secretary*.

Philadelphia, November 14.

#### Flame.

HOWEVER thoroughly a B.A. audience may have allowed Prof. Smithells, by means of his beautiful experimental demonstrations, to hypnotise them into unquestioning belief in his conclusions, those who read the account of his lecture in the pages of NATURE will not all be equally disinclined to question the validity of some of his arguments.

To tell us that Dalton, as a matter of fact, long ago settled the question as to which has the preference—the carbon or the hydrogen—when a hydrocarbon is burnt with insufficient oxygen, is, after all, but to appeal to the gallery; and this and other conclusions arrived at by Prof. Smithells appear to me to involve the use of that process of circular reasoning which consists in taking for granted that which is to be proved—a method which at the present day finds such favour in certain quarters.

As I discussed this matter somewhat in detail in a correspondence with Sir G. G. Stokes last year (*Chem. Soc. Proceedings*, 1892, No. 106, p. 22), it is unnecessary to go fully into it now. Any number of analyses showing the presence of hydrogen in the products of combustion may be quoted without materially ad-



vancing the settlement of the question. In my opinion, there is no improbability inherent in the assumption that hydrogen is but a secondary product, resulting from the interaction of the primary products—water and either carbon or carbon monoxide. The rate at which the interactions take place in flames are such, and the conditions are such, that the products collected are probably far from being the *products of the initial interchanges*, as indeed Prof. Smithells himself admits to be the case. It is scarcely likely that the settlement of such a question can ever be achieved by direct observation. Our ultimate views on the nature of the changes occurring in flames must depend on the gradual growth of a true understanding of the nature of chemical interchanges in general, and especially in gases.

I am inclined to take the same view with reference to Davy's explanation of the luminosity of flame. If eventually, as is not improbable, we come to regard the expressions *chemical interchange* and *electrolysis* as interchangeable equivalent terms, much more will have to be said on behalf of Frankland's hypothesis. I had the good fortune to attend the philosophic lectures at the Royal Institution in which Frankland, in 1868, first fully stated his views on this subject, illustrating his arguments by a series of most striking experiments. No course of lectures ever impressed me more, and to the present day I have the most vivid recollection of all that passed. An account of the lectures was published in the *Journal of Gas Lighting* at the time of their delivery. It has always appeared to me that Frankland's arguments are of a most weighty character, and that owing to their appearance in an obscure publication they have never yet been sufficiently widely considered.

The study of flame affords problems of the highest interest and importance, but of proportionate complexity and difficulty. There is little doubt, however, that we are inclined to take too narrow a view of this as of many other inquiries—that we have an unreasoning belief in what we are pleased to call facts, forgetting that these same "facts" are but phenomena interpreted by our own limited intelligence. On studying the views that have been taken at various times, it is only too obvious that fashion is not confined only to garments, nor is dogma the exclusive privilege of theologians; and it is time that we realised that very many of our conclusions regarding chemical interchanges are but the crudest dogmas, based on a thoroughly superficial consideration of the phenomena. If we are to deserve the title of scientific workers—workers exact in deed, thought, and word—we must be far more careful in the choice of our language, and guarded in our conclusions.

HENRY E. ARMSTRONG.

#### "Geology in Nubibus."

SIR HENRY HOWORTH wishes to continue the discussion of glaciation in the pages of NATURE, but I find in his last letter very good reason why this cannot be done. No discussion can lead to definite results unless the parties to it accept as data what they themselves have recently and deliberately admitted. But when I stated that the Rhone glacier *did* reach the Jura, and deposit on it erratic blocks between Geneva and Soleure, I did so because it was one of the data already admitted by Sir H. Howorth. In his "Glacial Nightmare," pp. 169-173, he gives a full summary of Charpentier's first memoir on the erratic blocks of Switzerland, describing the glacial phenomena exhibited along the whole course of the old glaciers from the Alps to the Jura, and showing that they "even climbed that range and went over to the other side of it." Sir H. Howorth then says: "I have quoted at considerable length from this excellent memoir, because I look upon it as having definitely applied *inductive methods to this question* with results which are for the most part *sound and unanswerable*." (Italics mine.) In the same chapter (pp. 195-202) Charpentier's second memoir is summarised still more fully, and his general conclusion is thus quoted: "It goes without saying that not only all the valleys of the Valais were filled with ice up to a certain height, but that all lower Switzerland, in which we find the erratic debris of the Rhone valley, must have been covered by the same glacier. Consequently all the country between the Alps and the Jura, and between the environs of Geneva and those of Soleure has been the bed of a glacier." Agassiz and other writers are quoted as giving further evidence of the same kind. Nowhere in the whole of this chapter can I find a single objection to the conclusions of the chief writers quoted, and the concluding paragraph, at p. 208, frankly accepts them. It declares that

they are supported by "every form of converging evidence," and that—"So far there is no question at issue." Yet, when I take these same conclusions of Charpentier as admitted data, Sir H. Howorth says: "This form of dogmatic argument is assuredly incomprehensible!" Charpentier's proof that the Rhone glacier reached Soleure, was, a year ago, "sound and unanswerable," and was an example of "definitely applied inductive methods"; but when I accept these same results as something to reason upon, I am told that I am making use of "hypotheses outside the laws of nature." I have now justified my opening statement that a discussion carried on in this manner can serve no useful purpose. ALFRED R. WALLACE.

#### Correlation of Magnetic and Solar Phenomena.

IN Mr. Ellis' letter on this subject (NATURE vol. xlix. pp. 30), he says:—

"To sum up, the points of the matter may be thus stated:—  
(1) The solar outburst in 1859 was seen independently by two observers: the fact of its occurrence seems therefore undoubted.  
(2) The corresponding magnetic movement was small.  
(3) Many greater magnetic movements have since occurred.  
(4) No corresponding solar manifestation has been again seen, although the sun has since been so closely watched."

Now, in the year 1882, I was acting as assistant to the Solar Physics Committee, and on November 17 there was a dense fog, so that it was not possible to take the usual solar observations. Mr. Lockyer was present in the morning, and then left for some reason; after he had gone, a telegram came for him: he returned late in the afternoon, and sent for me, told me the telegram was from Mr. Prece, of the Post Office, asking him whether there was a solar disturbance, as there was such a violent electrical storm raging, that communication had been cut off from the continent, and that it was difficult to maintain communication in England. I at once went to the instruments, and as the fog cleared just before sundown, was able to ascertain that there was a large group of spots near the sun's meridian, attended with most violent uprushes of luminous matter; indeed, if my memory serves me aright, it was the most violent disturbance I saw during the whole of my observations, extending from 1879 to 1886. On reporting to Mr. Lockyer, he said we should probably see an aurora in the evening; and as soon as it was dark, there was a most brilliant auroral display that exhibited some quite new features (NATURE, vol. xxvii. pp. 82 *et seq.*) Doubtless, had this spot been kept under observation, luminous outbursts similar to those observed by Carrington and Hodgson would have been seen; indeed, Mr. Whipple's letter (*loc. cit.* p. 83) seems to contain such an observation.

I believe, but am not quite sure, as the records of the observations are in Mr. Lockyer's possession, that it was in this spot that he and I first noticed that some of the so-called iron lines in the spot spectrum were in motion, while others were not.

H. A. LAWRANCE.

Gunnernbury, November 19.

#### New Variable Star in Andromeda.

A STAR that should be added to the list of variables is + 26<sup>o</sup>43, of the Bonn *Durchmusterung*, in which work its magnitude is given as 8.7. In reply to a letter of mine, in which I expressed a doubt as to this star's existence, Dr. Küstner, of Bonn, informed me that although he had on the 7th of this month looked in vain for the star with the 6-inch refractor of Bonn Observatory, yet it seemed pretty certain that a star had twice been observed in the specified place in September, 1855. I have subsequently been informed by Sir Robert Ball, that the star was twice observed at Cambridge (England) in 1878. The dates and places of the various observations, as well as the estimated magnitudes, are:—

Sept. 7, 1855, Bonn, 9.0 (but perhaps 9.2).

Sept. 10, 1855, Bonn, 8.3.

Nov. 29, 1878, Cambridge, 8.7.

Dec. 11, 1878, Cambridge, 8.7.

The star's mean place for 1894.0 is

|       |      |      |        |
|-------|------|------|--------|
| R.A.  | oh.  | 16m. | 51.3s. |
| Decl. | +26° | 24'  | 27"    |

THOMAS D. ANDERSON.

21 East Claremont Street, Edinburgh, November 22.

### Protective Habit in a Spider.

MR. R. I. POCOCK'S interesting paper in your issue of November 16, leads me to place on record an observation I made last summer in the island of Arran. Sitting by a little clear pool in the granite of Glen Sannox, I noticed a spider whose web was spun in the heather which partly overhung the stream. On disturbing her, she dropped on to the granite a few inches above the water, and running rapidly down, entered the pool and hid under a tuft of weed. After remaining thus hidden for 2½ minutes, she returned to the surface and, reeling herself up by her thread, regained the web. Disturbed again, she repeated the action, remaining under water 1¾ minutes. A puff of tobacco smoke sent her down a third time, when she remained hidden for 2¼ minutes. In each case she hid in the same place, and in each case regained the nest by her thread.

I have placed the spider in Mr. Pocock's hands. He informs me that the species is *Epeira cornuta*, or possibly *patagiata*.  
University College, Bristol. C. LLOYD MORGAN.

### THE LOSS OF H.M.S. "VICTORIA."

FOUR weeks ago the Admiralty issued a minute upon the proceedings of the Court-Martial appointed to inquire into the loss of H.M.S. *Victoria*; and also a further minute upon the construction and stability of the ship, and a report by Mr. W. H. White, the Director of Naval Construction, upon such parts of the evidence given at the Court-Martial as throw light upon the causes of the foundering or capsizing of the ship.

In the first-named minute the Admiralty concur with the finding of the Court-Martial, as regards the causes of the collision with the *Camperdown*, and the distribution of blame among the officers concerned:—matters with which we shall not now attempt to deal. The other two relate to the construction, buoyancy, and stability of the ship, and discuss facts and questions relating to these points, which demand the careful attention of all who are interested in the efficiency of the Navy. These minutes deal with matters for which the Admiralty is felt to be responsible, and to be, to some extent, upon its trial. The question of Admiralty responsibility for the efficiency of the *Victoria*, and her power to withstand such a blow as she received, has been hitherto treated and discussed as though it were merely one of who designed the ship. In this case, the circumstances are somewhat peculiar, for her original designer, Sir N. Barnaby, retired from the Admiralty service in 1885, immediately after the vessel was ordered to be built, and before she was even in frame. Many alterations were afterwards made during the progress of construction, and everything considered necessary for safety or efficiency was done by others, during the five years that passed before she was finally completed. Whether the early design were good or bad, the responsibility for the ship as she was completed and commissioned, and passed into the Navy as a first-class battle-ship in 1890, surely rests with those whose duty it was to watch her construction, and to ultimately certify to her fitness for the class in H.M. service in which she was placed. The question of who was responsible for the design of the *Victoria* as it first stood, has now little more than an historical interest. That of the responsibility for completing and fitting her out for sea, and passing her into the Navy as a first-class battle-ship, is the only one of real practical importance at the present time, if it be thought necessary to discuss the matter.

This being the state of the case with regard to the question of responsibility, we can only regard the minutes relating to the buoyancy and stability of the *Victoria* as the best defence of the ship that is possible. It may be a perfectly good defence, but it is obviously *ex parte*, and can only rightly be judged as such. Had a Committee of Inquiry been appointed, these minutes represent the case that would have been laid before it by the Admiralty,

and would have been examined from various points of view, and adjudicated upon. The Admiralty has preferred to treat the public as competent judges, and to lay their case before them in a form which bears the outward semblance of a judicial decision. The minutes are, however, upon some points more in the nature of a pleading than a judgment; while they are, at the same time, much too technical and complex for any but the most competent experts to judge. It is to be regretted, in the interests of the Navy and the country, that the facts and opinions thus put forward are not referred to a competent and impartial body for examination and report.

Mr. White's report summarises the evidence respecting the behaviour and movements of the *Victoria* after she was struck by the *Camperdown*, and gives the results of calculations respecting the effect of filling compartments in the neighbourhood of the blow, which appear to agree, in the main, with the reports of observers. The calculations employed are, as he states, quite simple in character; and no one who knows the Construction Department of the Admiralty, or the men in it who perform this class of work, could doubt their substantial accuracy. An important point in connection with them is, however, the assumptions upon which they are based. Some of these may be more or less open to question; while nothing is said as to the information the officers had respecting the rapidity with which the *Victoria* might be sunk if rammed. It appears evident that no one on board imagined the ship could sink, after such a blow as she received, without giving time to close the water-tight doors; and it appears, also, that some of the water-tight doors could only be closed by going into compartments into which the sea first obtained access.

These questions, and the more general one of the light that is thrown upon the efficiency of other ships of the same class by this sad disaster, respecting which the Admiralty minutes say nothing directly, though they imply that nothing unsatisfactory is indicated, appear deserving of close and careful consideration. The following remarks will be devoted to an attempt to describe how the matter, and the light thrown upon it by the recent Admiralty minutes, strikes one who is intimately acquainted with the ships of the Navy, and has studied the technical questions which have been raised, from time to time, respecting them.

The subjects treated of in the two minutes now under consideration may be classified as follows:—

- (1) The nature of the blow received by the *Victoria*;
- (2) her after-movements and behaviour up to the moment when she capsized and sank;
- (3) the extent to which water found access into the ship;
- (4) the effect of the water thus admitted upon the line of flotation and the stability;
- and (5) the lessons that are taught by various circumstances attending the loss that have come to light.

1. *The nature of the blow received by the "Victoria."*—Before the commencement of the manœuvre that immediately preceded the disaster, the ships of the squadron were steaming in two parallel lines, about 1200 yards apart, at a speed of about 8½ knots. The course was ordered to be reversed by turning the ships inwards between the lines. The *Victoria's* helm was put hard to starboard, at an angle of 35°, and the *Camperdown's* helm was put over to port, at an angle of 28°. With these helm angles the *Victoria* would turn in a circle of 600 yards diameter, and the *Camperdown* in a circle of 800 yards diameter. A collision was therefore inevitable with both ships continuing at the same speed. When both had turned through eight points, or a right-angle, they were end-on to each other, at a distance apart which was estimated at 400 to 500 yards. It was then seen that a collision was imminent, and the port engines of the *Victoria* and starboard engines of the *Camperdown*

were ordered to be reversed at almost the same instant, about one minute before the collision, in order to make the ships turn more quickly. Orders to go astern with both sets of engines followed immediately in each ship.

The *Camperdown's* speed on striking the *Victoria* was estimated at 5 to 6 knots, and appears to have been rather less than 6 knots. The *Victoria's* speed ahead at the same time was about 5 knots. The blow was struck at an angle of about  $10^\circ$  abaft the beam of the *Victoria*, and at a distance of about 65 feet abaft the stemhead. The vertical portion of the *Camperdown's* stem penetrated  $5\frac{1}{2}$  to 6 feet into the side of the *Victoria*, and the point of the ram, which projects 7 feet beyond the vertical portion of the stem, penetrated 9 feet within the bottom plating at a depth of about 12 feet below water. The breach thus made in the side of the *Victoria* appears to have been 220 or 230 square feet in area; of which over 100 square feet was below the water-line. It extended vertically downwards 28 feet from the upper deck, and 18 feet from the water-line, and was 12 feet wide at the upper deck, and 11 feet wide at the water-line. The ships were locked together for over one minute, during which time their sterns swung together through an angle of  $20^\circ$ . As the blow was struck just before a water-tight transverse bulkhead, it appears probable that the water-tightness of the division thus formed was destroyed, either by the first shock or by injuries subsequently received, as the sterns of the two ships swung towards each other, while they were locked together.

2. *The movements and behaviour of the "Victoria" after being struck, up to the moment when she capsized and sank.*—Mr. White gives a clear description of this, which agrees with the evidence of officers on board other ships, who observed carefully what was happening to the *Victoria*. The force of the blow given to the bow of the *Victoria* caused it to move over at first 60 or 70 feet to port. The two ships remained locked together about one minute,<sup>1</sup> and as the *Camperdown* moved astern and cleared the *Victoria* settled down rapidly by the bow, and heeled towards the starboard side. The bow sank 10 feet during the first four minutes after the collision. Two minutes later the water had risen so high on the forecastle, which was originally 10 feet above water, that the men working there had to be called away. In nine to ten minutes after the collision the sea was entering the open turret ports, 100 feet from the bow and 14 feet above the original waterline. The upper deck right forward was then 13 feet below water; the armour-door in the bulkhead at the fore end of the upper deck battery, which was open, was partly under water; and the two foremost gun ports on starboard side, also open, were awash. The forward part of the upper deck was thus submerged for nearly half the length of the ship, and the stern was lifted about 8 feet. Simultaneously with this rapid depression of the bow and elevation of the stern, the ship was continuously increasing her heel to starboard up to about  $20^\circ$ , and when this position had been reached, nine or ten minutes only after the collision, she gave a lurch to starboard, turned bottom up, and sank by the head. When the lurch began the vessel was steaming slowly ahead with both screws, and the helm was hard over to starboard.

The speed ahead, due to an attempt to steam slowly towards the land, and the helm being over to starboard, tended somewhat, as Mr. White points out, to increase both the depression of the bow and the heel to starboard. Even a very low speed would have a serious effect, after the fore end of the upper deck became submerged, in forcing it still deeper below water, and in driving water into the interior of the ship through the openings on and above the upper deck. The helm was kept over because the hydraulic steering gear ceased to act very soon after the collision, when it was in that position. The failure

of this steering gear is attributed to the inflow of water consequent upon the collision. Alternative hand-steering gear, which was available in a convenient position abaft the portion of the ship that was flooded, could not be brought into operation, owing to the short time the ship remained afloat.

3. *The extent to which water found access into the ship.*—A very large portion of Mr. White's report is devoted to a detailed discussion of the state of each compartment in the forward part of the ship, and the probability of water finding access into it; and, although the results thus arrived at are, doubtless, right upon the whole, it is not certain that they are correct in every particular. He appears to go too far in asserting that the evidence given before the Court Martial, respecting the compartments which were flooded, is exhaustive; while this is inconsistent with the list, given in Table II. of his report, of "Compartments shown by the evidence to have been probably or possibly filled through doors, hatches, &c." Two items in that list, at least, are quite doubtful, as judged by the published evidence, viz. the water-tight compartment in hold on port side, between frame stations 12 and 22, and the port ejector tank; which would hold 108 and 35 tons of water respectively. Neither does it appear right to claim, with absolute certainty, upon the evidence as it stands, that the submerged torpedo room was flooded, although it is probable that it was. This is a point upon which further examination of the witnesses might have converted reasonable doubt into something approaching to certainty.

There are, however, no scientific or practical questions relating to the case that would be seriously affected by proving absolutely that one compartment, or another, about which there might be any doubt, was or was not flooded. Events proved that sufficient water found its way into the fore-end of the ship to submerge the bow to the extent that was observed, and to ultimately cause her to capsize and sink. She would probably have kept afloat if all water-tight doors and scuttles had been closed, and if the entry of water had thus been limited to the compartments that were directly opened up by the breach made by the collision. The ultimate submersion and capsizing was apparently caused by the entry of water into compartments that were not damaged by the collision, through open doors and scuttles; and the circumstances and causes of the catastrophe can therefore be thoroughly discussed whether Mr. White be right or wrong in his conclusions as to the precise number and positions of the compartments that were flooded.

It thus appears, adopting Mr. White's figures in the aggregate—which must be fairly correct in order to account for the facts—that the weight of water which entered the ship was approximately as follows:—

(1) Into compartments that would have been flooded, in consequence of the collision, if all water-tight doors and hatches had been closed: 75 tons above the protective deck, 330 tons upon the platforms under the protective deck, and  $271\frac{1}{2}$  tons in the hold, being 676 $\frac{1}{2}$  tons in all. (2) Into compartments that were subsequently flooded through doors, hatches, &c., that were left open: 33 $\frac{1}{2}$  tons above the protective deck, 353 tons upon the platforms under the protective deck, and 47 tons in No. 7 coal bunker and shoot. (3) Into compartments which may have been flooded, but as to which the evidence is doubtful: 322 tons above protective deck,<sup>1</sup> 200 tons upon the platforms under the protective deck, and 143 tons in the hold. In addition to the above about 100 tons of water must have entered the boatswain's and carpenter's stores above the protec-

<sup>1</sup> The compartments into which this 322 tons of water may have entered are the air-compressing room, sail room, chest room, torpedo room, and turret support, and it is pointed out in a foot-note to Mr. White's minute that these compartments are within the limits of the armour belt. We do not understand how this affects any of the points in the case.

<sup>1</sup> Some observers thought two minutes.

tive deck, through the riding bits on the upper deck, after the tops of these became submerged.

We thus obtain a total of 1,110 tons of water which entered the ship through the breach made by the collision and passed into other compartments, besides those directly laid open to the sea, through open doors, hatches, &c., a further amount of 100 tons that entered after the tops of the riding bits became submerged; and 665 tons about which there may be doubt as to the precise positions of the compartments it entered.

4. *The effect of the water thus admitted upon the line of flotation and the stability.*—The 1,110 tons of water above mentioned would, according to the Admiralty calculations, considering its position at the fore-end of the vessel, depress the bow to the extent of 21 feet, and raise the stern 8 feet. This change of waterline is considered to have necessarily flooded the other compartments, respecting which the direct evidence is doubtful; and certainly to have filled the boatswain's and carpenter's stores through the riding bits. The turret ports, and also the door on starboard side, and the ports, in the upper deck battery, would thus be brought under water, and the position of the ship be rendered hopeless.

Mr. White states, with regard to the stability, that as the *Victoria* floated before the collision, she had a meta-centric height of 5 feet—i.e. the centre of gravity was 5 feet below the point at which its righting effect would be *nil*—and that after the collision, when the bow had sunk deeply and she had heeled considerably—by how much is not said—the metacentric height was reduced to about eight-tenths of a foot. When water had entered the battery and turret through the open door and ports, as observed when the fatal lurch began, the meta-centric height had become altered by the changed condition to *minus* 1·8 feet; and the final capsizing was inevitable.

A consideration of the fifth subject treated in these minutes, which is the lessons taught by circumstances connected with the loss—the most important of all for the future—will require an article to itself, and must therefore be postponed till another week. The points mentioned in this connection are: the effect of longitudinal bulkheads upon safety in such circumstances as are those under discussion; whether the closing of the battery doors and ports would alone have been sufficient to save the ship; whether the closing of all water-tight doors and scuttles would have done so; whether the water-tight doors fitted to the ship were the best for the purpose; the value of an armour-belt at the ends for the purpose of resisting damage; and whether the blame rests wholly upon the officers of the *Victoria* for not knowing how rapidly the ship would be likely to sink when damaged as she was, and for not taking steps sooner to close the water-tight doors and scuttles and prevent the final catastrophe.

FRANCIS ELGAR.

### JUPITER AND HIS RED SPOT.

JUPITER is now, with his northern declination of 18° and an equatorial diameter of 48", a very fine object visible above our horizon during more than 15 hours at a time. Thus, on December 1 he rises at 3h. 7m. and sets at 18h. 23m., shining nearly throughout the long nights now prevailing from a position about 6° south-west of the Pleiades.

As an object for telescopic study Jupiter is undoubtedly the most interesting planet of our system. The activity apparent everywhere on his surface, the number and variety of the forms displayed, and the comparative ease with which they may be observed, attest that this object is practically without a rival, and that the investigation of his phenomena is certain to be productive.

NO. 1257, VOL. 49]

The present time is eminently a suitable one for studying his surface markings, and redetermining their proper motions. As the planet's rotation period is less than 10 hours, the times of transit of the same spots may sometimes be obtained twice on one night, for if a marking crosses, say, 3 hours after the planet's rising, the same object will again reach the central meridian about 2½ hours before the planet sets.

It is well known that the visible surface of Jupiter consists of a number of light and dark zones interspersed with irregular forms which exhibit great differences in their rates of velocity. Certain white spots, bordering the equator, move very swiftly, and complete a rotation in considerably less time than the red spot. Some dark spots, which have appeared at various times on a double belt about 25° N. latitude, have moved more rapidly still, and shown a rotation in seven minutes less time than the red spot. But it is a peculiar feature of the different markings that they do not maintain the same rate of motion during their existence; in fact, a lengthening of period seems to generally affect them. Thus the red spot in 1880 gave a rotation of 9h. 55m. 34s., while in recent years it has been about 9h. 55m. 41s. The equatorial white spots, which thirteen years ago had a period of 9h. 50m. 6s., have been gradually moderating their speed until in the last few years their period seems to have been 9h. 50m. 30s. It is certain that the various markings are carried along in atmospheric currents, and are subject to remarkable differences, of which we do not comprehend the cause, though we may readily trace the effects.

The red spot situated in Jupiter's S. hemisphere, and on the boundary of the tropical and temperate zones of the planet, is still perceptible, and it is highly probable that the spot existed long before it first came conspicuously into notice in July, 1878. During the last fifteen years there has been little change either in its oval shape or in its dimensions, though its colour and visibility have suffered some trying vicissitudes. It has been successively presented as a brick-red spot, as a faint pink ellipse, as a grey shading, and it is now so feeble that only the outline of its following side can be distinguished, the preceding part of the spot having apparently lost its definite outline. In fact, there seems a prospect of losing the object temporarily if further decadence goes on, but in view of past experience and the probability of recurrence in the Jovian markings, we may certainly expect the spot to reappear, and to present a more conspicuous aspect than it does at the present time.

The following are some eye-estimates of the transits of the spot during the present apparition; they were made by Mr. A. Stanley Williams, of Brighton, and by myself at Bristol:—

| Date, 1893. | Red spot at transit. | Marth's zero meridian. | Red spot precedes, | Observer. |
|-------------|----------------------|------------------------|--------------------|-----------|
|             | h. m.                | h. m.                  | m.                 |           |
| Aug. 9 ...  | 14 5                 | 14 13·6                | 8·6                | W. F. D.  |
| 14 ...      | 13 15·5              | 13 22·1                | 6·6                | A. S. W.  |
| 16 ...      | 14 52·2              | 15 0·6                 | 8·4                | "         |
| 16 ...      | 14 55                |                        | 5·6                | W. F. D.  |
| Sept. 4 ... | 15 31                | 15 41·8                | 10·8               | A. S. W.  |
| 14 ...      | 13 52·2              | 13 57·5                | 5·3                | "         |
| Oct. 8 ...  | 13 35·8              | 13 43·6                | 7·8                | "         |
| 18 ...      | 11 50·4              | 11 58·0                | 7·6                | "         |
| 30 ...      | 11 45                | 11 50·0                | 5·0                | "         |
| Nov. 6 ...  | 12 29·2              | 12 34·9                | 5·7                | "         |
| 23 ...      | 11 25                | 11 33·9                | 8·9                | W. F. D.  |

The spot therefore transits a few minutes before the zero meridian based on the daily rate, 87°27' (= 9h. 55m. 40·65s. for one rotation), System II. in Mr Marth's ephemerides (*Monthly Notices*, May, 1893).

Mr. Williams writes me that he has recently been able to make out the whole outline of the red spot except the preceding end, and on one very favourable night,

November 6, he glimpsed the spot in its entirety, and describes it as of a pinkish colour. The following and south following part of the spot had quite a dark and definite outline.

On October 31 the red spot was seen with the 16-inch refractor at the Goodsell Observatory, Northfield, U.S.A. It was not a difficult object, though the colour is stated as being very faint. "The S. side of the spot and a belt of similar tint appeared to merge into one another without the slightest change in intensity of colour."

On November 23 I observed the spot with an 8½-inch reflector belonging to my friend, Mr. J. Harvey Jones, of Bristol; but the night was not very good. The red spot was faintly seen, and must have been central at about 11h. 25m. Other details were also noticed as follows:—

A faint, narrow, dark belt, like an irregular pencil-line, on the equator. A similar belt running from about the  $\beta$ . end of the red spot to W. limb of the planet. The shouldering of the S. equatorial belt N. of the ends of the red spot was distinctly seen, though that part N. of the  $\beta$ . end was very faint. The  $f$ . shoulder shows a much more gentle slope than formerly. Numerous reddish spots were seen on the N. side of the N. equatorial belt. These were large and conspicuous, as were a series of bright spots  $\beta$ . and S. of the red spot. A remarkably brilliant spot on the N. side of N. equatorial belt was central at 10h. exactly.

The general appearance of the planet betokened a more disturbed condition than usual, the belts being full of irregularities.

The great size, durability, and special character of the red spot have naturally attracted much discussion, and a number of theories have been broached to explain the nature of the spot, and to account for its long endurance. Some writers have regarded it as part of the solid material of Jupiter, but this theory is practically negated by the fact that it has shown an irregularity of motion. Unless we admit that the rotation period of Jupiter is extremely variable, and has experienced considerable retardation in recent years, we cannot allow that the red spot forms a portion of the sphere. Others believe the spot to represent a condensation of material floating or suspended above the surface of the planet, and that variations of motion and tint are impressed upon it by the action of the Jovian atmosphere, which is constantly in a state of turmoil. Another idea has been mooted to the effect that the spot may possibly be an opening in the atmosphere, through which the surface of Jupiter has been exposed, and that the recent feebleness of the object is occasioned by the filling in of the cavity with highly reflective vapours.

The Rev. E. Ledger remarks that at one time he felt inclined to believe that the permanency of the spot "seemed to indicate that it might be something which, while coagulating or solidifying, in some way caused a gap or break in the cloudy regions above it, or by its cooling condensed the vapours incumbent upon it, and thus increased its own visibility; in fact, that we might be watching in it the gradual formation of a huge continent upon Jupiter."

The theory has also been advanced that the spot was originally formed by ejecta from a volcanic region immediately underlying it, but it must be admitted that no hypothesis appears to be entirely satisfactory in its application, and certainly we cannot regard any one of them as capable of being definitely proved. In a word, it must be avowed that though we have become familiar with the red spot, its motion, shape, and variable tints, during observation extending over more than fifteen years, we are yet far from understanding the mystery it involves. Its production was doubtless the outcome of the energy and activity prevailing above, and possibly on, the planet's surface, but in what particular way the spot

was generated it is impossible to say. Nor is the specific date of its first apparition known; it may be a modern resuscitation of the spot which delighted Hooke and Cassini about two centuries ago, or it may only have been initiated into existence just before those memorable nights in July, 1878, when it exhibited an intensely red colour, and struck observers, instantly, as being a most anomalous feature.

But though the spot forms an unsolved mystery, it will continue to be watched with interest by telescopic observers, who will much regret if its present faintness is but the prelude to final dissolution. It can be justly said that no planetary marking visible in modern times has encouraged as much observation, and incited the same amount of interest as the familiar "red spot on Jupiter." Possibly the further study of this remarkable formation may yet enhance our knowledge of the physical condition of the "giant planet," and throw some light upon the singular variations so rife upon his expansive surface.

W. F. DENNING.

#### THE PREPARATION AND PROPERTIES OF FREE HYDROXYLAMINE.

A CONSIDERABLY improved method of isolating hydroxylamine is described by Prof. Brühl, of Heidelberg, in the current *Berichte*, by which a tolerably large quantity of the pure substance may be prepared without danger in a short space of time, and which may therefore be of general interest on account of its suitability for lecture and demonstration purposes. It may be remembered that M. Lobry de Bruyn, who first isolated solid hydroxylamine two years ago (*vide* NATURE, vol. xlv. p. 20), prepared it from a mixed solution of the hydrochloride and of sodium methylate in methyl alcohol. This solution, after removal of the precipitated common salt, was first concentrated under a water bath, under the diminished pressure of 100 m.m., and afterwards subjected to fractional distillation over a flame at the still lower pressure of 40 m.m. A continuous fractionating vacuum-apparatus was considered unsuitable, and the change of receivers could only be conveniently effected by temporarily arresting the distillation. This mode of operating frequently led to violent explosive decomposition of the heated hydroxylamine, and, moreover, the yield rarely exceeded 17 per cent. of the theoretical. Prof. Brühl, desiring to obtain a considerable quantity of the pure base for spectrometric purposes, has been led to devise the following much more convenient method:—

The methyl alcohol solution is first separated from the precipitated salt, and then immediately transferred to a slightly modified form of the well-known apparatus of Prof. Brühl for fractional distillation *in vacuo*. This apparatus consists essentially of a distilling flask, provided with thermometer and entrance tube furnished with tap, a condenser, and a receiving arrangement which provides for the repeated and rapid change of receiver without impairing the vacuum and without arresting the distillation. This receiving arrangement consists of a short but wide cylinder of stout glass, into which the end of the condensing tube is introduced through a tubulus fitted with bored caoutchouc stopper; inside the cylinder is a circular stand carrying six receiving tubes, which are capable of rotation by means of a rod passing, gas-tight, through a tubulus and its caoutchouc stopper in the top of the cylinder, and terminating in a handle outside. By suitable manipulation of the handle, each of the six receivers may be brought beneath the end of the condensing tube in turn while the distillation is proceeding. The distillation of the methyl alcohol solution contained in the distilling flask is effected by reducing the pressure to the lowest possible amount, and supplying the necessary heat by immersing the flask in a bath of hot water. On

account of the explosive character of hydroxylamine, it is dangerous to employ even a small naked flame, which is liable to effect local superheating. The temperature of explosive decomposition lies in the neighbourhood of  $130^{\circ}$ ; by uninterrupted distillation in the manner indicated, and at a pressure not exceeding 22 m.m., the hydroxylamine passes over entirely at a temperature of  $56-57^{\circ}$ , and by maintaining the water bath at only a few degrees superior to this temperature all danger of explosion is avoided. The methyl alcohol is practically entirely removed by the pump. Instead of leading the distillate through a warmed condenser, as recommended by M. de Bruyn, a practice which materially diminishes the yield by decomposition of a portion of the product, Prof. Brühl finds it much more advantageous to feed the condenser with a constant supply of iced water; for although the melting point of hydroxylamine is  $33^{\circ}$ , it does not resolidify even at temperatures only a few degrees above zero, so that stoppage of the condensing tube does not occur. It solidifies instantly, however, in contact with a vessel immersed in ice and salt. The cylinder containing the receivers is therefore immersed in such a mixture, so that each drop of hydroxylamine solidifies the moment it enters the receiver. The hydroxylamine thus obtained in one operation is substantially pure. From thirty grams of the hydrochloride about ten grams of the base may be obtained in one hour, a yield of 66 per cent. of the theoretical, which is four times that obtained by the method of M. de Bruyn. In the case of hydroxylamine becoming a commercial preparation, on account of its extraordinarily great antiseptic power, it would be quite easy, by introducing suitable additional condensers, to recover the whole of the methyl alcohol employed.

The pure white crystalline hydroxylamine melts according to the mode of heating and the size of the containing tube at  $32-34^{\circ}$ , and its boiling point for a pressure of 22 m.m. is  $56-57^{\circ}$ . It may actually be cooled below  $0^{\circ}$  without solidifying, if allowed to remain at rest; but, like most other substances which exhibit the property of superfusion, it solidifies the moment it is agitated. In the solid state it does not appear to be liable to decomposition. Even in the liquid state at  $0^{\circ}$  indications of decomposition have not been observed. At  $10^{\circ}$ , however, bubbles commenced to form in the liquid, and at  $20^{\circ}$  a continuous evolution of gas, mainly nitrogen, occurs, becoming more and more violent as the temperature rises, until sudden explosion takes place. Hence in a warm summer hydroxylamine cannot be preserved in sealed glass tubes. Thus a specimen, after keeping for eight days in July, was found to be no longer capable of solidification even at  $-6^{\circ}$ , although there was sufficient of the base left undecomposed to explode with a certain amount of violence upon heating, less, however, than in the case of freshly-prepared hydroxylamine. When just prepared one drop warmed in a test tube over a flame explodes with a report equal to that of a gun-shot. It is suggested that hydroxylamine might be safely preserved in metallic vessels, for it appears likely that the notable action of the liquid upon glass causes the commencement of the decomposition.

At the temperature of  $23.5^{\circ}$  the relative density of pure liquid hydroxylamine is 1.2044. Its refractive index at the same temperature varies from 1.4375 for light of the wave-length of the red lithium line to 1.4514 for light corresponding to the blue hydrogen line  $H_{\gamma}$ . The substance thus exhibits a small refractive power and a surprisingly small dispersion. Indeed, its molecular dispersion is about the same as was found by Prof. Brühl for nitrogen itself in triethylamine, so that the atom of oxygen and the three atoms of hydrogen would appear to exert no dispersive action if the same value for nitrogen be assumed to be equally operative. The only possible explanation is that the nitrogen here united to

oxygen and hydrogen possesses a lower spectrometric constant than when attached to carbon in triethylamine. From a systematic study of the spectrometric constants of the free base, and of the methyl derivative  $\text{CH}_3\text{NH.OH}$  prepared by his assistant Dr. Kjellin, an account of which was given in the Notes of NATURE of November 9, Prof. Brühl has been enabled to prove two important facts. The first is that the constitution of hydroxylamine can be none other than  $\begin{matrix} \text{H} \\ \diagup \\ \text{N} - \text{O} - \text{H} \\ \diagdown \\ \text{H} \end{matrix}$ . The second is that the molecular refraction and dispersion of the nitrogen present in these compounds is the same as that of the nitrogen in ammonia gas, much lower than that of the nitrogen in triethylamine, and that the probable values of these constants of nitrogen linked in this manner, for sodium light, are respectively 2.495 and 0.072. This addition to our knowledge of the spectrometric constants of nitrogen will be of invaluable aid in unravelling the intricate subject of the constitution of the class of nitrogenous organic substances known as "oxims," a subject upon which Prof. Brühl is now concentrating his attention. A. E. TUTTON.

#### NOTES.

It is with much regret that we announce the death of Baron von Bülow, at Kiel. Von Bülow's Observatory, better known, perhaps, as Bothkamp Observatory, was the first in Germany devoted to astro-physical researches, and it stands as a splendid monument to his interest in astronomy. By his death astronomical physics has lost one of its most enthusiastic supporters.

THE meeting of the Vienna Academy of Sciences was adjourned on November 16, as an expression of regard for Dr. Alexander von Bach, who died on November 12.

THE memorial to Sir Richard Owen is to take the form of a full-length marble statue, executed by Mr. Thomas Brock, and placed in the Natural History Museum, South Kensington.

A BOTANICAL section has been added to the Zoological Station at Naples, with a small laboratory for algological studies and researches in vegetable physiology.

DR. OSWALD KRUCH has been appointed to the Conservatorship of the Royal Botanical Institute of Rome, recently resigned by Dr. A. Terracciano.

A REUTER'S telegram from Montreal announces that the worst earthquake ever experienced in Canada occurred there at noon on November 27. As far as has been ascertained, no lives were lost, but considerable damage has been done to property, and the walls of many buildings have been cracked.

A SEVERE earthquake was felt at Peshawur, and other places in the Punjab, about nine o'clock on the morning of November 5, but fortunately no very serious damage was done. The wave apparently extended over a large area, including the Tamrud plain and Nowshera.

AN international Photographic Exhibition will take place at Milan from May until October next year. There will be a section for professional photography, another for amateur photography, and a third for technical and industrial applications of photography.

THE Department of Science and Art has received, through the Foreign Office, a dispatch from her Majesty's Minister in Chili calling attention to an exhibition which it is proposed to hold next year at Santiago, dealing with the subjects of mining and metallurgy. The exhibition will be opened in the second

fortnight of April, 1894, but the exact date is not yet known. The eight sections of the exhibition will comprise electricity, mining machinery, mechanical preparation of minerals, metallurgy, chemical industries, statistics and plans, and mining and metallurgical products respectively.

THE Municipal Council of Lausanne has been considering a scheme for the electrical transmission of power (says *La Nature*). It is proposed to obtain work to the extent of about 1200 horse-power from the Grand-Eau river, at a distance of forty kilometres from Lausanne. This energy will be utilised to supply about 5000 lamps and 16 arc-lights during the night, while in the day it will furnish the motive power for electric trams, and motors for domestic use, besides pumping the town's water-supply to the proper level.

THE new examination laboratories of the Institute of Chemistry will be opened on Friday, December 8.

THE last of the Gilchrist lectures, in connection with the Bethnal Green Free Library, will be given on Thursday, December 7, by Dr. Andrew Wilson, on "Brain and Nerve and their Work."

PROF. BORNMÜLLER has returned from his extended botanical journey in Persia.

A COMMITTEE has been appointed by the Italian Botanical Society for the study of the flora of Italy, both phanerogamic and cryptogamic. The reports from the various members will be collated by Prof. Arcangeli, and published in the *Bulletino* of the Society.

*Bulletin* No. 38 of the Experiment Station of the Kansas State Agricultural College is occupied by a preliminary report on rusts of grain, accompanied by three plates illustrating the mode of development of *Puccinia graminis*, *P. rubigo-vera*, and *P. coronata*. In Kansas the two former of these are found chiefly on wheat, while the last is apparently confined to oats.

EVIDENCES of the existence of man in Nicaragua during the early Neolithic age were discovered by the Spaniards about the beginning of the sixteenth century. They mainly consist of flint-heads of arrows and spears, stone statues of men, and numerous fragments of pottery made of clay, containing fragments of volcanic rocks, unadorned and originally unburned. Of these evidences, those indicating the geological time or epoch in which they were made are, according to Mr. J. Crawford (Proceedings of the Boston Society of Natural History, vol. xxvi. p. 49, 1893): (1) Several well-executed stone statues found in the same locality, and all of the same brachycephalic type, carefully sculptured from blocks of hard rock, with brittle tools of flint, jasper, and felsite; (2) oblong blocks of partly metamorphosed rocks, in their natural state or but slightly shaped by man, apparently forming the foundations for an oblong temple or observatory extending east and west; (3) fragments of unadorned pottery found near the stone images, cemented in the débris of a well-marked subsidence, all discovered in the small valley on the west face of the mountain island of Momotombo. This island is situated near the volcanic cone Momotombo, and an unobstructed view of the Pacific Ocean, about twenty-seven miles to the westward, can be obtained from the observatory or temple. Mr. Crawford's examination of the locality and the handiwork leads him to believe that "the aborigines of the sculptors of the stone images found on the island came from Polynesia, over the land route or chain of almost connected islands then existing across the Pacific Ocean, and that the latest subsidence of twenty-five feet, as recorded on the island and the western part of Nicaragua, and the consequent synchronous activity of all the volcanoes in

that region, both occurring during the time when the sculptors were carving stones into images of types of their own people, caused the sculptors and their tribe to migrate eastward (the only safe route) and seek a home on the side of the very fertile and non-volcanic Amerrique mountains, where their probable descendants—the Amerriques—now reside."

THE first of the three articles in the current number of the *Internationales Archiv für Ethnographie* (vi. parts 4 and 5) is by Prof. H. H. Giglioli. It is entitled "Notes on the Ethnographical Collections formed by Dr. Elio Modigliani during his recent Explorations in Central Sumatra and Engano." Dr. Modigliani published in 1890 a valuable book, "Un Viaggio a Nias," giving an account of his anthropological investigations in that little known island. Giglioli's communication, which is fully illustrated, appears to be a preliminary notice of a forthcoming work by Modigliani, and it gives to English readers a foretaste of the extremely interesting and important investigations made by that skilled observer and excellent collector. Modigliani was not allowed by the Dutch colonial authorities to remain long among their foes the Battaks of Lake Toba, but he made good use of his time, and also discovered a magnificent waterfall. Giglioli gives an admirable summary of the arts and crafts, habits and superstitions of these literally cannibals. The islanders of Engano remarkably resemble the Nicobarese, but the faces of some of them recall Polynesian and especially Micronesian types. Like other islands, the old order is rapidly changing, and the population of about 8,000, ten years ago, is now reduced to 840. Prof. A. C. Haddon has a paper on "The Secular and Ceremonial Dances of Torres Straits," illustrated by woodcuts and four admirably executed coloured plates. This is the first time that any Papuan dances have been adequately described. The dances are classified into festive dances, war dances, ceremonial dances (including initiation and seasonal dances), turtle processions, and funeral ceremonies. The descriptions of the dances and the decoration of the performers are given in great detail; the initiation and funeral ceremonies were carefully built up, so to speak, from the accounts of the natives. Here also so much change has taken place, that in a short time it will be impossible to gather any further information of any value. Prof. W. Joest has an illustrated paper on various toys ("Allerlei Spielzeug"). There are also the usual notes, reviews, and bibliography.

WE have received from Sgr. Arcidiacono a pamphlet containing the results of observations of the geodynamic phenomena which preceded, accompanied, and followed the Etna eruptions of May and June, 1886, carried out under the direction of the late Prof. Orazio Silvestri, of the University of Catania. This work forms a valuable addition to geodynamic literature, and contains a detailed account of the movements, both microscopic and sensible, observed in the various seismological stations around Etna from May 18 to June 11, a table of all the shocks recorded, with their general character, direction, and intensity, and a reproduction of the seismograph diagram in the form of a curve about 15 feet long, which shows the course of the phenomena as recorded between the dates May 8 and June 16. The general aspect of calm was first broken on May 12, where slight and slow perturbations are recorded. These were repeated more emphatically on May 14 and 15. The 17th was calm, but at 10.30 a.m. on the 18th the explosion of the central crater occurred, which threw the barometer stile right off the scale. This was followed by a continued succession of violent shocks during the same day, and by the eccentric explosion of the southern flank on May 19. The eruption then followed a regular course until May 26, the disturbances being much smaller and of nearly constant average amplitude for each hour. A steady diminution of the eruptive

force took place until May 31. This and the following day were visited by two considerable shocks, followed by another strong concussion on June 5, which marked the close of the eccentric eruption. The 9th witnessed some disturbances accompanying a mild eruption of the central crater, and calm was finally re-established on June 14. A coincidence worth noticing is that of the highest barometric pressure observed during all that time, a pressure of 771 mm., with that of the great central eruption on May 18. The greatest disturbances were produced along a line passing through the focus in a direction from east-north-east to west-south-west, this being at right angles to a radial line which was the seat of the 1883 eruption.

MEASUREMENTS of the amount of light absorbed by thin metallic films of various thicknesses are incapable of affording a true measure of the absorptive power of these films unless the films compared have the same reflecting power at normal incidence. M. Salvador Bloch has been for some time experimenting with collodion films coloured with fuchsine, and thus made to exhibit a metallic aspect. According to an account published in the *Comptes Rendus*, he has succeeded in obtaining films of different thicknesses and of equal reflecting powers. Two pellicles formed by pouring layers of different thickness over glass plates, and evaporating under the same conditions, show, if all goes well, a strong resemblance as to reflecting powers. This was tested by studying with a Babinet compensator the ellipticity of the green rays near the E line reflected from the pellicle. The employment of sunlight enabled the observer to measure differences of phase down to  $\frac{1}{20}$  of a wave-length. For two such pellicles no difference of phase exceeding or even approaching that limit was observed in any portion of the films. Three such films, called A, B, and C, and of thicknesses 744, 1921, and 1964  $\mu$ , respectively, were used for determining the index of absorption for the yellow D rays. The index of absorption was taken as defined by the fact that a vibration progressing in the absorbing medium through a length  $\frac{\lambda}{2\pi}$  has its amplitude reduced in the ratio  $1 : e^{-\gamma}$ , where  $\gamma$  is the index of absorption. From A and C combined,  $\gamma$  was found to be 0.088, and from A and B 0.084. Films of such thickness were opaque to green, but another set of films, of thicknesses 353, 504, and 627  $\mu$ , respectively, were found thin enough for measurements in the case of green light. The two corresponding values found were 0.529 and 0.505. The spectrophotometer used was analogous to a half shadow polarimeter. A polarised beam of sunlight fell normally upon a biquartz. The light then passed through an analyser with divided circle, and then through a lens, which projected an image of the biquartz upon the slit of a spectroscope provided with an eye-slit. The spectrum then consisted of two superposed portions, each corresponding to one of the quartz plates. The film was then cut half off the glass, and placed so that the edge coincided with the junction of the biquartz, with the result that the light suffering absorption passed through one of the quartzes only. Equality was established by turning the analyser. A special advantage of this arrangement is that it requires only one source of light.

THERE exist at present numerous arrangements for "turning down" an electric light, the chief peculiarity of them all being that nearly as much electrical energy is consumed when the lamp is only glowing feebly as when it is giving its normal amount of light. An arrangement to which this objection does not apply is described in the Proceedings of the American Institute of Electrical Engineers for September, by Mr. F. Moore. In the circuit of the lamp there is placed an automatic interrupter, consisting of a small electromagnet and an armature held back by a spring; the contacts being so arranged that as the armature vibrates the current is interrupted during part of

the oscillation. By this means different amounts of current can be passed through the lamp, for by moving the electromagnet nearer to or further from the armature, the speed with which the latter vibrates can be varied. To avoid the destructive effect of the sparks at the contacts the whole armature is enclosed in a glass globe from which the air has been exhausted. Under these conditions it is found that platinum contacts remain good for a considerable time. When the interrupter is at work the sparks produce in the exhausted globe a phosphorescent glow which the author thinks may possibly be made use of for the purpose of giving light. Another application of the above is for running lamps on circuits of much higher voltage than they are intended for.

*Wiedemann's Annalen der Physik und Chemie* for November contains an interesting paper by R. Hennig, on the magnetic susceptibility of oxygen. The method employed, namely, the measurement of the displacement in a magnetic field of a short column of liquid in a slightly inclined capillary tube, due to the difference in the susceptibility of the two gases (oxygen and air) at the two ends of the liquid column, would hardly seem at first sight capable of giving very accurate values. The author, however, has obtained very fairly consistent results, and finds the value  $0.0963 \times 10^{-6}$  for the difference between the susceptibility of oxygen and air at a temperature of about 26° C., and at pressures varying from 75 cm. of mercury to 328 cm. In order to measure the strength of the magnetic field a small coil was suspended by a bifilar-suspension close to the capillary tube, and from the deflection, when a known current was passed through this coil, the strength of the field was calculated. The results obtained by this method were also compared with those found by the rotation of polarised light in a piece of heavy glass, and by means of a small induction coil which could be rapidly moved out of the field.

SOME interesting investigations on the vitality of the cholera organisms on tobacco have been made by Wernicke (*Hygien: Rundschau*, 1892, No. 21). Small pieces of linen soaked in cholera broth-cultures were rolled up in various kinds of tobacco, and the latter made into cigars. At the end of twenty-four hours only a few bacilli were found on the linen, and none on the leaf. On sterile and dry tobacco leaves, the bacilli disappeared in one-half to three hours after inoculation. On moist, unsterilised leaves they disappeared in from one to three days, but on moist and sterile leaves in from two to four days. When introduced into a five per cent. tobacco infusion (10 grams of leaves to 200 grams of water), however, they retained their vitality up to thirty-three days; but in a more concentrated infusion (one gram of leaves to two grams of water, they succumbed in twenty-four hours. When enveloped in tobacco smoke, they were destroyed, both in broth-cultures as well as in sterilised and unsterilised saliva, in five minutes. Tassinari, in his paper, "Azione del fumo di tabacco sopra alcuni microrganismi patogeni" (*Annali dell'Istituto d'Igiene*, Rome, vol. i., 1891), describes a series of experiments in which he prepared broth-cultures of different pathogenic microbes, and conducted through them the smoke from various kinds of tobacco. Out of twenty-three separate investigations, in only three were the cholera organisms alive after thirty minutes' exposure to tobacco fumes. But in actual experience the apparent antiseptic properties of tobacco have not unfrequently been met with; thus, during the influenza epidemic in 1889, Visalli (*Gazzetta degli Ospedali*, 1889) mentions the remarkable immunity from this disease which characterised the operatives in tobacco manufactories; that in Genoa, for example, out of 1200 workpeople thus engaged, not one was attacked; whilst in Rome the number was so insignificant that the works were never stopped, and no precautions were considered necessary.



THE *Deutsche Seewarte* has published No. xi. of the results of observations taken in the North Atlantic on ships supplied with instruments either belonging to that institution, or verified by it. Each part contains all the observations made in a ten-degree square, which is again subdivided into 100 one-degree squares, grouped in such a way that anyone can make use of them as they are, or they can be eventually combined with the observations made by any other institution. The tract now covered by these volumes extends from latitude 20°-50° N., and longitude 10°-50° west (with the exception of one square), and this district joins on to that for which the data were discussed some years ago by the Meteorological Council, and extending from 20° N. to 10° S. latitude; so that for nearly all that part of the North Atlantic which is traversed [by] long-voyage ships a large amount of useful data is available, either for scientific inquiry or for the purpose of navigation. The winds are tabulated under sixteen points, and storms under four quadrants, while the mean values of pressure, temperature, &c., are deduced from the total number of observations in each sub-square. This work is quite independent of the synoptic weather charts of the North Atlantic, which are regularly prepared by the Seewarte, in conjunction with the Danish Meteorological Institute.

THE *Kansas University Quarterly*, vol. ii. No. 2, contains three articles by Prof. S. W. Williston. In one of these, entitled "Kansas Pterodactyls," a previous article is referred to, in which the opinion was expressed that the genus *Pteranodon* occurs in Europe. Since then Prof. Williston has seen papers by Prof. Seeley, in which the same view is held, and an attentive examination of the evidence leads him to say: "I am satisfied that there can no longer be any reasonable doubt of the congenerousness of our species with those included in the genus *Ornithostoma*. Seeley, a generic name antedating *Pteranodon* Marsh by some five years."

MR. R. L. JACK, the Government Geologist at Brisbane, has prepared a report on the progress of the geological survey of Queensland during 1892. Attention has been confined to detailed mapping of small areas of economical importance. For a general colony map it is thought that the scale of sixteen miles to an inch permits sufficient detail to be shown. As visiting the different mines will occupy some considerable time, it is intended to publish, in the meantime, a map showing the geological features, which will also be useful in the hands of miners and the general public for its topography. On the map, which is now being drawn on stone, are shown the outcrops of most of the reefs, as at present understood. A subsequent edition will show the actual or inferred outcrops of all the reefs, the underground workings, and the geological information acquired in the course of the underground survey by the Geological Staff. On the completion of the work, it is in contemplation to construct a glass model, the surface of which will be coloured, and the outcrops of the reefs shown in the same way as in the geological map, and the extension of underground geological boundaries, so far as ascertained, will be represented. Its main advantage, however, will be that the exact position of the reefs with relation to the surface features and artificial boundaries will be understood at a glance, and the depth at which any given reef would be met with in any position could be ascertained by a simple calculation.

A PAPER read by Dr. V. Ball, before the Royal Irish Academy on January 23 of this year, has been reprinted from the "Proceedings" (3rd Ser. vol. iii. No. 1, pp. 151-169). The title is "On the Volcanoes and Hot Springs of India, and the Folk-Lore connected therewith." Dr. Ball shows how the evidences of past volcanic activity in India—the metamorphism of sedimentary rocks by the Deccan traps into porcellanic shales,

the agates, cornelians, &c. produced, the peculiar appearance of old craters, the "Lonar Lake," the natural caves and pillared temples of basaltic rock, &c.—have formed a nucleus of truth around which the religious spirit of the people has wrapped coil upon coil of myth and the marvellous. Sometimes undue credence has been given by travellers to native tales of smoke emanating in present times from peaks in Western Bengal and the Central Provinces. For these no better foundation could be discovered by Dr. Ball than the ordinary atmospheric effects of mist and cloud. Bhawani Patna, in the Central Provinces, is an example of a "mythical volcano." Hot springs have more especially appealed to the superstition of the people, and served the purposes of the native priesthood. Dr. Ball stated that the total number of recorded sites where hot springs occur in India is about 300. He gave then a concise account of the most important scientific phenomena associated with the hot springs, and details, in some cases, of the particular virtues, medical and spiritual, ascribed to them by the people. He called attention, in concluding, to the local character of the vegetation near hot springs, and of the fauna which are sometimes present in their waters, e.g. the famous Magar Pir, seven miles north of Karachi, with its numerous crocodiles.

THE August number of the *Records of the Geological Survey of India*, vol. xxvi. part 3, has been sent us. An important paper is the "Geology of the Sherani Hills," by Mr. T. D. La Touche, with a geological map of part of the Sulaiman Range and several sections and sketches (pl. i.-v.). The first part of the paper is devoted to the physical features. The stratigraphical geology of the Sherani Hills is not complicated; the deposits in the area examined range from Cretaceous to recent and sub-recent time, and a complete table of the succession and the relative thicknesses of the rocks is given on p. 82. Dr. Fritz Noetling describes "Carboniferous Fossils from Tenasserim"; good specimens of *Lonsdaleia salinaria*, and new species of *Lithostrotion* and of *Schwagerina* are figured on the accompanying plate. Details are given by Mr. R. D. Oldham, Superintendent Geological Survey of India, of a deep boring at Chandernagore, and a "Note on Granite in the Districts of Tavoy and Mergui" (with plate), by P. N. Bose. Especial comment is made in the "Tri-Monthly Notes of the Geological Survey of India Department" upon the completion of the second edition of the "Manual of the Geology of India," by Mr. Oldham.

THE calendar for the year 1893-4 of the University College of North Wales has just been issued.

WE note with pleasure that the Oxford University Press has published two more editions of the "Oxford Bible for Teachers," containing the excellent "Hints to the Study of the Bible" reviewed in NATURE of October 5.

WE have received a "Record" of results of observations in meteorology and terrestrial magnetism made at the Melbourne Observatory and at other localities in the colony of Victoria, Australia, from July to December, 1892, under the superintendence of Mr. R. L. J. Ellery, the Government Astronomer. In the future this "Record" will be issued quarterly instead of monthly.

MESSRS. WILLIAM WESLEY AND SON have issued their 118th "Natural History and Scientific Book Circular." The catalogue includes a number of works from the library of the late Sir G. B. Airy, in addition to transactions of scientific societies, periodicals and serials, Government reports, and works dealing with the history of science. It should be in the hands of every bibliophile.

THE sixth edition of a book known to most chemists, viz. "Laboratory Teaching," by the late Prof. C. L. Bloxam, has

been published by Messrs. J. and A. Churchill. Mr. A. G. Bloxam, the editor of the new edition, has made several important additions and alterations, and these changes will doubtless enable the book to retain its high position among the many works that now exist on practical chemistry.

WHAT are happily termed "Drum-and-trumpet Histories" have not been so numerous since the publication of the late Mr. Green's famous narration of the development of the English people. A more pretentious work of a similar kind is "Social England," edited by Dr. H. D. Traill, and published by Messrs. Cassell and Co. In this history a section of each epoch is devoted to a description of the conditions of science and learning, and another to trade and industry. The departure cannot be too highly commended, for the truest epic of a nation's life is that in which the interests of all classes are recited.

LANTERNISTS will be glad to learn that Messrs. Perken, Son and Rayment have introduced a new oil-lamp, possessing three times the candle-power of those hitherto used for lantern projection. This gain of brilliancy is obtained by dividing the oil reservoir, so as to provide central air-shaft. The combustion is thus rendered more perfect, and the odour that usually accompanies ordinary lamps is correspondingly decreased. For small audiences the lamp will suit a lecturer's purpose quite as well as the lime-light. Doubtless the recent fatal result of the breaking of an oxygen cylinder at Bradford will considerably increase the demand for perfected lamps of this kind.

THE success of Sir John Lubbock's book on "The Beauties of Nature" has induced Messrs. Macmillan to issue a cheap edition, without illustrations. Though the book possesses a good table of contents, its value would be increased by the addition of an index. The author will be glad to have his attention called to one or two slips. On p. 207, Jupiter is said to have four satellites, whereas Prof. Barnard's discovery has brought the number up to five. Nitrogen should be removed from the list of elements in comets (p. 213), and *Clarke* (p. 223) should be *Clerke*. These slips, however, are but spots on the sun, for there are few books that will enlighten the general reader more than the one before us.

A REMARKABLE new substance, isocyanogen tetrabromide,  $\text{Br}_2\text{C}=\text{N}-\text{N}=\text{CBr}_2$ , has been obtained by Dr. Thiele in the laboratory of the Munich Academy of Sciences, and an account of it is contributed to the current *Berichte*. It was prepared by the reduction of azototetrazine, a new substance very rich in nitrogen (concerning which Dr. Thiele promises a further communication), and by treatment of the reduction product, hydrazotetrazine, with bromine. Isocyanogen tetrabromide is readily volatile in steam, insoluble in water, but soluble in organic solvents, particularly in ether. It crystallises from glacial acetic acid in large prisms, which rapidly lose their brilliancy, however, upon removal from the mother-liquor. The crystals melt at  $42^\circ$ , emitting a most pungent, irritating odour. The crystals normally in the cold evolve the same odour, although not so strongly as when warmed. Concentrated sulphuric acid, at the temperature of a water-bath, rapidly dissolves them with production of hydrazine and evolution of carbon dioxide, hydrobromic acid, and smaller quantities of free bromine and sulphur dioxide. Water precipitates from this solution a large quantity of hydrazine sulphate, which may easily be identified by its melting-point ( $256^\circ$ ), its reduction of silver solutions, and its formation of a difficultly soluble double sulphate with copper sulphate. The reaction for the decomposition by sulphuric acid is probably as follows:



Dilute hydrochloric and sulphuric acids only attack the tetrabromide after long-continued heating to  $300^\circ$ , the former then converting it into nitrogen and ammonia, and the latter oxidising

it. Its reaction with alkalis is specially interesting. It dissolves readily in them, and upon subjecting the alkaline liquid to distillation another new compound, which is probably isocyanogen oxide  $\text{OC}=\text{N}-\text{N}=\text{CO}$  or a polymer of that substance, passes over with the last portion of distillate. If a reducing agent, such as alcohol, a ferrous, manganous or stannous salt, is added to the alkaline solution, a powerful odour of the well-known isonitrile kind is at once emitted. This same odour is produced when the alcoholic solution of the tetrabromide is decomposed with zinc dust and a little chloride of zinc. It appears most probable that the odour is due to the hitherto unisolated isocyanogen,  $\text{C}=\text{N}-\text{N}=\text{C}$ . The supposition is further justified by the fact that the strongly odorous substance is expelled by boiling in a current of carbon dioxide, and is capable of absorption by hot dilute sulphuric acid with formation of a solution of just such powerfully reducing proclivities as might be expected from a solution of hydrazine and formic acid.

THE first results of an important research in connection with the melting-points of the more refractory inorganic salts are likewise communicated to the current *Berichte* by Prof. Victor Meyer and Dr. Riddle. The observations have been made with the object of ascertaining the relations of the melting-points of definitely connected salts, those already investigated being the chlorides, bromides, and iodides of sodium and potassium, and the sulphates of those metals. The method adopted in order to measure such high temperatures with accuracy was essentially as follows:—The salt was heated considerably above its melting-point in a capacious platinum crucible, by means of a Perrot furnace. The crucible was then removed from the furnace, and an air thermometer, constructed of platinum and on the compensating principle, was inserted into the liquid salt. As soon as solidification of the latter commenced the temperature remained constant for some little time, quite sufficient to enable the air, or in the cases of very high melting-points, the nitrogen contained in the thermometer, to be displaced by hydrochloric acid gas, and its volume measured over water. The results obtained are the following:—The chloride, bromide, and iodide of sodium melt at  $851^\circ$ ,  $727^\circ$ , and  $650^\circ$ , respectively; the analogous salts of potassium fuse at  $766^\circ$ ,  $715^\circ$ , and  $623^\circ$ . In each case a lowering of the melting-point accompanies the increase of the atomic weight either of the halogen or of the metallic element. Potash (presumably the oxide) melts at  $1045^\circ$ , and soda at  $1098^\circ$ , the same rule again applying. In the cases of the sulphates, however, sodium sulphate is found to melt at  $843^\circ$ , and potassium sulphate at the much higher temperature of  $1073^\circ$ , a result contrary to the rule for the halogen salts, but which is quite in keeping with other well-known differences which the oxy-salts of sodium and potassium exhibit.

THE additions to the Zoological Society's Gardens during the past week include a Chacma Baboon (*Cynocephalus porcarinus*, ♂) from South Africa, presented by Mr. W. S. Cox; two Common Marmosets (*Haipale jacchus*) from Brazil, presented by Dr. S. Steggall; a Pallas' Goat (*Capra cylindricornis*, ♀) from the Caucasus Mountains, presented by Mr. H. H. P. Deasy; a Duyker Bok (*Cephalophus mergens*, ♂) from South Africa, presented by Miss Gertrude A. Winly; three Palm Squirrels (*Sciurus palmarum*) from India, presented by Mrs. S. W. MacIver; a Meyer's Parrot (*Pseocephalus meyeri*) from South Africa, presented by Mrs. B. Searelle; a Great Eagle Owl (*Bubo maximus*) from China, presented by Major Boyd Bredon; two Puffins (*Fraterecula arctica*) British, presented by Mr. E. Hamond; a Brown Capuchin (*Cebus fatuellus*, ♂) from Brazil, a Rhesus Monkey (*Macacus rhesus*, ♀) from India, six Meyer's Parrots (*Pseocephalus meyeri*), an Alario Sparrow (*Passer alario*) from South Africa, deposited; two Redshanks (*Totanus calidris*), British, purchased.

## OUR ASTRONOMICAL COLUMN.

OTTO STRUYE'S DOUBLE-STAR MEASURES.—The most important addition to double-star astronomy during the last year is without doubt the work which we owe to Otto Struve, and which is entitled "Mesures Micrométriques des Étoiles Doubles" (Observations de Poulkova Tome IX. (avec un supplément) et Tome X.). The period which the observations cover is very large when one considers that it is for one observer, commencing as it does with the observations made in the year 1837, when Otto Struve was only seventeen years old. Readers who are unable to approach these volumes themselves will find that M. Bigourdan, in the October number of the *Bulletin Astronomique*, gives a general summary of the whole of the contents. As one would expect, the introductions to the volumes contain a mine of important information, both with regard to the measures and to the puzzling question of the "personal equation," a question on which even to-day astronomers hold different views. Otto Struve busied himself especially in this direction, making, in the years 1853-1876, a series of measures of artificial double stars. The expressions for the corrections which he obtained assumed considerable proportions, as will be seen below, the first being that for angles of position, and the second that for distance:—

Position angle

$$\text{Corr.} = + \frac{5^{\circ}2}{1 + 0.20g^2} + \frac{4^{\circ}4 \sin(2\phi - 27^{\circ}13')}{1 + 0.14(3.3 - g)^2} + \frac{5^{\circ}6 \sin(4\phi - 25^{\circ}0')}{1 + 0.20g^2}$$

Distance

$$\text{Corr.} = + \frac{0''050(g - 2.0)}{1 + 0.09(4.2 - g)^2} + \frac{0''15 \cos(2\phi - 28.4)}{1 + 0.06(5.2 - g)^2}$$

when  $g$  represents "l'angle visuel du couple considéré expérimenté en prenant pour unité celui qui correspond au grossissement de 708 fois," and  $\phi$  is the angle of the line between the two stars and the vertical.

Whether such corrections as these, made under non-observational conditions, should be applied to measures actually made in the sky is still open to much doubt. Otto Struve discusses also the observations made at Pulkova with those made at the same epoch by different observers; the comparison, to take an example, shows that Dawes's position angles in his early measures appear free from systematic error, while those made later require a correction of  $+1''.8$ ; his distances up to  $8''$  seemed all to be desired. Dembowski's measurements of angles also required no correction, but his distances, especially about  $6''$ , demand a small positive correction ( $0''.22$ ). In the second volume one finds the measures of W. Herschel's classes V. and VI., couples with large proper motion, including measures for the determination of parallaxes, and for the determination of the relation of the number of optical to physical binary stars discovered by M. Burnham and other astronomers, and a continuation of W. Struve's and O. Struve's measures. Double-star astronomy is already possessed of two fine monuments in the works of W. Struve's "Mensuræ Micrometricæ" and of Baron Dembowski's "Misure Micrometriche," and to-day we may, as M. Bigourdan adds, name a third in the "Mesures Micrométriques des Étoiles Doubles" of M. Otto Struve.

METHOD OF PIVOT TESTING.—By means of interference fringes, employed by M. Fizeau in his researches on crystals, M. Maurice Hamy describes a method of studying the form of pivots of a meridian instrument (*Comptes Rendus*, No. 20, Nov. 13th), which indicates errors not discernible by the ordinary course adopted. The great advantage to be gained by it is that the state of the pivots can be very easily, and with the expenditure of a very little time, ascertained. The arrangement consists in placing a metallic block astride a pivot, the block being supported further by a pointer fixed to a part of the telescope. The extremity of this pointer fits into the bottom of a horizontal groove, parallel to the meridian, in the pier. Contacts between the pivot and the pointer is thus ensured by the pressure of several weights, while displacements of the whole arrangement against slipping are totally eliminated. On the block rests, at one of its extremities above the centre of the pivot, a lever which is movable about an axis on the pillar on a vertical plane; this carries a small horizontal piece of glass, fixed in a certain manner. Between this mirror and the front of the lens of a fixed collimator are produced the interference fringes, the source of light (monochromatic) being placed at the focus of the lens. Turning the telescope on its

axis, the block remains still, but movements of a small nature in the vertical direction were observed which were sufficient to indicate the imperfectness of the pivot. To obtain at a glance the order of the magnitude of such errors, a plane mirror was fixed at some distance from the axis of the lever, so determined that the fringes were displaced by a row when the inclination of the telescope experienced a perturbation of  $0.015$ , by the action of one of the irregularities. The method of observation consists simply in counting the number of fringes which exceed a fixed limit when the telescope is turned, the number thus obtained expressing in hundredths of a second in time the order of the error. A trial of the above method shows that irregularities on the surface of pivots can be easily observed, and, moreover, the errors "ne sont pas complètement négligeable au point de vue des observations."

A BRIGHT METEOR.—The following are a few facts about a bright meteor which Prof. Schur, of Göttingen, has been good enough to send us:—The meteor was observed on Monday, November 27, at 5h. 54m. mean time, and the direction of its path lay between  $\zeta$  Persei and towards  $\alpha$  Piscium. At first it appeared as bright as  $\alpha$  Tauri, and then quickly excelled Jupiter in brilliancy, the light gradually fading away afterwards. The duration of the phenomenon was estimated at about ten seconds, and the trail was observed to be of a yellowish-red colour. Curiously enough, three minutes later a fainter meteor shot across the heavens from the zenith, its direction being nearly at right angles to that of the preceding one.

ASTRONOMICAL PHOTOGRAPHY.—Mr. H. C. Russell, F.R.S., President of the Astronomy, Mathematics, and Physics Section of the Australasian Association for the Advancement of Science, traced the history of astronomical photography in his presidential address at the recent Adelaide meeting. "In many departments of astronomy," he declared in the opening paragraph, "the observer must stand aside while photography takes his place and works with a power of which he is not capable, and I feel sure that in a very few years the observer will be displaced altogether, while his duty will be done by a new sensitive being—a being not subject to fatigue, to east winds, to temper, and to bias, but one above all these weaknesses, calm and unruffled; with all the world shut out, and living only to catch the fleeting rays of light, and tell their story."

"VIERTELJAHRSSCHRIFT DER ASTRONOMISCHEN GESELLSCHAFT."—The third part of this year's publication gives an account of the work done at the observatories usually included in this list, each director, as has been done in former numbers, summing up in a few words, and stating the work being, and about to be, accomplished. We must refer our readers to the publication itself for individual information.

## GEOGRAPHICAL NOTES.

*L'Afrique* gives a brief account of the last exploring journey of the late M. Georges Muller in Madagascar. He had returned to Antananarivo from a successful visit to Antsirabe, where he went to collect bones of *epiornis*, and in June he set out for Lake Alaotra, which, in company with Father Roblet, he explored, adding a number of features to the maps of the district. Parting from his companion, Muller pushed on with the view of reaching Mojanga on the west coast, but near Mandritsara he was attacked and murdered by a party of Fahavalos, one of the independent tribes who still contend against the Hova supremacy of the island.

THE *Madras Mail* says that the Indian Marine Survey vessel *Investigator* has proceeded to the Laccadives to continue the survey of those islands, which has been in course of preparation during the last two years. From the Laccadives the *Investigator* will go to Madras, and will be engaged for a few weeks in completing the East Coast Marine Survey from Pulicat Lake, where work was left off last year, to Madras Harbour. Finally in February the *Investigator* will proceed to Palk Straits, and a thorough survey of the dividing sea between India and Ceylon will be made, ostensibly with the object of testing the practicability of constructing a canal and a railway. The distance from the Indian mainland to Ceylon is sixty miles, of which twenty constitute Adam's Bridge proper. The bridge is said to consist of an irregular ridge formed of rock and sand partly dry at low water, but intersected by small intricate channels navigable only for native boats of very light draught. Average

spring tides rise only about two feet, so that the construction of the railway works and their future maintenance would be greatly facilitated. It is thought that the works required would consist of an iron and steel viaduct of considerable length, but in short spans, no large span being required except over the existing navigable channel, where a swing bridge would probably be necessary. Until a detailed survey of the strait has been made, however, it is impossible to speculate upon the details of the railway or the canal project with any degree of certainty; and the Government of India is determined to settle the question once for all by making a thorough survey of the coast and dividing sea.

FULL particulars have lately been received of the death by drowning, in September last, of Mr. H. M. Becher, while on his way to visit the mountain known as Gunong Tahan in the province of Trengganu in the Malay peninsula. He had come within sight of the mountain, which had never before been seen by a European, and roughly estimated its height at between 8,000 and 9,000 feet, when his camp on a low island in a river was submerged by a sudden flood, and the boat in which he attempted to reach the shore capsized. His companion, Mr. H. Quin, escaped, but did not continue the journey.

A LONG letter just received from Mr. Astor Chanler, who is travelling in East Africa, is published in the December number of the *Geographical Journal*. It contains the unfortunate tidings that his companion, Lieutenant von Höhnel, whose previous successful travels in East Africa are well known, had been seriously wounded by a rhinoceros, which rendered his immediate return to Europe necessary. Mr. Chanler, although he has suffered greatly from loss of men and animals, is determined to push on to the north in the hope of reaching Berbera or Zeila. At the time of writing, September 20, the party had returned to Daicho, near Mount Kenia, after a visit to the Rendile tribe, who live in the country to the north. These people appear to have strong Somali affinities, and were more intelligent than the Masai, but equally fierce and intractable. The loss of von Höhnel's services will detract from the geographical value of the expedition, as he is an accomplished surveyor.

IN our last issue we gave, without comment, an abstract of one of the rumours regarding the Nansen expedition, published by an evening newspaper. It is right to add, however, that the report of high land north of the New Siberian Islands is no new thing, and that Nansen has no thought of taking up winter quarters on any land, his intention being to get fast in the ice, and drift wherever it carries him. His only object in touching at the New Siberian Islands was to send letters home; but if the sea was as favourable as we believe it to have been, he would probably strike straight northward without calling anywhere.

#### ANTARCTIC EXPLORATION.

AT the meeting of the Royal Geographical Society on Monday evening Dr. John Murray, of the *Challenger* Expedition, read a paper on the renewal of Antarctic exploration. He sketched the history of voyages to the far south, and of the notions which prevailed as to the nature of the South Polar region from the earliest time down to the present day. He showed that while the huge southern continent believed in by the geographers of past ages had been vastly diminished by increased knowledge, the probability is that around the South Pole a land area of about 4,000,000 square miles actually exists. He indicated the present state of our knowledge of the region, which is extremely meagre, and then went on to show that until this knowledge was greatly increased many problems in science must remain unsolved. Until we had a complete and continued series of observations in the Antarctic area the meteorology of the globe could not be understood. Important problems in geology, in biology, in physics, in oceanography, demanded the renewal of research on an adequate scale in the South Polar area. Dr. Murray concluded as follows:—

Within the past few months I have been in communication with geographers and scientific men in many parts of the world, and there is complete unanimity as to the desirability, nay, necessity for South Polar exploration, and wonder is expressed that an expedition has not long since been fitted out to undertake investigations which, it is admitted on all sides, would be of the greatest value in the progress of so many branches of natural knowledge.

To determine the nature and extent of the Antarctic continent; to penetrate into the interior; to ascertain the depth and nature of the ice-cap; to observe the character of the underlying rocks and their fossils; to take magnetic and meteorological observations both at sea and on land; to observe the temperature of the ocean at all depths and seasons of the year; to take pendulum observations on land, and possibly also at great depths in the ocean; to bore through the deposits on the floor of the ocean at certain points to ascertain the condition of the deeper layers; to sound, trawl, and dredge, and study the character and distribution of marine organisms. All this should be the work of a modern Antarctic expedition. For the more definite determination of the distribution of land and water on our planet; for the solution of many problems concerning the Ice Age; for the better determination of the internal constitution and superficial form of the earth; for a more complete knowledge of the laws which govern the motions of the atmosphere and hydrosphere; for more trustworthy indications as to the origin of terrestrial and marine plants and animals, all these observations are earnestly demanded by the science of our day.

A dash at the South Pole is not what I now advocate, nor do I believe that is what British science, at the present time, desires. It demands rather a steady, continuous, laborious, and systematic exploration of the whole southern region with all the appliances of modern investigators.

This exploration should be undertaken by the Royal Navy. Two ships, not exceeding one thousand tons burthen, should, it seems to me, be fitted out for a whole commission, so as to extend over three summers and two winters. Early in the first season a wintering-party of about ten men should be landed somewhere to the south of Cape Horn, probably about Bismarck Strait at Graham's Land. The expedition should then proceed to Victoria Land, where a second similar party should winter, probably in Macmurdo Bay near Mount Erebus. The ships should not be frozen in, but should return to the North, conducting observations of various kinds towards the outer margins of the ice. After the needful rest and refit, the position of the ice and the temperature of the ocean should be observed in the early spring, and later the wintering parties should be communicated with, and, if necessary, reinforced with men and supplies for another winter. During the second winter the deep-sea observations should be continued to the north, and in the third season the wintering parties should be picked up and the expedition return to England. The wintering parties might largely be composed of civilians, and one or two civilians might be attached to each ship; this plan worked admirably during the *Challenger* expedition.

It may be confidently stated that the results of a well-organised expedition would be of capital importance to British science. We are often told how much more foreign governments do for science than our own. It is asserted that we are being outstripped by foreigners in the cultivation of almost all departments of scientific work. But in the practical study of all that concerns the ocean this is certainly not the case; we have to acknowledge no superiors nor equals in this branch of investigation, and if we be a wise and progressive people, British science will always lead the way in this direction. Twenty or thirty years ago we were in profound ignorance as to the condition of all the deeper parts of the great ocean basins; now we have a very accurate knowledge of the conditions which obtain over the three-fourths of the earth's surface covered by the waters of the ocean. This is the most splendid addition to earth-knowledge since the circumnavigation of the world, and is largely due to the work and exertions of the British navy in the *Challenger* and other deep-sea expeditions.

This country has frequently sent forth expeditions, the primary object of which was the acquisition of new knowledge—such were the expeditions of Cook, Ross, and the *Challenger*; and the nation as a whole has always approved such action, and has been proud of the results, although they yielded no immediate return. Shall it be said that there is to be no successor to these great expeditions?

A preliminary responsibility rests on the geographers and representatives of science in this country. It is necessary to show that we have clear ideas as to what is wanted, to show that a good workable scheme can be drawn up. When this has been done it should be presented to the Government with the unanimous voice of all our scientific corporations. Then, I have little doubt, that a Minister will be found sufficiently alive to the spirit of the times, and with sufficient courage to add a few

thousand pounds to the navy vote for three successive years, in order to carry through an undertaking worthy of the maritime position and the scientific reputation of this great empire.

An animated discussion, in which the Duke of Argyll, Lord Charles Beresford, Sir Joseph Hooker, Sir George Nares, Sir Vesey Hamilton, Capt. Wharton, Sir W. Turner, Sir W. Flower, Dr. Buchan, and Mr. W. S. Bruce took part, followed the reading of the paper. All the speakers strongly expressed their conviction that the time had come to make a vigorous attempt to resume the long-interrupted line of advance into the south polar regions by means of a Government expedition.

### PHENOMENA OF THE TIME-INFINITESIMAL.<sup>1</sup>

SCIENCE consists in the extension of our knowledge of the external universe, and it brings about this extension in great part by reinforcement of our senses. To bring into the field of observation the very distant and the very small, are therefore regarded as important scientific achievements, and the telescope and the microscope, by means of which this widening of the realm of knowledge has been made, as important implements of research.

Man's relation to time is such that it is difficult to conceive of an instrument which should bring distant events to hand in like manner for inspection. Our time vision turns chiefly in one direction—towards the past—and is obscured by the intervention of something very like a medium or atmosphere, through which we see dimly. As to the future, our thoughts are necessarily confined to matters found by experience of the past to be periodic, or to changes already begun and known by the observation of analogous processes to be likely to run some definite course. In the interpretation of the future by the past, there is much of interest to the physicist; but it is not of this that I would speak to-day. Let us turn our attention rather to the study of minute time intervals in physics—to a consideration of the methods by which we may record what takes place during infinitesimal elements of time. The interest of the physicist in time is confined really to a study of phenomena. He ascribes no property to time itself, beyond defining it after Riemann, as a complexity of the first order.<sup>2</sup>

As between the study of the infinitely great and the infinitesimally small, whether of space or of time, there is a peculiar value to be attached to the latter, because the only methods which have proved the least fruitful in the analysis of the more complex changes which are going on around us, are those which begin with the infinitesimal. We consider an element of mass or of volume, or sometimes merely the element of a surface or line, proceeding then to extend our statements so far as our powers of mathematical expression will permit.

Now the element of time is, of course, purely relative. In certain phenomena the time infinitesimal is so short as compared with any time interval with which we are able to cope experimentally as to be out of reach, just as in special relations the dimensions of the molecule and atom are such that we dare not hope to render these ultimate particles of matter visible even under the microscope. There are periodic phenomena, on the other hand, the periods of which are so great that a lifetime, indeed the entire era covered by history and tradition, affords us a glimpse of but a single time element. Lying between these two there is a great range of phenomena for which the element of time is within our reach. It is by the study of what takes place in such time elements, and the extension of the results thus obtained by analytical processes, that much of our knowledge of physics has been gained. It is to the extension of our powers in the observation of the phenomena of the time interval that we must look in great part for further progress. It has seemed worth while, therefore, to bring together for purposes of comparison some of the methods which have proved fruitful in this respect, and to consider along what line they may be further developed. It is an investigation which will lead us into all departments of science; for phenomena into which the element of time does not enter are unknown.

Since all study of phenomena involves the time element, the consideration of all dynamical problems must begin with the phenomena of the *time-infinitesimal*. There are two cases of chief importance:—(1) The study of the time elements of periodic phenomena; (2) the study of beginnings of changes which result from a sudden variation in the condition of equilibrium.

The methods which have been found most useful in the investigation of the phenomena under consideration may be classified as follows:—(1) Visual methods: (a) vision by instantaneous exposure, (b) vision by periodically interrupted exposure, (c) vision by the aid of the revolving mirror. (2) Photographic methods: (a) instantaneous exposure of a stationary film, (b) photography by the aid of the revolving mirror, (c) continuous exposure of a moving plate, (d) successive short time exposures of a moving plate. (3) Indirect graphical and electrical methods.

Much of the most important work which has been done in the domain of sound falls within the scope of our present inquiry, and it is in that field that many of the methods just indicated have been developed. The revolving mirror, for example, is a favourite tool of the acoustician; its usefulness is too well known to need mention here, but I wish to remind you that this instrument, chiefly used for the separation of images representing phenomena covering intervals of thousandths of seconds, has been found capable of rendering much briefer events subject to inspection and analysis.

The inventor of the revolving mirror (Wheatstone) found it possible to study time intervals down to within a millionth of a second ("Philosophical Transactions," 1834). He obtained a rate of revolution never since greatly exceeded, I think, of eight hundred revolutions a second. It is evident that he stood at the very threshold of the discovery of the oscillatory discharge, and that it was merely an accident of the relation of resistance and capacity in the circuits which he employed, which prevented him from observing that important form of the electric spark. That he was fully aware of the wide range of investigations to which the revolving mirror is adapted is also clear. He says in the memoir which Faraday presented for him before the Royal Society in 1834: "But this instrument is not confined to observing merely the intermittedness of electric light; whenever a rapid succession of alterations occurs in an object which does not change its place, they may be separately examined by this means. Vibrating bodies afford many instances for investigation; one among these is perhaps worthy to be mentioned. A flame of hydrogen gas burning in the open air presents a continuous circle in the mirror, but while producing a sound within a glass tube regular intermissions of intensity are observed, which present a chain-like appearance, and indicate alternate contractions and dilations of the flame corresponding with the sonorous vibrations of the column of air" (*loc. cit.* p. 586).

In a later paragraph of the same paper he noted the applicability of the spark in the study of the phenomena of the time-infinitesimal, suggesting a method the importance of which is even now but imperfectly appreciated. "The instantaneousness of the light of electricity of high tension affords the means of observing rapidly-changing phenomena during a single instant of their continued action."

In the hands of Foucault ("Recueil des travaux scientifiques," Paris, 1878), Michelson ("Proc. A.A.A.S.," 1879) also "Papers of Amer. Ephemeris," vols. i. and ii. 1882), and of Newcomb ("Astro. Pap. rs of Amer. Ephemeris," vol. ii.) the revolving mirror has given us our best determinations of the velocity of light; in those of Feddersen ("Beitrag zur Kenntniss des electrischen Funkens, 1857.") Also *Pogg. Ann.* 103, 113, 116 (1859 to 1862), Rood (*Amer. Journal of Science*, vol. ii. 111, p. 160), Trowbridge (*Amer. Journal of Science*, vol. xlii. 111, p. 223), and Boys (*Philosophical Magazine*, vol. xxx. 111, p. 248) and others it has made it possible to resolve the oscillatory spark into its elements.

Feddersen's experiments are especially noteworthy because he succeeded (in 1862) (*Pogg. Ann.* 116, p. 132) in photographing the discharge of the Leyden jar, securing an excellent record of the images seen in the revolving mirror. We are apt at the present day to look back to the introduction of the dry plate as the step necessary to the application of photography to the study of fleeting phenomena, but certainly the results obtained by this early investigator, who used the ordinary wet-plate process of his time, are not inferior in definition or in detail to any which have been published in recent years. Feddersen's researches are indeed worthy of all admiration. He used a concave mirror,

<sup>1</sup> An address delivered by Prof. E. L. Nichols before Section B (Physics) of the American Association for the Advancement of Science. Madison meeting, August, 1893.

<sup>2</sup> "Eine einfach auszudehnte Mannigfaltigkeit." (Riemann: Ueber die Hypothesen welche der Geometrie zu grunde liegen. Werke p. 257.)

giving excellent images when driven at a speed of one hundred revolutions a second. The velocity was under the regulation to within two per cent., and the millionth of a second represented not merely an appreciable distance upon the negative, it was an *easily measurable* quantity.

More than thirty years ago this German physicist stood, as Wheatstone had done nearly half a century before him, in the very gateway of the domain in which such activity has shown itself of late—the domain of electrical resonance. He was not only the discoverer along experimental lines, of the oscillatory discharge and the demonstrator of the existence of effects which had already been embodied in the analytical work of Helmholtz, Thomson, and Kirchhoff; he anticipated also many of the discoveries of later investigators, and worked out quantitatively the dependence of the rate of oscillation upon capacity, induction, and resistance. Two of Feddersen's photographs have been brought to general notice by reproduction in the fourth volume of Wiedemann's "Electricität." There is another set which I consider even more significant, showing the increase in the number of oscillations with diminishing resistance. It is copied *in fac simile* from the original plate in Fig. 1.

Another forerunner in the development of the methods which it is my privilege to consider, was Prof. E. W. Blake, of Brown University. His results, too, have become classical; but I refer to them because they are related in ways not always



FIG. 1.

recognised in later work. We are all familiar with his interesting photographs obtained by speaking into the mouthpiece of a Bell telephone (Blake, *Am. Journal of Science*, vol. xvi. (3) p. 57), to the diaphragm of which was attached a rocking mirror. Records obtained in a variety of other well-known ways, of some of which I shall have occasion to speak, indicate that these photographs do not give a complete trace of the vibrations which go to make up the articulate utterances by means of which they were excited, but the method is of interest in three particulars:—

(1) It is one of the earliest attempts to substitute photography for vision in the study of the transient phenomena of the sound wave.

(2) It substitutes a moving sensitive plate for the revolving mirror.<sup>1</sup>

(3) It is a distinct forerunner of the method applied some years later with somewhat better success by Froehlich to the analysis of alternate current phenomena.

Throughout the history of the study of the phenomena of the time-infinitesimal we find the tendency to be to supplant visual methods by methods of photographic record. One of the most noteworthy achievements in experimental acoustics, for example, is the application of the manometric flame to the

<sup>1</sup> Stein, in a paper cited by Prof. Blake, *Pogg. Ann.* 159 (1876), describes a similar device, but it is difficult to ascertain from his paper to what extent he succeeded with his experiments.

study of sound waves. The drawings made by Koenig (*Annalen der Physik*, vol. cxxii. p. 666; also in his "Experiences d'Acoustique," pp. 47-84) in illustration and verification of the phenomena of the organ-pipe and of the analysis of complex sounds, have been admired by all of us; and the repetition of his experiments has delighted an entire generation of demonstrators in physics. In how many minds the question of the feasibility of photographing the manometric flame has arisen I do not know, but quite recently it has been shown by Doumer (*Comptes Rendus*, 103 and 105), and independently by Ernest Merritt (*Proc. A.A.A.S.* 41, p. 82; also *Physical Review*, vol. i.) in a paper read before this section, that by surrounding the sensitive flame with a mantle of free oxygen (after the method of what was once known as the "Budde" light), sufficient actinic intensity may be obtained to ensure an excellent photographic record on a rapidly moving plate. The results of such photographs applied to the analysis of vowel sounds give evidence of the extraordinary fidelity of the sketches published by Koenig. They also afford a basis for the study of timbre of the sounds to which they correspond, which is open to one objection only, viz. to the uncertainty as to the influence of the inertia of the diaphragm upon the character of the image. Of this source of error I shall have more to say in connection with some other researches.

Other interesting examples of the study of the time-element might be drawn from this field; indeed, the science of sound is of necessity largely made up of such work. The beautiful photographs of vibrating strings by Menzel and Raps (*Annalen der Physik*, N.F. 44, 1891, p. 623), which are so fitting an appendix to the earlier labours of Helmholtz (*Die Tonempfindungen*, p. 137), may serve to illustrate the usefulness of the method of photography on a moving plate.

In the study of periodic phenomena two distinct methods of investigation have been established. The first of these consists in the isolation of a desired element of the cycle at each repetition for as long a time as may be necessary to obtain a satisfactory record of the existing conditions. By the selection successively of many neighbouring elements, we get in this way at last the data from which to construct a complete diagram of the cycle.

This principle has been most fruitful in enabling us to analyse periodic processes not easily approachable by more direct means. The most notable application has been that which is commonly spoken of as the "method of instantaneous contact," well known to the student of alternating current phenomena.

It is to Joubert<sup>1</sup> (1880) that we owe this ingenious adaptation of the device of properly timed repetitions of instantaneous observations of periodic phenomena (a principle which underlies the phenakistoscope and similar well-known instruments). He made use of it in the study of the changes of potential in the circuit of the alternating current dynamo, and between the terminals of the Jablochhoff candle.

In the same year the method was discovered independently, and applied to the study of the Brush arc-lighting dynamo by B. F. Thomas.<sup>2</sup> Joubert pointed out the method of using the quadrant electrometer in alternating circuits, also that the galvanometer might be utilised. ("On peut mesurer cette intensité par l'électromètre mais on peut aussi employer le galvanomètre puisque les contacts successifs correspondent toujours à une même phase du courant.") He discovered the retardation of phase in the current curves of the alternating dynamo, and the peculiar distortion of the curves in the circuit containing an arc lamp, a matter more fully investigated at a later day by Tobey and Walbridge.<sup>3</sup> Thomas during this first period in the history of the Joubert method used a ballistic galvanometer and condenser.

The periodic phenomena of the alternating current circuit have been among the most important to which the study of the time-element has been applied, and it is to the method of instantaneous contacts that we owe much of the progress of the last thirteen years. It is interesting to note the extension of

<sup>1</sup> "Sur les Courants alternatifs et la force électromotrice de l'arc électrique." *Comptes Rendus*, vol. xci. p. 161, July 19, 1880.

<sup>2</sup> "Observations on the electromotive forces of the Brush dynamo-electric machine." (title only.) *Proceedings A.A.A.S.* vol. xxix. p. 277 (1880). Prof. Thomas gave the results obtained, and described the method eleven years later in a communication to the Institute of Electrical Engineers, entitled "Notes on Wiping Contact Methods for Current and Potential Measurements." *Translations of the American Institute of Electrical Engineers*, vol. ix. p. 263.

<sup>3</sup> "Investigations of the Stanley Alternate Current Arc Dynamo." *Trans. Am. Inst. Electrical Engineers*, vol. vii. p. 567.

this method in the study of a variety of allied phenomena. After the publication of Jouber's papers the method seems to have come into common use in the physical laboratories, particularly in the exploration of the fields of continuous current dynamos and motors.

In 1888 it was applied by Duncan, Hutchinson, and Wilkes ("Experiments on Induction Coils," *Electrical World*, vol. ii. p. 160, 1888) to the study of induction coils and transformers. To them we owe the first set of complete diagrams relating to the performance of this class of alternating current apparatus. In the same year Meylan ("Sur les Appels Magnetiques," *La Lumière Electrique*, xxvii. p. 220, 1888) used an interesting modification of the method in the investigation of the vibratory magnetic call-bell of Abdank.

In the same year appeared the first definite data with reference to the Westinghouse alternating dynamo, at the hands of Messrs. Searing and Hoffmann ("Variation of the Electromotive Force in the Armature of a Westinghouse Dynamo," *Journal of the Franklin Institute*, vol. cxxiii. p. 93), of Stevens Institute. Then followed in the order named the researches of Ryan and Merritt ("Transformers," *Trans. Am. Inst. Electrical Engineers*, vol. vii. p. 1, 1889), Humphrey and Powell ("Efficiency of the Transformer," *Ibid.*, vol. vii. p. 311), Tobey and Walbridge (*Ibid.*, vol. vii. p. 367), of Marks (*Ibid.*, vol. vii. p. 324), of Herschel (*Ibid.*, vol. vii. p. 328), of Fortenbaugh and Sawyer (*Ibid.*, vol. vii. p. 334).

In all these investigations the methods under consideration have been used with varying accessories in the problem of the transformer.

In 1890 it was applied under much more difficult conditions to the analysis of the "ball and point effect" by Archbold and Teeple (see Nichols, "On Alternating Electric Arc between a Ball and Point," *American Journal of Science*, vol. xli. p. 1).

In 1891, Thompson ("Study of an Open Coil Arc Dynamo," *Trans. Am. Inst. Electrical Engineers*, vol. viii. p. 375) determined the intricate changes of induction in open coil arc lighting machines by means of the same method, and Ryan ("Relation of the Air Gap and the Shape of the Poles to the Performance of Dynamo-electric Machinery," *Ibid.*, p. 451) utilised it in his investigations of the influence of the air gap upon the performance of dynamos and motors. In 1892, Duncan ("Note on some Experiments with Alternating Currents," *Ibid.*, vol. ix. p. 179) described modifications of the method of instantaneous contacts by means of which the rapidity of reading is greatly enhanced.

During the present meeting, you will doubtless have the pleasure of listening to a description of the applications of the same device to the study of electrostatic hysteresis. (Reference is here made to the paper presented by Messrs. Bedell, Ballantyne, and Williamson: "Alternate Current Condensers and Dielectric Hysteresis," *Physical Review*, vol. i. p. 91. Subsequent note.)

Such has been, in brief, the history of a method by means of which in greater degree than of any other we have been able to extend and complete our knowledge of alternating current phenomena.

To the practical electrician and to the theorist alike, the domain has been one of the most attractive of those which have been developed in recent years. To the electrical engineers of the younger generation the very complexity of alternate current theory has proved a benefit. It has forced them to increased mathematical proficiency and to more rigorous thinking; it has, indeed, served as an excellent source of discipline. What the problems of submarine telegraphy did for the English electricians who served their apprenticeship during the early days of the cable-laying industry, compelling the development of those sturdy qualities which have been so highly serviceable in every branch of electrical progress since, the intricacy of alternate current practice is unquestionably doing for the younger school which is growing up to-day in this country. The difficulties which have to be met and overcome in this field of work will have an excellent influence upon the manner in which the problems of the future will be approached.

Another investigation, which owes its existence to a most ingenious application of this same principle of instantaneous contacts periodically repeated, is well known to all of you. I refer to Prof. E. H. Hall's<sup>1</sup> study of periodic heat-flow in the

cylinder walls of the steam-engine by means of thermo-elements embedded within the metal and connected momentarily during a selected time-element in the course of each stroke with a sensitive galvanometer. To my mind no more interesting example of the indirect method of studying the phenomena of the time element could be found than this suggestive memoir.

The method of instantaneous contacts has been a fruitful one, and productive of high results, but it does not yield a knowledge of any individual time-element, nor the picture of any single completed cycle. Numerous attempts to record single cycles have been made, the results of which are of considerable interest, because they deal with the more direct study of the time-infinitesimal.

The device which lay nearest to hand, and which by its performance seemed to promise success in this direction, was the magneto-telephone. The investigations of Mercadier (*Journal de Physique*, vol. ix. pp. 217 and 282) had already paved the way to some extent, when Froehlich described his experiments upon the optical representation of the movement of the diaphragm of the telephone, followed almost at once by Thomson.

Froehlich<sup>2</sup> reported his preliminary results to the Electro-technische Verein of Berlin, in 1887. Elihu Thomson ("An Indicator for Alternating Circuits," *La Lumière Electrique*, vol. xxvii. p. 339 (1888) brought out his indicator for alternating circuits, an instrument in which the movement of a diagram was amplified by levers, and then made visible by optical means (or photographed) in the same year. Froehlich's method in its complete form, including the photography of the images from the involving mirror,<sup>2</sup> was first described in the year 1889. Some of the curves published in the papers just cited, and particularly the experiments shown in the exhibition of the method at the Frankfort Electrical Exposition of 1891, are most striking, but considering the method by which they are produced, the question inevitably arises as to the part played by the inertia of the moving masses.

Froehlich himself points out the necessity of great care in the matter of the adjustments, and of distinguishing the natural oscillation of the plate, which are frequently superimposed upon those to be recorded. Some experience with Froehlich's method has convinced me that not only is extraordinary skill necessary in order to obtain, by means of a mirror attached to the diaphragm of a telephone, curves which should represent, even with a fair approximation, the law of whatever periodic changes we may desire to record, but that the attainment of the proper adjustment is a matter so entirely fortuitous, and its maintenance so uncertain, as to deprive the method of much of its usefulness. One may indeed hope to get, by means of successive adjustments, curves which correspond to a known type, but whether in passing to new and unknown types the apparatus retains its faithfulness, is always a question.

By way of illustration, I introduced three of an extended series of curves obtained by this method with a telephone in circuit with an alternating current dynamo. The character of the cycle had been determined by the method of instantaneous contacts. The true cycle was represented by a curve of sines, but with the apparatus under consideration complex curves of the kinds shown in figures 2 and 3 were the rule; curves even approximating to simple sinusoid were the rare exception.

The difficulties of the method lay not merely in the tediousness of adjustment, but rather in the tendency to revert to complex forms under changes of condition so slight as to be entirely beyond control. The remedy clearly consists in the elimination of mechanism and the reduction of inertia of the moving parts. Following the suggestion of an assistant, Mr. E. F. Northrup, I tried the following experiments:—

A mercury stream flowing from the contracted nozzle of a funnel (Fig. 4) was made to pass between two metal terminals which were attached to the poles of a large Holtz machine. A portion of the falling column of mercury within the electrostatic field was illuminated by means of an arc lamp, and so much of it as could be seen through a horizontal slit was photographed by transmitted light. The sensitive plate was given rapid vertical motion through the field of the camera. When the machine was out of action there resulted a vertical trace running the length of the developed plate. As soon as the machine was put

<sup>1</sup> "A Thermo-Electric Method of Studying Cylinder Condensation in Steam-Engine Cylinders." *Trans. Am. Inst. Electrical Engineers*, vol. iii. p. 236.

<sup>2</sup> "The Optical Representation of the Movements of a Telephone Diaphragm." *La Lumière Electrique*, vol. xxv. p. 180 (1887).

<sup>3</sup> Froehlich: "Ueber eine neue Methode zur Darstellung von Schwingungskurven." *Electrotechnische Zeitschrift*, bd. x. pp. 345, 369 (1889).

into operation, deflection of the mercury stream occurred. It was the object of the experiment to determine the performance of the stream under the sudden fluctuations of the field which occurred when the Holtz machine was under rapid discharge.

Fig. 5 is from a photograph taken when nearly one hundred sparks a second were passing between the poles.

Other photographs were obtained in a similar manner, the deflecting forces, however, being due to the action between the

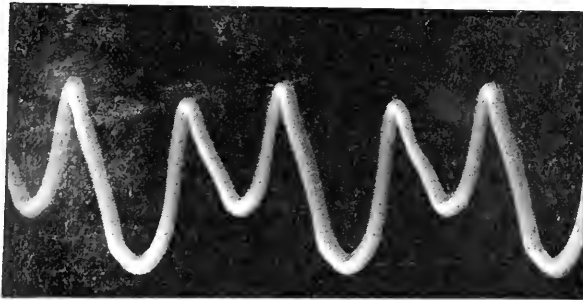

FIG. 2.

lines of a stationary magnetic field and those of an alternating current traversing the mercury column. The arrangement of the apparatus is shown in Fig. 6. The mercury stream was introduced into the circuit of the alternating current dynamo, already made use of in the experiments upon Froehlich's method. It flowed through a strong magnetic field with horizontal lines. The transverse oscillations of the mercury under these con-

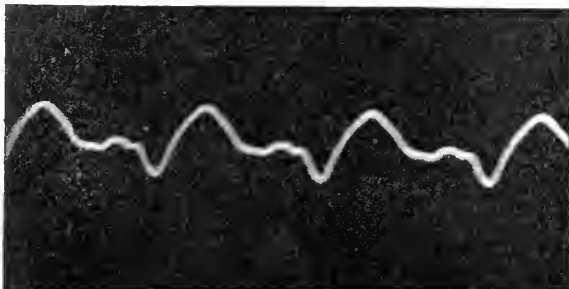

FIG. 3.

ditions were very apparent. When photographed by means of a camera with optical axis parallel to the lines of force, the stream strongly illuminated from behind and viewed through a narrow horizontal slit, as in the previous experiment, a sinusoidal trace was obtained. All the complexities of the telephonic trace disappeared in these records, and curves corresponding to those of the method of instantaneous contact were always pro-

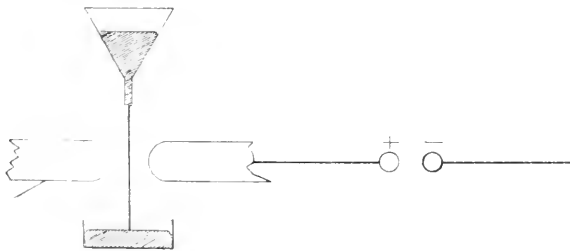

FIG. 4.

duced. The experiment was made by Mr. Henry Floy, to whose efforts the photographs by Froehlich's method are also due. This method has not been further developed. I introduce it here to show that increased accuracy of record may be looked for as the result of reducing in any practicable manner the mass of the indicating device.

Another attempt to record single periods in dynamo-electric work should be mentioned here. It is described by Moler<sup>1</sup> in a recent paper. By means of a D'Arsonval galvanometer with a period of vibration of a few thousandths of a second, curves of varying potential are traced, which show excellent agreement with measurements by the method of instantaneous

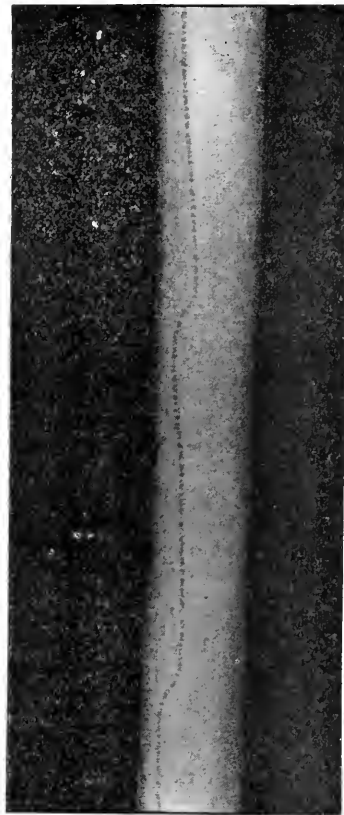

FIG. 5.

contacts. The instrument is not free from the errors due to inertia. It is reliable only in recording changes of period considerably greater than its own, but its use is a step in a direction along which progress may be looked for.

Thus far I have dealt with methods of studying periodic changes, the time-elements of which are easily within reach

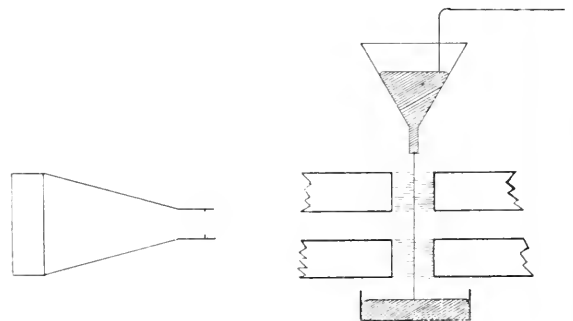

FIG. 6.

through experimental devices. I might have devoted myself with as good reason to the consideration of recent advances in the study of electrical oscillations of a higher order of frequency. This is a department of physics in which much has been done of

<sup>1</sup> "A Dynamo-Indicator, or Instantaneous Curve-writing Voltmeter." (Trans. Am. Elec. Engineers, vol. ix. p. 223.)



late, but so much has been written at second-hand, as well as in the way of original treatment, that further reiteration is uncalled for. The work of Hertz and of his host of followers is familiar to us all. In the study of electrical oscillations even of very high frequency, photography has been used with success, and details of the phenomena of time-elements truly infinitesimal have been secured. By the labours of Wiener<sup>1</sup> waves of a still higher order than those which have occupied the attention of the electrician have been photographed, and a new field of the greatest promise has been thrown open to the optician. The isolation of a single light vibration may indeed still be as far from us as is the inspection of the molecule by means of the microscope, but in the meantime we have in the photography of a system of standing light-waves, an achievement well worth celebrating.

In the investigation of the phenomena of the time-infinitesimal, so far as periodic changes are concerned, we see that the experimenters of the present time are gaining much of detailed knowledge. There is another field equally important, in my opinion, which is as yet for the most part unexplored. The study of the beginnings of changes brought about by abrupt shifting of the conditions of equilibrium is one from which very much may be expected. Already suggestive beginnings have been made, but the researches have not been pushed to the limit of the experimentally possible. Oftentimes interesting observations of what might be termed "startling phenomena" have been recorded, but quantitative results are lacking. Take for example the brilliant work of Becquerel (*Comptes rendus*, 96, pp. 121, 1215, 1853) with the phosphorescope. What a mass of fascinating and suggestive material that savant has gathered into the first volume of his book on light! (*La Lumière*, i, pp. 206-422.) What a world of interesting material these preliminary observations present to him who shall undertake to determine quantitatively, wave-length by wave-length, the changes which the radiations from the numerous luminescent materials undergo, beginning with the instant of exposure and following the vanishing light until it is gone.

Of a few isolated cases which have been forced upon us by their practical importance we have some complete knowledge already. With the phenomena in cables when current is suddenly introduced or circuit is broken, we are reasonably familiar. The case of the charge and discharge of condensers has been treated analytically under assumptions the precise truth of which is still to be verified. The detailed study by experiments carried to the utmost refinement, of the very cases which seem to have been most completely covered by theory, is especially important; since in this way only can the assumptions upon which our analysis is based be rigorously determined, and the necessity of modifications be ascertained. For some of this work methods already in use in the study of periodic phenomena will suffice. The curve-writing voltmeter, for example, may be made to give records running to within a thousandth of a second of the instant when a process such as electrolysis, electrolytic polarisation, voltaic action, or the charge and discharge of a condenser begins. Instruments such as the von Helmholtz pendulum, for the isolation of definite small time intervals, may also be applied to a great variety of progressive phenomena, enabling us to approach by successive steps almost to the very beginnings of the changes to be analysed. Concerning known methods let me point out, in conclusion, that photography with the moving plate is a means, the limitations of which have not yet been discovered. It is equally applicable to periodic and to progressive phenomena, often with results of unexpected beauty and significance.<sup>2</sup>

The remarkable experiments of Mach (*Wiener Sitzungsberichte*, 95, p. 764, also 97, p. 41) and of Boys ("On Electric Spark Photographs," &c., *NATURE*, vol. xlvii, p. 415) indicate that the dry plate is still abundantly exposed within intervals so short that the swiftest of modern projectiles give images as of a body at rest.

The laws of electrical resonance have already been so far determined that we can construct condensers, the duration of the discharge of which is a matter of computation, and the precise

<sup>1</sup> "Stehende Lichtwellen und Schwingungsrichtung des polarisirten Lichtes." *Annalen der Physik N.F.*, vol. xl, p. 293.

<sup>2</sup> In photographing the alternate current arc a single exposure of a continuous current lamp upon the moving plate, by way of check, brought out the seat and precise nature of the hissing of the arc in a manner scarcely to be reached in any other way. For the method used, see "A Photographic Study of the Electric Arc," *Trans. Am. Inst. Electrical Engineers*, vol. viii, p. 214, 1891.

moment of the discharge of which after a given event is quite within control. This single device, consisting of the exposure of the photographic plate by means of a properly timed spark, brings under observation a set of time intervals of a new and higher order of brevity. Much is destined to be learned by means of it concerning the nature of matter, and much more, I think, from other, possibly still more powerful, methods which will doubtless be developed when the importance of the study of the time-infinitesimal is more generally recognised.

#### UNIVERSITY AND EDUCATIONAL INTELLIGENCE.

OXFORD.—At a meeting of the Ashmolean Society, held at the Museum on Monday, 27th inst., Prof. Odling was elected President for the ensuing year, and Messrs. F. J. Smith and G. C. Bourne were re-elected Secretaries. Mr. E. J. Stone read a paper on the rainfall at Oxford during the last seventy-eight years, and Prof. E. Ray Lankester read a paper on fresh-water jelly-fishes.

At the meeting of the Junior Scientific Club, on Friday, 24th inst., papers were read by Dr. Ritchie, on anthrax spores and bacilli; by Mr. G. B. Cronshaw, on explosions in coal-mines; and by Mr. A. L. Still, on plants and their standing army.

CAMBRIDGE.—The Special Board for Physics and Chemistry report that the Cavendish Laboratory, founded and equipped by the munificence of the late Duke of Devonshire, has become incapable of accommodating the large number of students desiring tuition in Physics. In the present term no less than 135 students are at work in a disused galvanised iron dissecting-room, which, on its vacation by the Professor of Anatomy, has been placed at the disposal of the Professor of Physics as a temporary laboratory. Its site will, however, soon be required for the Sedgwick Memorial Museum of Geology, and the Board feel that the time has come for the permanent extension of the Cavendish Laboratory. An adjoining site is available between it and the Engineering Laboratory; but the problem of funds for building and equipment is less easy to solve, unless a benefactor as generous as the late Chancellor should make his appearance. The high position deservedly held by the Cavendish Laboratory, entrusted as it is with much work of national importance, makes it reasonable to hope that Prof. J. J. Thomson will be able to obtain the means for the desired extension.

Mr. W. Gardiner and Mr. A. C. Seward have been re-appointed University Lecturers in Botany, and Dr. Hill, Master of Downing College, Lecturer in Advanced Human Anatomy, for five years. Dr. Hill has also been appointed Chairman of the Examiners for the Natural Sciences Tripos.

The Local Examinations Syndicate report that the work done in the scientific branches of the Higher Local Examinations during the past year was on the whole satisfactory. Imperfect experimental work in chemistry, and lack of practical instruction in zoology, are among the weaker points revealed.

The Examinations in Sanitary Science seem to be increasingly appreciated by medical men. During the present year eighty-seven candidates have presented themselves, and of these fifty-eight received diplomas in Public Health.

THE *Times* correspondent at Paris says that an International University alliance is in course of formation there. Its object is to facilitate the passing of students from one University to another, to promote travelling scholarships and the exchange of information, to multiply periodical celebrations, and to "draw the attention of the Universities to the question of introducing greater justice into international relations."

#### SCIENTIFIC SERIALS.

*Wiedmann's Annalen der Physik und Chemie*, No 11.—On the speed of electrolytic ions, by F. Kohlrausch. This is a compilation of tables of absolute velocities, of mobilities, and of coefficients of electrolytic friction according to the latest and most reliable data.—Contributions to the knowledge of the absorption and branching of electric oscillations in wires, by Ignaz Klemencic.—The resistance which causes evolution of heat during the passage of very rapid oscillations depends upon the magnetic permeability of the wire, but in a different

manner from that in the case of a constant current. The amounts of heat developed in wires of iron, German silver, brass, and copper 6 cm. long and of 0.018 cm. radius, were in the proportion of 10.5 : 1.75 : 1 : 1, the last being probably a little too large. The branching of the oscillations is only affected by the self-induction of the wires, not by their resistance.—The emission of hot gases, by F. Paschen (see p. 82).—A simple method of testing the conductivity of dielectric liquids, by K. R. Koch. The apparatus used for this method is a modified Dewar capillary electrometer, in which a drop of the substance to be examined takes the place of the drop of sulphuric acid usually employed for determining differences of potential. Any electrolytic polarisation is indicated by a movement of the drop of liquid, which should not be more than 0.5 mm. long. The conductivity of various dielectrics has thus been studied, and has in many cases been found to be due to impurities. Benzol, carefully cleaned and freed from moisture, ceased to show any polarisation.—On the magnetic susceptibility of oxygen, by R. Hennig (see Notes).

### SOCIETIES AND ACADEMIES.

#### LONDON.

Chemical Society, November 2.—Dr. Armstrong, President, in the chair.—The following papers were read:—The action of bromine on azobenzene: a correction, by H. E. Armstrong. The colourless bromination product of azobenzene is tetrabromobenzidine, and not a tetrabromazobenzene, as stated by Werigo.—The origin of colour. X. Coloured hydrocarbons, by H. E. Armstrong.—The formation of the hydrocarbon "truxene" from phenylpropionic acid and from hydrindone, by F. S. Kipping. On heating hydrindone with dehydrating agents, a hydrocarbon of the constitution

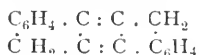

is formed; it is identical with truxene, to which the molecular formula  $\text{C}_{27}\text{H}_{18}$  has been erroneously assigned by Liebermann and Bergami. Further, Gabriel and Michael's "tribenzylenebenzene" in all probability has the molecular formula  $\text{C}_{18}\text{H}_{12}\text{O}_2$  instead of  $\text{C}_{27}\text{H}_{12}\text{O}_3$ , as has previously been supposed.—The action of aluminium chloride on heptylic chloride, by F. S. Kipping. A crystalline ketone of the composition  $\text{C}_{14}\text{H}_{20}\text{O}$ , is formed by the interaction of heptylic chloride and aluminium chloride.—The inertness of quicklime. II. The interaction of chlorine and lime, by V. H. Veley. Dry chlorine has no appreciable action on quicklime below  $300^\circ$ ; above this temperature, a partial replacement of oxygen by chlorine occurs.—Note on hyponitrites, by D. H. Jackson. No hyponitrite is formed during the reduction of sodium nitrate with aluminium or barium amalgam. Diver's process for preparing hyponitrites gives the best results when a weak sodium amalgam is employed, and when the action proceeds at a low temperature.—The interaction of hydrogen chloride and potassium chlorate, by W. H. Pendlebury and Mrs. McKillop. The authors have determined the amounts of oxidising gases removed, during successive periods of time, from an aqueous solution of hydrogen chloride and potassium chlorate by a current of air. The action of sunlight on the solution materially increases the quantity of oxidising gas carried away by the air current.—The formation of indoxazen derivatives, by W. A. Bone. The author has studied the action of alkalis on orthochloronitrobenzaloxime with the object of preparing nitroindoxazen; in place of this substance, however, the isomeric 1 : 2 : 5 nitrosalicylonitril was isolated, molecular change having occurred during the interaction. A number of new nitro-derivatives were obtained.—The interaction of benzylamine and phenacyl bromide. Synthesis of piazine derivatives, by A. T. Mason and G. Winder. Phenacyl bromide and benzylamine readily interact with formation of the hydrobromides of monophenacylbenzylamine,  $\text{Ph} \cdot \text{CO} \cdot \text{CH}_2 \cdot \text{NH} \cdot \text{CH}_2\text{Ph}$  and diphenacylbenzylamine ( $\text{Ph} \cdot \text{CO} \cdot \text{CH}_2\text{N} \cdot \text{CH}_2 \cdot \text{Ph}$ ); on liberating the bases, molecular changes occur. In the case of the monophenacyl-derivative, 1, 4-dibenzyl-2 : 5-diphenylpiazine dihydride is obtained; when this substance is heated to the boiling-point, it yields toluene and 2 : 5-diphenylpiazine.

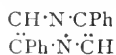

A number of other piazine derivatives are also described.—The interaction of quinones and metanitriline and nitroparatolu-

idine: a preliminary note, by J. Leicester. The author describes a number of condensation products of quinones with *m*-nitraniline and nitro-*p*-toluidine.—Preparation of  $\alpha$ - $\beta$ -diphenylindoles from benzoin and primary benzenoid amines, by F. R. Japp and T. S. Murray. A mixture of benzoin, aniline, and zinc chloride yields  $\alpha$ - $\beta$ -diphenylindole, in accordance with the following equation

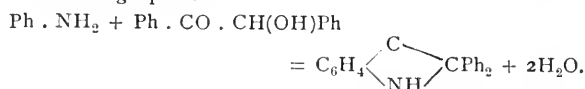

New substituted indoles may be prepared by the employment of other aromatic amines in place of aniline.

Mathematical Society, November 9.—A. B. Kempe, F.R.S., President, in the chair.—The resolution for the incorporation of the Society, and the list of names as new Council for the session 1893-4 (see NATURE, vol. xlviii. p. 619), were carried unanimously.—The President gave a brief account of the life and work of the late W. S. B. Woolhouse, and then accompanied the presentation of the De Morgan medal, which had been awarded by the Council in June last to Prof. F. Klein, of Göttingen, with an outline sketch of the grounds of the award. Prof. Greenhill, F.R.S., and Dr. Forsyth, F.R.S., who had been deputed by Prof. Klein, in his unavoidable absence, to receive the medal, suitably acknowledged the gift. The following communications were made:—A mechanical solution of the problem of tethering a horse to the circumference of a circular field, so as to graze over an *n*<sup>th</sup> part of it, by Prof. L. J. Rogers. (The solution turned on a property of the cycloid).—The stability of certain vortex motions, by A. E. H. Love. The paper contains investigations of the steady motion and small oscillations of Kirchhoff's elliptic vortex, which rotates uniformly in the midst of an infinite mass of liquid, and of Hill's elliptic vortex, which rotates uniformly in the midst of a mass of liquid filling a conical rigid envelope, the envelope rotating with the same angular velocity. It is proved that Kirchhoff's vortex is stable for all modes of oscillation in which the boundary ceases to be elliptic, provided the major axis is less than three times the minor axis. It is also proved that if the boundary is any ellipse, the vortex rotates steadily with angular velocity suitable to its eccentricity, and that it is impossible for it to change form and remain elliptic. The characteristics of the various modes of oscillation are made out, viz. it is shown that for each mode there is a definite number of wave-lengths of a simple harmonic disturbance in the circumference, provided the amplitude of the disturbance is measured by the ratio of the normal displacement of a point in the boundary to the central perpendicular on the tangent at the point. The general period equations are obtained, and it is shown in particular that Hill's vortex is always stable for elliptic displacements of the boundary of the vortex, the frequency for such displacements tending to zero when the vortex degenerates into a Kirchhoff's vortex by indefinite expansion of the external boundary of the liquid, thus verifying the results found in the more special case. It is also verified that the vortex sheet, which is another degenerate Hill's vortex, is always unstable for the more complex types of disturbance. Messrs. Hill, Basset, Greenhill, and Bryan spoke upon the paper.—Cyclo-tomic quartics, by Prof. G. B. Mathews.—On the application of elliptic functions to the curve of intersection of two quadrics, by J. E. Campbell.—Note on the theory of groups of finite order, by Prof. W. Burnside, F.R.S. The only quite general theorem at present known concerning the structure of a group (of finite order) is the following, due to Herr Sylow: "If *p*<sup>*n*</sup> is the highest power of a prime *p* that divides the order of a group, the group contains a single conjugate set of sub-groups of order *p*<sup>*n*</sup>, and the number of such sub-groups is congruent to unity, modulus *p*." In the theory of groups of finite order, and especially in considering the possible structure of a group of given order, this theorem is fundamental. From its enunciation it is clearly independent of the form in which the group may be represented. The only published proofs of it, to the best of the author's knowledge, are the original proof by Herr Sylow (*Math. Ann.* vol. v.), and a proof given by Herr Netto in his "Substitutionentheorie." These both depend essentially on the representation of the group as a group of substitutions, and also on the conception of transitivity in connection with this form of representation. A proof of the theorem is given in the first of these notes, which is as fundamental in conception as

the theorem itself, being entirely independent of the form in which the group may be supposed to be expressed. The latter part of the paper dealt with the orders of simple groups in certain cases.—Prof. Hudson showed and explained some mechanical constructions (by his son, R. W. Hudson) for the parabola, hyperbola, cubical parabola, and semi-cubical parabola.

Royal Meteorological Society, November 15.—Dr. C. Theodore Williams, President, in the chair.—Mr. F. J. Brodie read a paper on the great drought of 1893, and its attendant meteorological phenomena. The author confined his investigation to the weather of the four months, March to June, during which period the absence of rain was phenomenal; barometric pressure was greatly in excess of the average, temperature was high, with a large diurnal range, and the duration of sunshine was in many places the longest on record. The mean temperature over England was about 4° above the average. Along the south and south-west coasts the sunshine was between 50 and 60 per cent. of the possible duration. The rainfall was less than half the average amount over the southern and eastern parts of England, the extreme south of Ireland, and a portion of Durham and Northumberland; while over the southern counties of England generally the fall amounted to less than one-third of the average. The smallest number of days with rain was at the North Foreland, where there were only eighteen.—Mr. W. Marriott gave an account of the thunder and hail-storms which occurred over England and the south of Scotland on July 8, 1893. Thunderstorms were very numerous on that day, and in many instances were accompanied by terrific hail-storms and squalls of wind. It was during one of these squalls that a pleasure-boat was capsized off Skegness, twenty-nine persons being drowned. About noon a thunderstorm, accompanied by heavy hail and a violent squall of wind, passed over Dumfries and along the valley of the Nith; many of the hail-stones measured from 1 inch to 1½ inches in length. At the same hour a similar storm occurred at Peterborough. From about two until ten p.m. there was a succession of thunderstorms over the north-east of England and south-east of Scotland, and at many places it was reported that the thunderstorms were continuous for nine hours. Two storms were remarkable for the immense hail-stones which fell during their prevalence over Harrogate and Richmond in Yorkshire. The hailstones were 4 and 5 inches in circumference, and some as much as 3 inches in diameter. Great damage was done by these storms, all windows and glass facing the direction from which the storm came being broken. It is computed that within a radius of five miles of Harrogate not less than 100,000 panes of glass were broken, the extent of the damage being estimated at about £3000. The thunderstorms in the northern part of the country travelled generally in a north-north-westerly direction at the rate of about twenty miles an hour. They appear to have taken the path of least resistance, and consequently passed over low ground and along river valleys and the sea coast. Several storms seem to have followed each other along the same track.

Royal Microscopical Society, November 15.—A. D. Michael, President, in the chair.—Mr. C. L. Curties exhibited and described a microscope by Leitz, of Wetzlar, made on the English model, with tripod foot and inclining body, horse-shoe stage, and sub-stage fittings.—Mr. A. W. Bennett gave a *résumé* of Mr. W. West's paper on new British fresh-water Algæ.—Prof. F. Jeffrey Bell read a paper by Mr. G. Sandeman, on a parasitic disease in flounders. The author stated that there are often found on the coast flounders having small round swellings under the skin, which have been described under the name of multiple tumours. The tumours have the appearance of eggs, deposited irregularly beneath the skin. They cause a slight projection of the skin, which sinks slightly between the individual ova, but, when very many are present in one mass, the large tumour which is formed projects considerably from the body, and is sometimes even a pedunculated or finger-shaped formation. On microscopic examination, the contents of the tumours present all the characteristics of eggs. The cause and habits of the parasite are so obscure that the author finds it impossible to pronounce a definite opinion on the subject.—The President announced that the Society's conversazione would take place in the early spring.—Mr. C. Beck raised a discussion as to the possibility of obtaining a standard tube-length. Dr. W. H. Dallinger congratulated Mr. Beck upon the able way in which he had brought the matter before them. He thought that a committee should be appointed to discuss the whole question.

PARIS.

Academy of Sciences, November 20.—On a new model of a reverberatory electric furnace with movable electrodes, by M. Henri Moissan.—On equations of mixed functions and a problem of geodesics, by M. G. Koenigs.—On differential equations of the second order with fixed critical points, by M. Paul Painlevé.—On the means of increasing the security of high-tension alternate-current distribution, by M. G. Claude. The elimination or diminution of the capacity of the mains with regard to the earth would make it necessary to touch the two poles of the circuit to receive a shock capable of endangering life. This may be obviated most conveniently by neutralising the capacity by self-inductions placed along the circuit.—Action of some metals upon acid solutions of their chlorides, by MM. A. Ditte and R. Metzner. If a plate of tin is plunged into a concentrated hydrochloric acid solution of stannous chloride upon which a layer of water has been poured, crystals of tin are rapidly formed near the surface of separation. The arrangement amounts to a galvanic cell, in which the same electrode is plunged into different liquids. A solution of stannic chloride shows the same phenomenon, which takes place as soon as the water has, by the diffusion of the salt, become sufficiently conducting to permit the passage of the current. The tin above the surface of separation merely acts as a negative electrode, and may be replaced by a platinum wire. That the phenomenon is one of electrolysis may be shown by replacing a small portion of the bar of tin by an insulator placed at the surface of separation. No crystals are deposited until the two separated portions are brought into communication by the diffusing salt. When the stannic chloride solution is placed in a porous pot in a vessel of acidulated water, and the two liquids are joined by platinum plates, no electrolysis takes place; but cadmium treated by the first method shows precisely similar phenomena. Zinc, which is easily dissolved by the most dilute hydrochloric acid, shows nothing similar. Nickel, which is quickly covered with a protecting layer of hydrogen, and also bismuth and antimony, which are insoluble in hydrochloric acid, show no phenomena analogous to those exhibited by tin.—Means of preserving wood from being worm-eaten, by M. Emile Mer. The attacks on the sap-wood by the insects are due to the presence of starch in this tissue. It may therefore be inferred that the fact of the hard wood being free from the invasion is due to its not being amyloferous. The alburnum may be protected by ridding it on starch. This may be done by annulation of the bark at the upper end of the trunk, and by suppressing all buds developed there. Spring is the best season for this operation. The starch has disappeared by autumn, and the trees may be felled during October. Carpenters and joiners will, in this way, be enabled to utilise the whole or part of the sap-wood.—On the development and maturation of the cider apple, by M. L. Lindet. In the maturation of the cooked apple the same transformations take place as during the ripening of the fruit on the tree. The quantity of starch accumulated in the green fruit diminishes, and this diminution coincides with the increase of the saccharose and inverted sugar; these sugars disappear in their turn through respiration.—On the minute structure of the terminal plates of the motor nerves of striated muscle, by M. Charles Rouget.—On the nematodes of the pharyngeal glands of ants, by M. Charles Janet. The two glands taken from an ant from an artificial nest (*Formica rufa*) appeared in the form of bunches of yellow tubes resembling actinia with numerous tentacles. Each tube was occupied by one or more *Rhabditis*, which could be dislodged in great numbers by slight pressure on the cover-glass. The whole nest turned out to be thus infested, although the ants appeared to be in good health. The nematodes appear to be a larval form of the sexed individuals living in a free state in the detritus of the nest.—On the polymorphism of *Peridinium acuminatum* Ehr., by M. Georges Pouchet.—On the north-east extremity of the main body of Mont Blanc, by MM. L. Duparc and L. Mrazec.—On the origin of the Alps of Chablais and Stockhorn, in Savoy and Switzerland, by M. Hans Schardt.—Discovery of another pre-historic magdalenoan deposit in the Vézère valley, by MM. Paul Girod and Elie Massénat.—On the variation of composition of lake-water with the depth, by M. A. Delebecque.

NEW SOUTH WALES.

Linnean Society, September 27.—The President, Prof. David, in the chair.—The following papers were read:—Descriptions of new species of *Bostrychidae*, by Arthur M. Lea.

—Botanical notes from the Technological Museum, Sydney. No. 1, by J. H. Maiden and R. T. Baker. The paper embodied a number of fresh localities for New South Wales plants, and also New South Wales localities for plants hitherto known only from Queensland, viz. *Decaspermum paniculatum*, *Psychotria nematopoda*, *Tetrarrhena ferruginea*, (*Litsaea hexanthus*). There are also recorded observations on *Ampera spartioides* with pedicellate female flowers, several at each node, *Hovea acutifolia*, with glabrous pods; notes on *Melodorum Leichhardtii*, *Sideroxylon myrsinoides*, *Blechnum serrulatum*, *B. cartilagineum*, *Eucalyptus saligna*, and others.—Preliminary note on a species of *Balanoglossus* from the coast of New South Wales, by J. P. Hill. *Balanoglossus*, hitherto unrecorded from Australia, has recently been met with, both at Broken Bay and at Jervis Bay, in loose sand under large stones between tide-marks. A detailed account of this interesting form, in all probability a new species, was promised.—Note on the presence of vestigial Mullerian ducts in a full-grown male lizard (*Amphibolus muricatus*), by J. P. Hill.

DIARY OF SOCIETIES.

LONDON.

THURSDAY, NOVEMBER 30.

SANITARY INSTITUTE, at 8.—Textile Manufactures, Silk, Cotton, Woollen, and Linen Industries: Dr. J. T. Arledge.

FRIDAY, DECEMBER 1.

GEOLOGISTS' ASSOCIATION, at 9.—Notes on a Discovery of Fossils at Little Stairs Point, Sandown Bay, Isle of Wight: Thos. Leighton.—Notes on the Sharks' Teeth from British Cretaceous Formations: A. Smith Woodward.—The Breaking-up of the Ice on the St. Mary River, Nova Scotia, and its Geological Lessons: Geoffrey F. Monckton. INSTITUTION OF CIVIL ENGINEERS, at 7.30.—Forms of Tensile Test-Pieces: Leonard H. Appleby.

SUNDAY, DECEMBER 3.

SUNDAY LECTURE SOCIETY, at 4.—The Body's Servants—A Talk about Cells and their Work: Dr. Andrew Wilson.

MONDAY, DECEMBER 4.

VICTORIA INSTITUTE, at 8.—Habit in Man: Dr. Schofield. SOCIETY OF CHEMICAL INDUSTRY, at 8.—Application of Air in Motion to Chemical Industry: H. G. Watel. (Adjourned Discussion).—Note on the Copper Mines of Singhbhoom: H. Harris.—The Product of the Action of Mercuric Chloride upon Metallic Silver: Chayman Jones. ARISTOTELIAN SOCIETY, at 8.—On the Import of Categorical Propositions: Miss E. E. Constance Jones. ROYAL INSTITUTION, at 5.—General Monthly Meeting.

TUESDAY, DECEMBER 5.

ZOOLOGICAL SOCIETY, at 8.30.—On the Geographical Distribution of Earth worms: F. E. Beddard, F.R.S.—On a Collection of Coleoptera sent by Mr. H. H. Johnston, C.B., from British Central Africa: C. J. Gahan.—On a Collection of Petrels from the Kermadec Islands: Captain F. W. Hutton, F.R.S. INSTITUTION OF CIVIL ENGINEERS, at 8.—Impounding Reservoirs in India, and the Design of Masonry Dams: Mr. Clarke, Mr. Sadaseewjee, Colonel Jacob, and Prof. Kreuter. (Discussion.)

WEDNESDAY, DECEMBER 6.

GEOLOGICAL SOCIETY, at 8.—The Purbeck Beds of the Vale of Wardour: Rev. W. R. Andrews and A. J.ukes-Browne.—On the Variety of Ammonites (*Strophoceras*) subarumatis, Young, from the Upper Lias of Whithy: H. W. Monckton.—On a Pierreite and other Associated Rocks at Barmton, Edinturgh: H. W. Monckton. ENTOMOLOGICAL SOCIETY, at 7.—On a Collection of Lepidoptera from Egypt: George T. Bethune-Baker.—The Rhynchophorous Coleoptera of Japan: Part III. Scolytidæ: Walter F. H. Blandford.

THURSDAY, DECEMBER 7.

ROYAL SOCIETY, at 4.30.—The Organogeny of *Asterma gibbosa*: E. W. MacBride.—Reptiles from the Elgin Sandstone: Description of Two New Genera: E. T. Newton, F.R.S.—A Dynamical Theory of the Electric and Luminiferous Medium: J. Larmor, F.R.S.—Note on the Action of Copper Sulphate and Sulphuric Acid on Metallic Copper: Prof. Schuster, F.R.S.—On Copper Electrolysis *in vacuo*: W. Gannon.—On a Chart of the Symmetrical Curves of the Three-Bar Motion: W. Brennand. LINNEAN SOCIETY, at 8.—Catalogue of the Described Neura ptera Odonata (Dragonflies) of Ceylon, with Description of New Species: W. F. Kirby.—On the Cause of the Fall of the Corolla in *Verbascum*: Signor U. Martelli. CHEMICAL SOCIETY, at 8.—An Apparatus for the Estimation of the Gases dissolved in Water: Dr. Truman.—Metallic Oxides and the Periodic Law: R. M. Deeley.

FRIDAY, DECEMBER 8.

ROYAL ASTRONOMICAL SOCIETY, at 8. SANITARY INSTITUTE, at 8.—Metallic Poisons, Lead and Arsenic: Prof. T. Oliver.

SATURDAY, DECEMBER 9.

PHYSICAL SOCIETY, at 5.—A Potentiometer for Alternating Currents: J. Swinburne.—The Specific Resistance of Sea-Water: W. H. Preece, F.R.S.—The Calculation of the Coefficient of Self-Induction of a Circular Current of a Given Cross-Section and aperture; and The Magnetic Field of a Cylindrical Coil: Prof. G. M. Minchin. ROYAL BOTANICAL SOCIETY, at 3.45.

BOOKS, PAMPHLETS, and SERIALS RECEIVED.

BOOKS.—By Moorland and Sea: F. A. Knight (E. Stock).—Laboratory Teaching: C. L. Bloxam, 6th edition (Churchill).—An Elementary Treatise on Theoretical Mechanics, Part 2—Introduction to Dynamics, Statics: A. Ziwet (Macmillan).—Micro-Organisms and Fermentation: A. Jorgenson, translated by A. K. Miller and E. A. Lennholm, new edition (Lyon).—Concrete, its Nature and Uses: J. L. Sutcliffe (Lockwood).—The Sacred City of the Ethiopians: J. T. Bent (Longmans).—University College of N. Wales, Calendar 1893-4 (Manchester, Cornish).—The Pamirs, 2 vols: Earl of Dunmore (Murray).—Against Dogma and Free Will, and for Weismannism: H. C. Hiller, 2nd edition (Williams and Norgate).—The Wilder Quarter-Century Book (Ithaca, N. Y. Comstock Publishing Company).—The Story of Our Planet: Prof. Boney (Cassell).—The Elements of Applied Mathematics: C. M. Jessop (Bell).—A Year amongst the Persians: E. G. Browne (Black).—The Principles of Waterworks Engineering: J. H. T. Turner and A. W. Brightmore (Spon).—Science and Education: T. H. Huxley (Macmillan).—Letters of Asa Gray, 2 Vols: edited by J. L. Gray (Macmillan).—Oxford Bible for Teachers, with Helps (two styles) (Frowde).

PAMPHLETS.—A Check List of the Slugs: Prof. T. D. A. Cockerell (Dulan).—Temperature and Vertebræ? Dr. D. S. Jordan (Ithaca, New York).—Sulle Osservazioni Mareografiche in Italia, &c.: G. Grablovitz (Genova).

SERIALS.—Notes from the Leyden Museum, Vol. xiv, No. 3, and Vol. xv, No. 4 (Williams and Norgate).—Sitzungsberichte und Abhandlungen der Naturwissenschaftlichen Gesellschaft Isis in Dresden, 1893, Jan. bis Juni (Williams and Norgate).—Botanische Jahrbücher für Systematik, Pflanzengeschichte und Pflanzengeographie, Siebzehnter Band v. Heft (Williams and Norgate).—Zeitschrift der Gesellschaft für Erdkunde zu Berlin, Band xxviii, 1893, No. 3 (Berlin).—Mittheilungen von Forschungsreisenden und Gelehrten aus der Deutschen Schutzgebieten, vi. Band, 4 Heft (Berlin).—Bollettino della Societa Geografica Italiana, Serie 3, Vol. 6, Fasc. 8-9 (Roma).

CONTENTS.

PAGE

|                                                               |     |
|---------------------------------------------------------------|-----|
| The Mummy . . . . .                                           | 97  |
| Eskimo Life. By J. P. . . . .                                 | 98  |
| Our Book Shelf:—                                              |     |
| Easton: "La Voie Lactée dans l'Hémisphère Boréal              | 99  |
| Johnston: "An Elementary Treatise on Analytical               |     |
| Geometry" . . . . .                                           | 99  |
| Stehlin: "Zur Kenntniss der Postembryonalen                   |     |
| Schädelmetamorphosen bei Wiederkauern" . . . . .              | 99  |
| Letters to the Editor:—                                       |     |
| Suggested Nomenclature of Radiant Energy.—Prof.               |     |
| Simon Newcomb, F.R.S. . . . .                                 | 100 |
| The Postal Transmission of Natural History Speci-             |     |
| mens.—Isaac J. Wistar; Edw. J. Nolan . . . . .                | 100 |
| Flame.—Prof. Henry E. Armstrong, F.R.S. . . . .               | 100 |
| "Geology in Nubibus."—Dr. Alfred R. Wallace,                  |     |
| F.R.S. . . . .                                                | 101 |
| Correlation of Magnetic and Solar Phenomena.—                 |     |
| H. A. Lawrance . . . . .                                      | 101 |
| New Variable Star in Andromeda.—Rev. Thomas                   |     |
| D. Anderson . . . . .                                         | 101 |
| Protective Habit in a Spider.—Prof. C. Lloyd                  |     |
| Morgan . . . . .                                              | 102 |
| The Loss of H.M.S. "Victoria." By Dr. Francis                 |     |
| Elgar . . . . .                                               | 102 |
| Jupiter and his Red Spot. By W. F. Denning . . . . .          | 104 |
| The Preparation and Properties of Free Hydroxy-               |     |
| lamine. By A. E. Tutton . . . . .                             | 105 |
| Notes . . . . .                                               | 106 |
| Our Astronomical Column:—                                     |     |
| Otto Struve's Double-Star Measures . . . . .                  | 111 |
| Method of Pivot Testing . . . . .                             | 111 |
| A Bright Meteor . . . . .                                     | 111 |
| Astronomical Photography . . . . .                            | 111 |
| Vierteljahrsschrift der Astronomischen Gesellschaft . . . . . | 111 |
| Geographical Notes . . . . .                                  | 111 |
| Antarctic Exploration . . . . .                               | 112 |
| Phenomena of the Time-Infinitesimal. (Illustrated.)           |     |
| By Prof. E. L. Nichols . . . . .                              | 113 |
| University and Educational Intelligence . . . . .             | 117 |
| Scientific Serials . . . . .                                  | 117 |
| Societies and Academies . . . . .                             | 118 |
| Diary of Societies . . . . .                                  | 120 |
| Books, Pamphlets, and Serials Received . . . . .              | 120 |

THURSDAY, DECEMBER 7, 1893.

## ELEMENTARY PRACTICAL SCIENCE.

*Elementary Course of Practical Science.* Part I. By Hugh Gordon, M.A. (London: Macmillan and Co. 1893.)

IN the teaching of science, as of any other subject, the importance of method is most apparent in dealing with the elements. Of late years, since laboratory instruction has been generally introduced into our colleges, the teaching of science to advanced students may be said to be based on correct methods. But so much cannot yet be said for the teaching of the elements of science to young children. If, however, science is to obtain a recognised place in the curriculum of our primary and secondary schools, it is most important that the means adopted for the teaching of science should be educational in character. Very rarely is science so taught to young children and junior pupils in schools as to bring into active exercise the very faculties of the mind which it is supposed to develop. The teaching of science follows too closely the older education, by appealing to the memory, and storing the mind with facts and information of more or less value; and the methods employed involve a mental discipline too similar in kind to that of ordinary mathematics.

Mr. Hugh Gordon, in Part I. of his "Elementary Course of Practical Science," recently published, has broken comparatively new ground. His little book gives a very satisfactory answer to the question: How can the elements of science be so taught as to become a means of *educating* young children? In arranging a course of practical instruction in the rudiments of science, *two* principles have to be observed: first, the instruction must be introductory to science as a whole, and not to any branch of it; and secondly, the aims of the teaching must be strictly educational. In other words, the information imparted must be such as is equally applicable to physics, chemistry, and biology, and the methods must be those by which the student, at every stage of his progress, is enabled to learn by himself. Indeed, the real end of science teaching should be kept in view from the commencement of the study, and the pupil should be exercised, through his science lessons, in accurate observation, and in interpreting the results of experiments.

The book under review is the practical outcome of the experience gained by the author in superintending a course of science teaching in fifteen schools under the London School Board, and is based on a scheme drawn up by Prof. Armstrong for a committee of the British Association. Mr. Gordon has had the advantage of working for some time in the laboratory of Prof. Armstrong, to whom he very readily acknowledges his indebtedness for many valuable suggestions. The book is an endeavour to show how the most elementary science teaching may be made scientific. The author truly says: "Science had much better be left alone altogether than be taught unscientifically"; and it is only too evident that science is often so taught as to be of little or no value in the real work of education. Matthew Arnold said somewhere, "that all learning is scientific which is

systematically laid out and followed up to its original sources, and that a genuine humanism is scientific." This is true, and it is because the humanistic studies have been for so many years systematically pursued, that both here and in Germany they have proved more serviceable in teaching scientific method than science itself.

The book before us is a collection of suggestions rather than a text-book or a science primer. It consists of 76 small pages, and contains a few exercises to be worked by the pupils, and for the guidance of teachers. Although an instalment only of a complete course, it indicates very fully the methods to be followed and the objects to be aimed at in teaching science to beginners. The key to the system is supplied in the question, addressed to the pupil, and constantly repeated in the text: "What is it you see? What would you expect to find if the conditions were varied?" and by the reiterated instruction: "Try it for yourself; try experiments to see if this is the case; record your results." In the method of instruction suggested by the author, the pupil is never passive; he is always doing something, and is consequently interested in his work. He is observing, recording, anticipating results, or experimenting. In dealing with the simplest matters, the methods of inductive inquiry are illustrated and practised. The teacher who follows Mr. Gordon does not instruct; he guides and assists his pupils in questioning and interpreting Nature. And although the immediate aim of this instruction is education rather than information—the development and strengthening, by suitable exercises, of certain faculties of the mind, rather than the acquisition of knowledge, the pupil nevertheless gains, in the short course here sketched out, much actual knowledge which cannot fail to prove useful in any kind of practical work. Through the experiments he is made to perform, he learns the metric system, the use of the balance, the mechanical principle of the lever, methods of determining specific gravities, the action of thermometers and of the barometer, facts concerning the expansion of solids and liquids, and applications to every-day phenomena of the principles of solubility and evaporation. Moreover, the child who has gone through this course will have learnt to be observant and accurate, and will have acquired a certain skill in the use of some of the simpler instruments of science. This is no small result of such a short course of lessons.

Between Mr. Gordon's method of teaching the elements of science, and the lectures or lessons illustrated by experiments which answer for science teaching in so many of our schools, there is the widest difference; and by showing in detail how this method may be applied, Mr. Gordon has made a very useful contribution to pedagogic literature. There is very little fault to be found in the subjects selected by the author to illustrate his method; they are nearly all such as are familiar to the pupil in his every-day life. The early and constant use of squared paper is rightly insisted on in most of the exercises. It may be thought that there is too great an advance in the difficulty of some of the exercises towards the end of the book. But possibly this may have been intentional on the part of the author, to encourage the teacher to fill in the breaks in the reasoning, and to prevent the book from being used by teacher or pupils as an ordinary text-book.

The book is clearly printed and illustrated, but would be improved if the numbers of the diagrams were given and referred to in the text. Where more than one diagram is found on the same page, it is not always evident to which diagram the lettering refers. The phrase "addition of interest" might also, with advantage, be changed to some other, less suggestive of commercial arithmetic. These, however, are small defects which can easily be corrected in a subsequent edition. The merit of the book is not in *what* it teaches, but in *how* it teaches; and not the least valuable part of it will be found in the introductory remarks addressed to the teachers.

PHILIP MAGNUS.

### THE PYRENEES.

*Les Pyrénées.* Par Eugène Trutat. (Bibliothèque Scientifique Contemporaine.) (Paris: J. B. Baillière et Fils, 1894.)

IN this volume Dr. E. Trutat gives a sketch, as the full title states, of the mountains, glaciers, mineral springs, atmospheric phenomena, flora, fauna, and man in the Pyrenees, illustrated by woodcuts and diagrams, together with two small maps. The mountains differ from the Alps in their greater simplicity of structure, for they form "the most perfect type of a regular chain." Like the Alps, this consists of an axis of crystalline rocks, granites, gneisses, and schists, flanked on both sides by deposits comparatively unaltered. But there is one important difference: in the Alps, systems anterior to the Carboniferous are only recognised in the extreme east; in the larger part of the chain, rocks of that or of a later age rest on crystalline schists, which must be very ancient. But in the Pyrenees schists truly crystalline are succeeded by great stratified masses which have been much less markedly changed. The most ancient of these are assigned to the Cambrian, though as yet fossils either have not been found, or are too ill-preserved to afford any certain evidences of age. It seems, however, clear that they are older than the Silurian system, for the different members of this can be identified in several places by their characteristic fossils. The Devonian system is well developed, and followed by limestones (marine), conglomerates, and slaty rocks of the Carboniferous period. The occurrence of Permian rocks is considered by Dr. Trutat to be doubtful. Trias of the Lorraine type, is found, followed by representatives of the various systems in orderly succession up to the Neocomian. Between this and the Cretaceous is a break, then the sequence continues till after the Nummulitic age. Then, as in the Alps, began the great series of movement, of what the present chain is the outcome. Masses of eruptive rock are connected with these disturbances. The enormous beds of conglomerate, called the *Poudingues de Palassou*, which sometimes surpass 1000 metres in thickness, recall the Alpine *nagelfluhe*. Strata partly marine, partly freshwater, represent the Miocene and the Pliocene; the Quaternary deposits presenting a general resemblance to those of the Alps.

The glaciers of the Pyrenees at the present day are comparatively small, the length of the largest not exceed-

ing about 4300 metres, while that of the Great Aletsch is 32 kilometres, but their former extent, as in the Alps, was much greater. They filled the valleys, and even debouched on the lowland; that of the valley of Ariège must have been about 70 kilometres long. The glacial deposits have been assigned to two epochs, and Dr. Trutat claims for the earlier a considerable antiquity. In the Ariège he states that they underlie Pliocene marls, and near the plateau of Lannemezan pass under the Miocene deposits of Sansan. The sections which he gives are very rough, and further proofs of these statements, which involve obvious difficulties, are likely to be demanded. The Pyrenees owe their existence, as has been said, to post-Nummulitic disturbances, but they also afford evidence of great movements, both anterior to the Carboniferous and after the Neocomian, the latter apparently being less marked. Movements occurred after the great post-Eocene elevation, but of much less importance than they were in the Alps. The other topics, mentioned on the title-page, receive due notice, and the volume will be found useful, as it gives, in a concise and convenient form, much information about one of the most important mountain chains in Europe.

T. G. B.

### OUR BOOK SHELF.

*Les Courants Polyphases.* Par J. Rodet et Busquet. (Paris: Gauthier-Villars et Fils, 1893.)

To those desirous of obtaining a general knowledge of the principles used in the calculation of the efficiency and of the dimensions of polyphase motors, &c., this book will be of considerable use. In the first part, the calculation of the dimensions of, and losses in, the conductors conveying the currents are worked out at some considerable length, numerical examples being given. In the other sections the generation of polyphase currents, motors with rotating fields, and transformers are dealt with; in each case the general principles of the machines now in use being described, though no account is given of the details of their construction. There is also a short account of some of the plants for the transmission of energy by polyphase currents which have been installed, with a table summarising the tests and measurements made during the Frankfurt Exhibition.

*Solutions of the Examples in the Elements of Statics and Dynamics.* By S. L. Loney, M.A. (Cambridge: Camb. Univ. Press, 1893.)

MR. LONEY is indebted to a friend for these solutions, and also for the revision of the whole of the proof-sheets. We have glanced through many of the examples, and they seem to be fully and clearly worked out on the whole, very little being taken for granted. Students who cannot depend on the presence of a teacher, will find that with a judicious use of this key much may be self-taught.

### LETTERS TO THE EDITOR.

[The Editor does not hold himself responsible for opinions expressed by his correspondents. Neither can he undertake to return, or to correspond with the writers of, rejected manuscripts intended for this or any other part of NATURE. No notice is taken of anonymous communications.]

Sir Henry Howorth and "Geology in Nubibus."

SIR HENRY HOWORTH, in his reply to Dr. Wallace and Mr. LaTouche, concerning the excavating power of ice, remarks that he is "speaking to every man of science, geologist or

otherwise." Indeed, from the tone of his letter he would appear to be defending modern science against the attacks of certain unscientific persons who hold extreme views on glacial questions. As one who has taken a great interest in this subject for a number of years, I trust that I may be allowed to add a few words to the discussion.

We are required by Sir Henry Howorth to establish two postulates. "(1) That ice can convey thrust for more than a moderate distance. (2) That glaciers, such as we can examine and report upon, are anywhere at this moment doing the excavating work . . ." Dr. Wallace postulates.

In reply to the first, we have the undoubted fact that in hundreds and thousands of instances striated rock surfaces do occur hundreds of miles from existing glaciers. On this point he remarks: "If glaciers travelled further in former days, it was doubtless because glaciers were larger in former days, because they descended longer slopes, and had larger gathering grounds; that is to say, because the country where they grew was more elevated." So the glacial period resulted from elevation, and all glaciated regions conveniently rose together to produce it, and as conveniently sank down again. I was quite unaware that this was the accepted view. We have no proof whatever that the striated slopes down which the old glaciers moved were steeper in glacial times than they are now. Indeed, the proof is all the other way, and we may consider it as proved that at long distances from their sources, and on comparatively level plains, glaciers have moved, and have polished, ground, scratched and *grooved* the rocks over which they passed. The only point about which there may be legitimate discussion concerns the possible extent of the abrasion.

In his mechanics Sir Henry Howorth is, I am afraid, rather unsound. There are really two factors upon which the possibility of motion in a viscous body depends. One is, of course, the slope of the surface over which it passes, and the other is the slope of the upper surface of the viscous body. Fracture and regelation have little to do with the question, for fracture only occurs near the surface, and fracture must not be confounded with *shear*. Sir Henry Howorth makes one statement which seems to account for the conclusions he has come to. It is "a viscous body, unless the viscosity approaches that of a liquid, cannot move by mere hydrostatic pressure." In fact he assumes, without adducing a particle of evidence in support of the assumption, that there is an inferior limit to the stress required to deform *glacier* ice. I always regarded viscosity as something which retarded motion, but did not in any way interfere with the ultimate result. I have personally made mechanical tests of ice, and also of many thousands of samples of steel, iron, copper, brass, tin, &c. All these substances yield elastically and permanently under stress, some of them under very small stresses, but ice is the only one of them that yields continuously from the moment the stress is applied until it is again removed.

It is not, properly speaking, pressure from behind that forces the ice forward. Ice being viscous, every individual particle moves in the direction of least resistance at a rate depending upon the stress and the viscosity. Sir Henry Howorth may term this "Geology in Nubibus," and call it unmechanical; but I would point out to him that I regard the question from the point of view of a *mechanical engineer*, which I am afraid he does not.

During the past summer I had the pleasure of seeing some of the Norway glaciers, and also of crossing the Folgefond snow field. It was interesting to note that although the streams coming from the hills and uplands free from ice were quite clear, those escaping from the glaciers were charged with sediment. In this connection I would call attention to a calculation made by Prof. G. F. Wright, giving the rate of erosion of its bed by the Muir Glacier. From the volume and turbidity of the water he makes the figure one-third of an inch per annum over the whole of the 1200 square miles of area occupied by the glacier. In fact, erosion goes on much more rapidly when the rocks are covered by moving ice than when they are not. Although we may feel absolutely certain, both by fact and reason, that the erosion beneath glaciers when they are moving with relative rapidity is very great, and be as sure as we reasonably can be of most things that such erosion must result in the formation of lake basins, I am afraid that we shall be unable to satisfy Sir Henry Howorth on the point. We cannot remove a glacier, and if there should prove to be a rock basin

below measure of its depth, then replace the ice, and measure again, say, in a thousand years. This is the kind of proof the second postulate seems to demand.

R. M. DEELEY.

#### The "Zoological Record."

IN reference to the letter of Messrs. Pocock and Bather, on the subject of the *Zoological Record*, in NATURE of November 16, I desire to state that the council of this Society (to which the *Zoological Record* at present belongs) quite agree with the above-named gentlemen in their wish to render the *Zoological Record* more complete by combining palæozoology with it. With this view the council some time since addressed the Geological Society, and suggested what in their opinion would be an equitable arrangement for carrying out the plan. This arrangement, however, as will be seen by the copy of the correspondence enclosed herewith, was rejected by the council of the Geological Society. It remains, therefore, for Mr. Bather and such members of the Geological Society as may share his sentiments, to do their best to induce the council of the Geological Society to alter their views upon this question.

I have good authority for stating that the editor of the *Zoological Record* is not really of a different opinion to Messrs. Bather and Pocock on this subject, as would seem to be inferred in their letter. I believe that he only suggested that the palæontologists should start a record for themselves because of the refusal of the Geological Society to co-operate with us in our work.

P. L. SCLATER.

Zoological Society of London,  
3, Hanover Square, London, W.

(COPY.)

To the Secretary, the Geological Society, Burlington House, W.

DEAR SIR,—I am instructed by the council of this Society to apply to the council of the Geological Society under the following circumstances:

When the *Zoological Record* (which is now carried on by this Society) was established twenty-eight years ago, it was not considered that palæozoology came within its scope, and the recorders were instructed to notice only such palæontological works as appeared to be "of interest to the student of living forms" in their records. This part of the subject has, however, received a continually increasing amount of attention from the recorders, and the council of this Society, being desirous that palæozoology should in future be treated of in the *Record* as completely as recent zoology, asks the assistance of the Geological Society in carrying out this object.

The Zoological Society bears at present a loss of about £350 per annum, arising from the publication of the *Zoological Record*, and, as the inclusion of palæozoology in an exhaustive manner would materially increase the work of the recorders, and necessitate an addition to their remuneration (which is even at present too small), the council of this Society asks the council of the Geological Society to make a grant of £100 annually towards the expenditure thus incurred.

It is thought by some members of the Council that the Zoological Society, bearing, as it does at present, the whole loss arising from the publication of the *Record*, should not increase its expenditure thereon, and the sum mentioned above, £100, would, it is estimated, be sufficient to relieve this society from the additional expense that the inclusion of palæozoology, in its record of zoological literature, would involve. In return for this assistance, the council of this Society will make every effort to treat the subject of palæozoology exhaustively, and will add to each *Record* a reference to palæozoological memoirs stratigraphically arranged, besides dealing with those memoirs in detailed analysis in the systematic records.

In order that the interests of palæozoology may be more carefully attended to, the council of this Society will undertake to place a nominee of the Geological Society upon the committee of their body appointed every year to supervise the publication of the *Zoological Record*.

Should these proposals meet with acceptance from the Geological Society, the council will further undertake to place one hundred copies of the *Zoological Record* at the disposal of the Geological Society, and, if it be wished, will alter the title of the *Record* to *The Record of Zoological and Palæozoological Literature*, from *The Record of Zoological Literature*.

Trusting that these proposals will meet with the approval of your council,

I am, dear sir,  
Yours faithfully and obediently,  
(Signed) P. L. SCLATER,  
Secretary.

January 21, 1893

(COPY.)

*From the Geological Society, Burlington House, W.*

DEAR SIR.—Your communication, dated January 21, 1893, was this day submitted to the council of the Geological Society, and I was asked by the council to inform you that they regretted that they were unable, in the present state of the Society's income, to recommend to the Fellows of the Geological Society an increase of expenditure such as would be necessitated by acceding to your request that a grant of one hundred pounds should be made to aid the publication of the *Zoological Record*.

Whilst regretting their inability to comply with your request, the council thank you for the conditional offer which accompanied it.

I am, dear sir,  
Yours faithfully and obediently,  
(Signed) JOHN E. MARR,  
Secretary.

February 22, 1893.

### The Proposed Continuous Polar Exploration.

YOUR excellent summary of the proposed continuous Polar exploration (November 2, p. 18) conveys a wrong impression in its closing sentence. The system may in the future assume large proportions; but the *beginning*, to be made next year, will be *very small*. It will consist merely in the establishment of the principal station at the south-east angle of Ellesmere Land, and 80 days' exploration along the west coast of that land. At most, an advanced depôt, erected some 100 miles farther west, may be so fitted out as to serve at once as a secondary station. It is not easy to see why this work should be postponed till Peary and Nansen have returned. Their fields are far from ours, and their results can shed no light on the area west of Ellesmere Land. As well might you say that the exploration of the Mediterranean should not be begun until that of the Baltic was completed.

As you say, the possibility of continuous Polar exploration is not demonstrated. There can be no doubt, however, of the value of a permanent station at the entrance of Jones Sound, nor of the practicability of its maintenance, so long as the whalers continue to visit that region. How far exploration may be carried with that station as a base, it is impossible to foretell, but at any rate the existence of a secure base will be an advantage possessed by no previous expedition in that direction, and, in the words of the "Encyclopædia Britannica," will "make disaster on a large scale, humanly speaking, impossible."

U.S. Geological Survey. ROBERT STEIN.

### On the Classification of the Tracheate Arthropoda.— A Correction.

IN No. 423 of the *Zoologische Anzeiger* (1893) I ventured to propose a new classification of the Tracheata, including under this heading those Arthropoda that are usually known as myriopods and insects. The principal changes suggested were the abolition of the name Myriopoda as indicating an unnatural assemblage of beings and the union of the *Chilopoda*, *Symphyla*, and *Hexapoda* in a division (Opisthogoneata), which was based upon the situation of the generative apertures at the hinder end of the body. But in referring the *Symphyla* to this category by adopting the assertions of Menge and Latzel respecting the position of the orifices in question, it appears that I fell into error; for Dr. Erich Haease has kindly written to me from Bangkok, with the information that by means of a series of transverse sections he was able, although with considerable difficulty, to confirm Grassi's statement to the effect that the generative apertures in *Scolopendrella* are situated upon the fourth body-segment. This genus is therefore progoneate, like the *Diplopoda* and *Paupoda*; but whether it should be ranged with these two classes, or occupy an independent position between the Progoneata and Opisthogoneata, is a question for future discussion.

R. I. POCKOCK.

### THE LOSS OF H.M.S. "VICTORIA."<sup>1</sup>

II.

WE dealt last week with the circumstances relating to the loss of H.M.S. *Victoria*, and the causes of her sinking with such startling rapidity after she was rammed. The facts, so far as they are known, are fully and, in our opinion, fairly summarised by Mr. W. H. White, in No. 3 of the Admiralty Minutes, just issued; and Mr. White demonstrates clearly, from the results of calculations made in the Construction Department of the Admiralty, that the movements and behaviour of the ship after the accident, and the observed effects upon her line of flotation and her stability, are precisely what would be caused by the entry of water into the compartments at the fore end of the ship, which are known, or believed, to have been filled before she foundered. These calculations serve, therefore, the useful purpose of showing that the water known to have entered those forward compartments that were proved, by evidence given before the Court Martial, to be filled, was quite sufficient to account for the subsequent capsizing and sinking of the ship; and for the capsizing and sinking to happen exactly in the manner that was observed. This is so, as already stated, whether Mr. White be absolutely right or not with regard to the precise state of each separate compartment after the damage; as the evidence is sufficiently conclusive, upon the whole, respecting the various compartments, to reduce the probability of error to a very small amount, such as would not materially affect the practical results of the demonstration.

The Admiralty calculations thus remove all reasonable doubt as to whether the compartments known to have been filled were sufficient in themselves to account for the final disaster; and they make it unnecessary, in order to explain what happened, to speculate as to the probability of the collision having been more far-reaching in its effects upon the structure, or internal arrangements, of the ship than the evidence indicates. The evidence, as it stands, is shown to completely account for the facts; and to furnish a solid basis for investigation, or argument, as to the lessons that may now be learned from the loss of the *Victoria*.

The Lords Commissioners of the Admiralty, in the first of the three Minutes lately issued, dated October 28 last, on the finding of the Court Martial, stated that the question of closing the water-tight doors of the *Victoria*, and the construction and stability of the ship, would be dealt with separately. Their lordships accordingly issued the second Minute, dated October 30. This Minute states that, in consequence of the Court Martial finding "that it does not feel itself called upon, nor does it feel itself competent, to express an opinion as to the causes of the capsizing of the *Victoria*," their lordships instructed the Director of Naval Construction to make a thorough examination and analysis of those parts of the evidence which throw light on these points. The report prepared by Mr. White, in accordance with these instructions—No. 3 of the present Minutes—was dealt with in our article of last week; but we then left over for subsequent consideration the references made in the Minutes to the lessons taught by the various circumstances of the case.

These points being dealt with authoritatively in the second Admiralty Minute, dated October 30, we shall deal principally with that Minute in the following remarks. It commences by adopting the figures and the conclusions stated in Mr. White's report with regard to the nature of the blow received by the *Victoria*, the after movements and behaviour of the ship, the extent to which water found access into her, and the effect of such water upon her flotation and stability. We have nothing

<sup>1</sup> Continued from p. 104.



further to say upon the subjects dealt with in this portion of the Minute, which appears to accord with the evidence, and also with the known effects that would be produced by filling the compartments that were opened up directly to the sea, or into which water could pass freely through open doors, hatches, &c.

The Admiralty Minute next expresses the opinions of the Board upon the following points; and we will take these in the order named in the concluding paragraph of our former article: (1) The effect of longitudinal bulkheads upon the capsizing of the ship; (2) what would probably have happened if the doors and ports in the upper-deck battery had been closed; (3) what would probably have happened if all doors, hatches, &c. had been closed before the collision took place; (4) the efficiency of the water-tight doors to the bulkheads, and the means of closing them quickly; (5) the value of an armour belt at the ends for resisting damage; (6) the sufficiency of the stability possessed by the ship; and (7) the steps that should be taken "to prevent the recurrence, under similar circumstances, of the conditions which, after the collision, resulted in the loss of the ship."

1. *The effect of longitudinal bulkheads upon the capsizing of the ship.*—Mr. White points out that there was no continuous central longitudinal bulkhead in the *Victoria*. In the stokeholds and engine-room there were two such bulkheads on opposite sides of, and each several feet from, the centre line; but these were far abaft the damaged portion of the hull, and do not appear to have been reached by water that entered the ship up to the moment of sinking. There were a few longitudinal partitions in the fore part of the ship; but some of these were inoperative because of damage or open doors. The effect of filling the compartments formed by these longitudinal partitions has been calculated, and it is stated that this would only cause an inclination of about 5° in the intact condition of the ship. This result does not, however, bear directly upon the actual effect produced in such circumstances as are being considered, because the damage caused by collision not only admitted water into the ship, but it reduced, at the same time, her power to withstand the heeling effect of the excentric compartments that were thereby filled. The ship would only have heeled about 5° with these compartments filled, if the hull had been uninjured; but if the hull had been uninjured, the compartments would, of course, not have been filled. Mr. White goes on to say: "It appears on investigation that in the damaged condition and at the extreme position which the *Victoria* occupied before the lurch began, the flooding of the compartments enumerated, and the accumulation of water on the starboard side, account for the observed angle of heel, 18 to 20 degrees." This inclination—which is what was really due, in the circumstances, to water being held over to starboard by the longitudinal partition above referred to; as the accumulation of other water to starboard was merely the consequence of the heeling thus caused—must have allowed the sea to enter the ports and door of the upper deck battery sooner than it otherwise would have done, and thus have hastened the capsizing of the ship. The Admiralty Minute states that "the evidence clearly shows that the existence of longitudinal water-tight bulkheads in the *Victoria* was not the cause of her capsizing. There were only a few minor longitudinal partitions in the fore part of the ship. Many of these were inoperative because of damage or open doors."

This conclusion is doubtless correct so far as it relates to the continuous longitudinal central bulkhead to which the capsizing of the ship was prematurely, though confidently, attributed by certain hasty critics, because such a bulkhead did not exist in the forward part of the ship that was affected by the collision. It clearly does not apply, however, to the minor longitudinal partitions above

referred to, because these must have been contributory to the disaster according to the extent by which the water they held over towards one side caused the heel of the ship to increase as the bow became immersed, and the stability diminished. It is a question that could only be settled by further investigation, whether the reduction of stability and the heeling effect thus caused was greater or less in this particular case than would have occurred if the water had been free to pass from side to side of the ship within the fore-and-aft limits of the compartments it entered.

2. *What would probably have happened if the doors and ports in the upper-deck battery had been closed.*—Mr. White says: "It is not possible to state absolutely that the *Victoria*, with turret and battery closed, could have been kept afloat permanently under the actual circumstances of the collision"; and he points out that there are many compartments into which water might have found its way eventually, through doors and hatches that were probably open. He considers, however, that "her capsizing would have been improbable even if she had eventually foundered." The Admiralty endorse this opinion in their minute, which states: "The great weight of water thus gradually admitted into the forward part of the ship might eventually have caused the ship to founder by the head."

We see no reason to believe that the ship could possibly have been saved by the closing of these doors and ports. By the time the sea had reached them the fore end of the ship was so deeply submerged, and there were so many openings by which water could then find its way into compartments not already filled, that it is difficult to conceive how even the rate at which she was so rapidly sinking could be checked. When the sea had reached the height of the turret ports and the upper-deck battery ports and doors, the ship was inevitably doomed. She might possibly have sunk by the head without capsizing, although this appears improbable. With her stability reduced to the extent described in the Admiralty Minutes, when the bow was under water, and the heel to starboard was great, it would appear that the effect of the increasing quantities of water in the ship would certainly be to capsize her very soon. But whatever might have been the precise manner in which she would have gone down, there appears no doubt that the vessel would have gone to the bottom almost immediately after she did, even if the turret and upper-deck battery ports and doors had been closed.

3. *What would probably have happened if all doors, hatches, &c., had been closed before the collision took place.*—We agree upon this point with the opinion, based upon the calculations of the Construction Department, which is expressed in the Admiralty Minute as follows: "While the loss of buoyancy must in that case have been considerable, yet, making all due allowances for probable damage, the ship would have remained afloat and under control, and able to make port under her own steam. Her bow would have been depressed about to the water level, her heel to starboard would have been about one-half of that observed before the lurch began (*i.e.* 9 or 10 degrees), her battery ports would have been several feet above water, and she would have retained ample stability."

4. *The efficiency of the water-tight doors to the bulkheads, and of the means of closing them quickly.*—This question is one of the greatest importance in the present case, because, as we have seen, the *Victoria* might apparently have been navigated safely into port if all the water-tight doors, hatches, &c. had been closed soon enough to prevent water passing from compartments directly opened up by the collision into others from which they were separated by water-tight bulkheads or decks. The Admiralty express strong and unqualified opinions upon this point. Their lordships say "the detailed evi-

dence establishes the fact that water-tight doors, hatches, &c. in the *Victoria* were in good order. It contains nothing which suggests a doubt of the efficiency of the system of water-tight subdivision existing in the *Victoria*. At the parts affected by the collision the subdivision was minute, but doors were left open. According to the established practice of the Admiralty in all classes of ships, the number of water-tight doors is made as small as possible consistently with the essential conditions for working and fighting the ship. . . . In conclusion, their lordships are of opinion that . . . the arrangements of water-tight doors . . . did not by any fault of principle contribute to the loss of the ship; but that, on the contrary, had the water-tight doors, hatches, and ports<sup>1</sup> been closed, the ship would have been saved." Mr. White says, in his Minute: "No orders were given to close doors until one minute before collision. It is established by the evidence that the doors, &c. were in good order. The failure to close doors, therefore, was due entirely to the insufficiency of the time available, especially in compartments breached by the collision."

The statement that the water-tight doors, hatches, &c. were in good order at the time of the collision appears justified by the evidence; except, perhaps, with regard to the door at the after end of submerged torpedo room, which slides horizontally, and could only be moved six or eight inches when the attempt was made to close it after the collision. Their lordships go on to say that the detailed evidence contains nothing which suggests a doubt of the efficiency of the system of water-tight subdivision. We cannot discover, however, that this question was investigated by the Court Martial. Very complete evidence was obtained as to the exact state of each compartment, and of each opening into the compartments, at the time of the collision; but the general question of the efficiency of the system of water-tight subdivision, which involves that of the water-tight doors and hatches to the various compartments, was not gone into. It would appear, indeed, to have been expressly excluded from the investigations of the Court Martial, since it can only be judged in relation to the buoyancy and stability of the ship; and the Court confined itself, as already stated in the quotation given from the Admiralty Minute, to placing upon the Minutes all evidence obtainable with regard to the closing or otherwise of water-tight doors, &c., but did not feel itself called upon, nor feel competent, to express an opinion as to the causes of the capsizing. While it may therefore be true that the evidence contains nothing which suggests a doubt upon these points, it is, on the other hand, equally true that it contains nothing which proves the assertion that the system of water-tight subdivision was efficient.

One of the weak points in the water-tight subdivision appears to have been the doors and hatches to openings in the bulkheads and decks; and especially the impossibility of closing a sufficient number of them after the collision to keep the ship afloat. The doors upon the mess deck were all closed; but this deck was about 3 feet above the water-line, and there was time to attend to the doors upon it before the inrush of water drove the men away. On the protective deck below, however, and on the platform in the hold, there was not time to get at all the doors and hatches before the water reached them; while most of those that were got at and closed appear to have been only partially, and very imperfectly, secured. The plans of H.M.S. *Victoria*, appended to the Admiralty Minutes, show ten water-tight doors in the bulkheads on the protective deck, at the fore side of the armour belt. This deck is about 100 feet in length, and includes the whole of the area directly affected by the collision; and there is only one important bulkhead in this space which

<sup>1</sup> It has already been pointed out that the closing of the ports would apparently have had but little effect, and the Admiralty admit that the ship might still have foundered.

does not contain a door, viz. that which divides the cable locker from the fresh-water tanks. On the platform in the hold, immediately under the protective deck, there are eight water-tight doors in the bulkheads, while there is in addition a water-tight door in the bulkhead at Frame Station 35, which forms the after boundary to the space. This was the door which could not be closed when the attempt was made to do it. There is no bulkhead upon this deck in the space referred to which does not contain a door. Besides these doors there are numerous openings, fitted with water-tight hatches, in the decks over the various compartments.

The Admiralty Minute states that the number of water-tight doors was made as small as possible, in accordance with the established practice of the Admiralty. It would be difficult, however, to fit more doors than are shown upon the plans of the two decks that are below the water-line in the *Victoria*—the protective deck and the deck below it in the hold.

Judging by the Admiralty plans, it was only a certain number of these water-tight doors that were fitted so as to slide horizontally; and some were merely hinged doors, which could only be closed by entering the compartment in which they were situated, and were secured by a number of clips round the edge of the door. Some of these were upon the most important transverse bulkheads, such as the two bulkheads which enclosed the submarine mining flat on the platform in hold. We have always considered that arrangements should be made for closing all doors in bulkheads that are essential to the efficient water-tight subdivision of the ship from a deck that is at a safe height above water, as well as in the compartments where the doors are; and we believe, also, that this is the Admiralty rule—as it obviously ought to be. If doors are fitted below the water-line so as only to be opened or closed in the compartments where they are, they should seldom require to be opened, and never to be left open, unless the bulkheads to which they are fitted are not considered essential to the efficiency of the water-tight subdivision. It does not appear by the evidence, or by the Admiralty Minutes, that a single one of the many doors in the fore part of the ship on and below the protective deck could be closed from a deck at a safe height above water; because the sliding doors could only be closed, we believe, from the main deck, which does not appear to have been more than 3 feet above water at the time of the accident, and was almost instantly immersed. In view of these circumstances we cannot agree with the opinion of the Admiralty that there is "nothing which suggests a doubt of the efficiency of the system of water-tight subdivision existing in the *Victoria*." It appears, upon the other hand, quite practicable to improve the efficiency of this system by dispensing with some of the doors, and by arranging with reference to the others that every one which requires to be left open for even an instant, without the certainty of some one being in constant attendance upon it till it is closed, should be capable of being worked from a deck at a safe height above water.

Mr. White says that the failure to close the water-tight doors in the forward part of the *Victoria* has caused suggestions to be made that automatic or self-closing doors should be adopted instead of existing arrangements. This suggestion was, he adds, carefully considered long ago, after certain experimental doors had been tried. He is satisfied that the existing arrangements are the best, and that their safety is only a question of good time being allowed for closing the doors. It must be remembered, however, that when doors can only be closed in the compartments where they are situated, and these are below the water-level, the inrush of water would often effectually prevent the closing of the doors in bulkheads that separate the compartment that is breached from those

adjacent to it. Also, with such arrangements below as those of the *Victoria*, it is impossible to ensure that an unforeseen accident would always allow of sufficient time to close the water-tight doors in the manner required.

The efficiency of the water-tight hatches, and the chances of their being properly secured in an emergency when they are fastened by a number of clips round the edge, as at present, is also a question that appears to require consideration; while it is to be observed that the sliding horizontal door in the protective deck of the *Victoria*, which opened into a shoot through which coal was trimmed from the reserve bunkers at after end of protective deck, into the side bunkers in the stokehold, could not be closed from the shoot in which the men worked who were trimming the coal; but had to be worked from the submerged torpedo room, a compartment below the protective deck. This open door had an important effect upon the capsizing, for Mr. White states that "one of the chief causes of inclination to starboard is to be found in the fact that, owing to open doors, water was able to find its way from bunkers above the protective deck, down through the coal-shoot, and so to fill No. 7 bunker just before the forward starboard stokehold."

It appears to us that one of the chief lessons taught by the circumstances of this disaster, is the necessity of reducing the number of water-tight doors and hatches, and of arranging that all of them which are essential to the efficiency of the water-tight subdivision, and are ever likely to be left without attendance while open, should be capable of being closed, either by a thoroughly satisfactory self-acting arrangement, or by appliances for working them from a deck at a safe height above water.

The points still remaining to be considered will be reserved for our next article.

FRANCIS ELGAR.

#### REAPPEARANCE OF THE FRESHWATER MEDUSA (*LIMNOCODIUM SOWERBII*).

FOR three years nothing has been seen of the freshwater medusa in the Regent's Park, and naturalists had given up hope of carrying on any further investigation into its life-history. It seemed as though this beautiful little organism—brought we know not how or whence into the midst of London—had, like some mysterious comet, unexpectedly burst on the zoological world, and as unexpectedly disappeared.

I was, therefore, greatly astonished to hear in September, from my friend the Director of Kew, that the curator of the Sheffield Botanic Gardens (Mr. Harrow) had discovered it in quantity in the *Victoria Regia* tank under his care during the present summer, and I was soon after delighted by the safe arrival from Sheffield of a bottle containing living well-grown specimens of the familiar jelly-fish. Mr. Harrow informs me that he observed it in the tank at Sheffield for the first time in the beginning of June of this year (1893). Specimens were still observed as late as the middle of October—giving a duration of some fourteen weeks—an unusually long period. Mr. Harrow estimates the total number seen as at least 300.

The last seen in the Botanic Gardens, Regent's Park, London, were taken from the *new Victoria Regia* tank on July 30, 1890. The question as to how the jelly-fish got to Sheffield is easily answered. Water plants (*Nymphaeaceæ* and *Pontederia*) were sent (as I am informed by Mr. Sowerby and by Mr. Harrow) from Regent's Park to Sheffield to re-stock the tank there on April 4, 1892, and on April 7, 1893. Hence there was the probability of some of whatever reproductive germs of *Limnocodium* existed in Regent's Park being transferred to Sheffield. The curious thing is that in 1892 and in 1891 no *Limnocodium* were seen in the original source—viz. the Regent's

Park tank—nor in 1893, excepting a few sent from Sheffield and placed in that tank by Mr. Sowerby.

This is the first instance recorded in which another *Victoria Regia* tank has been "infected" with *Limnocodium* from the original Regent's Park tank, excepting when the new tank in Regent's Park was in 1890 infected from the old one—by the transference to it of weeds and roots containing the germs of the jelly-fish.

The tank at Kew has never been properly infected, for it is, I regret to say, the anti-zoological custom at the Royal Gardens to thoroughly cleanse, wash, and furbish up the *Victoria Regia* tank every year so thoroughly that the winter germs of the jelly-fish are removed or destroyed. Hence *Limnocodium* has flourished at Kew when sent there from Regent's Park, but has never "carried over" from one season to another. It is, fortunately, the custom in other botanical gardens to leave a quantity of "sludge" (including some old leaves and stems) at the bottom of the tank, when the water is drawn off and the soil prepared for a new season, and hence *Limnocodium* has been preserved from destruction for so many years.

As to what is the precise nature of the process by which *Limnocodium* has been carried over from one season to another in the Regent's Park, we are still uncertain. The facts at first ascertained were these, viz. that the jelly-fish suddenly appear each year as early as April or as late as August, and remain for from five to twelve weeks, when they die down and absolutely disappear. During the first few weeks of their appearance the water is found to contain an immense number of minute young forms ( $\frac{3}{16}$  of an inch in diameter), which I described and figured in the *Quart. Journ. Micros. Science*, vol. xxi. p. 194. Evidently these young were being produced in quantity in the tank, and gradually developed to the full size of half an inch diameter. The form and appearance of these young were such as to lead me to the conclusion (subsequently found to be erroneous) that they had been developed from eggs. At the same time the remarkable fact was established by the examination in successive years of many hundred specimens that the adult *Limnocodia* were every one, without exception, males. They produced abundant motile spermatozoa, but not a trace of an egg-cell was ever found in any one of them!

The hypothesis which I entertained in 1884 as an explanation of this curious state of things was—that the female was a non-motile, perhaps a fixed hydriform organism, and I accordingly searched for such a form in the mud and *débris* from the bottom of the tank. At last, in a large quantity of such material which I obtained when the tank was cleared out in the winter of 1884, my assistant, Dr. A. G. Bourne, found a very strange diminutive polyp adhering in numbers to the root-filaments of *Pontederia*. This polyp he carefully described in the same year in a communication to the Royal Society. There was very great probability that this little polyp, devoid of tentacles, and not more than  $\frac{1}{8}$ th of an inch long, was the "trophosome" of the *Limnocodium* medusa. That this was a true inference was subsequently proved by Dr. G. H. Fowler, who in 1890 (*Quart. Journ. Micros. Science*, vol. xxx.) the last year in which the jelly-fish were seen in London, showed that the little spherical young found floating in the water of the tank are nipped off by a process of transverse fission from the free ends of the minute polyps described by Bourne.

Fowler (whose observations were made in my laboratory in 1883) found the polyps very abundantly upon floating water-plants widely scattered in the tank; they were also detected by Mr. Parsons, of the Quecket Club, in water which was the overflow of the tank, and accumulated in an outside reservoir.

The immediate question then became "How do the polyps originate?" The polyps account for the medusæ,

but whence do they themselves originate? And this question still remains unsolved. The polyps are observed to increase by budding, but they never form clusters of more than four "persons." How do they become distributed over the under surface of nearly all the floating leaves in the tank? How do they get carried to an outside reservoir? Is it not improbable that they would continue year after year to propagate themselves by budding as polyps, and in the summer to throw off successive crops of *male* medusæ? It is possible that this is the whole history, but not quite probable.

In any case, however, the existence of the minute polyps attached to water-plants is sufficient to explain the introduction of the jelly-fish to Sheffield. It also is sufficient to explain the original introduction of the jelly-fish to the Regent's Park, since in 1878 (two years before the first discovery of the jelly-fish) specimens of a remarkable water-plant (*Pontederia*) were brought from Brazil by a lady and presented to the Botanical Society, and placed in the Victoria Regia tank.

A new interest has recently been added to that already attaching to *Limnocoelium* by the description of another fresh-water jelly-fish, the *Limnocoelida Tanganyisica*. This remarkable form was worked out in my laboratory in Oxford during last winter by Mr. R. T. Günther, who received the specimens from his father, Dr. Günther, F.R.S., of the British Museum. Dr. Günther had written to the Mission on Lake Tanganyika in order to procure the specimens. Individuals of three kinds are described by Mr. Günther, viz. males, females, and a-sexual individuals which produce crops of buds on the manubrium (see his papers in the *Ann. and Mag. Nat. Hist.*, 1893, and in the forthcoming number of the *Quart. Journ. Micros. Science*). Whilst differing greatly from *Limnocoelium* in most respects, *Limnocoelida* agrees with it, in a most extraordinary way, in the minute structure of the marginal sense-organs. No light is thrown by *Limnocoelida* on the problem of the life-history of *Limnocoelium*.

I subjoin a list of dates in reference to the history of *Limnocoelium*, and may add that the columns of NATURE already contain numerous communications relative to it, viz. in vol. xxii. (1880), pp. 147, 177, 178, 190, 218, 241, 290, and in vol. xxxi. p. 107.

1880.—June 10, first observed in Regent's Park; remained six weeks.

1881.—June 12; reappeared; remained five weeks.

1882.—None observed.

1883.—April 28; twelve weeks.

1884.—April 27; twelve weeks (?).

1885.—April 5 (no record of duration).

1886.—August 7 (no record of duration).

1887.—End of May (no record of duration).

1888.—May 10 (no record; very few observed).

1889.—None.

1890.—New tank constructed and stocked; July 10 a few.

1891.—None.

1892.—None. Plants sent to Sheffield April 4.

1893.—None in London. Plants again sent, April 7, to Sheffield.

1893.—June 7 to mid-October, large numbers observed in tank at Sheffield.

Hydroid trophosome discovered by Bourne in winter of 1884.

Production of medusæ by hydroid, observed by Fowler, in May, 1888.

E. RAY LANKESTER.

#### DEATH OF PROF. TYNDALL.

ANOTHER of our "Scientific Worthies" has "crossed the bar," leaving behind an honoured name and works that will perpetuate his memory. On Monday evening Prof. Tyndall passed away at his residence, near Haslemere. For some time previous he had been suffering from insomnia and rheumatism, and very unfavourable symptoms set in on Monday morning. He quickly

became unconscious, and except for a brief interval at midday, remained in this state until half-past six o'clock, when a peaceful change from life to death took place. It appears that the cause of death was an overdose of chloral, which Prof. Tyndall took as a sedative against insomnia. He had been in the habit of taking narcotics for several years past in order to overcome the sleeplessness from which he suffered. On Monday about the usual quantity was administered to him, but his greatly weakened condition was unable to bear so much. The inquest on the body, which was considered necessary by the doctors, was held yesterday.

A detailed account of Tyndall's life was given in these columns in August, 1874, so it is only necessary to trace now a brief outline of his career. He was born in 1820, at Leighlin Bridge, near Carlow, in Ireland. But it was not until 1847 that he began his career as a teacher of science, by accepting a post in Queenwood College, Hampshire, where Dr. Frankland was chemist. A year later the two friends did what every young man of science should do, if possible—they went together to a German University, the University of Murburg, Hesse Cassel, rendered celebrated by Bunsen and others; and to Bunsen, whose lectures he attended, and in whose laboratory he worked, Tyndall was never tired of expressing his obligations. He was at Murburg when Knoblauch, preceded by a distinguished reputation, and accompanied by a choice collection of instruments, went there as Extraordinary Professor. Subsequently, in conjunction with Knoblauch, Tyndall carried on his "classic" inquiries in connection with diamagnetism, afterwards prosecuting his research in the laboratory of Prof. Magnus at Berlin. In 1851 his life-long friendship with Prof. Huxley commenced, and in the following year he was elected a Fellow of the Royal Society. In February, 1853, he gave the first of his eloquent Friday evening lectures at the Royal Institution. Shortly afterwards, at the proposal of Faraday, he was appointed Professor of Physics in the Institution, a post from which he retired in 1887. The managers and members of the Institution marked their sense of the benefits he had conferred upon it by electing him as Honorary Professor, a title previously borne by Davy and Brande, and by calling one of the annual courses of lectures "The Tyndall Lectures." His bust was also placed in the Institution in memory of his relations with it.

A complimentary dinner was given to Tyndall on the occasion of his retirement from the Chair of Physics in the Royal Institution. The body of eminent men which met at the dinner was such as has seldom if ever been brought together to do honour to a man of science, and when the chairman, Sir George Stokes, the then President of the Royal Society, gave voice to the desire of the company that their guest should long enjoy the leisure which he had so well earned, it was not thought that after but six years of rest from labour he would be called away. The speeches made at the dinner are reported in NATURE, vol. xxxvi. p. 222, and they show the high regard in which Tyndall was held throughout the world of science, art, and letters. In responding to the toast of the evening, he gave an account of his life, including in his speech the following true remarks:—"To keep technical education from withering, and to preserve the applications of science from decay, the roots of both of them must be imbedded in the soil of original investigation. And here let it be emphatically added, that in such investigation practical results may enter as incidents, but must never usurp the place of aims. The true son of science will pursue his inquiries irrespective of practical considerations. He will ever regard the acquisition and expansion of natural knowledge—the unravelling of the complex web of nature by the disciplined intellect of man, as his noblest end, and not as a means to any other end." This was the kind of spirit that actuated Tyndall throughout his career. It

was well shown in 1872, when he placed the balance of 13,000 dollars, that remained after his lecturing tour in the United States, in the hands of a committee who were authorised "to expend the interest in aid of students who devote themselves to original research."

It would be superfluous for us to enumerate Tyndall's explorations in the domain of science, or to expatiate upon his remarkable power of presenting a subject both in speech and in writing, for among men of science these facts are common knowledge. To such men as he—not only original discoverers, but also popular and powerful interpreters of scientific fact—we owe much of the advancement that has been made during the last forty years.

#### NOTES.

MR. H. H. TURNER, of Greenwich Observatory, has been elected to the Savilian Professorship of Astronomy at Oxford, in succession to the late Prof. Pritchard.

THE Russian traveller Potanin, who has spent more than a twelvemonth in a botanical exploration of Thibet, is expected in St. Petersburg in January next. M. Dobrotworsky has arrived at Jenisseisk on the Jenissei, on a botanical expedition.

PROF. BEN. K. EMERSON, of Amherst College, and of the U.S. Geological Survey, who met with a serious railroad accident last summer, and was reported killed, has so far recovered that he started in November on a trip round the world, for rest and recuperation. He visits Italy, Egypt, India, Java, and Japan. Prof. Emerson has been engaged for a long time in mapping the crystalline rocks of Central Massachusetts and Connecticut.

DR. NICOLE has been appointed Director of the Bacteriological Institute of Constantinople.

DR. SEUBERT has been appointed Professor of Analytical and Pharmaceutical Chemistry in the University of Tübingen.

MR. W. F. C. GURLEY has been appointed Director of the Geological Survey of Illinois.

WE learn that Prof. D. A. Gilchrist has accepted the Professorship of Agriculture at the University Extension College, Reading.

DR. K. VON DALLA TORRE has been appointed Professor of Botany in the University of Innsbrück, and Dr. H. Möller Professor of Botany in the University of Greifswald.

MR. W. T. MCGEE, known for his contributions to geology, has been appointed Director of the Bureau of Ethnology at Washington, U.S.

THE Chair of Comparative Anatomy and Zoology in the Biological School of the University of Pennsylvania has been accepted by Prof. E. D. Cope, and that of Geology and Mineralogy by Prof. A. P. Brown.

THE death of Dr. Webb, the well-known Principal of the Aspatia Agriculture College, is a severe loss to agricultural education. After a very brief illness, he passed away on November 28, in the prime of life. Through his exertions the College at Aspatia has been raised from a very low condition to its present high standing. He was greatly respected by his students, and his place as a teacher of agriculture will not be easily filled.

THE first step towards the introduction of the decimal system into Russia will be taken on January 13, 1894, when, by order of the Czar, the chemists of the Russian empire will begin to use decimal weights and measures.

A PRIZE of 1800 liras is offered by the Italian Geological Society for the best account of the state of knowledge of Palæozoic and Mesozoic formation in Italy, the work to be in continuation of D'Archiac's "Histoire des progrès de la Géologie," and to be presented before the end of March, 1896.

*Die Natur* announces that the Berlin Academy of Sciences has granted Drs. Richarz and Krygar-Menzel two thousand marks for the carrying on of their investigations of the constant of gravitation. A like sum has been granted to Dr. Franz Reinecke for the furtherance of his ethnological and anthropological studies.

THE ninth congress of Russian Naturalists will be opened at Moscow on January 15, 1894. The Mathematical and Physical Faculty of the Moscow University has undertaken its organisation. Reductions of railway fares are offered to persons who will apply for that purpose to the Dean of the Faculty before December 13. The first general meeting of the congress will take place on January 16, and the conference will close on the 23rd of that month.

MR. C. M. IRVINE informs us that at four o'clock on the afternoon of December 4 a brilliant meteor passed over Lesmahagow, N.B., travelling true south. The altitude was about 45°. The arc through which it was visible was about 10°, and the duration of visibility nearly 3 secs. Colour, pale greenish blue. The sky was overcast with detached clouds. The passage of the meteor was slightly zigzag, deviating from a straight line by about 1° on either side.

THE second series of lectures given by the Sunday Lecture Society begins on December 10, in St. George's Hall, when Sir Benjamin W. Richardson, F.R.S., will lecture on "The Mastery of Pain." Lectures will subsequently be given by Prof. A. A. Rambaut, Royal Astronomer of Ireland; Dr. R. D. Roberts, Prof. Percy Frankland, F.R.S., Mr. C. T. Dent, Mr. Arthur W. Clayden, and Prof. R. Meldola, F.R.S.

THE following are among the lecture arrangements at the Royal Institution before Easter:—Prof. Dewar, six lectures (adapted to a juvenile auditory) on air; gaseous and liquid; Prof. Charles Stewart, nine lectures on locomotion and fixation in plants and animals; Mr. W. Martin Conway, three lectures on the past and future of mountain exploration; Prof. Max Müller, three lectures on the Vedānta philosophy; the Right Hon. Lord Rayleigh, six lectures on light with special reference to the optical discoveries of Newton. The Friday evening meetings will begin on January 19, when a discourse will be given by Prof. Dewar, on scientific uses of liquid nitrogen and air. Succeeding discourses will probably be given by Mr. A. P. Graves, Mr. T. J. Cobden-Sanderson, Prof. W. F. R. Weldon, Prof. Silvanus P. Thompson, Prof. John G. McKendrick, Dr. W. H. White, the Right Hon. Lord Rayleigh, and others.

ACCORDING to the *Times* correspondent at Cairo, Messrs. Garstin and Willcocks have inspected the four sites proposed for reservoirs in which to store water for irrigation purposes during the summer when the Nile is low, and their reports will shortly be presented. The Government will then invite three European hydraulic engineers of the highest reputation to come to Egypt and make a technical examination of the proposed schemes. This will probably be in February next. Three of these schemes are for the construction of dams across the river at either Kalabsheh, Assouan, or Silsileh; the fourth proposes to utilise the natural depression of the Wady Raian, in the province of Fayoum, by conducting into it the flood-water of the Nile.

THE London County Council some time ago decided to establish a pathological laboratory and museum in connection with the London lunatic asylums. Last week the Council accepted the plans prepared by Mr. G. T. Hine, and we understand that they will shortly be put into execution at Claybury. A competent pathologist is now to be appointed, who will be supplied with material from the Claybury and other asylums under the supervision of the London County Council. The necessity for

such a laboratory has long been felt, and although good work has been done in several asylums by enthusiastic workers, these investigations have hitherto been carried out at a great disadvantage, chiefly owing to the want of assistance on the part of the governing bodies. So great have been these difficulties that in many asylums pathological science has been totally neglected. The task of electing a pathologist will not be an easy one. It is to be hoped the choice will fall on one who has made his mark in all the various branches of neurological science; for the study of cerebral disease is so bound up with that of the spinal cord and nerves, that a knowledge of cerebral pathology must prove useless if not combined with a thorough mastery of the clinical phenomena of spinal and peripheral nervous diseases, of their lesions, and of the methods of clinical and experimental neurological investigation.

As might have been expected, the anti-vivisectionists, headed by the Lord Chief Justice of England, have memorialised the Viceroy of India and the members of the Executive and Legislative Councils. In this document the usual sentimental arguments against vivisection are stated. If with reference to the Indian Bill now under consideration for the regulation of vivisection experiments, it should be deemed advisable to legislate on the subject, the signatories suggest (a) that the higher animals, such as horses, asses, mules, dogs, and cats, for which special certificates are granted in England, and also monkeys, should be wholly exempted from experimentation; (b) that it should be made essential to keep the animals under an anaesthetic throughout the investigation; (c) that the use of curare should be entirely prohibited; (d) that it should be provided that one inspector at any rate shall be selected on account of his recognised humanity, not his scientific knowledge. The executive committee of the Society for the Protection of Animals from Vivisection have also recently transmitted to the Viceroy and the members of the Executive Council a protest against the establishment of a Pasteur Institute in India. They represent that similar institutes in Paris and elsewhere have so far failed to prevent deaths from the bites of dogs and other animals alleged to be rabid, and that 256 persons have died in spite of the preventive treatment invented by M. Pasteur. It is also remarked that the Pasteur system involves and depends upon the cultivation and perpetuation of the malady of rabies in series after series of sentient animals, to their great misery and suffering, but the benefits that mankind derives from it are naturally ignored.

DURING the week ending the 2nd inst. several depressions passed across these islands, causing gales on our northern coasts. In the rear of these disturbances northerly winds set in, with a great fall of temperature; on the 1st and 2nd inst. the thermometer fell to 20°, or less, in nearly all parts. In Scotland the lowest readings were between 12° and 15°. But by Sunday, the 3rd inst., the temperature rose rapidly in the north and west, and subsequently the rise extended to the southern parts of the country.

THE *Meteorologische Zeitschrift* for November contains a paper on the frequency of halo phenomena, by G. Hellmann. Few text-books have dealt with this subject, and those that have done so state that lunar halos are most frequent, an error which appears to date from the time of Aristotle. Certainly the moon offers less opportunity for such phenomena. Prof. Hellmann points out that only such observatories as record hourly observations afford the necessary materials for giving a satisfactory answer to the question. He has examined various records, and especially those of the Upsala observatory, the result being that the solar phenomena exceed the lunar by about five to one, by far the most frequent halos being those of 22° radius. The halos as well as mock-suns and mock-moons show a distinct yearly period. The solar phenomena are most

frequent from April to June, and the lunar phenomena are most frequent in the winter half-year, being dependent on the length of the nights. These results are supported by observations made in the United States, and also in Japan.

THE *Pioneer Mail*, of November 9, contains an article on the past monsoon in India, based upon the official reports of rainfall between June 1 and October 15. These reports show a generally satisfactory state of affairs, about half the country having had excessive, and half deficient rainfall; some regions which generally receive only moderate rain had an excessive amount, while those which usually receive an excessive amount had a relatively light fall. The causes which bring about this half-yearly reversal of the winds are of especial interest, and offer a large field for study. Among the generally accepted theories, one attributes the origin of the rain-bearing current to the intense heating of the plains of Upper India, while another is that the chances of a good monsoon vary inversely with the amount of snow during the preceding winter. The writer thinks that these theories have failed in the present instance, while admitting that the distribution of heat and, under some circumstances, the snowfall exercise an influence on the monsoon. He sets up another theory, viz. that the monsoons are caused by the heated air of Asia rising up and overflowing at a great height to the southern hemisphere, where it settles down and is impelled northward by its own energy and by pressure in the rear. A reference to the "Memorandum on the Snowfall, &c." issued by the *Meteorological Reporter* on June 1 last, shows that the general forecast was to the effect that the rainfall might be deficient to a moderate extent in north-west India, and would very probably be at least normal in other parts. If any modification of the accepted theories be necessary, it will doubtless be shown by a study of the daily charts of the Indian monsoon area, to which we recently alluded, and the publication of which began with the present year. One of the special objects in preparing these charts is to elucidate the conditions which determine the advances, and variations in strength of the monsoon currents.

SOME interesting observations on the velocity at which crystallisation proceeds in a super-cooled substance are communicated by Mr. Moore to the current number of the *Zeitschrift für Physikalische Chemie*. The method of experiment resembles that originally used by Gernez. The substance is contained in a carefully cleaned U-tube, made of thin glass, which is immersed in a bath of liquid maintained at constant temperature, and which during an observation is kept open at both ends. When crystallisation sets in, in such a tube, the line of demarcation between solid and liquid can readily be followed by eye, and the time can easily be noted which is taken by the crystallisation to travel a definite distance down a limb of the U tube. Satisfactory observations cannot be taken when the crystallisation is rising in a limb of the tube, owing to the disturbing effects of the thermal changes attending solidification. Experiments on acetic acid showed that at any temperature the velocity is uniform, and is independent of the diameter of the tube, and observations on acetic acid, phenol, and mixtures of phenol with water and with cresol, show that the velocity increases with the amount of super-cooling, and at a diminishing rate. For phenol it is 6 c.m. per sec. with 4°·4 super-cooling, and 2·9 c.m. with 15°·8 super-cooling. The addition of water and of cresol to phenol largely reduces both the velocity of crystallisation and the rate at which it increases with the amount of super-cooling. Several of the curves indicate a maximum velocity as the extent of super-cooling increases. Attempts to observe this maximum were rendered fruitless, however, by the spontaneous crystallisation of the substances.

DIURNAL movements of the ground have been noticed at Santiago for some years, and have usually been attributed to the

action of heat upon the Santa Lucia mountain. According to *La Nature*, the observatory has recently been removed to a plain at the south of the city, and Dr. Obrecht, the director, has investigated the movements. It appears from his observations that from noon until nine o'clock in the evening, the ground to the north-east is raised, and then gradually descends until seven o'clock on the following morning. These curious variations sometimes attain an amplitude of 3" or 4". There is also evidence that from July to September the ground to the north-east is continuously raised, while from September to November, the part to the east of the observatory is continuously elevated. The total amplitude of elevation is said to be about 35".

MR. A. SIGSON, a professional photographer at Rybinsk, contributes an account of his method of obtaining photographs of snowflakes to the *Journal of the Russian Physico-Chemical Society*. He used a Zeiss microscope provided with an aplanatic lens and a long focus camera. This was placed near an attic window at a strong inclination to the horizon. The flakes were received on some rough cloth and transferred to a small net of cocoon fibres stuck on a card perforated in the middle. This card was placed on the stage of the microscope, and the illumination was so arranged that half the field was uniformly illuminated, and the other half shaded off. For an enlargement of fifteen times the exposure lasted two to five seconds, with plates supplied by M. Lumière. To avoid the melting of the flakes by the breath of the operator, the latter is obliged to breathe through a pipe bent backwards during the adjustment of the apparatus.

IN *Bulletin* No. 8 of the Geological and Natural History Survey of Minnesota, Dr. Andrew C. Lawson publishes two papers of great importance for the systematic grouping of volcanic rocks in North America. The first paper is on the "Anorthosytes of the Minnesota Coast of Lake Superior," and is prefaced by a long note, written by Prof. Winchell, on "The Norian of the North-West." In this note Prof. Winchell gives up many of his previously-formed ideas regarding the Minnesota rocks, in favour of the conclusions now obtained by Dr. Lawson. There occurs on the Minnesota coasts a rock almost wholly composed of a plagioclase felspar which had been included by Profs. Winchell and Irving in the Keweenaw or Cupriferos series of volcanic lavas and sheets. For this rock, Dr. Lawson accepts the name of "Anorthosyte," given by Prof. Adams to similar rocks in the Norian series of Quebec; and he proves conclusively that it is a Plutonic formation, solidified under deep-seated conditions, and exposed later during the long period of pre-Palæozoic erosion. On its eroded surface the volcanic lavas of the Keweenaw series were poured out, no rocks belonging to the Animikie series being present in this area. The thickness of the Keweenaw series had been estimated by Prof. Irving at 20,000 feet. Dr. Lawson is of opinion that the series is comparatively thin, ranging from zero to a maximum of a few hundred feet. Special interest attaches to the hummocky—*roches moutonnées*—aspect of the old surfaces of the Anorthosyte rock at Beaver Bay, Carlton Peak, &c., as this is such a marked feature of the ancient erosion planes of Archæan rocks in North America. Dr. Lawson compares the Anorthosytes of Minnesota with the Norian series of irruptive plagioclase rocks invading Archæan gneisses in Quebec, but until there is sufficient evidence in favour of this correlation, he suggests that a local name of "Carltonian" be given to the Minnesota Anorthosytes.

THE second paper in the same *Bulletin*, by Dr. Lawson, is entitled "The Laccolitic Sills of the North-West Coast of Lake Superior." Extensive trap-sheets are in this region associated with the Animikie and Nipigon groups of sedimentary rocks, and have up to this time been described as contemporaneous flows. Mr. Ingall had observed the intrusive nature of some of these

so-called flows, but drew no farther conclusions. Dr. Lawson now advances the view that "there are no contemporaneous volcanic rocks in the Animikie group, and that the trap-sheets are all intrusive in their origin, and are of the nature of laccolitic sills." He supports this view by weighty evidence, such as the simplicity of the trap-sheets, their regularity and persistence over wide areas, the passage of thick sheets from the Animikie series into the higher horizons of Keweenaw strata, the absence of pyroclastic rocks, the alteration of the rocks above and below the intruded sheets, and the direct continuity of the "trap-sheets" with dykes of the same intrusive rock. The "trap-sheets" occur as laccolitic sills both in the Animikie and Keweenaw series, and are therefore later than these. Dr. Lawson thinks they may belong to the great series of trap-rocks intruded in the Silurian rocks of Quebec, but calls them for the present "Logan Sills," in honour of the late Sir William E. Logan.

IT is well known that electric currents may be produced by heating a single metal, if there be any variation in temper, or if the distribution of heat be very irregular, and the changes of temperature abrupt. Mr. W. H. Steele has made some experiments on these effects, in the Physical Laboratory of Melbourne University (*Science*, No. 562). A sensitive galvanometer put in circuit with a piece of iron wire showed a current when the wire was simply warmed with the fingers. This was the only metal which gave a current when at a temperature below 100° C. Altogether twelve different metals and four alloys were examined, and the effect noticed in each of them. In order to raise the wires to a high temperature without fusing them, they were passed through clay tubes (stems of tobacco-pipes), and, in the case of metals having low melting-points, the tube was completely filled with the metal. The highest electromotive force obtained from iron was 0.002 volt; 0.3 volt was observed with six different metals—lead, copper, gold, tin, zinc, and antimony; while with others, *e.g.* silver and aluminium, the effect was exceedingly small. In the case of lead, the effect showed no sign of ceasing after the metal had been heated for half a day. Gold gave the highest effect, as much as half a volt being observed. Mr. Steele remarks that these phenomena are generally quite sufficient to mask the ordinary thermo-electric effect at a red heat, and that thermo-electric tables are consequently not trustworthy for high temperatures.

THE current number of the *Comptes Rendus* contains a note, by M. Ch. André, on the variation of the electric state of the high regions of the atmosphere in fine weather. During a previous attempt to investigate this point, the author unfortunately met with an accident which has prevented him personally making any more observations; the measurements contained in this note have, however, been made under his direction. At opposite corners of the car of the balloon were fixed two cylindrical reservoirs, filled with distilled water, and insulated on plates of sulphur. To the base of each of these vessels an india-rubber tube, about 20 metres long, was attached, each tube having a small jet at its end. When the balloon had come to rest at any desired height, the difference of potential existing between two points, at a known vertical distance, was determined by means of an electrometer (Exner's pattern) connected metallically with the water reservoir. This difference of potential, the distance being kept constant, gave a measure of the strength of the electrical field. As a result of two series of observations, the author considers that in fine weather the strength of the electrical field does not increase with the altitude, but is the same at a given instant at any point along the same vertical.

IN a paper communicated to the Reale Accademia delle Scienze, Torino, Signor Garbasso gives an account of his experiments on the reflection of electrical waves. The author allows the waves given out by a Hertz oscillator to fall upon a mirror consisting of a wooden plank 175 c.m. long and 125 c.m. broad, over which were stretched a large number (168) of parallel rectilinear resonators. These resonators were without spark-gaps, and consisted of wires 20 c.m. long with metal discs, 3·8 c.m. in diameter, fixed at either end. When another resonator, having a spark-gap, is placed so that the radiation reflected from this mirror falls upon it, bright sparks are produced, as has been shown by Trouton and others, when its length is parallel to the wires on the reflector, while no sparks are produced when it is at right angles to these wires. What seems curious, however, is that the radiation reflected, although it has such a large wave-length compared with the dimensions of the mirror, is not scattered but is regularly reflected.

IN No. 5, vol. xii. of the *Zeitschrift für Physikalische Chemie*, Mr. Harry C. Jones gives an account of an additional series of observations on the freezing-points of dilute aqueous solutions. The most dilute solutions employed were in general about 0·001—normal. Of the inorganic substances examined ammonia exhibited the most striking behaviour. Although the bases potash and soda like hydrochloric and nitric acid seem to be almost entirely dissociated into ions, ammonia is only dissociated to the extent of some twenty per cent. Phosphoric acid apparently dissociates into the two ions H and  $H_2PO_4$ , and in the most dilute solutions is less dissociated than sulphuric acid, which in turn is less dissociated than the monobasic acids. The extent of the dissociation thus obtained agreed, in the main, with that deduced from Kohlrausch's observations on the electric conductivity of the solutions. The organic substances examined gave quite unexpected results. Cane-sugar, dextrose, urea, phenol, and ethyl and propyl alcohols, which, according to the new theory, cannot undergo electrolytic dissociation, behaved in all cases in the most dilute solutions as if they were really dissociated, and gave molecular lowerings of the freezing-point which were much higher than the calculated value. Indeed, if one supposes for the moment that cane-sugar can dissociate into two ions, the observations on the freezing-point of its aqueous solutions, when treated as in the case of an electrolyte, would indicate that twenty-seven per cent. of the sugar is dissociated, or an amount greater than that found for ammonia. With rise in concentration the molecular lowering for all the organic substances diminishes, in some cases reaching a minimum and then increasing, or, as in the case of urea and the two alcohols, remaining constant. This constant minimum value of the molecular lowering agrees closely with the theoretical number. The explanation of these remarkable results from the standpoint of the new theory will be awaited with interest.

THE marked increase in the vitality of the cholera bacillus in artificial culture media induced by adding larger than usual proportions of salt to the latter, was drawn attention to in these notes on August 24, in connection with the saline condition of the river Elbe at the intake of the Hamburg water-works during the great cholera epidemic. In a subsequent note, on September 28, it was pointed out how this property of the cholera organism had been taken advantage of by Koch and others in devising methods for the separate identification of this vibrio in water in the presence of other harmless saprophytic bacteria. Of extreme interest, therefore, are the experiments of Dr. M. N. Gamaleia, contained in a short paper, "Du choléra virulent et épidémique," contributed to the *Comptes Rendus*, No. 5, 1893, p. 285. This investigator states that he was able to increase the virulence of the cholera organism by cultivating it in media containing from

3, 4, up to 5 per cent. of common salt. Nor were these results confined to one particular cultivation of the cholera bacillus, but were also derived with cholera cultures obtained from numerous different sources. On inoculating these salt-cultures of cholera vibrios into pigeons and guinea-pigs, symptoms of septicæmia developed, invading the blood and all the tissues. If one drop of the blood of these infected animals was taken and inoculated into others, the malady was transmitted. These observations support the theory that the unusual saline condition of the Elbe may have assisted in supplying the conditions which so greatly favoured the vitality and virulence of the cholera bacillus during the Hamburg epidemic.

THE last two numbers of the *Botanische Zeitung*, published on November 1, are devoted to a memoir by E. Crato, "Morphologische und mikrochemische Untersuchungen ueber die Physoden." This memoir is stated to be an "Arbeit" carried on under the direct guidance of Prof. Dr. Reinke, at the University of Kiel, and the following is from the summary given by the author:—There lies at the basis of the vegetable cell a system of delicate lamellæ, arranged in such a way as to form a foam-like mass (Lamellensystem, Gerüstsubstanz). In those plants where the point has been carefully investigated, these lamellæ do not give the ordinary proteid reactions. The spaces enclosed by the lamellæ contain a clear, watery, slightly refractive fluid (Kammerflüssigkeit), whereto belong both cell-sap as well as enchylema. In these lamellæ there glide about, apparently at will, minute, refractive, bladder-like formations (physodes, to which the greater part of the microsomes belong), swelling out the lamellæ where they occur. These physodes certainly form readily transportable vehicles of chemical substances for the plant. In the brown Algæ these physodes contain substances similar to phenol. In all the Algæ which were investigated, the Laminaria excepted (their investigation is not complete), phloroglucin was found. Further, it would appear that these phenol-like substances are used up for the formation of the lamellar substance (plasma, &c.).

MAJOR J. W. POWELL's eighth annual report, as Director of the U.S. Bureau of Ethnology, is a splendid addition to ethnological literature. In the first part of the volume the plans and operations of the Bureau are described, a brief account being given of the many investigations carried on during the fiscal year 1886-87 by the twenty-five assistants. The contributions contained in the volume are: "A Study of Pueblo Architecture, Tusayan and Cibola," by Mr. Victor Mindeleff, and "Ceremonial of Hasjelti Dailjis and Mythical Sand Painting of the Navajo Indians," by Mr. James Stevenson, this being his last official work before his death in 1888. In these papers "the prehistoric archæology of the Pueblos in the special department of architecture is the most prominent single subject presented and discussed; but the papers also include studies of the history, mythology, and sociology of that people, as well as of their neighbours and hereditary enemies, the Navajo." All these correlated studies are set forth in detail, and are profusely illustrated. Mr. Mindeleff's study relates to the ruins and inhabited towns found over a large territory in the interior southwestern parts of the United States. His research leads him to conclude that there is no need for the hypothesis of an extinct race with dense population and high civilisation to account for the conditions actually existing in North America before the European discovery. Mr. Stevenson's paper is most interesting, and it has the advantage of being a statement of facts actually witnessed by the deceased author. Translations of six of the Navajo myths are also presented, some of which elucidate parts of the ceremony forming the main title of his paper. The whole work has been excellently done, and our only regret is that there should have been a delay of six years in its publication.



DURING the summers of 1891 and 1892 Mr. W. P. Hay took the opportunity, while visiting the caves of Southern Indiana, to observe the habits of the blind crayfish, *Cambarus pellucidus*. In some of the caverns, as at Shiloh Cave, the crayfish were extremely abundant. When observed in an undisturbed state, they were found resting quietly in some shallow part of the underground streams on the clay banks. They lay with all their legs extended, and their long antennæ gently waving about to and fro. They were easier caught by the hand suddenly seizing them than with a net. Noise did not seem to affect them. When first taken out of the water they were of a translucent pinkish white colour, with the alimentary track showing through as a blue body, but they soon lost these hues. The variation in the general spininess is very great. As a rule, the farther north the specimens were taken the smoother they were. At Mayfield's Cave, in Monroe County, a variety was found entirely without spines; this is described and figured as a sub-species. (Proc. U.S. Nat. Museum, No. 935, 1893.)

IN Wundt, *Philosophische Studien*, ix. Bd., 1 Heft., Herr Bruno Kämpfe brings together all the values of the integral for the probable error, *i.e.*

$$\phi(\gamma) = \frac{2}{\sqrt{\pi}} \cdot \int_0^{\gamma} e^{-t^2} dt,$$

which gives the whole number of errors, both positive and negative, whose numerical magnitude falls between the given limits. The number of errors between any two given limits will be found by taking the difference between the tabular numbers corresponding to these limits. Since the total number of errors is taken as unity in the table, the required number of errors in any particular case is to be found by multiplying the tabular numbers of the actual number of observations. Thus, to take an example, if there were 1000 observations, and we wish to employ the limits 0.0 and 0.5, then looking in the column giving the values of  $\gamma$ , we find against them the numbers 0.0000 and 0.5205, which when subtracted from one another, and multiplied by 1000 give 520.5 or 520 errors. If the limits had been 1.5 and 2.0, then we should have found the corresponding values 0.9661 and 0.9953, which subtracted give 0.0292, and multiplied by 1000 give 29, *i.e.* 29 errors that lie between these limits out of 1000 observations. This table is published also as a *separatabdruck* by Wilhelm Engelmann, Leipzig, which is in a more useful form for computation. The values of  $\gamma$  can be read directly to three places of decimals.

WE have received a report of the meteorological observations made during 1892 at the Royal Alfred Observatory, Mauritius.

THE new issue of Mr. Edward Stanford's compendium of geography and travel includes a revised and partly rewritten edition of "Australasia." Under this title Dr. A. R. Wallace's excellent description of Australia and New Zealand has been published, and a second volume, embracing Malaysia and the Pacific Archipelagoes, by Dr. F. H. H. Guillemard, is in preparation.

MM. J. B. BAILLIÈRE ET FILS have added to their library of contemporary science a volume entitled "Pêches et Chasses Zoologiques," by the Marquis of Folin. The book is well illustrated, and, though much of the matter it contains is only of local interest, a large portion will be read with profit by students of natural history.

IT is very doubtful whether any useful purpose is served by the issue, from Mr. Edward Stanford's, of the series of maps edited by Captain A. Staggemeier, of Copenhagen. The maps show very little except the configuration of the land surfaces, the editor's idea being that they will be of service to physical geographers for placing observed facts of natural history,

meteorology, &c., in their proper geographical position. There are five maps in the portfolio before us, two showing the Polar regions down to 30°, and three the zone between 45° of North and South latitude, on Mercator's projection; hence the zones between latitudes 30° and 45° are represented on both projections. It is intended to issue other maps on a larger scale, the whole series to comprise twenty-five plates, which will be published in six parts.

IT is encouraging to learn, from the forty-first annual report of the working of the Manchester Public Free Libraries, that during the year 1892-93, 77,878 volumes dealing with science and art were issued from the reference library, and 67,456 were referred to in the reading-room. The total number of books issued to borrowers by the nine branch libraries was 872,655, of which 45,526 are classified under science and art. Of the 100,123 volumes consulted in the reading-rooms of the branch libraries, 7869 were on science and art subjects. The record is a good one; but if the committee were to classify science separately from art, we should be better able to estimate from the figures the growth of interest in natural knowledge.

DR. ARTHUR GAMGEE has just completed the second volume of his text-book on the Physiological Chemistry of the Animal Body, upon which he has been engaged for some years. Like the first volume, it constitutes an independent and complete treatise, dealing with the physiological chemistry of the digestive processes. It has been the author's aim to give the reader a very full and, so far as possible, independent account of the state of knowledge on the subjects discussed. Messrs. Macmillan and Co. will publish the volume immediately.

MESSRS. MACMILLAN AND CO. are also about to publish a revised and enlarged edition of "Elementary Lessons in Steam Machinery and the Marine Steam Engine," by Messrs. Langmaid and Gaisford, Instructors on H.M.S. *Britannia*. It will be followed by other works constituting a Britannia Science Series. Among those already in hand may be mentioned "Physics for School Use," by Mr. F. R. Barrett, Mr. A. E. Gibson, Rev. J. C. P. Aldous, and others; a "Physics Note-Book," by Messrs. Gibson and Aldous; "Trigonometry for Practical Men," by Mr. W. W. Lane; and "Geometrical Drawing, Perspective, and Mechanical Drawing," by Mr. J. H. Spanton.

THE additions to the Zoological Society's Gardens during the past week include a Mozambique Monkey (*Cercopithecus pygerythrus*, ♂) a Sykes's Monkey (*Cercopithecus albicularis*, ♂) a Bell's Ciniys (*Ciniys belliana*) from East Africa, presented by Mr. T. E. C. Remington; a Red Tiger Cat (*Felis chrysothrix*) from the Gold Coast, West Africa, presented by Mr. William Adams; a Common Otter (*Lutra vulgaris*) from Yorkshire, presented by Mr. C. B. C. de Wit; a Herring Gull (*Larus argentatus*) British, presented by Mr. J. G. Goodchild; a Northern Mocking Bird (*Mimus polyglottus*) from North America, presented by Miss Dorothy Williams; a Viperine Snake (*Tropidonotus viperinus*) European, presented by Miss Ffennell; five Barbary Partridges (*Caccabis pectorata*) from North Africa, deposited.

#### OUR ASTRONOMICAL COLUMN.

THE VARIATION OF LATITUDE.—In the *Astronomical Journal*, No. 19 (November 14), Prof. S. C. Chandler gives the eighth of the important series of articles that he has been contributing on the variation of latitude. The special part of the subject which is referred to deals with the direction of the rotation of the pole and is accompanied by an explicit demonstration which includes all the data bearing upon it. Owing to the insufficient extent of series of observations in widely different longitudes to furnish independent values of the constants

for both terms of the variation, Prof. Chandler has thought well to combine short series made in nearly the same longitudes, and so deduced fourteen determinations of the numerical equations for the latitude variation. Reducing the values so obtained to a common epoch, he found that the values of the observed Julian date when the latitude would be a minimum, or when the pole of figure would pass the meridian of the respective stations by virtue of the fourteen months' revolution alone, and of the sun's longitude on the observed date when the same phase would occur by virtue of the annual term alone, both decreased from Pulkowa towards Madison showing that the direction of the rotations in both the elements was from west to east. In the latter part of the article Prof. Chandler refers not only to our knowledge of the general law of latitude variation, but to the accuracy of the necessary constants which afford us a means of predicting the immediate future course. The minimum of the curve of April, 1893, will be followed by an interval of nearly two years, and will be marked by very slight fluctuations, so that from the maximum of October, 1893, to that of August, 1895, or from minimum April, 1893, to that near the beginning of 1895, "there will apparently be but a single decidedly marked period of, say 20-22 months," the total range amounting to  $0^{\circ} 10'$  as against  $0^{\circ} 56'$  which prevailed in 1889 and 1892. In May, 1896, the same dimensions as in 1889 will be again attained, and the variation from that time forward to 1898 it will be in full play with the range of  $0^{\circ} 5'$  or  $0^{\circ} 6'$ , a period of nearly 390 days which prevailed between 1889 and 1892. In § 2 of the article Prof. Chandler adds a few words as to the reality of these movements of the earth's axis as against the motions being "merely misinterpretations of the observed phenomena" or an illusory effect of instrumental error due to the influence of temperature. Those of our readers who are still sceptical on the subject will learn that the observed law of latitude variation includes two terms, one with a period of fourteen months, and another with twelve months, making the phases come in very different relations to conditions of temperature dependent on season. An argument greatly against that brought forward by temperature-variation believers.

METEOR SHOWER FOR DECEMBER.—No news is yet to hand with regard to the Biela meteors, but we hope soon to receive accounts of the display which will give us some idea of the quantity and also of the date of reaching their maximum. The following meteor radiant-points are given by Mr. Denning for the ensuing month, that for the 10th lying approximately close to  $\rho$  Gemini in a prolongation of  $\beta$  and  $\rho$  Gemini, and being defined as a "most brilliant shower."

| Date.      | Radiant.     | Meteors.       |
|------------|--------------|----------------|
|            | $\alpha$     | $\delta$       |
| Dec. 8 ... | 145 + 7 ...  | Swift; streaks |
| 8 ...      | 208 + 71 ... | Rather swift   |
| 10 ...     | 108 + 33 ... | Swift; short   |
| 24 ...     | 218 + 36 ... | Swift; streaks |
| 25 ...     | 98 + 31 ...  | Very slow      |

REFRACTION TABLES.—We have received a small pamphlet extracted from the *Mittheilungen aus der Deutschen Schutzgebieten*, Bd. vi., Heft 4, containing refraction tables computed by Dr. L. Ambronn, of the Göttingen observatory. These tables are not intended for such accurate values as are required in observatories with fixed instruments, but are intended to be used by those who having made astronomical observations, wish to compute them on the spot, using approximate formulæ. Travellers, especially, will find these tables very useful for wide ranges, both as regards temperature and barometer arguments. The tables are based on Bessel's refraction-table formula, and by slightly combining the first two terms, which is no other than the mean refraction, and eliminating the term  $\log T$  by reducing the height of the barometer to  $0^{\circ}C$  becomes, employing the usual notation:

$$\log \text{refraction} = \log a \tan z + A \log B_0 + \lambda \log \gamma$$

$$\text{or} \quad \text{refraction} = a \tan z : B_0^A \times \gamma^\lambda \dots (1)$$

To make the correction for the mean refraction additive, the expression can be put in the form:

$$\text{refraction} = [a \tan z + a \tan z (\gamma^\lambda - 1)] B_0^A$$

Table II. gives the expression for the second term in the brackets using the mean refraction ( $a \tan z$ ) and the air temperature ( $\gamma$ ) as arguments. For the barometer correction, if

$a \tan z$  represent the mean refraction corrected for temperature then in equation (1) we may omit  $\gamma$  and write

$$\text{refraction} = (a \tan z) \times B_0^A$$

$$\text{or, refraction} = (a \tan z) \times (a \tan z) [B_0^A - 1]$$

The second term is taken direct from Table III. using the the mean refraction (corrected for temperature) and the height of the barometer as arguments.

To obtain the true refraction then, one simply (1) finds the mean refraction for the given zenith distance; (2) adds then the correction for temperature, and with this corrected mean refraction as argument; (3) adds the corresponding correction for the height of the barometer. Accuracy up to less than half a second of arc can be obtained.

GEOGRAPHICAL NOTES.

THE friends of the late Emin Pasha, at the suggestion of Dr. Schweinfurth, have resolved to collect subscriptions for a memorial to commemorate his long labours in Africa as a naturalist, traveller, and administrator. There must be many in this country anxious to have a share in such a tribute, and we shall shortly be able to intimate where subscriptions should be sent. The present proposal is to erect a monument in the Silesian town of Neisse.

By the death of Mr. A. L. Bruce, at Edinburgh last week, the cause of geography and civilisation in Africa has lost a wealthy and judicious promoter. Mr. Bruce, who married as his second wife a daughter of Dr. Livingstone, was a director and one of the founders of the Imperial British East Africa Company. He was a devoted friend and warm supporter of Mr. H. M. Stanley, and took a leading position in organising and supporting the Emin Relief Expedition. Mr. Bruce was the originator of the Royal Scottish Geographical Society, of which he acted as treasurer, and in the prosperity of which he took the keenest interest to the last.

GIULIO GRABLOVITZ has published as a pamphlet a paper on tidal phenomena in the Mediterranean, read at the Italian Geographical Congress, and entitled "Sulla Osservazioni Mareografiche in Italia e specialmente su quelle fatte ad Ischia." The work done with recording mareographs is of considerable importance and several diagrams are given showing the tidal range and its fluctuations. The mean rise of the water was 11 centimetres at San Remo, 24 at Genoa, 12 in the North of Sardinia, from 15 to 22 along the west coast of Italy as far as Ischia, 30 in the Lipari Islands, but only from 2 to 13 round Sicily. In the Adriatic the range increased from 9 centimetres at Brindisi to 48 at Venice, which was the only station showing a range greater than one foot. The curves are recorded on a large scale, the ripples of the calm water in which the mareograph worked bearing a comparatively large ratio to the total tidal amplitude.

MONT ISERAN, in the eastern Alps, is, or rather was, one of the most remarkable mountains on the map of Europe, where it flourished long, although without any physical representative on the mountain-range itself. M. Henri Ferrand, in an entertaining little brochure relates its story, showing how it had come to be an accepted belief amongst cartographers that the river Isère had its source in a Mont Iseran. The mountain was fixed in latitude, longitude, and altitude by an Italian surveyor in 1809; but in the fifties, when Alpine climbing became fashionable, the discovery was made by climbers that no one in the neighbourhood could point out Mont Iseran. There was a col of that name, but no peak. An exhaustive French survey conclusively proved that the summit so long honoured on all maps had no real existence, and M. Ferrand tells the whole amusing history remarkably well as a lesson of the value of mountain-climbing, even to scientific topography.

THE telegraphic cable opened last month from Zanzibar to Mauritius and Seychelles is an important link in the cable network which is gradually encompassing the globe.

THE ANNIVERSARY MEETING OF THE ROYAL SOCIETY.

THE anniversary meeting of the Royal Society was held in the apartments of the Society at Burlington House, on St. Andrew's Day, November 30. The auditors of the

treasurer's accounts having presented their report, the secretary read the list of Fellows elected and deceased since the last anniversary. The Society has lost eleven fellows on the home list, and two foreign members, as follows:—

Henry Tibbats Stainton, December 2, 1892, aged 70.  
 Sir Richard Owen, December 18, 1892, aged 89.  
 Dr. James Jago, January 18, 1893, aged 77.  
 Henry Francis Blanford, January 23, 1893, aged 58.  
 Thomas William Fletcher, February 1, 1893, aged 84.  
 Edward Walker, March 2, 1893, aged 73.  
 Alphonse de Candolle, March 28, 1893, aged 87.  
 Henry Edward Stanley, Earl of Derby, April 21, 1893, aged 67.  
 Ernest Edward Kummer, May 14, 1893, aged 84.  
 Rev. Charles Pritchard, May 28, 1893, aged 85.  
 Dr. John Rae, July 22, 1893, aged 80.  
 Thomas Hawksley, September 23, 1893, aged 86.  
 Sir Andrew Clark, Bart., November 6, 1893, aged 67.

The Society next proceeded to elect the officers and council for the ensuing year. A list of those selected for election was given in NATURE, November 9.

Lord Kelvin, the President, then delivered his address. After briefly referring to the work of the Standing Committees, he continued as follows:—

Not the least important of the scientific events of the year is the publication, in the original German and in an English translation by Prof. D. E. Jones, of a collection of Hertz's papers describing the researches by which he was led up to the experimental demonstration of magnetic waves. For this work the Rumford Medal of the Royal Society was delivered to Prof. Hertz three years ago by my predecessor, Sir George Stokes. To fully appreciate the book now given to the world, we must carry our minds back to the early days of the Royal Society, when Newton's ideas regarding the forces which he saw to be implied in Kepler's laws of the motions of the planets and of the moon were frequent subjects of discussion at its regular meetings, and at perhaps even more important non-official conferences among its Fellows.

In 1684 the senior secretary of the Royal Society, Dr. Halley, went to Cambridge to consult Mr. Newton on the subject of the production of the elliptic motion of the planets by a central force,<sup>1</sup> and on December 10 of that year he announced to the Royal Society that he "had seen Mr. Newton's book, 'De Motu Corporum.'" Some time later, Halley was requested to "remind Mr. Newton of his promise to enter an account of his discoveries in the register of the Society," with the result that the great work "Philosophiæ Naturalis Principia Mathematica" was dedicated to the Royal Society, was actually presented in manuscript, and was communicated at an ordinary meeting of the Society on April 28, 1686, by Dr. Vincent. In acknowledgment, it was ordered "that a letter of thanks be written to Mr. Newton, and that the printing of his book be referred to the consideration of the council; and that in the meantime the book be put into the hands of Mr. Halley, to make a report thereof to the council." On May 19 following, the Society resolved that "Mr. Newton's 'Philosophiæ Naturalis Principia Mathematica' be printed forthwith in quarto, in a fair letter; and that a letter be written to him to signify the Society's resolution, and to desire his opinion as to the volume, cuts, &c." An exceedingly interesting letter was accordingly written to Newton by Halley, dated London, May 22, 1686, which we find printed in full in Weld's "History of the Royal Society" (vol. i. pp. 308-309). But the council knew more than the Royal Society at large of its power to do what it wished to do. Biology was much to the front then, as now, and the publication of Willughby's book, "De Historia Piscium," had exhausted the Society's finances to such an extent that the salaries even of its officers were in arrears. Accordingly, at the council meeting of June 2, it was ordered that "Mr. Newton's book be printed, and that Mr. Halley undertake the business of looking after it, and printing it at his own charge, which he engaged to do."

It seems that at that time the office of treasurer must have been in abeyance; but with such a senior secretary as Dr. Halley there was no need for a treasurer.

Halley, having accepted copies of Willughby's book, which

had been offered to him in lieu of payment of arrears of salary<sup>1</sup> due to him, cheerfully undertook the printing of the "Principia" at his own expense, and entered instantly on the duty of editing it with admirable zeal and energy, involving, as it did, expostulations, arguments, and entreaties to Newton not to cut out large parts of the work which he wished to suppress<sup>2</sup> as being too slight and popular, and as being possibly liable to provoke questions of priority. It was well said by Rigaud, in his "Essay on the first publication of the Principia," that "under the circumstances it is hardly possible to form a sufficient estimate of the immense obligation which the world owes in this respect to Halley, without whose great zeal, able management, unwearied perseverance, scientific attainments, and disinterested generosity the 'Principia' might never have been published."<sup>3</sup> Those who know how much worse than "law's delays" are the troubles, cares, and labour involved in bringing through the press a book on any scientific subject at the present day will admire Halley's success in getting the "Principia" published within about a year after the task was committed to him by the Royal Society two hundred years ago.

When Newton's theory of universal gravitation was thus made known to the world Descartes' *Vortices*, an invention supposed to be a considerable improvement on the older invention of crystal cycles and epi-cycles from which it was evolved, was generally accepted, and seems to have been regarded as quite satisfactory by nearly all the philosophers of the day.

The idea that the sun pulls Jupiter, and Jupiter pulls back against the sun with equal force, and that the sun, earth, moon, and planets all act on one another with mutual attractions, seemed to violate the supposed philosophic principle that matter cannot act where it is not. Descartes' doctrine died hard among the mathematicians and philosophers of continental Europe; and for the first quarter of last century belief in universal gravitation was an insularity of our countrymen.

Voltaire, during a visit which he made to England in 1727, wrote: "A Frenchman who arrives in London finds a great alteration in philosophy, as in other things. He left the world full; he finds it empty. At Paris you see the universe composed of vortices of subtle matter; at London we see nothing of the kind. With you it is the pressure of the moon which causes the tides of the sea; in England it is the sea which gravitates towards the moon. . . . You will observe also that the sun, which in France has nothing to do with the business, here comes in for a quarter of it. Among you Cartesians all is done by impulsion: with the Newtonians it is done by an attraction of which we know the cause no better"<sup>4</sup> Indeed, the Newtonian opinions had scarcely any disciples in France till Voltaire asserted their claims on his return from England in 1728. Till then, as he himself says, there were not twenty Newtonians out of England.<sup>5</sup>

In the second quarter of the century sentiment and opinion in France, Germany, Switzerland, and Italy experienced a great change. "The mathematical prize questions proposed by the French Academy naturally brought the two sets of opinions into conflict." A Cartesian memoir of John Bernoulli was the one which gained the prize in 1730. It not infrequently happened that the Academy, as if desirous to show its impartiality,

<sup>1</sup> It is recorded in the Minutes of Council that the arrears of salary due to Hooke and Halley were resolved to be paid by copies of Willughby's work. Halley appears to have assented to this unusual proposition, but Hooke wisely "desired six months' time to consider of the acceptance of such payment."

<sup>2</sup> The publication of the "Historia Piscium," in an edition of 500 copies, cost the Society £400. It is worthy of remark, as illustrative of the small sale which scientific books met with in England at this period, that a considerable time after the publication of Willughby's work, Halley was ordered by the Council to endeavour to effect a sale of several copies with a bookseller at Amsterdam, as appears in a letter from Halley requesting Boyle, then at Rotterdam, to do all in his power to give publicity to the book. When the Society resolved on Halley's undertaking to measure a degree of the earth, it was voted that "he be given £50 or fifty 'Books of Fishes.'" (Weld's "History of the Royal Society," vol. i. p. 310.)

<sup>3</sup> "The third [book] I now design to suppress. Philosophy is such an impertinently litigious lady that a man had as good be engaged in lawsuits as have to do with her. I found it so formerly, and now I am no sooner come near her again but she gives me warning. The first two books without the third will not so well bear the title of 'Philosophiæ Naturalis Principia Mathematica,' and therefore I have altered it to this, 'De Motu Corporum Libri duo'; but, upon second thoughts, I retain the former title. 'Twill help the sale of the book, which I ought not to diminish now 'tis yours.'" (*Ibid.*, p. 311.)

<sup>4</sup> *Ibid.*, p. 310.

<sup>5</sup> Whewell's "History of the Inductive Sciences," vol. ii. pp. 202-203.

<sup>6</sup> *Ibid.*, vol. ii. p. 201.

<sup>1</sup> Whewell's "History of the Inductive Sciences," vol. ii. p. 77.

divided the prize between Cartesians and Newtonians. Thus, in 1734, the question being the cause of the inclination of the orbits of the planets, the prize was shared between John Bernoulli, whose memoir was founded on the system of vortices, and his son Daniel, who was a Newtonian. The last act of homage of this kind to the Cartesian system was performed in 1740, when the prize on the question of the tides was distributed between Daniel Bernoulli, Euler, Maclaurin, and Cavalleri; the last of whom had tried to amend and patch up the Cartesian hypothesis on this subject.<sup>1</sup>

On February 4, 1744, Daniel Bernoulli wrote as follows to Euler: "Uebrigens glaube ich, dass der Aether sowohl *gravis versus solem*, als die Luft versus terram sey, und kann Ihnen nicht bergen, dass ich über diese Punkte ein völliger Newtonianer bin, vnd verwundere ich mich, dass sie den Principiis Cartesianis so lang adhariren: es möchte wohl einige Pas-ion vielleicht mit unterlaufen. Hat Gott können eine *animam*, deren Natur uns unbegreiflich ist, erschaffen, so hat er auch können eine attractionem universalem materiae imprimiren, wen gleich solche *tractio supra caput* ist, da hingegen die Principia Cartesiania allezeit *contra caput* etwas involviren."

Here the writer, expressing wonder that Euler had so long adhered to the Cartesian principles, declares himself a thoroughgoing Newtonian, not merely in respect to gravitation *versus* vortices, but in believing that matter may have been created simply with the law of universal attraction without the aid of any gravific medium or mechanism. But in this he was more Newtonian than Newton himself.

Indeed Newton was not a Newtonian, according to Daniel Bernoulli's idea of Newtonianism, for in his letter to Bentley to date February 25, 1792,<sup>2</sup> he wrote: "That gravity should be innate, inherent, and essential to matter, so that one body may act upon another at a distance through a vacuum without the mediation of anything else, by and through which their action and force may be conveyed from one to another, is to me so great an absurdity that I believe no man who has in philosophical matters a competent faculty of thinking can ever fall into it." Thus Newton, in giving out his great law, did not abandon the idea that matter cannot act where it is not. In respect, however, of merely philosophic thought, we must feel that Daniel Bernoulli was right; we can conceive the sun attracting Jupiter, and Jupiter attracting the sun, without any intermediate medium, if they are ordered to do so. But the question remains, Are they so ordered? Nevertheless, I believe all, or nearly all, his scientific contemporaries agreed with Daniel Bernoulli in answering this question affirmatively. Very soon after the middle of the eighteenth century Father Boscovich<sup>3</sup> gave his brilliant doctrine (if infinitely improbable theory) that elastic rigidity of solids, the elasticity of compressible liquids and gases, the attractions of chemical affinity and cohesion, the forces of electricity and magnetism—in short, all the properties of matter except heat, which he attributed to a sulphurous fermenting essence—are to be explained by mutual attractions and repulsions; varying solely with distances, between mathematical points endowed also, each of them, with inertia. Before the end of the eighteenth century the idea of action-at-a-distance through absolute vacuum had become so firmly established, and Boscovich's theory so unqualifiedly accepted as a reality, that the idea of gravitational force or electric force or magnetic force being propagated through and by a medium seemed as wild to the naturalists and mathematicians of 100 years ago as action-at-a-distance had seemed to Newton and his contemporaries 100 years earlier. But a retrogression from the eighteenth century school of science set in early in the nineteenth century.

Faraday, with his curved lines of electric force, and his dielectric efficiency of air and of liquid and solid insulators, resuscitated the idea of a medium through which, and not only through which but *by* which, forces of attraction or repulsion, seemingly acting at a distance, are transmitted. The long struggle of the first half of the eighteenth century was not merely on the question of a medium to serve for gravific mechanism, but on the correctness of the Newtonian law of gravitation as a matter of fact however explained. The corresponding controversy in the nineteenth century was very short, and it soon became obvious that Faraday's idea of the transmission of electric

force by a medium not only did not violate Coulomb's law of relation between force and distance, but that, if real, it must give a thorough explanation of that law.<sup>1</sup> Nevertheless, after Faraday's discovery<sup>2</sup> of the different specific inductive capacities of different insulators, twenty years passed before it was generally accepted in continental Europe. But before his death, in 1867, he had succeeded in inspiring the rising generation of the scientific world with something approaching to faith that electric force is transmitted by a medium called ether, of which, as had been believed by the whole scientific world for forty years, light and radiant heat are transverse vibrations. Faraday himself did not rest with this theory for electricity alone. The very last time I saw him at work in the Royal Institution was in an underground cellar, which he had chosen for freedom from disturbance; and he was arranging experiments to test the time of propagation of magnetic force from an induction coil through a distance of many yards to a fine steel needle polished to reflect light; but no result came from those experiments. About the same time, or soon after, certainly not long before the end of his working time, he was engaged (I believe at the shot tower near Waterloo Bridge on the Surrey side) in efforts to discover relations between gravity and magnetism, which also led to no result.

Absolutely nothing has hitherto been done for gravity either by experiment or observation towards deciding between Newton and Bernoulli as to the question of its propagation through a medium, and up to the present time we have no light, even so much as to point a way for investigation, in that direction. But for electricity and magnetism, Faraday's anticipations and Clerk-Maxwell's splendidly developed theory have been established on the sure basis of experiment by Hertz's work, of which his own most interesting account is this year presented to the world in the German and English volumes to which I have referred. It is interesting to know, as Hertz explains in his introduction, and it is very important in respect to the experimental demonstration of magnetic waves to which he was led, that he began his electric researches in a problem happily put before him thirteen years ago by Prof. von Helmholtz, of which the object was to find by experiment some relation between electromagnetic forces and dielectric polarisation of insulators, without, in the first place, any idea of discovering a progressive propagation of those forces through space.

It was by sheer perseverance in philosophical experimenting that Hertz was led to discover a finite velocity of propagation of electromagnetic action, and then to pass on to electromagnetic waves in air and their reflection, and to be able to say, as he says in a short reviewing sentence at the end of his eighth paper: "Certainly it is a fascinating idea that the processes in air which we have been investigating, represent to us on a million-fold larger scale the same processes which go on in the neighbourhood of a Fresnel mirror, or between the glass plates used for exhibiting Newton's rings."

Prof. Oliver Lodge has done well in connection with Hertz's work, to call attention<sup>3</sup> to old experiments, and ideas taken from them, by Joseph Henry, which came more nearly to an experimental demonstration of electromagnetic waves than anything that had been done previously. Indeed, Henry, after describing experiments showing powerful enough induction due to a single spark from the prime conductor of an electric machine to magnetise steel needles at a distance of thirty feet in a cellar beneath with two floors and ceilings intervening, says that he is "disposed to adopt the hypothesis of an electrical plenum," and concludes with a short reviewing sentence: "It may be further inferred that the diffusion of motion in this case is almost comparable with that of a spark from a flint and steel in the case of light."

Prof. Oliver Lodge himself did admirable work in his investigations with reference to lightning rods,<sup>4</sup> coming very near to experimental demonstrations of electromagnetic waves; and he drew important lessons regarding "electrical surges" in an insulated bar of metal "induced by Maxwell's and Heaviside's electromagnetic waves," and many other corresponding phenomena manifested both in ingenious and excellent experiments devised by himself and in natural effects of lightning.

Of electrical surges or waves in a short insulated wire, and

<sup>1</sup> "Electrostatics and Magnetism," Sir W. Thomson, Arts. I. (1842) and II. (1845), particularly § 25 of Art. II.

<sup>2</sup> 1837, "Experimental Researches," 1161-1306.

<sup>3</sup> "Modern Views of Electricity," pp. 369-372.

<sup>4</sup> "Lightning Conductors and Lightning Guards," Oliver J. Lodge, F.R.S. Whittaker and Co.

<sup>1</sup> Whewell's "History of the Inductive Sciences," vol. ii. pp. 198, 199.  
<sup>2</sup> "The Correspondence of Richard Bentley, B.D.," vol. i. p. 70.  
<sup>3</sup> "Theoria Philosophicæ Naturalis redacta ad unicam legem virium in natura existentium auctore P. Rog-rio Josepho Boscovich, Societatis Jesu," 1st edition, Vienna, 1755; 2nd edition, amended and extended by the author, Venice, 1763.

of interference between ordinary and reflected waves, and positive electricity appearing where negative might have been expected, we hear first, it seems, in Herr von Bezold's "Researches on the Electric Discharge" (1870), which Hertz gives as the third paper of his collection, with interesting and ample recognition of its importance in relation to his own work.

In connection with the practical development of magnetic waves, you will, I am sure, be pleased if I call your attention to two papers by Prof. G. F. Fitzgerald, which I heard myself at the meeting of the British Association at Southport in 1883. One of them is entitled "On a Method of Producing Electromagnetic Disturbances of comparatively Short Wave-lengths." The paper itself is not long, and I shall read it to you in full, from the "Report of the British Association," 1883: "This is by utilising the alternating currents produced when an accumulator is discharged through a small resistance. It is possible to produce waves of as little as two metres wave-length, or even less." This was a brilliant and useful suggestion. Hertz, not knowing of it, used the method; and, making as little as possible of the "accumulator," got waves of as little as 10 cm. wave-length in many of his fundamental experiments. The title alone of Fitzgerald's other paper, "On the Energy Lost by Radiation from Alternating Currents," is in itself a valuable lesson in the electromagnetic theory of light, or the undulatory theory of magnetic disturbance. It is interesting to compare it with the title of Hertz's eleventh paper, "Electric Radiation"; but I cannot refer to this paper without expressing the admiration and delight with which I see the words "rectilinear propagation," "polarisation," "reflection," "refraction," appearing in it as sub-titles.

During the fifty-six years which have passed since Faraday first offended physical mathematicians with his curved lines of force, many workers and many thinkers have helped to build up the nineteenth century school of *plenum*; one ether for light, heat, electricity, magnetism; and the German and English volumes containing Hertz's electrical papers, given to the world in the last decade of the century, will be a permanent monument of the splendid consummation now realised.

But, splendid as this consummation is, we must not fold our hands and think or say there are no more worlds to conquer for electrical science. We do know something now of magnetic waves. We know that they exist in nature, and that they are in perfect accord with Maxwell's beautiful theory. But this theory teaches us nothing of the actual motions of matter constituting a magnetic wave. Some definite motion of matter perpendicular to the lines of alternating magnetic force in the waves and to the direction of propagation of the action through space, there must be; and it seems almost satisfactory as a hypothesis to suppose that it is chiefly a motion of ether with a comparatively small but not inconsiderable loading by fringes of ponderable molecules carried with it. This makes Maxwell's "electric displacement" simply a to-and-fro motion of ether across the line of propagation, that is to say, precisely the vibrations in the undulatory theory of light according to Fresnel. But we have as yet absolutely no guidance towards any understanding or imagining of the relation between this simple and definite alternating motion, or any other motion or displacement of the ether, and the earliest known phenomena of electricity and magnetism—the electrification of matter, and the attractions and repulsions of electrified bodies; the permanent magnetism of lodestone or steel, and the attractions and repulsions due to it; and certainly we are quite as far from the clue to explaining, by ether or otherwise, the enormously greater forces of attraction and repulsion now so well known after the modern discovery of electromagnetism.

Fifty years ago it became strongly impressed on my mind that the difference of quality between vitreous and resinous electricity, conventionally called positive and negative, essentially ignored as it is in the mathematical theories of electricity and magnetism with which I was then much occupied (and in the whole science of magnetic waves as we have it now), must be studied if we are to learn anything of the nature of electricity and its place among the properties of matter. This distinction, essential and fundamental as it is in frictional electricity, electro-chemistry, thermo-electricity, pyro-electricity of crystals, and piezo-electricity of crystals, had been long observed in the old known beautiful appearances of electric glow and brushes and sparks from points and corners on the conductors of ordinary electric machines and in exhaustive receivers of air-pumps with electricity passed through them. It was also known, probably

as many as fifty years ago, in the vast difference of behaviour of the positive and negative electrodes of the electric arc lamp. Faraday gave great attention to it<sup>1</sup> in experiments and observations regarding electric sparks, glows, and brushes, and particularly in his "dark discharge" and "dark space" in the neighbourhood of the negative electrode in partial vacuum. In [1523] of his 12th series, he says, "The results connected with the different conditions of positive and negative discharge will have a far greater influence on the philosophy of electrical science than we at present imagine." His "dark discharge" ([1544-1554]) through space around or in front of the negative electrode was a first instalment of modern knowledge in that splendid field of experimental research which, fifteen years later, and up to the present time, has been so fruitfully cultivated by many of the able scientific experimenters of all countries.

The Royal Society's Transactions and Proceedings of the last years contain, in the communications of Gassiot,<sup>2</sup> Andrews and Tait,<sup>3</sup> Cromwell Varley,<sup>4</sup> De La Rue and Müller,<sup>5</sup> Spottiswoode,<sup>6</sup> Moulton,<sup>7</sup> Plücker,<sup>8</sup> Crookes,<sup>9</sup> Grove,<sup>10</sup> Robinson,<sup>11</sup> Schuster,<sup>12</sup> J. J. Thomson,<sup>13</sup> and Fleming,<sup>14</sup> almost a complete history of the new province of electrical science which has grown up largely in virtue of the great modern improvements in practical methods for exhausting air from glass vessels, by which we now have "vacuum tubes" and bulbs containing less than 1/190,000 of the air which would be left in them by all that could be done in the way of exhausting (supposed to be down to 1 mm. of mercury) by the best air-pump of fifty years ago. A large part of the fresh discoveries in this province have been made by the authors of these communications, and their references to the discoveries of other workers very nearly complete the history of all that has been done in the way of investigating the transmission of electricity through highly rarefied air and gases since the time of Faraday.

Varley's short paper of 1871, which, strange to say, has lain almost or quite unperceived in the Proceedings during the twenty-two years since its publication, contains an admirable first instalment of discovery in a new field—the molecular torrent from the "negative pole," the control of its course by a magnet, its pressure against either end of a pivoted vane of mica according as it is directed by a magnet to one end or the other, the shadow produced by its interception by a mica screen. Quite independently of Varley, and not knowing what he had done, Crookes was led to the same primary discovery, not by accident, and not merely by experimental skill and acuteness of observation. He was led to it by carefully designed investigation, starting with an examination of the cause of irregularities which had troubled<sup>15</sup> him in his weighing of thallium; and, going on to trials for improving Cavendish's gravitational measurement, in the course of which he discovered that the seeming attraction by heat is only found in air of greater than 1/1000<sup>16</sup> of ordinary density; and that there is repulsion increasing to a maximum when the density is decreased from 1/1000 to 36/1,000,000, and thence diminishing towards zero as the rarefaction is farther extended to density 1/20,000,000. From this discovery Crookes came to his radiometer, first without and then with electrification, powerfully aided by Sir George Stokes.<sup>17</sup> As he went on he brought all his work more and more into touch with the kinetic theory of gases; so much so that when he discovered the molecular torrent he

<sup>1</sup> "Experimental Researches," Series 12 and 13, Jan. and Feb. 1832.

<sup>2</sup> Roy. Soc. Proc., vol. 10, 1860, pp. 36, 269, 274, 432.

<sup>3</sup> Roy. Soc. Proc., vol. 10, 1860, p. 274; Phil. Trans.

<sup>4</sup> Roy. Soc. Proc., vol. 19, 1871, p. 236.

<sup>5</sup> Roy. Soc. Proc., vol. 25, 1875, p. 356; vol. 26, 1877, p. 519; vol. 27, 1878, p. 374; vol. 29, 1879, p. 231; vol. 35, 1883, p. 292; vol. 36, 1884, pp. 151, 206; Phil. Trans., 1878, pp. 55, 155; 1880, p. 65; 1883, 477.

<sup>6</sup> Roy. Soc. Proc., vol. 23, 1875, pp. 356, 455; vol. 25, 1875, pp. 73, 547; vol. 26, 1877, pp. 90, 323; vol. 27, 1878, p. 60; vol. 29, 1879, p. 21; vol. 30, 1880, p. 302; vol. 32, 1881, pp. 383, 388; vol. 33, 1882, p. 423; Phil. Trans., 1878, pp. 163, 210; 1879, 165; 1880, p. 501.

<sup>7</sup> Roy. Soc. Proc., vol. 29, 1879, p. 21; vol. 30, 1880, p. 302; vol. 32, 1881, pp. 385, 388; vol. 33, 1882, p. 453; Phil. Trans., 1879, p. 165, 1880, p. 561.

<sup>8</sup> Roy. Soc. Proc., vol. 10, 1860, p. 256.

<sup>9</sup> Roy. Soc. Proc., vol. 25, 1879, pp. 347, 477; Phil. Trans., 1879, p. 641; 1880, p. 135; 1881, 387.

<sup>10</sup> Roy. Soc. Proc., vol. 32, 1878, p. 181.

<sup>11</sup> Roy. Soc. Proc., vol. 12, 1862, p. 202.

<sup>12</sup> Roy. Soc. Proc., vol. 37, 1884, pp. 78, 317; vol. 42, 1887, p. 371; vol. 47, 1890, pp. 309, 509.

<sup>13</sup> Roy. Soc. Proc., vol. 42, 1887, p. 343; vol. 49, 1891, p. 84.

<sup>14</sup> Roy. Soc. Proc., vol. 47, 1890, p. 118.

<sup>15</sup> Tribulation, not undisturbed progress, gives life and soul and leads to success when success can be reached, in the struggle for natural knowledge.

<sup>16</sup> Crookes, "On the Viscosity of Gases at High Exhaustions," § 655, Phil. Trans., February, 1884, p. 473.

<sup>17</sup> Phil. Trans., vol. 172 (1881), pp. 387, 435.

immediately gave it its true explanation—molecules of residual air, or gas, or vapour projected at great velocities<sup>1</sup> by electric repulsion from the negative electrode. This explanation has been repeatedly and strenuously attacked by many other able investigators, but Crookes has defended<sup>2</sup> it, and thoroughly established it by what I believe is irrefragable evidence of experiment. Skilful investigation perseveringly continued brought out more and more of wonderful and valuable results: the non-importance of the position of the positive electrode; the projection of the torrent *perpendicularly* from the surface of the negative electrode; its convergence to a focus and divergence thenceforward when the surface is slightly convex; the slight but perceptible repulsion between two parallel torrents due, according to Crookes, to negative electrifications of their constituent molecules; the change of direction of the molecular torrent by a neighbouring magnet; the tremendous heating effect of the torrent from a concave electrode when glass, metal, or any ponderable substance is placed in the focus; the phosphorescence produced on a plate coated with sensitive paint by a molecular torrent skirting along it; the brilliant colours—turquoise-blue, emerald, orange, ruby-red—with which grey colourless objects and clear colourless crystals glow on their struck faces when lying separately or piled up in a heap in the course of a molecular torrent; “electrical evaporation” of negatively electrified liquids and solids; the seemingly red-hot glow, but with no heat conducted inwards from the surface, of cool, solid silver kept negatively electrified in a vacuum of 1,000,000 of an atmosphere, and thereby caused to rapidly evaporate. This last-mentioned result is almost more surprising than the phosphorescent glow excited by molecular impacts in bodies not rendered perceptibly phosphorescent by light. Both phenomena will surely be found very telling in respect to the molecular constitution of matter and the origination of thermal radiation, whether visible as light or not. In the whole train of Crookes’ investigations on the radiometer, the viscosity of gases at high exhaustions, and the electric phenomena of high vacuums, ether seems to have nothing to do except the humble function of showing to our eyes something of what the atoms and molecules are doing. The same confession of ignorance must be made with reference to the subject dealt with in the important researches of Schuster and J. J. Thomson on the passage of electricity through gases. Even in Thomson’s beautiful experiments showing currents produced by circuital electromagnetic induction in complete poleless circuits, the presence of molecules of residual gas or vapour seems to be *the essential*. It seems certainly true that without the molecules there could be no current, and that without the molecules electricity has no meaning. But in obedience to logic I must withdraw one expression I have used. We must not imagine that “presence of molecules is *the essential*.” It is certainly *an essential*. Ether also is certainly *an essential*, and certainly has more to do than merely to telegraph to our eyes to tell us of what the molecules and atoms are about. If a first step towards understanding the relations between ether and ponderable matter is to be made, it seems to me that the most hopeful foundation for it is knowledge derived from experiment on electricity in high vacuum; and if, as I believe is true, there is good reason for hoping to see this step made, we owe a debt of gratitude to the able and persevering workers of the last forty years who have given us the knowledge we have: and we may hope for more and more from some of themselves and from others encouraged by the fruitfulness of their labours to persevere in the work.

The President then presented the medals awarded by the Society as follows:—The Copley Medal to Sir George Gabriel Stokes, Bart., F.R.S., for his researches and discoveries in physical science; a Royal Medal to Prof. A. Schuster, F.R.S., for his spectroscopic inquiries, and his researches on disruptive discharge through gases and on terrestrial magnetism; a Royal Medal to Prof. H. Marshall Ward, F.R.S., for his researches into the life-history of fungi and schizomycetes; and the Davy Medal to Prof. J. H. van’t Hoff and Dr. J. A. Le Bel, in recognition of their introduction of the theory of asymmetric carbon, and its use in explaining the constitution of optically active carbon compounds.

In the evening the Fellows and their friends dined together at the Whitehall Rooms, Hôtel Métropole.

<sup>1</sup> Probably, I believe, not greater in any case than two or three kilometres per second.

<sup>2</sup> Address to the Institute of Telegraphic Engineers, 189.

<sup>3</sup> Roy. Soc. Proc., June 11, 1891.

### THE TEMPERATURE OF IGNITION OF EXPLOSIVE GASEOUS MIXTURES.

AN important contribution to our knowledge of this subject is communicated to the *Berichte* by Prof. Victor Meyer of Heidelberg, in conjunction with his assistant, Herr A. Münch. The interesting experiments which were carried out some eighteen months ago in the Heidelberg laboratory, concerning the conditions under which the explosion or silent combination of gaseous mixtures occurs, left the question of the precise temperatures of explosive combination undetermined, inasmuch as the necessary high temperatures were attained by the use of boiling salts whose temperatures of ebullition lay a considerable number of degrees apart. The researches have since been continued under conditions in which it has been found possible to determine the actual temperatures with precision. In these experiments any possibility of the occurrence of appreciable amounts of silent combination has been avoided, in order that the determinations of the temperature of explosive combination might be unaffected by errors due to that cause. The conspicuous novelty of the method adopted consists in placing the small bulb containing the mixture to be exploded inside the larger bulb of the air thermometer employed to determine the temperature, thus at once ensuring that the explosion bulb and the thermometer bulb shall be heated to precisely the same temperature. The objection which at first suggests itself, that the heat suddenly developed at the moment of explosion might exert a disturbing influence upon the indications of the air thermometer, was proved, by direct and repeated experiment to be without validity, such disturbance being found to be too small to be measured. The bulb in which the explosion is brought about is not closed, for the explosion of such detonating mixtures of gases at rest, that is to say, confined to a closed space, is so violent that if the glass escapes pulverisation it is much distorted, owing to the temperature to which it requires to be heated being about its softening point. The distortion usually takes the form of a shrinking from two opposite points, where the glass is drawn in and distended to such an extent as to produce two internal spheres. Such deformation would of course alter considerably the volume of the air thermometer. This is avoided by attaching a long stem to the bulb, open at the free extremity, and of passing a slow current of the gaseous mixture through the apparatus. The bulb of the thermometer was heated by means of a bath of a fused alloy consisting of equal parts of tin and lead, and it was found immaterial whether the thermometer was directly immersed in the molten metal or protected by means of a closely-fitting refractory metal sheath. The estimation of the temperature was effected by displacing the air of the thermometer, whose volume was known, by means of a current of hydrochloric acid gas, and measuring its volume over distilled water which had recently been freed from air by boiling.

The first series of experiments were made with the detonating electrolytic mixture of hydrogen and oxygen. The gases were freed from ozone by passage through a solution of potassium iodide. They were then washed through water, with which a Woulfe’s bottle was almost filled, after which they traversed a tube packed with numerous discs of brass gauze, which were found effectual in preventing the explosion from travelling back to the Woulfe’s bottle. The mixed gases were then allowed to enter the explosion bulb by means of a capillary tube passing down the stem to the bottom of the bulb. The rapidity of the gaseous stream was found to exert no influence upon the temperature of explosion, within the limits imposed by the mode of experimenting. The bath was then gradually raised to the neighbourhood of the combining temperature, and the instant the explosion ensued the air contained in the thermometer was displaced by hydrogen chloride, collected over water in the measuring vessel, and its volume ascertained on the attainment of atmospheric temperature and pressure. By displacing the air the instant the detonation was heard, any appreciable augmentation of the temperature during the moment of explosion was prevented.

As the result of several series of experiments carried out with four distinct sets of apparatus, the temperature of explosion of electrolytic hydrogen and oxygen is found to vary from 612° to 686°. It would thus appear, conformable with the supposition of Prof. Van t’Hoff from theoretical considerations, that this mixture is incapable of exhibiting a sharply fixed temperature of explosion. Moreover, it makes no difference whether the mixture is dry or moist; for if dried a small amount of silent

combination invariably renders it again moist before explosion occurs.

It has been currently supposed that the presence of sharp solid fragments, such as those of glass, exerts a lowering effect upon the temperature of explosion of hydrogen and oxygen. This supposition has been practically tested and found wanting in accuracy. Neither glass fragments nor sea-sand were found to reduce the temperature below the limits above stated. A remarkable result, however, was obtained when pieces of platinum foil and wire were introduced into the explosion bulb. It was found impossible in their presence to bring about an explosion, even when the temperature of the bath was raised to 715°. Quiet combination invariably ensued.

The size of the explosion vessel appears to be immaterial, except when reduced to very small dimensions, such as 4.5 mm. diameter, as in the case of the smallest bulb tested, when the range of molecular forces is approached. In six experiments with this small bulb no explosion occurred; in others the explosion did not occur in the vessel, but the quiet combustion there initiated was transmitted along the leading tube, through the tube containing the brass gauze discs, and eventually occasioned an explosion in the wash-bottle, disastrous to the latter.

In the cases of other explosive mixtures the admixture was effected, in the proper proportion, in a three litre flask, from which the gases were driven first through a wash-bottle, and subsequently through a test-tube, arranged likewise as a small safety wash-bottle, to prevent the explosion reaching the larger one.

Carbon monoxide and oxygen, in the proportion to form carbon dioxide, were found to suffer, for the most part, silent combination in the apparatus, and the wide limits of the observed temperatures of explosion, 636° to 814°, in those cases when explosion did ensue, were found to be due to more or less of such silent combination.

Gaseous mixtures of hydrocarbons and oxygen were found, however, with the exception perhaps of marsh gas and oxygen, to exhibit practically no quiet combination; and these mixtures have afforded most trustworthy and constant temperatures of explosion.

Marsh gas was found to explode, as a rule, with oxygen at temperatures varying from 656° to 678°, but occasionally quiet and complete combustion occurred. Other hydrocarbons never failed to yield an explosion.

Ethane detonated with oxygen in three experiments at 622°, 605°, and 622° respectively. A mixture of ethylene and oxygen exploded at 577°, 590°, and 577° in three consecutive experiments. Acetylene prepared by Gattermann's method, which in Prof. Meyer's experience yields it in a purer state than the more recent convenient method discovered by Maquenne, explodes with oxygen with exceptional violence, the wash-bottle being destroyed in every experiment. The temperature of this explosion was very constant, 510°, 515°, and 509° being successively observed. Propane mixed with five times its volume of oxygen likewise exhibits a very constant temperature of ignition, 548°, 545°, and 548° being indicated in three determinations. Propylene exploded with four and a half times its volume of oxygen at 497°, 511°, and 499°. Isobutane mixed with six and a half times its volume of oxygen detonated at 549°, 550°, and 545°; and isobutylene at 546°, 548°, and 537°. Finally, coal gas mixed with thrice its volume of oxygen was found to explode in three experiments at the remarkably constant temperatures of 649°, 647°, and 647°. It was found impossible, however, to induce a mixture of coal gas and air to explode under these experimental conditions.

It will be clearly seen from the above experiments with gaseous mixtures of hydrocarbon and oxygen, that the temperature of explosion falls as the content of carbon increases. Thus the mean temperatures for methane, ethane and propane are 667°, 616°, and 547° respectively. Further, the temperature also falls with the degree of saturation, or in other words, the less saturated the hydrocarbons become the more readily do they ignite in contact with oxygen. Thus ethane, ethylene and acetylene explode with oxygen at 616°, 580° and 511°; propane and propylene at 547° and 504°; and isobutane and isobutylene at 548° and 543°. It will also be observed, however, as would be expected, that these differences due to difference of saturation diminish as the series are ascended.

A. E. TUTTON.

#### UNIVERSITY AND EDUCATIONAL INTELLIGENCE.

CAMBRIDGE.—Mr. Austen Leigh, Provost of King's, the Vice-Chancellor, has been appointed a member of the Geographical Committee, in the place of Dr. Ferrers, resigned. The award of the Geographical Studentship of £100 will be made towards the end of the Lent Term.

The first award of the Walsingham Medal, founded by the Lord Iligh Steward for the encouragement of biological research, has been made to Mr. E. W. MacBride, Fellow of St. John's, for his monographs in zoology.

MR. ARTHUR WILLEY, at present giving a course of lectures in Columbia College, New York, has been elected to the vacant Balfour Studentship by the Special Board of Biological and Geological Studies of the University of Cambridge. It is understood that the investigation prescribed for him will be that of the embryology of *Nautilus pompilius*, for which purpose he will proceed to the South Seas.

#### SCIENTIFIC SERIALS.

*The Quarterly Journal of Microscopical Science* for September, 1893, contains studies on the comparative anatomy of sponges: V. Observations on the structure and classification of the *Calcarea heterocæla*, by Dr. Arthur Dendy (plates 10-14). In this paper the author gives a general account of the anatomy, histology, and classification of the *Calcarea heterocæla*, from the point of view of one who has for a long time past been engaged in an independent study of the group, and he brings together all that is known on the subject. While on the classification of the group he departs somewhat widely from the lines laid down by previous writers, yet the necessity of doing so was forced upon him by a study of nearly fifty Australian species. The author finds neither the canal system nor the skeleton affords a reliable guide for classification, and a compromise is the only satisfactory way out of the difficulty. The families adopted are: (1) Leucasidæ, (2) Syctetidæ, (3) Grantidæ, (4) Heteropidæ, (5) Amphoriscidæ. — On some points in the origin of the reproductive elements in *Apus* and *Branchipus*, by J. E. S. Moore (plates 15 and 16). Calls attention to some important details in the spermatogenesis of *Branchipus* and in the oögenesis in *Apus*. In the former, the observations bear out the general law as to the similarity of the male and female cells, their specific peculiarities being physiological in origin, without morphological import. The divisional phenomena of these cells are intimately related to a protoplasmic structure, which might be fitly described as "Schaumplasma," and one of the initial impulses towards metamorphosis is a fusion of some of the intra-nuclear globules; while a considerable portion of the complicated karyokinetic figures, with their centrosomes, pseudosomes, and dictyosomes, appear to be the logical as well as the actual consequence of the continuance of this process. Some time before and always during the course of the chromatic changes bodies answering to the centrosomes in all details except in their numbers, which is much greater, make their appearance; these the author provisionally names "pseudosomes." The term "dictyosomes" is given to bodies which make their appearance connected one to another and to the inner group of chromosomes by fine strands, and which remain uncoloured by reagents, and are more or less related to the cell periphery. (In connection with these, Farmer's notes and figures of like bodies in the Pollen mother-cells is of interest. (See *Ann. of Bot.* September, 1893). — Notes on the *Peripatus* of Dominica, by E. C. Pollard (plate 17). Miss Pollard's species is apparently very nearly related to *P. edwardsii*, but differs in the number of ambulatory appendages, there being 29 to 34 pairs in *P. edwardsii*, while in *P. dominica*, sp. nov., there are from 25 to 30. — Studies on the Protochordata, by Arthur Wiley, B.Sc. (plates 18-20). II. The development of the neuro-hypophysial system in *Ciona intestinalis* and *Clavelina lepadiformis*, with an account of the origin of the sense-organs in *Ascidia mentula*. III. On the position of the mouth in the larvæ of the Ascidiæ and Amphioxus, and its relations to the Neuroporus.

*Symons's Monthly Meteorological Magazine*, November. Mr. Symons gives a summary of all the rainfall observations known to have been taken in Persia; the only places at which such appear to have been made are Ooromiah, in the north-

west; Bushire, on the eastern shore of the Persian Gulf, and at Teheran. At Bushire the annual mean for 1878-90 is 12.96 inches. Recent observations at Teheran give a mean of about 10 inches, and the older observations, taken at the Russian Embassy, give a mean of about 11 inches, of which nearly the whole falls in the winter half of the year. To the north of the great mountain range, between Teheran and the Caspian, the fall is nearly four times as great as in Persia. The same number of the magazine contains a summary of the few meteorological papers read at the British Association at Nottingham.

## SOCIETIES AND ACADEMIES.

LONDON.

Royal Society, November 16.—“Experiments in Heliotropism.” By G. J. Romanes, F.R.S.

I cannot find in the literature of heliotropism that any experiments have hitherto been made on the effects of interrupted illumination, when the periods of illumination are rendered as brief as possible—*i.e.*, instantaneous flashes of light. Accordingly I have conducted an extensive research on heliotropism, where the flashes have been caused either by means of electric sparks in a dark room, or by the opening of a photographic shutter placed before the plants in a camera obscura with an arc light or Swan burner, at a distance of several feet on the other side of the shutter. The electric sparks were made either with a Wimshurst machine, induction sparks, or by means of the following contrivance. From the binding screws of the condenser of a large induction coil copper wires were led to a cup of mercury, where, by means of an electro-magnet suitably actuated by clockwork, a current was closed and opened at any desired intervals: each break was therefore accompanied by a brilliant spark. A thick plate of glass was interposed between the seedlings and the electrical apparatus. In all the experiments here described the plants employed were mustard seedlings (*Sinapis nigra*), previously grown in the dark until they had reached a height of between one and two inches. Save when the contrary is stated, in all the experiments comparative estimates were formed by using the same pot of seedlings: during the first half of a comparative experiment half of the seedlings were protected from the light by a cap of cardboard covering half the pot; during the second half of the experiment this cap was removed, and the pot turned round so as to expose the previously protected seedlings to the influence of the light. The principal results thus obtained, and frequently corroborated, were as follows:—

I. Even having regard to the fact that for equal strengths of a stimulus excitable tissues are more responsive in proportion to the suddenness of the stimulus (or in a kind of inverse proportion to the duration of the stimulus), the heliotropic effects of such flashing stimulation as is above described proved to be much greater than might have been antecedently expected. This was shown to be the case whether the effects were estimated by the rapidity with which the seedlings began to bend after the flashing stimulation was begun, or by that with which they continued to bend until attaining a horizontal line of growth, *i.e.* bending to a right angle. Thus, at a temperature of 70° Fahr., and in a moist camera, vigorously growing seedlings begin to bend towards the electric sparks ten minutes after the latter begin to pass, and will bend through 45° in as many minutes; frequently they bend through another 45° in as many minutes more. This is a more rapid rate of bending than can be produced in the same pot of seedlings when the previously protected side is uncovered and exposed for similar durations of time, either to constant sunlight or to constant diffused daylight. This is the case even if the sparks (or flashes) succeed one another at intervals of only two seconds.

II. It would thus appear that the heliotropic influence of electric sparks (or flashes) is greater than can be produced by any other source of illumination. But in order to test this point more conclusively, I tried the experiment of exposing one half-pot of seedlings in one camera to the constant light of a Swan burner, and another half-pot of similar seedlings in another camera, placed at the same distance from the same source of light, but provided with a flash shutter working at the rate of two seconds intervals. The amount of bending in similar times having been noted, the pots were then exchanged and their previously protected halves exposed to the constant and the flashing light respectively. In both cases, the rapidity

with which the bending commenced and the extent to which it proceeded in a given time after commencement, were considerably greater in the seedlings exposed to the flashing than to the constant source stimulation. The same is true if, instead of a Swan burner, the source of light is the sun.

III. Many experiments were tried in order to ascertain the smallest number of sparks in a given time which would produce any perceptible bending. Of course the results of such experiments varied to some extent with the condition of the seedlings. But in most cases, with vigorous young mustard seedlings and careful observation, bending could be proved to occur within fifteen to thirty minutes, if bright sparks were supplied at the rate of only one per minute. The most extreme sensitiveness that I have observed in these experiments was that of perceptible bending after half-an-hour's exposure to electrical sparks following one another at the rate of fifty in an hour. This result would appear to indicate that in heliotropism under flashing light there need be no summation or “staircase effect”; but that each flash or spark may produce its own effect independently of its predecessors or successors.

IV. It is noteworthy that, while the heliotropic effects of flashing light are thus so remarkable, they are unattended with the formation of any particle of chlorophyll. In the many hundred pots, and therefore many thousands of plants, which have passed under my observation in this research I have never seen the slightest shade of green tingeing the etiolated seedlings which had bent towards flashing light. On one occasion I kept a stream of 100 sparks per second illuminating some mustard seedlings continuously for forty-eight hours; and although this experiment was made for the express purpose of ascertaining whether any chlorophyll would be formed under the most suitable conditions by means of flashing light, no change of colour in any of the seedlings was produced.

With the exception of those mentioned in the last paragraph, all these results were obtained by using sparks from the coil condenser, as above explained. These sparks were very brilliant, and yielded the maximal results, which alone are here recorded.

“Experiments in Germination.” By G. J. Romanes, F.R.S.

The primary object of these experiments was to ascertain whether the power of germination continues in dry seeds after the greatest possible precautions have been taken to prevent any ordinary processes of respiration for practically any length of time.

The method adopted was to seal various kinds of seeds in vacuum tubes of high exhaustion, and after they had been exposed to the vacuum for a period of fifteen months to remove them from the tubes and sow them in flower-pots buried in moist soil. In other cases, after the seeds had been *in vacuo* for a period of three months, they were transferred to sundry other tubes respectively charged with atmospheres of sundry pure gases or vapours (at the pressure of the air at time of sealing); after a further period of twelve months these sundry tubes were broken, and their contents sown as in previous case. In all cases, excepting that of clover, the seeds sown were weighed individually in chemical balances, and seeds of similar weights taken from the same original packets were similarly sown as controls.

The exhaustion of the tubes was kindly undertaken by Mr. Crookes, F.R.S., to whom I must express my best thanks for the assistance he has given. The kinds of seeds used were mustard, red beet, clover, peas, beans, spinach, cress, barley, and radish. In addition to vacuum tubes and control tubes containing air, others were charged with oxygen, hydrogen, nitrogen, carbon monoxide, sulphuretted hydrogen, aqueous vapour, ether, and chloroform.

With the exception of the beans, where only two were sown, ten weighed seeds were sown out of each of the tubes, and also out of each of the control packets which had been kept in ordinary air from the first. These results amply prove that neither a vacuum of one-millionth of an atmosphere, nor the atmospheres of any of the gases and vapours named, exercised much, if any, effect on the germinating power of any of these seeds. I may add that the same remark applies to an atmosphere of carbon dioxide, although in the particular series of experiments quoted this gas was accidentally omitted.

A subsidiary object of these experiments was to ascertain whether any appreciable variations would be caused in plants grown from seeds which, before germination, had been submitted to the conditions above explained. Hundreds of plants



of the kinds named were grown from the seeds in the various tubes. But in no one instance was there the smallest deviation in any respect from the standard type grown from the corresponding control packet.

In the case of the beet-root, a larger number of plants were developed in many of the pots than the ten seeds which had been sown in each. This I found to be due to the fact that beet-root seeds very frequently throw up two seedlings apiece. Not so frequently, but still very often, they yield three, and sometimes even four.

Further experiments are in progress.

"On hepatic glycogenesis," by Dr. Noël Paton, Superintendent, Research Laboratory of the Royal College of Physicians of Edinburgh.

The object of the research is to determine the mode of conversion of glycogen to sugar in the liver. Is it due to a zymion, or to the metabolism of the liver protoplasm? A study of the rate of conversion of glycogen in the excised liver at the body temperature shows that there is an initial rapid and a subsequent slow stage in the process. The former occurs before visible morphological changes can be detected in the cells; the latter goes on after the cells are disorganised. The former is inhibited by destroying the cells (by pounding with sand), and by the presence of one per cent. of fluoride of sodium; the latter is not stopped thereby. The product of the former is glucose; of the latter, glucose with dextrin and, possibly, maltose. Agents, such as chloroform, ether, and pyrogallic acid, hasten the disintegrative changes in the cells, and accelerate the early rapid stage of conversion, but do not influence the later slower stage. During life the first may produce glycaemia by this action on glycogen conversion. They seem to act by hastening the katabolic changes immediately preceding cellular death. Drugs, such as curare, morphin, and nitrite of amyl, which cause glycaemia, do not do so by increasing the conversion of glycogen; they do not accelerate the morphological changes in the cells. These observations show that the early rapid changes are due to the metabolism of the protoplasm. The later slower changes are not due to the acid which develops, nor are they, to any marked extent, due to the action of micro-organisms; they seem to be brought about by a zymion developed as a result of the disintegration of the cells.

November 23.—"Magnetic Observations in Senegambia." By T. E. Thorpe, F.R.S., and P. L. Gray.

On the occasion of the recent Eclipse Expedition to Senegambia we took with us a set of magnetic instruments of the Kew pattern, with a view of making observations in a district for which the magnetic elements have not hitherto been determined.

Observations were made at Fundium, Senegal, and at Bathurst, on the River Gambia.

The results are as follows:—

Fundium, Senegal, lat. 14° 7' 4" N., long. 16° 32' W. (approx.).

The observations were made on April 4, 5, and 14, 1893, in the vicinity of the Eclipse Camp and on a partially enclosed piece of ground between the Administrator's house and the River Salum, about 80 yards from the shore. The temperature during the force observations was about 30° C.

The results are as follows:—

|                  |     |     |                       |
|------------------|-----|-----|-----------------------|
| Declination      | ... | ... | = 18° 44' W.          |
| Horizontal force | ... | ... | = 0.30409 c.g.s.      |
| Dip              | ... | ... | = Needle 1, 29° 9' 1" |
| "                | ... | ... | " 2, 29° 8' 2"        |

Bathurst, River Gambia, lat. 13° 28' N., long. 16° 37' W.

The station was on a large piece of open ground and near the centre of McCarthy Square. All the observations taken were made on April 20, 1893.

|                  |     |     |                        |
|------------------|-----|-----|------------------------|
| Declination      | ... | ... | = 18° 50' W.           |
| Horizontal force | ... | ... | = 0.30514 c.g.s.       |
| Dip              | ... | ... | = Needle 1, 28° 43' 4" |
| "                | ... | ... | " 2, 28° 42' 1"        |

Physical Society, November 24.—Prof. A. W. Rücker, F.R.S., President, in the chair.—Colonel Maitland, C.B., was elected a member of the Society. Prof. S. P. Thompson then occupied the chair whilst the President read a paper on the magnetic shielding of concentric spherical shells. In this mathematical investigation the author considers cases in which the equipotential surfaces are surfaces of revolution about a line through the centre of the shells, and the per-

meability ( $\mu$ ) of each shell is constant. Taking the common centre as origin, the potential within any shell is expanded in terms of zonal spherical harmonics, and the ratio of the shielded to the unshielded field determined. The following important result is arrived at, viz. if the permeabilities of the enclosed and external space be the same, then the ratios of the shielded to the unshielded fields are the same for each harmonic term, whether the part shielded be external or internal. It is also shown that the shielding effect on external space when a small magnet is placed at the centre of the shell is the same as the shielding effect on the enclosed space when the shells are placed in a uniform magnetic field. The case of a single shell with a small magnet at the centre is next considered where the permeabilities of the internal and external spaces are taken as unity. Here the shielding depends on the ratio of the outer to the inner radius ( $a_1/a_0$ ). When the thickness of the shell is  $1/100$  of  $a_1$  the ratio of shielded to unshielded field ( $\Psi/\Psi_0$ ) is  $3/15$  when  $\mu = 500$ , and  $3/23$  when  $\mu = 1000$ . For  $\mu = 1000$ , increasing the thickness from  $a/10$  to  $a/2$  changes the shielding from  $1/60$  to  $1/194$ , thus showing that after the shell is moderately thick, further increasing the thickness is not very effective. When the small magnet is displaced from the centre of the shell with its axis along a radius, then the shielding effect of the shell is greater on the side towards which the magnet is moved, and less on the opposite side. Thickening a single shell being inefficient, the effect of using two or three shells separated by air-gaps is investigated. Here, as in the case of a single shell, the shielding is improved by adding permeable material either within the inner or without the outer shell. If the inner and outer diameters are given then when the difference in these diameters is small, one continuous shell gives the best result. For a larger difference, two shells separated by an air-gap are much more efficient than a single one, and filling up the air-gap would appreciably diminish the screening effect. When the permeability of the substance is high the best shielding is obtained when the radii of the bounding surfaces of the shells are in geometrical progression. The great value of lamination is shown in the following table, where the volume of the permeable material is expressed in terms of that of the enclosed space, and the shielding in each case being the best.

|              | Volume of material used. | External field. |
|--------------|--------------------------|-----------------|
| Single shell | ... 1.0 ...              | 0.018           |
| Two shells   | ... 5.0 ...              | 0.0006          |
| Three shells | ... 4.8 ...              | 0.00016         |
| Single shell | ... 7.0 ...              | 0.0103          |

The conditions for the best arrangement in each of the following cases are fully worked out in the paper, viz. Two shells when the largest and smallest radii and the volume of the material used are given; two contiguous shells of different permeabilities; and three shells of different permeabilities. The main results of the investigation are that with thin shells lamination is useless, while with thick shells it is essential, if the best effect is desired. Experiments made on actual shells had fully confirmed the theoretical conclusions. Prof. Minchin said the mathematical results were very simply expressed. Although the work was apparently restricted to zonal spherical harmonics, some of the important formulæ apply equally to general spherical harmonics. Referring to the difficulty of shielding by single thick shells, he pointed out that the equation giving the relation between the shielded and unshielded fields with different thicknesses of shell represented a hyperbola with its asymptotes parallel to the axes; hence the shielding tended to a definite limit as the thickness increased indefinitely. Mr. Evershed said he had been engaged for the last two years on the subject of magnetic shielding, with a view to screening measuring instruments from external fields. In such cases it was not possible to use closed shells, and this introduced trouble. The best results he had yet obtained was to reduce the disturbance to about one-fifth. Another difficulty was introduced by the fact of the shields being magnetised by the current passing through the coil, and owing to hysteresis, the permeability was different according as the magnetisation increased or decreased. By using an outer iron shell a great improvement had been effected. To obtain the best results, it was important to have no joints in the shields. A coil frame with two shields of bent iron was exhibited. Mr. J. Swinburne remarked that the subject divided itself into two, shielding of instruments and shielding sources. If a

dynamo itself be shielded, this did not prevent the currents in the leads producing magnetic disturbances. This was very important in ships. By using an alternator with resolving fields all disturbances could be avoided. Dr. C. V. Burton inquired whether by considering the hydrodynamical analogue of a porous material the case of perforated shells could be elucidated? Mr. A. P. Trotter wished to know if the homogeneity of the shield was of much consequence? At Oxford it had been found that a screen of four inches of scrap-iron was better than boiler-plate. Mr. Blakesley asked if the effect of moving a magnet sideways in a sphere had been observed. He thought the mathematics developed in the paper would be useful in working out the magnetic theory of the earth. Prof. S. P. Thompson thought that taking the permeability as constant would not be quite correct, for  $\mu$  was a function of the magnetisation. Hence in the cases considered the outer shell would be the more permeable. In his reply, the President said scrap-iron in contact was not like clear space, for there were comparatively free paths for the induction at the points of contact. As regards the shielding of the dynamo at Greenwich, Mr. Christie had written to say that the credit was due to the makers of the machine and shields, Messrs. Johnson and Phillips.—Prof. G. M. Minchin read a paper on the action of electromagnetic radiation on films containing metallic powders. After noticing the resemblance of the phenomena exhibited by tubes containing metallic filings shown by Mr. Croft, on October 27, to those of photoelectric impulsion cells, he repeated some of the experiments with filings, and found the same effects when the filings were of ordinary fineness. He also noticed that the experiments did not succeed either when the filings were coarse or very fine. Coarse ones always conducted, whilst very fine filings or powders acting as insulators, except when strongly compressed. To establish a closer connection with the impulsion cells he tried films of gelatine and collodion containing metallic powders. Directions for preparing the films are given in the paper. On inserting such a film in circuit with a battery, key, and galvanometer, it acts as an insulator. To render a small portion conducting, the electrodes on the surface of the film are brought very close together, and one of the wires touched with an electrified body (an electric gas-lighter was often used). This caused a current to pass. The electrodes may then be separated a little further, and the process repeated until any desired portion is rendered conducting. The peculiarity of such a film is that if the circuit be broken at the film, the film becomes an insulator; whereas breaking the circuit at any other point leaves the film conducting. The action of the sparks or charges on the conductivity of the films is attributed to the influence of electric surgings in the wires by the electric discharges. The President read a written communication from Prof. O. J. Lodge, in which the writer suggested that the phenomena of the films, and also of Lord Rayleigh's water-jet experiment (in which water-drops are caused to coalesce by the presence of an electrified body), were due to the range of molecular attraction being increased by electric polarisation. Mr. Blakesley said he had tried Mr. Croft's experiments, and found that conductivity could be established in a tube of filings whilst the circuit was unclosed. Breaking the circuit of a transformer or electromagnet would produce conductivity; hence he concluded that electric surgings were not essential. Another curious experiment was to put the discharging knobs of an electric machine on a photographic plate at a distance of a few inches. On turning the machine a small spark travels slowly along the plate from the negative to the positive knob. On reversing the polarity of the machine the spark travels back along the same path, but if the polarity remains unchanged a second spark usually travels along a different path. Prof. C. V. Boys asked Prof. Minchin whether the films themselves, or the contacts between the electrode and film is made conducting by the sparks? Prof. S. P. Thompson wished to know if ordinary photographic dry-plates would serve the purpose? Mr. Evershed inquired whether the metal used as electrode made any difference? Prof. Minchin, in his reply, maintained that the phenomena were due to electric impulses. He had not tried photographic plates, and had always used platinum for his electrodes.

Chemical Society, November 16.—Dr. Armstrong, President, in the chair.—A letter has been addressed to Prof. Mendeléeff, congratulating the Russian Chemical Society on the celebration of its twenty-fifth anniversary. The following papers were read:—The normal butylic, heptylic, and octylic ethereal salts of active glyceric acid, by P. Frankland and J.

MacGregor. The authors have determined the rotatory powers of the homologous series of ethereal salts of active glyceric acid up to octylic glycerate; the molecular rotations of the normal and secondary butylic salts are greater than those of any others of the series. This kind of result has been predicted by Guye. —The ethereal salts of diacetylglyceric acid in relation to the connection between optical activity and chemical constitution, by P. Frankland and J. MacGregor. The authors have prepared the methylic, ethylic, propylic, isopropylic, and isobutylic salts of active diacetylglyceric acid. In the case of the first two of these salts, two of the atomic groups attached to the asymmetric carbon atom are of equal mass; according to Guye's theory, these should be almost, or quite, optically inactive. This, the authors find, is not the case, and they therefore again urge that the qualitative nature of the groups attached to the asymmetric carbon atom must be considered, as well as their masses. —The oxidation of paratoluidine, by A. G. Green. The red base obtained by Barsilowsky by oxidising paratoluidine with ferrocyanide is a diparatolylimide of the constitution

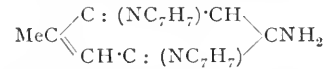

On reduction it yields a stable leuco-base.—The action of benzoic chloride on urine in presence of alkali. Formation of benzoic derivatives of urochrome, by J. L. W. Thudichum. By the action of benzoic chloride on alkaline urine, a mixture of benzoic derivatives of urochrome is deposited.—The combination of hydrocarbons with picric acid and other nitro compounds, by W. A. Tilden and M. O. Forster. Picric acid combines with terpene, giving a compound which forms a peculiar potassium salt, yields picramide and borneol when treated with alcoholic ammonia, and gives borneol when treated with aqueous alkalis. —The formation of pyrrol derivatives from aconitic acid, by S. Ruhemann and F. E. Allhusen.—The conversion of  $\alpha$ -hydrindoxime into hydrocarbostyryl, by F. S. Kipping.  $\alpha$ -hydrindoxime yields hydrocarbostyryl when treated with phosphorus pentachloride.—The constitution of lapachol and its derivatives. II. The azines of the lapachol group, by S. C. Hooker. The author describes methylapazine, methylapaurhodone, methylhydroxy-lapaurhodone, and several of their halogen derivatives.

Geological Society, November 22.—W. H. Hudleston, F.R.S., President, in the chair.—The following communications were read:—The basic eruptive rocks of Gran, by Prof. W. C. Brögger. In previous communications the author has maintained that the different masses of eruptive rock which occur within the sunken tract of country lying between Lake Mjösen and the Langesundsford are genetically connected, and have succeeded each other in regular order. The oldest rocks are the most basic, the youngest (except the unimportant dykes of diabase) are the most acid, and between the two extremes he has found a continuous series. He is now preparing a detailed monograph on this series of eruptive rocks, and in the present communication he gave an account of the results of his work on the oldest members. Several bosses of basic plutonic rock, now forming a series of dome-shaped hills, lie along a north-and-south fissure line. The most northerly is that of Brandberget in the parish of Gran, about 50 or 60 kilometres north-north-west of Christiania, and the most southerly occurs at Dignæs on Lake Tyrifjord, about 35 kilometres west-north-west of the same town. The prevailing rock in these bosses is a medium or coarse-grained olivine-gabbro-diabase; but pyroxenites, hornblendites, camptonites, labrador-porphyrites, and augitediorites also occur. Analyses of the typical rocks from three localities on the north and south line were given, and the conclusion was reached that the average basicity of the rocks forming different bosses decreases from north to south. The contact-metamorphism was referred to; and the presence of hypersthene in the altered *Oggia*-shales, coupled with its absence from the same shales where they have been affected by quartz-syenite, led the author to the conclusion that the chemical nature of the intrusive rock does, in certain cases, produce an influence on the character of the metamorphism. Innumerable dykes and sheets of camptonite and bostonite are associated with the above-mentioned plutonic bosses. These are regarded by the author as having been produced by differentiation from a magma having the composition of the average olivine-gabbro-diabase. Analyses were given, and it was proved that a mixture of nine parts of the average camptonite and two of the average bostonite would produce a magma

having the composition of the average olivine-gabbro-diorite. The petrographical variations, such as the occurrence of pyroxenites and augite-diorites, in the plutonic masses themselves are described, and attributed to differentiation under physical conditions unlike those which gave rise to the camptonites and bostonites. In discussing the general laws of differentiation the author pointed out that it must have taken place before crystallisation to any extent had occurred, because there is a marked difference in mineralogical composition between the rocks occurring as bosses and those occurring as dykes: and, further, that it is dependent on the laws which determine the sequence of crystal-building, in so far as the compounds which, on given conditions, would first crystallise are those which have diffused to the cooling margin, and so produced a contact-stratum, of peculiar chemical composition, before any crystallisation had taken place. A discussion followed, in which the President, Prof. Judd, General McMahon, Prof. J. F. Blake, and Mr. W. W. Watts took part.—On the sequence of perlitic and spherulitic structures (a rejoinder to criticism), by Mr. Frank Rutley. This paper related to the order in which the perlitic and spherulitic structures have been developed in a felsitic lava of Ordovician age from Long Sleddale, Westmoreland. The author having described this rock in a paper published in the Quarterly Journal of the Society in 1884, and the accuracy of the views then expressed having been questioned, endeavoured to confirm his original statements, adducing in support fresh observations made upon this and other rocks of a similar kind. Mr. Marr and Dr. J. W. Gregory spoke on the subject of the paper, and the author briefly replied.—Enclosures of quartz in lava of Stromboli, &c., and the changes in composition produced by them, by Prof. H. J. Johnston-Lavis. The author described the existence of enclosures of quartz in a lava-stream at the Punta Petrazza on the east side of Stromboli, and also in the rock of the neck of Strombolichio. He described the effects of the rocks upon the enclosures, concluding that the quartz has undergone fluxion but not fusion, and has supplied silica to the containing lavas, thus causing an increase in the amount of pyroxene and a diminution in the amount of magnetite in the portions of those lavas that surround the inclusions and raising the percentage of silica. He suggested that such a process at greater depths and higher temperature may, under certain conditions, convert a basic rock into a more acid one, so that possibly the andesite of Strombolichio may have been of basaltic character at an earlier period of its progress towards the surface. He offered the suggestion that other rocks or minerals once associated with the quartz have been assimilated by the magma. The President and Prof. Judd made a few remarks upon the paper.

## CAMBRIDGE.

Philosophical Society, October 30.—Prof. Hughes, President, in the chair.—The following officers were elected for the ensuing session:—President, Prof. Hughes; Vice-presidents, Prof. Cayley, Prof. Darwin, Dr. A. Hill; Treasurer, Mr. Glazebrook; Secretaries, Mr. Larmor, Mr. Newall, Mr. Bateson; New Members of Council, Prof. Sir G. G. Stokes, Dr. Lea, Mr. Shipley, Mr. Seward.—The President (Prof. Hughes) read a paper on the geological evidence for the recurrence of ice ages. Prof. Hughes pointed out that the advocates of the astronomical explanation of glacial ages have urged that there has been a recurrence at regularly varied intervals of combinations, the result of which must have been circumpolar vicissitudes of climate; and, seeing that the secular recurrence of these conditions formed a necessary part of their theory, they gladly welcomed any confirmation of it, such as was offered by those geologists who saw in the character of the stones in certain conglomerates traces of ice-action in several successive geological periods. The value of this evidence he now criticised. He laid before the Society examples of the striated boulders and rock floors supposed to present glaciated surfaces, and with a view to the elimination of sources of error in the identification of the work of ice he exhibited a large series of specimens illustrating the various ways in which results were produced sometimes exactly the same as, and often closely resembling, the forms, markings, and other characters relied upon as proofs of ice action. By reference to these he showed that the faceted stones from which the extension of the glacial conditions over parts of Southern Germany was inferred, found their exact counterparts among those trimmed by blown sand into roof-like forms and ridges, and had no parallel among undoubtedly glacially-dressed stones. The scratched stones in

the base of the New Red, or so-called Permian of England (with the exception of one single specimen, which he said must have got into the collection in Jermyn Street by mistake, he compared with those produced by earth movements, in which the included pebbles of the conglomerate were protruded through the softer matrix and scored and indented by harder fragments held in the mass. The supposed glaciation of the boulders in the basement beds of the carboniferous he explained in the same way, producing examples in which the matrix and included fragments were scored alike by movements along small fault faces. He exhibited a portion of the solid silurian floor on which these conglomerates rested, which was striated in a manner that might be easily mistaken for glacial action; but he explained that he had taken this from a thrust plane, and he pointed out the difference in the mineral condition of the surface between these slickensided surfaces and those produced by glacial action. He excluded from the present discussion cases in which ice agency was inferred only from the size and shape of the stones or their isolation in finest material. He admitted the probability of evidence of ice action being found along known axes of recurrent upheaval, such as those in the most ancient rocks along the Scandinavian range, or in the more recent deposits along the Alpine chain, or further south in the carboniferous boulder beds of India, Africa, and Australia; but he pointed out that these last, at any rate, could lend no support to the astronomer's contention, seeing that they surrounded a basin whose centre was in equatorial, not in circumpolar regions. He was willing to admit that in the astronomical combinations we might find a *vera causa* of vicissitudes of climate, but he urged that all the evidence from direct observation went to show that extreme glaciation does and did always bear a direct relation to earth movements.

## PARIS.

Academy of Sciences, November 27.—M. de Lacaze-Duthiers in the chair.—On the registration of the variable elements of the sun, by M. H. Deslandres.—On equations and implicit functions, by M. Pellet.—On surfaces admitting of gauche cubics for asymptotic lines, by M. Blutel.—On ripples (*clapotis*), by M. E. Guyou. Equations are obtained in which elliptic functions are substituted for the circular functions employed by Boussinesq. According to these equations, each molecule oscillates along a straight line of fixed direction which itself oscillates vertically, and the resultant motion takes place along a parabola whose axis is vertical. For the surface molecules, the first movement is that of the projection upon the minor axis of an ellipse of a point describing the contour of the curve with a constant linear velocity. On examining the photographic tracing obtained by M. Marey it is found that the motion of the surface molecules takes place along a very flat closed curve. This divergence from the theory is easily explained by the oscillations of the cylinder producing in the experimental basin a vertical displacement of the layers which are theoretically at rest. The superposition of this motion upon that indicated by the theory has the effect of separating in a vertical sense the trajectories corresponding to the two inverse phases of an oscillation.—Mutual action of bodies vibrating in fluid media, by M. M. Berson and Juppont. Two vertical discs were placed in air with their axes coincident. The one was made of steel, 0.033 cm. thick and 12 cm. in diameter, and was kept vibrating by two small electromagnets, excited by currents of intensities, varying according to the amplitudes required. The other was of mica, 0.012 cm. thick and 6 cm. in diameter, fixed normally to the bent end of a light bar of aluminium, which, supported by a long silver wire, formed the movable part of a torsion balance. The movement of this disc is due to the surrounding air, thus being analogous to electrostatic induction. The experiments were made inside a cage draped with soft and loose cloth, to prevent resonance. The torsion was measured with a Vernier micrometer to  $\frac{1}{2}$  degree. The attractions exhibited between the two discs when vibrating ranged from half a dyne to about 600 dynes. At a distance of 1 mm. it was 602.3 dynes; at 2 mm., 98.0; at 4 mm., 14.5, and at 10 mm., 2.55. To produce the same forces electrostatically, a difference of potential of 600 volts would be required. The authors intend to study the effect of distance and of the medium in the case of pulsating spheres.—Calculation of the forces to which bodies placed in an electromagnetic field are subjected, by M. Vaschy.—On the variation of the electric state of the high atmospheric regions in good

weather, by M. Ch. André.—On the preparation of metallic lithium, by M. Guntz.—Improvement of culinary and lubricating oils by an electric treatment, by M. L. A. Levat.—On chloralose, by MM. M. Hanriot and Ch. Richet.—On some facts relating to the effects of injections of organic liquids upon animals, by M. E. Meyer.—On absorption by the urinary ducts, by M. Bazy.—Transpiration and respiration as functions determining the habitat of the Batrachians, by M. A. Dissard.—On a ptomaine extracted from urine in influenza, by MM. A. B. Griffiths and R. S. Ladell. This ptomaine is a white substance crystallising in prismatic needles, soluble in water, and showing a feebly alkaline reaction. Its formula is  $C_9H_9NO_4$ . It is a poison producing strong fever and death in eight hours, and is not met with in normal urine.—On a new genus of fishes, related to *Fierasfer*, by M. Léon Vaillant.—On the male genital apparatus of the Hymenoptera, by M. Bordas.—Researches on the anatomy and development of the female genital apparatus of the Orthoptera, by M. Foytoureau.—On the localisation of the active principles in the Limnantheae, by M. Guignard.—On the localisation of the active principles in the Cucurbitaceae, by M. L. Braemer.—Experiments on the disinfection of mushroom beds, by M. I. Costantin.—On the exchanges of carbonic acid and oxygen between plants and the atmosphere, by M. Th. Schloesing fils.—Subterranean grafting, applied to the preservation of ungrafted French vines, by M. Geneste.—On the requirements of direct or grafted vines, by M. Albert Renault.—Study of a variety of the cider apple in all its life periods, by M. A. Truelle.—Proofs and cause of the actual slow movements of Scandinavia, by M. A. Badoureaux.—Observations on the oolitic limestone superior to the gypsum of Villejuif, near Paris, by M. Stanislas Meunier.

## AMSTERDAM.

Royal Academy of Sciences, October 28.—Prof. van de Sande Bakhuysen in the chair.—Prof. Behrens treated (1) on the structure of native gold. Several samples of auriferous quartz were examined under the microscope, on the supposition that they would be found to contain agglomerated granules of metal. The gold was found to be crystallised in cubes, and in combinations of the cube with the octahedron, so perfectly as even to present good cleavage planes. It would appear, therefore, that such gold must have been precipitated and crystallised at the same time and under the same conditions as the surrounding quartz. Further evidence for this conclusion was afforded by the presence of microscopical cavities in small nuggets. Like the cavities in quartz, they occur in streaks and small heaps, being partly spherical or oval, and partly of a sub-angular shape. By the distribution of the alloyed silver in concentric layers of rich and poor alloy, the supposition of a molten state is excluded. All these peculiarities were also found in grains of gold washed from an auriferous ochre, enclosed by auriferous quartzite. (2) On the chemical constitution of alloys. (i.) Lead was found to be a good solvent for crystallising copper and its alloys, a small quantity of lead only being taken up by the latter. If a piece of copper is put into red-hot lead containing a little tin, the surface of the copper is changed to bronze, which does not melt, but will partly dissolve in the lead, and on cooling separate out in crystals. Bronze and common brass will not split up into definite alloys under this treatment. The alloy of copper with 10 per cent. aluminium, which is said to be homogeneous, behaves differently. It will yield red crystals in the upper part of the button, yellow ones in the middle, and white ones near the bottom of the crucible. (ii.) Is copper in bronze univalent or bivalent? With a view to solving this question, a series of silver-tin alloys was compared with corresponding bronzes. The following results were obtained: Regular crystals,  $Cu_6Sn$  and  $Ag_6Sn$ ,  $Cu_3Sn$  and  $Ag_3Sn$ ,  $CuSn$  and  $AgSn$ ,  $CuSn_2$  and  $AgSn_2$ ; other systems (rhombohedral)  $Cu_2Sn$  and  $Ag_2Sn$  (maximum of hardness),  $Cu_2Sn$  and  $Ag_2Sn$  (second maximum),  $Cu_2Sn_3$  and  $Ag_2Sn_3$ . Now, for  $Ag_2Sn$ , no other structural formula can be admitted than  $Ag_2 = Sn = Ag$ , hence there is a great probability for the univalent character of copper in its alloys with tin. Several of the other formulæ will probably have to be doubled. The formula  $Ag_6Sn$  cannot be construed here, and the reasoning leads to the supposition that also in bronzes rich in copper the surplus of the predominant metal is simply dissolved in an isomorphous combination.—Prof. Schoute treated on regular sections and projections of the ikosatrahedron. The author studied the central sections perpendicular to, and the orthogonal projections in, the direction of four lines that join

the centrum to a vertex, or to the centre of an edge, of a tri-angular face, or of a bounding octahedral three-flat. As to the vertices, the four dimensional being  $L_a^{24}$  (24 = number of bounding three-flats,  $a$  = length of edge), proves to be the combination of a  $L_a^8$  (tesseract) and a  $L_{a\sqrt{2}}^{16}$  or of three  $L_a^8$ 's; as to the bounding three-flats it may be considered as the combination of a  $L_{2a}^{16}$  and a  $L_{a\sqrt{2}}^8$  or of three  $L_{2a}^{16}$ 's. — Prof. Kamerlingh Onnes gave a comparison made by Dr. Zeeman of his measures of polar reflection of light on magnets with the theories of Goldhammer and Drude. His experiments decide in favour of the first theory. Prof. Onnes communicated also an explanation by Dr. Kuenen of the abnormal phenomena observed in the neighbourhood of the critical temperature by the theory of mixtures. The experiments of Dr. Kuenen agree with the results of Gouy.

## BOOKS and SERIALS RECEIVED.

BOOKS.—Julius Cesar, with Introduction and Notes, &c.: W. Dent (Blackie).—Heat and the Principles of Thermodynamics: C. H. Draper (Blackie).—Hydrostatics and Pneumatics: R. H. Pinkerton (Blackie).—The Elements of Hypnotism: R. H. Vincent (K. Paul).—Handbook of British Hepaticæ: Dr. M. C. Cooke (Allen).—Helical Gears, a Foreman Pattern Maker (Whittaker).—Choix et Usage des Objectifs Photographiques: E. Wallon (Paris, Gauthier-Villars).—Geologic Atlas of the United States, Hawley Sheet, Massachusetts (Washington).—Jubilé de M. Pasteur (Paris, Gauthier Villars).—Marvelles de la Nature, La Terre avant l'Apparition de l'Homme: F. Priem (Paris, Baillière).—Specola Vaticana, Classificazione delle Nubi (Roma, Tipografia Vaticana).—Celestial Objects for Common Telescopes: Rev. T. W. Webb, 5th edition, vol. 1 (Longmans).

SERIALS.—Zeitschrift für Physikische Chemie, xii. Band, 5. Heft (Leipzig, Engelmann).—Bulletin of the U.S. National Museum, No. 45, Monograph of the North American Proctotrypidæ: W. H. Ashmead (Washington).—Berichte der Naturforschende Gesellschaft zu Freiburg i. B., Band vii. Heft 1 and 2 (Williams and Norgate).—Botanical Gazette, November (Bloomington, Ind.).—Journal of the Anthropological Institute, November (K. Paul).—Natural Science, December (Macmillan).—Geological Magazine, December (K. Paul).—American Naturalist, November (Philadelphia).—Geographical Magazine, December (Stanford).—Mitteilungen des Vereins für Erdkunde zu Halle a. S. (Halle a. S.).—Bulletin of the New York Mathematical Society, November (New York, Macmillan).

## CONTENTS.

|                                                                                                               | PAGE |
|---------------------------------------------------------------------------------------------------------------|------|
| Elementary Practical Science. By Sir Philip Magnus . . . . .                                                  | 121  |
| The Pyrenees. By T. G. B. . . . .                                                                             | 122  |
| Our Book Shelf:—                                                                                              |      |
| Rodet et Busquet: "Les Courants Polyphases" . . . . .                                                         | 122  |
| Loney: "Solutions of the Examples in the Elements of Statics and Dynamics" . . . . .                          | 122  |
| Letters to the Editor:—                                                                                       |      |
| Sir Henry Howorth and "Geology in Nubibus."—R. M. Deeley . . . . .                                            | 122  |
| The "Zoological Record."—Dr. P. L. Sclater, F.R.S.; John E. Marr . . . . .                                    | 123  |
| The Proposed Continuous Polar Exploration.—Robert Stein . . . . .                                             | 124  |
| On the Classification of the Tracheate Arthropoda.—A Correction.—R. I. Pocock . . . . .                       | 124  |
| The Loss of H.M.S. "Victoria." II. By Dr. Francis Elgar . . . . .                                             | 124  |
| Reappearance of the Freshwater Medusa ( <i>Limnocodium Sowerbii</i> ).—Prof. E. Ray Lankester, F.R.S. . . . . | 127  |
| Death of Prof. Tyndall . . . . .                                                                              | 128  |
| Notes . . . . .                                                                                               | 129  |
| Our Astronomical Column:—                                                                                     |      |
| The Variation of Latitude . . . . .                                                                           | 133  |
| Meteor Shower for December . . . . .                                                                          | 134  |
| Refraction Tables . . . . .                                                                                   | 134  |
| Geographical Notes . . . . .                                                                                  | 134  |
| The Anniversary Meeting of the Royal Society . . . . .                                                        | 134  |
| The Temperature of Ignition of Explosive Gaseous Mixtures. By A. E. Tutton . . . . .                          | 138  |
| University and Educational Intelligence . . . . .                                                             | 139  |
| Scientific Serials . . . . .                                                                                  | 139  |
| Societies and Academies . . . . .                                                                             | 140  |
| Books and Serials Received . . . . .                                                                          | 144  |

THURSDAY, DECEMBER 14, 1893.

## A BOOK OF PRACTICAL EXAMPLES IN ELECTRICITY.

*Problèmes et Calculs Pratiques d'Électricité.* Par M. Aimé Witz. (Paris: Gauthier-Villars et Fils, 1893.)

THIS is, in the main, a book of fully worked-out exercises in electricity and magnetism, designed for the help of practical students. Its idea and arrangement are good, and the examples seem to have been chosen with much care, and, as far as possible, from actual cases which have occurred in laboratory and practical work. The aim of the author has not been to furnish a set of examples, like the collection of Walton, in theoretical mechanics, or that of Hall Turner, in heat and electricity. These works illustrate general mathematical theories by examples, the solutions of which are in many cases important or interesting particular theorems; but their interest is, to a great extent, mathematical. M. Witz has had in view the wants of students endeavouring to obtain a sound elementary knowledge of electricity, who are not afraid of a piece of calculation involving, when necessary, a little differentiation or integration, when it comes in its proper place as the simplest and most direct means of attaining the required result.

The work is divided into three parts: (1) containing definitions and formulas, (2) numerical constants, and (3) the greater portion of the book—a collection of illustrative examples. Part 1 deals first with magnetism, and gives the ordinary relation between magnetic intensity and magnetic induction, introduces the notions of magneto-motive force and magnetic resistance, and shortly states the main facts of lamellar and solenoidal magnetisation. In like manner the next chapter states, merely, some of the principal theorems of electrostatics; the third deals with phenomena of steady currents; and the last two with electro-magnetism and induction of currents.

In connection with electro-magnetism a paragraph is devoted to the researches of Ewing and "M. Hopkins" on the magnetization of iron. All the latter experimenter (the distinguished inventor of characteristic curves of dynamos appears to be meant!) is credited with is a demonstration that the "travail" (consumed in putting a sample of iron through a magnetic cycle) "exprimé en ergs et rapporté à l'unité de volume, est égal au produit de la force coercitive de l'échantillon par l'induction maximum, divisé par  $\pi$ ." The measure of coercive force assigned by Hopkinson does not seem to be explained in the book, and so a really important idea, rendering definite what was before a perfectly vague expression, is passed over. As to the demonstration referred to, we must confess to never having heard of it. Dr. Hopkinson, we had supposed, simply used the rule stated in the quotation as a rough and ready method of rapidly finding the approximate dissipation of energy in a closed magnetic cycle.

Ampère's law ("formule classique, connue de tous nos lecteurs") of the action between two current elements is explained, but no hint is given that any number of other laws can be obtained which give for the only cases with which we can without ambiguity deal,

those of closed circuits, precisely the same result as is given by Ampère's formula, although the latter may have certain advantages in point of simplicity.

The word "law" is a good deal misused in electrical science; we have Kirchhoff's laws, Ohm's law, Joule's law, Lenz's law, and many others; but we have here a law that we do not remember to have come across before, namely "Pouillet's law," which asserts that the quantity of electricity conveyed by a current  $I$  in time  $t$  is  $It$ . No doubt if the electro-magnetic definition and measure of a current are adopted, it is a proper subject of investigation to settle whether it is simply proportional to the current defined electrostatically as the time rate of flow of electricity; but the real proof that this is the case, is the consistency with the results of experiment of the great mass of results deduced from this proportionality.

The chapter on induction is brief, but contains a great deal of information very accurately expressed. The function of the current which multiplied into the speed gives the electromotive force of a dynamo, is referred to as the "fonction caractéristique" of M. Marcel Depres; but Hopkinson's extremely important dynamo characteristic curves are merely referred to, without any mention of their author.

The so-called law of Jacobi, namely, that "Le travail utile d'un moteur est maximum lorsque sa force contre-électromotrice est égale à la moitié de la force électromotrice de la génératrice," is no doubt correctly stated, since by "le travail utile" is meant the electrical work done on the motor in a given time, otherwise than in heating its conductors. But it would be better to say that the electrical activity as specified in the motor is a maximum when the condition stated is fulfilled. The phrase "useful work," here used, has caused this result, simple as it is, to be completely misunderstood by many practical electricians of high standing. In the present case the tendency to error is obviated by the statement immediately following, that "Le rendement électrique d'une transformation d'énergie, est égal au rapport de la force contre-électromotrice  $e$  de la réceptrice à la force électromotrice  $E$  de la génératrice. Ce rendement peut devenir égal à l'unité lorsque  $e$  devient égal à  $E$ ; mais alors le travail produit tombe à zéro. C'est la loi de Siemens."

The late Sir William Siemens objected in 1883 to the erroneous interpretation put upon Jacobi's result by Verdet and others, and likewise stated the true principle of efficiency; but the law of maximum efficiency of a circuit containing a motor was given in Lord Kelvin's very important paper on the "Mechanical Theory of Electrolysis," published in 1851 in the *Philosophical Magazine*. As not only this result, but others, forming practically the whole of the simple but immensely important elementary theory of the electrical efficiency of a generator and motor, are there incidentally given by Lord Kelvin, and are usually stated in practical treatises and lectures as theorems of much later date, we may be allowed to give here a short abridgement of the passage.

Denoting by  $\omega$  the angular velocity with which a Faraday disk magneto-electric machine is driven, by  $v$  the velocity with which the machine would have to be driven to give a back electromotive force equal to that of the generator (a battery in this case), Lord Kelvin

points out that if  $\omega$  is less than  $\Omega$ , the current is opposed to the electromotive force of the disk, and that therefore in this case "the chemical action is the source of the current instead of being an effect of it: and the disk by its rotation produces mechanical effect as an electro-magnetic engine" (or, as we now call it, a motor) "instead of requiring work to be spent upon it to keep it moving as a magneto-electric machine." If  $\gamma$  be the current flowing,  $F$  the intensity of the field in which the disk revolves,  $r$  the radius of the disk,  $R$  the resistance of the circuit,  $W$  the rate at which work is done by the current on the engine,  $M$  the rate at which energy is spent by the battery, then the results—

$$\gamma = \frac{r^2 F}{2R} (\Omega - \omega),$$

$$W = \frac{1}{2} r^2 F \omega \gamma,$$

or

$$W = \frac{\omega M}{\Omega}$$

are given, and it is pointed out that the fraction of the "entire duty of the consumption which is actually performed by the engine is equal to  $\omega/\Omega$ ." The ratio  $\omega/\Omega$  is the ratio of the back electromotive force of the motor to the total electromotive force of the generator, and is therefore the law of efficiency stated above in the words of M. Witz.

The examples worked out in the book are many of them highly instructive, and, so far as we can judge from the examination of a selected few, seem clearly and correctly dealt with. They are not merely numerical, but include in most cases the deduction from general theorems of formulas for particular cases, which are then illustrated by numerical problems in which results are expressed in C.G.S. units. The value of these problems is enhanced by the fact that they are, as we have said, for the most part actual problems which have turned up in experimental or practical work. The subjects thus elucidated include magnetism, electrostatics, steady flow of electricity, electro-magnetism, dynamos, motors, and the distribution and transmission of electric energy. There can be no doubt that the book will prove very useful to teachers and students. Its only fault is that it leaves nothing for the student himself to do. A moderate number of unworked examples, on which he might test his grip of the subject, and power of applying principles, would have been very valuable. It is undesirable to spend very much time in solving mere arithmetical or algebraic conundrums, but enough must be done to acquire a fair amount of readiness and expertness of calculation; and of the great benefit derived from working out numerical examples of physical principles, there can be no doubt. We think, therefore, the author would do well to supply material for this in a future edition.

A. GRAY.

#### BESANT'S DYNAMICS.

*A Treatise on Dynamics.* By W. H. Besant. (Cambridge: Deighton, Bell, and Co., 1893.)

THIS popular text-book has now reached a second edition, and contains several additions which have increased its size from 334 to 448 pages. A new chapter has been added on disturbed elliptic motion, which shows how the elements of an elliptic orbit are affected

by small disturbances in the same plane. This chapter will serve as a useful introduction to the planetary theory, since the limitation of the problem to two-dimensional motion enables various difficulties, which arise from taking into account the longitude of the node and the inclination of the orbit, to be got rid of. The principle, upon which the method of the variation of the elements is based, is one to which students should be introduced at an early stage; but unless some simplification is made, the analysis becomes rather complicated. We are inclined to suggest that this chapter might be extended in a future edition.

The last chapter of the first edition has been amplified into two, the first of which deals with motion in three dimensions, whilst the second discusses several important problems relating to the motion of tops, discs, gyroscopes, &c.; and the book concludes with a new chapter on Lagrange's equations, together with several applications illustrating their use. To discuss any of the higher developments of this branch of the subject, including the Hamiltonian transformation, and the mixed transformation which in 1887 was for the first time given in a *complete* form by the author of this review, would probably be thought beyond the scope of an elementary work; but it would be well to bring out more pointedly the fact that the kinetic energy of a dynamical system can be expressed in several different forms, and that when employing Lagrange's equations there is only one form which it is permissible to use, viz. the Lagrangian form, in which the kinetic energy is expressed as a homogeneous quadratic function of velocities which are the time-variations of coordinates. Mistakes are frequently made upon this point; and it is most necessary to impress upon the minds of students that Lagrange's equations are double-edged tools, which are apt to cut the fingers of those who unskilfully handle them.

Dr. Besant has used the word *phoronomy* in the place of *kinematics*, and he has stated his reasons for so doing in a letter published in NATURE, March 17, 1892. The word appears to be a good one, and has the merit of being classical, and not Teutonic; but notwithstanding occasional flights into the regions of radicalism, the ingrained conservatism of the English mind is so strong that it is by no means certain whether phoronomy will supplant a word which has long held the field.

One of the most satisfactory features of the work is that Dr. Besant has drawn marked attention to the principle of momentum. This principle is in some respects a more fundamental one than the principle of the conservation of mechanical energy; for the former principle is true in the case of viscous systems in which there is a conversion of mechanical energy into heat, whilst the latter does not hold good when internal friction or viscosity exists. The principle of linear momentum can be shown to be a direct consequence of Newton's second and third Laws of Motion: but doubts have been entertained whether the principle of angular momentum can be deduced from Newton's Laws without the aid of an additional hypothesis. The question, however, is far too recondite one to be discussed in a review.

It is possible that some of those whom a recent correspondent in NATURE has described as "the slug and the bug school" may object to the large amount of problems

and examples which are contained in the text and at the end of the chapters. Persons whose curiosity is limited to finding out *what electricity does*, and adopt the unscientific attitude of considering it waste of time to try and ascertain *what electricity is*, and *why* it is capable of performing so many wondrous feats, may perhaps rebel against a system, one of whose objects is to train the mind to inquire into the *causes* of natural phenomena. It must be recollected that young men, who are just emerging from the schoolboy stage of existence, invariably find that Rigid Dynamics is a very difficult subject to master, and that a thorough knowledge of the principles of the subject, combined with analytical skill in applying them to natural phenomena, can only be acquired by working out a large number of problems and examples. It is also an excellent plan for students to work out the same problem (for example, the motion of a top) by various methods, and to study the different results obtained by each; for they will thereby not only obtain analytical skill, but will learn that their symbols, instead of representing mere mathematical quantities, are the embodiment of important scientific facts.

A. B. BASSET.

#### INSECT PESTS.

*Our Household Insects: an Account of the Insect Pests found in Dwelling-houses.* By Edward A. Butler, B.A., B.Sc.Lond., author of "Pond Life," "Silk-worms," &c. (London and New York: Longmans, Green and Co., 1893.)

MR. E. A. BUTLER has done useful service to the cause of popular entomology by reprinting the present series of his contributions to *Knowledge* in book form. Not very many species are discussed, but these seem to comprise most of the principal insect pests belonging to the various orders of insects which infest our houses, and attack ourselves or our property.

As insects (exclusive of insect-parasites) attack all kinds of dead or decaying animal and vegetable matters, and play the part of general scavengers, nothing is exempt from their ravages. Books are particularly subject to their attacks; and many of their enemies are noticed by Mr. Butler. We remember once being much amused by an account of a book-worm, which was ridiculed by a writer in a bibliographical magazine, as being evolved from the describer's own consciousness, but which was really fairly recognisable as applicable to *Lepismus saccharina*, the common silver-fish. But the critic regarded the book-worm as necessarily a small grub or beetle (we forget which), and displayed his own ignorance of entomology accordingly. Prof. Westwood once named a minute beetle, which had done much mischief to the cover of a book, *Hypothenemus eruditus*; and specimens of books damaged by insects may be seen in one of the cases in the public insect-room at the Natural History Museum, South Kensington. We believe that Mr. Zaehnsdorf, the well-known book-binder, has also formed a collection of the book-pests which he has met with in the exercise of his vocation. We may add that the Arabs sometimes write the name Kabikaj, said to be that of a genius who presides over insects, on their manuscripts, in order to protect them from the ravages of his subjects.

There is no doubt that insects of various kinds get mixed with human food from time to time; but we imagine that the passage which Mr. Butler quotes from Curtis's "Farm Insects," relating to maggots in cocoa-beans, is somewhat out of place at the end of a chapter on beetles, for we have good reason to believe that the insect to which Curtis alluded was not a beetle, but a moth of the genus *Ephestia*.

The seven plates of magnified insects and their structure, and the numerous woodcuts, add much to the usefulness of the book. Clear definitions, and accurate demonstrations, are extremely useful in entomology, not merely to beginners, but even to more advanced students, who often find much difficulty in obtaining the necessary explanations of the characters and terminology, when they take up the study of a group of insects with which they were not previously familiar.

The insects which Mr. Butler discusses may be divided into three classes: those which really cause serious destruction to property, as the clothes-moths and various kinds of small beetles; those which are rather troublesome and annoying than destructive, such as the flies and wasps; and those which attack man himself. Among the latter are the lice, which the increase of cleanliness has fortunately rendered rather unfamiliar objects to the better classes in recent times. Yet they are highly interesting creatures, from many points of view, and several entomologists have not scrupled to make a special study of them; among others, Denny, who wrote an elaborate monograph on the British species, illustrated with twenty-six coloured plates; and the old Dutch naturalist, Van Leeuwenhoek, who actually reared a brood in a stocking on his own leg! We think the figure of the proboscis of a louse, which Mr. Butler copies from the Danish entomologist Schiödte, on p. 332, will be new to most of his readers. But there is a curious omission of a necessary explanation in Mr. Butler's observations, in the following passage:—

"Man is not exceptional among mammals in harbouring these vermin; he is but in the same category with the rest, for it seems to be the rule, from elephant to mouse, largest to least, that some member of this group of parasites should be attached to each species; and even aquatic animals, such as the seal and walrus, do not evade their attacks."

Surely Mr. Butler, to avoid being misunderstood, should here have stated that the presence of a true louse on seals is quite an exception as regards marine animals, and that the so-called "whale-louse," and similar parasites, are not true lice, or even insects at all, but parasitic crustacea.

Our author mentions the fact of colonies of fleas having sometimes been found on sandy sea-shores, and wonders what they can find to eat there. But although certain species of fleas are attached to different species of animals, they are perhaps not so particular about their food as is generally supposed. In all warm countries it is very common to find colonies of fleas camping-out in the open; and the late Mr. F. Smith once recorded an instance of a suburban garden, in which a particular bed was swarming with dog-fleas; no particular dog being mentioned as the probable origin of the invasion. In the Western States of America, the "wild fleas," as the late

Frank Buckland would have said, actually feed on the larvæ of a white butterfly which abounds in the pine-forests.

Some curious stories are related by Mr. Butler respecting Longicorn beetles, and *Sirex gigus* perforating sheets of lead. Many years ago, a tin canister was exhibited before the Entomological Society, through which a siag-beetle had gnawed its way, and the marks of its jaws were distinctly visible on the tin.

In his remarks on the bed-bug, which is almost invariably, if not always, apterous, Mr. Butler makes some general observations (p. 287) on the use of wings to insects. It may be mentioned that the late Mr. Wollaston has observed that most insects inhabiting the Atlantic Islands, are either strongly winged, or practically incapable of flight. The explanation which he gives is very curious and interesting. Insects living on small islands exposed to gales are very liable to be blown out to sea. Hence it is almost equally beneficial to them either to be gifted with such strong powers of flight that they can make their way back, in case of such an emergency, or else that they should never fly at all, and thus never run the risk of being blown away.

There are many interesting subjects touched upon in Mr. Butler's work, and much that would admit of further comment; but we have perhaps said enough to indicate its general scope and character. Should it reach a second edition, we think it might be made a little more comprehensive with advantage; for the subject is a very large one, and those who feel a real interest in it rarely find a book too long or too much detailed.

#### OUR BOOK SHELF.

*Text-book of Biology.* By H. G. Wells, B.Sc.Lond., F.Z.S., Lecturer in Biology at University Tutorial College. With an Introduction by G. B. Howes, F.L.S., F.Z.S., Assistant Professor of Zoology, Royal College of Science, London. Part II. Invertebrates and Plants. (London: W. B. Clive, University Correspondence College Press, 1893.)

IN dealing with a small number of Vertebrate types in Part I. of this book (see NATURE, vol. xlvii. 1893, p. 605), the author showed distinct capability and promise; but we feel that he would have done well to wait and work for a few years before publishing this second volume, which covers a larger field. As the types of plants and invertebrates treated of have already been described in so many text-books, the writer had, at any rate, the opportunity of getting his facts and deductions second hand and fairly correctly stated, even without an extensive acquaintance with biological science. There is, therefore, all the less excuse for the many errors and misstatements which occur in this volume, the preface to which would lead one to expect better things in this respect, as well as in the selection and arrangement of facts. Prof. Howes's introduction appeared in Part I.; and before inserting his name on the title-page of Part II. it would, we think, have been only just to have at least submitted the proofs to him. The book would certainly have gained by so doing.

Apart from the more serious faults, which are so numerous that it is not easy to give a short selection of them, awkward terms and misprints abound. Prof. Goebel would probably be surprised to hear that he had written a text-book on botanical "mythology" (p. 94)!

The illustrations are exceedingly crude, and are mostly

rough copies of well-known figures. [It] is, however, only fair to state that the author has purposely made them "as simple and diagrammatic as possible." W.N.P.

*The New Technical Educator.* Vol. ii. (London, Paris, and Melbourne: Cassell and Co., Ltd., 1893.)

IN a notice of vol. i. of this useful work we pointed out that it filled a want in our general technical literature, and that its contents were of a high order. The present volume is quite equal to its predecessor in this respect, and forms a continuation of all the subjects treated in the previous volume.

Under the heading of the "Steam Engine" we find an admirable series of chapters, by Mr. Archibald Sharp, on the subject of valve gear generally, particularly the diagrammatic treatment of the subject illustrative of the various movements of eccentrics, piston and valve. "Electrical Engineering" is also in good hands, being clearly treated by Mr. Edward A. O'Keefe. The many explanations and descriptions given are of a high order of merit. On the subject of "Cutting Tools" much useful information is to be found from the pen of Prof. R. H. Smith, who is an authority on this particular subject. The other subjects embraced in the volume, including practical mechanics, plumbing, photography, steel and iron, drawing for engineers and carpentry, are all well written and illustrated, forming a very useful collection of articles on technical subjects. It is to be regretted, however, that the various articles on different subjects continue in this volume to be mixed together, thus causing the reading of one subject to be a matter of frequent reference to the page of contents.

*Heat, and the Principles of Thermodynamics.* By Dr. C. H. Draper. (London: Blackie and Son, 1893.)

IN these days of innumerable books, it is often a difficult task to correctly appraise the value of a new work, and this is especially the case with books intended for use in classes. The only thing a reviewer can do is to judge whether the volume under his notice differs much from previous volumes on the same subject; and if the author shows no originality of treatment, it seems to us that his book could very well have been left unwritten. Viewing Dr. Draper's work in this light, we find as follows: (1) Much more attention is paid to the principles of thermodynamics than is usual in class-books of its kind; (2) the examples and exercises distributed throughout the book, and at the end, are more numerous than in most text-books of heat, and cover a wider range of examinations; (3) the mathematical section of the subject has not been shirked. Little more can be said. The book is as good as any of its class, and to the student who desires to read up for an examination in heat it should be very helpful.

#### LETTERS TO THE EDITOR.

[The Editor does not hold himself responsible for opinions expressed by his correspondents. Neither can he undertake to return, or to correspond with the writers of, rejected manuscripts intended for this or any other part of NATURE. No notice is taken of anonymous communications.]

#### Systematic Nomenclature.

WITH reference to Prof. Newcomb's suggested nomenclature for radiant energy, which appeared in NATURE, November 30, p. 100, it seems advisable to be rather cautious in adopting new words, or rather terminations to words already more or less in use, for at the present time the student beginning the study of physical science is fairly bewildered with the various forms of words used under the present system, or rather want of system, in nomenclature.

If once for all some system of termination was settled upon



(as in chemistry, for the increasing oxidation results, &c.), the coinage of words as fresh needs arose would proceed automatically on rational lines.

This might very well form the object of a special committee of the British Association.

Mr. Oliver Heaviside's system for electromagnetic matters has much to recommend itself for adoption, also, in general physics.

For example, after the plan (1) conduction, (2) conductance, (3) conductivity, we would have, in the case of radiant energy, (1) radiation, (2) radiance, (3) radiativity.

The first is for reference in a general way to the phenomenon in question; the second refers to its amount in appropriate units in any individual case; while the third is suitable for expressing the peculiar action or factor in the phenomenon possessed by different kinds of bodies. Thus the radiance from a hot kettle would be the total quantity of energy lost per second. The radiativity would be the quantity of this per square centimetre.

With a view of examining the feasibility of this system, the following list is subjoined. Many of the words appear at first as if they would prove most awkward in practice, but remembering similar fears (which subsequently proved groundless) in electromagnetic matters, one is afraid to say they are due to more than unfamiliarity.

| Phenomenon   | Amount of   | Coefficient of |
|--------------|-------------|----------------|
| Absorption   | Absorbance  | Absorbivity    |
| Attrition    | Attritance  | Attritivity    |
| Diffusion    | Diffusance  | Diffusivity    |
| Emission     | Emissance   | Emissivity     |
| Expansion    | Expansance  | Expansivity    |
| Extension    | Extensance  | Extensivity    |
| Friction     | Frictance   | Frictivity     |
| Gravitation  | Gravitance  | Gravitivity    |
| Heat         | Heatance    | Heativity      |
| Inertia      | Inertance   | Inertivity     |
| Polarization | Polarizance | Polarizivity   |
| Reflection   | Reflectance | Reflectivity   |
| Refraction   | Refractance | Refractivity   |
| Rotation     | Rotance     | Rotativity     |
| Solution     | Solulance   | Solutivity     |

Special attention deserves to be called to inertance as a good name for mass, and inertivity for density, to rotance for moment of momentum, and rotativity for moment of inertia.

GEO. FRAS. FITZGERALD,  
FRED. T. TROUTON.

Physical Laboratory, Trinity College, Dublin,  
December 5.

### On the Nomenclature for Radiant Energy.

IN connection with this subject there are many things to be considered, and one of the most important is the question of radiation and absorption, which requires a completely new nomenclature to get over very serious ambiguities that at present embarrass the subject. It is very necessary to distinguish between what may be called, on Prevost's theory of exchanges, the total radiance from the actually observed loss of energy by radiation which is, according to this theory, the difference between the total radiance and the total absorbance. This difference per degree of temperature is very commonly called the radiating power, but this same word is used in quite a different sense when it is attempted to prove, from Prevost's theory of exchanges, that the radiating is equal to the absorbing powers by a consideration of thermal equilibrium. In this latter case the term radiating power means obviously the total radiance of Prevost's theory.

It may also be worth while calling attention to the theory, given at Nottingham by Lord Rayleigh, as to the absorbivity of rough surfaces being equal to unity. The general idea underlying his investigation is that owing to diffraction the waves amongst the deep corrugations in the surface spread abroad within them, and hardly any of their energy escapes out again. At the time I called his attention to the way a similar theory would explain the radiating power of rough surfaces, as I have

taught here for years back. I am mentioning this now to call attention to an experiment of Magnus' mentioned in Jamin ("Cours de Physique," vol. iii, part 3, p. 113, top line, edition 1881; *Pogg. Ann.* vol. cxxiv, p. 476), where I have an old note concerning this theory, and which I had forgotten, to the effect that the radiation from platinised platinum was much greater than that from smooth platinum, but that the increase was chiefly in the ultra-red rays, for that the difference between the two plates was almost completely annulled by a plate of alum. This is what would be expected from the above theory, because corrugations that are small enough to affect the ultra-red radiations might still be too large to be anything but a smooth surface for the visible radiations. There is evidently a good deal still to be done on radiativity.

GEO. FRAS. FITZGERALD.

Physical Laboratory, Trinity College, Dublin,  
December 5.

### Flame.

I TRUST that, in common with other readers of NATURE, I feel duly chastened by the homily which Dr. Armstrong has addressed to you on the subject of my lecture on "Flame." It is perhaps well that we should be warned from time to time against the sin of dogmatising. The only objection I have to the process is that I should be singled out as a sinner without some good reason being given for the selection. I am charged with forgetting that certain alleged facts "are but phenomena interpreted by our own limited intelligence," and yet I actually wound up my lecture with a quotation from Carlyle, intended to emphasise that very point. If Dr. Armstrong had said that *this* was an "appeal to the gallery," I should not have complained.

I do not feel equal to the metaphysical discussion to which Dr. Armstrong opens the way. I know only of one kind of fact, namely, "phenomena interpreted by our own limited intelligence," and it seems better to spell the thing in four letters than to bury it in phrases that smack of the pulpit.

Now let us see what I have done. I found on burning a hydrocarbon with a limited supply of oxygen, that in the cooled products of combustion all the carbon was oxidised, and that some of the hydrogen was set free. I had been brought up, like Dr. Armstrong, to cherish certain chemical dogmas, one of which was that the hydrogen of a burning hydrocarbon was oxidised before the carbon. I now asked myself what were the grounds for this dogma? It seemed to me to spring from the narrowest view of things, probably from the fact—I mean the by-limited-intelligence-interpreted-phenomenon—that hydrogen gas is easier to set on fire than a lump of charcoal. This was obviously an unscientific conclusion, for the carbon of a burning hydrocarbon is part of a gas, and when it is oxidised it has not, like a lump of charcoal, to be virtually gasified in the act of burning, and so to demand a high temperature and an untold amount of heat. I then read with great profit a paper by Dr. Armstrong, which confirmed my opinion that the heat of combustion of an atom of gaseous carbon, in forming carbon monoxide, must be exceedingly high, and so on all grounds I concluded that there was no *prima facie* reason for assuming that the hydrogen of a hydrocarbon would be oxidised in preference to the carbon. Experiment showed the opposite result; the carbon was oxidised, and I adopted the straightforward explanation, and renounced the old dogma. There were alternative explanations. It was conceivable that the hydrogen burnt first and liberated the carbon, which then acted upon the steam to produce one or both of the oxides of carbon and free hydrogen. We should then have two successive chemical reactions. I pointed out that there was only one piece of indirect evidence in favour of this view, and that has since been contradicted by Prof. Dixon. But Dr. Armstrong appears to suggest the view that the two chemical reactions are simultaneous. Now we know of plenty of chemical reactions which are best understood and remembered if we represent them by two simultaneous equations. When, for instance, zinc is heated with strong sulphuric acid, and we do not get hydrogen, we may explain the apparent anomaly by saying that hydrogen is liberated, but that it immediately attacks some of the hot sulphuric acid, producing sulphur dioxide and water. Or we may choose another pair of "normal" reactions which, being supposed to happen simultaneously, will explain the "abnormal" result. But surely no one thinks that the two reactions do proceed simultaneously. I use this method of exposition very largely, but I always tell my students that it is analogous to the treatment of forces in dynamics. We suppose

a body acted upon by two forces whose direction and intensity may be conveniently represented by the adjacent sides of a parallelogram. The body *really* moves along the diagonal: *virtually* it has a double track, one along each of the adjacent sides of the parallelogram. In like manner, in our hydrocarbon-oxygen system, we may picture two compelling forces, viz. the ten-dency of oxygen to combine with carbon, and of oxygen to unite with hydrogen. You may, if you please, to this seems a fascinating exercise to Dr. Arms rong), shut your eyes alternately to each force and say, "first the hydrogen gets all the oxygen, and then the carbon snatches some from it," or you may just as well put it the other way about. I simply recorded the fact that the carbon got the most of the oxygen, with an explicit reference to the fact that I was dealing with the cooled products. Before my experiments were published Dr. Armstrong thought that hydrogen got most of the oxygen. He had actually tried to persuade Sir G. G. Stokes and many others to this effect. When my paper appeared he sought to discount the facts it contained by flights of polysyllables worthy of a great statesman.<sup>1</sup> Is it not strange that he should now turn to rend the man who relieved him from what he so abhors—a dogma?

The assumption that the products which are collected from a flame may have totally altered in kind during a minute fraction of a second is perfectly gratuitous, and a similar assumption might be made about nearly every reaction in chemistry. Dr. Armstrong might just as well forbid me to say that zinc and hot sulphuric acid give sulphur dioxide, as to say that when a hydrocarbon burns with limited oxygen, the carbon has the preference.

I will not trespass on your space with a discussion of the liberation of carbon in luminous flames. Dr. Armstrong's contentions on that matter are of precisely the same character as those I have dealt with above. Dr. Frankland has promised us some new evidence in favour of his theory. I trust I have always treated this theory with respect. I am not bigoted on the subject, though I await Dr. Frankland's promised publication with the same sort of feelings as those with which a Neapolitan might look forward to the reawakening of Vesuvius.

I have now, I hope, given an adequate reply to the question of scientific fact raised by Dr. Armstrong. I will not say much about the imputations he casts upon my scientific honesty. It ought not to be a light thing for a man in Dr. Armstrong's position to accuse a scientific worker of deluding an audience into unsound opinions by means of dazzling experiments, of playing to the gallery; of doing, in short, just those things which are most repugnant to the conscience of an earnest investigator. After years of personal friendship, I know Dr. Armstrong's idiosyncrasies very well, and they are, I imagine, pretty well known to the scientific world in general. I feel compelled, none the less, to ask him *either* to justify or withdraw his aspersions. I make no appeal *ad misericordiam*, and seek no comforting eulogy. It is a duty Dr. Armstrong owes no less to the scientific world than to myself to state clearly and precisely how I have departed from the standards of diffidence, deliberation, and exactitude that are becoming to a man who is honestly seeking to expound the truth. This, at any rate, is a matter the settlement of which is not contingent upon the arrival of that chemical millennium when we shall recognise "chemical interchange and electrolysis as interchangeable equivalent terms"; and I have the right to ask for an immediate and definite reply to my demand.

ARTHUR SMITHHELLS.

December 2.

The Second Law of Thermodynamics.

CLAUSIUS' supposed deduction of the second law from the ordinary equations of dynamics in the form

$$\frac{\partial Q}{T} = 2\partial \log (iT)$$

has been discussed at length by Messrs. Larmor and Bryan in

<sup>1</sup> Here is a copy of a letter from one of his letters to Sir G. G. Stokes: "Regarding the intricate difficulties consisting in a series of simultaneous and inseparable explanations, of which we can only examine the final steady state, it seems to me that the phenomena are necessarily of an exceedingly complex character, and that their appreciation and successful interpretation must tax our powers of mental analysis in a high degree. It will certainly be unwise at present to interpose the oxidation of the hydrocarbon, or the separation of carbon and water of hydrogen from them, takes place entirely in any one way." This seems to me like saying of a fall of waters, that it is "a series of simultaneous and inseparable" bumps, &c., so difficult to trace out an explanation so many possible varieties of motion that it is hardly safe to call it a fall of water at all.

their Report on Thermodynamics for the British Association. They accept the deduction on condition that the system be conservative, that is, that the external as well as the internal forces acting on it are to be derived from a potential.

Now it is admitted that the equation

$$\frac{\partial Q}{T} = 2\partial \log (iT)$$

can be proved for a conservative system with the meaning of *i* given in the report. But in order that this equation, however true, may express the second law, *T* and *i* must be *independent variables*, or (which is the same thing when there is only one controllable coordinate *v*) *T* and *v* must be *independent variables*.

Now the second law implies comparison of two states, in either of which a substance can exist permanently. So if we seek to prove the law, or an analogous law, for a dynamical system, it is essential that we should compare two states of the system in either of which it is in *stationary motion*. One state may have the variables *T* and *v*, and the other may have *T + ∂T* and *v + ∂v*, but there must be *stationary motion* with either pair of values. If then *K* be the virial of all the forces, external as well as internal, the Clausian equation, *K = 2T* must hold. But if the system be conservative, as Larmor and Bryan assume, *K* is a determinate function of *v*, and the virial equation constitutes a relation between *T* and *v*, so that only one of them is independent. For example, a fixed quantity of gas in equilibrium in a vertical cylinder under a piston of mass "*m*" acted on by gravity. Clearly if *T* be given, *v*, the volume, is determinate, or we have only one independent variable. If *m* be disposable, you may make *T* and *v* vary independently, but then the system is not conservative. It seems to me that Larmor and Bryan's equation does not express the second Law.

Prof. J. J. Thomson, in his "Application of Dynamics to Physics and Chemistry," pages 95-102, proves the second law on a certain assumption. And Boltzmann, "Über die Mechanischen Analogien des zweiten Hauptsatzes," has proved it on, I think, the same assumption. In order to show clearly the nature of the assumption I will begin a proof as follows, treating only the case of *T* temperature, and *v* volume. If  $\bar{\chi}$  denote the potential of all the conservative forces, *f* the external force necessary to maintain *v* constant, we have *T* being the mean kinetic energy of one of *N* molecules

$$\partial Q = N\partial T + \partial \bar{\chi} + f\partial v.$$

But by the virial equation

$$f\partial v = \frac{1}{2}NT \frac{\partial v}{v} - \frac{d\bar{\chi}}{dv} \partial v,$$

in which  $\frac{d\bar{\chi}}{dv}$  is to be distinguished from  $\frac{d}{dv}\bar{\chi}$  as explained in Watson's "Kinetic Theory of Gases."

Therefore

$$\partial Q = N\partial T + \frac{1}{2}NT\partial \log v + \partial \bar{\chi} - \frac{d\bar{\chi}}{dv} \partial v,$$

or

$$\frac{\partial Q}{T} = N\partial \log T + \frac{1}{2}N\partial \log v + \frac{1}{T} \left( \partial \bar{\chi} - \frac{d\bar{\chi}}{dv} \partial v \right),$$

now make

$$i = \frac{v}{T^{\frac{1}{2}}}$$

(a definite time), then

$$\partial \log T + \frac{1}{2}\partial \log v = 2\partial \log (iT),$$

and therefore

$$\frac{\partial Q}{T} = 2N\partial \log (iT) + \frac{1}{T} \left( \partial \bar{\chi} - \frac{d\bar{\chi}}{dv} \partial v \right).$$

Now J. J. Thomson assumes (p. 97) that  $\bar{\chi}$ , in his notation *V*, is to be a function of *v* only, where it follows that

$$\partial \bar{\chi} - \frac{d\bar{\chi}}{dv} \partial v = 0,$$

as he says, and so

$$\frac{\partial Q}{T} = 2N\partial \log (iT),$$

which I submit as a form of his result (118). I understand Boltzmann in the treatise above cited to make the same

assumption. J. J. Thomson subsequently considers the case of  $\chi$  being a function of  $T$  as well as of  $v$  (p. 100). But he does not in this case make  $\frac{\partial Q}{T}$  a complete differential.

I think that in the general case we must regard  $\chi$  as a function of the unconstrainable coordinates, and as varying from one configuration to another, through which the system passes in the same stationary motion with constant  $v$ . When  $v$  becomes  $v + \partial v$  we do work in two ways. Firstly, we alter the value of  $\chi$  for each configuration, doing thereby on the whole an amount of work equal to  $\frac{d\bar{\chi}}{dv} \partial v$ . Secondly, we alter the comparative frequency of different values of  $\chi$  in the stationary motion. This is essential; for without this the system would not be in stationary motion with the altered values of  $T$  and  $v$ . I think J. J. Thomson had this in his mind when he made  $\chi$  a function of  $T$  as well as of  $v$  (p. 100).

Let, then,  $f, dx_1, \dots, dx_n$  or  $f, d\sigma$  denote the frequency of the configuration  $x_1, \dots, x_n$ , so that

$$\bar{\chi} = \int f \chi d\sigma, \quad \frac{d\bar{\chi}}{dv} = \int f \frac{d\chi}{dv} d\sigma,$$

and

$$\partial \bar{\chi} = \int f \partial \chi d\sigma + \int \chi \partial f d\sigma$$

$\partial f d\sigma$  referring to variation of the limits of integration

$$= \int \chi \partial f d\sigma + \frac{d\bar{\chi}}{dv} \partial v.$$

and so

$$\partial \bar{\chi} - \frac{d\bar{\chi}}{dv} \partial v = \int \chi \partial f d\sigma$$

and

$$\frac{\partial Q}{T} = 2N \partial \log (iT) + \frac{1}{T} \int \chi \partial f d\sigma.$$

Now how to make

$$\frac{1}{T} \int \chi \partial f d\sigma,$$

or

$$\int \frac{\chi}{T} \partial f d\sigma,$$

a complete differential?

If

$$B = \int f (\log f - 1) d\sigma$$

(Boltzmann's minimum function),

$$\int \log f \partial f d\sigma = \partial B + N \partial \log \tau,$$

and is a complete differential.

Hence one solution, and probably the only general solution, of the problem is obtained by making  $\log C_f$  proportional to  $\frac{\chi}{T}$ , or

$$f = C e^{-\frac{\chi}{T}},$$

where  $c$  is numerical. That gives

$$\frac{\partial Q}{T} = 2N \partial \log (iT) - \frac{1}{c} \partial B - \frac{N}{c} \partial \log \tau.$$

Since  $2iT$  is the Action of the system during the definite time  $t$ , we see that the second law stands in a certain relation to the principle of least Action. But I think the complete treatment of it must be based on the virial equation. And it may be regarded as the law of the variation of  $B$  when  $T$  and the controllable coordinates vary.

S. H. BURBURY.

THE LOSS OF H.M.S. "VICTORIA."

III.

LAST week we discussed the opinions expressed by the Board of Admiralty, in their Minute of the 30th of October, upon certain points that relate to the construc-

<sup>1</sup> Continued from p. 127.

tion and stability of the *Victoria*; but the remainder was left for consideration in the present concluding article.

*The value of an armour-belt at the ends for resisting damage.*—Their lordships say "the fact that the *Victoria* was not armour-belted to the bow had no influence upon the final result of the collision. No armour-belt could have prevented the ripping open of the bottom below water by the ram-bow of the *Camperdown*, and the flooding of the compartments to which water could find access through the breach." Mr. White argues strongly against the assertion, which he states has been made, that if a strong armour-belt had existed at the place where the blow was struck, the damage might have been greatly reduced and the ship kept afloat. He considers that all the most important compartments which were flooded in the *Victoria* must have been thrown open to the sea under the conditions of the collision, even if there had been such a belt. "The breach in the side might have been different in form and possibly less extensive, especially above water; but it must in any case have been of large extent, and have admitted very large quantities of water in a short time." Mr. White proceeds to argue that the extent to which the *Camperdown* penetrated into the interior of the *Victoria* was not altogether a disadvantage, as the *Camperdown's* bow thus became virtually locked in the protective deck of the *Victoria*, till the relative forward movement of the latter ship was destroyed and the tearing action of her spur upon the side of the *Victoria* was thereby prevented. "Under the assumed condition of a non-penetrable armour-belt, this relative forward movement and tearing action must have taken place." But the Admiralty cannot admit the assumption of impenetrability. Reference is made to cases of collision, such as those between *Vanguard* and *Iron Duke*, and between *Grosser Kurfürst* and *König Wilhelm*, which prove, in Mr. White's opinion, that "the existence of an armour-belt is no sufficient safeguard against injuries resulting from serious collision."

The objections that have been made to leaving so much of the ends of some of our first-class battleships unprotected by armour, have been mainly in connection with their defence against gun-fire. The gun is, and appears likely for some time to be, the weapon of attack which a battleship must be designed primarily to resist. The attack of the ram can often be evaded by speed or skilful handling; and that of the torpedo by watchfulness, tactical resource, and smart conduct on the part of the officers in command. The real defence against rams and torpedoes lies at present much more in the judgment and skill with which a ship can be safeguarded or manoeuvred by her officers, than in her own intrinsic power of resistance.

At the same time, it is obviously desirable that everything possible should be done to increase the amount of resistance that can be offered by a ship's hull to attack from ram or torpedo. The Admiralty say that an armour-belt would have no influence upon the final result of ramming. This statement is based upon two assumptions: (1) that "under a blow of such energy as was delivered on the *Victoria* the strongest armoured side ever constructed must have yielded and been driven in. Its water-tightness and that of the bulkheads, &c., within it adjacent to the place where the blow was struck, must have been destroyed, and the ultimate result (as regards the admission of water) would have been practically as serious under the same conditions of open water-tight doors, &c. as that which actually occurred in the *Victoria*"; and (2) that if the *Camperdown's* bow had been prevented by an armour-belt from penetrating to so great a depth as was stated into the side of the *Victoria*, her spur would have torn away much more of the bottom plating than it actually did.

The truth of both these assumptions appears very

questionable. With regard to the first, it is pointed out that the ram-bow of the *Iron Duke* drove the armour of the *Vanguard* bodily inwards more than a foot. The armour of the *Vanguard* was, however, only 6 to 8 inches thick, while the force of the blow with which she was struck is said to have been two-thirds of that delivered to the *Victoria*. The armour at the point where the *Victoria* was struck would have been 15 or 16 inches thick if she had been fitted with an armour-belt, while the energy of the blow delivered to her is stated to have been "about the muzzle energy of a 12-inch 45-ton B.L.R. gun, the estimated perforation of its projectile being about 22½ inches of wrought-iron armour." The armour of the *Victoria* was not, however, of wrought iron, but of iron faced with steel, on the "compound" principle, which offers much greater resistance to penetration than wrought iron.

Seeing that the depth of the armour-belt would be 7 to 8 feet, and its thickness 15 or 16 inches; and that the projectile referred to, whose energy is about equal to that of the blow delivered to the *Victoria*, only succeeds in penetrating the plate by concentrating its whole effect upon an area 12 inches in diameter, it does not appear that the armour ought to suffer much from a blow distributed over so much greater an area. The armour of the *Vanguard* was driven in because the supports in its rear were not strong enough to resist the blow. In our present ships the top of the armour-belt comes against the edge of a protective deck, which is 2½ or 3 inches thick, and could well be supported and connected to it in such a manner as to effectually resist being driven inwards; and it appears to be mainly a question of fitting a similar bearing at the bottom of the armour, in connection with the armour-shelf, to furnish sufficient resistance at the lower edge. Such an arrangement for supporting the armour would not be difficult to devise; and it does not appear impossible to thus construct an armour-belt, in a ship like the *Victoria*, that would resist being driven in by such a blow as she received; and would do so without necessarily causing the water-tightness of the bulkheads, &c. adjacent to the place where the blow was struck, to be destroyed by the shock of the collision. The fact is that armour-belts have usually been arranged exclusively for keeping out projectiles from guns, and not with the view of resisting ramming. Had the latter been regarded as an important function for armour-plating to perform, the lower edge of armour, which would receive the first force of the blow in many cases, would have been supported in the rear better than it now is, and probably somewhat in the manner indicated.

The second assumption upon which the opinion that an armour-belt would have been useless is based is that, by preventing the *Camperdown* from penetrating so far as she did into the interior of the *Victoria*, there would have been serious tearing of the bottom abaft the breach as the ships got clear of each other. In support of this it is stated that the bow of the *König Wilhelm* tore open the bottom of the *Grosser Kurfürst* for some distance abaft the first breach, owing to the speed with which the latter vessel tried to cross ahead of her. This tearing action would depend very much, however, upon whether the point of the ram would have penetrated far enough into the bottom below the armour-belt to keep the ships together for a sufficient time, and it is quite likely that it would. Anyhow, it is impossible to say what depth of penetration would be necessary for this purpose, especially as the ram bows of ships by which a British vessel might be attacked are very different in length and form; and it seems a doubtful process of reasoning which leads to the result that the great depth to which the side of the *Victoria* was penetrated might not have been considerably reduced with advantage.

But the objections that have been made to leaving so great a length at the ends of a battleship without armour are not, as we have said, with reference to their being rammed, but because of the damage to which they are thus exposed by gun-fire. The results of the Admiralty calculations show that the effect of gun-fire upon the unarmoured ends of such ships as the *Victoria* might be very serious. We are informed by Mr. White that the *Victoria*, as she was at the time of the collision, would change her trim 3 feet by the bow in consequence of 110 tons loss of buoyancy above the protective deck. It follows, therefore, that if the whole of the compartments above the protective deck were penetrated so as to admit water, there would be a loss of buoyancy sufficient to change her trim fully 5 feet by the head. The change of trim and extra mean immersion thus caused by the loss of buoyancy would bring the top of the armour-belt close to the water-line at its fore end; and the slightest inclination would then be sufficient to immerse the fore end of the armour-belt on its inclined side. Perforation of the thin side plating at this point above the armour would thus admit water into the ship over the top of the armour-belt, and lead to a growing loss of buoyancy and stability, both transverse and longitudinal, which would soon place the vessel in a perilous position. The destruction of such a ship does not thus appear very difficult by the large rapid-firing guns that are carried in cruisers and in the secondary batteries of battleships. These guns, firing twelve to twenty projectiles of 6 inches and 4½ inches diameter, per minute could be aimed with great precision at the water-line of a ship, and would very soon cause the whole of the thin partitions in the unarmoured ends to be penetrated through and through, and admit water freely into the whole of the compartments. If the vessel thus attacked were steaming ahead, at the slowest speed possible, the additional water that would thus be forced in would greatly increase the change of trim, and it would only be necessary to follow up the process of aiming at the water-line along the fore end, and over the top, of the armour-belt in order to soon disable or sink her.

The foregoing considerations may suffice to show that we see no sufficient grounds for believing the Admiralty to be right in the assertion that the absence of an armour-belt at the bow had no influence upon the final result of the collision in the case of the *Victoria*; still less that an armour-belt could not be made more effective than it now is against the attack of a ram; and still less, again, that an armour-belt of sufficient length to furnish all the buoyancy and stability necessary for safety would not afford a most powerful protection to a battleship against the destructive effects of the present rapid gun-fire.

*The sufficiency of the stability possessed by the ship.*—The Admiralty say "the capsizing of the *Victoria*, under the special circumstances described, does not suggest any insufficiency of stability in the design of that vessel. The provision made was ample for all requirements. When fully laden and in sea-going trim the metacentric height was 5 feet, stability reached its maximum at an angle of 34½ degrees to the vertical, and the range of stability was 67½ degrees." It will be observed that it is only the stability that would be possessed when the hull of the ship is absolutely intact that is here spoken of; and it is doubtless sufficient for that condition, and would enable the vessel to take considerable quantities of water on board without danger. This is not a point, however, which has great practical importance in connection with actual fighting requirements. In order to judge of the sufficiency of the stability under ordinary fighting conditions it is necessary to know what it would be when the thinly-plated ends and compartments outside the armour-belt are penetrated by projectiles. This is a

factor of such great importance to the problem, as to make the bare information with regard to the stability in the intact condition comparatively valueless. Whether the provision of stability was ample, in the *Victoria*, for all requirements, as the Admiralty assert, or is ample in existing ships of similar type, depends almost entirely, as regards the fighting requirements of a first-class battleship, upon what it is when the thinly-plated ends are penetrated. It is quite certain that damage to the ends would soon make demands upon the stability, which necessitate the provision of a large reserve in the intact condition for drawing upon, and that this reserve should be sufficient to cover not merely the heeling effect of water held over to one side by longitudinal partitions, but also the reduction of stability due to loss of buoyancy in compartments that are opened up to the sea, and the effect of speed of ship upon the quantity of water that might be admitted, and the position into which it might be forced. There is no necessity to look far in order to see that the stability could thus be seriously reduced very early in an action, and might soon become insufficient to enable the ship to be handled and fought as she should be, if not to place her in absolute peril.

*The steps that should be taken "to prevent the recurrence, under similar circumstances, of the conditions which, after the collision, resulted in the loss of the ship."*—The Admiralty considers that the only step requisite is to issue regulations to the fleet which will ensure "that, under special circumstances, and particularly when there is risk of collision, doors, hatches, &c. shall be kept closed as far as possible, and men stationed at any that are necessarily left open"; also, "that under certain conditions arising out of collision or under-water attack, the gun-ports and other openings in the upper structure shall be closed before water can enter and endanger the stability of the ship." Now, everyone acquainted with the Admiralty and the Navy must know perfectly well that this really leaves matters as they were. Officers in command of H.M. ships are quite aware that water-tight doors, hatches, &c. require to be worked in the manner described; but the difficulty is to do it, in any emergency that may arise, so as to be effective for the purpose. The great number of water-tight doors, the difficulty of properly securing some of them, and the necessity that exists for many to be frequently open in order to carry on the ordinary work of the ship, makes it practically impossible to ensure that safety can always be relied upon by such precautions. It is true that the *Victoria* would, in all probability, not have been lost if all the water-tight doors and hatches in the fore part of the vessel had been closed; but it does not therefore follow that a similar disaster can be prevented in future merely by an order from the Admiralty directing that all such doors, &c. are to be closed in future in sufficient time to keep water from passing out of one compartment into another.

We would recommend that the number of water-tight doors in the various compartments be reduced; that no door which is essential to efficient water-tight subdivision, and is ever required to be left open without attendance, be fastened merely by clips; that all doors which are relied upon for safety should be capable of being closed either by a satisfactory self-acting arrangement, or by appliances for working them from a deck at a safe height above water. We would also call attention to the danger of making the safety of a ship depend upon the complete closing of a large number of small compartments. The only arrangement that can be relied upon is one of subdivision into a series of main compartments, formed by bulkheads that are carried to a deck that is high above the water-line, which will be perforated as little as possible by doors, or by pipes, &c. below water. Such an arrangement as that in the *Victoria*,

where the efficiency of some of the divisional bulkheads, which appear to have formed part of the system of water-tight subdivision, depended upon the closing of scuttles in a water-tight deck only 3 feet above water, at which the bulkheads stopped, is manifestly untrustworthy; and it is impossible for the Admiralty to remedy its defects by promulgating orders to make it work.

So far as other ships of the type of the *Victoria* are concerned, the Admiralty does not see that the necessity for any improvement is indicated. We consider, however, as the foregoing remarks show, that the result of the ramming of the *Victoria* points clearly to the necessity of making the armour-belts longer in such ships if the armour is to be made really effective. This would increase the power of resistance to gun-fire, while the belts might be so fitted as to reduce the injuries likely to be caused by ramming. Water-tight flats at a small height above water, and thin bulkheads above water, are of little good against rapid gun-fire. Vessels with short armour-belts, such as the *Victoria* and others of her type, might, as has been pointed out, be destroyed by rapid gun-fire without any penetration of their armour; so that their defensive power is not measured by the resistance to penetration of the armour they carry. They thus belong more to the type that are called protected ships than to that of armour-clads; and it would probably be more correct to classify them as such. Their names now figure in the list of first-class battleships, and make our Navy appear stronger in this class of ships than it really is. If they were classed according to their real fighting value, the necessity for adding to the number of battleships would appear stronger than it now does to those who cannot judge the relative merits of ships.

Another lesson taught by the *Victoria* disaster appears to be that the officers of such ships should be more fully instructed with regard to the probable effects of various kinds of injury than they now appear to be. It is quite certain that the officers of the *Victoria* never imagined that the ship could sink so rapidly as she did, even with many of the water-tight doors open, or that her safety depended, to the extent it did, upon the absolute closing of so many small compartments. They require to be advised, and to obtain some experience as to the best mode of treatment under different conditions of damage. Would the captains of the ships with short armour-belts all know, for instance, whether it would be better or not to admit water into the ends before going into action? Has it been decided that it would be better to thus admit water, and prevent changes of trim as the thin ends become perforated by projectiles, or to keep water out as long as possible, and to submit to changes of trim and of heeling to one side or the other as the various compartments were opened up? The effect of loose water in the ends might be very objectionable if the speed of the ship were changing, or if she were rolling to any extent; but it would exist as soon as the ends became damaged; and it is clear that the presence of a large body of water in the long unarmoured ends of some of these ships would be a great source of difficulty in keeping speed and in manœuvring.

The general result of the Admiralty investigation, and of the judgment based upon it, is that there is no fault to be found with any single point connected with the construction and arrangements of the *Victoria*, or other ships of her type, for which those who conducted the investigations, or pronounce the judgment, could be held responsible; but that the whole blame is due to the one cause with which no one at the Admiralty could be in any way connected, viz. the failure to close all the water-tight doors, hatches, &c. in time to prevent the disaster. In saying this we do not wish to cast any doubt upon the accuracy of the calculations which have been made, or upon the desire of the Admiralty to arrive

at a fair decision upon the questions raised. It is impossible for persons who are deeply interested in these questions, and in the results of the investigation, to divest themselves of all feeling and bias, and to judge their own ideas and work from an absolutely impartial standpoint. It would probably happen in any inquiry, that if one of the parties implicated were allowed to draw up the judgment, the result would not be unfavourable to itself. Most people appear satisfied, however, that at this course should be taken when the question involved is that of the efficiency of the battleships upon which the defence of the British Empire would mainly depend in the event of war.

FRANCIS ELGAR.

#### THE NEW LABORATORIES OF THE INSTITUTE OF CHEMISTRY.

At length the members of the Institute of Chemistry may feel entitled to cry with Proteus, "Time is the nurse and breeder of all good," for now the object, kept steadily in view through evil report and good, though there was mighty little of the latter, has been achieved, and the Institute of Chemistry finds itself in the possession of a house with offices, council chamber, examination rooms, laboratories for examination, and everything handsome about it.

The successive councils are to be congratulated on the firmness with which they have resisted the numerous and persistent attempts which have been made by a somewhat important body of members to force the Institute into becoming a publishing and paper-producing body, thus adding another to the already too numerous chemical journals.

The Institute was not founded for this purpose: but the fact was forgotten again and again by those who were apparently unable to resist the temptation to spend the gradually accumulating funds of the Institute on "doing something," no matter what, but preferably holding meetings and printing a journal. The councils, however, proved wiser than some of their constituents, and held to the true view of their function, namely, that they were an examining and qualifying body.

Upwards of twenty years ago the passage of the Food and Drugs Act led to a series of appointments of public analysts that taken in the mass were little short of scandalous. The chemical profession had no corporate existence; it had never been consulted in the matter of drafting the Act, and the Government of the day, though having eminent chemists at command, never asked any advice. County and borough, corporation and vestry, were required to appoint "analytical chemists," and, left to their own sweet will in making the selection, with results that can be more easily imagined than described. It was this that literally forced the then small number of men who were practising chemistry professionally, to organise themselves with a view, not of undoing the mischief already done, for that was irreparable, but of gradually supplying a body of men whose qualifications were vouched for by a searching examination.

These examinations, at first held in town and at a number of provincial centres, have gradually concentrated in London, and the increasing number of examinees at length warned the council that the time had come when the Institute must be able to examine under its own roof.

The presidency of Dr. Tilden has been signalised by the carrying through of this project. After a prolonged search, suitable premises were found at No. 30 Bloomsbury Square, and the lease purchased. The House Committee, consisting of the President and Treasurer, with

Prof. J. M. Thomson and Mr. R. J. Friswell, immediately set about planning the laboratory, the architectural work being placed in the hands of Mr. H. V. Lancaster.

The immediately surrounding property being residential, it was of great importance to prevent any nuisance from the escape of fumes, and the committee, in view of the almost universal failure of most of the fume apparatus in existing laboratories, placed themselves in the hands of one of their members whose experience as a chemical manufacturer led him to adopt the novel expedient of treating the laboratory as an acid factory, and scrubbing and burning the fumes, the latter by means of a specially constructed furnace, which also causes the draught by which the fumes are removed. So far this arrangement appears to work well, and it will no doubt be watched with interest by future builders of laboratories.

When the premises were taken over they consisted of a house of 36 feet frontage and 45 feet depth. Behind this lay a space of 60 feet by 36 feet, partly covered by an old building, once no doubt a stable, and partly occupied by an area and a built-out basement kitchen, which had a very large chimney, built independently of the house chimneys, and about 95 feet high and 18 inches square. The old building being removed, there remained an area of 34 by 36 feet for the principal laboratory, while the basement kitchen could be easily converted into a combustion laboratory, and its tall chimney—a factory shaft on a small scale—utilised for ventilating the fume cupboards and working benches.

The house faces nearly due west, and this permitted the laboratory to be lighted entirely from the north. As it was not possible to erect a lofty roof, it was decided to divide it into three gables, each having one side of glass, the other, turned towards the south, slated and match-boarded inside. These unglazed sides rise at an angle of 40°, and are so prolonged that the glazed sides, rising at an angle of 60°, meet them at an angle of 80°, and the entrance of direct sunlight is thus prevented, and, except for a very short time in the middle of the day, at mid-summer. The main laboratory, 35 × 32 feet, is fitted with thirty-two working benches, and a desk for the examiner; two fume chambers and one bench of muffles being arranged at each end. It is lined throughout with white glazed bricks, the floor is of 2-inch pitchpine, and the working benches are of the same wood with mahogany edges, and tops saturated with high melting paraffin wax. Each bench has the necessary reagent shelves, seven drawers, and ample space with shelves beneath for the storage of large apparatus. It is also provided with two gas-cocks, a low-pressure water-cock, another for the supply of a condenser, and one high-pressure cock for a Sprengel filter pump. The sinks are circular, of salt-glazed stoneware, and so arranged that each supplies accommodation for four benches. Under each bench, below the floor level, runs an 8-inch Doulton pipe (which gives off 3-inch branches to each bench), and connects with a 12-inch main which runs along the front wall and descends to the level of the combustion laboratory floor, where it enters a salt-glazed stoneware tower packed with coke, and provided with a water shower. Passing up this, which is 2ft. 6in. diameter and 13ft. 6in. high, the washed fume is carried by another 12-inch pipe to the ground level again, and enters the ashpit of a furnace 4ft. × 1ft., which has fire-brick doors closing air-tight against planed cast-iron rims. Separate 8-inch pipes communicating with the 12-inch main go to each fume cupboard, and when the furnace is alight a most powerful draught, amounting to about 12,000 cubic feet of air per hour, is drawn from the benches and fume cupboards.

The stone muffle benches are each provided with a

small flue in the wall, and will accommodate eight full-sized gas muffles. All the gas, water, heating, and fume pipes, together with the drains, which have specially arranged intercepting tanks to prevent the loss of mercury or the carrying of solid matter into the sewers, are carried beneath the benches in an ample stone-paved recess below the floor level. There is an easy means of access to all these pipes by sliding out the bottoms of the apparatus stores, which are arranged below each bench, and protected by an iron foot-rail.

Air from outside is also admitted from the same space, and is thus slightly warmed before entering the laboratory. The glass lights in the roof can, if desired, be opened. Artificial light is provided by six powerful self-ventilating Wenham gas-lamps, but it is hoped in time to provide incandescent electric lights to each bench.

Just outside the laboratory is a balance room fitted with six Oertling balances; this room is small, but the exigencies of the site did not permit of a larger area. Opposite the balance room a spiral staircase enables the examiner in charge to at once descend to the combustion laboratory. This room,  $23 \times 13$ , is fitted with seven stone-topped combustion benches, each 4ft. 6in.  $\times$  1ft. 3in., provided with a  $\frac{3}{4}$ in. fullway gas cock. Behind this is a vault lighted by prism light in the laboratory floor, in which is placed a powerful high-pressure water heating apparatus. Outside in the area is a washing-up room, provided with requisite shelves, sink, &c., and supplied with gas, so that the rougher operations of a laboratory, the handling of carboys, storage of acids and bulky chemicals, &c., can there take place.

From the house the laboratory is entered by a corridor starting from the cloak-room. The latter is large and amply provided with all necessaries, and with it communicates a commodious and well-fitted lavatory, having hot and cold water and all necessary fittings.

Behind the office, a handsome oak-floored room in the house itself will serve as a suitable laboratory for gas analyses.

Besides the accommodation here described, the house contains fifteen large rooms and a fine entrance hall. On the ground floor the front room serves as the office. The first floor supplies two large council and committee rooms, while the basement furnishes the housekeeper with ample accommodation. It will thus be seen that there is plenty of room for expansion.

The proverbial delays of the law prevented the House Committee from getting to work until August had begun. Its members are to be congratulated on the work they have done, and the time, four months, in which it has been accomplished.

The opening of the laboratories took place on Friday, December 8, at one o'clock, when the President received a number of gentlemen, who subsequently inspected the new buildings. The company included Sir F. Abel, F.R.S., Dr. Bell, F.R.S., Dr. H. E. Armstrong, F.R.S., Dr. Russell, F.R.S., Prof. Ramsay, F.R.S., Prof. Hartley, F.R.S., Prof. Clowes, Mr. C. E. Groves, F.R.S., Prof. Meldola, F.R.S., Mr. R. J. Friswell, Mr. O. Hehner, Dr. T. A. Lawson, Mr. D. Howard, Mr. Ernest Hart, and many other gentlemen and representatives of the press. Letters and telegrams regretting absence were received from Sir W. Foster, M.P., Sir H. Roscoe, M.P., Mr. Fowler, M.P., Mr. Norman Lockyer, F.R.S., Prof. J. M. Thomson, the Duke of Bedford, &c.

At half past one the President delivered a short address dealing with the history and objects of the Institute, which now consists of 731 fellows and 104 associates, and has 200 registered students on its books. On the conclusion of this brief ceremony the laboratories being declared open, the President invited the assembled

company to luncheon, which was laid in the council rooms. Sir F. Abel proposed the President's health, to which Dr. Tilden briefly replied, after which the meeting broke up.

#### SCIENCE IN THE MAGAZINES.

DR. A. R. WALLACE contributes to the *Fortnightly* the second part of his article on "The Ice Age and its Work." He deals in detail with the erosion of lake basins, first describing the different kinds of lakes, and their distribution, and then the conditions that favour the production of lakes by ice-erosion. The objections of modern writers are afterwards considered *seriatim*, and the manner in which they are handled will give pleasure to all glacialists. The alternative theory to that of ice-erosion, for the origin of the class of lakes discussed, viz. that they were formed before the glacial epoch, by earth-movements of the same nature as those concerned in mountain formation, appears to be fairly presented, and the difficulties in the way of accepting it are pointed out. Evidence is adduced to show that the contours and outlines of the lakes in question indicate erosion rather than submergence, and, finally, the Lake of Geneva is taken as a test of the two rival theories. As the subject discussed is very complex, and the argument essentially a cumulative one, Dr. Wallace gives the following summary of the main points:—

In the first place, it has been shown that the valley lakes of highly glaciated districts form a distinct class, which are highly characteristic, if not altogether peculiar, since in none of the mountain ranges of the tropics, or of non-glaciated regions over the whole world, are any similar lakes to be found.

The special conditions favourable to the erosion of lake-basins, and the mode of action of the ice-tool, are then discussed, and it is shown that these conditions have been either overlooked or ignored by the opponents of the theory of ice-erosion.

The objections of modern writers are then considered, and they are shown to be founded either on mistaken ideas as to the mode of erosion by glaciers, or on not taking into account results of glacier-action which they themselves either admit or have not attempted to disprove.

The alternative theory—that earth-movements of various kinds led to the production of lake-basins in all mountain ranges, and that those in glaciated regions were preserved by being filled with ice—is shown to be beset with numerous difficulties, physical, geological, and geographical, which its supporters have not attempted to overcome. It is also pointed out that this theory in no way explains the occurrence of the largest and deepest lakes in the largest river valleys, or in those valleys where there was the greatest concentration of glaciers, a peculiarity of their distribution which points directly and unmistakably to ice-erosion.

A crucial test of the two theories is then suggested, and it is shown that both the sub-aqueous contours of the lake-basins, and the superficial outlines of the lakes, are exactly such as would be produced by ice-erosion, while they could not possibly have been caused by submergence due to any form of earth-movements. It is submitted that we have here a positive criterion, now adduced for the first time, which is absolutely fatal to any theory of submergence.

Lastly, the special case of the Lake of Geneva is discussed, and it is shown that the explanation put forth by the anti-glacialists is wholly unsupported by facts, and is opposed to the known laws of glacier motion.

The *Contemporary* is included among the magazines that we have received, and to it Mr. Herbert Spencer contributes a rejoinder to Prof. Weismann. "As a species of literature," he remarks, "controversy is characterised by a terrible fertility. Each proposition becomes the parent of half-a-dozen, so that a few replies and rejoinders produce an unmanageable population of

issues, old and new, which end in being a nuisance to everybody." If this opinion had come from anyone but one of the debaters it would have been ungracious. The questions at issue between Weismann and Spencer and Romanes have become so involved that some discrimination is required to unravel the tangled skein of argument. Mr. Spencer therefore confines his replies to those arguments of Prof. Weismann which are contained in his first article. The following points are of interest:—

Prof. Weismann says he has disproved the conclusion that degeneration of the little toe has resulted from inheritance of acquired characters. But his reasoning fails against an interpretation he overlooks. A profound modification of the hindlimbs and their appendages must have taken place during the transition from arboreal habits to terrestrial habits; and dwindling of the little toe is an obvious consequence of disuse, at the same time that enlargement of the great toe is an obvious consequence of increased use.

The entire argument based on the unlike forms and instincts preserved by castes of social insects is invalidated by an omission. Until probable conclusions are reached respecting the characters which such insects brought with them into the organised social state, no valid inferences can be drawn respecting characters developed during that state.

A further large error of interpretation is involved in the assumption that the different caste-characters are transmitted to them: in the eggs laid by the mother insect. While we have evidence that the unlike structures of the sexes are determined by nutrition of the germ before egg-laying, we have evidence that the unlike structures of classes are caused by unlikenesses of nutrition of the larvæ. That these varieties of forms do not result from varieties of germ-plasms is demonstrated by the fact that where there are varieties of germ-plasms, as in varieties of the same species of mammal, no deviations in feeding prevent display of their structural results.

Mr. Spencer also shows that for such caste-modifications as those of the Amazon ants, which are unable to feed themselves, there is a feasible explanation other than that given by Prof. Weismann. With regard to panmixia, he says:—

The tacit challenge I gave to name some facts in support of the hypothesis of panmixia—or even a solitary fact—is passed by. It remains a pure speculation having no basis but Prof. Weismann's "opinion." When from the abstract statement of it we pass to a concrete test, in the case of the whale, we find that it necessitates an unproved and improbable assumption respecting *plus* and *minus* variations; that it ignores the unceasing tendency to reversion; and that it implies an effect out of all proportion to the cause.

It is curious what entirely opposite conclusions men may draw from the same evidence. Prof. Weismann thinks he has shown "that the last bulwark of the Lamarckian principle is untenable." Most readers will hold with me that he is, to use the mildest word, premature in so thinking.

A short article on "Water Bacteriology and Cholera," by Mrs. Percy Frankland, appears in *Longmans' Magazine*. It deals chiefly with the value of sand filtration as a means of purifying water. The report of the cholera epidemic in Hamburg and Altona has strikingly proved that sand-filters offer a remarkable and obstinate barrier to the passage of disease organisms, as well as the ordinary harmless water bacteria. Here is a statement of the facts:—

These two cities are both dependent upon the river Elbe for their water supply, but whereas in the case of Hamburg the intake is situated *above* the city, the supply for Altona is abstracted below Hamburg *after it has received the sewage of a population of close upon 800,000 persons*. The Hamburg water was, therefore, to start with, relatively pure when compared with that destined for the use of Altona. But what was the fate of these two towns as regards cholera? Situated side by side, absolutely contiguous in fact, with nothing in their surroundings or in the nature of their population to especially distinguish them, in the one cholera swept away thousands, whilst in the other the scourge was scarcely felt; in Hamburg the deaths

from cholera amounted to 1,250 per 100,000, and in Altona to but 221 per 100,000 of the population. So clearly defined, moreover, was the path pursued by the cholera, that although it pushed from the Hamburg side right up to the boundary line between the two cities, it there stopped, this being so striking that in one street, which for some distance marks the division between these cities, *the Hamburg side was stricken down with cholera, whilst that belonging to Altona remained free*. The remarkable fact was brought to light that in those houses supplied with the Hamburg water cholera was rampant, whilst in those on the Altona side, and furnished with the Altona water, not one case occurred. We have seen that the Hamburg water, to start with, was comparatively pure when compared with the foul liquid abstracted from the Elbe by Altona, but whereas in the one case the water was submitted to exhaustive and careful filtration through sand before delivery, in Hamburg the Elbe water was distributed in its raw condition as drawn from the river.

Also in *Longmans'*, Sir John Evans writes on "The Forgery of Antiquities." From his history of ingenious frauds perpetrated in every branch of archæology we select the following:—

Of prehistoric antiquities, both in stone and bronze, forgeries are numerous, but it seems needless to enter into all the details of their character, and of the means that may be employed to detect their fraudulent origin. Suffice it to say that in the gravel-pits of the valley of the Somme and of the neighbourhood of London the manufacture of paleolithic implements takes rank as one of the fine arts. The chipping of the English forgeries is superior to that of the French, but in each case the lanceolate form is the favourite. The appearance of antiquity is usually given by a thin coating of fine clay, but at Amiens a plan of whitening the flint by long boiling in the family kettle has been introduced. . . . In some of the bone-caves of the Reindeer period, both in France and Germany, ancient bones have had designs engraved upon them by modern forgers, and ancient flint tools have been inserted in sockets of ancient bone so as together to form a composite falsification. Something of the same kind has been practised with regard to relics from the Swiss lake-dwellings, many of the bronze objects from which have also been imitated by casting.

Of neolithic implements forgeries are equally abundant, and in some instances equally difficult to detect. Large perforated axe heads when made of soft sandstone which could not possibly be used for cutting purposes, of course betray themselves; but the modern flint axes and arrowheads are not so easily distinguishable from the ancient. To the experienced eye there is, however, a difference both in the workmanship and the character of the surface, the ancient arrowheads having probably been worked into shape by pressure with a tool of stag's horn, and not by blows of an iron hammer. The grinding of the edges of modern imitations has usually been effected on a revolving grindstone; in ancient times a fixed stone was always used, on which the surface and edges of axes or hatchets were ground by friction.

"A Naturalist's Notes off Mull," by "Nether Lochaber," in *Good Words*, is a chatty account well worth reading.

*Blackwood's Magazine* contains a paper by Prof. Andrew Seth on "Man's Place in the Cosmos," being a criticism of Prof. Huxley's Romanes lecture on "Evolution and Ethics." Mr. J. Bickerdyke writes on "Successful Fish-culture in the Highlands." He explains some of the facts and principles which should be understood and considered before Highland fish-culture is attempted, and illustrates his subject with an account of some experiments made by Mr. Stewart at Kinlochmoidart.

An article on "Anthropometry as Applied to Social and Economic Questions" is contributed by Mr. C. Roberts to the *Humanitarian*. In it we note that the mean height of Fellows of the Royal Society is given as 5 feet 9.76 inches.

We have also received the *National Review* and the *Century*, but neither contains any articles of scientific interest.



## EXPERIMENTS ON FLYING.

IF we imagine the linear dimensions of a bird increased  $n$  times, its weight will be increased  $n^3$  times. On the other hand, the work necessary to keep it flying will, as Helmholtz has shown, increase  $n^2$  times.<sup>1</sup> Now, we can assume that the power, that is to say, the amount of

A second objection is that we see many birds—and especially the large birds—when soaring, evidently doing an extremely small amount of work, or none at all, but nevertheless moving rapidly, and even rising to great heights. It seems certain that the wind must do the work for them. The experiments of O. Lilienthal have shown how this is effected. He has made diagrams of the direction of the wind blowing over a plain, and has found it to be on the average three degrees upwards.<sup>1</sup> His idea is that the lower regions of the air are retarded by friction against the earth, and that it is therefore heaped up. Of course the rising air or an equal amount would have to come down again somewhere, and this might take place in calm weather. But however this may be, the wind in some way or other does the necessary work for soaring birds. With a bird of linear dimensions increased  $n$  times, this work, it is true, would only increase in proportion to the surface of the wings, that is, proportional to  $n^2$ , while the weight increases proportional to  $n^3$ . But for man there would be no difficulty in constructing the wing surface much larger in comparison than that of a bird.

The principal difficulty would lie in the management of the apparatus, in keeping the surface in the right position according to the variations of the wind, and according to the direction that one intends to follow. Perhaps it is not greater than the difficulty a skater meets with in keeping his balance while moving in the direction he pleases; but the consequences of a wrong movement are worse. O. Lilienthal seems to me to have taken a step in the right direction by trying to learn

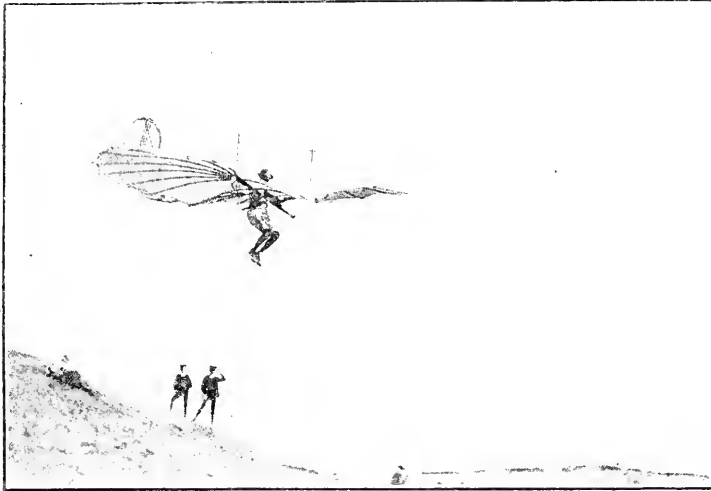

FIG. 1.

work that can be done in the unit of time, increases in proportion to the weight, or even less. Helmholtz, therefore, concluded that large dimensions are a disadvantage, and that there is a limit beyond which the power will become inadequate to the increased weight. This limit, in his opinion, is already attained in the largest birds, whose bodies appear to be constructed with the utmost economy in weight, and whose constitution and food seem adapted to furnish the highest power. And he therefore thought it improbable that man would ever be able to fly by his own power.

To these discouraging observations, however, some objections may be raised. First, the work necessary to keep a bird flying horizontally depends largely on its horizontal velocity. It decreases with increasing velocity up to a certain limit, when, on account of the friction, too much work must be spent on the horizontal component of the movement. The air will carry a body moving horizontally better than a stationary one, for the same reason that thin ice will sometimes carry a skater, but break under his dead weight. The moving skater is carried as if he rested on long skates that spread his pressure over a large area. The work which is expended in flying horizontally with a sufficiently high velocity may, in spite of Helmholtz's observations, be quite within the reach of human power. The difficulty, then, would only be to start and to arrive at this velocity, and this difficulty might be met by special contrivances. The size of a flyer might therefore be increased many times without losing the possibility of quick horizontal flight, though birds must be able to do without such contrivances for starting and arriving at the necessary velocity.

<sup>1</sup> Helmholtz, *Gesammelte Abhandlungen*, bd. 1, p. 165.



FIG. 2.

soaring.<sup>2</sup> The accompanying illustrations, which are reproductions of instantaneous photographs taken in Steglitz, near Berlin, show the way he slides down a

<sup>1</sup> O. Lilienthal, "Der Vogelflug," p. 115; see also No. 55 of *Prometheus*, p. 37.

<sup>2</sup> See his article in Nos. 204 and 205 of *Prometheus*, from which the illustrations are taken.

slight decline of 10° or 15°. The shape of the wings is not flat but slightly curved. The experiments recorded in his book, "Der Vogelflug," show that the curved form has decided advantages both as regards the amount and the direction of the resistance. The wing surface is 15 square metres. It is not safe to take a larger surface before having learnt to manage a smaller one. He takes a sharp run of four or five steps against the wind, jumps into the air, and slides down over a distance of about 250 metres. By shifting his centre of gravity relatively

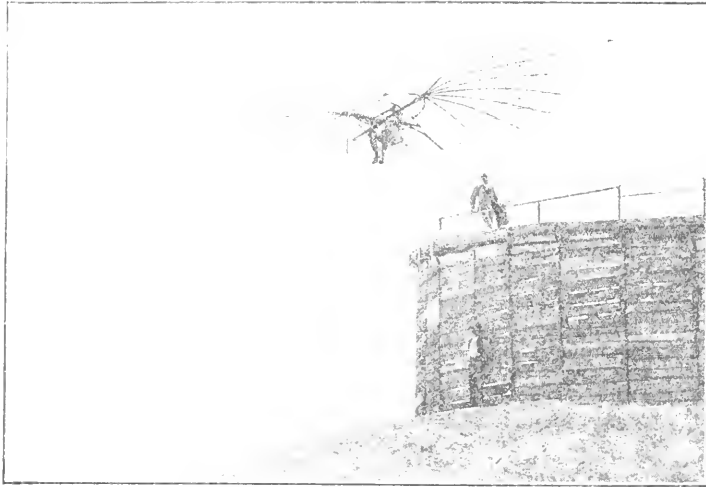

F.

to the centre of resistance he can give the wing surface any inclination, and thereby can, to a certain extent, either slide down quicker, or slacken the movement, or alter the direction. If the wind is not too strong, and the surface of the apparatus not too large, I think there is very little danger in this kind of practice. If it is taken up by a great many people, improvements of the apparatus are sure to follow, and the art of keeping one's balance in the air will be developed. Perhaps this is the road to flying. At any rate it must be fine sport.

C. RUNGE.

#### NOTES.

THE funeral of the late Prof. Tyndall took place on Saturday, in the parish churchyard at Haslemere. It was the desire of Mrs. Tyndall that the assemblage upon that sad occasion should not be large, so the mourners were chiefly Tyndall's close friends. Among them were the following men of science:—Prof. Huxley, Sir Joseph Hooker, Sir James Crichton Browne, Lord Rayleigh (representing the Royal Institution), Sir John Lubbock, Prof. Michael Foster (representing the Royal Society), Prof. Rucker (representing the Royal College of Science), Prof. Williamson, the Hon. Rollo Russell, Mr. Alex. Siemens (representing Sir William Siemens), Dr. Bazzard, and Dr. Atkinson. These mourners are eminent in many different branches of science; and it is hardly too much to say that their presence not only marked the regard in which Tyndall is held in our best scientific institutions, but also testified to the grief of all students of natural knowledge at the loss of one of the pioneers of the scientific movement in England.

A SPECIAL general meeting of the members of the Royal Institution will be held on Friday, December 15, to pass a vote of sympathy and condolence with Mrs. Tyndall on the occasion of

the death of Dr. Tyndall, who was Honorary Professor of Philosophy of that Institution.

THE death is announced at Paris of the biologist Dr. Chabry, known for his work in experimental teratology.

THE Muséum d'Histoire Naturelle lost its able conchologist, M. Paul Fischer, on the 29th ult. He was born at Paris in 1835, and entered the palæontological laboratory of the Museum in 1861, remaining there until his death. The list of his contributions to the literature of science contains no less than three hundred titles, among which may be mentioned his "Histoire des Mollusques du Mexique," and the "Manuel de Conchyliologie," written in collaboration with M. Crosse.

THE friends of Dr. Julius Hann, of Vienna, will be glad to learn that he has received from the Emperor the rare decoration for science and art (*Ehrenzeichen für Wissenschaft und Kunst*). This corresponds to the Order Pour le Mérite in Prussia, but is bestowed very charily, the total number of holders of it being only about a dozen. The actual decoration received by Dr. Hann had been set free by the death of Prof. J. Stefan, the physicist.

PROF. RIGGENBACH has been elected a Correspondent of the Paris Academy, in the place of the late Dr. Colladon.

DR. J. RUSSELL REYNOLDS, F.R.S., has been elected President of the Royal Col-

lege of Physicians, in the place of the late Sir Andrew Clark.

THE eleventh International Medical Congress will be held in Rome, from March 29 to April 5, 1894.

A REUTER'S telegram from Berne announces that the Federal Council has decided to introduce the time of Central Europe into the Swiss postal telegraph, railway, and steamship services on June 1, 1894.

A PRIZE of 3000 liras is offered by the R. Istituto Veneto di scienze lettere ed arti, for the most important innovation in Venetian pisciculture. The research for which the prize will be awarded may relate to the artificial hatching of the eggs of any important species of marine fish, the introduction of new species, improvements in methods of ostriculture, or the production of better kinds of fish.

FOR some time negotiations have been in progress for the purchase of the Little Barrier Island, with a view to setting it apart as a home for New Zealand fauna. We are glad to learn that the island has now been obtained from its owner, and that there is nothing to prevent the scheme being carried into effect.

THE *New Bulletin* (Appendix i. 1894) contains a list of seeds of hardy herbaceous plants and of trees and shrubs available for exchange with colonial, Indian, and foreign Botanic Gardens, as well as with regular correspondents of Kew. No application for seeds can be entertained after the end of next March, except from remote colonial possessions.

THE Director of the Botanic Garden of Rio de Janeiro has prepared and issued a list of plants cultivated there, and offered in exchange. A descriptive catalogue will shortly be published containing a description of each separate species in the Garden.

THE weather during the past week has been very unsettled over the whole of the British Isles, owing to the approach of several large depressions from the Atlantic. On the 6th a large disturbance passed eastwards to the north of Scotland, causing south-westerly gales in the north and west, and during the night of Thursday, the 7th, another deep depression advanced from the south-westward, attended by serious gales in all parts, but of great severity in Scotland and in Scandinavia. The barometer at Stornoway fell to the exceptionally low reading of 27.97 inches during the afternoon of the 8th, giving a difference in the pressure of nearly an inch and a half between the extreme north and south of our islands. Further disturbances arrived from the westward both on Sunday and Tuesday, again causing gales from the south-east and south. The storm on the latter day was chiefly restricted to the southern parts of England and the northern parts of France, and has not been exceeded in violence by any that has visited our southern counties this season. Several places reported force 11 of the Beaufort wind scale. Much rainfall and some sleet accompanied these various disturbances; in the north of Scotland 1.2 inch of rain was measured on the morning of the 9th, and the Meteorological Office Reports for the week ended the 9th inst. show that in that district the rainfall greatly exceeded the average, the total amount being 2.6 inches, while in most of the English districts the fall was less than the average.

It is now known that the earthquake which affected Tashkent on November 5, was also felt in other parts of Russian Turkestan. At Samarkand it was felt one minute later than at Tashkent—that is, at 8. 23½ n. a.m., and pretty strong oscillations of the soil lasted for about 1½ minutes. Crockery was shattered, and the water in the ponds and irrigation canals was set in motion. At Marghelan the strongest shock took place at 9h. 35m., and lasted for about five seconds; it was followed by a feebler one about three minutes later.

ON November 5, the magnetic instruments at Potsdam were disturbed in a manner which showed that a distinct earthquake had reached the observatory. The supposition that such a cause produced the movements of the needles was afterwards confirmed by the record of the seismometer of the geological laboratory of the Faculty of Sciences at Grenoble. From the magnetic curves at Potsdam it appears that the wave reached the observatory at 5h. 4m. 50s. a.m. (Potsdam mean time), and produced the greatest effect at 5h. 5m. 55s., a vibration also being recorded at 5h. 7m. 15s. According to *Comptes Rendus* of November 6, the shock was first felt at Grenoble at 4h. 50m. 35s. (Potsdam time), hence the time taken to travel a distance of about 956 kilometres was 8m. 15s. The rate at which the wave was propagated was therefore about 1.94 kilometre per second. It is estimated that the time can be read off from the magnetograph curves with an accuracy of ten seconds.

A FEW months ago the President of the Alpine Club invited the co-operation of the Government of India in obtaining a record of observations on the movements of glaciers in the Himalayan Range, to supplement a similar record maintained of the movements of glaciers in Europe. Believing that such a record would prove of importance to geological and meteorological science, the Government have communicated with officials and others who are stationed in or near the snows, or who may visit from time to time the glacial regions of the Himalayas. Copies of the Alpine Club's memorandum of instruction in glacier observation have been forwarded to the Foreign and Military Departments of the Government of India, the Governments of the Punjab, North-Western Provinces, and Oudh and Bengal, the Meteorological Reporter, and the Director of the Geological

Survey, for distribution to such officers as may be in a position to supply the requisite information. The energetic action of the Indian Government in the matter deserves high praise, and it will doubtless result in some interesting data being obtained.

A COPY of the splendid volume published in honour of M. Pasteur's jubilee has been sent to us. It opens with a brief account of the formation of the memorial committee; this is followed by a reprint of the address delivered by M. C. Dupuy at the jubilee celebration, and of the numerous addresses and telegrams received from all parts of the world. The volume also includes five beautiful plates, three of which represent medals struck in M. Pasteur's honour, one the investigator himself in his laboratory, and one is a fac-simile of the address presented by the Stockholm School of Medicine. This testimony of the esteem in which Pasteur is held brings to our mind the words, "Wisdom raineth down skill and knowledge of understanding, and exalteth them to honour that hold her fast."

AT the Adelaide meeting of the Australasian Association for the Advancement of Science, a lecture was given by Mr. C. W. de Vis, on the "Diprotodon and its Times." Popular interest has lately been aroused in this subject owing to an important discovery of fossil marsupial bones at Lake Mulligan. Mr. de Vis pointed out the mistake of the current idea that the Diprotodon was a gigantic kangaroo, any great resemblance between the two being confined to the teeth. In general build, Diprotodon was more like a wombat, but the bones of the thigh were even longer in proportion to those of the lower leg than is the case in the wombat, hence it might be concluded that the Diprotodon was less capable of rapid motion than the wombat. The spongy texture of the bones of the skeleton indicates that it frequented lakes and marshes. There were two species of Diprotodon found in Central Australia—*D. australis*, Owen (circa 6 feet high and 10 feet long), and *D. minor*, Huxley (circa 5 feet high and 8 feet long). The arid central plains of the present had been occupied in Diprotodon times by vast extents of luxuriant forest and richly vegetated districts, well-watered by wide rivers. The marsupials were even then the dominant type of life in Australia: lizards were also numerous, and some were of unusually large proportions, e.g. *Megalania*, an extinct "guana," 18 to 20 feet in length. Extinct forms of alligators and turtles infested the waters, and amongst the fishes was the still existing *Ceratodus*. The remains of a varied bird fauna have been well preserved in the same deposits. This fauna included some ancestral forms connecting, on the one hand, the wingless birds of New Zealand with the Australian emus, and, on the other hand, the Australian birds with the New Zealand Apteryx. Mr. de Vis was inclined to attribute the disappearance of so many of these ancient forms of life from Australia quite as much to senile decay as to altered climatic influences.

THE slow ascensional movement of Scandinavia, evidenced by the displacement of tide marks, the peculiarities of Scandinavian lake fauna, and other geographical and geological phenomena, is subjected to mathematical investigation by M. A. Badonrean, who, in the *Comptes Rendus* of last week, treats the subject from the point of view of thermal expansion. At the time of the last glacial epoch, the Scandinavian ice-sheet covered the greater portion of the peninsula, as well as Finland and the Baltic, the area of this sheet being about 1500 km. in diameter. Where the soil touched and partly liquefied the mass of ice, its temperature must have been 0° C. At the present time, the mean temperature of the soil over the area of the ancient ice-sheet is 3° C. Taking the coefficient of expansion of the rocks as eight-millionths, the elevation of the centre of the ice-cap is calculated at 229 m., and the isonabatics, or lines of equal

elevation, should be parallel to the contour. De Geer's map of these isoanabatics, traced in 1890, satisfies these conditions, allowance being made for the want of homogeneity in the rocky mass, and the want of fixity of its borders.

AN interesting account of a fine series of glacial potholes on Cooper's Island, Little Harbour, Cohasset, U.S., is given by Mr. William O. Crosby, in a paper on the "Geology of the Boston Basin" (Occasional Papers of the Boston Society of Natural History, IV.). It is shown that the potholes were formed by *moulin*s, or glacier mills, and Mr. Crosby discusses a question raised in these columns a short time ago, viz. why, as the ice-sheet moves continuously forward, carrying the crevasses and *moulin*s with it, the potholes escape elongation in the direction of the movement? The true explanation of many glacial potholes is found in the fact, that a crevasse closes as it is carried forward by the general movement of the ice, a new one subsequently being formed just where in relation to the land at the margin of the glacier the former one existed. This explanation, however, is not applicable to the Cohasset potholes, and in place of it Mr. Crosby makes the suggestion that a *moulin* may remain approximately stationary, while the ice moves on, through the backward erosion and melting of its up-stream side; and that when a pothole is formed at the bottom of a *moulin*, it is not the direct impact of the water upon the face of the ledge that does the work, nor do the stones carried down by the water wear the ledges appreciably by their direct fall, but the pothole is due to their subsequent movement, and especially their rotation, by the water. This rotation implies an antecedent depression or hollow to hold the stones, and thus the conditions are seen to be essentially the same as for ordinary river potholes. Since the rotation of stones in a pre-existing hollow appears to be an essential condition of glacial as of other potholes, and the *moulin* simply supplies the power, it would seem to make little or no difference whether the water plunges into the up-stream side, the middle, or the down-stream side of the hollow. The pothole is made where the hollow exists, and during the progress of a *moulin* across the hollow, there would not, apparently, be any marked tendency to elongate it. In the case of a linear group of potholes on the ice slope of a ledge, concludes Mr. Crosby, it is reasonable to suppose that the upper one, which on Cooper's Island is always the smallest and most indefinite, marks the shifting position of the *moulin*, and that the others were formed by the subglacial flow of water from the bottom of the *moulin*.

It has been supposed, says Mr. A. J. Jukes-Browne, in the *Geological Magazine* for December, that the total amounts of silica existing in the chalk with flints and the chalk without flints respectively, are very nearly equal; and this supposition favours the theory that flints have been formed by some process of segregation after the consolidation of the chalk containing them. It is generally conceded that the silica from which such flints were made was a soluble form like that of sponge spicules, diatoms, or radiolaria; hence by chemical analyses, aided by microscopical discrimination between crystalline and colloidal siliceous particles, it is possible to determine whether flintless chalk always contains soluble silica, and whether chalk with flints contains little or none. Mr. Jukes-Browne has made this investigation, and he finds that there is no definite relation between the occurrence of flints and the absence or presence of soluble silica in the surrounding chalk. He thinks that chalk which is now destitute of any remains of siliceous spicules, has, since it became chalk, always been destitute of such spicules. These conclusions have a very important bearing upon the question of the formation of flints.

In a recent number of the *Comptes Rendus*, M. A. Delebecque gives the results of some observations made last summer on water from various depths in inland lakes, which show that the amount of solid matter in solution increases with the depth. Thus in the lakes quoted below the amount of dissolved solid matter in grammes per litre was:—Anney, surface 0.138, bottom (65 metres) 0.157; Aiguebelette, surface 0.114, bottom (71 metres) 0.1605; Nantua, surface 0.154, bottom (43 metres) 0.190; Saint-Point, surface 0.152, bottom (40 metres) 0.182; Remoray, surface 0.1605, bottom (27 metres) 0.205; Crozet, surface 0.0275, bottom (37 metres) 0.0368. The water samples were collected about 3 metres above the bottom, by means of Dr. H. R. Mill's water-bottle. M. Delebecque agrees with Dr. Duparc, of Geneva, that the small amount of dissolved matter in the surface water is due to its removal by the calcareous organisms which swarm in the upper layers.

THE *Philosophical Magazine* for December contains a paper, by Sidney J. Lochner, on the elongation produced in soft iron by magnetisation. The author undertook the investigation of this subject in order, if possible, to settle whether the experiments of Bidwell or Berget represented what really happens. In order to measure the elongation, what was essentially a Michelson's interferential refractometer was made use of, which was capable of measuring an elongation of a millionth of an inch. The bar of iron, whose elongation was to be measured, was placed inside a long magnetising coil, and carried at one end one of the mirrors of the refractometer. The expansion due to the heating effect of the coil being slow, while that due to magnetisation was rapid, the two could be distinguished. The author finds that, for a given magnetising field, different elongations are produced according to the manner in which the magnetising current is applied. Thus different elongations were produced in the cases where the current had been turned on suddenly, or had been applied gradually; and in the latter case it made a difference whether the current had reached its final value by increasing slowly, or by decreasing slowly from a higher value. Another peculiarity observed was that if the current be gradually increased from zero, at a certain point a maximum expansion is reached; after this a further increase of the current will produce a decrease in the elongation; if, however, instead of increasing the current when the maximum is reached, it is gradually decreased, it is possible to obtain a still greater elongation. The observations show that the expansion is a function of the ratio between the diameter and length of the bar, and that the elongation varies approximately directly as the square root of this ratio; also, the expansion varies directly as the permeability. The amount of current required to produce the maximum expansion also depends on the ratio between the diameter and length.

THE bacterial efficiency of porous cylinders in the filtration of water for domestic purposes is the subject of considerable discussion just now. Kirchner (*Zeitschrift f. Hygiene*, vol. xiv. p. 307) found in his experiments with water purposely infected with typhoid bacilli, that such filters were incapable of arresting these organisms. Large quantities of typhoid infected broth were added to the water before filtration, and the filtrate after 48 hours was found to contain very large numbers of typhoid bacilli. Dr. Schöfer, in a recent number of the *Centralblatt f. Bakteriologie*, vol. xiv. p. 685, gives the results of his investigations of porous cylinders as regards their retention of typhoid bacilli. In these experiments as small a quantity as possible of nutritive material was added with the typhoid organisms to the water (previously sterilised), and even after 24 days the filtrate was found to be perfectly sterile, although the unfiltered water was freshly infected with typhoid bacilli no less than twelve times during the investigation. Very different results were,

however, obtained when broth was purposely added to the unfiltered water, an addition of as little as 5 c.c. to 600 c.c. of water so stimulating the growth of the typhoid organisms, that two days later they appeared in the filtrate; the numbers present, however, gradually decreased, but on again adding 5 c.c. of broth they rose on the following day from 9 to 6,139 per c.c. This large increase was due to the rapid multiplication of the few isolated bacilli still remaining in the pores of the filter in consequence of the supply of food material to the water in the shape of broth, for no fresh infection with typhoid organisms had taken place. Dr. Schöfer is of opinion that typhoid bacilli as present in water, under ordinary circumstances, are not supplied with the requisite conditions for their growth and multiplication, and are, therefore, incapable of growing through these porous filters, and so reaching the filtrate; but these conditions are, however, undoubtedly furnished when a sufficient supply of food material is contained in or added to the water, under which circumstances the cylinders are unable to retain them. These experiments not only explain the unsatisfactory results obtained by Kirchner, but indicate what precautions should be taken in the bacteriological investigation of such filters.

THE last two parts of the well-known "Notes from the Leyden Museum," forming parts 3 and 4 of vol. xv., were published in July and October. They contain numerous papers describing new or rare species of mammals, birds, reptiles, &c., added to the museum. Among the articles we notice one which is by F. E. Blaauw, the Secretary of the Zoological Society of Amsterdam, on a comparative list of the birds of Holland and England. Holland, although so much smaller than the United Kingdom, is the regular abode, at different seasons, of 221 species of birds, whilst the British Islands can only boast of 211. Dr. R. Horst continues his descriptions of earth-worms, giving a list of species found, for the most part by Dr. H. ten Kate, during his journey in the Malay Archipelago in 1891. A large number of the species belong to the genus *Pericheta*, of which no less than seven species are described as new, bringing the number of the species of this genus already found in the Malay Archipelago to thirty-three. The following note, by Dr. Jentink, will be interesting to others besides book collectors. In the Proceedings of the Zoological Society of London for 1880 (p. 489), Mr. F. H. Waterhouse gives the dates of the publication of the parts of Sir Andrew Smith's "Illustrations of the Zoology of South Africa," and states that as the copy he examined "did not contain plates 18 and 38 (Mammalia), he had examined three or four other copies, and as neither of these plates are to be found in any of these, he presumed they do not exist." Now, in the copy in the Leyden Museum's library, plate 38 is present, but plates 18 and 37 are wanting, and at the bottom of the page containing an index of the Mammalia, there is the following: "Plates 18 and 37 not published." Librarians will call to mind how often the collating of this fine work has perplexed them.

THE Royal Meteorological Institute of the Netherlands has recently issued its *Jaarboek and Onweers in Nederland* for the year 1892. The first work has been regularly published for forty-four years, and now contains hourly observations taken at four stations, in addition to those taken at specified hours at a number of other places. It also contains observations taken in Surinam (South America) and French and Upper Congo. The second work is the thirteenth of the series, and contains a discussion of each of the thunderstorms which have occurred during the year, with reference to the general weather conditions over Europe.

WE have received from Mr. John Elliot, the Meteorological Reporter to the Government of India, the daily weather charts of January, 1893, for the Indian sea and land areas.

MM. J. B. BAILLIERE ET FILS, Paris, have issued an ornithological bibliography containing announcements of five or six hundred works on ancient and modern birds.

HERR MORITZ, Berlin, has published Nos. 1-4 of his "Antiquariats-Katalog." The catalogues are of special interest to geographers and anthropologists, and they contain many rare works.

MESSERS. FRIEDLÄNDER AND SON, Berlin, have sent us Nos. 16-21 of their "Naturæ Novitates." These bibliographical lists contain works in every branch of science, and are invaluable to the scientific book-hunter.

ANOTHER catalogue, recently issued, is one containing the titles of works on geology offered for sale by Messrs. Dulau and Co.

THE first number of the *Psychological Review* will be published early in January, by Messrs. Macmillan and Co., London and New York. It will be edited by Profs. J. Mark Baldwin (Princeton) and J. McKeen Cattell (Columbia). The *Review* is intended to contribute to the advancement of psychology by publishing the results of original research, constructive and critical articles, &c., in connection with the subject.

THE *American Naturalist* for November contains several interesting articles. Mr. Howard Ayers writes on the genera of the Dipnoi Dipneumon, and Dr. J. Weir gives a number of examples of animal intelligence. A collection of molluscs from North-Western Louisiana is described by Mr. T. Wayland Vaughan, and Mr. H. C. Mercer compares the Trenton and Somme gravel specimens with ancient quarry refuse in America and Europe.

MESSERS. NEWTON and Co. have issued a new catalogue of optical lanterns, microscopes, and polariscopes for demonstrations in science. There are very few class experiments that do not admit of being projected upon a screen by means of the many good lanterns in the market, and certainly there is no better method of demonstrating scientific facts to a large audience. One of the finest lanterns made by Messrs. Newton is the triple rotating electric lantern designed by Sir David Salomons. We learn that the Royal Society has just ordered an instrument of this kind.

A GENERAL method of artificially preparing crystallised anhydrous silicates similar to the naturally occurring pyroxenes, is described by Dr. Hermann Traube in the current *Berichte*. It consists in precipitating the particular metallic silicate, which it is desired to obtain in anhydrous crystals, by the addition of a solution of sodium silicate to a solution of a salt of the metal. The amorphous hydrated silicate thus precipitated is heated to a high temperature with boric acid for some hours. When most of the boric acid has volatilised, the anhydrous metallic silicate is usually left in the form of good crystals. Ebelmen has already succeeded in artificially preparing the magnesium pyroxene  $MgSiO_3$  by this method; and Dr. Traube now extends its application. When precipitated silicate of zinc, for instance, obtained by the addition of a solution of sodium silicate to one of zinc sulphate, is dried, and then heated with eight times its weight of fused boric acid, in a platinum crucible, for a few days, to the highest temperature of a porcelain manufacturer's furnace, a large proportion of the boric acid disappears by volatilisation, and upon extraction of the remaining portion from the cooled residue with water, beautiful little insoluble crystals of anhydrous silicate of zinc,  $ZnSiO_3$ , remain. When examined under the microscope these crystals are observed to be perfectly transparent prisms with domal terminations. Their optical characters indicate that they belong to the rhombic system of symmetry. This artificial silicate of zinc would thus

appear to be isomorphous with the naturally occurring magnesium silicate, enstatite,  $MgSiO_3$ . The method is also applicable to the synthesis of complex mixed silicates, and it is possible by means of it to reproduce almost any of the naturally occurring silicates of this class.

At the last meeting of the Southern District Association of Gas Engineers and Managers, Dr. L. T. Thorne gave an account of further experiments with the new process for enriching coal gas by means of oxy-oil gas. Dr. Thorne has been enabled to carry out an exhaustive series of tests at Huddersfield, where the process is now in actual operation. His conclusions are summarised as follows: (1) The addition of oxygen to oil gas, preferably while the latter is still hot, not only increases the illuminating value of the oil gas when employed directly as illuminant, but also when it is used for purposes of enrichment. (2) Oxy-oil gas is a highly permanent gas, and when used as an enricher of coal gas actually increases the stability of that gas. (3) Enrichment of coal gas by oxy-oil gas would cost about one-third of a penny per candle per thousand cubic feet. Dr. Thorne concludes by expressing the opinion that the experimental results place oxy-oil gas at the head of the enriching processes yet known, and fully justify the favourable view of the process which was expressed in an earlier communication. With regard to the actual working of the Huddersfield plant, we learn from *London*, the organ of the London County Council, of November 30, that the Huddersfield Corporation have now used the new gas continuously for over two months, and have obtained a steady white flame, affording a better light, while enabling a saving to be effected at the rate of £10,700 per annum. They are now using 36,000 cubic feet of the new gas per day for enriching the ordinary product. They have been in the habit of enriching their ordinary gas, which is of about sixteen candle power, to the extent of four additional candles, by means of cannel coal. The cost per candle at Huddersfield, using Yorkshire cannel, has been about three-halfpence per cubic foot. With the new plant of the oxy-oil process the actual working cost is at present less than a halfpenny per candle per thousand cubic feet, and will eventually be still less by thirty per cent. or more, as crude petroleum is rapidly becoming cheaper. Moreover, the coke produced from cannel coal is so useless that the Huddersfield Corporation have been unable to dispose of it, even to give it away. Under the new process they find no difficulty in selling all the coke they can produce, for seven shillings and sixpence per ton. The saving due to enrichment amounts to £7,700 per annum, and the gain from sale of coke to £3,000, results which will have the practical effect of reducing the price of gas to the consumers at Huddersfield by at least threepence per thousand cubic feet, while supplying them with a more cheerful light which is stable even in winter.

NOTES from the Marine Biological Station, Plymouth.—There has been little that is novel to record lately, owing to the inability of our small boats to face the stormy seas. Last week several specimens of the Teleostean *Stæna umbra* were brought in, and the Nematode *Eugenia curia* (second capture) and the Crustacean *Gebia stellata* were taken in the Sound. The floating fauna is poor as a rule, but there is an increasing number of Annelid trochospheres, *Siphonantes* and Opisthobranch veligers. There is a noteworthy scarcity of Medusæ. The Anthozoa *Agonium digitatum* and *Cereres palmulatus* (= *Saxotia bellis*), and the Crustacea *Pandanus annulicornis*, *Cragon vulgaris*, and one-year-old *Carcinus maenas* have begun to breed.

THE additions to the Zoological Society's Gardens during the past week include a Pale-headed Parrakeet (*Platyercus pallidiceps*) from North-East Australia, presented by Mr. C. B.

Lewis; two Common Crossbills (*Loxia curvirostra*), a Song Thrush (*Turdus musicus*) British, presented by Mr. H. C. Martin; two Alligators (*Alligator mississippiensis*) from the Mississippi, presented by Mr. Austin E. Harris; a Chacma Baboon (*Cynocephalus porcellarius*, ♀) from South Africa, presented by Mrs. Rowland Tomson; two Leopards (*Felis pardus*) from India, deposited; thirteen Rufous Tinamous (*Rhynchctus rufescens*) from Brazil, purchased; a Japanese Deer (*Cervus sika*, ♀) born in the Gardens.

#### OUR ASTRONOMICAL COLUMN.

##### NEW NOTATION FOR LINES IN SPECTRUM OF HYDROGEN.

—The application of the photographic plate to that important instrument of physical astronomy, the spectroscope, has brought to our view, in addition to the four well-known lines of hydrogen in the visible part of the spectrum, another set of similar lines, the first of which, having a wave-length less than that of  $H_1$ , coincides with one component of  $H_2$  of the broad double line in the solar spectrum which Fraunhofer termed H. The second component, written  $H_2$  or K, is wanting in many stars of Vogel's class Ia; yet its coincidences with the line  $H_2$  or K, where in this class another line in the region of  $H_1$  makes its appearance, became established, so that no opportunity offered itself to make a special nomenclature for the two first lines above  $H_1$  outside of the star's spectrum situated in the violet region. The other lines Huggins named with the Greek characters  $\alpha$ ,  $\beta$ ,  $\gamma$ , &c. A new system of nomenclature, suggested by Prof. Vogel, in the *Astronomischen Nachrichten* (No. 3198), has many points in its favour. The four lines in the visible region, C, F, G, and  $h$ , retain their old signs of  $H_1\alpha$ ,  $H_1\beta$ ,  $H_1\gamma$ ,  $H_1\delta$ , but H or  $H_1$  is here changed to  $H\epsilon$ , and the  $\alpha$ ,  $\beta$ ,  $\gamma$  lines of Huggins to  $H\zeta$ ,  $H\eta$ , &c., thus making the nomenclature thoroughly consecutive. Prof. Vogel says that in future he shall adopt this new notation, and that Dr. Huggins has also agreed to the arrangement, viz. that the hydrogen lines should always have the clearest sign H coupled with a Greek letter as index, as shown in the following table, in which are given the new and old notations with the wave-lengths:—

| Wave-lengths. | Notation.   |                                            |
|---------------|-------------|--------------------------------------------|
|               | New.        | Old.                                       |
| 6563 $\mu\mu$ | $H\alpha$   | $H_1\alpha$ or C                           |
| 4861          | $H\beta$    | $H_1\beta$ or F                            |
| 4341          | $H\gamma$   | $H_1\gamma$ (written often wrongly with G) |
| 4102          | $H\delta$   | $H_1\delta$ or $h$                         |
| 3969          | $H\epsilon$ | H or $H_1$                                 |
| 3889          | $H\zeta$    | $\alpha$                                   |
| 3836          | $H\eta$     | $\beta$                                    |
| 3798          | $H\theta$   | $\gamma$                                   |
| 3771          | $H\iota$    | $\delta$                                   |
| 3750          | $H\kappa$   | $\epsilon$                                 |
| 3734          | $H\lambda$  | $\zeta$                                    |
| 3722          | $H\mu$      | $\eta$                                     |
| 3712          | $H\nu$      | $\theta$                                   |
| 3704          | $H\xi$      | $\iota$                                    |

THE SPECTRUM OF NOVA NORMÆ.—Prof. Pickering, in *Astronomischen Nachrichten*, No. 3198, gives some details about the discovery of the new star in Norma. The star was found by Mrs. Fleming on October 26 when, examining a photograph of the *specula* of the stars in this constellation, the negative having been taken by Prof. S. J. Bailey at the Arequipa station on July 10, 1893. Comparing the spectrum with that obtained in the case of Nova Aurigæ, nearly the same dispersion having been employed, it seems that they are nearly identical—“about a dozen lines are visible in each, and are identical in wave-length.” The line F, although bright in both stars, is more intense in Nova Normæ, and, further, is more intense than any other line, while G was generally strongest in Nova Aurigæ. With regard to the time of the outburst of this new star, photographs indicate that it must have occurred within the first ten days of July 1. A photograph taken June 21,

1893, shows no trace of it upon the plate exposed to that region, while charts of the same region taken on June 6, June 10, July 21, 1889; May 16, May 16, June 10, June 23, June 23, 1891; May 7, and May 27, 1893, also give no indication of a star in that position. The similarity of the spectra of these two new stars is of interest, as Prof. Pickering points out, in that it has proved a means of discovering one of these objects, and that, if confirmed by other new stars, it will indicate that they belong to a "distinct class resembling each other in composition and physical condition." The nearest catalogue stars to which the Nova lies are Cord. G. C. 20,940 and Cord. G. C. 20,926 of the 8 and 8.75 magnitude respectively, the Nova being nearly midway between them. We may add that the above communication seems to throw some doubt on the accuracy of the note we wrote three weeks ago (November 23), with reference to Prof. Kapteyn's search through his Durchmusterung. Until the exact position of Nova Normæ is obtained, one cannot of course make any statement, but it seems probable that Prof. Kapteyn's and Mrs. Fleming's stars are not the same.

PROF. RUDOLF WOLF, OF ZURICH.—We are very sorry to have to record this week the death of Prof. Rudolf Wolf, the well-known director of the Zurich Observatory. He died at midday on November 6, after a short illness, at the age of seventy-eight years. By his death astronomical science has lost one of her most devoted servants. It was through his work, coupled with that of Schwabe, that the existence of the periodicity of the sunspots was without doubt first accepted, and its length determined to be eleven and one-ninth years. The deceased was, among other things, the author of the work on the "Geschichte der Astronomie," and also of a "Taschen-buch für Mathematik, Physik, Geodäsie und Astronomie," both of which ran through several editions.

THE COMPANION TO THE *Observatory*.—The Companion for the year 1894 follows the same lines as it has done in former years. No additional matter has here been added, unless we mention the ephemeris for the elongations of the satellites of Mars, which planet comes into opposition during next year. We notice that in Mr. Denning's list of meteor showers, instead of November 27, he has this year thought fit to alter it to November 23-27, an alteration justifiable by facts. With regard to eclipses, on March 20-21 a partial eclipse of the moon will take place, but will be invisible at Greenwich. An annular eclipse of the sun, just visible as a partial one in Norway, Sweden, Eastern Europe, and Asia, occurs on April 5, while on September 14 a partial eclipse of the moon will be partly visible at Greenwich. The total eclipse of the sun, on September 28, lasts only for eleven seconds (maximum duration), and as the path of the centre of the shadow lies entirely across the Southern Indian Ocean, the occurrence is of little scientific interest. On November 10 a transit of Mercury across the sun's disc will be partly visible at Greenwich, the first contact taking place before sunset. The times are—

|                      | Ingress. |       | Egress. |       |
|----------------------|----------|-------|---------|-------|
|                      | h.       | m. s. | h.      | m. s. |
| External contact ... | 3        | 55 40 | 9       | 13 9  |
| Internal ,, ...      | 3        | 57 23 | 9       | 11 26 |

For the sun in the zenith at the time of egress, the place of observation lies 63° W. and 17° S. or in Bolivia, South America, that for egress lying 142° W. and 17° S.

SOLAR OBSERVATIONS AT ROME.—In the September number of the *Memorie della Societa degli Spettroscopisti Italiani*, Prof. Tacchini contributes the results of the solar observations made at the Royal Observatory during the second and third trimestre of 1893. The same number also contains two large diagrams of the limb of the sun, the first showing the observations made at Catania, Palermo, and Rome, during the second three months of the year 1892, and the second indicating observations made at the last-mentioned place during June and July.

GEOGRAPHICAL NOTES.

MR. R. D. OLDHAM, Superintendent of the Geological Survey of India, read a paper at the last meeting of the Royal Geographical Society, on the evolution of the geography of India. He pointed out that the three main divisions of India were natural regions the individuality of which had been marked throughout a long range of geological time. The peninsula

consists of very ancient land which has not been submerged since the early Palæozoic period, while the continental division has been frequently under water until Tertiary times, and the great plain is relatively recent alluvium. There is evidence from the close resemblance of fossil forms of a continuous land connection between India and Africa in the Cretaceous period. This former continent has been named Gondwana Land, and must not be confused with the hypothetical continent of Lemuria. It had disappeared by the end of the secondary period. At the close of the Cretaceous period there was an unparalleled outburst of volcanic activity contemporary with a series of great earth-movements which went far to give its present outline to peninsular India, and led to the first appearance of the extrapeninsular mountains. This activity continued during the Tertiary period. The depression at the base of the Himalaya, now filled up by alluvium, was simultaneously formed. The Indus was the original outlet of drainage from the Himalayan district, the river system splitting up later, and the diversion of the Jumna to the Ganges may even have occurred in historical times. The latter part of the paper gave an able summary of Indian types of scenery.

THE crossing of the eastern horn of Africa is fast becoming one of the commonplaces of travel, having been again accomplished this year by Prince E. Ruspoli, who, starting from Berbera in December last year, reached the Jub in March. The last number of the *Bulletin* of the Italian Geographical Society contains a letter giving an account of the journey and a sketch-map showing his route. Another Italian expedition, under Captains Bottego and Grixoni, made the journey by a somewhat different route about the same time.

THE *Verhandlungen* of the Berlin Geographical Society states that the Swedish traveller in Persia, Mr. Sven Hedin, has undertaken a serious attempt to reach Lhasa in the disguise of a Persian merchant. He will start from Leh, and follow the route of the Punjit Nain Singh to Tengri-Nor.

THE death is reported of Dr. D. Scott Monciieff, of Harvard University, who had been making a journey of exploration, mainly with a view to ethnological observations, in Eastern Siberia. He left a Gilyak village near the mouth of the Amur for a sail in an open boat, on August 11, and nothing further was heard of him until a fortnight later his body was found on the coast of Sakhalin.

M. E. PONCINS, a French traveller, writes from Gilgit to the Paris Geographical Society under date August 26, that he has crossed the Pamirs, from north to south, and paid special attention to the source-region of the Oxus. He proposed to proceed to Simla, and there complete a full account of his journey.

THE source region of the Irawadi is still one of the most unknown parts of Asia, and it is satisfactory to learn that Captain Bower, whose recent journey in Tibet is well known, is making explorations in that region during the present cold season.

THE meeting of the Paris Geographical Society on November 17 was devoted to the memory of the navigator Entrecasteaux, whose somewhat unfortunate voyage of discovery round the coast of Australia and amongst the islands of the Western Pacific was interrupted by his death in 1793.

UNVEILING OF THE JOULE MEMORIAL STATUE.

MANCHESTER claims the distinction of having been the home of two of our greatest men of science—Dalton and Joule—and it has shown itself worthy of the honour. A beautiful statue of Dalton has adorned the vestibule of the Town Hall for some years, and on Friday last, one of Joule, by Mr. A. Gilbert, was unveiled in the same place, the two philosophers standing face to face.

It was in 1889 that the Manchester Literary and Philosophical Society proposed to raise a memorial to Joule, and, to the credit of Manchester be it said, the suggestion was taken up with enthusiasm. On November 25 of that year, a meeting was convened by the Mayor of Manchester at that time (Mr. Alderman Mark), and was attended by a large and influential company. The

following resolution was then adopted:—"That this meeting desires to mark its deep sense of the benefits conferred on mankind for all time, as well as of the great honour which has accrued to this district, by the scientific work of the late James Prescott Joule, by the erection of a durable memorial of him in Manchester, in the form of a white marble statue." A representative committee was appointed to raise subscriptions to carry the resolution into effect, and the sum of £2611 was eventually obtained.

Almost the first act of the committee was to pass a resolution to the effect that the movement should be directed to secure not only a marble statue of Dr. Joule as a companion to that of Dr. Dalton, but also a replica in bronze to occupy some public place in the city. This object was kept in view for some time, but eventually it was thought advisable to relinquish the idea. After abandoning the scheme of raising a bronze replica of the statue, it was decided that the surplus should be handed over to the Literary and Philosophical Society as a nucleus for the institution of a permanent Joule Memorial Fund, the income of which is to be employed, as the council of the Society may direct, for the encouragement and promotion of science.

The unveiling of the Joule statue was performed by Lord Kelvin, in the presence of a large company. The *Manchester Guardian* gives a full report of the proceedings, and from it we extract the following remarks made by Lord Kelvin in the course of his address.

The Literary and Philosophical Society had the distinguished honour of being really the cradle of Joule's work—first as Dalton's home, and afterwards as Joule's life-long scientific harbour. From very early days he kept constantly in touch with that Society. Many of his most important papers were first given to the world there, and during the last years of his life he was an exceedingly regular—it might almost be said a constant—attendee at the meetings of the Society. The citizens of Manchester did not require to be told what great things this Society in its rather more than a century's existence had done. Their presence in such numbers on that occasion showed how much they appreciated the results of that very effective scientific institution. Now he ought to say something of the electrical, mechanical, and chemical character of Joule's work, although to examine it properly would require the space not of one address, but of a whole course of lectures illustrated by experiments. A great surprise that came out very early in Joule's work was burning without heat—an absolutely novel idea which Joule developed most wonderfully and most magnificently by his experiments in the generation of heat in the voltaic battery, which in those days was the only source of electricity on a large scale. Joule was the first to develop the idea, and it came to him not as a bright flash of genius, but as the demonstrated result of years of hard, measuring, calculating work. This was the fundamental idea that pervaded all Joule's work. A few years later he expanded it in a wonderful way. About 1846, in a joint paper by himself and Scoresby, he brought out the wonderful, the truly philosophical, and at the same time startling idea that when a man or any other animal walked uphill, only a part of the heat or combustion of his food was developed, and that it was when the body was quiescent that the chemical attraction between the food and the oxygen dissolved in the blood developed its whole energy in actual animal heat. He showed, further, that the animal body was more economical for fuel than was any steam engine hitherto realised. This was a very far-reaching idea, and seemed to hold out prospects of greatly advancing the efficiency of the steam engine. That promise had not been lost. It was due to Joule, more than to any other individual, that the great improvement of surface condensation was now universal, although very rarely practised, indeed, before 1860 or 1862. Joule, about the year 1860, in working upon a little steam engine, applied a surface condenser on an entirely new principle, and in doing so he was led to think out a mode of getting heat out of the steam to be condensed without sending a jet of water into it, as on the old plan. But he (Lord Kelvin) had not yet touched upon Joule's great fundamental discovery, the discovery which was first in everyone's mouth—that of the mechanical equivalent of heat. They would understand that it was not merely by a chance piece of measurement that he stumbled on this result, which was afterwards found to be of great value. It was measurement, rigorous experiment and observation, and philosophic thought all round the field of physical science that made this discovery possible. Very early indeed in his work-

ing time Joule brought out the mechanical equivalent of heat, and in a paper read at the British Association at Cork in 1843, and afterwards in the *Philosophical Magazine*, he gave the number "772." Six years later a second determination gave him the same result, and twenty-five years later he made a third determination, which gave him the final and corrected result "772.56." In the year 1824 a great theory was originated by a very young man, who died only a few years later—Said Carnot, son of the Republican Minister, and uncle of the present President of the French Republic. It was he who made "Carnot's theory" a household word throughout the world of science; and great was the French President, much as he had done for his country and the world, in after times his uncle would be always remembered as one of the most distinguished characteristics attached to that great name. Carnot's theory gave an important fundamental principle regarding the development of motive power from heat. Joule's work, on the other hand, so far as the mechanical equivalent was concerned, was the generation of heat by mechanical work. It was quite the middle of the century before Carnot's work began to attract attention; but Joule was early made acquainted with it, and after fighting a little against it as differing from his own theory, he of all others took it up in the most hearty manner. Lord Kelvin went on to say that he could never forget the British Association at Oxford in the year 1847, when in one of the sections he heard a paper read by a very unassuming young man who betrayed no consciousness in his manner that he had a great idea to unfold. He (Lord Kelvin) was greatly struck with the paper. He at first thought it could not be true because it was different from Carnot's theory, and after the meeting he and the reader of the paper, James Joule, had a long and thoroughly discursive talk on the subject, and he obtained ideas he had never had before, although he thought he too suggested something worthy of Joule's consideration when he told him of Carnot's theory. He had the great pleasure and satisfaction for many years, beginning just forty years ago, of making experiments along with Joule, which led to some important results in respect to the theory of thermodynamics. This was one of the most valuable recollections of his life, and was indeed as valuable a recollection as he could conceive in the possession of any man interested in science. Joule's initial work was the very foundation of our knowledge of the steam engine and steam power. Taken along with Carnot's work it had given the scientific foundation on which all the great improvements since the year 1850 have been worked out, not in a haphazard way, but on a careful philosophical basis. James Watt had anticipated to some degree in his compound engine and his expansive system the benefits now realised, but he was before his time in that respect, and had the complete foundation which Joule's mechanical equivalent and Carnot's theory had since given for the improvement of the steam engine. Might he be allowed, Lord Kelvin added, to congratulate the city of Manchester on its proceedings that day? When the cover was lifted from the statue of Joule, he felt deeply touched at the sight of the face of his old friend. To his mind it was a most admirable likeness, and the ideality of the accessory of the little model held in the hand seemed to him most interesting and most striking—he thought he might say poetical. That little model was not one of Joule's first or second, but of his third and greatest apparatus for the determination of the mechanical equivalent of heat—that by which he corrected the British Association's standard ohm, which he proved to be 1.7 per cent. wrong. Regarding that standard a diplomatic correspondence was now going on between our Foreign Office and other European Governments with a view to arranging the precise terms of the definition of the ohm, which was really first worked out by Joule. Lord Kelvin further asked to be allowed to congratulate the sculptor on the great beauty and the great success of his work, and added that Manchester now possessed statues both of the man who laid the foundation of the atomic theory in chemistry, and of the man who was the originator of the whole subject of thermodynamics. If the prosperity of Manchester did not depend on chemistry and on the steam engine and thermodynamics, he did not know upon what it did depend. The energy and industry of its inhabitants were no doubt essential to its success, but they must ever remember that the material prosperity of the city was as much dependent on philosophic thought as it was upon any material appliance whatever.

Sir H. E. Roscoe, M.P., in moving a vote of thanks to Lord



Kelvin for his address, mentioned that for thirty years he himself sat at the feet of Joule, whom he might therefore claim in some sense as his scientific father. He remained in constant communication with Joule up to the day of the philosopher's death. It was a great thing that in a city like Manchester, devoted as it was to industry and commerce, the citizens should be entitled to place in their Town Hall the statues of two such fellow-citizens as Dalton and Joule. Few cities in the world could boast of two greater men. In London, also, they had been doing something to show the appreciation in which not only this country but the world held Joule. A sum of money had been raised and placed in the hands of the Royal Society for the purpose of founding a Joule studentship, and on Thursday the Council of the Society resolved that the money should be spent in founding such a scholarship, to be awarded alternately in England and in other countries, for the purpose of encouraging young scientific men to walk in the steps of Manchester's great citizen. The first of those scholarships, of the value of £100, would be shortly awarded, and he thought he was not going too far when he said it would come to the city in which Joule lived and worked. He might mention that since the foundation of Owens College that institution could claim nine metallists of the Royal Society, and had they lived Prof. Jevons and Prof. Schorlemmer would have been added to the number. It would be seen, therefore, that Manchester had taken up the thread spun by Dalton and Joule, and that there was no reason to fear that their work would not be continued.

Prof. Osborne Reynolds seconded the resolution, which was adopted.

On the motion of Mr. Alderman Mark, seconded by Principal Ward, a vote of thanks was given to the Lord Mayor for presiding. At the conclusion of the proceedings the Lord Mayor and Lady Mayoress held a reception in the state apartments.

### THE ETHNOLOGICAL MUSEUM AT LEYDEN.

IT is from twenty-five to thirty years ago that the interest in ethnology as a science was awakened. Ethnological objects are no longer considered by scientific men as mere curiosities; collections of them have ceased to be shops of foreign bric-a-brac. In America and in Europe, museums have arisen, variable in size and importance it is true, but all with the same object in view, viz. the study of man from his handiwork as illustrative of his mental development in various directions, in time as well as in space.

The realisation of the importance of collecting and studying ethnological material in distant lands has not come too soon. What has been done in this respect within the last twenty-five years surpasses all that has been performed in the centuries before, from the beginning of the circumnavigation of the globe to the early seventies of our century. The result of this has not only been the publication of valuable ethnological monographs and studies, but also the foundation of new, and the further development of existing, museums in Europe and America. Amongst the ethnological collections which have grown considerably are those of the National Ethnological Museum at Leyden. A pamphlet by the director, Dr. L. Serrurier, recently published under the very suggestive title of "Museum or Storehouse?" induces me to write the present notice.

The origin of this museum dates back as far as 1837, the year in which the Dutch Government purchased von Siebold's Japanese collections. This formed the nucleus of the little museum, which gradually increased by means of collections made in the Indian Archipelago by Macklot, Salomon Müller, von Rosenberg, and other naturalists. In the meanwhile von Siebold had returned to Japan, and the late Dr. Leemans was appointed acting director of the collection in 1859, as a part of the National Museum of Antiquities. A long period of inactivity then ensued until 1880, when it was decided that the ethnological department should become a separate museum, under the direction of Dr. Serrurier, until then curator of the Japanese department.

From that moment the museum sprang into new life. The period of curiosity shop had ceased for ever; and the institution was developed in the right direction. Many objects were properly identified, check lists and manuscript catalogues

corrected and newly made,<sup>1</sup> relations with sister institutions established, exchanges made, and valuable objects and collections bought. Many residents in the Dutch colonies who hitherto had hardly heard of the existence of an ethnological museum at Leyden, now gladly presented or loaned their private collections to it. Nothing shows more clearly the extraordinary growth of these collections than the maps accompanying the pamphlet of Dr. Serrurier. On these maps—two of the world, and two of the Indian Archipelago—is indicated the number of groups of objects in the Leyden Museums representing special ethnological regions or areas. These groups refer to a very rational division or classification established by Dr. Serrurier and used in the Leyden Museum. One set of maps shows the condition of the collections in 1881, the other in 1893. A single glance at the maps is sufficient to illustrate the vast difference wrought in those twelve years. Southern Asia, the Orient, Africa, and North America were hardly or not at all represented in 1881, and so were many parts of the Indian Archipelago and South America, but in 1893 the ethnology of these countries can be studied in the museum by means of valuable and more or less representative collections. In short the collection has decupled in these twelve years, not to speak of the rich and varied anthropological section, entirely the work of the present director.

It would be only natural to suppose that collections of this importance were exhibited in a special building where they were not only safely stored but also made of interest to the public, as well as for professional men. Nothing is, however, farther from the reality than this supposition. To the amazement of foreign ethnologists, and every friend of science in fact, the Leyden collections are scattered, as Dr. Serrurier summarises, over not less than five different places—ugly, dark, and damp private houses, or other localities, all equally unfit for the conservation of the ethnological material. Thousands of precious objects are stowed away as in a storehouse, where moths and moisture are hard to fight against, and where the danger of fire is so much greater than elsewhere. Should ever a fire destroy these collections, the loss would, for the greater part of them, be irreparable; they could not be again collected. In many distant countries, all over the world, the inhabitants have given up their native industries, and are losing rapidly their originality in every respect, the result of their contact with Western civilisation.

An appendix to Dr. Serrurier's pamphlet, being a number of testimonies from different travellers and authors as to the disappearance of primitive conditions among foreign races, tends to prove the value of present ethnological collections and the necessity of collecting objects and data without delay, before it will be too late.

Irrespective, however, of the present buildings the museum collections are not quite what they ought to be, which perhaps is partly due to the fact that they are situated in a small old-fashioned city with a public—University students included—taking very little or no interest in ethnological exhibitions. If the museum were situated in a great city, say Amsterdam or The Hague, things might probably take a turn for the better, but still, as long as there is no special building, a thorough improvement will be impossible.

There are many things which the Ethnological Museum of Leyden ought to be, and should be, if proper attention was paid to it by the Dutch government. For a nation like the Dutch, which ranks third as a colonial power, a museum like this could be a sort of a bureau of ethnology, more or less similar to that of Washington, and a place where both University students and the general public could be taught sounder ideas about races of mankind which they have been used to consider as "savages."

For years past the director has called the attention of the Dutch government to this state of things. In each of his annual reports Dr. Serrurier has pleaded for the sake of a new and proper building with the ardour and conviction of a man who pleads for the thing to which he devotes his life and talents, but all in vain; *vox clamantis in deserto*.

The present pamphlet of Dr. Serrurier's is a supreme effort to improve this sad state of affairs, a last appeal to the national

<sup>1</sup> A system of cataloguing introduced not long ago by Dr. Serrurier in the Leyden Museum, as far as I know not followed in any other ethnological museum, is what might be called the "Note Catalogue." Each object has an inventory number referring to a separate note on a slip of stiff paper, which contains, besides a small photograph of the object in question, a full description of it, and bibliographic indications relating to its origin, occurrence, use, &c. This system facilitates greatly the study of the objects.

representatives, the members of the First and Second Chambers. The granting of a considerable sum of money for the building of a new National Museum of Natural History at Leyden, a necessity long felt and perseveringly advised by its director—Dr. Jentink—furnished an occasion to bring the question once more before the public. What the result will be—museum or storehouse?—we cannot tell. If a man is not convinced after reading Dr. Serrurier's pamphlet, he will never become convinced.

"But whatever may be done"—Dr. Serrurier concludes his interesting paper—"every change, in this case, will be an improvement, for now the life of the museum is ebbing away. The time is near that it will sink into a lethargic sleep, the end of which will be death."

H. TEN KATE.

### UNIVERSITY AND EDUCATIONAL INTELLIGENCE.

OXFORD.—Mr. T. I. Pocock, of Corpus, has recently been elected to the Burdett-Coutts Geological Scholarship. It is his intention, we believe, to devote himself ultimately to the science of astronomy, which he studied at Oxford under the late Prof. Pritchard.

Mr. E. A. Murchin has been elected to a Biological Fellowship, at Merton College, and Mr. H. M. Vernon, of that college, has been elected to the Oxford Biological Scholarship at Naples.

CAMBRIDGE.—The council of the Royal Geographical Society offer in the present academical year a studentship of £100, to be used in the geographical investigation (physical or historical) of some district approved by the council. Candidates must be members of the University of not more than eight years' standing from matriculation, who shall have attended the courses given in Cambridge by the late or present University lecturer in geography.

The following awards in Natural Science were made at St. John's College on December 11:—K. C. Browning (Dulwich College), Foundation Scholarship of £80; E. R. Clarke (Tonbridge School), Foundation Scholarship of £50; O. F. Diver (Winchester College) and K. B. Williamson (St. Paul's School), Minor Scholarships of £50; A. A. Robb (Queen's College, Belfast), R. F. C. Ward (Epsom College), J. A. Glover (St. Paul's School), and G. D. McCormick (Exeter Grammar School), to various Exhibitions of £50 and under.

### SOCIETIES AND ACADEMIES.

#### LONDON.

Linnean Society, November 16.—Prof. Stewart, President, in the chair.—Mr. J. H. Veitch exhibited a large and interesting collection of economic and other vegetable products of Japan, recently brought by him from that country, and described the various uses to which different kinds of wood, fibre, grass, &c., were applied for domestic purposes, as also the way in which various seaweeds were collected and prepared for food.—Mr. A. G. Renshaw exhibited a remarkably large specimen of the giant puffball, *Lycoperdon giganteum*, which he had gathered at Catford Bridge.—On behalf of the Rev. Prebendary Gordon, the secretary exhibited a plant of *Fernicia salicifolia* of New Zealand, found growing in Langland's Bay, Mumbles, Swansea, having been introduced by some chance.—A paper was then read by the Rev. G. Henslow, on the origin of plant structures by self-adaptation to the environment, exemplified by desert and xerophilous plants. The purport of this paper was to prove by a direct appeal to facts the probably universal application of Mr. Darwin's assertions, viz.: (1) that natural selection has no relation whatever to the primary cause of any modification of structure ("Animals and Plants, &c." vol. ii. p. 272); (2) that modifications of structure are due to the direct action of the environment (*Id.* Darwin, Weismann, Spencer, &c.). This always results in "definite variations," by which Mr. Darwin signifies (3) that all, or nearly all, the individuals became modified in the same way ("Origin of Species," 6th ed., p. 106), and consequently (4) that "a new variety would be produced without the aid of natural selection" ("Animals and Plants," ii. 271, "Origin of Species," pp. 72, 175). Mr. Henslow showed (1) that all the species constituting the peculiar *faunes* of a desert flora are the direct result of their climatic conditions; (2) that

these peculiarities are in nearly all cases of the utmost benefit to the plants, such as the hardening of the tissues, the reduction of parenchyma, the minute size of the leaves, the dense clothing of hair, a thick cuticle, the presence of wax, storage of water tissues, &c. But (3) these features are just those which systematists utilise as descriptive characters of varieties and species. Mr. Henslow observed that by Darwin's assuming that "indefinite variations" which are characteristic of *cultivation* were equally so in *nature*, he reasonably required natural selection to correspond with artificial selection; but that assumption he believed to be erroneous. For experiments proved that by sowing seeds in a very different medium, *all* the seedlings vary in the same direction, viz. that of adaptation to the new environment, verifying Mr. Herbert Spencer's statement that "under new conditions the organism immediately begins to undergo certain changes in structure, fitting it for its new conditions." The conclusion is thus arrived at which is expressed in the title of this paper. The functions of natural selection therefore become limited, as follows: (1) The survival of the constitutionally strongest amongst seedlings; (2) delimitation of species by the non-reproduction of intermediate forms; (3) the geographical distribution of plants by self-adaptation. An interesting discussion followed, in which Prof. Reynolds Green, the Rev. Dr. Klein, Mr. Perry Coste, and others took part.

Zoological Society, November 21.—Sir W. H. Flower, K.C.B., F.R.S., President, in the chair.—The secretary read a report on the additions that had been made to the Society's menagerie during the month of October, 1893, and called special attention to an example of Goliath beetle (*Goliathus druyii*), the largest of known Coleoptera, obtained near Accra, and pie-ented October 5, by Mr. F. W. Marshal, and to an adult female and a young of the Manatee (*Manatus americanus*), captured in Manatee Bay, Jamaica, and most kindly sent home for the Society's collection by Sir Henry A. Blake. Unfortunately the Manatees had reached the gardens in a very exhausted condition, and died soon after their arrival.—The secretary read an extract from a letter addressed to him by Mr. J. S. Mackay, of the Kangra District, Punjab, relating to a young snow-leopard which he had in captivity, and exhibited some photographs of this animal.—Mr. Slater exhibited and made remarks on a mounted specimen of an African monkey (*Cercopithecus albogularis*) belonging to the Leyden Museum.—Mr. W. B. Tegetmeier exhibited and made remarks on two hybrid pheasants, believed to be crosses between the common pheasant and the gold and silver pheasants.—A communication was read from Messrs. G. W. and E. C. Peckham, on the spiders of the family *Atidae* of the island of St. Vincent, based on specimens collected in that island by the agency of the joint committee of the Royal Society and the British Association for the exploration of the Lesser Antilles. The series had been collected by Mr. Herbert H. Smith and Mrs. Smith, who had been specially sent to the island as skilled collectors by Mr. F. D. Godman, F.R.S.—A communication was read from Mr. P. R. Uhler, containing a list of the Hemiptera Heteroptera collected in the island of St. Vincent by Mr. and Mrs. Herbert H. Smith, with descriptions of new genera and species.—Dr. G. Lindsay Johnson made some observations on the refraction and vision of the eye of the common seal (*Phoca vitulina*).—Mr. Slater read a paper on some specimens of mammals from Lake Mweru, British Central Africa, transmitted by Vice-Consul Alfred Sharpe, through Mr. H. H. Johnston, C.B. The specimens were referred to seventeen species, amongst which was a new monkey of the genus *Cercopithecus*, proposed to be called *C. osthostictus*, and a new antelope allied to the waterbuck, which was named *Cobus cratichayii*, after Mr. R. Crawshay, who had first discovered the species.

#### CAMBRIDGE.

Philosophical Society, November 27.—Prof. T. McK. Hughes, President, in the chair.—The following communications were made.—The action of light on bacteria, by Dr. H. Marshall Ward. By throwing the spectrum on various bacteria suspended in films of agar, it is possible to obtain photographic records of the action of the various rays; because, after incubation, those spores or bacilli, &c. which are killed by certain rays remain invisible, whereas those still left capable of development render the agar opaque. The experiments show that those germs which are struck by the infra-red, red, orange and yellow, develop as rapidly as those not exposed to light at all. The action begins

as we leave the green and rises to a maximum in the blue-violet and violet, falling off as we pass into the ultra-violet. For the solar spectrum a heliostat and glass lenses and prism were used; for the electric spectrum a quartz train, and quartz covering the film. Even a thin plate of clear glass blocks out much of the effective region of the spectrum, and especially ultra-violet rays. The author recorded his thanks to Prof. O. Lodge, F.R.S., for kindly exposing the plates to the electric spectrum for him, with most successful results. The author also found that the water of the Thames, examined in August and October respectively, shows the following interesting results. (1) The number of bacteria per c.c. was distinctly smaller in the bright August weather than in the duller days of October, and differences were observable in the aspect of the colonies on plate-cultures. (2) Suspecting that this was concerned with light action, experiments showed that insolation not only kills off large numbers of the bacteria in the water, but in some cases shows its effects in diminishing the liquefying (*i.e.* enzyme action) power of certain forms, and even in altering their mode of growth, so that the aspect of the colonies is affected. These changes in aspect are not a mere matter of preventing or increasing the production of pigment, &c., but are due to effects on the *growth* of the colonies. As regards pigments, the author has examined a pigment of one of these river species, which, though so resistant as to bear solution in alcohol, evaporation and drying at 100 C., and re-solution, without apparent alteration, is destroyed in an hour or two on exposure to light.—On gynodioecism (third paper), with a preliminary note upon the origin of this and similar phenomena, by Mr. J. C. Willis. The experiments described in the two former papers have been continued, and have still further shown the very variable nature of the phenomena of gynodioecism. From the results, taken together with those of experiments upon dichogamy and cleistogamy, and the observations of other writers upon these subjects, the author is inclined to the conclusion that all these phenomena, together probably with androdioecism, andromonoecism, polygamy, dioecism, &c., are closely allied to one another, depending largely upon varying conditions of nutrition, these again depending on numerous factors, such as soil, climate, temperature, light, season of the year, moisture, and internal conditions in the plant itself. These factors acting together or separately, may call forth, in a marked degree, any of the above phenomena. In the most marked cases natural selection appears to have come into play, and the phenomena have become hereditary, but in many cases they seem to be only sporadic. A full review of the literature relating to these subjects is in preparation.

## PARIS.

Academy of Sciences, December 4.—M. de Lacaze-Duthiers in the chair.—Significance of the localisation of organs in the measurement of the germination of plants, by M. Ad. Chatin.—Estimation of manganese oxides by oxygenated water, by Harry C. Jones.—On the profound deformations of the spheroid of Mars, by Dom Laney.—On the observations made by M. J. Vallot on the summit of Mont Blanc in 1887, by M. Alfred Angot. From the barometric pressures and temperatures observed by M. Vallot on the top of Mont Blanc, and simultaneous observations made on the Saïtis, Obir, and Pay-de-Dôme, and at Berne, Geneva, and Lyon, the height of the former may be calculated. The values thus obtained range from 4810 m. to 4824 m. The true height is 4810 m., so that an interesting confirmation of Laplace's law is obtained. The temperature at the limit of the atmosphere has been calculated by Voëtkoff according to Mendelejeff's formula, which makes the temperature of the air a linear function of the pressure. The result obtained from numerous mountain observations is  $-42^{\circ}$ . A combination of the Mont Blanc observations with those of the three mountain stations mentioned gives  $-47^{\circ}$ , and with the three town stations  $-45^{\circ}$ . Since these values are obtained from summer observations only, they are probably a little too low.—On the complex acids which are formed by molybdic acid with titanous acid and zirconia, by M. E. Péchard.—Researches on the constitution of the albuminoid materials extracted from the vegetable organism, by M. E. Fleurent.—On the stability and the conservation of dilute solutions of corrosive sublimate, by M. Léon Vignon. If a solution of sublimate of 1 grain to 1 litre of distilled water is left to itself for a few days at the ordinary temperature, it gives rise, in a period varying from one to three days, to a white precipitate whose quantity gradually increases. Quantitative measurements of the amounts of mercury thus precipitated under varying conditions gave the following

results. When the solution was left in an open vessel, the percentage of mercury left in solution after seven days was 0.57, in a closed vessel 0.97, and 0.67 after 220 days. When colouring matters were added to the solutions, the corresponding numbers were, for fuchsine, 0.67, 0.97, and 0.77; and for indigo carmine, 0.76, 0.98, and 0.80, the latter therefore giving the greatest stability.—Discovery of abradol in wines, by M. Single-Ferrière. This gives a method of finding whether abradol, a new antiseptic for the preservation of wine, has been used in a given sample. It is the sulphonic ether of  $\beta$  naphthol combined with calcium. The method utilises the decomposition ensuing when abradol is heated with dilute HCl, calcium carbonate, sulphuric acid, and  $\beta$ -naphthol being formed.—On the sterilisation of bread and biscuit on coming from the oven, by MM. Balland and Masson. This gives an answer to the question whether all dangerous germs which may have been contained in the water used for breadmaking, are destroyed during the process of baking. Experiments show that microbes in general are incapable of resisting the acidity of the dough and the high temperature of baking. Certain spores notorious for their stability are indeed capable of regaining their activity under favourable circumstances, but all pathogenic bacilli, especially those of typhoid and of cholera, are certainly destroyed.—Some chronological data relating to the regeneration of nerves, by M. C. Vanlair.—On the termination of the motor nerves of striated muscles in the Barrachians, by M. Charles Rouget.—On some points relating to circulation and excretion among the cirripedes, by M. Gravel.—On phosphaturic albuminuria, by M. Albert Robin. The constitution of the group of phosphaturic albuminurias, shows that the morbid entity known as Bright's disease, is often nothing but the anatomical complication of an anterior purely functional malady, and that, like a number of similar cases, the cure should begin at this anterior functional disorder.—Parasites in cancer, by M. G. Nèveu.—The shell cavity of the Philinidæ, by M. P. Pelseuer.—On a new gregarine of the Algerian Acridians, by M. L. Léger.—On the exchanges of carbonic acid, and oxygen between plants and the atmosphere, by M. Th. Schlessing his.—Observations on the constitution of the membrane in mushrooms, by M. L. Mangin.—On the primary strata of Saint-Pons (Hérault), by MM. P. de Rouville, Aug. Delage, and J. Miquel.—On the Triassic and Jurassic formations of the Balearian Isles, by M. H. Nolan.

## BERLIN.

Physical Society, November 3.—Prof. du Bois Reymond, President, in the chair.—Dr. Rubens discussed the experiments of Righi, who had succeeded in obtaining Hertz's oscillations of much smaller wave length than had hitherto been found possible. Whereas the shortest waves obtained by Hertz were 55 c.m. long, and those by Döppler 20 c.m., Righi had produced waves only 7.5 c.m. in length, and had repeated all Hertz's experiments in a much more convenient form. Rubens had somewhat modified Righi's experimental arrangements, and produced waves 10 c.m. long, which he intended to submit to further investigation.

November 17.—Dr. O. Frölich explained a generalised form of Wheatstone bridge, and a series of applications of the same for theoretical and technical purposes. Dr. Blüm demonstrated a form of apparatus for showing refraction suitable for use in schools, giving accurate results to the third place of decimals with very little practice.

Physiological Society, November 10.—Prof. du Bois Reymond, President, in the chair.—Dr. Gumlich gave an account of feeding experiments made on dogs, with nucleic acid, which showed an absorption of this substance by the animal organism. The phosphates of the urine were increased, as also the nitrogen of its extractives. There was no increase of uric acid.—Dr. Goldscheider made further communications on leucocytosis. His experiments, carried on in conjunction with Dr. Jacob, had shown that after the injection of hemialbumose, or extract of spleen, and other substances with similar action, there is a diminution (hypocytosis) in the number of leucocytes, followed by a rapid rise in their number up to the normal and then to a permanent increase above the normal (hypercytosis). When the active substance was injected into the jugular, it was found that during the brief period of hypocytosis the capillaries of the lungs were abnormally filled with leucocytes. Later on, there was a still further increase in this region at the time of increase of leucocytes in the blood generally. By using smaller doses of the active substance the stage of hypocytosis could be lessened

or even entirely suppressed, leaving only the stage of hypercytosis.

November 24.—Dr. Katzenstein gave an account of experiments on the median pharyngeal nerve. In the rabbit this nerve gives off branches to the cricothyroid muscle, whereas in the monkey, dog and cat no such connection can be made out, either anatomically or physiologically. Prof. Munk made some remarks, in connection with these experiments, on Prof. Exner's belief in the existence of a median pharyngeal nerve, which could at most only be admitted in the case of the rabbit. Prof. Zuntz described a new method of measuring the amount of the circulating blood and the work done by the heart. It depends on the fact that as long as the peripheral resistance is constant, blood-pressure is dependent on the volume of blood driven into the aorta by the left ventricle. When the heart is inhibited by stimulation of the vagus the blood-pressure falls, and if now a volume of blood is injected into the aorta sufficient to raise the pressure again to the normal, then this volume must be equal to that which the heart ordinarily drives into the arterial system. The method had shown itself to be reliable in experiments made on dogs, and had already yielded some interesting results relating to the circulation, which will be further investigated.

#### NEW SOUTH WALES.

Linnean Society, October 25.—Prof. David, President, in the chair.—The following papers were read: On *Polyercus*: a proliferating Cysticercoid parasitic in certain earthworms, by Prof. Haswell and J. P. Hill.—Some points in the anatomy of the monotreme scapula, by Prof. Wilson and W. J. Stewart McKay.—Notes on the family Brachyscelidæ, with descriptions of new species, Part III., by W. W. Froggatt.—On some new genera of nematode worms found in Port Jackson, by Dr. N. A. Cobb.—On recently observed evidences of extensive glacial action at Mount Kosciusko Plateau, by R. Helms.—Contributions to a revision of the Tasmanian land mollusca, by H. Suter.—Notes on the occurrence of a species of *Plecorema* and other species of mollusca in Port Jackson, by Dr. J. C. Cox.—On the distribution of little-known mollusca from Polynesia and Australia, with their synonyms, by John Brazier.—Dr. Cox exhibited a fine specimen of the herring *Elops saurus*, Linn., purchased in a Sydney fishmonger's shop, and believed to have been captured off Broken Bay; the species is occasionally taken in Port Jackson, though it is more properly an inhabitant of tropical seas. He also showed a piece of timber in an excellent state of preservation supposed to be red gum, a portion of a tree encountered in sinking a shaft in the bed of the river during the building of the bridge at Echuca; the specimen was forwarded to him by Mr. A. P. Stewart, of Hay, N.S.W. Dr. Cox also showed specimens of the shells referred to in his paper, and a very fine example of *Voluta manilla* from Tasmania.—Mr. Froggatt exhibited a fine series of mounted galls and coccids in illustration of his paper, including a new Brachyscelid collected by Mr. A. Roxburgh at Cobar, and representatives of several new species of Opisthoscelis.—Mr. North exhibited a set of eggs consisting of three eggs of *Collyriocincla harmonica* and an egg of *Cacomantis pallida* collected on the Woollie Creek on the 19th inst. The cuckoo's egg was deposited on the 17th inst., when the nest contained but two eggs of the *Collyriocincla*. This is the only occasion he had known the egg of any cuckoo to be found in the nest of the Harmonious Thrush. Mr. North also communicated a note in which he pointed out that the blue wren (*Malurus cyaneus*) is developing a protective habit against the cuckoos which intrude their eggs upon it, as he had found in several instances that the intruder's eggs were covered with a layer of nest material; a parallel instance has been recorded by Messrs. Sclater and Hudson in their "Argentine Ornithology."—Mr. Mitchell, of Narellan, contributed a note on the occurrence of a fossil at Stockyard Mountain, Jamberoo, bearing a strong resemblance to *Lepidostrobos* and *Halonis*; and of certain scales at Glenlee, referable, in his opinion, to one or other of the genera *Lepidostrobos* or *Sigillariostrobos*; also of a species of *Pterophyllum*, at Kenny Hill, near Campbelltown.—Mr. A. M. Lea showed a small collection of insects which inhabit ant and termite nests, including a dipterous insect (*Microdon variegata*), one of the Micro-lepidoptera at present undetermined, both from Sydney; and of coleoptera, two species of Pselaphidæ from Tamworth and Inverell, *Anthrenus* sp., from Sydney, *Lagria* n.sp., from Cootamundra and Queanbeyan, and a fifth species (g. et sp. indet.).—Mr. Brazier exhibited for Mr. T. Steel three

aboriginal stone axes, one with a groove for hafting, from the Herbert River, said to have been found at a depth of thirty feet in sinking a well; a second from the Tweed River, being a simple adaptation of a flat water-worn stone by grinding the thinner end; the third from Harrow, Victoria.—Mr. Fletcher exhibited for Mr. G. L. Pilcher, of Rockhampton, an undescribed longicorn, and two of the mud nests of one of the solitary wasps (*Eumenes Latreillei*, Sauss.), together with specimens of the wasp and of a species of *Chrysis* which, like members of the same family elsewhere, plays the part of cuckoo; and he communicated a note giving particulars of the mode of construction of the nests exhibited, and of the habits of the maker and of the attendant intruder.

#### BOOKS and SERIALS RECEIVED.

BOOKS.—Elementary Trigonometry: H. S. Hall and S. R. Knight (Macmillan).—A Theory of Development and Heredity: H. B. Orr (Macmillan).—Natural Value: F. von Wiesner, translated (Macmillan).—The Vault of Heaven: R. A. Gregory (Methuen).—A Journey through the Yemen: W. B. Harris (Blackwood).—Chinese Central Asia, 2 Vols.: Dr. H. Lansdell (Low).—The Dispersal of Shells: H. W. Kew (K. Paul).—A Text-book of Physiological Chemistry: Prof. O. J. Hammarsten, translated by J. A. Mandel (K. Paul).—Die Hawaiiischen Inseln: Dr. A. Marcuse (Berlin, Friedländer).—Fra i Batacchi Indipendenti: E. Modigliani (Roma, Soc. Gerg. Italiana).—A Text-book on Electro-Magnetism and the Construction of Dynamos, Vol. 1: Prof. D. C. Jackson (Macmillan).—Mining: A. Lupton (Longmans).—Anwendung der Quaternionen auf die Geometrie: Dr. P. Mohlenbrock (Leiden, Brill).—Studies from the Physical and Chemical Laboratories of the Owens College, Vol. 1, Physics and Physical Chemistry (Manchester).—Schneekristalle: Dr. G. Hellmann (Berlin, P. Mückenberger).—Darwinianism: Dr. J. H. Stirling (Edinburgh, T. and T. Clark).—A Catalogue of the Egyptian Collection in the Fitzwilliam Museum, Cambridge: Dr. E. A. W. Budge (Cambridge University Press).

SERIALS.—American Meteorological Journal, November (Boston, Ginn).—Bulletin de l'Académie Royale des Sciences de Belgique, 3rd Series, Tome 26, Nos. 6 and 10 (Bruxelles).—Observatory, December (Taylor and Francis).—Companion to ditto, 1894 (Taylor and Francis).—Mémoires de la Société d'Anthropologie de Paris, Tome 1, 3rd série, 1 Fasc. (Paris, Masson).—L'Anthropologie, Tome 4, No. 4 (Paris, Masson).—Himmel und Erde, December (Berlin, Paetel).—Engineering Magazine, December (New York).—L'Elettrista, December (Roma).—Medical Magazine, December (Southwood).—Illustrated Archaeologist, December (C. J. Clark).—Insect Life, Vol. vi, No. 1 (Washington).—Zee, Vol. iv, No. 3 (San Francisco).—Bulletin de la Société Impériale des Naturalistes de Moscou, 1893, N. s. 2 and 3 (Moscow).—Bulletin du Comité International Permanent pour l'exécution photographique de la Carte du Ciel, Tome 2, Deux Fasc (Paris, Gauthier-Villars).

#### CONTENTS.

|                                                                                         | PAGE |
|-----------------------------------------------------------------------------------------|------|
| A Book of Practical Examples in Electricity. By Prof. A. Gray . . . . .                 | 145  |
| Besant's Dynamics. By A. B. Basset, F.R.S. . . . .                                      | 146  |
| Insect Pests . . . . .                                                                  | 147  |
| Our Book Shelf:—                                                                        |      |
| Wells: "Text-book of Biology."—W. N. P. . . . .                                         | 148  |
| "The New Technical Educator" . . . . .                                                  | 148  |
| Draper: "Heat, and the Principles of Thermodynamics" . . . . .                          | 148  |
| Letters to the Editor:—                                                                 |      |
| Systematic Nomenclature.—Prof. G. F. Fitzgerald, F.R.S.; and Fred. T. Trouton . . . . . | 148  |
| On the Nomenclature of Radiant Energy.—Prof. G. F. Fitzgerald, F.R.S. . . . .           | 149  |
| Flame.—Prof. Arthur Smithells . . . . .                                                 | 149  |
| The Second Law of Thermodynamics.—S. H. Burbury, F.R.S. . . . .                         | 150  |
| The Loss of H.M.S. "Victoria," III. By Dr. Francis Elgar . . . . .                      | 151  |
| The New Laboratories of the Institute of Chemistry . . . . .                            | 154  |
| Science in the Magazines . . . . .                                                      | 155  |
| Experiments on Flying. (Illustrated.) By Prof. C. Runge . . . . .                       | 157  |
| Notes . . . . .                                                                         | 158  |
| Our Astronomical Column:—                                                               |      |
| New Notation for Lines in Spectrum of Hydrogen . . . . .                                | 162  |
| The Spectrum of Nova Normæ . . . . .                                                    | 162  |
| Prof. Rudolf Wolf, of Zurich . . . . .                                                  | 163  |
| The Companion to the Observatory . . . . .                                              | 163  |
| Solar Observations at Rome . . . . .                                                    | 163  |
| Geographical Notes . . . . .                                                            | 163  |
| Unveiling of the Joule Memorial Statue . . . . .                                        | 163  |
| The Ethnological Museum at Leyden. By Dr. H. ten Kate . . . . .                         | 165  |
| University and Educational Intelligence . . . . .                                       | 166  |
| Societies and Academies . . . . .                                                       | 166  |
| Books and Serials Received . . . . .                                                    | 168  |

THURSDAY, DECEMBER 21, 1893.

## THE TOMBS AT BENI HASAN.

*Beni Hasan.* Part I. (Published under the auspices of the Egypt Exploration Fund.) By P. E. Newberry and G. W. Fraser. (London: Kegan Paul, 1893.)

IN the handsome volume which lies before us the Egypt Exploration Fund publishes the first part of an "Archæological Survey of Egypt," which it proposes to issue under the direction of Mr. F. L. Griffith; and we believe that it will be generally admitted the site selected for description and illustration in the first part of the projected work could not have been better chosen. We are also very glad to see that the committee has changed the scene of its excavations from Lower to Upper Egypt, for there it is moderately certain that excellent results will accrue to the archæologist and Egyptologist. It must not be thought for a moment that we wish to underrate the value of the excavations which the Fund has made in the Delta, but it must be said that in the days, now past we hope, when sentimental Egyptology was more rampant than it is now, too much time and money were spent in the endeavour to bring to light "proofs" of the truth of the Bible narrative which could not exist, and in twisting evidence to suit the fancies of enthusiastic *dilettanti*. We admit that in the Delta these things are "in the air," for the land of Goshen lieth there, and the sites at which the Israelites are supposed to have halted must be sought therein, and the *yam süph*, or "sea of reeds," must border it in some part; but in Upper Egypt we are face to face with the mighty monuments of some of the best periods of Egyptian art and sculpture, and we are free from the influence of the heterogeneous mixture of peoples in the Delta, and in the everlasting hills which fringe the banks of old Nile we have the remains of a nation which could boast of a hoary antiquity, even before Joseph came into Egypt. The spot chosen for the new scene of labour by the Egypt Exploration Fund is Beni Hasan, probably better known as Jebel Beni Hasan, which forms a link in the long chain of cliffs which bound the eastern side of the Nile valley, and for which we may look on the map between Minyeh and Roda, a little more than 150 miles south of Cairo. Here, high up in the rock, are hewn two ranges of tombs, which are approached by a sloping path, at the top of which is a terrace whereon all the large tombs open. Of the thirty-nine tombs at Beni Hasan, twelve are inscribed, and of these eight are of governors of the nome wherein they are situated; two are of princes, one is of the son of a prince, and one is of a royal scribe. In one range—the northern—are thirteen tombs, and in the southern are twenty-six. Speaking broadly, it may be said that both ranges were hewn during the twelfth dynasty, or about B.C. 250. Of the twelve inscribed tombs six may be dated with a fair amount of accuracy; one (No. 14) bears the name of Amenemhät I., and another was probably hewn at the end of his reign; No. 2 belongs to the reign of Usertsen I., and Nos. 3, 4, and 23 we must place in the reign of Usertsen II. Concerning the remaining six, we need have little doubt as to their age, for the

position of some of them indicates that they belong to the period anterior to the reign of Amenemhät I.

Considered historically, the tombs of Ameni-Amenemhät and Khnemu-hetep are of the greatest importance, for they afford us some insight into the life of high officials in those days, and incidentally record some interesting historical facts. In the reign of Usertsen I. Ameni held the high rank of hereditary prince, and he was chosen by his royal master to make three expeditions into Nubia and Ethiopia; on the first occasion he accompanied his king; on the second he set out with the royal heir at the head of four hundred men, and brought back the appointed tribute; and on the third, he marched at the head of six hundred men. In quaint, characteristic language this worthy nobleman paints his own character, and says: "I wronged not the daughter of a poor man, I oppressed not the widow woman. I was not hostile to any farmer, I stood not in the way of the cattle-keeper, I levied no men for my works, there was no beggar round about, neither felt any man hunger in my days. In the season of famine I ploughed the land of the nome, north and south, I saved the life of its people, and I provided food, so that there was no man hungry therein. I gave to the widow the same as to the married woman, and in this respect I treated the younger as the eldest son. When, in after years, there were abundant Niles, and wheat and barley were plentiful, I did not claim payment for what I had given in the previous years." The most interesting text in the book, however, is that in which Khnemu-hetep, a feudal chief, records the chief events of his life, and the high services which he had rendered to his king. He was the son of Nekhera, and of the daughter of a princess called Baket, and he held the office of governor of the Arabian desert, and *utcheb* priest of Horus and Pakhet; the king, Amenemhät II., granted unto him the inheritance of his father and mother in Menät-Khufu, and his property lay on each bank of an arm of the Nile, or of that river itself. As a landowner, he gave great attention to the adjustment of the boundaries of each city in the nome, and his fair and upright dealing in this respect gained him great favour in the sight of all men. The king promoted him over the heads of all his nobles, and conferred favour after favour upon him; his sons, Necht and Khnemu-hetep, who had been born to him by the lady Khati, were each raised to the rank of *Smer uat*. Following the example of his father Nekhera, the son of Sebak-ankh, who from his earliest childhood had held the highest place in the king's favour, Amenemhät built a tomb, upon which are his own name, and that of his father, and it is to the inscription which he caused to be engraved upon it, under the direction of the architect Baqet, that we owe our knowledge of the life and times of this trusted official. The hieroglyphic text of the inscription has been published several times, but Mr. Newberry has succeeded in correcting several errors, one of the most important being in line 12. There is no doubt that this edition of the text is the best hitherto published. But hieroglyphic texts are, in the main, only useful for Egyptologists, and they form, after all, but a very small part of the book, which owes its chief attraction to the large number of beautiful plates which are in it. In these we

find depicted representations of all the chief scenes which are found in the first fourteen of the tombs that form the subject of the part before us, and it would be difficult to speak too highly of their excellence. The reader who has seen the originals will have them brought again vividly before his mind, and he who has not seen them may rest content that he has under his eyes faithful copies of the paintings reproduced in soft and pleasing tints. The subjects for the coloured plates are well chosen, and we believe that they will be generally admired. Altogether, the life of what we might describe as an "Egyptian feudal baron," enjoying high favour with the king, is most thoroughly depicted; the periodic war waged against the blacks in the gold-producing countries, the chase, to keep the body sound and the limbs supple, and the keen personal superintendence of all agricultural operations, whereby the evil results of "absentee landlordism" was done away with, filled the life of these old lords of the soil, who fondly hoped to live in the next world as they lived in this. When we consider the state and luxury in which they lived, and the large households which they maintained, it is not difficult to understand why Egypt was always an object of plunder by neighbouring nations.

Before we end our brief notice of this most interesting book, we must call attention to the hideous system of transliteration which has been adopted throughout; but we are wrong in calling it "transliteration," for that is intended to help the poor reader, who is not an expert, how to pronounce; but this is not, and is only meant to indicate what Mr. Griffith imagines to be the proper way of representing Egyptian characters in English letters. Studies in systems of transliterations are excellent gymnastics for experts, but the non-expert resents the constant changes which are being thrust upon him; and no surer plan of alienating the interest of the general public can be found than that of setting out in a work which is paid for by the general public, and is meant for all readers, a system representing hieroglyphics in English letters, which is both unnecessary and difficult; moreover, we submit that the transliteration which Birch and Lepsius formulated is easy, and at the same time sufficiently correct for all practical purposes.

#### A NATURE LOVER'S CORRESPONDENCE.

*Letters to Marco.* By George D. Leslie, author of "Our River." (London: Macmillan and Co., 1893.)

MR. LESLIE has published a good book with an unpromising title. It contains thirty-seven letters written to an old friend, H. Stacy Marks, R.A. The first of these is dated October 4, 1885; the last, March 6, 1893.

Both the author and his friend have attained to eminence as painters, but there is no word in the book which alludes to their professional careers; and but for an occasional grumble that a picture is not going smoothly, no one would guess that the letters were written from one artist to another.

The interest of the correspondence centres upon mutual associations connected with the banks of the Thames, where they wandered together in days gone by,

observing nature, sketching her, and nourishing their youth with aspirations, many of which they have lived to realise.

That was in very early days, when name and fame were still behind the clouds of morning, and when they used to leave London annually with the expressed intention of "improving the quality of the British kit-cat," which was still in an unregenerate condition.

As the interest of an artist's career lies in his struggles, and as the annals of success make commonplace reading, we can be grateful that all allusion to professional matters has been left out, though we might have been glad to have more artistic observations, such as that of the black rook flying away with a golden walnut in his mouth.

One palpable realised ambition is the pretty property which Mr. Leslie has bought at Wallingford, from which he writes to his old friend, describing the condition of their old haunts, and chatting in a desultory way about nature in general.

As Mr. Marks is an ornithologist, there is a great deal about birds. He observes their ways, and describes the kingfisher hovering over the water, the terns hawking on the shallows, and the poor swallows during a frost cuddling up together to keep warm; and what is a great comfort, he kills nothing. He is not a sportsman, and not being a naturalist he does not want specimens for dissection; he merely observes with loving watchfulness; in hard winters he scatters food to mitigate the lot of his feathered friends, and it is absolute grief to him when his children bring a poor fledgling which they have captured. This is the great charm of his book, which probably adds little or nothing to our knowledge of natural history; indeed, its method is the reverse of scientific, and its originality consists in the persistent way in which the author discerns human attributes in birds. They are to him a little people, whose customs and ways of thinking he studies attentively. The robin comes to him to sing a "conciliating song," the blackbird is "proud, vain, and impudent," and the sparrow is "bold, but he knows that he is only tolerated"; and these things are evidently not stated with any conscious or intentional metaphor, but in perfect good faith. The author, in fact, is an amiable enthusiast, who loves nature with his whole soul; and when the contemplation of birds, beasts, flowers, and fruit has worked him up to a state of enthusiasm, rushes home and writes to his friend to tell him what he thinks about them.

We do not feel in a position to dispute the theories which he occasionally propounds, such as that the young shoots on a hedge are kept in their place and supported by cobwebs, that darkness is favourable to the growth of plants and babies; on all these matters he speaks with more authority than we can pretend to. All we can venture to say is, that "si non e vero e ben trovato"; and his theory of darkness seems to explain the unfolding of a sycamore shoot, though he gives no instance of its operation in the case of the young of the human species.

The contemplation of all things in nature—birds, beasts, and fishes, reptiles, insects, and molluscs, inflames Mr. Leslie to a rapture of affection; and when the fit is on him, he can find extenuation even for snails and sparrows, whereby he soars into a lofty and rarified region of

charity and benevolence, into which we find it impossible to follow him.

There are many amusing descriptions and playful passages scattered through the book, such as the friendship of the donkey and the dirty drake who disliked cold water; and the droppings of the reindeer, which the author spread round his Iceland poppies because he thought it might amuse them; and it is also very pleasant reading on account of its evident sincerity and absence of affectation, of which the following is a fair example.

The author describes the snails in his garden: "the common 'tabbies,'" he says, "have already begun to hibernate, but the bushes are covered with a small flat kind." A less conscientious and more pretentious writer would inevitably have made a shot at their generic and specific names, and given us the words "*Helix aspersa*" and "*Helix nemoralis*" in brackets; but Mr. Leslie very wisely makes no pretensions to be considered a naturalist, though he knows more of the aspect of organic life than many an authority on comparative anatomy; his knowledge is that of Götz von Berlichingen, who "knew every pass, pathway, and ford about the place, before he knew the name of village, castle, or river," and he seems thoroughly to sympathise with the sentiments of Shakespeare's "Biron":—

These earthly godfathers of heav'n's lights  
That give a name to every fixed star,  
Have no more profit of their shining nights  
Than those that walk and wot not what they are.

The accuracy of Mr. Leslie's observation is shown by the illustrations which he has scattered through the volume; some of these are extremely beautiful, such as the "Bird's-eye View of a Swallow," "The Fruit of *Rosa Rugosa*," and "Flight of Starlings and Rooks," as is also the frontispiece, representing his house at Wallingford.

This book we can confidently recommend for its tonic properties. To the great world of men and women given over to satiety and boredom it cannot but be salutary, by pointing out what a world of enjoyment, what a peaceful and engrossing occupation for leisure, lies open to all of us, outside our own doors, and the only price we have to pay for it is to take the trouble to use our eyes.

#### OUR BOOK SHELF.

*A Text-book of Heat.* The Tutorial Physics, vol. ii (Univ. Coll. Tutorial Series.) By R. Wallace Stewart. (London: W. B. Clive, 1893.)

NOT long ago we had occasion to say a few words about the books which have appeared from the pen of this author, and we then stated our belief in him as a writer whose clearness of explanation and conciseness of language would render him popular among students of physics. In the volume now before us, which is devoted simply to the one branch of this large subject of physics—heat—we may again apply the same remarks to the treatment of the subject, the author stating with all clearness and necessary accuracy the various laws, and showing their practical application by means of appropriate examples. In the descriptions of the experiments, as, for instance, in those for determining the absolute expansion of mercury, the object of the experiment in question, the end to be obtained, and the different means of attaining it, are especially emphasised, and the diagrams aid the reader in grasping a clear

idea of the arrangement of the apparatus employed. At the end of each chapter, under the heading "calculations," are brought together all the formulated expressions of the laws deduced in the one preceding—a very useful arrangement for a short revision of the subject. The concluding chapter deals with the application of graphic methods to the results of experiment, and this part of the subject is one of great importance, although generally omitted in text-books. The work, as will have been noticed from the heading, is published in the Tutorial Series, and is a most useful addition to it.

*The Industries of Animals.* By Frédéric Houssay. (London: Walter Scott, Ltd., 1893.)

THIS—the twenty-third volume of the Contemporary Science Series—is an English edition of a good book. It is not merely a translation, but a revised and enlarged edition, to which numerous bibliographical references have been added. By this addition the work has gained considerably in value; for such references are not only useful to the student who desires to increase his knowledge of any matter broached in the book, but they also furnish a means of estimating the weight of the many stories of animal intelligence and instinct contained in it. The first chapters of the book deal with those industries of animals of which the object is the search for prey. These industries are necessarily connected with protective effects providing for the immediate safety of the individual. A number of examples are then given, to show that "social species unite for the common security the forces and effects which they can derive from their own organs." The art among animals of collecting provisions, of domesticating and exploiting flocks, and of reducing their fellows to slavery, is well described, and, finally, the series of modifications which the dwelling undergoes is investigated.

Except in one or two places, the translation reads very well. Forty-four figures illustrate the text, most of them adapted from that great repository of facts in natural history—Brehm's *Thierleben*. Altogether the book is very pleasant reading, and it contains a large amount of matter of interest to all students of animal skill and intelligence.

#### LETTERS TO THE EDITOR.

[The Editor does not hold himself responsible for opinions expressed by his correspondents. Neither can he undertake to return, or to correspond with the writers of, rejected manuscripts intended for this or any other part of NATURE. No notice is taken of anonymous communications.]

#### "Flame."

IN NATURE for November 23, p. 86, under this title, there appears an account of a lecture delivered by Prof. Smithells to the British Association on September 15, in which he brings before the Association those fascinating experiments with which his name has lately become identified. The apparatus by means of which Prof. Smithells draws the "inner cone" of a flame away from the "outer cone," and which he describes as an *appliance for dissecting the flame, or the cone-separating apparatus*, is now quite familiar to most. By means of it a regulated stream of air is admitted along with the burning gas, until a portion of the flame recedes down the tube, and is arrested in its downward movement at the top of an inner tube, where the issuing gases are moving upwards at a slightly greater rate.

In all cases Prof. Smithells calls this descending flame the *inner cone*, and regards the remnant of the flame that remains at the top as the *outer cone*. It would appear to follow, therefore, that if, by means of the "cone-separator," a flame can be so dissected, it must have originally consisted of two cones.

Prof. Smithell describes the flames of hydrogen and of carbon monoxide as being of the simplest construction; it being out of the question that any complications can arise in the combustion of hydrogen to water, and of carbon monoxide to

carbon dioxide. These flames are therefore described by him as being "simply a hollow conical sheath of pretty uniform character." This is undoubtedly a true description; neither of these flames presents the appearance of double coned structure which is seen in such flames as cyanogen, carbon disulphide, ammonia, and others; and it is hardly possible that in a hydrogen or carbon monoxide flame there can be two distinct areas or cones in which different chemical processes are going on. It occurred to me that it might throw some light upon the real value of this cone-separating apparatus as an appliance for dissecting flames, to try its effect upon the single-coned flames of carbon monoxide and of hydrogen. When air was cautiously admitted into these gases, as they burned at the top of the tube, I found that the flame travelled quickly right down the tube, and did not stop at the narrower tube when the upward rate of movement was greater, and did not appear to leave any remnant at the top of the wider tube. I have no doubt but that Prof. Smithells has made this experiment, and with a similar result.

I have found, however, that by a slight modification of the apparatus, it is quite easy to drag down an inner flame from either the flame of carbon monoxide or of hydrogen. In order to do this, all that is necessary is to provide the top of the inner and narrower tube with a cap made of fine wire gauze, either copper or platinum. When this small addition to the original apparatus is made, and the experiment with carbon monoxide is repeated, it will be seen that as air is gradually introduced a portion of the flame descends the tube and sits quietly upon the wire gauze, and, in spite of the flame-extinguishing power of the carbon dioxide, it there generates, a remnant of the original flame remains feebly burning at the top. In the case of hydrogen a similar result is obtained, a portion of the flame descending to the gauze, where it burns with a pale blueish flame, while the remnant burns freely at the top. These experiments show that whatever is the structure of the flame, a part of it can be torn away from the rest by the regulated introduction of air: that in order to divide a flame by this method it is *not* a necessary condition that the flame should consist of more than one "cone," or, in other words, that there should be two distinct areas of combustion. If, therefore, a "simple" flame like that of hydrogen, consisting of a single cone of uniform character, can be divided, the fact that other and more complex flames can also be so divided, does not seem to throw much light upon their structure. As soon as sufficient air has been admitted into a flame, of whatever burning gas, to produce a certain volume of an explosive mixture whose rate of explosion exceeds the rate of efflux of the gases, that exploding mixture will become detached from the remainder of the burning gas, and travel back down the tube. In the case of hydrogen, where a very wide margin exists within which mixtures of this gas and air are rapidly explosive, the admission of a very small quantity of air is sufficient to form such a mixture, and so drag down a comparatively small portion of the entire flame. In the space between these two flames there can only be water vapour as the product of combustion, atmospheric nitrogen, and the excess of hydrogen. The lower flame is a burning mixture of air and hydrogen in which an excess of air is taking part in the combustion, and represents a condition of things certainly not far removed from, if not identical with, the old phenomenon of air burning in oxygen. It is difficult to see in what way the separation of other flames differs from this.

I have no doubt that everyone who has read the account of Prof. Smithells's lecture will have been struck, as Dr. Armstrong was, with the manner in which the classical researches of Dr. Frankland are brushed aside, and the difficult question as to the true causes of the luminosity of flame is settled by an appeal to the "opinion of the majority."

Without touching the question as to whether or not solid carbon is actually precipitated during the decompositions that are going on in a coal-gas flame, the recent experiments of Prof. Lewes leave no room for doubt that the first stage in the process of decomposition and condensation that goes on, is the production of acetylene, which is formed during the passage of the gas through the inner dark area of the flame, where no combustion is going on; that is to say, where the hydrocarbons are being simply strongly heated, but are not burning. This fact seems to have an interesting bearing upon some of the peculiarities exhibited by the well-known flame of air burning in an atmosphere of coal-gas. In this flame the air is in the inside, and the hydrocarbons upon the outside; it is in effect an ordinary coal-gas flame *turned inside out*. The formation of acetylene, instead of

taking place within the flame, as in the usual conditions, in which case it has to pass through the heated area where it is further decomposed with probably the precipitation of carbon, is now produced upon the outer surface or periphery of the flame; it therefore largely escapes combustion or decomposition, and passes into the coal-gas atmosphere with which the flame is enveloped. Hence the flame is non-luminous, and hence also this constitutes the ready method for obtaining large quantities of acetylene first devised by Prof. McLeod. I am not aware that it has ever been noticed that during the combustion of this non-luminous flame there are produced, besides acetylene, other hydrocarbons of much greater density. That this is so is evident from the fact that when the flame has been allowed to continue burning for a length of time, the glass vessel in which it is contained becomes coated with a brown tarry film. This non-luminous flame of air burning in coal-gas can be rendered luminous by a simple device. If the vessel employed in which to burn it be an ordinary bulb-shaped paraffin lamp chimney, it will be seen that when the flame is in the middle and wide portion of the chimney it is non-luminous; if, however, it be thrust up into the narrow part, it at once shows signs of luminosity: the acetylene under these circumstances is reflected back into the flame, which, aided no doubt by the radiated heat from the glass, causes the luminosity. If the supply of air be regulated, the flame may be caused to curl over upon itself, whereby very beautiful vortices are obtained, in which Heumann's floating particles are well seen. There is an old experiment in which two flames of air in coal-gas are placed side by side, and so arranged that at will they can be caused just to impinge upon each other. At the point where they touch a small luminous area is seen to appear, the luminosity being probably due to the same causes.

G. S. NEWTH.

I AM unable to understand how Prof. Smithells can in any way suppose that I either have, or possibly could, cast any imputation on his honesty, "scientific" or otherwise; and I fail also to understand what has given rise to the impression, unless it be that the opening sentence of my letter—which I intended should convey a compliment—has been turned round and a meaning given to it which I never contemplated, and which it cannot fairly be made to bear.

I have always regarded NATURE as a journal which is willing to afford a fair field for the consideration of scientific problems, but the last place in which to raise, let alone discuss, personal questions. By publishing his lecture in NATURE, Prof. Smithells directly challenged criticism, and the only object and intention of my letter was to challenge the validity of certain of his arguments. That he should have taken the view he has, is to me a matter of deep regret. He has now stated his position very clearly, and the passage that he has been good enough to quote from my letter to Sir G. G. Stokes sufficiently defines mine. I fear that we must agree still to differ; evidently we look at these matters from very dissimilar standpoints.

HENRY E. ARMSTRONG.

#### The Postal Transmission of Natural History Specimens.

AT page 100, *ante*, you reproduce a circular letter, sent out by the Academy of Natural Sciences of Philadelphia, on this subject, the object of which is the very laudable one of establishing an international rate of postage for natural history specimens, based on that charged for *bona fide* trade patterns and samples. It is therein stated that the United States Post Office Department recently proposed to the countries comprised within the Postal Union a modification of the rates in favour of a charge so based, but that the Governments of very many of them declined to consider the proposal, and in the list there given Great Britain is included. No precise date for this refusal on the part of the British postal authorities is given, but presumably the date is not precisely recent. Early in 1891, several of our Natural History Societies agreed to approach the British postal authorities on this point, and a letter was addressed to the Secretary of the Post Office (the late Sir S. A. Blackwood) by Lord Walsingham, on March 18, 1891. A reply (which I have before me) to that letter, from Sir S. A. Blackwood, is dated April 13, 1891, and is published in the Proceedings of the Entomological Society of London, 1891, p. 14 (and probably elsewhere). An extract from the letter is to this effect:—"Your



lordship will no doubt be glad to learn that so far as this Department is concerned, scientific specimens sent by sample post, and addressed to places abroad, will not be stopped in future; but I must state that this Department cannot guarantee the delivery of such specimens abroad, inasmuch as they do not come within the definition of sample packets as prescribed by the Postal Union." I may add that within the last month I have, on two occasions, sent specimens abroad by sample post with perfectly satisfactory results.

All naturalists will feel grateful to the Academy of Natural Sciences of Philadelphia for agitating in this matter. But it is to be regretted that the United States Postal Department should, in another way, continue to maintain a barrier against cheap transmission and interchange of specimens. The sample post can, in any case, only be used for small packets, but larger packages can now be sent to nearly all foreign countries by parcel post, the introduction of which was an inestimable boon. The United States Government stands almost alone in persistently refusing to co-operate in this respect. It is not for scientific men to inquire into what contracts that Government may have entered into with private carrying companies, or how far it may be influenced by hyper-protective susceptibilities; they can only regret the facts, and deplore the result.

Lewisham, December 8.

R. McLACHLAN.

#### "Geology in Nubibus."—Mr. Deeley and Dr. Wallace.

MR. DEELEY will not have anything to say to ice conveying thrust as a *solid body*, which has been the sheet anchor of glacial geology for many a decade. He also repudiates Dr. Wallace's notion that regelation can in some way act as a compensating element when crushing supervenes in ice, and thus enable it under crushing pressure to convey thrust. So far so good.

Mr. Deeley, however, bids me turn to ice acting as a viscous body, a subject on which I have written a great deal in my recent book, which he does not seem to have seen.

There are two ways in which we can conceive a viscous body flowing on a flat plain: (1) by pure fluid, or what is commonly called hydrostatical pressure, in which the upper layers move up and down, and the lower layers alone have a horizontal motion; (2) by its particles rolling over each other. The former depends, of course, entirely upon the difference of level of two connected parts of the mass under consideration; the latter depends upon the slope of the upper surface of the fluid.

I contend, as Forbes contended, that in the case of a body so slightly fluid as ice, motion by hydrostatic pressure is practically impossible. The consistency and mutual support of the parts prevent the indefinite transmission of pressure in this way through ice, and nowhere have I seen or heard that in detached masses of a glacier cut off at either end by crevasses the ice rises in one place, and sinks in another, or that the walls of these ice rifts or the perpendicular ice walls in the arctic and antarctic regions or in scarped icebergs bulge out below in the slightest degree, as must happen if ice were to move in this method.

Forbes' experiments and measurements and patient examination of the problem proved that ice as a viscous body moves in fact by its layers rolling over each other, and that this motion is differential, being greatest at the surface and in the middle, and least at the base and sides of a glacier.

It is quite true that the rate of this motion on a flat plain would depend theoretically on the slope of the upper surface of the ice. It is established by experiment, however, that such motion is very largely confined to the surface layers, and when we approach the nether layers the motion quickly slackens, owing to the internal friction and drag of the ice particles. Even on inclined beds, glaciers have sometimes been found frozen to the ground. The evidence of a large number of observers is conclusive, that as glaciers reach the level ground, the motion, even of their upper layers, gradually stops. The masses of ice that collect on the flat Siberian Tundras do not move at all, nor do the thick horizontal ice beds examined by Dall in Alaska. Argument, experiment, and observation are therefore entirely against Mr. Deeley, upon whom the burden of proof rests. Perhaps he will explain what are the conditions under which he conceives his ice sheets to have been formed, to have been maintained, and to have moved. Mr. Wallace confesses that he does not like to face these mechanical issues, which are presupposed in all his reasoning. This is assuredly building on a quicksand, which is not a profitable experiment. He cannot be

serious, either, in arguing that because I believe in Charpentier's view that the Alps were formerly higher, and consequently nursed bigger glaciers, I am therefore committed to Ramsay's extravagant notions, repudiated by nearly all explorers of glaciers, that the lakes of Geneva and Lucerne were dug out by ice. Charpentier's method, in such a case, would have prompted him to first prove the capacity of ice to do the work, and most people will agree that in a scientific argument this method is alone fruitful.

H. H. HOWORTH.

30 Collingham Place, Earls Court.

#### The Viscous Motion of Ice.

Is not Sir H. Howorth wrong in assuming that there is no transmission of hydrostatic pressure in ice? Certainly Forbes was of opinion that such transmission existed, and was necessary to explain the remarkable parallelism between the motion of ice and of viscous fluids. It is a question of scale. Even a cup of treacle will not flatten out indefinitely; still less will a barrel of pitch; but I have no doubt a cubic mile of ice would flatten out, but to what extent is a question for calculation, not for dogmatic assertion. Unfortunately the first requisite of such calculations is wanting, as no determination of the coefficient of viscosity exists. Canon Moseley's experiments are clearly out of court, and in the interesting experiments of Mr. Coult's Trotter in 1883, the length of the portion of ice which took part in the shearing motion is not given.

May I add that the paragraph in Sir H. Howorth's letter of November 23, in answer to Mr. LaTouche, is distinctly erroneous so far as our limited evidence goes.

If Sir H. Howorth will draw to scale the observations of Prof. Tyndall at the Tacul on the side of the Mer de Glace, or those of Prof. Forbes, given on page 354 of his own book, he will see that while the velocity of the ice is greatest at the surface, the viscous yielding or differential motion is greatest at the bottom: and the curve into which a vertical line in the ice is thrown by the motion, is always convex towards the direction of motion, is relatively flat above, and strongly curved towards the base. This is exactly what we should expect on the viscous hypothesis, and justifies the application of hydrodynamical treatment to the problem, if only the necessary data were to hand.

19 The Boltons, S.W.  
December 12.

JOHN TENNANT.

#### Chemistry in Space.

IT may be of interest to your readers to know that the idea of the arrangement of atoms in space, which is looked upon as quite a modern one, is clearly put forth by Wollaston in his paper entitled "On Super-Acid and Sub-Acid Salts" (Phil. Trans. vol. xcvi. 1808, pp. 96-102).

He discusses the constitution of the two oxalates of potash; and I make the following extracts, but must refer your readers to the original paper for the full context. . . . "when our views are sufficiently extended, to enable us to reason with precision concerning the proportions of elementary atoms, we shall find the arithmetical relation alone will not be sufficient to explain their mutual action, and that we shall be obliged to acquire a geometrical conception of their relative arrangement in all the three dimensions of solid extension. . . . when the number of one set of particles (combined with one particle), exceeds in the proportion of four to one, then, on the contrary, a stable equilibrium may again take place, if the four particles are situated at the angles of the four equilateral triangles composing a regular tetrahedron. . . . It is perhaps too much to hope, that the geometrical arrangement of primary particles will ever be perfectly known." Thus Wollaston's conception of the combination of four particles with another is exactly the same as our modern idea of the arrangement of four monovalent atoms (or groups) in combination with a carbon atom. The same idea is also developed somewhat later by Ampère in his "Letter to Berthollet" (*Annales de Chimie*, 90, p. 43-86, 1814), in which he considers the molecules as forming various geometrical figures dependent on the number of atoms contained therein.

JOHN CANNELL CAIN.

The Owens College, Manchester, December 14.

THE MANŒUVRING POWERS OF STEAMSHIPS AND THEIR PRACTICAL APPLICATIONS.

IN a recent number of the *United Service Magazine*, I wrote an article tracing briefly the history of manœuvring powers of steamships as ascertained and applied, or as assumed and applied, or as omitted in application, to the purposes of war and navigation. It was chiefly addressed to the Navy as my apology for certain published views on the causes of the loss of the *Victoria*, but it is suggested that a *résumé* with diagrams would interest the readers of NATURE.

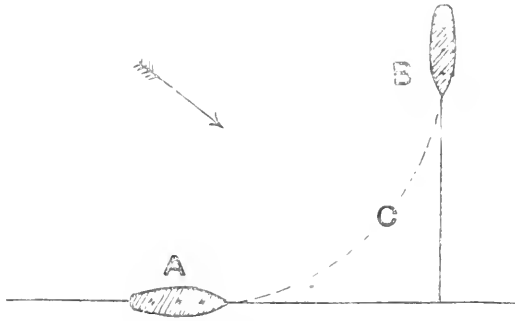

FIG. 1.

Quite in the early days of steamers it was noticed that when they turned under the influence of their helms, they took a wider and more regular sweep than seamen were accustomed to notice in sailing-ships. There was a limit to their powers; for when a steamer had put her helm "hard over," she had done all she could to turn "sharp," and if the turn was not sharp enough to avoid collision, for instance, it inevitably took place unless she could check her impetus in time by reversing her engines.

When steamers began to multiply—I speak of a date before 1854—collisions with them began to multiply also, and it was necessary to devise "rules of the road" for their prevention, such as sailing vessels had for generations possessed amongst themselves. Admiral Beechey, to whom the matter was confided, could not escape from his knowledge of the sweep that steamers made in turning, but it did not occur to him to make any investigations into its nature. He assumed it. Having done so, it did not occur to him that the application of his assumption could only be made by diagram to scale. He therefore based a proposed law on the assumption that the first 90° of a ship's path was a circular arc, but he did not specify what its radius might be in terms of the ship's length. I reproduce in Fig. 1 the fundamental diagram of the great "law of port helm" which was set out in Clause 296 of the Merchant Shipping Act, 1854, and was finally condemned by Parliament in August, 1860. The fact was that no steamer ever did, or could, turn on the path represented, and that the law could not have been drawn had the Admiral been aware of the real path, and had he applied it by means of diagrams drawn to scale.

When the single screw began to supersede the paddle, the characteristics of the turn remained, but constructive difficulties increased the sweep in warships. The late Admiral Sir Cooper Key, being in charge of the Steam Reserve at Devonport, carried out investigations—very incomplete in those days—which culminated, in 1863, in a series of experiments with a gunboat, directed to ascertain the relations between helm-angle, area of rudder, and the length and duration in time, of the path described in turning completely round. It was still assumed that the path was circular from first to last,

and the results as to helm-angle are shown in Fig. 2. The "diameter" of an assumed "turning circle" was the comparative space-measurement employed. The result of the experiments was the introduction of the "balanced rudder" into the Navy.

Our first ironclad, the *Warrior*, had been more than a year at sea when these experiments were made. She was 380 feet long, much longer than any other man-of-war, except her sister, the *Black Prince*, and the time she took to turn round, as well as the space she evidently covered, were tremendous. Still assuming that every part of her path in turning was circular, means were devised to measure its "diameter," which was found to be six times her length, or 760 yards; while, at 12 knots, it took her 7m. 46s. to turn completely round. Everyone was much impressed, but the smallness of the helm-angle—22°, due to want of power to move the rudder over—was much less noticed than the length of the ship; and the fact bore remarkable fruit.

Great changes of thought on the subject of manœuvring occurred both at home and abroad. Everywhere the idea of the circular arc was accepted; no means had been invented for discovering the form of the path, and it was not sufficiently plain that only the first 180° of the turn was of any importance, and that knowledge of the nature of the path for the first 90° was the most important of all. Abroad, the idea of the circular arc was made the substructure of vast and embracing theories. Admiral Boutakov, of the Russian Navy, based a complete system of tactics on the diagram reproduced in Fig. 3, which he called "tangential arcs." It may be seen that the path from S to S' does really embrace the whole question of helm-manœuvres. But no ship beginning to turn at N, and turning back again, could ever, by any possibility, reach W, or S'. The assumptions were entirely apart from the facts. At home, we contented ourselves with ordering that the time any warship took to turn half-round, and

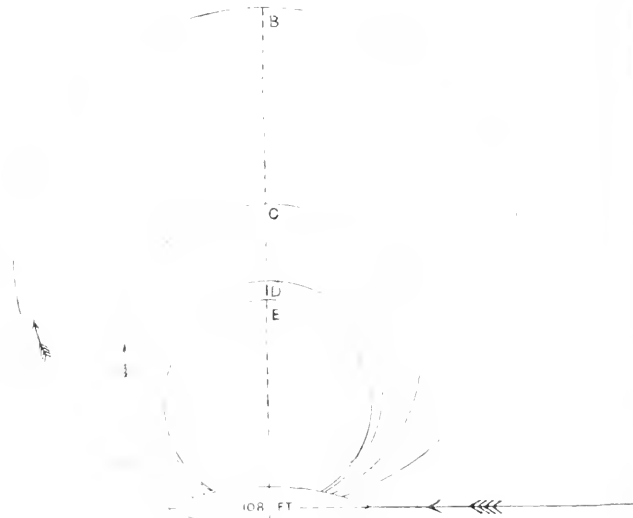

A B = 534 feet 18' of helm. | A D = 238 feet 40' of helm.  
A C = 318 feet 30' of helm. | A E = 216 feet 45' of helm.

NOTE.—The ship is drawn on twice the scale of the rest of the diagram.

FIG. 2.—Scale, 1/2 inch = 100 feet.

completely round, at named speeds, should be recorded, and that the "diameter" of her "turning circle," measured in any way that seemed suitable, should at the same time be ascertained. No advance in the matter could be arrived at by any single experiment of this kind, but I found in later years that a great fund of knowledge

lay buried, which could be dug up when numbers of the experiments were compared.

Meantime the condemnation of Admiral Beechey's law by Parliament had put those concerned on devising a substitute. Discussions over the subject went on from August, 1860, to January, 1862, but there is nowhere any sign that the manœuvring powers of the ships to be dealt with ever came into view at all. A single diagram survives, which is reproduced in Fig. 4. It is obviously not to scale, but was intended to show that a movement proposed to be prescribed for one of the ships would be a

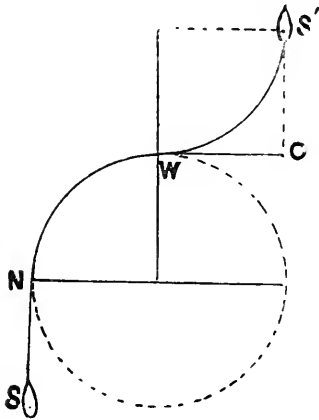

FIG. 3.

dangerous one. It was not noticed that if scale were applied to the diagram, it would show that no possible movement on the part of either ship could avoid the inevitable collision.

The Rules of the Road of 1862 have been continually modified since; and by some appeal to experiment as applied to diagram, the British delegates at the Washington Conference in 1889 were able to carry material amendments. But the fallacy of the original basis has been perhaps most forcibly brought out by Mr. John

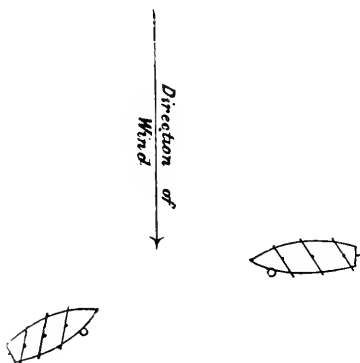

FIG. 4.

Glover before the Statistical Society in 1892. He showed that while in the decade 1880-90, all other wrecks about the coast of England have been reduced from 705 to 353 annually, the wrecks by collision have increased from 69 to 72 annually.

The Rules of the Road—not yet superseded by those of the Washington Conference—were once very carefully attacked by means of experiment and diagram to scale. The answer, made by the highest authority at the time, was based on the diagram reproduced in Fig. 5. The point was, what action No. 1, when steering at different

angles across No. 2's path, ought to take to avoid her. The diagram is again clearly not to scale; but if scale be applied, it is seen that No. 1 is always so placed that no steps taken by her could possibly avoid collision.

In 1865 I had the honour to be entrusted by the Admiralty with the task of designing a system of manœuvring iron-clad steam fleets to supersede that under which Nelson had fought his battles, and which still remained intact. I was enabled, by the kindness of the Admiral commanding the Channel Fleet, to carry out a series of experiments, incomplete no doubt, but sufficient for my immediate purpose. The reduction of these experiments to scale diagrams became the basis of a system of manœuvring which has scarcely been modified, though it has been added to, down to the present day. The flaw in it undoubtedly was the enforced assumption of the circular arc, by the want of better methods of measurement, and the fact that Boutakov's diagram represented general belief.

The failure to duly connect helm-angle with the turning powers of the *Warrior* now began to bear its fruit

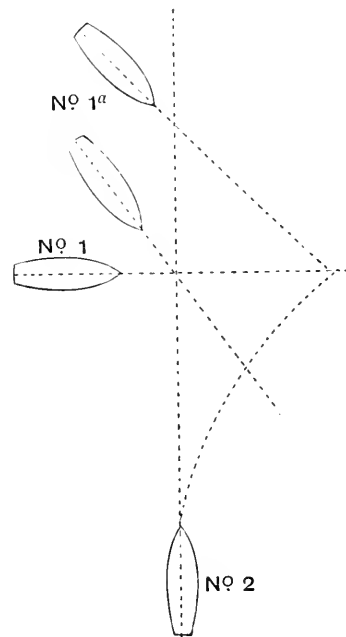

FIG. 5.

in a new direction. The present Sir Edward Reed, K.C.B., became Chief Constructor of the Navy in 1863. He was greatly impressed, as everyone then was, with the necessity of good manœuvring powers in men-of-war. He connected had manœuvring powers, as everyone else then did, with length, and he was not impressed more than anyone else was, with the desirability of systematic experiment to ascertain what manœuvring powers really were, and what share different elements had in influencing them. He proceeded, with universal commendation, to reconstruct the Navy on the thesis that a short ship was necessarily a better manœuvrer than a long ship. His *Bellerophon*, only 300 feet long, was laid down in 1864, and his *Hercules*—still regarded by the whole Navy with affection—only 325 feet long, was laid down in 1866. Sir Edward was justly proud of the manœuvring powers of the *Bellerophon*, whose "diameter" was only 401 yards, as compared with the *Warrior's* 760. It was not sufficiently noted that the smaller space was due in greater proportion to the increase of helm-angle, by means of Captain Key's

balanced rudder, from 22° in the *Warrior* to 37° in the *Bellerophon*, than from the decrease in length from 380 to 300 feet. But it was really for want of experiment and diagram reduced to scale, that the error was committed of exaggerating the element of length. As a fact

beginning to be applied to the rudders, so that any helm-angle provided for, could be obtained at any speed. These changes in the elements of manœuvring powers demanded especial study; and, most of all, some more complete and accurate method of measurement. Anticipating, I here show, in Fig. 6, what these developments came to in the case of H.M.S. *Thunderer*, and how little modification the twin-screw can make in the early part of the turn.

The invention of a satisfactory method of measurement is due to Mr. Philip Watts, late of the Admiralty, who, in the year 1877, applied it to the *Thunderer* for purposes that had nothing to do with manœuvring. But the experiments showed how very far from circular the path really was, and how misleading the idea of a circular path had been. Collisions, unaccountable before, were now easily accounted for, and a terrible opportunity of bringing the new light to bear was offered when, in 1878, the *Bywell Castle* ran into and sank the *Princess Alice*, destroying 600 lives. The accident was wholly a question of manœuvring. Starting, as it was possible to start, with the assumption that the *Princess Alice* was legally wrong in turning to the left when approaching the *Bywell Castle*, disclosing her movement by exhibiting first her red and then her green light in front of the latter ship, the question remained as to what was safe for the *Bywell Castle* to do? She did turn to the right and sink her neighbour. Ought seamen to be instructed that the movement was a right or a wrong one as an answer to the signal received? The diagram which is reproduced in Fig. 7, was carefully prepared by putting all the facts into line with the best experiments, but it was found im-

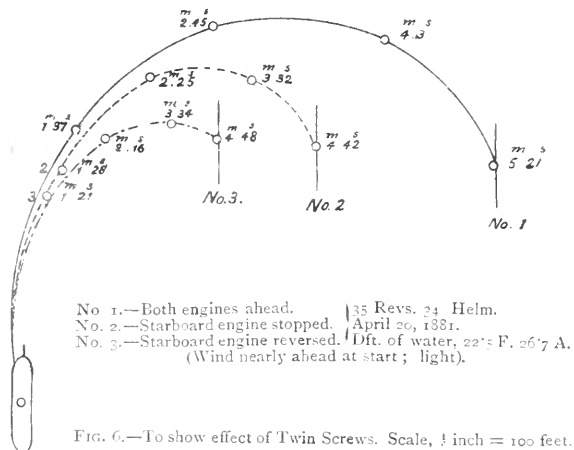

FIG. 6.—To show effect of Twin Screws. Scale, ¼ inch = 100 feet.

it is but one element out of many. The *Edinburgh*, for instance, which is 325 feet long, requires a "diameter" 93 yards longer than the *Minotaur*, which is 400 feet long.

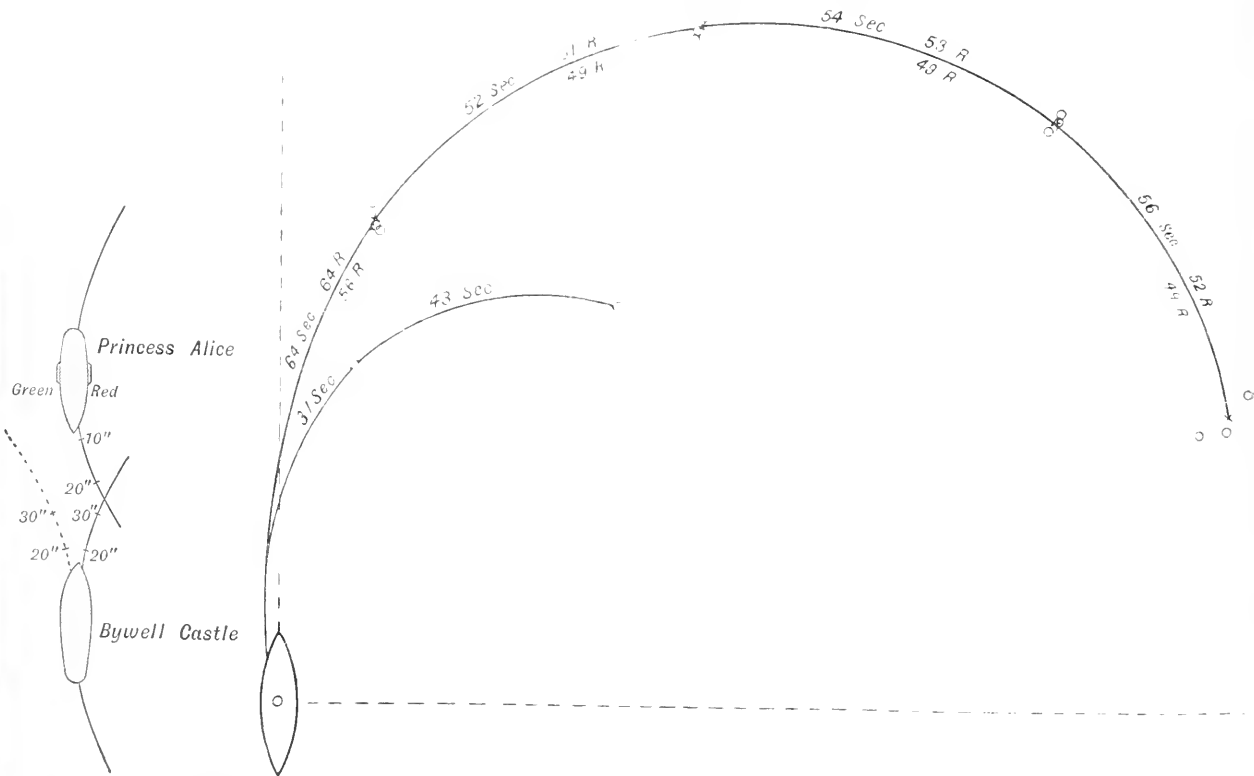

FIG. 7.—Scale, ¼ inch = 100 feet.

FIG. 8.—Scale, ¼ inch = 100 feet.

The twin-screw began to make its appearance in the early days of Sir E. Reed's control of our shipbuilding, and he pushed it forward vigorously. Several twin-screw battleships were launched, and others laid down before he left office in 1870. At the same time steam power was

possible to bring ideas of the manœuvring powers of the ships, and the causes of the accident, together into the discussion. The form of the accident was common, and it remains common; but no teaching yet exists which might help seamen to avoid it.

It was somewhat remarkable that in this same year in the Navy, just, it might be said, when the means of fully applying the experimental method to fleet manœuvring became available, the tide set strongly against experiment. The recommendations for experiment were curtailed, and special promptings and means for carrying out experiments, which had been usefully employed for four years, were withdrawn. The feeling grew that what had been done in 1865 was sufficient for all time; and those who were responsible for errors and shortcomings in 1865, because of the defective means for experiment, found themselves met by the stubborn character of their own mistakes when they desired to amend them. The Navy became too satisfied with the work of 1865, and felt in

powers has shown less apparent variation in the movement of ships under given conditions; and when, with any given method, the observers grow skilled, the apparent variations of movement become less. The accuracy of movement of all ships at speed when turning is remarkable. The curve traced in Fig. 8 is the mean of three turns of  $180^\circ$  to the right, made by the *Edinburgh*, at an original speed of twelve knots, and with a helm-angle of  $34^\circ$ , reached, by means of steam steering gear, in 11 seconds. The small circles represent the successive positions fixed by observation when the turn had reached  $45^\circ, 90^\circ, 135^\circ,$  and  $180^\circ$ . The figures on each side of the trace represent the total revolutions of each screw, and the seconds marked denote the time occupied in passing

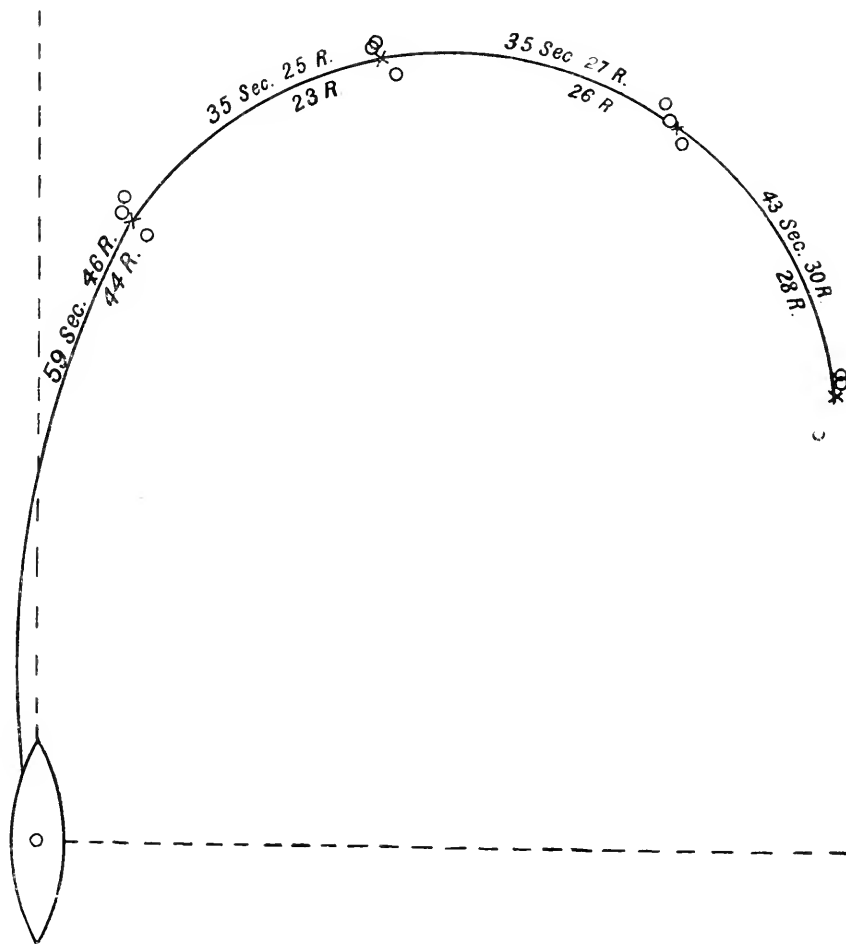

FIG. 9.—Scale,  $\frac{1}{2}$  inch = 100 feet.

everything else disposed to trust to the chances and judgment of the moment when manœuvring the ships in a fleet. What was lost by failure to pursue the experimental method was not seen, and when I state clearly that if the experimental method could have been persevered in and developed, we should not have lost the *Victoria* and Sir George Tryon, my views are scarcely apprehended by the Navy. I cannot enter upon this matter here, though I shall presently make a remark on it which will then be understood. I must conclude my paper by setting forth some of the results which have been obtained by the experimental method.

In the first place it seems made out that every improvement in the method of measuring manœuvring

over each "octant." The accuracy of the turn is apparent to the eye, and while the space measurements in no case vary more than 60 feet from the mean, the time measurements do not vary more than five seconds from the mean, and that is out of a total of 220 seconds.

To the figure is added a trace of the *Edinburgh's* powers of reducing the size of her arc and her speed over it, by reversing both engines full speed, as simultaneously as possible with the movement of the helm.

Fig. 9 traces a path which is the mean of three turns made by H.M.S. *Dreadnought* at 10.9 knots speed with  $32^\circ$  of helm, where the apparent variations in the path seem to be greater. But the space variations here are never more than 74 feet from the mean, while the times

do not vary more than eight seconds from the mean out of a total of 176 seconds. This remarkable precision has been always found. It was equally present in a steam

experiment, would make each ship turn towards the other, X turning to the right, and Y turning to the left; in which case it would not be possible for the ships to touch

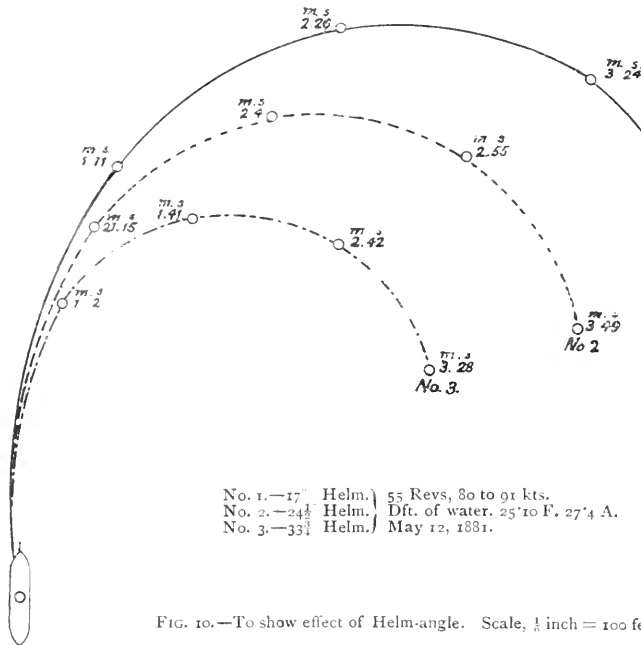

FIG. 10.—To show effect of Helm-angle. Scale, ½ inch = 100 feet.

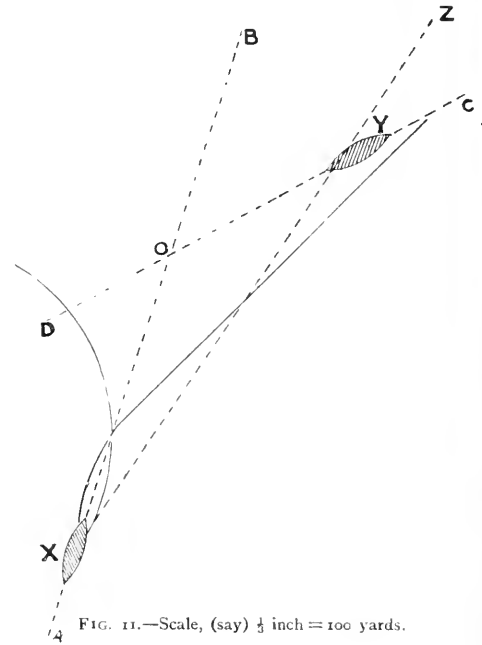

FIG. 11.—Scale, (say) ½ inch = 100 yards.

pinnacle, and the one experiment made with a very light ship in a high wind failed to disclose any difference due to differing directions of the wind.'

The traces of the *Edinburgh* and *Dreadnought* are brought together in order to exhibit the wide differences that exist in the form of the path described by different ships in turning. They show how imperative it is that in fleets, at any rate, these differences of form should be recognised.

But the peculiarity of the form of the path remains nearly the same at all helm-angles, and this makes the necessary equalising of the paths for the purposes of fleet manœuvring easier. It shows, too, the fallacy of the 1865 idea—still preserved—that there can be a single "evolutionary helm-angle" suitable to equalise a large or a small turn. The facts are illustrated by Fig. 10, which shows the effect of varied helm on H.M.S. *Thunderer*.

I have now only to point out how experiment bears on the question of collision between ordinary ships at sea. The ordinary form of approach before collision is given in Fig. 11. The law enjoins that Y should keep steadily to her path, and that X should "keep out of her way." In order to do so, she has been for something like thirty years told that she must decide for herself whether to turn to the left or to the right. Needless to say that as she cannot hope to turn "sharper" than the path marked for her, she generally produces collision by turning to the left, but she is never explicitly condemned for that act.

Ships often only discover one another when so close that it cannot be certain which has the power of avoiding collision. Fig. 12 supposes two *Edinburghs* meeting under such conditions, where it is seen that safety can alone lie in knowledge of the general manœuvring powers of ships and their application to the particular case. Admiral Beechey's law would have caused both these ships turn to the right, and would have made collision inevitable. The existing law—if it were acted on—would compel Y to keep her course, in which case also collision would be inevitable. The natural law, based on

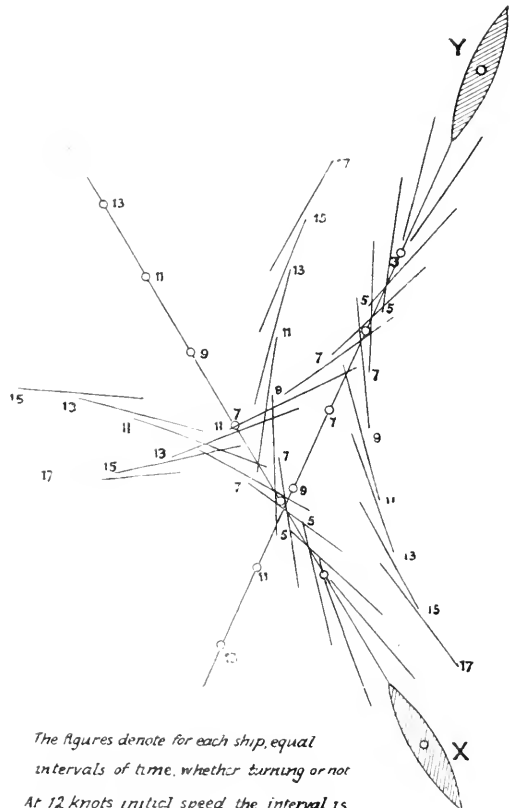

The figures denote for each ship, equal intervals of time, whether turning or not  
 At 12 knots initial speed the interval is five seconds on this scale

FIG. 12.—Scale, 1/88 inches = 100 yards.

I have by me many scores of experiments made with fifteen or sixteen ships and vessels of all sizes and classes.

at all. The rule would evidently apply safely in every such case, unless the ships had nearly equal manœuvring powers, and were then so placed that their turning arcs coincided; two concomitant conditions almost impossible to exist. Needless to say that the results of actual collisions exactly follow the diagram.

It now remains to express my general belief as to the *Victoria*. The paths in turning given of the *Edinburgh* and *Dreadnought* are those of two of the ships which were present on the occasion of her loss. Whether or not they had these traces on board I do not know. There is no mention of such things in the Minutes of the Court Martial, and the questions and answers never go beyond the work of 1865-74. But it is to me inconceivable that the mistake could have been made had such traces been familiar in every ship, and had the late Sir George Tryon been supplied with those of all his ships as a matter of course.

I think that, while blame for this accident has been authoritatively and unauthoritatively strongly thrown on individuals, it is impossible for anyone realising what I have written, to blame any one individual.

P. H. COLOMBE.

### THE TUNICATE.

Far down in the depths of the ocean  
The Tunicate's active and gay;  
It hasn't the ghost of a notion  
How cellular tissues decay.

With a notochord all down its central part,  
It is surely a wee morsel vain;  
For it knows it possesses a ventral heart,  
Not to speak of a dorsal brain.

Then down in the depths of the ocean  
The Tunicate's lightsome and free;  
It hasn't the ghost of a notion  
How degenerate old age can be.

For it must be a pleasing sensation  
That, if other resources all fail,  
You can never come quite to starvation  
If you've been endowed with a tail.

Then down in the depths of the ocean  
The Tunicate's careless and glad;  
It hasn't the ghost of a notion  
Its instincts all tend to the bad.

Till, wearied by youthful diversion,  
It thinks it will rest on a stone.  
It becomes disinclined for exertion.  
—Ah! Tunicate, you are undone!

Now, down in the depths of the ocean  
That Tunicate's losing his tail:  
As though he had swallowed a potion,  
His mental resources all fail.

His brain and his nerves they degenerate,  
His notochord meets a like fate;  
You hardly can class him, at any rate  
He's no longer a true vertebrate.

And down in the depths of the ocean  
He gets him a cellulose frock;  
And all just because of that notion  
Of taking a rest on a rock.

And there is a moral deduction,  
Which I'd like you to cogitate often:  
Don't we all know of stones where, by suction,  
We stick, till our intellects soften?

R. M.

### NOTES.

THE Croonian lecture of the Royal Society for 1894 is to be delivered by S. Ramón y Cajal, Professor of Histology and Pathological Anatomy in the University of Madrid. The subject will be "The Minute Structure of the Nervous System," and the date, March 1.

ON February 16 next, Prof. E. Haeckel celebrates his sixtieth birthday, and in honour of the event it is proposed to place his marble bust in the Zoological Institute of Jena. Friends and admirers of Haeckel who desire to support this object, should send their subscriptions to Prof. Richard Semon, Jena.

MISS KLUMPKE, the well-known lady assistant at the Paris Observatory, took the degree of Doctor of Mathematical Science at the Sorbonne, on December 14. The subject of her thesis was Saturn's rings.

PROFS. BARNARD AND ASAPH HALL have been awarded the Arago Prize for Astronomy by the Paris Academy of Sciences.

PROF. C. F. MABERY has received a grant of 300 dollars from the American Academy of Arts and Sciences, to enable him to carry on his investigations of the American sulphur petroleum.

THE death is announced of Dr. J. Boehm, Professor of Botany in Vienna University, of Dr. D. A. Brauns, Extraordinary Professor of Geology in Halle University, and of Dr. P. A. Spiro, Professor of Physiology in the University of Odessa.

IT appears from the will of the late Sir Andrew Clarke that he has bequeathed the sum of £500 to the London Hospital Medical College, for the foundation of a scholarship.

AT a special general meeting of the Royal Institution of Great Britain, held on Friday last, the following resolution was unanimously adopted:—"That the members of the Royal Institution of Great Britain, in special general meeting assembled, hereby record their deep regret at the death of Dr. John Tyndall, D.C.L., LL.D., F.R.S., who was for forty years connected with the institution as lecturer, professor, and honorary professor of natural philosophy, and who by his brilliant abilities and laborious researches nobly promoted the objects of the institution and conspicuously enhanced its reputation, while at the same time he extended scientific truth, and rendered many new additions to natural knowledge practically available for the service of mankind; and that the members of the Royal Institution further desire to convey to Mrs. Tyndall an expression of their sincere sympathy and condolence with her in the bereavement she has sustained in the loss of her gifted and distinguished husband."

WE learn from the *Victorian Naturalist* that Baron von Mueller has withdrawn from the directorship of the International Academy for Botanic Geography of Le Mans.

AFTER remaining dormant throughout historic time the volcano El Calbuco in the Andes (Lat. 41° 21' S. Long. 72° 38' W.) has renewed its activity. Mr. A. E. Noguez described the eruption in a communication to the Paris Academy, on December 11. Some months ago, columns of vapour began to issue from the crater, their escape being accompanied by the usual subterranean noises, seismic movements, and electrical phenomena. This stage was followed by the ejection of scorie and rock fragments in such large quantities that the surrounding woods were burnt up, and the ground raised to a comparatively high temperature. At the present time the volcano is in full play. Lava has issued from the sides of the cone and flowed down to the base, forming streams of molten rock which have barred the way of torrents and changed the directions of rivers. This phase of the eruption, however, marks a decline of activity, and will in all probability be followed by the quiet emission of gaseous products.

By the generosity of M. G. Solvay, two important institutes have been established at Brussels, namely, a University Institute of Physiology, and an institute specially designed for carrying on electro-biological researches. In May last M. Solvay presented the town with a sum of two hundred thousand francs for the erection and equipment of the University building, stipulating only that the University should provide courses in physiological chemistry, and medical physics relating to the connection between physiology and electricity. This condition was laid down with the object of improving the instruction at the University, and developing the spirit of investigation in the minds of students, thus giving them the ability to carry on physiological researches independently in a special laboratory. For students thus trained, and desiring to apply their knowledge to research of a special kind, the Solvay Institute has been established. At the inauguration of this institute, on December 14, M. Solvay delivered an address on the rôle of electricity in the phenomena of life. He remarked that his conviction was that the phenomena of life could probably be explained by the action of physical forces, and that, among these forces, electricity played an important part. It was to obtain evidence on this point, by the observation and study of facts, that M. Solvay was led to found the institute that bears his name.

AN appeal has been made for funds to establish a small station at Millport for the study of the marine zoology and botany of the Firth of Clyde and West of Scotland generally. It is intended to establish in connection with the station a representative collection of local marine fauna and flora, and, should the funds permit, to construct tanks for the study of living animals and plants. A station, on a limited scale—centred in a small vessel called the *Ark*—has existed at Millport for some years, and has been found exceedingly useful. During 1891 and 1892, the Royal Society of London gave a grant of £100 for the investigation of the algæ of the Clyde sea area. This work was carried on chiefly in the *Ark*; the result being that about eighty species new to the district were found, and of these between twenty and thirty were new to Britain, and about six new to science. The advantages which a permanent station would offer to students of natural history are sufficiently obvious. As the scheme has the cordial approval of many of the Professors at Glasgow University, and also the support of local naturalists, there should be little difficulty in obtaining the contributions required to realise it.

WE learn from the Allahabad *Pioneer* that subscription lists will be opened immediately for the Pasteur Institute scheme. The Amritsar municipality have sanctioned a donation of 1000 rupees and an annual subscription of 500 rupees. The Gurdaspur municipality had previously promised a donation and an annual grant, and among other donations promised are 1000 rupees from Khan Bahadur Barjorjee D. Patel of Quetta. The Government of India have promised to give the services of a qualified medical officer to superintend the institution, which is equivalent to an annual donation of at least 12,000 rupees. Altogether the committee will commence their work under most favourable auspices.

MR. E. A. MINCHIN, whose election to a Fellowship at Merton College, Oxford, we noted last week, was placed in the first class in the Honour School of Natural Science (Animal Morphology) in 1890, and has since been a Demonstrator in the Linacre Department of Comparative Anatomy. It is understood that the examiners sent in a special report to Merton College, to the effect that all of the eleven candidates for the Fellowship acquitted themselves with distinction, and were, in the opinion of the examiners, fully up to the standard required.

NO. 1260, VOL. 49]

THE following appointments have recently been made in America:—Mr. W. S. Aldrich, Professor of Mechanical Engineering, West Virginia University; Mr. F. F. Almy, Professor of Physics, Iowa College; Dr. Charles E. Coates, Professor of Chemistry, Louisiana State University; Dr. A. J. Hopkins, Professor of Chemistry, Westminster College, Pa.; Dr. H. B. Loomis, Assistant Professor of Physics, Northwestern University; Dr. M. M. Metcalf, Professor of Biology, Woman's College of Baltimore; Mr. A. M. Muckenfuss, Professor of Chemistry, Millsaps College, Miss.; Mr. S. L. Powell, Professor of Natural Sciences, Newberry College, S.C.; Dr. H. L. Russell, Assistant Professor of Bacteriology, University of Wisconsin; Dr. J. N. Swan, Professor of Chemistry, Monmouth College, Illinois.

IN a recent *Bulletin* the State Board of Health of Michigan makes the assertion that the statistics of sickness indicate a connection between atmospheric ozone and influenza. Speaking generally, influenza increases with the proportion of ozone in the atmosphere. On the other hand, remittent fever decreases as the proportion of ozone increases.

THE following science lectures will be given at the Royal Victoria Hall during January:—Prof. Smithells on "Flame"; Mr. R. W. Frazer on "Life in South India"; Mr. F. W. Rudler on "Diamonds"; and Dr. Waghorn on "Our Eyes, their merits and failings."

WRITING upon "South American Meteorology," in the *American Meteorological Journal* for December, Prof. W. H. Pickering remarks that the Harvard College Observatory has four meteorological stations in Peru, all within one hundred miles of one another. The first is at Mollendo, on the sea coast, with an altitude of 100 feet; the second is at La Joya, in the desert—altitude 4140 feet; the third is the observatory in the Arequipa oasis—altitude 8060 feet; and the fourth is at the Ravine Camp upon Mount Chachani—altitude 16,600 feet. A fifth has recently been established, by Prof. S. I. Bailey, upon the summit of the Misti, at an altitude of 19,200 feet. The observations made at these observatories will doubtless lead to a much more accurate knowledge of the meteorology of Southern Peru than we at present possess.

AT the meeting of the Royal Society of New South Wales, on November 1, Mr. H. C. Russell described a new form of rainfall map. Instead of having different tints to indicate different amounts of precipitation, Mr. Russell divides the area over which the observations extend into square degrees, and by means of large figures printed on each square, shows to the nearest quarter of an inch the mean rainfall for that spot. Other smaller figures are used to show the number of years the observations have been made, and the number of stations used to find the mean. The map thus gives a large amount of information about the average rainfall of a country, and, at the same time, it shows in a conspicuous manner lines of equal rainfall and outlines of large areas of heavier rainfall, like the shaded maps; giving, in addition, what the shaded map cannot exhibit, viz. the variations in the rainfall of these areas of heavier rain. A map of New South Wales was prepared on this principle by Mr. Russell, specially to meet the wants of the agriculturist; but after it had been completed, it was found to serve the requirements of the meteorologist better than any map constructed on the shaded plan.

IN *Hansa* of the 9th instant, Captain C. H. Seemann discusses the meteorological conditions which accompanied or preceded the slight outbreak of cholera at Hamburg this year, and the serious epidemic of 1892. A comparison of the curves of the temperature of the air and the water of the Elbe for the corresponding period of each year shows scarcely any difference,



while the level of the river was lower near Hamburg this year. It appears from the facts brought forward, that meteorological conditions were in no way connected with the outbreak or spread of the disease, and that the cause must be attributed entirely to the accidental contamination of the water of the Elbe.

AN abstract on the "Occurrence of Amber in Russia," by Fr. Th. Köppen, is published in *Petermann's Mitteilungen*, November 1893, pp. 249-253. The original paper by the same author appeared in a Russian publication. Amber is found on the Baltic shores, the south coast of the Gulf of Riga, and in turf-moors or ancient gulfs of Kurland, embedded below thin beds of turf or sea-sand. Farther north, it occurs on the shores of the Oesel Island, and even in South Finland. The Polish localities along the river Narew are supposed to have been those referred to by Pliny. The most extensive occurrence is in the western provinces of Russia, and in different places on the banks of the Dneiper. From these facts, the "amber-formation" may be said to occur in Western Russia, from the Baltic to the Black Sea. A recent paper, written by N. Sokolow, shows that the lower tertiary deposits of Southern Russia extend also throughout this area. Sporadic appearances of amber occur in the southern parts of Bessarabia in brown-coal strata; they are possibly associated with the amber found in Roumania. Other Russian localities are the Arctic shores of Russia and Siberia, and on the Sea of Okhotsk. A sketch-map accompanies the text, showing the distribution of lower tertiary deposits according to Sokolow, and the most important occurrences of amber in Russia.

LAST week's number of *Die Natur* concludes a series of eleven articles written by A. and S. Ortleb. The title of the series is "Introduction to specimen-collecting, geological and palæontological." The early chapters run rapidly through the physical and geological history of the development of our earth, and point out the significance of the fossils found in sedimentary beds. A short, systematic description follows of the chief groups in the plant and animal kingdoms. A few of the more interesting genera are mentioned, illustrations are given along with the text, and care is taken to bring out the particular epochs and localities to which the fossil representatives belong. This admirable contribution to popular scientific literature will supply a want widely felt among amateur collectors in Germany.

MR. M. CAREY LEA, who recently described a method of transforming mechanical work into chemical action in the *American Journal of Science*, has been continuing these interesting researches, and gives a description of some further remarkable results in the current number of the same journal. Instead of an enormous simple pressure, he tried shearing stress, and obtained more striking and apparent reactions than by the former method. In one series of experiments he placed a small quantity, a few decigrams, of a metallic salt in a mortar, spread it into a thin uniform sheet over the bottom, and rotated the pestle with the utmost force that could be exerted. Two of three decigrams of chloroaurate of sodium left 1.8 milligram or metallic gold. Under the action of the pestle the yellow colour of the salt gradually deepened to an olive shade. When water was poured on, the undecomposed salt dissolved, leaving the gold as a delicate purple powder. Half an hour's trituration of half a gram of the salt resulted in the reduction of 9.2 mgrms. of gold. This reduction represented the conversion of about 500 gram-meters work into chemical energy. Since the reaction is endothermic, there is no doubt that the energy was derived from the mechanical power. That the reaction was not produced by heat was proved by carrying on the operation intermittently, when the reaction took place in the same way, and also by the partial reduction of corrosive sublimate to

calomel by a similar operation. By heat, corrosive sublimate sublimes unaltered. The same conclusion can be drawn from other reactions. Salts of mercury, platinum, and silver gave results analogous to those in the case of gold. In another series of experiments Mr. Carey Lea imbued pure strong paper with a solution of the substance, dried it thoroughly, and laid it upon a piece of plate glass. Characters were then marked on it with the rounded end of a glass rod, using as much pressure as possible without tearing the paper. Marks were thus immediately obtained in the case of potassium ferricyanide, gold and platinum chlorides, mercuric oxide, and many silver salts. The author accounts for the more immediate action of shearing stress in effecting chemical changes by the increased vibration and consequent shattering of the molecules, the action being analogous to that brought about when a bow is drawn over a stretched cord.

THE third number of the *Physical Review* contains a paper, by Alexander Macfarlane and G. W. Pierce, on the electric strength of solid, liquid, and gaseous dielectrics. In the course of a previous research Dr. Macfarlane had found that the "electrical gradient" necessary to force a spark through a thin stratum of dielectric diminishes as the thickness increases, when air or other gas is the dielectric, but remains constant when turpentine or other insulating liquid is the dielectric. Mr. Steinmetz has shown that solid dielectrics, such as paraffined paper, behave in the same way as the liquid dielectrics. In order to obtain more trustworthy observations on these points, the authors have compared the electrical gradient necessary to break down different solid and liquid dielectrics with that required in the case of air. For this purpose they employed two discharging tables, each table supporting two parallel discs about 4 inches in diameter, the connecting rods being joined to the poles of a Holtz electrical machine, so as to form two alternative paths for the discharge. One of the tables, that used for the air gap, was provided with a micrometer by which the distance between the plates could be measured. The sheets of dielectric were placed between the other pair of discs, and the air gap enlarged till a spark passed through the solid dielectric. The difference of potential required was calculated from the length of the air gap, using the results published by Macfarlane and Steinmetz. The equivalent thickness of air is not proportional to the thickness of the solid or liquid, but increases more rapidly as the stratum increases in thickness; the difference of potential, however, required to break down a solid or liquid dielectric is proportional to the thickness. Thus it appears that while thin strata of solid or liquid dielectrics are equally strong whatever the thickness, thin strata of gaseous dielectrics grow weaker as the thickness increases. The authors consider that this difference is not due to a surface phenomenon, but to the greater rarity of the gas which allows discharge by convection to be more readily set up. They find that for liquids, when the thickness is considerable, convection currents are sometimes started, and that in this case the discharge takes place at a lower difference of potential.

*Wiedemann's Annalen* for December contains a description of a modified form of Thomson quadrant electrometer, which has been employed by Herr F. Himstedt. The chief characteristics are the employment of the form of needle which Lord Kelvin uses in his multicellular voltmeter, suspended by a quartz fibre. The lower end of the row of needles carries an insulating stem, to which are fixed two small magnets. These magnets are placed with their axes vertical, so that the earth's magnetism has no tendency to cause rotation of the needles, and are surrounded by a thick copper shield, the induced currents in which damp the oscillations of the needle. The fibre by which the needle is suspended is covered with a thin coat of deposited silver, so that it conducts, and thus allows the needle to be

charged. With a period of 22 seconds, and when the needle is charged by means of 80 small accumulators, one Clark cell gives of 800 scale divisions on a scale 250 c.m. from the instrument.

JUST now Saxony, of which Chemnitz is the most important manufacturing centre, is interested in the comparisons being made in Switzerland between steam-power plants and electricity gained by utilising water. In connection with this subject the United States Consul at Chemnitz has recently made the following remarks (*Board of Trade Journal*):—"It used to be urged that Switzerland's water supply, if properly utilised for obtaining electricity, would reduce very considerably her cost of production. Not only has she many streams, but they fall from such heights that even rivers of small volume have great power. . . . Every effort that science could suggest, ingenuity devise, or mechanics arrange, was made in different cantons of the little Republic to gather electricity by, and transmit it from, her rivers and streams. The latest reports show that if Switzerland, or any country with streams and climate like hers, is to win her way into the world's markets and take a place in the front ranks, it must be by some better method than the use of electricity gained and transmitted from rivers and waterfalls." Electricians will doubtless have something to say on this matter.

ONE of the factors in the so-called self-purification of river-water is regarded by some authorities to consist in the destruction and oxidation by bacteria of some at least of the organic material present. Prof. Pettenkofer, who has been investigating the condition of the river Isar, in the vicinity of Munich, is of opinion that the green living algæ found in this water also play no unimportant part as purifying agents. Prof. Schenck (*Centralblatt f. Allgem. Gesundheitspflege*, 1893), who has been making a special study, from this point of view, of the Rhine in the neighbourhood of Cologne, mentions that, to his surprise, he found comparatively few algæ where most impurities were present, the former being apparently crowded out by the large masses of bacteria. On the other hand, Prof. Percy Frankland has recently stated that, contrary to what might have been anticipated, he found a comparatively small number of bacteria present in the water of a loch, which was so turbid that it was practically opaque when viewed in a glass, by reason of the immense number of algæ present. Dr. Schenck's investigations were carried out to ascertain if the city of Cologne could with safety discharge its sewage untreated direct into the river, relying upon the processes of subsequent self-purification for the water to regain its normal condition. The mass of algæ found was remarkably small, being chiefly confined to the shallows along the banks, or to those spots where protection was afforded from the rush of the stream; the varieties, moreover, present were found to vary very considerably at different seasons of the year. But according to Prof. Schenck, the condition of the river banks in the immediate vicinity of the site selected for the entry of the Cologne sewage is very suitable for the aggregation of masses of bacteria, and he maintains that in conjunction with other factors of purification, such as mass of water and rate of flow, &c., a rapid and thorough purification of the water may be expected. Whatever the general opinion may be of the wisdom of Prof. Schenck's advice, his investigations show that the alleged action of green algæ as important water purifiers cannot be accepted without reservation, but that in the case of each river or stream the nature and growth of these plants must be studied.

THE first part has been sent to us of a work entitled *Sporozoon als Krankheitserreger* (Berlin: Friedländer and Sohn, 1893), by Dr. Alexis Korotneff, Professor at the Kiew University, and Director of the Zoological Laboratory in Villafranca. This "Heft" is devoted to "Untersuchungen über den Parasitismus

des Carcinoms," and is illustrated by four beautifully coloured plates showing the structure of the tissue in cancerous tumours, and the presence of parasites in various stages of development. The large amount of work which has been published during the last three years since Nils Sjöbring's paper on the parasitic nature of this disease appeared, renders a critical summary, such as Dr. Korotneff has written, of particular interest. The author admits, however, that personally the number of cancerous cases which he has examined is insignificant, but adds that the greater part of the drawings which have appeared in the works of Sudakewitsch, Sawtschenko, Kossinsky, Ruffer, and others on this subject, which are based upon observations made upon hundreds of cases, agree almost entirely with his own, and that he therefore considers his experience sufficient to justify him in expressing an opinion, not only on those cases examined by him, but also "über jede andere Krebsgeschwulst."

THE Calendar of the Imperial University of Japan for the year 1892-93 has been received.

THE latest volume of the useful Aide-Mémoire Series, edited by M. Léauté, and published by MM. Gauthier-Villars, is on the "Choix et Usage des Objectifs Photographiques." The author is Prof. E. Wallon.

WE have received a descriptive catalogue of the exhibits in the Anthropological Building of the Chicago Exposition. The anthropological laboratories contained three general subdivisions, viz. physical anthropology, neurology, and psychology. Sections were also devoted to growth and development, and to the anthropology of North American Indians.

A STATEMENT has been published of the origin, plan, and results of the field and other experiments conducted on the farm and in the laboratory by Sir J. B. Lawes, at Rothamsted, for the last fifty years. To the general statement are appended lists of the titles of all the published papers dealing with Rothamsted work, with full reference to the journals in which they appeared.

MR. S. H. C. HUTCHINSON, the Meteorological Reporter for Western India, has sent us a brief sketch of the meteorology of the Bombay Presidency from April, 1892, to March, 1893, inclusive. The year 1892 was one of barometric minimum, and consequently one of excessive rainfall throughout the whole of the Presidency. In some respects the meteorological conditions resembled those of 1878.

PATHOLOGISTS will welcome the publication of a new "Descriptive Catalogue of the Anatomical and Pathological Specimens in the Museum of the Royal College of Surgeons of Edinburgh," vol. i. In this volume the specimens which exemplify affections of the skeleton and organs of motion are described. A subsequent volume or volumes will include specimens relating to the alimentary canal, the respiratory system, &c. Mr. C. W. Cathcart, the Conservator of the Museum, deserves the thanks of all members of the medical profession for his useful and carefully compiled work.

THE *Bulletin* recently issued by the committee for the execution of the photographic star-map, contains Prof. Kapteyn's investigations on the systematic differences between the photographic and visual magnitudes in different parts of the sky. M. Loewy contributes his second memoir on the construction of the catalogue founded on the *elichés* of the star-chart, and M. Prosper Henry describes the methods of measurement and reduction of the *elichés* for the catalogue, adopted at the Paris Observatory.

'A MONOGRAPH of the North American Proctotrypidæ,' by Mr. William H. Ashmead, forms *Bulletin* No. 45 of the U.S.

National Museum. In it is given a systematic description of the species of the hymenopterous family *Proctotrypidæ* found north of Mexico; the genera of the world being also studied and described, as an aid to future students. The *Proctotrypidæ* are considered by some authorities to be closely allied to the *Chalcididæ*, which they usually follow in catalogues and lists of hymenopterous families. Mr. Ashmead considers, however, that there is little affinity between the two, and that such an arrangement is unnatural. He thinks that the *Proctotrypidæ* should be placed at the head of the *Terebrantia*, for after the removal of the group *Mymarinae* (which probably forms a separate and distinct family allied to the *Chalcididæ*), there is no relationship with the *Chalcididæ*.

THE first volume of "Studies from the Physical and Chemical Laboratories" of the Owens College has been published, and it furnishes evidence of the large number of important investigations carried on by the alumni of the College. The volume contains thirty papers in all, most of which have been reprinted from the Transactions and Proceedings of various societies. A paper by Mr. J. A. Harker, "On the Reaction of Hydrogen with Chlorine and Oxygen," has been translated from the *Zeitschrift für Physicalische Chemie*, and appears in English for the first time. Among the papers not previously published is one "On New Forms of Stereometers," by Mr. Haldane Gee and Dr. Harden, and another "On the Duration of Chemical Action in the Explosive Combination of Gases," by Dr. Turpin. The council of the Owens College has done a good work by collecting and publishing the results of researches made in its laboratories during the last few years.

IN his paper on the "Glacial Striæ in Somerville," Mr. Upham concludes, from a large series of observations, "that the currents of the ice-sheet were deflected here from one course to another, and even to several successive courses in so short a time that it allowed no great amount of erosion of the rock beneath." The general motion of the ice-sheet during the period of its maximum thickness was south-south-east over the Boston area, but it was deflected eastward during the recession of the ice. The long axes of the drumlins have also an eastward direction, and Mr. Upham finds in this fact evidence that they were formed wholly during the time of deflected glacial movements.

SINCE the publication, in 1868, of Pasteur's classical work, "Études sur le vinaigre," the only contributions of importance to this subject are those made in this country by Mr. Adrian Brown. It is, therefore, interesting to learn that Dr. Lafar intends devoting special attention to the whole question of the fermentation of vinegar, and the *Centralblatt für Bakteriologie*, vol. xiii. p. 584, 1893, contains his first contribution to, as well as a short review of, the existing literature on this important subject. In the course of his researches at the Institute for the Experimental Investigation of Fermentation Industries near Stuttgart, Dr. Lafar obtained a species of yeast which rendered beer strongly acid, and on studying its behaviour in other alcoholic media it was found to produce vinegar. The various observations made with this interesting organism are conveniently brought together in a table, and include the determination of the amount of vinegar produced, the changes, both in taste and smell, induced in the media, the formation of surface-film, &c. In his next communication, Dr. Lafar hopes to furnish more exact particulars of the physiological and bacteriological characters of this vinegar-producing yeast.

THE *Illustrated Archaeologist* for December contains a number of very fine illustrations. Among the articles is one "On the Excavation of a Pictish Tower in Shetland," by Mr. G. Goudie. The author thinks that the remarkable round towers with the remains of which the islands of Orkney and Shetland are studded

may be assigned a date as far back as the commencement of the Christian era, or earlier. Mr. Arthur Elliot writes on "Some Old Towers at Liège," and Mr. J. Romilly Allen, "On the Celtic Brooch, and how it was Worn." Dr. K. Munro contributes some notes on flint saws and sickles, in which he discusses the differences between Egyptian sickles and the saws found in the Polado lake-dwelling near Desenzano. He is of the opinion that there is little or no evidence that such sickles were in use among the prehistoric people of Western Europe, though compound saws of the kind discovered at Polado may be found among the *débris* of prehistoric civilisations beyond that of the lake dwellings of Europe.

THE additions to the Zoological Society's Gardens during the past week include a Macaque Monkey (*Macacus cynomolgus*) from India, presented by Sir F. D. Dixon-Hartland, Bt., M.P.; a Ring-tailed Coati (*Nasua rufa*) from South America, presented by Mr. Kenelm Chandler; two Arctic Foxes (*Canis lagopus*) from the Arctic Regions, presented by the Duke of Hamilton, K.T.; a Red Kangaroo (*Macropus rufus*) from Australia, two Short-toed Eagles (*Circæetus gallicus*) European, deposited; a Moloch Lizard (*Moloch horridus*) from Australia, presented by Mr. John Carter.

IN line four of article "Experiments on Flying" (NATURE, December 14), read  $n^2$  instead of  $n^7$ .

OUR ASTRONOMICAL COLUMN.

COLOUR-ABERRATION OF REFRACTING TELESCOPES.—At a recent meeting before the Royal Astronomical Society, the proceedings of which will be found in the *Observatory* (No. 208, December), Mr. H. Dennis Taylor read an abstract of a paper entitled "The Secondary Colour-Aberration of Refracting Telescopes in Relation to Vision," which had for its aim the determination of the detriment to vision, if any, and the percentage of light lost for defining purposes, owing to the presence of the usual colour-aberrations. In the colour curves which the author exhibited, where the wave-lengths and longitudinal colour-aberrations were represented by the ordinates and abscissæ respectively, some remarkable facts were brought to light. A comparison with Captain Abney's curves of the luminous intensity of the normal solar spectrum gave a means of obtaining a rough estimate of the percentage of light thus lost. The following table gives one a rough idea of these losses for different objectives in the case of star work, 100 representing the whole amount of light transmitted:—

| Objective.               | Focal length.<br>Feet. | Light lost. |
|--------------------------|------------------------|-------------|
| 36-inch Lick Telescope   | 57                     | 27          |
| 24 " Refractor           | 30                     | 42          |
| 12 " "                   | 15                     | 21          |
| 6 " "                    | 7½                     | 9           |
| 28 " Greenwich Refractor | 28                     | 50          |

Other conclusions which the author draws from the above inquiry may be stated as follows:—In large telescopes the light-gathering power for star work by no means increases as the square of the aperture, the focal length being constant, but a point is reached when it increases simply as the aperture. With a given large aperture the light-grasping power can be considerably augmented by increasing the focal length. In the case of large telescopes, a smaller telescope of relatively large focal length may actually excel in light-grasping power a telescope of larger aperture and shorter focal length. In his concluding remarks Mr. Dennis Taylor refers to the increase of size in the images of stars under increasing exposures; this, he says, can be accounted for by the photographing of the halo of wasted light which surrounds the real image. If further research corroborates the views above stated, there seems to be no doubt that there is still room for improvement in rendering our lenses more perfectly achromatic. Of course the main point in large telescopes is to have them as short as possible, and it is satisfactory to notice the comparative smallness of the light lost in the 36-inch Lick instrument.

STARS WITH REMARKABLE SPECTRA.—The present list (*Astr. Nach.* No. 3200) is a continuation of that which appeared in a previous number of the same journal (*Astr. Nach.* No. 3171).

Among some of the *more* remarkable spectra may be mentioned that of R. Coronæ, which, as Mr. Espin says, is one of the most puzzling in the heavens. The spectrum, he "feels pretty sure," is a double one, and that there is a displacement; at one time the spectra coincide and the star's light is continuous, and at another they are so displaced as to give the appearance of bright lines flanked with dark ones. T. Coronæ, which showed some years ago a nebular spectrum, seems to have undergone a change, as Mr. Espin says that it "is certainly not now the case."

A remark of interest is that the region bounded by the declinations +51° and +56°, and R.A. 10h. 40m. and 11h. 5m. contains a large grouping of coloured stars. Out of 108 stars above 9th mag. there are seventeen which may be classed as orange-red. The region from  $\beta$  to  $\epsilon$  Ursæ is also "very rich."

"HIMMEL UND ERDE" FOR DECEMBER.—In the current number of this journal Prof. Scheiner contributes an interesting article on the cluster in Hercules; it is accompanied both with early drawings of this fine object as viewed in the telescope, and also with the latest photograph. The last-mentioned appears, as one would suppose, as if quite another object had been photographed, so different is the result obtained. Dr. Schwahn treats in a clear manner also of a very difficult subject in an article entitled "Die Lothabweichungen und das Geoid."

A NEW VARIABLE.—In *Wolsingham Observatory Circular*, No. 38 (December 14), the Rev. T. E. Espin announces that photographs taken with the Compton telescope show that the star Espin-Birmingham 57 (R.A. 11h. 39m. 58s.; Decl. +56° 23'), Magnitude 9.5, is variable. The star is now 8.5 mag. It has a Type III. spectrum.

#### GEOGRAPHICAL NOTES.

DR. F. A. COOK has communicated to the American Geographical Society of New York a scheme for the exploration of the Antarctic regions. He proposes to purchase a steam-whaler of 300 tons, equip her specially with several large boats, sledges, and an outfit similar to that used for Arctic travel, including fifty Eskimo dogs. The plan proposed is to steer south from the Falklands to Terre Louis Philippe, and enter the ice-barrier at the first convenient opening where winter quarters may be established and a landing effected. The adjoining land would be systematically explored and all possible scientific observations made. The scientific party will not exceed twelve or fourteen. Dr. Cook has had some experience in Arctic exploration with Lieutenant Peary, and Astrup, now with Peary on his second sojourn in North Greenland, has agreed to accompany him. It is proposed that the expedition should be one year in the Antarctic regions. Dr. Cook estimates the cost of his expedition at £10,000, which he hopes to raise by private subscriptions, grants from scientific societies, and by lecturing. While recognising the greater advantages to science likely to accrue from a national expedition on a large scale, such as that suggested by Dr. Murray, we would like well to see Dr. Cook's party also in the field, which is a wide one, and full of scientific possibilities.

REUTER'S Agency announces that Mr. and Mrs. Theodore Bent and their party left Aden on the 16th inst. for the seaport of Makalla, on the south coast of Arabia, whence they will proceed to the interior with the object of exploring Hadramant.

*Austland* announces the sudden death, on November 21, in Yokohama, of the Austrian Consul-General, Gustav von Kreitner, who was with Count Sechenyi on his great journey in Central Asia as topographer. There his work was of the best quality, and made the results of the expedition permanently valuable to cartographers.

THE *Annales de Géographie*, a quarterly geographical paper edited by M. M. Vidal de la Blache and Marcel Dubois, which has just entered on the commencement of its third volume, has already taken the first place amongst French geographical journals for the comprehensive scope of its contents and the solid value of the contributions to geography which it publishes, as well as for the impartiality of its editorial notes. The last number is particularly good, containing a coloured map of the faunal divisions of the globe, with a discussion by Prof. J. Welsch; an able treatise on the lakes of the Jura by Dr. A.

Magnin, several excellent studies in local geography, an epitome of M. Maistre's great journey to the Shari, and an account of Mount Ararat by M. Chantre.

THE prospective formation of a "buffer-state" between Siam, Burma and China, necessitates a more complete survey of the region than has hitherto been attempted, and an Anglo-French Commission will probably undertake this work at an early date.

DR. H. R. MILL completed a course of twelve lectures on geography applied to commerce, at the London Institution, on Tuesday evening. The lectures were arranged by the Royal Geographical Society as a special educational course, designed to meet the wants of merchants and advanced school-teachers. The first six lectures took up the scientific basis of commercial geography, showing the relations of mathematical, physical, biological, anthropological, and political geography to the special subject. The remainder of the course dealt with the commercial geography of the larger divisions of the British Empire, in order to enforce the general principles in particular cases. The attendance throughout was satisfactory; and the same course was given on Friday evenings at Birmingham, under the Oxford University Extension scheme. Mr. Mackinder will commence the second course of educational lectures for the Royal Geographical Society on January 12, in the hall of the United Service Institution, Whitehall, the subject being the relation of geography to history.

#### A NEW PROCESS FOR THE PREPARATION OF ETHERS.

A NEW and advantageous general process for the preparation of ethers (alkyl oxides), including the most important from a technical point of view, ethyl ether, is described by Prof. Kraft, of Heidelberg, in the current *Berichte*. In the course of an investigation of the aromatic derivatives of sulphuric acid, it was observed that there is a complete analogy between the behaviour of sulphovinic acid and its homologues on the one hand, and the alkyl esters of aromatic sulphonic acids on the other, towards alcohols at moderately elevated temperatures. It was found, in fact, that the conclusions arrived at by Prof. Williamson in the year 1851, with regard to the processes involved in the formation of ethers from the esters of sulphuric acid, are equally applicable to the alkyl esters of the sulphonic acids. For these latter substances decompose in a precisely similar manner to the alkyl sulphuric acids upon warming with alcohols, an ether being the product of the reaction. Thus, for instance, the reactions between alcohol and ethyl sulphuric acid, and between alcohol and the ethyl ester of benzene sulphonic acid, run exactly parallel, as will be apparent from the equations representing them—

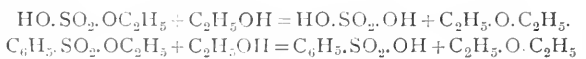

This new class of reactions of the sulphonic acids appears likely to prove of more than merely theoretical interest, for on account of the great stability of these aromatic substances, they are capable of converting far larger relative quantities of alcohol into ether when the reaction is made continuous than the alkyl derivatives of sulphuric acid. Although sulphuric acid is so cheap, and the manufacturing process of continuous etherification has been rendered as perfect perhaps as is possible, still oil of vitriol is unfortunately prone to decomposition in contact with a readily oxidisable substance such as alcohol, becoming reduced to sulphur dioxide which is lost in the gaseous state. Moreover, the powerful affinity of oil of vitriol for water, which is one of the products in the first stage of the reaction, brings about such a dilution after treatment with a considerable quantity of alcohol, that it is no longer capable of performing its function in the process of etherification, which latter must of necessity be arrested in order that the acid may be replaced. Now, the sulphonic acids of the aromatic series, such as benzene sulphonic acid,  $\text{C}_6\text{H}_5.\text{SO}_2.\text{OH}$ , are so stable at the temperature of reaction with alcohol, that the latter is only etherified, and not in the slightest degree oxidised, doubtless owing to the fact that the hydroxyl group present in sulphovinic acid is replaced by the less mobile radicle of the benzene nucleus. Further, the water which gradually accumulates is not retained by the sulphonic acid, but passes over largely with the ether, from which it separates as a distinct layer in the receiver.

This mode of preparation of ethyl ether and its homologues from alcohols by means of sulphonic acids may therefore be very advantageously substituted for the ordinary process now in use. It may be carried on in a perfectly continuous manner, employing the same quantity of the sulphonic acid for weeks, in open vessels and upon any scale. There would appear to be practically no limit to the amount of alcohol which any definite amount of sulphonic acid is capable of converting into ether. Prof. Krafft has actually followed the process with benzene sulphonic acid until one hundred times its weight of alcohol had been so converted, and the residual sulphonic acid appeared as capable of bringing about the reaction, and as free from products of decomposition, as at first.

The reaction in the case of benzene sulphonic acid can readily be proved to occur in the two stages indicated in the following equations:—

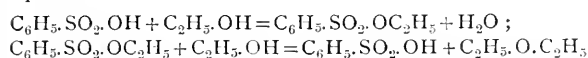

For if the process is arrested at any time and the liquid in the distilling vessel is poured, when cool, into water, the ethyl ether of benzene sulphonic acid,  $\text{C}_6\text{H}_5\cdot\text{SO}_2\cdot\text{OC}_2\text{H}_5$ , immediately separates in the form of a difficultly soluble heavy oil, which after separation is found to boil at  $156^\circ$  under 15 m. m. pressure, which temperature has previously been given by other observers as the boiling-point of the compound.

The benzene sulphonic acid may be replaced by benzene disulphonic acid, para-toluene sulphonic acid,  $\beta$ -naphthalene sulphonic acid, or any stable sulphonic acid or its esters.

As a laboratory or lecture experiment this new process of etherification may be easily carried out in the following manner:—The sulphonic acid, about 80–120 grams in quantity, is conveniently placed in a strong glass tube, 25–30 centimetres high and 5 centimetres wide, closed at one end. The open end is stoppered with a well-fitting ordinary cork bored with three holes, through one of which a thermometer is inserted, through another the tube leading to the condenser, and through the third the stem of a dropping funnel. The benzene sulphonic acid is first melted and then heated to about  $135$ – $145^\circ$  with the thermometer in the liquid. Alcohol is then allowed to emerge into the hot liquid from the dropping funnel, whose stem is made to end in a fine opening only about an inch from the bottom of the reaction cylinder. The supply of alcohol is maintained constant at a convenient rate from a reservoir whose delivery tube passes air-tight through a cork in the neck of the dropping funnel. The two layers of ether and water then rapidly collect in the cooled receiver into which the tube of the condenser passes.

The process lends itself equally well to the preparation of mixed ethers. For instance, if a mixture of methyl and propyl alcohol are allowed to pass through a layer of a sulphonic acid,  $\beta$ -naphthalene sulphonic acid was used in the actual experiment made, at a temperature of  $122$ – $126^\circ$ , the product consists largely of methyl propyl ether. This mixed ether, which has previously been found so difficult to obtain, and which is important as being isomeric with ethyl ether, can readily be obtained pure by fractional distillation of the product, when it is found to boil constantly at  $37^\circ$ . Similarly, di-methyl and di-propyl ether may be readily prepared from the corresponding alcohols. Isobutyl ether may also be obtained with ease from isobutyl alcohol by use of a sulphonic acid, a reaction which it has hitherto not been found possible to carry out by means of sulphuric acid.

A. E. TUTTON.

### THE PROGRESS OF TECHNICAL EDUCATION.

SINCE the passing of the Technical Instruction Acts in 1889 and 1891, authorising County Councils to devote the funds accruing under the local taxation (Customs and Excise Act, 1890) to educational purposes, considerable progress has been made both as regards the number of authorities who have availed themselves of the provisions of the Act, and also in respect to the proper disposal of the funds. From the last report of the National Association for the Promotion of Technical and Secondary Education it appears that out of a total of 126 local authorities in England and Wales, 114 are now giving the whole, and twelve are giving part of the grant to educational

purposes, and, estimating the total amount distributed at £750,000, no less than £604,000 is spent to this end. These figures show that the work of technical instruction is firmly established, and it only needs to be organised and consolidated to become a very important factor in our educational system.

It seems desirable, now that the scheme has had sufficient time to crystallise into shape, to put on record some of the experiences of Technical Instruction Committees, as set forth in reports to various County Councils. By this means it is possible to give an idea of the developments which are most likely to end in good results. No attempt is made in the following to discuss all the reports, for such a course would be beyond the limits of this paper. A few reports have been selected, and from them extracts have been taken which are likely to be of use for future procedure.

For convenience we begin with the northern counties. The Northumberland Committee reports that—"The average attendance at the science classes was not quite as satisfactory as might have been anticipated. It is notable, moreover, that the centres where the attendance was smallest were not always situated in sparsely populated districts. On the contrary, in more than one fairly populated district, where educational work of a similar character has been carried on for some years, and where a general and ready appreciation of the advantages offered might reasonably be expected, the results were disappointing. In several instances the teachers experienced difficulty on account of the lack or diversity of the previous training of the students, and it is to be hoped that the more general establishment of night schools and continuation classes will, in the course of time, prepare the ground for the work of the special technical instructors."

In thus expressing the need for more schools to prepare the ground for technical instruction, the committee shows its good sense. Elementary science is the best foundation of a technical education, and to attempt to infuse a knowledge of technicalities into the minds of the young mechanics of this country without such a preliminary grounding, is to court failure. The action of the Department of Science and Art, in withdrawing grants for second-class certificates, was taken in order to force the Technical Instruction Committees to provide the necessary elementary instruction. Unfortunately, however, some committees have not yet realised their duty in this matter, so between them and the Department many classes in elementary science have fallen to the ground.

One of the greatest needs experienced by Northumberland is for a good secondary school. To quote the report:—"The facilities for secondary education in Northumberland are in certain parts of the county entirely absent, and where they do exist appear to be in many cases inadequate, inefficiently equipped, and having no relation to the established agencies for elementary and higher education. In the south-west of the county there is no secondary school of any description, and the lad who gains a scholarship has no choice between Newcastle and Carlisle. . . . Of the schools of a secondary character already in existence in the county, in only one or two cases is there any attempt to provide systematic instruction in science, and in no case is there, outside Newcastle, laboratory accommodation for practical work in chemistry or physics."

This is a very regrettable state of things, and much progress cannot be made until it is altered. A good secondary school should be established at every large centre of population. There are, however, numerous large districts not so favoured. For example, the Technical Instruction Committee of the West Riding of Yorkshire, which is without doubt doing as good work as any committee in the country, reports that in the Todmorden district, with a population of over forty thousand, the nearest available secondary schools are at Halifax, more than twelve miles away, and there are many districts in other counties far worse off. Clearly a portion of the sums now spent in the railway fares of holders of scholarships would be better expended in the establishment of secondary schools in the required districts, or by increasing the scholarships to the amount necessary to cover the cost of maintenance of the scholar at a residential college. The payment of the West Riding Committee for railway fares during the year covered by the last report amounted to nearly £4000, of which about £3000 was expended under the scholarship scheme. This money would be better spent in subsidising local technical schools, and the committee intends in the future to follow such a course as far as possible.

It has been remarked that the Department of Science and Art is throwing its responsibility to some extent upon the County Councils. The West Riding Committee estimates that by the withdrawal of grants for apparatus and second-class students, an expenditure of more than £3,500 has been shifted to their Yorkshire Council. It is justly complained that "the changes have been carried out without in any way considering the views of the County Council. It is clearly necessary that some distinct understanding should be arrived at as to the spheres to be respectively occupied by County Councils and the several Government departments, including the Education Department, the Science and Art Department, and the Agricultural Department, or it may be found that the funds specially granted to the County Councils for the purpose of technical instruction are being largely absorbed in carrying out the work hitherto devolving upon Government departments."

To some extent, however, the departments referred to are completely justified in their action. Thus, instruction in elementary science can very well be relegated to local authorities, and so leave the Department of Science and Art to foster more advanced work. This brings us to another point, viz. the system of payment by results. Any other system involves the employment of a large staff of inspectors, and the question then arises as to whether the close inspection required ought to be carried on by the County Councils or by Government officials. It is the opinion of many directors of technical instruction that a Government official is in a better and more independent position for doing such work than a county official. Usually the work of inspection done on behalf of most counties is small. In the case of the West Riding Committee a number of inspectors have been appointed, and the grants made to classes, schools, and institutions under its jurisdiction take the form of capitation grants, depending, not upon the instruction given, nor upon the number and size of the classes at each school or institution, but upon the attendance and work of the individual pupils and students. This admirable system is certainly worthy of extended application.

The Union of Lancashire and Cheshire Institutes has done much to promote primary, secondary, and technical education in Lancashire, Cheshire, and North Derbyshire, and to consolidate the various associations that exist in those counties. The Union acts as an examining board, and offers special prizes and exhibition for the encouragement of science and art. As evidence of the importance of the Union, and the great activity shown in the cause of technical and secondary education, it is sufficient to say that 128 institutes are affiliated to it, with a membership of over 100,000, and upwards of 80,000 students attending evening classes, and at the examinations held this year 10,700 papers were worked. These facts are enough to indicate that the Union has become an important examining authority in Lancashire and Cheshire. It is satisfactory to know, therefore, that the governing council fully recognises the necessity of good teaching and a thorough systematic scheme of education. It is to some extent owing to the existence of this Union that Lancashire ranks among the counties doing the best educational work. Cumberland and Durham are also developing excellent and comprehensive schemes of instruction.

Passing now to the southern counties, we find that Kent has been largely spending its money upon University Extension Lectures. The following extract from a report of one of the lecturers is therefore of interest:—

"Although the last two years' experience in Kent must have convinced all of the great possibilities of technical education in rural districts, yet at present the success is but partial, and the results ephemeral, owing to the isolation and want of continuity of the various educational ventures in process of trial. To achieve real educational results, local classes under local teachers should be formed in each village centre. Laboratory accommodation of a simple and inexpensive nature should be provided, and from time to time a course of lectures by an experienced lecturer might supplement the local class, and serve to arouse general sympathy, interest, and enthusiasm.

"Most emphatically would I urge, with the whole conviction of past experiences, the absolute necessity for practical laboratory instruction as a part of any scheme for the teaching of chemistry. To make technical education a real servant to the national weal, and a sound branch of educational progress, it will be necessary to connect, systematise, and unify the varied educational machinery employed. The successful founding of village laboratories and classes, under capable instructors, will

make it possible for a village lad to place his foot upon the first rung of a ladder that will raise him through urban technical institutes or county colleges to the higher levels of scientific and technical instruction.

"As an extension lecturer, I feel bound to confess that, standing alone face to face with the problem of technical education in rural districts, our present system is doomed to failure unless supported by an adequate system of local teaching, and, as a student of science, I feel convinced of the absolute impossibility of imparting an intelligent group of scientific principles capable of practical application and utility unless such instruction be supplemented by courses of practical and experimental study."

This is a right view to take. The function of the extension lecturer is that of a pioneer in the case of science, whatever it may be with literature. There is no doubt that in the classes held after extension lectures, the lecturer assumes more the part of a teacher by being brought into closer contact with the students, but even then it is doubtful whether he is often regarded as more than a popular exponent of elementary principles.

The Technical Instruction Committee of the Surrey County Council is a very strong one, and its efforts have been attended with a remarkable measure of success. In the tenth report of the committee, however, it is remarked with regard to the science classes: "There is probably no branch of the work more educationally important than this, and in Surrey, as in other counties, it has been found that there is none which meets with more passive opposition from the public, and, perhaps, costs more, in consequence of the entire lack of efficient teachers in the localities themselves." We are afraid that this is very true. That undefinable quantity—the general public—may attend science lectures of which the main features are magic-lantern illustrations, or explosions and pretty experiments; but that is quite a different matter from attending classes requiring close study. We do not for an instant hold that popular science lectures are not productive of good. By their influence the commonality are brought to know something of the poetry of science, and are set thinking about nature's laws and wonders. What we do contend, however, is that such discourses must be regarded as of a recreative character, calculated more to interest and amuse than to give a clear view of the true inwardness of scientific things. The general public wants variety and highly-coloured facts, and a very small proportion indeed are inclined to take upon themselves the drudgery of hard study. Technical Instruction Committees should remember, therefore, that though the attendance at classes may be small in comparison with that at lectures, the students are mostly workers who take up science seriously, and with the full knowledge that many difficulties must be met and overcome. It is upon this class of the community that all schemes of technical instruction depend for their success. As to the second point raised in the above extract, there is little doubt that, in many counties, peripatetic teaching by good teachers, who can be obtained by the payment of a good salary, is preferable to entrusting the instruction to local dabblers in science. This applies chiefly to country districts in which science was almost unheard of before the County Councils began their educational work.

In the last scholarship report of the Surrey Committee, Mr. Macan, the organising secretary, makes a gratuitous remark that can by no means be substantiated. He says: "The subjects which require most attention in the schools appear to be chemistry, heat, and electricity, and masters are reminded that the purely bookish and routine instruction, which serves to gain South Kensington results, is not enough for a scholarship examination." This is a cheap criticism that might well have been omitted. Any teacher who has had experience of the South Kensington examinations knows that great stress is laid upon the practical teaching of the subjects named, and examiners are expressly forbidden to award marks for meaningless phrases such as are given by candidates with mere book knowledge. And we will say further, that any candidate who could pass the elementary examinations in chemistry, heat, or electricity, held by the Department of Science and Art, would come off with flying colours in the scholarship examination of the Surrey County Council. There is not a single question upon these subjects contained in any of the examination papers of the Council but what a departmental examiner at the present time would consider too elementary for South Kensington candidates.

The work of the Berkshire Technical Instruction Committee has been greatly facilitated by the establishment of the University Extension College at Reading. The college possesses good teachers, and, owing to the proximity of Reading to London, and the special relations which the college has to Oxford, the services of specialists can easily be obtained to supplement the teaching of the regular staff. For the sum of about £300 per annum paid to the college, systematic instruction is given to teachers in elementary schools at four centres. The scheme followed provides an excellent graduated course extending over three years, and given by well-qualified instructors. An agricultural department, such as exists at Bangor, Leeds, and Newcastle, has been added to the college, so that it will not be necessary to send students holding agricultural scholarships out of the county for their instruction. The establishment of University Extension colleges at strong centres is certainly an admirable plan, and County Councils would do well to assist in their foundation and adequate equipment.

An important report upon the relation of secondary schools to a county scheme of technical education has been prepared for Southampton county by Mr. Vaughan Cornish, and adopted by the Technical Instruction Committee. The fact is recognised that it is of little use to make provision, by scholarships or otherwise, for the highest forms of technical training unless there are schools which provide such an instruction. Hampshire at present possesses very few schools of this kind, but the committee proposes to assist, by means of capital grants to improve the appliances for teaching, by capitation grants, and by scholarships, the public secondary schools in the county that are able to give an efficient general preparation for an industrial (*i.e.* manufacturing, agricultural, or commercial) career. Something can be said in favour of this scheme, but great care will have to be taken in the selection of the schools, or the funds may be misapplied.

From the report of the Wiltshire Technical Instruction Committee, it appears that that county shows a lower standard of general elementary education than that of almost any county in England. On this account, the majority of the students are not fit recipients of higher or technical education; and the fact that very few technical or secondary schools exist within or in the near neighbourhood of Wiltshire, has rendered the work of the committee most difficult. It has been necessary to create as well as foster a desire for technical education. In this connection the following extract from a letter addressed to Lord Fitzmaurice by Mr. Ashenhurst is of interest:—

"It must be borne in mind that mathematics are the real foundation on which technical knowledge alone can be built up, and I am fully convinced in my own mind that intending students seeking instruction in the different technological subjects, for the teaching to be of any practical use to them, they must of necessity study the above-mentioned subjects. Until such times as classes for the study of the higher branches of arithmetic and mathematics are established, it is almost useless for the committees of different technical schools in the county to expect a large number of students to derive advantage from the various subjects being taught in technology.

"These remarks are based upon the fact that, personally, I have been obliged to teach arithmetic before the students could make the necessary calculations for the branch of textile industry I am now particularly engaged to teach, *viz.* cloth weaving and designing.

"Had such institutions as the Mechanics and Working Men's Institutes, which have been so prevalent in the large towns and villages of the North for this last thirty or forty years, been established in this district, where evening classes could have been held for instruction in elementary subjects, the educational standard of this county would have held its own with that of any other in the United Kingdom."

But though the committee has had to labour under such difficult conditions, and has made some mistakes (which was inevitable, perhaps, under the circumstances) it has worked energetically and well in initiating and fostering technical education in Wiltshire, and it has evolved a system of instruction that ranks in point of excellence even with that of any northern county.

The real object and scope of technical education is thus stated by the Devon County Council:—

"It is not contended that technical education will prove a panacea for all the evils resulting from the depression of trade

and agriculture, or that it will remedy all the difficulties arising from foreign competition. But it is certain, that by due attention and reform in our educational methods, a good deal can be done to remove some of the more serious defects under which our industries are at present carried on.

"Technical education has been described as being not so much a specific subject, or group of subjects, as a *method*. It is concerned with the 'why' and the 'wherefore' and the 'how.' It enables workmen to develop their faculties, to obtain a knowledge of the principles underlying their work, and to get thoroughly practical information with regard to the materials and the tools which they use. It provides a means for the training of the eye and hand, and encourages dexterity, neatness, and order; and while not in any way antagonistic to book learning, it relies to a great extent upon handwork rather than upon headwork. It does not, however, involve the teaching of the practice of a trade or industry, or the drilling of individuals as apprentices would be drilled."

This certainly reads very well, and may be taken as a sign that Devonshire is at last beginning to work on good lines. We notice with some regret, however, that the committee has decided to relegate some of their powers to District Committees. The whole provision of technical instruction is to be in the hands of (1) the County Technical Education Committee; (2) the District Committees, who are responsible to the County Technical Education Committee; and (3) the Local or Parish Committees, who are in turn responsible to the District Committees. The general opinion of those who ought to know is that the system of District Committees or Divisional Committees is a hopeless blunder. Such bodies may be of use for advising purposes, but when money has been allotted to them for distribution, it has generally led to inefficient and extravagant expenditure. It is satisfactory to learn that the instruction in the technical and the science and art schools of Devon is increasing in comprehensiveness, but there is yet much room for improvement. The last report shows that all the schools devote considerable time and energy to art, but few of them take up an adequate number of science subjects.

The committee of the Cheshire County Council does not institute classes, but make grants to various centres to carry out class work. A staff of lecturers is kept engaged in visiting various places, and giving series of lectures on subjects mostly connected with agriculture. Grants are made to grammar schools, and considerable subsidies are given to various bodies for building purposes. In addition to these grants, most of the town councils and local boards in Cheshire tax themselves for technical instruction purposes. The county also possesses a comprehensive scholarship scheme. It seems a pity, however, that the committee does not pay more attention to the teaching of the rudiments of science, instead of concentrating their energies almost entirely upon "bread and cheese" subjects.

Before the Technical Instruction Act came into operation, Shropshire had done very little to foster education of any kind. It is not at all astonishing, therefore, to learn that much of the early work of the Technical Instruction Committee was futile. In 1892 the scheme for agricultural and science scholarships completely failed; six were offered of the former, and ten of the latter, but though the examinations were well advertised, only one candidate entered his name, and he failed to obtain half the total marks adjudged to the papers set. There was also a very limited competition for the exhibitions and scholarships offered this year; indeed, the results have been so unsatisfactory that the committee has rescinded the original scholarship scheme and substituted another. Salop is not alone in this respect, for quite a number of counties have had a difficulty in producing candidates for their scholarships, to their discredit be it said. The committees of these counties will have to work for many years before they bring their charges up to the standard of counties like Yorkshire.

The work of technical instruction carried on in Somerset is based upon broad lines, and is extending. From the outset, however, the task of the committee has been made more difficult by the almost complete absence of fully organised schools of science and art, the absence of any adequate provision for science or technical training in the secondary schools, and the consequent inefficient previous education and training of those who have attended the classes in special technical subjects. It was to be expected in such a case that University Extension lectures should be found a satisfactory means of reaching the adult population, and also of great service in creating an interest

in science and in technical instruction generally. The Somerset committee is laying an excellent foundation on which to erect a permanent and comprehensive system of technical education, but some time must elapse before the structure will be seen and properly appreciated by the county. The following extract shows that the committee realises the importance of instruction in elementary science and mathematics:—

"It is the boys at present at secondary schools who will in time become directors and leaders of industries, agricultural or otherwise, and from whom improvements in our various industries ought to come. The best way to prepare them for their future career, and to equip them for their struggle against foreign competition, is to begin whilst they are still at the secondary schools, and give them a sound general education, including a large proportion of science and mathematics. They will thus learn something of the method of experiment and of the manner in which knowledge is acquired, their powers of observation will be cultivated, and their judgment to some extent trained, and they will learn to see much more clearly than at present the intimate relation between science and their daily life and occupations.

"It seems certain that the only way in which a real appreciation of the value of technical instruction in agriculture can be created is to provide for the coming generation of farmers a sound training of the character indicated. In this connection it may be well to call attention to a statement made by Prof. Fream, in his report on technical education to the Royal Agricultural Society of England, that his own experience, extending over many years, shows that a boy who is 'fairly competent in mathematical studies,' is as a rule very good material to work upon in giving instruction in the principles and practice of agriculture. To mathematics, from this point of view, natural science may unquestionably be added.

"At present it must be admitted that the science teaching in the secondary schools in Somerset has not reached the degree of excellence and thoroughness that is desirable, and in some instances the teaching of mathematics is capable of considerable improvement. There is at present no school in the county at which higher scholarships under the Technical Instruction Acts could fitly be made tenable."

Staffordshire did excellent work in the cause of technical education before the passing of the Technical Instruction Act, and since then it has taken the initiative in many important developments. Both last year and this, a number of teachers in elementary schools received grants towards the expense of a course of manual instruction in wood-work, metal-work, and cardboard-work at Dr. Götz's institute in Leipzig, and most of them are now conducting classes in the county. This system cannot be too highly commended, and is worthy of adoption by every county: for by its new methods of work will be learnt, while the insularity that characterises the British workmen will be removed.

Like many other counties, Oxfordshire has to lament the want of an adequate number of secondary and technical schools. On this account it has been found difficult to arrange for the further education of holders of county scholarships. Notwithstanding these serious defects, however, the committee reports that, taking the county as a whole, secondary and technical instruction is in a state of increased efficiency. In common with other committees, that of Oxfordshire sent in 1892 a number of teachers to attend the summer courses on geology, chemistry, botany, and mechanics, arranged at Oxford by the delegates for the extension of University teaching, and with most satisfactory results. A similar summer course for County Council students was held this year, the subjects and the lecturers being:—Geology, Prof. A. H. Green, F.R.S.; Practical Physics, Rev. F. J. Smith; Hygiene, Dr. C. H. Wade; Chemistry, Mr. J. E. Marsh; Animal and Vegetable Pests of Crops and Stock, Mr. P. Chalmers Mitchell and Mr. J. B. Farmer. The success of these short courses indicates that it may be desirable for counties to grant scholarships which would enable students to reside in University towns during term, and take advantage of the many facilities for study available at these centres of learning.

No reference has yet been made to the county boroughs. This survey would not be complete, however, without a few words on the work done in some cities. Oxford city, for instance, has a very strong Technical Instruction Committee, and the work accomplished during the last session shows a very considerable advance upon that of the previous year.

The city of Liverpool possesses a scheme of technical instruction that connects educational institutions from the elementary schools up to the University by means of scholarships and free studentships, and is thus a true educational ladder. The technical instruction is controlled by a sub-committee of the Liverpool Library Museum and Arts Committee. Before this sub-committee came into power, much of the work of technical instruction previously carried on in the city was supported by voluntary contributions, but these were largely withdrawn as soon as public money became available for the purpose. Owing to the loss of income due to this cause, and that which has resulted from the withdrawal of grants by the Department of Science and Art, and the City and Guilds of London Institute, a large portion of the funds set apart by the Council for purposes of technical instruction has to be used in supplying these deficiencies. But in spite of this, new branches of work have been developed, and in a very short time the whole scheme of the sub-committee will be in successful operation. A nautical college has been established, and from the last report of the head-master, Mr. James Gill, it appears that an astronomical observatory is to be erected in the school-yard, which will serve to create a greater interest in nautical astronomy and the almanac by reference to the aspects of the heavens, revealed by the telescope, and the astronomical methods of measuring time. For completeness of equipment and suitability for the work of technical and scientific nautical instruction, the college compares favourably with any of the same kind in the world.

The borough of Bootle has the distinction of being the first to take advantage of the Local Taxation Fund for technical instruction. The instruction provided in the borough is of the right kind, and should lead to good results.

The first report of the Technical Instruction Committee of Plymouth shows that progress is being made. That the demand for technical instruction is increasing in this borough is evidenced by the fact that though a fine school was opened last year, the building will have to be extended in order to provide the necessary accommodation for students.

It is beyond the scope of this article to refer to the numerous institutes and schools, such as those of Manchester, Birmingham, Bradford, Bristol, and Bolton, that existed before 1889, and made provision for technical instruction. The towns that possess these old-established educational agencies are necessarily far ahead of those that have only recently had the importance of technical instruction thrust upon them. It will have been gathered from the foregoing description that the greatest need felt by newly-constituted authorities is for technical and secondary schools. Not until this want has been supplied, either by subsidising existing schools or building new ones, can many of the County Councils hope to see the fruits of their labours. The policy of withdrawing grants for elementary instruction in science, recently taken by various examining authorities, has been the means of raising the standard of efficiency in counties where science classes have been held for many years. In some counties, however, the committees have not realised that it is their duty to provide elementary scientific instruction; for they are using their funds almost entirely in supplying instruction in industrial "dodges." On the other hand, it is becoming recognised that science students must possess a more extended knowledge of mathematics than they usually have before any great advance can be made. No unbiassed observer can deny that the progress reported up to now has generally been in the right direction. Mistakes have, of course, been made, but the committees are usually not slow in seeing their failings, and rectifying them. In a few years, when the distrust and suspicion which hampers the work in some counties has been broken down, we shall have the nucleus of a system of education such as exists in Germany, France, and Switzerland, and shall begin to reap the benefits that accrue from it. R. A. GREGORY.

#### SCIENTIFIC SERIALS.

*Bulletin of the New York Mathematical Society*, vol. iii. No. 2 (November, 1893, New York).—"Lachlan's Modern Pure Geometry" (pp. 33-36) contains a review, by Prof. F. Morley, of Dr. Lachlan's treatise. It mainly points out what the writer considers to be defects in the author's programme, but closes with the hope, since Dr. Lachlan shows so much power in handling his subject, that he will "throw examination



schedules to the four winds of heaven," and is largely "with some part of the present outlook as stated in Klein's 'Vergleichende Betrachtungen.'" Prof. Cleveland Abbe gives (pp. 36-38) an analysis of papers on vortices in a compressible and rotating fluid, by Mr. Charles Chree, and trusts that the strictly meteorological work of his new position (at Kew) will tempt him to apply modern mathematical analysis to the winds, the clouds, and the storms of the actual atmosphere. Dr. T. Craig's high estimate of the *Traité d'Analyse*, by M. Émile Picard, will be seen from the space (pp. 39-66) he devotes to an account of this first volume. The extraordinary developments in the theory of functions, in differential equations, and in certain purely algebraical theories, and the important applications of the results of these developments to geometrical, physical, and astronomical problems, have made such a treatise almost indispensable. Notes and new publications occupy pages 65-72.

THE last volume of the *Memoirs of the St. Petersburg Society of Naturalists* (vol. xxiii.), for the Section of Botany, contains, besides the proceedings of the Society, a number of valuable papers. N. V. Diakonoff gives, under the title "Typical Representatives of the Life-substratum," a summary of his researches into the behaviour of lower fungi in an atmosphere devoid of oxygen. The *Penicillium glaucum* is a typical representative of organisms in which no life is possible without the action of oxygen; while *Mucor stolonifer* may be taken as a representative of organisms in which life is impossible without either the action of oxygen or the presence of a substance capable of fermenting. Prof. N. Tsinger gives a description of the mosses of Tula, of which 134 species are enumerated. M. L. P. Bowdin gives the results of his very interesting experiments upon the breaking out of buds upon cuttings of plants. S. G. Navashin describes and figures a new parasite of the cupulæ of some mosses, *Tilletia (?) sphagni*. N. Aiboff gives the results of his five years' exploration of the flora of Abkhazia (on the north-east coast of the Black Sea); his collection numbers no less than 1300 species, and does not confirm the conclusion as to the flora of Caucasus, arrived at by MM. Krasnoff and Kuzeretsoff. S. Navashin gives a very elaborate paper on the Discomycete, *Sclerotinia betulæ*, with several coloured plates. The vegetation of the Zerafshun valley is shortly described by V. Komaroff; and N. Ponyatsky criticises Hugo de Vries' method for the analysis of isotonic coefficients.

*Bulletin de la Société des Naturalistes de Moscou*, 1893 November I.—On some ecto- and ento-parasites of the Cyclopides, by Dr. W. Schewiakoff. One new species, *Trichophrya cordiformis*, is described, as also the ento-parasitic slimes of the Cyclopides.—Note, by W. Zykoff, on the chorda of *Siredon pisciformis*.—Note on a new skull of *Amynodon*, by Marie Pavlow.—A catalogue of the Coleoptera of Kazan, by L. Krulikovsky: the Noctuæ.—On the evolution of the ocean, by H. Trautschold, being an attempt at tracing the gradual development and modification of salinity in the ocean throughout the earth's history.

SOCIETIES AND ACADEMIES.

LONDON.

Royal Society, November 23.—"A certain Class of Generating Functions in the Theory of Numbers," by Major P. A. MacMahon, R.A., F.R.S.

The present investigation arose from my "Memoir on the Compositions of Numbers," recently read before the Royal Society and now in course of publication in the Philosophical Transactions. The main theorem may be stated as follows:—

If  $X_1, X_2, \dots, X_n$  be linear functions of quantities  $x_1, x_2, \dots, x_n$  given by the matricular relation

$$(X_1, X_2, \dots, X_n) = (a_{11} \ a_{12} \ \dots \ a_{1n}) (x_1, x_2, \dots, x_n),$$

$$\begin{vmatrix} a_{11} & a_{22} & \dots & a_{2n} \\ \vdots & \vdots & \ddots & \vdots \\ a_{n1} & a_{n2} & \dots & a_{nn} \end{vmatrix}$$

that portion of the algebraic fraction

$$\frac{1}{(1 - s_1 X_1) (1 - s_2 X_2) \dots (1 - s_n X_n)}$$

NO. 1260, VO. 49]

which is a function of the products,

$$s_1 X_1, s_2 X_2, \dots, s_n X_n,$$

$$\text{only, is } 1/V_n, \text{ where (putting } s_1 = s_2 = \dots = s_n = 1)$$

$$\begin{vmatrix} a_{11} - 1/x_1 & a_{12} & \dots & a_{1n} \\ a_{21} & a_{22} - 1/x_2 & \dots & a_{2n} \\ \vdots & \vdots & \ddots & \vdots \\ a_{n1} & a_{n2} & \dots & a_{nn} - 1 \end{vmatrix} = V_n = (-1)^{n-1} x_1 x_2 \dots x_n$$

The theorem is of considerable arithmetical importance, and is also of interest in the algebraical theories of determinants and matrices.

The theory is developed at length in the paper, with illustrative examples of arithmetical applications.

Incidentally interesting results are obtained in the fields of special and general determinant theory. The special determinant, which presents itself for examination, provisionally termed "inversely symmetric," is such that the constituents symmetrically placed in respect to the principal axis have, each pair, a product unity, whilst the constituents on the principal axis itself are all of them equal to unity. The determinant possesses many elegant properties which are of importance to the principal investigation of the paper. The theorems concerning the general determinant are connected entirely with the co-axial minors.

I find that the general determinant of even order, greater than two, is expressible in precisely two ways as an irrational function of its co-axial minors, whilst no determinant of uneven order is so expressible at all.

Of order superior to 3, it is not possible to assume arbitrary values for the determinant itself and all of its co-axial minors. In fact of order  $n$  the values assumed must satisfy

$$2^n - n^2 + n - 2$$

conditions, but these conditions being satisfied, the determinant can be constructed so as to involve  $n - 1$  undetermined quantities.

"On the Whirling and Vibration of Shafts." By Stanley Dunkerley, Berkeley Fellow of the Owens College, Manchester

December 7.—"Reptiles from the Elgin Sandstone: Description of Two New Genera." By E. T. Newton, F.R.S. Communicated by permission of the Director-General of the Geological Survey.

Two new reptiles from the Elgin Sandstone are described in detail. One of them is the property of Mr. James Grant, of Lossiemouth. The bones themselves being absent, their forms have been reproduced by gutta-percha casts taken from the cavities left in the stone. This reptile was evidently allied to *Stagonolepis*; it is represented by the skull, which is about three inches long, and the anterior half of the body, with the pectoral arch and both the fore limbs. The skull is depressed, has a pair of large prelachrymal fossæ; the two nasal openings are small, and placed near the end of the muzzle. The palate is narrow and deeply grooved, with primitive posterior nares placed far forwards. The vertebræ and limbs are Crocodilian in form. Above the vertebræ there is a double row of pitted, and closely-set scutes. This small Parasuchian is named *Erpetosuchus Granti*.

The second specimen was obtained by the Rev. Dr. Gordon, from the quarry at Spynie. In this fossil the bones were present, and the skull is still preserved, but many of the other bones were too much crumbled to show their form, and the casting process was again resorted to. The neck and fore limbs are wanting. The skull, which closely resembles that of *Ceratosaurs*, is about  $4\frac{1}{2}$  inches long, sharp anteriorly, and bird-like when seen from above, but deep when seen from the side, and it has a large prelachrymal fossa. The teeth are compressed and serrated anteriorly and posteriorly. The palate is deep, and a median pair of apertures, near the post-palatine vacuities, are believed to be primitive posterior nares placed far back. Many oval scutes are scattered above the neural spines.

This reptile seems to be intermediate between the Dinosaurs and Crocodilians; the skull and teeth are most like those of Dinosaurs; the pelvis and limbs might belong to either Dinosaurs or Crocodiles; while the free astragalus is certainly a Crocodilian character; provisionally it is referred to the Theropodous Dinosauria, and named *Ornithosuchus Woodwardi*.

"The Organogeny of *Asterina gibbosa*." By E. W. MacBride. Communicated by Adam Sedgwick, F.R.S.

"On Copper Electrolysis *in Vacuo*." By William Gannon.

"Note on the Action of Copper Sulphate and Sulphuric Acid on Metallic Copper." By Prof. Arthur Schuster, F.R.S.

Physical Society, December 8.—Prof. A. W. Rücker, F.R.S., President, in the chair.—A paper, by Mr. James Swinburne, on a potentiometer for alternating currents, was read by Mr. Blakesley. After referring to the many advantages of the "potentiometer" method of measurement, the author describes an arrangement by which alternating pressures can be measured. A quadrant electrometer with a double fishtail-shaped needle suspended by a torsionless fibre is employed. The electrostatic attraction exerted by an alternating pressure between the needle and one pair of quadrants is balanced by the force due to a steady pressure between the needle and the other pair of quadrants. The magnitude of the steady pressure is determined by a potentiometer and standard cell, and the effective value of the alternating pressure thus deduced. For measuring alternating currents a differential electro-dynamometer having two fixed coils and one moving coil, and no controlling spring, is used. A direct current, measured by the fall of potential over a small resistance, is passed through one of the fixed coils, the alternating current through the other fixed coil, and the moving coil is included in both alternating and direct current circuits. When the two forces balance, the currents are taken as equal. Several small inaccuracies to which the method is subject are mentioned in the paper. Prof. S. P. Thompson inquired if the fishtail-shaped needle of the electrometer was novel. Mr. Blakesley said the author had mentioned the needle previously. He (Mr. Blakesley) thought the name "potentiometer" was not very suitable. In effect, the so-called measurement of pressures was a comparison of two powers.—The President announced that Mr. Preece's note on the specific resistance of sea-water had been temporarily withdrawn.—Prof. G. M. Minchin made a communication on the calculation of the coefficient of self-induction of a circular current of given aperture and cross-section. Instead of assuming the cross-section of the wire small, and the current density constant over the section, as is usually done, the author takes into account the dimensions of the section and the non-uniform distribution of the current. Making use of the expressions for the vector potential ( $G$ ) of the current given in his previous papers (*Phil. Mag.*, April and August, 1893), the author calculates the total normal flux of force through a surface intersected once in the positive direction by every tube of force emanating from the given current. This flux, divided by the current, gives the coefficient of self-induction. The surface chosen is the circular aperture of the current and half of the anchor ring formed by the wire. When the current density is inversely proportional to the distance from the axis of the circular current, the value of the coefficient of self-induction is found to be

$$\pi \left\{ 4a(L-2) + 2c \left( L - \frac{5}{4} \right) - \frac{c^2}{10a} (2L+19) \right\},$$

where  $a$  is the radius of the central filament of the current,  $c$  the radius of the cross-section of the wire, and  $Lc = \log \frac{8a}{c}$ .

Clerk-Maxwell's approximate expression agrees with this in the principal term. As an example of the closeness of the approximation, the case of a current in a wire 2 millimetres diameter bent to a circle of 2 centimetres mean diameter had been taken, the approximate and corrected coefficients being 58.866 and 59.207 absolute units respectively. When the current in the wire is superficial, as in case of alternating currents of high frequency, the coefficient is somewhat greater, being given by the expression

$$\pi \left\{ 4a(L-2) + 2c \left( L + \frac{3}{2} \right) + \frac{c^2}{10a} (4L+11) \right\}.$$

Incidentally it was pointed out that the function  $Gx$  where  $G$  is the vector potential at a point distance  $x$  from the axis of a circular current was the same as Stoke's current function in hydrodynamics. Another paper, on the magnetic field of a current running in a cylindrical coil, was read by Prof. Minchin. The cylindrical coil is regarded as a series of equal circles lying close together and forming a cylindrical surface. Replacing each circular current by its equivalent magnetic shell, the problem of finding the magnetic potential at a point resolves

itself into calculating the gravitational potential due to two circular plates of attracting matter, one positive and the other negative, situated respectively at opposite ends of the cylinder. The magnetic potential due to one plate is then deduced in terms of elliptic integrals of the first, second, and third kinds. The President had pointed out that the expressions given in the printed proof of the paper, only applied when the perpendicular from the point to the plate fell within the circle; the author had therefore modified the formula so as to be true generally. From this formula the equipotential curves can be constructed. The same system of curves serve for the plate at the other end of the cylinder by changing the signs of the numerals representing the potentials and giving the curves a motion of translation equal to the length of the cylinder in the direction of its axis. The equipotential curves for the coil can then be deduced by drawing through the points of intersection of the two sets of curves whose numerical values have a constant sum. In determining the curves the author had to calculate tables of elliptic integrals of the third kind, and these he hoped to complete before the paper was published. In reply to a question on the first paper, which had been brought before him by Prof. Perry, the author said that as the diameter of the wire diminished indefinitely, both the self-induction and resistance became infinite, but the ratio  $L/R$  became zero. It was interesting to examine what relation between the aperture and cross-section gave minimum impedance. If the ordinary expression for it be taken the problem was impossible, but the corrected form admitted of a solution. Prof. Perry hoped the work Prof. Minchin had done so well for circles and cylinders would be extended to cylindrical coils of rectangular cross-section. It was most important to be able to find the shape of the field produced by such coils. Prof. S. P. Thompson inquired if there was any way of deducing the expression for the magnetic force at a point other than that given in the paper on the magnetic field of a circular current (*Phil. Mag.*, April, 1893). In reply Prof. Minchin explained how the formula followed at once from the fundamental theorem that magnetic force is the curl of the vector potential. This was based on Laplace's expression for the force between a magnetic pole and an element of current which had been proved experimentally.

Zoological Society, December 5.—W. T. Blanford, F.R.S., Vice-President, in the chair.—The secretary read a report on the additions that had been made to the Society's menagerie during the month of November. Among these special attention was called to a Cunning Bassaris (*Bassaris astuta*), obtained by purchase, to two Jerboas presented by Capt. R. A. Ogilby, and to a fine adult female of the Caucasian Wild Goat (*Capra caucasica*), presented by H. H. P. Deasy.—Prof. G. B. Howes exhibited and made remarks on some specimens of abnormal Marsipobranch Fishes. These were two heads of the Lamprey with the first pair of gills only imperfectly developed, and a Hag (*Myxine glutinosa*) with a supernumerary gill on one side.—Mr. F. E. Beddard, F.R.S., gave an account of the general geographical distribution of Earthworms, as treated of in a work on the subject which he had in preparation. Mr. Beddard recognised sixty-nine genera of this order, divided into six families; and after some preliminary remarks on the artificial introduction of earthworms into districts colonised from Europe, called attention to a series of tables in which the genera found in the six generally recognised regions of the earth's surface were shown. In addition to these six regions Mr. Beddard was disposed to recognise, in the case of earthworms, the existence of an Antarctic region, to embrace New Zealand and most of the Antarctic Islands.—A communication was read from Mr. C. J. Gahan, containing an account of a collection of Coleoptera sent by Mr. H. H. Johnston, C.B., from British Central Africa. Amongst these were examples of eight species new to science.—A communication was read from Capt. F. W. Hutton, F.R.S., containing a report on a collection of Petrels from the Kermadec Islands. Amongst them was an example of a new species proposed to be called *Estrelata leucophrys*.—Mr. G. A. Boulenger gave an account of *Vipera renardi*, a newly recognised European Viper from Southern Russia and Turkestan.

Entomological Society, December 6.—Henry John Elwes, President, in the chair.—Mr. W. F. Kirby exhibited, for Dr. Livett, specimens of a moth taken at Wells, which Dr. Livett considered to be varieties of *Dasyampa rubiginea*, but which many entomologists present thought were varieties of *Cerastis vaccinii*. Mr. Kirby stated that specimens similar in appearance

to those exhibited had been taken rather freely during the past autumn in Berkshire, and it was suggested that they might be hybrids between *D. rubiginosa* and *C. vaccinii*.—Mr. Lovell-Keays exhibited a series of *Lycæna alexis*, with confluent spots on the under sides of the front wings. He drew attention to the fact that the insects were all taken within a short radius, and probably were in the ratio of about one in forty with reference to the ordinary form. All the examples, with one exception, were females. Mr. Lovell-Keays remarked that he had some years ago met with a similar brood near Weymouth, in which the confluent spots were entirely confined to females. Prof. S. H. Scudder, of Cambridge, Mass., U.S.A., stated that he had observed the occurrence of broods of allied species with suffused spots in America.—Mr. C. O. Waterhouse exhibited the type specimen of *Coptomia opalina* of Gory, from the Hope Collection at Oxford, and pointed out that it was quite distinct from *C. mutabilis*, W. Mr. Waterhouse also called attention to *Silpha atomaria* of Linnæus (Syst. Nat., ed. xii., i., p. 574), a Swedish species which appeared to have escaped notice, and was not included in any catalogue. The type is still extant in the Linnean cabinet, and he said he was of opinion that it was *Olibrus geminus* of our collections, but he had not had an opportunity of making a critical examination. He also exhibited male and female specimens of a *Helopeltis* (the Tea-Bug), which he considered a distinct species, occurring only in Assam.—Mr. M. Jacoby exhibited certain species and varieties of the genus *Ceroglossus* from Chili, and Dr. D. Sharp, Mr. J. J. Walker, and Mr. Champion made remarks on their geographical distribution.—Prof. Scudder exhibited the type specimen of a fossil butterfly, *Prodryas persophone*, found in beds of Tertiary Age at Florissant, Colorado. He said the species belonged to the *Nymphalidae*, and the specimen was remarkable as being in more perfect condition than any of those from the European Tertiaries. He also stated that he had found a bed near the White River on the borders of Utah, in which insects were even more abundant than in the Florissant beds. Dr. Sharp, Mr. Kirby, Mr. H. Goss, and the President took part in the discussion which ensued.—Mr. Goss exhibited hibernating larvæ of *Spilothyrus alcea*, which had been sent to him by Mr. F. Bromilow from St. Maurice, Nice. Mr. W. F. H. Blandford read a paper entitled "The Rhynchophorous Coleoptera of Japan." The President, Dr. Sharp, Mr. Champion, Mr. McLachlan, and Mr. J. J. Walker took part in the discussion which ensued concerning the distribution of the group and the admixture of Palearctic and Oriental forms.—Mr. G. T. Bethune-Baker read a paper entitled "Notes on some Lepidoptera received from the neighbourhood of Alexandria," and exhibited the specimens described. Mr. McLachlan suggested that the scarcity of insects in Egypt was possibly to be accounted for by the fact that much of the country was under water for a considerable portion of the year; and Dr. Sharp said that another cause of the scarcity was the cultivation of every available piece of land for centuries past.—Mr. C. O. Waterhouse read a paper entitled "Further Observations on the Tea-Bugs (*Helopeltis*) of India."—Dr. F. A. Dixey communicated a paper entitled "On the Phylogeny of the *Pierine*, as illustrated by their wing-markings and geographical distribution."

Geological Society, December 6.—W. H. Hudleston, F.R.S., President, in the chair. The following communications were read:—The Purbeck beds of the Vale of Wardour, by the Rev. W. R. Andrews and Mr. A. J. Jukes-Browne. The authors have obtained better evidence than previously existed for calculating the thicknesses of the several parts of the Purbeck series in the Vale of Wardour, and compared the different subdivisions as developed in that vale with those exposed in other localities. The average thickness of the Lower Purbeck strata was given as 70 feet, of the Middle Purbeck beds about 32 feet, and of Upper Purbeck strata at least 66 feet. A comparison was instituted between the Purbeck beds of the Vale of Wardour and those of the Dorset coast, &c., and some remarks were made upon the physical conditions under which the beds were deposited. A discussion followed, in which the President, Prof. J. F. Blake, Prof. T. Rupert Jones, and Mr. H. B. Woodward took part. The Rev. W. R. Andrews briefly replied.—On a picrite and other associated rocks at Barnton, near Edinburgh, by Mr. Horace W. Monckton. The object of this paper was to describe a cutting on a new railway in Barnton Park, where there is an excellent exposure of picrite. It con-

sists of serpentinised olivine, augite, mica, iron oxide, and a little plagioclase-felspar, with a variable amount of interstitial matter. In many respects it comes very near to the picrite of Inchcolm, which island is 4½ miles north of Barnton cutting. It differs from the picrite of Bathgate, and the probability is that the Barnton rock is an offshoot from the same magma as that which supplied the Inchcolm rock. Besides the picrite other igneous rocks from the same cutting were described—in particular, a rock with porphyritic crystals of a green mineral replacing olivine, or more probably augite, and a great quantity of brown mica in small flakes and crystals. It was suggested that the name of mica-porphyrite might be given to this rock. Sir James Maitland made some remarks upon the paper.—On a variety of *Ammonites* (*Stephanoceras*) *subarmatus*, young, from the Upper Lias of Whitby, by the same author. The author described an ammonite found by himself in 1874 near Sandsend, three miles north-west of Whitby. He thought it was not actually *in situ*, but lying with a number of nodules on the floor of an old alum-pit, although he had no doubt that it was from the alum shale of the Upper Lias. A peculiar arrangement of the costæ as they cross the siphonal area distinguishes the specimen from other Whitby ammonites known to the author. It bears a strong resemblance to a shell figured as *A. subarmatus* by D'Orbigny ("Terr. Jurass." pl. lxxvii.), but is unlike the figures of that species given by other authors.

Linnean Society, December 7.—Prof. Stewart, President, in the chair.—Mr. C. T. Drury exhibited and made remarks upon a new example of aspospory in *Scolopendrium vulgare*, and Prof. Bower brought forward a similar case in *Trichomanes Kaulfussii*. Mr. George Brebner exhibited some new and rare British Algae, including *Haplospora globosa*, *Tilopteris Mertensii*, *Ectocarpus tornentosoides*, and *Polysiphonia spinulosa* var. *major*. Mr. F. Enoch, with the aid of the oxyhydrogen lantern, exhibited the various stages of development of the black currant mite, *Phytoptus ribis*, and gave an interesting account of its life history.—Mr. Thomas Christy exhibited a gigantic reed-like leaf from the Zambesi, with drawings of sections. It appeared to be allied to *Sansevieria cylindrica*, but differed conspicuously in the greater size of the leaves, which measured about 9 feet in length, instead of from 18 inches to 3 feet. The remarkably tough and strong fibre which it produces is considered to be of great commercial value, being equal to the best *Sansevieria* hemp.—Mr. W. F. Kirby read a paper on the dragon-flies of Ceylon, with descriptions of some new species. The paper was based chiefly upon a collection made by Colonel Yerbury, which he had presented to the British Museum. Seventy-five species were enumerated, of which fifty-five had been collected by Colonel Yerbury. Another collection, made in Ceylon by Mr. E. Green, had been dealt with in a previous paper (*Proc. Zool. Soc.* 1891, pp. 203-206).—On behalf of Signor Martelli, the secretary read a paper on the cause of the fall of the corolla in *Verbascum*, which gave rise to an interesting discussion. The meeting adjourned to December 21.

## PARIS.

Academy of Sciences, December 11.—M. de Lacaze-Duthiers in the chair.—On the sublimation of the red and yellow iodides of mercury, by M. Berthelot.—Research on the structure of feathers, by M. C. Sappey.—The densities of saturated vapours, and their relation to the laws of condensation and vaporisation of the solvents, by M. F. M. Raoult.—On the burning of moor and forest lands in Gironde, and the exceptional drought during the spring and summer of this year, by M. G. Rayet and G. Clavel. The long drought of the spring and summer of this year has favoured the production and extension of fires in the pine woods of the department of Gironde. In the 184 days between March 1 and September 1, 132 fires happened in the woods of Gironde, destroying 35,589 hectares of forest land, and doing damage to the extent of six million francs. Similar disasters occurred in 1870, and they have led the authors to look up the rainfall observations for the last 122 years for purposes of comparison. Among other points brought out by the investigation is that only two springs, 1716 and 1768, were drier than that of 1893. The summer of this year, however, only ranked thirteenth in order of dryness.—Solar observations made during the second and third quarters of 1893, by Prof. Tacchini (see *Our Astronomical Column*).—On the surfaces of which the lines of curvature of a system are plane and equal, by R. T. Caronnet.—On the characters of convergence of series, by M. Hadamard.—Low wave-length

spectrum of fluorine, by M. G. Carvallo.—On the diurnal variation of pressure on the summit of Mont Blanc, by M. A. Angot.—On the transformation of iron, by M. G. Charpy. Osmond's investigations of the transformations of iron led him to conclude that this metal exists in two allotropic forms,  $\alpha$  and  $\beta$ , having very different mechanical properties, and, according to him, it is to the transformation of  $\alpha$  into  $\beta$  that we must attribute the greater part of the modification undergone by steel during the process of tempering. M. Charpy has investigated the matter, and he finds that permanent deformation by cooling produces in iron and steel of different qualities an allotropic modification of iron. This transformation can be shown by means of curves of extension-tests. In the case of annealed iron and steel the curve showing the stress and strain has a step in it which does not appear when other varieties are tested. The curves thus furnish a simple method of studying the transformation of iron, its influence on mechanical properties, and its *role* in tempering.—On the velocities of etherification of hydrofluoric acid, by M. M. Meslans.—Analysis of butters, by M. C. Viollette.—On the buccal armature and a new digestive gland of Cirripedes, by M. A. Gruvel.—On the localisation of the active principles in resedas, by M. L. Guignard.—On the olive of Maillargues, near Allanche (Cantal), by M. F. Gonnard.—Eruption of the Calbuco volcano, by M. A. E. Nogués (see Notes).—On *Bennettites Morieri*, a fossil fruit presenting a new type of gymnosperm inflorescence, by M. O. Lignier.—Employment of artificial cultures of pathogenic microbes in the destruction of troublesome rodents, by M. J. Dampz.

AMSTERDAM.

Royal Academy of Sciences, November 25.—Prof. van de Sande Bakhuyzen in the chair.—Prof. J. A. C. Oudemans read a paper on the accuracy of the divisions of the altazimuth made by Pistor and Martin, and that by Repsold, for the triangulation of Java. In Pistor and Martin's circles, divided into 5', the intervals were alternatively larger and smaller in one instance, the difference in an instrument constructed in 1856 being almost 6"; in the other instruments it was much smaller. In Repsold's circles, divided into 4', no difference was found. The discovery of this imperfection led to a severe examination of all the circles, and the result was that, taking into account this difference, and measuring the intervals of seven degrees of each circle from three to five times, it was found that Pistor and Martin's divisions had grown better and better, so that *within one degree*, the mean error of each line, in the instruments of 1865 and 1867, in linear measure, was only  $\frac{1}{2}\mu = \frac{25}{1000000}$  of an inch. Two altazimuths of Repsold gave  $\frac{3}{2}\mu = \frac{375}{1000000}$  of an inch. Account was taken of the errors in the measurement of the intervals by the micrometers of the microscopes. The periodic and irregular errors were, of course, larger.—Prof. Zaaijer read a paper on the sutura condylo squamosa of the occipital bone of man and mammalia. For the first time in 1878 attention was directed to this suture (only part of which remained, and that very rarely, with man) by Dr. W. Dominicus who had found this anomaly on some skulls in the collection of the Anatomical Museum at Leyden. However, this observation remained buried in the dissertation of Dr. Dominicus ("Ontleed kundige aanteekeningen betreffende het achterhoofsbeen." Leiden, 1878). Last winter Prof. Zaaijer quite accidentally lighted on a human skull (from a grave on the island Disko, Greenland) of which the above-mentioned suture was not obliterated. This induced him to examine the state of the sutura condylo-squamosa of mammalia. By the kindness of the Director of the Museum of Natural History at Leyden, about 1900 skulls of mammalia were examined. The chief result of the examination of the skulls of full-grown animals indicated that the suture was found in its entire state with Marsupialia in 8.6 per cent. of the examined skulls (35 in number), Rodentia 3.9 per cent. (153), Pachydermata 16.5 per cent. (85), Ruminantia 10.5 per cent. (210), Simiæ 1 per cent. (202). With the skulls of the adult animals from the other classes the suture was never found in its entire state, no more than with man. Before communicating these results Prof. Zaaijer gave a short description of the normal development of the occipital bone in man. A minute and close investigation of a great number of human skulls raises the question as to whether the entire obliteration of this suture may not be found more frequently with the so-called lower races.

BOOKS, PAMPHLETS, and SERIALS RECEIVED.

Books.—Dynamos, Alternators, and Transformers: G. Kapp (Biggs).—Electric Traction on Railways and Tramways: A. Reckenzaun (Biggs).—Portative Electricity: J. F. Niblett (Biggs).—The Design of Alternating-Current Transformers: R. W. Weekes (Biggs).—Electrical Distribution, its Theory and Practice, Part 1, M. H. Kilgour; Part 2, H. Swan and C. H. W. Biggs (Biggs).—Town Councilor's Handbook to Electric Lighting: N. S. Russell (Biggs).—First Principles of Electrical Engineering, new edition: C. H. W. Biggs (Biggs).—Descriptive Catalogue of the Anatomical and Pathological Specimens in the Museum of the Royal College of Surgeons of Edinburgh, Vol. 1, the Skeleton and Organs of Motion: C. W. Cathcart (Edinburgh, Thin).—Romance of the Insect World: L. N. Badenoch (Macmillan).—Elementary Lessons in Steam Machinery and the Marine Steam Engine, new edition: J. Langmaid and H. Gaisford (Macmillan).—A Text-book of the Physiological Chemistry of the Animal Body, Vol. 2, the Physiological Chemistry of Design: Dr. A. Gamgee (Macmillan).—Meteorology: H. N. Dickson (Methuen).—Le Cuir: P. Weiss (Paris, Baillière).—Key to Lock's Shilling Arithmetic: H. Carr (Macmillan).—About Orchids: F. Boyle (Chapman and Hall).—Annals of British Geology, 1892: J. F. Blake (Dulau).—The Flora of the Assyrian Monuments and its Outcomes: Dr. E. Bonavia (Constable).—The Cliff Dwellers of the Mesa Verde, South-Western Colorado: G. Nordenskiöld, translated by D. Lloyd Morgan (Stockholm, Norstedt).—Index Kewensis, Part 2: J. D. Hooker and B. D. Jackson (Oxford, Clarendon Press).—The Royal Natural History, edited by R. Lydekker, Vol. 1, Part 2 (Warne).—Random Recollections of Wo-land, Fen, and Hill: J. W. Tutt (Sonnenschein).—Imperial University of Japan, Calendar for the Year 1892-3 (Tokyo).—Les Emules de Darwin, 2 vols.: A. de Quatrefages (Paris, Alcan).

PAMPHLETS.—Report of a Conference on Secondary Education in England (Oxford, Clarendon Press).—Official Catalogue of Exhibits and Descriptive Catalogue World's Columbian Exposition, Department M, Anthropological Building (Chicago).—Memoranda of the Origin, Plan, and Results of the Field and other Experiments at Rothamsted.—Report of an Investigation on the Gases enclosed in Coal and Coal Dust: W. McConnell.

SERIALS.—Journal of the Chemical Society, December (Gurney and Jackson).—American Meteorological Journal, December (Ginn).—Bulletin from the Laboratories of Natural History of the State University of Iowa, Vol. 2, No. 4 (Iowa).—Mémoires de la Société de Physique et d'Histoire Naturelle de Genève, Tome xxxi, Seconde Partie (Genève).—American Journal of Science, December (New Haven).—Minerological Magazine, November (Simpkin).—Materials for a Flora of the Malayan Peninsula, No. 5, Dr. J. King (Calcutta).—Materials for a Flora of the Malayan Peninsula, Index and Title Page to the 'Tha'amitoræ' (Nos. 1 to 5 of the Series): Dr. G. King (Calcutta).—Johns Hopkins University, Studies in Historical and Political Science, Eleventh Series, xi-xii. (Baltimore).—Beiträge zur Biologie der Pflanzen, vi. Band, iii. Heft (Williams and Norgate).—Morphologisches Jahrbuch, 20. Band, 4. Heft (Williams and Norgate).

CONTENTS.

PAGE

|                                                                                                                                            |     |
|--------------------------------------------------------------------------------------------------------------------------------------------|-----|
| The Tombs at Beni Hasan . . . . .                                                                                                          | 169 |
| A Nature Lover's Correspondence . . . . .                                                                                                  | 170 |
| Our Book Shelf:—                                                                                                                           |     |
| Wallace Stewart: "A Text-book of Heat" . . . . .                                                                                           | 171 |
| Houssay: "The Industries of Animals" . . . . .                                                                                             | 171 |
| Letters to the Editor:—                                                                                                                    |     |
| Flame.—G. S. Newth; Prof. Henry E. Armstrong, F.R.S. . . . .                                                                               | 171 |
| The Postal Transmission of Natural History Specimens.—R. McLachlan, F.R.S. . . . .                                                         | 172 |
| "Geology in Nubibus"—Mr. Deeley and Dr. Wallace.—Sir H. H. Howorth, K.C.I.E., M.P., F.R.S. . . . .                                         | 173 |
| The Viscous Motion of Ice.—John Tennant . . . . .                                                                                          | 173 |
| Chemistry in Space.—Dr. John Cannell Cain . . . . .                                                                                        | 173 |
| The Manœuvring Powers of Steamships and their Practical Applications. ( <i>With Diagrams.</i> ) By Vice-Admiral P. H. Colomb, R.N. . . . . | 174 |
| The Tunicate. By R. M. . . . .                                                                                                             | 179 |
| Notes . . . . .                                                                                                                            | 179 |
| Our Astronomical Column:—                                                                                                                  |     |
| Colour-Aberration of Refracting Telescopes . . . . .                                                                                       | 183 |
| Stars with Remarkable Spectra . . . . .                                                                                                    | 183 |
| "Himmel und Erde" for December . . . . .                                                                                                   | 184 |
| A New Variable . . . . .                                                                                                                   | 184 |
| Geographical Notes . . . . .                                                                                                               | 184 |
| A New Process for the Preparation of Ethers. By A. E. Tutton . . . . .                                                                     | 184 |
| The Progress of Technical Education. By R. A. Gregory . . . . .                                                                            | 185 |
| Scientific Serials . . . . .                                                                                                               | 188 |
| Societies and Academies . . . . .                                                                                                          | 189 |
| Books, Pamphlets, and Serials Received . . . . .                                                                                           | 192 |

THURSDAY, DECEMBER 28, 1893.

QUATERNIONS AS AN INSTRUMENT IN  
PHYSICAL RESEARCH.*Utility of Quaternions in Physics.* By A. McAulay,  
M.A. (London: Macmillan and Co., 1893.)

JUST as "one shove of the bayonet" was truly said to be more effective than any number of learned discussions on the art of war:—this really practical work, giving genuine quaternion solutions of new problems as well as largely extended developments of old ones, is of incomparably greater interest and usefulness than the recently renewed, but necessarily futile, attempts to *prove* that a unit vector cannot possibly be a quadrantal versor:—nay, that a Calculus of Vectors must limit itself to the beggarly elements of addition and subtraction, commonly called "composition."

It is much to be regretted that Mr. McAulay has not determined simply to let his Essay speak for itself. His Preface, though extremely interesting as the perverid outburst of an enthusiast, assumes here and there a character of undignified querulousness or of dark insinuation, which is not calculated to win sympathy. It has too much of the "Rends-toi, coquin" to make willing converts; and in some passages it runs a-muck at Institutions, Customs and Dignities. Nothing seems safe. It is a study in monochrome:—the lights dazzlingly vivid, and the shades dark as Erebus! We gladly pass from it to the main contents of the book.

There can be no doubt whatever of its value from the scientific point of view. It is the work of a man of genuine power and originality. Many parts of it are, no doubt, laboured and somewhat heavy, others very crude; and in some places the obscurity is almost repulsive. [Curiously, these obscurities occur chiefly where more than usual pains have been taken to make things plain!] But faults like these are well-nigh inevitable in a first effort; and they should, perhaps, be regarded as enhancing by contrast the merits of the novel processes and results to which they act as a foil.

It is positively exhilarating to dip into the pages of a book like this after toiling through the arid wastes presented to us as wholesome pasture in the writings of Prof. Willard Gibbs, Dr. Oliver Heaviside, and others of a similar complexion. Here, at last, we exclaim, is a man who has caught the full spirit of the Quaternion system:—"the real *astus*, the *awen* of the Welsh bards, the *divinus afflatus* that transports the poet beyond the limits of sublunary things"! No doubt, to a man like this, the restrictions imposed, in view of the prospective ordeal of the Senate-House, by the passionless worldly-wisdom of a "Coach," must have been gall and bitterness. Intuitively recognising its power, he snatches up the magnificent weapon which Hamilton tenders to all, and at once dashes off to the jungle on the quest of big game. Others, more cautious or perhaps more captious, meanwhile sit pondering gravely on the fancied imperfections of the arm; and endeavour to convince a bewildered public (if they cannot convince themselves) that, like the Highlander's musket, it requires to be treated to a brand-new stock, lock, and barrel, *of their*

*own devising*, before it can be safely regarded as fit for service. "Non *his* juvenas orta parentibus. . ." What could be looked for from the pupils of a School like that?

Mr. McAulay himself has introduced one or two rather startling innovations. But, unlike the would-be patchers or underpinners to whom we have referred, he retains intact all the exquisitely-designed Hamiltonian machinery, while sedulously oiling it, and here and there substituting a rolling for a sliding contact, or introducing a *lignum vitæ* bearing. To borrow an analogy from current electricity, he endeavours to add facilities, while his concurrents are busy adding resistances, sometimes indeed breaking the circuit altogether!

Among the additions to which Mr. McAulay calls attention, some are certainly not novel, they were perfectly well known to Hamilton himself. Thus the use of suffixes, to show which factor of a product (say) is to be acted on by an operator, is at least as old as Herschel's *Appendix* to the translation of Lacroix:—and is an essential part of the notation required for what is correctly called "Hamilton's Theorem." Mr. McAulay refers to this as a process of his own, which was found "necessary somewhat to expand the meaning" of a symbol. Another instance is the use of a vector, *which may have an infinite number of values*, for the purpose of condensing three independent scalar equations into one common expression, &c. This is purely and entirely Hamiltonian.

The "startling innovations," however, as we called them above, are unquestionably Mr. McAulay's own—and he has certainly gone far to justify their introduction. He has employed the sure tests of ready applicability and extreme utility, and these have been well borne. Objections based upon mere unwontedness or even awkwardness of appearance must of course yield when such important advantages as these (if they be otherwise unattainable) are secured; but it certainly requires a considerable mental wrench to accustom ourselves to the use of

$$X_1 \frac{d}{dx_1}$$

as an equivalent for the familiar expression

$$\frac{dX}{dx}.$$

If this be conceded, however, it is virtually *all* that Mr. McAulay demands of us, and we are free to adopt his system. It is to be carefully observed that there is no interference with the *principles* of quaternions to which, as was remarked above, Mr. McAulay strictly adheres. The quantities and operators, to which the dislocation applies, *are all scalars*, and the wrench referred to is therefore an algebraic, not a specially quaternion, one. Its introduction is made necessary by the determination to adhere to the non-commutative property of quaternion multiplication, while endeavouring to effect certain desirable transformations. Mr. McAulay likens this dislocation of the usual arrangement of operator and subject to the occasional disarrangement of relative position of adjective and substantive in a Latin sentence:—the nexus between them being the common case-ending, which is the analogue of the common suffix. A single example,

of a very simple character, must suffice. Thus in the strain of a homogeneous isotropic solid, due to external potential  $u$ , we have for the strain-function  $\phi$  (when there are no molecular couples) the equation

$$S.\nabla\phi a + S.a\nabla u = 0,$$

which (in virtue of the property of  $a$ , already spoken of) is equivalent to three independent scalar conditions. Suppose we wish to express these, without the  $a$ , in the form of one vector condition. Mr. McAulay boldly writes the first term as

$$S.a\phi_1'\nabla_1; \text{ or rather as } S.a\phi\nabla,$$

for in so simple a case the suffixes are not required, and the strain-function is self-conjugate under the restriction above. Then, at once, the property of  $a$  shows us that

$$\phi\nabla + \nabla u = 0,$$

which is the vector equation required. Here it is obvious that, in the usual order of writing,

$$\phi\nabla = \frac{d}{dx}\phi i + \frac{d}{dy}\phi j + \frac{d}{dz}\phi k.$$

This simple example shows the nature of the gain which Mr. McAulay's method secures. Those who wish to know its extent must read the work itself. They will soon be introduced to novel forms of concentrated operators with regard to which, as I have not yet formed a very definite opinion, I shall content myself by hazarding the remark that, while they are certainly powerful and eminently useful, they must at present be regarded as singularly uncouth.

As a purely personal matter I would add that I do not think Mr. McAulay states quite accurately the nature of some of the remarks which I made on his Essay when I read it (at the request of Dr. Ferrers) in MS. The passage of the last edition of my book, to which he refers as being aimed at him, was meant as a defence or explanation of my own procedure. So far as I can recollect, I urged Mr. McAulay to avoid (when possible) dealing with quaternion elements; and to frame relations between surface and volume integrals, &c., from kinematical or other interpretations of their wholes.

P. G. TAIT.

#### THE MANUFACTURE OF PAINTER'S COLOURS AND VARNISHES.

*Painter's Colours, Oils, and Varnishes: a Practical Manual.* By George H. Hurst, F.C.S. (London: C. Griffin and Co., 1892.)

THIS work is intended for those who are more immediately interested in the manufacture of painter's colours and varnishes; and the author, as he says in his preface, has in the treatment of his subject endeavoured to combine theory and practice by giving a short account of the theory of the processes which he describes. Considering the range of the work and the great number of subjects dealt with, the information thus afforded is necessarily here and there somewhat scanty, and hardly sufficient to work upon. At the same time it appears to us that the bulk of the book might with advantage have been reduced by leaving out most of the elementary chemistry, with which nowadays we must suppose anyone would be thoroughly familiar, who intended to embark on colour-making. A colour-maker ought, above all

things, to be a thorough chemist if he wishes to succeed; and those who merely rely on the working of their stock of receipts, secret processes, and rule-of-thumb directions, will have but little chance of success in the future. The author, in his desire to make his work as complete as possible, has also given undue space to the description of numerous colours and processes which are now obsolete, and to others which attracted only a transient interest when issued from the Patent Office.

The uninitiated reader will therefore find it somewhat difficult to separate the chaff from the grain, as it is not always clear whether, in the description of the processes and the properties of the colours obtained by them, the author gives his own experience, or merely a transcript of the patent specification or the trade circular. This criticism applies more especially to the chapter on white pigments. Here it is also to be regretted that the author has not give more prominence to the description of the qualities of the typical whiteleads obtained by the different processes, and has not brought them into comparison with other similar lead compounds, and with the various zinc pigments which have been introduced as substitutes for the poisonous whitelead. The results of such comparative trials carried out systematically, and according to the methods mentioned in the book, would have been of great value, as they would also assign the proper value to those compounds which are so persistently recommended as being equal, or even superior, to genuine old-fashioned whitelead.

With regard to zincwhite, it appears to us that the real reason of its not being more generally employed is not its supposed want of covering power, for well-prepared Belgian zincwhite ground in oil is hardly inferior in this respect to whitelead, but that it does not work so smoothly and freely under the brush, however finely it may be ground. On this account the workman will always prefer to use whitelead, and he will only use zincwhite when he is compelled to do so. We notice that the author, in describing the preparation of zincwhite, says "the vapour of zinc burns, and vapour of zincoxide is emitted in large volumes"; and further on he speaks of the use of "zinc ores, such as calamine and zincblende, and any product of zinc which, being heated in a retort, can be reduced to the metal." Both these statements are absurdly incorrect. Here also we notice that the author, in referring to certain furnace operations, makes frequent use of the term "calcining," but quite indiscriminately, whether the operation is carried out on an open hearth, or in a muffle with the exclusion of air, or in a covered crucible. It is desirable that writers on technical matters should preserve the strict meaning of such terms as this, which have a distinct and specific signification.

The chapter on Barytes the author introduces with the following words:—"Barytes is one of the most important white pigments at the disposal of the painter, probably in this respect ranking next to whitelead." We have no hesitation in saying that this will surprise those who have any acquaintance with the behaviour of barytes when ground in oil or in varnish. It is true that this substance, as shown in the numerous analyses given in this book, enters largely into the composition of a good many commercial colours; but we venture to say

that, with a few exceptions, where the precipitated barium sulphate is used as a basis or bearer of certain colouring matters, the admixture of ground native barytes has no other object than that of adulteration. As an oil paint it is absolutely worthless. But while we have not a good word to say for ground native barytes, especially when it enters into the composition of oil colours, it is quite otherwise with the precipitated or artificial barium sulphate, which, in our opinion, receives here too scanty a treatment, judging by the little the author says about its preparation. It seems almost as if he had quite overlooked its vast importance. He omits to mention that this pigment is principally made from native barium carbonate, or Witherite, by what apparently is a very simple process; a process, however, which only in the hands of very few makers furnishes it in that perfect condition in which it finds so large an application in preparing the surface of paper for chromo-lithography. It is not, indeed, too much to say that this art largely owes its modern development to the introduction and use of this form of barium sulphate. Passing on to gypsum, we think, from the description given, the reader will receive quite an exaggerated idea of the qualities and importance of this substance in its application as a pigment. The author says "its body is not as good as that of white-lead, but it is at least equal to barytes in this respect, and is superior to zincwhite." He also states that it mixes well with either water or oil, and it can be mixed with all other pigments without affecting them. Here we might ask, are these the results of the author's own trials? In speaking of its being used very largely by paper-stainers and makers of paper-hangings, he says it is preferred to barytes on account of its having more body when used for that class of work; "bulk," perhaps, would be a more correct term in this case. We almost suspect that the author, whilst speaking of the use of gypsum as a pigment, really means "satin-white," a substance of some importance to the paperstainer and maker of paper-hangings, which is obtained by precipitating aluminium sulphate with caustic lime, and which is a mixture of calcium sulphate and alumina hydrate. This substance, however, we do not find mentioned in the book before us.

It deserves to be noticed that, according to the author, gypsum as well as barytes and China clay are used in the finishing of cotton goods. We were under the impression that this nefarious and stupid practice had been given up before now. Strontium sulphate, under the name of strontian white, finds also a place amongst the white pigments, and considering the price of strontium minerals, we are not a little surprised to see it stated that strontium sulphate is often sent out as a substitute for barytes. Concluding with the white pigments, we find a very full and interesting account of China clay, and the mode of obtaining it from the natural deposits.

Regarding the article on Vermilion, it appears to us that the author is under an entire misapprehension as to the merits of the dry and wet methods of its preparation. It is incorrect to say that the Chinese product is finer and more brilliant in tone than that made in Europe. The vermilion made at present in Europe by the sublimation process is quite equal to, if not better than, the Chinese; but, as regards colour and fineness, the wet-process ver-

million is far superior to either, and is superseding the former.

We should have thought it hardly worth while to mention that the chromates of mercury and silver had been proposed as red pigments, and still less the chromate of copper, which, according to the author, is a dark red (?) coloured body. Under chrome-green we notice that the author takes "Guignet's green" to be chromic oxide, whilst it really is a hydrate of chromium oxide, and the chemical formula he gives for its formation is, of course, quite wrong.

In the article on Ultramarine we notice misspellings of the names of authors, and R. Hoffmann, for instance, is throughout referred to as "Hofmann."

The foregoing remarks have already taken up so much space, that we cannot find room for our comments on the remaining chapters dealing with the colours, and we must conclude here, but not without calling attention to the latter part of the book, which treats of paint vehicles, oils, resins and varnishes, and gives a very full and interesting account of these materials. The description of the manufacture of oil varnishes is particularly valuable, as it gives an exact account of processes which are usually guarded with much secrecy.

#### BRITISH FUNGUS FLORA.

*British Fungus Flora; a Classified Text-book of Mycology.*

By George Masee. Vols II. and III. (London: Geo. Bell and Sons, 1893.)

IT was originally estimated that this work would be completed in three volumes, but, as we pointed out in our first notice, this was practically impossible. A notice now accompanies the third volume, to the effect that a supplementary volume will speedily be published in conclusion of the work. The second volume continues the Hymenomycetes, which occupy 268 pages also of the third volume, so that two and a half volumes are occupied by the Hymenomycetes, leaving 220 pages for the Hyphomycetes, which bring the third volume to a close. It is only necessary to enumerate the remaining orders to appreciate the difficulty of completing even with a fourth volume. There are all the Ascomycetes, which occupied in Cooke's "Handbook" an equal number of pages to the Hymenomycetes; and supposing the increase to have been in the same ratio, it may be conjectured that this order (including the Discomycetes) cannot be compressed into less than two volumes. For all that remains afterwards, there will not be so much necessity. There would be the *Sphaeropsidæ* and *Melanconicæ*, which are of minor interest, although numbering perhaps 700 species. The *Phycomycetæ*, which have recently been the subject of a volume, by the same author, as "British Fungi, Phycomycetes, and Ustilagineæ." Hence they may be dispensed with. The *Uredinæ*, which, with the *Ustilagineæ*, formed a volume by C. B. Plowright in 1889, have had so few accessions that a revision is not imperative. The *Myxomycetes*, which occupied a monograph by G. Masee in 1892, is all-sufficient. As to the *Saccharomycetes* and the *Schizomycetes*, the little volume by W. B. Grove, dated 1884, would furnish an introduction, and would be fairly

complete to that date, in genera and species. With these modifications, we see no reason why, with two supplementary volumes to contain all the *Ascomycetes*, the five volumes might not be accepted as a fair approximation to a "British Fungus Flora."

As far as the *Basidiomycetes* are concerned, and these will occupy half the bulk of the volumes, even if extended to five, it will be conceded that they are of the greatest interest to the largest number of persons, and, moreover, that they are treated with all the fulness that such an important section demands. We cannot help regretting, however, whenever we are called upon to use the book, that the sequence of families and genera were inverted. The ample descriptions, under each species, will nevertheless atone for much, and justify the appropriation of half the volumes to their service.

The 220 pages which are devoted to the *Hyphomycetes* (or moulds), will be especially welcome to students of microscopical fungi, not only because they are arranged according to the most recent system—that proposed by Saccardo—but also on account of the very useful figures illustrative of the several genera. In our opinion, these are the most successful of the illustrations yet included in the present work. It would have been a great achievement, had it been possible, so to have increased the number of these little outline figures, as to have included every one of the species included in the Flora. As to substantial accuracy, that must, to a large extent, be accepted on trust, since the practical use can be the only test of the merits of the text-book, and its demerits—if any.

We can now estimate the number of British species, and see how they are provided for in this Flora, or may hereafter be included, viz. :—

|                                   |        |      |                       |
|-----------------------------------|--------|------|-----------------------|
| Gastromycetes                     | .. ..  | 78   | ... Vol. I.           |
| Hymenomycetes                     | ... .. | 1950 | ... Vols. I. II. III. |
| Hyphomycetes                      | ... .. | 635  | ... Vol. III.         |
|                                   |        |      | 2663                  |
| Pyrenomycetes                     | ... .. | 900  |                       |
| Discomycetes                      | ... .. | 610  |                       |
| Hysteriacei                       | ... .. | 30   |                       |
| Tuberaceæ                         | ... .. | 30   |                       |
|                                   |        |      | 1570                  |
| Sphærospideæ, &c.                 | ... .. | 700  |                       |
| Uredineæ and Ustilagineæ          | ... .. | 257  |                       |
| Phycomycetes                      | ... .. | 100  |                       |
| Myxomycetes                       | ... .. | 100  |                       |
| Saccharomycetes and Schizomycetes | ... .. | 133  |                       |
|                                   |        |      | 1290                  |
| Total                             | ... .. | 5523 |                       |

The above estimates of the *Ascomycetes*, at 1570, are only approximate, and probably below, rather than above, the actual number. Hence therefore the total contents of the four or five volumes, as the case may be, would not be less than 4200 species, and the absolute total of all British recorded Fungi upwards of 5500 species, as compared with the 2809 of Cooke's "Hand-book" in 1871, or a duplication in twenty-two years. This fact is a sufficient justification for the publication of the present work.

We need not repeat our general commendation, as expressed in our first notice, except perhaps to intimate that in all respects the second and third volumes are up to the level of the first, and justify the confidence reposed

by the publishers, and ourselves, in the author to whom such an important work has been entrusted. It would be folly to pretend that it is absolutely perfect, but the errors of judgment, or execution, are not such as to detract from the general utility of the most pretentious and important work which Mr. Masee has yet attempted.

M. C. COOKE.

#### OUR BOOK SHELF.

*Some Salient Points in the Science of the Earth.* By Sir J. William Dawson, F.R.S. Pp. 499, with 46 illustrations. 8vo. (London: Hodder and Stoughton.)

THIS volume will have a melancholy interest, especially for the older geologists; for the author says that it "is intended as a closing deliverance on some of the more important questions of geology, on the part of a veteran worker, conversant in his younger days with those giants of the last generation, who, in the heroic age of geological science, piled up the mountains on which it is now the privilege of their successors to stand." We must bear in mind this implied limitation, that the heroic age of geology is now past, and must treat the volume before us as containing an account of researches and speculations made during the lifetime of a bygone generation. It is, in fact, a sort of scientific autobiography, touched up here and there to agree with recent research, but not claiming authority as an epitome of the present state of our knowledge.

Few chapters in the history of geology are so fascinating as Lyell's account of the discovery, by Principal Dawson and himself, of the wonderful series of remains from the coal field of Nova Scotia. It reads like the story of the exploration of a new country. We seem to walk among the strange vegetation of the coal; we see the larger reptiles crawling over and leaving trails in the soft mud; and on the dry land we help to pull to pieces one of the hollow trees, and find within it a number of land animals, all new to science. We can understand how these discoveries came as a complete surprise to the scientific world in days when few or no reptiles were known of earlier date than the Permian, and no land mollusca earlier than the Eocene. The reader will naturally turn first to the chapters relating to the researches in the coal measures, and it is probably on the observations there recorded that the author's fame will principally rest. Sir William Dawson's exploration of the coal measures of Nova Scotia led him to devote particular attention to the natural history of that period. He studied carefully the physical conditions under which the strata were laid down, devoting special attention to the formation of underclays and to the origin of coal seams; he still stands up for the dry-soil origin of coal, and for its growth on the spot. From the origin of coal it was a natural transition to the coal-measure plants, and these the author has worked at most industriously, though the present volume only contains a summary of his researches. There is also a chapter on the air-breathers of the coal, in which the author gives an account of his explorations at South Joggins.

We do not much care for the chapters on the genesis and migrations of plants, on the distribution of animals and plants as related to geographical and geological changes, and on Alpine and Arctic plants in connection with geological history. In all such subjects the author's strong bias against evolution in any form leads him to use strange arguments. We do not wish, however, to conclude this notice with a criticism of minor points, and though unprepared altogether to praise Sir William Dawson's volume, we thoroughly recognise how much he has done for the science of geology, and we gladly welcome in this handy form a short record of his life's work.



*Das Karstphänomen.* Versuch einer morphologischen monographie von Dr. Jovan Cvijić. (Wien: Ed. Hölzel.)

NOTWITHSTANDING its rather pompous second title, this is an interesting and valuable book, which, however, is not a separate work, but the third part of the fifth volume of a geographical series (*Abhandlungen*) edited by Prof. A. Penck. Its subject may be briefly stated as follows:—In many limestone districts the surface of the rock is guttered by channels—sometimes small, sometimes large—varying from comparatively smooth to rough. Here each ends in a small pipe, which descends vertically into the rock; there they converge towards one of larger size. With this system of superficial drainage are associated hollows of various forms, “blind valleys,” and the like, and caves are likely to be common. A region which exhibits some or all of these phenomena is called, from the peculiar sculpture of the surface, a *karst* region. Such may be found in various parts of the world. It is represented in England by the furrowed limestones and “swallow-holes” of Derbyshire and Yorkshire; it occurs in many parts of the Alps, the phenomena becoming more frequent eastward, till their headquarters are reached in the Julian Alps and the great “Karst plateau,” north of the Gulf of Fiume. As they occur in many lands, so they bear many names. A full, exhaustive, and elaborate account of these interesting phenomena will be found in this memoir, perhaps with an affected attempt at precision in distinction and classification (for after all, though curious, they are simple in origin), together with abundant references to the literature of the subject. Its usefulness, however, would be greatly increased by an index or by a very full table of contents; and though it is paged continuously with the volume, the latter, at least, ought to have been given.

T. G. B.

#### LETTERS TO THE EDITOR.

[The Editor does not hold himself responsible for opinions expressed by his correspondents. Neither can he undertake to return, or to correspond with the writers of, rejected manuscripts intended for this or any other part of NATURE. No notice is taken of anonymous communications.]

#### The Origin of Lake Basins.

THE most thorough-going glacialist could find no ground for complaint that Dr. Wallace has not gone far enough in his most interesting advocacy of the glacial origin of lakes. I do not propose to enter into any general discussion of this question; that glaciers can excavate rock basins is indisputable, but there is a limit to their power, and this limit I believe to be reached far short of even the larger of our English lakes. The controversy is of long standing, and there is little new to be said on either side; nor would I have desired to re-enter it, but that Dr. Wallace's article seems to me to contain one serious fallacy and one vital misstatement which have not as yet been noticed, though they should not be left uncorrected.

The fallacy is not a new one; it may be found in the writings of more than one of the advocates of the glacial theory, and is contained in the argument that because lakes are found in regions that have been extensively glaciated, and are not found in regions precisely similar in every respect, except that there has been no great extension of glaciers, therefore the rock basins in which the lakes lie were excavated by glaciers. I trust I have not misrepresented the argument in this succinct statement of it; but such condensation is useful if we would detect a fallacy, and in this condensed form the fallacy of the undistributed middle term becomes conspicuous. The term “lake” is by no means coextensive with the term “rock basin,” and it is not the water filling the lake which requires explanation so much as the basin that it fills. A rock basin filled with alluvium is a rock basin still, and requires explanation as much as if it contained water, and was consequently a lake.

The misrepresentation is to be found in Dr. Wallace's limitation of what he rightly regards as the only tenable alternative theory, that the rock basins owe their origin to deformation of the surface immediately before the advance of the ice. This

limitation of time is so extraordinary that it would have passed for an accident or oversight, but that it is repeated at greater length on the very next page; did it form any essential part of the theory, this would deserve all the strictures passed upon it, but such is by no means the case. Without entering into the question of whether the geologists quoted by Dr. Wallace accept this limitation of time, I may point out that it is altogether more reasonable to regard the deformation as having taken place *after* the advance of the glaciers. We know that during the glacial period there were great changes of level, and it is reasonable to suppose that these were not absolutely uniform; moreover, had the rock basins been formed before the ice was there to fill them, they would mostly have been filled at once by river deposits, as has been the case in nonglaciated regions, and once filled up they would remain so on this theory, for if a glacier cannot erode a rock basin it cannot clean out one that has been filled up with stream deposits. This alteration of time makes the theory more natural and acceptable; when a rock basin is formed in the course of a stream by elevation or subsidence no lake arises in the great majority of cases, as either the barrier is destroyed by corrosion, or the hollow is filled up by deposition, as fast as it is formed; but when the basin arises underneath a glacier it becomes occupied by ice, and on the retreat and disappearance of the glacier a hollow is left that is at first filled by water, forming a lake, and only subsequently by degrees filled up by stream deposits. In this way the connection between the present distribution of lakes and the areas of pleistocene glaciation is easily explicable, and it is consequently not admissible as an argument to prove that the lake basins were excavated by glaciers until it is shown that in the nonglaciated regions, where there are now no lakes, there are also no rock basins.

With most of the regions quoted by Dr. Wallace I have no personal acquaintance, but in India such do certainly occur, and have as certainly not originated by glacial erosion; in some cases the existence of the rock basin has been proved by borings, but besides these there are many more instances where there can be no reasonable doubt of the existence of a rock basin, though the final test has not been made.

R. D. OLDHAM.

IN his last communication Sir Henry Howorth makes two statements which are so erroneous and so misleading that I cannot allow them to pass without correction. The first is, that Mr. Deeley “repudiates Dr. Wallace's notion that regelation can in some way act as a compensating element when crushing supervenes in ice.” Here is a double misstatement. Mr. Deeley “repudiated” no notion of mine, or he would, I am sure, have said so plainly, and he said nothing whatever about “crushing.” Neither did I say a word about regelation acting as a “compensating element,” for I do not believe in the crushing of glaciers by their own pressure. I asked Sir Henry what would happen to the ice after it was crushed, the pressure continuing; and I get no reply but the above double misstatement.

Then, further on, Sir Henry says: “Mr. Wallace confesses he does not like to face these mechanical issues.” This is simply untrue. I “confessed” nothing of the kind, and I challenge Sir Henry Howorth to quote any words of mine which will bear such a meaning. I maintain that his “mechanical issues” are pure theories, and are beside the question of the actual facts of glacier notion. Lastly, he attempts to evade the real issue between us, which is, that he himself accepted Charpentier's conclusions as to the extent of the Rhone glacier, but refuses to allow me to use these same conclusions as a datum in the discussion.

I have now shown ample reason why further discussion of this matter with Sir Henry Howorth must be unprofitable.

ALFRED R. WALLACE.

#### The Second Law of Thermodynamics.

I AM unable to see any reason for regarding Clausius' supposed deduction of the Second Law as in any way limited by the condition stated by Mr. Burbury, viz. “that the system be conservative, that is, that the external as well as the internal forces acting on it are to be derived from a potential.” No such limitation was contemplated by me when I was preparing the Report for the British Association.

It is true that this assumption is made in § 17 of the Report, in order to establish the closest possible connection between the

deduction and Hamilton's Principle of Least Action. But the limitation is required by the postulate, viz. the Principle of Least Action, not by the deduction. Clausius expressly states (*Phil. Mag.* vol. xlv. (1872) p. 365) that his deduction holds good for systems to which the Principle of Least Action is not directly applicable, and in consequence he claims that his equations involve a new principle which is of more general application than Hamilton's Principle (*vide* Report, § 16). I think there can be little doubt that Clausius had in his mind the very objection which Mr. Burbury now raises, and that it was in order to meet it that he claimed this generalisation.

The assumption as to the conservative nature of the forces is not required except in § 17 of the Report, and at the end of that paragraph two methods of avoiding it are suggested. One is to assume that the force-function can be varied with the time, the other is a method adopted by Von Helmholtz.

If we allow the force-function to be varied with the time, then in Mr. Burbury's case (of a column of gas held down by a piston of constant mass) the potential of gravity can be altered and therefore the weight of the piston is disposable. This disposes of Mr. Burbury's objection, and it only remains to consider the investigations given at the beginning of § 17 of the Report.

Clearly the Second Law of Thermodynamics cannot be deduced from studying the behaviour of gas under constant pressure. To establish it we must make the working substance undergo a reversible cycle in which heat is absorbed and external work performed. To do this we attach the piston to a crank as in an ordinary steam engine, and make it turn a wheel which raises a weight by means of a windlass. Here we have a strictly conservative system, and one to which the arguments of § 17 are therefore strictly applicable. And for every single turn of the wheel we have

$$\int \frac{dQ}{T} = 0 \dots \dots \dots (1)$$

a relation identical in form with that which expresses the Second Law.

It seems to me that the real objections to Clausius' deductions are far more intricate and far less easily disposed of. The difficulty of assigning a physical meaning to the quasi-period  $i$  is one of them, and there are other difficulties connected with the interpretation of  $T$  as absolute temperature when intermolecular forces are taken into account. All these difficulties are alluded to in my Report, and they are not peculiar to the hypothesis of "quasi-periodic" motions; similar difficulties exist in some form or other in most so-called "proofs of the Second Law."

It may be interesting to mention that a proof of the Second Law based on the virial equation

$$pv = \frac{3}{2} (T + \Sigma \Sigma (\frac{1}{2} R^2))$$

was given by R. C. Nichols in the *Philosophical Magazine* for 1876 (v. Series I. p. 369). I hope later on to deal more fully with that portion of Mr. Burbury's letter which relates to the "virial proof."

G. H. BRYAN.

December 21.

**Flame.**

I HAD hoped that after disavowing the unpleasant interpretation which had been put upon his first letter, Dr. Armstrong would have done me the honour, and himself the justice, of indicating precisely where he disagreed with my scientific arguments. Instead of doing so, he has imputed to me a sensitiveness to criticism so excessive that he feels it best to retire from the controversy with a mere statement that our standpoints are different. I must leave it to the readers of NATURE to judge whether Dr. Armstrong has any longer the right to claim a *standpoint*.

Mr. Newth will find a fuller discussion of my views about flame in the *Journal of the Chemical Society* for 1892, pp. 204-226. If after reading that he still has difficulty in understanding the fundamental points of my work, I shall be glad to help him if he will communicate with me privately. With a little care, Mr. Newth will find it quite easy to separate the two cones of a carbon monoxide-air flame in the ordinary apparatus without the use of a gauze cap. The air must be turned on very gradually. In the case of the hydrogen-air flame it is best to dilute the gases with nitrogen, as recommended in my first paper.

I am sorry that anyone should think I have slighted Dr. Frankland's work. I can, however, understand, and even admire, Mr. Newth's excessive zeal in the matter.

ARTHUR SMITHELLS.

**"The Zoological Record."**

WE are delighted to find such a consensus of opinion as to the desirability of retaining palæozoology in the *Zoological Record*. The recorders whom we have consulted, the editor, and now the secretary of the Zoological Society, all have expressed themselves in its favour. The question therefore is purely one of finance. Under these circumstances the publication of the correspondence with the Geological Society is of great interest, and the only addition that we could suggest would be the publication in your columns of that poverty-stricken society's balance-sheet.

We should like, however, to point out that the *Zoological Record* appeals to the Geological Society, not merely on the ground of its palæontological contents. Palæontologists go to the *Record* to learn what the neontologists are doing, quite as much as to read the titles of their own papers. Under any circumstances, then, the *Zoological Record* has some claim on the Geological Society, and we must all regret that financial distress prevents the Society from acknowledging that claim.

But the Record Committee of the Zoological Society need not despair; for the *Record* has no less claims on many other of our learned societies, and, by the converse argument, the inclusion of palæozoology merely strengthens those claims. Every biologist should be grateful to those who bring to his notice literature that he would otherwise never hear of. Apart from this, one-third of the volume is devoted to entomology. Why should the Entomological Society not be invited to contribute? Then there are the Royal and the Linnean Societies, and the British Association; the Microscopical, we would mention, did it not already do excellent work of a similar kind. At any rate, surely five of these bodies could be prevailed on to subscribe £20, or even £40 a-piece. The Zoological Society appeals through its *Record* to hundreds of workers who do not belong to it. It has long done an admirable work, of which it will never lose the credit. Everyone should sympathise with it in its present attempt to perfect this work, and should not permit it to suffer so large a pecuniary loss in that attempt.

December 17.

R. I. POOCK.  
F. A. BATHER.

**On the Bugonia-Superstition of the Ancients.**

LAST August, I published in the *Bulletin Soc. Entomol. Italiana*, 1893, p. 186-217, an article entitled "On the Bugonia of the Ancients, and its relation to *Eristalis tenax*, a two-winged insect." I desire to collect some more materials on that subject, in view of a second edition, and I would be very grateful to readers of NATURE who may be able to give me assistance in that matter.

The information I require may be expressed in two questions: (1) Whether travellers in out-of-the-way places in Europe or Asia have not come across vestiges of the superstition about oxen-born bees, still lingering among primitive people?

(2) Whether readers of Oriental literature have not come across passages evidently referring to this superstition, like the passage I reproduce here as an example. I found it in the "Golden Meadows" of the Arab traveller Massoudi (died in Cairo, 955), translated by Barbier de Meynard and Pavet de Courteille, Paris, 1861, vol. iii. p. 233. It relates a conversation which took place in Arabia, and of which this is a fragment. "Had the bees, which produced this honey, deposited it in the body of a large animal," asked Yiad? The surveyor answered: "Hearing that there was a hive near the sea-coast, I sent people to gather the honey. They told me that they found at what place a heap of bones, more or less rotten, in the cavity of which bees had deposited the honey that they brought with them."

I have sent separate copies of my paper to the Geographical, Linnean, and Entomological Societies in London, to the Natural History Museum, South Kensington, to the Athenæum Club, and to many friends in England. I should be happy to send a copy to anybody interested in the subject.

C. R. OSTEN SACKEN.

**The Earliest Mention of the Kangaroo in Literature.**

I TAKE advantage of the present opportunity to put another question to zoologists. In the same book of Massoudi, whom I quoted in the previous notice, I found the following passage (vol. i. p. 387):—"El Djahiz, in his 'Book on Animals,' relates that the female rhinoceros is pregnant for seven years,

during which the cub protrudes the head from the belly of the mother, in order to browse, and withdraws it afterwards. Desirous of being better informed, I asked the people of Siraf and Oman, who visited this country, as well as merchants whom I had met in India. They all told me that the rhinoceros breeds just like the cow and the buffalo; and I do not know where El Djahiz has found this story, whether among his reading, or from his inquiries." This is evidently an obscure tradition about the Australian kangaroo, which had reached some part of Asia, and was connected with the rhinoceros by people who knew nothing about either of the two animals. Has the attention of zoologists been called to this story before?

Heidelberg, Germany, C. R. OSTEN SACKEN.  
December 5.

On an Undescribed Rudimentary Organ in Human Attire.

LECTURERS who are tired of the cockade hat-ribbon and tail buttons, may be glad to know of the following rudiment. The old-fashioned double eye-glass was a folder, with a knob at the outer side of the distal glass; and this on folding locked against a pin on the outer side of the proximal glass. The double eye-glass of the present day does not fold; but, none the less, is the knob outside the distal glass retained for it, though there is no pin to lock with on the proximal glass. How long will it take before this useless rudiment disappears? What will be the cause of its disappearance? As panmixia is out of the question, we may prophesy that it will be economy of material.

Cork, December 12. MARCUS HARTOG.

EARLY ASTERISMS.<sup>1</sup>

III.

The Constellations referred to in the Myth of Marduk and Tiamat.

WE are indebted to the myth, then, for the knowledge that when it was invented the constellations Bull, Scorpion, Goat, and Fishes had been established.

This argument is strengthened by the following considerations suggested by Jansen:—

"We look in vain among the retinue of Tiamat for an animal corresponding to the constellations of the zodiac to the east of the vernal equinox. This cannot be accidental. If therefore we contended that the cosmogonic legends of the Babylonians stood in close relationship to the phenomena of sunrise on the one hand and the entrance of the sun into the vernal equinox on the other; that, in fact, the creation legends in general reflect these events, there could not be a more convincing proof of our view than the fact just mentioned. The three monsters of Tiamat, which Marduk overcomes, are located in the 'water-region' of the Heavens, which the Spring Sun Marduk 'overcomes' before entering the (ancient) Bull. If, as cannot be doubted, the signs of the zodiac are to be regarded as symbols, and especially if a monster like the goat-fish, whose form it is difficult to recognise in the corresponding constellation, can only be regarded as a symbol, then we may assume without hesitation that at the time when the Scorpion, the Goat-Fish, and the Fish were located as signs of the zodiac in the water-region of the sky, they already played their parts as the animals of Tiamat in the creation legends. Of course they were not taken out of a complete story and placed in the sky, but conceptions of a more general kind gave the first occasion. It does not follow that all the ancient myths now known to us must have been available, but certainly the root-stock of them, perhaps in the form of unsystematic and unconnected single stories and concepts."

There is still further evidence for the constellation of the Scorpion.

Jensen remarks:—

<sup>1</sup> Continued from vol. xlviii. p. 520.

"A Scorpion-Man plays also another part in the cosmology of the Babylonians. The Scorpion-Man and his wife guard the gate leading to the Māsu mountain(s), and watch the sun at rising and setting. Their upper part reaches to the sky, and their *irtu* (breast?) to the lower regions (Epic of Gistubar 60,9). After Gistubar has traversed the Māsu Mountain, he reaches the sea. This sea lies in the east or south-east. However obscure these conceptions may be, and however they may render a general idea impossible, one thing is clear, that the Scorpion-Men are to be imagined at the boundary between land and sea, upper and lower world, and in such a way that the upper or human portion belongs to the upper region, and the lower, the Scorpion body, to the lower. Hence the Scorpion-Man represents the boundary between light and darkness, between the firm land and the water region of the world. Marduk, the god of light and vanquisher of Tiamat, i.e. the ocean, has for a symbol the Bull = Taurus, into which he entered in spring. This leads almost necessarily to the supposition that both the Bull and the Scorpion were located in the Heavens at a time when the sun had its vernal equinox in Taurus and its autumnal equinox in Scorpio, and that in their principal parts or most conspicuous star groups; hence probably in the vicinity of Aldebaran and Antares, or at an epoch when the principal parts of Taurus and Scorpio appeared before the sun at the equinoxes."

If my suggestion be admitted that the Babylonians dealt not with the daily fight but with the yearly fight between light and darkness—that is, the antithesis between day and night was expanded into the antithesis between the summer and winter halves of the year; then it is clear that at the vernal equinox Scorpio setting in the west would be watching the sunrise; at the autumnal equinox rising in the east, it would be watching the sunset; one part would be visible in the sky, one below the horizon in the celestial waters. If this be so all obscurity disappears, and we have merely a very beautiful statement of a fact, from which we learn that the time to which the fact applied was about 3000 B.C., if the sun were then near the Pleiades.

Jensen in the above-quoted passages by implication, and in a subsequent one directly, suggests that not all the zodiacal constellations were established at the same time. The Babylonians apparently began with the easier problem of having six constellations instead of twelve. For instance, we have already found that to complete the present number, between

|                     |              |           |
|---------------------|--------------|-----------|
| Scorpio.            | Capricornus. | Pisces.   |
| we must interpolate |              |           |
| Sagittarius.        |              | Aquarius. |

Aries and Libra seem also to be late additions according to Jensen, who writes:—

"We have already above (p. 90), attempted to explain the striking phenomenon that the Bull and Pegasus, both with half bodies only, *ἡμιτόμοι*, enclose the Ram between them, by the assumption that the latter was interposed later on, when the sun at the time of the vernal equinox stood in the hind parts of the Bull, so that this point was no longer sufficiently marked in the sky. Another matter susceptible of a like explanation may be noted in the region of the sky opposite to the Ram and the Bull. Although we cannot doubt the existence of an eastern balance, still, as already remarked (p. 68), the Greeks have often called it *χρηλαί* 'claws' (of the Scorpion), and according to what has been said above (p. 312), the sign for a constellation in the neighbourhood of our Libra reads in the Arsacid inscription 'claw(s)' of the Scorpion. These facts are very simply explained on the supposition that the Scorpion originally extended into the region of the Balance, and that originally  $\alpha$  and  $\beta$  Librae represented the 'horns'

of the Scorpion, but later on, when the autumnal equinox coincided with them, the term Balance was applied to them. Although this was used as an additional name, it was only natural that the old term should still be used as an equivalent. But it also indicates the great age of a portion of the zodiac."

Let us suppose that what happened in the case of Aries and Libra happened with six constellations out of the twelve, in other words, that the original zodiac consisted only of six constellations. We should have—

|        |                       |                            |             |             |        |
|--------|-----------------------|----------------------------|-------------|-------------|--------|
| Taurus | Crab<br>(or Tortoise) | Virgin<br>(or ear of corn) | Scorpion    | Capricornus | Pisces |
| Gemini | Lion                  | Libra                      | Sagittarius | Aquarius    | Aries  |

The upper list not only classifies in an unbroken manner the Fish-Man, the Goat-Fish, the Scorpion-Man, and Marduk of the Babylonians, but we pick up all or nearly all of the ecliptic stars or constellations met with in early Egyptian mythology, Apis, the Tortoise,<sup>1</sup> Min, Selk, Chnemu as represented by appropriate symbols.

Further, the remarkable suppression or small representation of the Lion in both the more ancient Babylonian and Egyptian mythology is explained. I have shown before how the Babylonians with an equinoctial year would take slight account of the solstice, while it also follows that the Egyptians, who were wise enough not to use zodiacal stars for their warnings of sunrise for the reason that stars in the brighter light of dawn near the sun are more difficult to see, might easily neglect the constellation of the Lion as first Phact and then Sirius, both southern stars, marked for them the advent of the summer solstice; on different grounds, then the Lion might well have been at first omitted in both countries.

Since there is a doubt as to the existence of the Lion among the first Babylonian constellations,<sup>2</sup> the argument in the following paragraph would appear to refer to observations made at a later time when totemism was less prevalent:—

"The Lion in the heavens must represent the heat of the summer. He does this most effectually when the summer solstice coincides with the constellation, that is, when its principal stars appear before the sun at the summer solstice. This happened at the time when the vernal equinox lay in Taurus, and when the principal star-group of the Bull appeared before the sun at the time of the vernal equinox. The water-jug (Amphora)—Aquarius must represent symbolically the watery season of winter. It does this most effectually when the winter solstice coincides with it, or its principal star-group appears before the sun at the winter solstice. This happened about the time when the vernal equinox lay in Taurus, and its principal star-group rose before the sun at the time of the vernal equinox."

The above suggested basis of the Babylonian mythology, regarding the demons of Tiamat, established when the sun was in Taurus at the spring equinox, enables us to understand clearly the much later (though similar) imagery employed when the sun at the equinox had passed from Taurus to Aries—when the Zend Avesta was written, and after the twelve zodiacal constellations had

been established. We find them divided equally into the kingdoms of Ormuzd and Ahriman. Here I quote Dupuis:<sup>1</sup>

"L'agneau est aux portes de l'empire du bien et de la lumière, et la balance à celles du mal et des ténèbres; l'un est le premier des signes supérieurs, et l'autre des signes inférieurs.

"Les six signes supérieurs comprennent les six mille de Dieu, et les six signes inférieurs les six mille du diable. Le bonheur de l'homme dure sous les premiers signes, et son malheur commence au septième, et dure sous les six signes affectés à Ahriman, ou au chef des ténèbres.

"Sous les six signes du règne du bien et de la lumière qui sont agneau, taureau, gémeaux, cancer, lion et vierge ou épi nous avons marqué les états variés de l'air et de la terre, qui sont le résultat de l'action du bon principe. Ainsi on lit sous l'agneau ou sous le premier mille ces mots, printemps, zephyr, verdure; sous le taureau, sève et fleur; sous les gémeaux, chaleurs et longs jours; sous le cancer, été, beaux temps; sous le lion, épis et moissons; et sous la vierge, vendages.

"On passant à la balance, on trouve les fruits; à commence le règne du mal aussitôt que l'homme vient à cueiller les pommes. La nature quite sa parure; aussi nous avons écrit ces mots. Dépouillement de la nature, sous le scorpion on lit froid; sous le sagittaire, neiges; sous le capricorne, glace et brouillard, siège des ténèbres et de long nuits; sous le verseau, pluies et frimas; sous les poissons, vents impétueux."

We now return for a moment to Ia.

Associated with Ia was an Ia-star, which Jensen concludes may be  $\eta$  Argûs. This we must consider.

Jensen concluded that the Ia-star is  $\eta$  Argûs, on the ground that many of the texts suggest a darkening of it now and again; he next proceeds to point out that a variability in the star is the only point worth considering in this connection, and by this argument he is driven to  $\eta$ , which is one of the most striking variables in the heavens, outshining Canopus at its maximum. Speaking generally, everybody would agree that observation by clouds, &c., would not be recorded, but if the star were observed just rising above the southern horizon only, then its absence, due to such causes, would, I should fancy, be chronicled, and it must not be forgotten that this is precisely the place where it would be observed, for in the first place it was to the south of the heavens, what Bil was to the north, and the temple sacred to it at Babylon was oriented to the south.

But  $\eta$  Argûs never rose or set anywhere near the south. I have ascertained that its declination was approximately  $33\frac{1}{2}^{\circ}$  S. in 6000 B.C., and increased to  $40^{\circ}$  S. by about 2000 B.C. Hence between these dates at Eridu its amplitude varied between  $38^{\circ}$  and  $47^{\circ}$  S. of E. or W. Now here we are far away from the S. point, though very near the S.E. or S.W. point, to which it is stated the Babylonian structures had their sides oriented.

The question arises whether there was a star which answers the other conditions. There was a series of such stars. First, beginning with the most recent; we have *Canopus*. 6000 B.C. its declination was  $62\frac{1}{2}^{\circ}$ ; it would then have been below the horizon of Eridu, first making its appearance with a declination of  $59^{\circ}$  nearly at the south point in 4700 B.C. Phact would follow in 5400 B.C. Achenar would make a similar appearance for the first time about 8000 B.C. It may be here mentioned generally that the precessional movement must, after certain intervals, cause this phenomenon to be repeated constantly with one star after another. May this explain the "other animals" who subsequently appeared like Ia (Oannes)? The whole myth is, I think, clearly one relating to men coming (from the south?) to Eridu in ships. The boat is turned into a "fish man," and the

<sup>1</sup> "Origine des Cultes," vol. vii. p. 82.

<sup>1</sup> I think I am right about the Tortoise, for I find the following passage in Jensen, p. 65, where he notes the absence of the Crab:—"Ganz absehend davon, ob dasselbe für unsere Frage von Wichtigkeit werden wird oder nicht, muss ich daran erinnern, das unter den Emblemen, welche die sogenannten "Deeds of Sale" häufig begleiten, verschiedene Male wie der Scorpion so die Schildkröte abgebildet gefunden wird. . . ."

<sup>2</sup> Jensen, p. 314.

star to which they pointed to show whence they came or made a god.<sup>1</sup>

It will have been gathered that the constellations of the Bull and the Scorpion were recognised as such at the same early date both in Babylonia and Egypt, and this of course implies intercommunication.

The ecliptic stars in use in Babylonia in later times are as follows<sup>2</sup> :—

- |                  |                    |
|------------------|--------------------|
| 1. η Piscium.    | 15. α Leonis.      |
| 2. β Arietis.    | 16. ρ Leonis.      |
| 3. α Arietis.    | 17. β Leonis.      |
| 4. η Tauri.      | 18. β Virginus.    |
| 5. α Tauri.      | 19. γ Virginus.    |
| 6. β Tauri.      | 20. α Virginus.    |
| 7. ζ Tauri.      | 21. α Liliæ.       |
| 8. η Geminorum.  | 22. β Liliæ.       |
| 9. μ Geminorum.  | 23. δ Scorpionis.  |
| 10. γ Geminorum. | 24. α Scorpionis.  |
| 11. α Geminorum. | 25. δ Ophiuchi.    |
| 12. β Geminorum. | 26. α Capricornis. |
| 13. δ Cancræ.    | 27. γ Capricornis. |
| 14. ε Leonis.    | 28. η Capricornis. |

With regard to the complete ecliptic, the information seems meagre both from Babylonia and from Egypt in early times.

As to later times in Babylonia—say 1000 B.C.—the following list represents the results of Jensen's investigations :—

- (1) Perhaps Aries (= "leading sheep").
- (2) A "Bull (of the Heavens)" = Aldebaran or (and) = our Taurus.
- (3) Gemini.
- (4) ?
- (5) Perhaps Leo.
- (6) The constellation of the "corn in ears" = the ear of corn. [Spica.]
- (7) Probably Libra, whose stars are, however, at least in general, called "the claw(s)" (*i.e.* of the Scorpion).
- (8) The Scorpion.
- (9) Perhaps Sagittarius.
- (10) The "goat fish" = caper.
- (11) ?
- (12) The "Fish" with the "Fish band."

In Egypt we find no such sharp references as the above to either the poles or the great circles, but dating from the twentieth dynasty (1100 B.C.), and therefore almost contemporaneous, is a series of star tables which have puzzled Egyptologists from Champollion and Biot downwards.

Looking at them they seem to be observations of stars made during the twelve hours of the night on the 1st and 16th of every month. The chief stars seem to be twenty-four in number, and it looked at first as if we had really here a list of priceless value of twenty-four either ecliptic or equatorial stars.

Unfortunately, however, the list has resisted all efforts to completely understand it. Whether it is a list of risings or meridian passages even is still in dispute. Quite recently, indeed, one of the investigators, Herr Gustav Biffinger,<sup>3</sup> has not hesitated to consider it not a list of observations at all, but a compilation for a special purpose.

"The star-table is intended to carry the principle of time into the rigid world of the grave, and represents over the sepulchral vault, 'the eternal horizon' as the ancient Egyptians so aptly styled the grave, an imitation of the sky, a compensation for the sky of the upper world with its time-measuring motion; yet the idea here is bolder, the execution is more artificial and complicated, since the sculptor endeavoured to combine the daily and the annual motion of the celestial vault in *one* picture; wanted to transfer into the grave the temporal frames in which all human life is enacted. This endeavour to represent by one configuration both motions and both

chronological units explains all the peculiarities and imperfections of our star-table.

"The simplest means of representing both motions was found in the stars, which circle the earth in the course of a day and indicate the year by the successive appearance of new stars in the morning twilight. If the same stars were to serve both purposes in one representation, it was necessary to take twenty-four stars which rose at intervals of fifteen days, since only such followed each other at an average distance of 15°, and were therefore useful for showing the hours."

"If the calendar-maker really possessed a list of the twenty-four principal (zodiacal) stars, the course of the year was indicated thereby; but since he also wanted to represent the daily motion, he might with some justice have composed each night out of eleven of these stars, since the stars' risings are only visible during the ten middle hours of the night. But ten hours would not have adequately represented the night, since this was thought of as a twelve hours' interval.

"There was a way out of it, viz. to call *hora 0* 'sunset,' *hora 12* 'sunrise,' which would have been a simple and correct solution if the division of the night into twelve parts for practical purposes had been aimed at. But this expedient he could not adopt, because he could or would only operate with stars, and the notions of sunrise and sunset found no place in his tables. Thus he was forced to *falsify* the customary division of the hours, by squeezing the twelve hours of the night into the time during which star risings are visible, viz. the dark night exclusive of twilight. On the other hand he could not, with his principal stars at intervals of 15°, divide his night, shortened as it was by two hours, into twelve parts, and thus he was obliged to make use of two or three auxiliary stars, as we have proved in detail above, and thus yet more to disfigure the hour-division, since thereby the lengths of the hours were made very variable. These are then two things which we must not regard as peculiarities of ancient Egyptian reckoning, but as a consequence of the leading idea of our table, which did not intend to facilitate the division of the night into twelve parts by star observations, but was calculated by the connection of thirteen stars with thirteen successive moments to create the idea of the circling host of stars and thence the course of the night."

I give an abstract of the list of the twenty-four principal stars and the constellations in which they occur :—

1. Sahu = Orion.
2. Gothis = Sirius.
3. The two stars.
4. The stars of the water.
5. The lion.
6. The many stars.
7. Mena's herald.
8. Mena.
9. Mena's followers.
- 10.
- 11.
12. Hippopotamus.
- 13.
- 14.
- 15.
- 16.
17. Necht.
- 18.
- 19.
- 20.
21. Ari.
22. } Goose.
23. }
24. Sahu = Head of Orion.

It will be seen that this Egyptian star list is very indeterminate, but there are other lists, which are much more definite, represented by the Indian Nakshatras, the Arab Manâzil al-Kamar, and the Chinese Sieu.

<sup>1</sup> For the story as told by Bérôssa, see Sayce, p. 131.

<sup>2</sup> "Astronomisches aus Babylon," pp. 117-133.

<sup>3</sup> "Die Sterntafeln in den ägyptischen Königsgräbern von Bibân el Molûk" — von Gustav Biffinger (p. 69).

| Hindu Asterism.                                                                     | Arab Manzil.                                                                                                | Chinese Sieu.                                 |
|-------------------------------------------------------------------------------------|-------------------------------------------------------------------------------------------------------------|-----------------------------------------------|
| 1. Açvini (The two gods)<br>β and γ Arietis                                         | 1. ash-Sharatān (The two signs)<br>β and γ Arietis                                                          | 1. Mao<br>η Tauri                             |
| 2. Bharanī (Carrying away)<br>35, 39, and 41 Arietis                                | 2. al-Buṭain (The little belly)<br>35, 39, and 41 Arietis                                                   | 2. Pi<br>ε Tauri                              |
| 3. Kṛttikā (Has been explained as matting ;<br>doubtful)<br>η Tauri, &c. (Pleiades) | 3. ath-Thuraiyā (Probably "the cluster")<br>η Tauri, &c. (Pleiades)                                         | 3. Tse<br>λ Orionis                           |
| 4. Rohinī (Red)<br>α, θ, γ, δ, ε Tauri                                              | 4. ad-Dabarān ("The follower" of the Plei-<br>ades)<br>α, θ, γ, δ, ε Tauri                                  | 4. Tsan<br>δ Orionis                          |
| 5. Mr̥gaciras (Head of deer)<br>λ, φ <sup>1</sup> , φ <sup>2</sup> Orionis          | 5. al-Hak'ah (The circle of hairs)<br>λ, φ <sup>1</sup> , φ <sup>2</sup> Orionis                            | 5. Tsing (A well)<br>μ Geminorum              |
| 6. Ārdrā (Damp)<br>α Orionis                                                        | 6. al-Han'ah (Apparently "the wishing As-<br>terism")<br>η, μ, ν, γ, ξ Geminorum                            | 6. Kuei<br>θ Cancri                           |
| 7. Punarvasu (Twice bright)<br>β, α Geminorum                                       | 7. adh-Dhirā' (The arm)<br>β, α Geminorum                                                                   | 7. Lieu (The willow)<br>δ Hydræ               |
| 8. Pushya (Auspicious)<br>θ, δ, γ Cancri                                            | 8. an-Nathrah ("The point between lip and<br>nostrils" of Leo)<br>γ, δ Cancri, and Præsepe                  | 8. Sing (A star)<br>α Hydræ                   |
| 9. Açleshā (Embracing, serpents)<br>ε, δ, σ, η, ρ Hydræ                             | 9. at-Tarf ("The eyes" of Leo)<br>ξ Cancri, λ Leonis                                                        | 9. Chang<br>ν <sup>1</sup> Hydræ              |
| 10. Maghā (The strong?)<br>α, η, γ, ζ, μ, ε Leonis                                  | 10. aj-Jabbah (The forehead)<br>α, η, γ, ζ Leonis                                                           | 10. Y<br>α Crateris                           |
| 11. Pūrva Phalgunī (Grey)<br>δ, θ Leonis                                            | 11. az-Zubrah (The shoulder)<br>δ, θ Leonis                                                                 | 11. Chin<br>γ Corvi                           |
| 12. Uttara Phalgunī<br>β, 93 Leonis                                                 | 12. aṣ-Ṣarfah ("The change" of weather)<br>β Leonis                                                         | 12. Kio (A horn)<br>α Virginis                |
| 13. Hasta (Hard)<br>δ, γ, ε, α, β Corvi                                             | 13. al-Auwā ("The howler," sometimes con-<br>ceived as a dog barking round Virgo)<br>β, η, γ, δ, ε Virginis | 13. Kang (Overbearing, strong)<br>κ Virginis  |
| 14. Citrā (Beautiful)<br>α Virginis                                                 | 14. as-Simāk (The prop)<br>α Virginis                                                                       | 14. Ti (A foundation)<br>α <sup>2</sup> Libræ |
| 15. Svātī<br>α Bootis                                                               | 15. al-Ghafr (Of uncertain sense)<br>ι, κ, λ Virginis                                                       | 15. Fang (Room, dwelling)<br>π Scorpionis     |
| 16. Viçākḥā (Fork)<br>ι, γ, β, α Libræ                                              | 16. az-Zubānān ("The two claws" of the<br>scorpion)<br>α, β Libræ                                           | 16. Sin (The heart)<br>σ Scorpionis           |
| 17. Anurādhā (Blissful)<br>δ, β, π Scorpionis                                       | 17. al-Iklīl (The crown)<br>β, δ, π Scorpionis                                                              | 17. Uei (High)<br>μ <sup>2</sup> Scorpionis   |
| 18. Jyeshthā (The best)<br>α, σ, τ Scorpionis                                       | 18. al-Ḳalab (The heart)<br>α Scorpionis                                                                    | 18. Ki<br>γ <sup>2</sup> Sagittarii           |
| 19. Mūla (Root)<br>λ, ν, κ, ι, θ, η, ζ, μ, ε Scorpionis                             | 19. ash-Shaulāh ("The sting" of the scorpion)<br>λ, ν Scorpionis                                            | 19. Teu<br>φ Sagittarii                       |
| 20. Pūrva-Ashādhā (Unconquered)<br>δ, ε Sagittarii                                  | 20. an-Na'a'im (The ostriches)<br>γ <sup>2</sup> , δ, ε, η, φ, σ, τ, ζ Sagittarii                           | 20. Nieu<br>β Capricorni                      |
| 21. Uttara-Ashādhā (Unconquered)<br>σ, ζ Sagittarii                                 | 21. al-Baldah (The hairless space between the<br>eyebrows)<br>N of π Sagittarii                             | 21. Nū<br>ε Aquarii                           |
| 22. Abhijit (Victorious)<br>α, ε, ζ Lyræ                                            | 22. Sa'd adh-Dhābiḥ (Sa'd (luck) the sacrificer)<br>α, β Capricorni                                         | 22. Hiu<br>β Aquarii                          |
| 23. Çravana (Lame)<br>α, β, γ Aquilæ                                                | 23. Sa'd Bula' ("Greedy Sa'd," because the<br>larger star seems to swallow the smaller)<br>ε, μ, ν Aquarii  | 23. Goei<br>α Aquarii                         |
| 24. Çravishthā (Most glorious)<br>β, α, γ, δ Delphini                               | 24. Sa'd as-Sūūd ("The luck of lucks" = spe-<br>cially lucky star)<br>β, ξ Aquarii                          | 24. Che<br>α Pegasi                           |
| 25. Çatabhishaj (?)<br>λ Aquarii, &c.                                               | 25. Sa'd al-Akhbiyah ("Sa'd with the tents")<br>α, γ, ζ, η Aquarii                                          | 25. Pi<br>γ Pegasi                            |
| 26. Pūrva Bhādrapadā (Having ox feet)<br>α, β Pegasi                                | 26. al-Fargh al-Mukḍim (The front lip of the<br>bucket)<br>α, β Pegasi                                      | 26. Koei<br>ζ Andromedæ                       |
| 27. Uttara-Bhādrapadā (Having ox feet)<br>γ Pegasi, α Andromedæ                     | 27. al-Fargh al-Mukhir (The hinder lip of the<br>bucket)<br>γ Pegasi, α Andromedæ                           | 27. Leu<br>β Arietis                          |
| 28. Revatī (The rich)<br>ζ Piscium, &c.                                             | 28. Baṭn al-Hūt (The fish's belly)<br>β Andromedæ, &c.                                                      | 28. Oei<br>35 Arietis                         |

I mention these, because although their dates are uncertain, they are undoubtedly built upon a common model, they have identical functions, and they have to do with the ecliptic, that is to say, we are in each case in presence of a belt of stars to which the motions of any other heavenly body travelling round the sun or, like the planets, round the earth, like the moon can be readily referred. In these lists<sup>1</sup> I give translations of the Sanscrit, Arab, and Chinese names, so far as they can be made out, and I must here express my deep obligations to Profs. Max Müller, Robertson Smith, and Douglas, for their kindness in supplying them.

J. NORMAN LOCKYER.

### THE SECONDARY EDUCATION MOVEMENT.

THE outcome of the Oxford Conference on Secondary Education in England is our usual panacea for social ills, a Royal Commission. As this is to be, let us hope that the reference will be restricted to some definite points, and the members to a small number of properly qualified persons. Otherwise little else than unnecessary delay will be the result. Practical experience of such Commissions tends, however, to disenchant one with the prevailing idea of their usefulness, that is, of their power to settle the question at issue. Look at the last Commission on Primary Education, containing big-wigs of every kind. How long they sat, and how many Blue Books they filled with evidence, may be learnt by those who are interested. But what did it all come to? The large majority reported that they were totally opposed to free education, and the small minority, though not opposed, saw no possibility of its accomplishment. Two years afterwards a Tory Government carried a Free Education Act! Again, a Royal Commission on Vaccination has been sitting every Wednesday for the last five years, and it has not yet finished taking evidence! In face of facts like these, and they might be greatly extended, can one look with much hope to the early settlement of so difficult and complex a question as English secondary education by a Royal Commission as usually constituted? There are two conditions under which Commissions of this kind can act usefully: first, as means of inquiry into facts, and such a one was the Technical Commission of 1881-4, which journeyed over sea and land in quest of information; and second, as a means of carrying out measures laid down by Act of Parliament; and such a one, for example, is the Scottish University Commission now sitting. If we do not now know what we want in the way of secondary education, let there be a Commission by all means. Many may think that we do know. We are all convinced that more good secondary schools are needed both in town and country; and what has to be decided are such matters as how these schools are to be governed, by whom new ones are to be set up, and old ones remodelled to suit the wants of the times, how the necessary funds are to be found, and so forth. Now, are these questions of a kind which a Royal Commission can once for all determine? I think not. In my opinion they can only be settled by the House of Commons. The rival claims of County Councils, now in possession of the funds; of School Boards, now entrusted with primary education; of existing public schools of various orders; and, lastly, of private venture schools of all sorts and sizes, cannot be met or satisfied by any report of a Royal Commission. They must be fought out on the floor of the House, and it is by no means clear that the outcome of such a struggle

will be in accordance with the recommendations which the report may contain. Therefore, desiring, as all those interested in education must do, to see the present chaos reduced to some degree of order without delay, and the crying needs at least to some extent supplied; and, knowing that there is no present prospect of Government action on such a scale as to systematise our varied forms of educational activity, I, for one, should be satisfied to get a Bill through the House of Commons consisting of two clauses, the first making the educational use of the whisky money compulsory and permanent, and the second giving County Councils power to expend such a portion as they think fit, of the funds capable of devotion to technical instruction, on the furtherance of secondary education. That an expenditure in this direction of some of the money especially voted by Parliament for technical instruction is justified by the acknowledged fact that it is impossible to carry on such instruction, except on the lowest level, to persons ignorant of the educational tools which have to be used.

But, in fact, technical instruction, as defined in the Act, is, or may be, modern secondary education, for it includes all the necessary subjects with the exception of classics and, perhaps, of English and history. So that under these Acts schools—either free or fee'd—can now be established wherever the County Councils determine, and these may be, to all intents and purposes, middle-class secondary schools. Moreover, under these Acts, the local authority may aid existing schools so as to enable them to give scientific or technical instruction. Both of these modes of action are now being widely adopted by County Councils all over the country, so that something substantial in the direction of what is needed is being done. There is, of course, considerable difference of opinion as to the best steps to be taken to bring about a complete and satisfactory system; and for the purpose of ventilating the subject, the Oxford University, in its corporate capacity, took the unprecedented step of calling a conference of the teachers of England, from the university to the elementary school, to discuss the whole question of secondary education. The gathering was remarkable in many ways, but chiefly as an admission, on the part of the universities, of the need of radical educational reform, and of the wisdom of their participation in such reforms. The papers read and the discussions held were, of course, of the multifarious and somewhat discursive order. All, however, from Dean Gregory on the one side, to Mr. Lyulph Stanley on the other, agree "that something should be done," but we may seek in vain for any consensus of opinion as to how that "something" is to be done, or even what that "something" is, except, indeed, the consignment of the matter to the tender mercies of a Royal Commission. Nevertheless, much good may come from the conference; many wise things were said, and the coming together of a large number of persons all in one way or another interested in assisting the progress of the question, cannot be without its useful effect.

What one misses chiefly in the discussion is the scientific aspect of the question. Scarcely a speaker touched upon what, I take it, is after all the gist of the whole matter, viz. the necessity, above all and under all, for an education based upon science. We have to deal, as was well said by Dr. Hewitt, of the Cheshire County Council, not with the 10 per cent. of the population to whom we teach the "humanities," but with the 90 per cent. of humanity struggling for existence. If we want to hold our own with foreign nations, we must alter, and that rapidly, and not waste our precious time too much in inquiry. With the object of raising the standard of existence for these teeming millions the nation now pays £750,000 a year, not enough, perhaps, to accomplish all we require, but amply sufficient for pre-

<sup>1</sup> Reproduced from the Journal of the American Oriental Society, vol. vi. No. 11, p. 468, as given by Profs. Whitney and A. H. Newton.

sent use, especially when we remember that County Councils can, if they please, levy a rate in addition to the Imperial grant. We shall agree with Dr. Gull, of the Grocers' Company's School, that the battle of scientific and technical training *versus* the humanities ought to be decided by evolution and natural selection, rather than by authority; though what this latter exactly means I do not quite understand. Authority can only act when evolution and natural selection—in other words, public opinion—has decided what is wanted. But we shall disagree with him when he says that “no time could be worse than the present for settling this question.” We say that no time can be better, or rather that no time can be so good as the present; for if we do not settle the question soon it will be too late, and our people will lag so far behind those of other countries, that we shall not be able to fetch up our lee way, and the victory will not be to us. To my mind much nonsense is talked, especially by those whom I may without offence call the high-faluting educationists, about so-called culture, and of the necessity for the study of grammar and the humanities for children of every degree. Mr. Bowden, President of the Union of Teachers, is not one of these. He calls attention to the fact—deplorable enough—that only about five per cent. of our five million of children on the registers of elementary schools are in the sixth standard. This being so, it is our duty to give these few children whose parents are willing and able to let them pass on to a higher level of education in secondary schools, that which will most effectively fit them for the life which they afterwards have to follow. Ours is essentially an industrial population, and as the Duke of Devonshire said, at another conference on the same subject, “any advance in the direction of utilising existing secondary schools must be made not for the benefit of the middle classes only, but also of the whole of the working-class community of this country”; and to this I may add Mr. McCarthy's axiom, that school machinery which makes for clerky employment at the expense of the skilled handicrafts, is so far harmful. Still, it is mainly our middle-class education which is in chaos and needs reform. The higher secondary education is probably sufficiently provided for by over 100 so-called “public” schools having a total of from 26,000 to 27,000 pupils. Primary education is under State direction, and will improve from year to year. To amend the middle-class education is more important even than to improve the educational ladder. Mr. Llewellyn Smith's most excellent report on the condition of secondary education in London shows how crying is the necessity in the metropolis for such middle-class schools. The few that exist in the kingdom are often insufficiently endowed, and their work is generally hampered by competition with private venture schools; and how bad the education is, which is given in many of these middle-class private schools, can, as Dr. Gull says, hardly be conceived. These inefficient schools must be either mended or ended before we can make much progress, and for this we need a Registration of Teachers Act, and an effective system of inspection. Honest private schools would benefit, and the others would disappear.

Of all the communications made concerning the relations present and prospective of the universities to the secondary education of the country, the letters read by Prof. Jebb, from the late Master of Balliol, are of the greatest interest, as giving the latest opinions of one who throughout his life was an educational, and especially a university, reformer. Dr. Jowett stated his desire that there should be a universal abiturient examination, giving the right of admission to the universities. Then he wished to give all students who pass such an examination the right of becoming candidates, without residence or restriction of age, for any university examination, with or without honours, or for any part of the examination. He further remarks that such persons

should have the privilege of admission to the libraries, of competing for university certificates and prizes without restriction of age. Moreover, he would give to such candidates as have shown any considerable merit, sums of money to enable them to carry on their inquiries; and this, says Prof. Jebb, was intended by Dr. Jowett to apply to all branches of knowledge without distinction, which the universities could best teach. These are indeed truly radical proposals, for they mean throwing open the university honours and emoluments to the world. That such measures should have been suggested in the almost dying words of the greatest master of the greatest of Oxford colleges, is in itself remarkable evidence of the present position of Oxford opinion. If fifty, or perhaps twenty, years ago, a radical undergraduate were to have made such suggestions, he would have stood a chance of being expelled from the university, like Shelley, for blasphemy; now they are the last words of Jowett, quoted in the presence of the Vice-Chancellor, with approval by Jebb.

H. E. ROSCOE.

#### THE SONNBLICK MOUNTAIN OBSERVATORY.

THE progress of meteorological science having rendered necessary a more careful investigation of the conditions of the higher strata of the atmosphere, the subject of mountain stations was considered at the Meteorological Congress at Rome, in 1879, and the various problems which could best be solved by such observations or in balloons were discussed. Among these may be mentioned:—The decrease of temperature with height, especially during cyclones and anticyclones; terrestrial and solar radiation; the behaviour of barometric maxima and minima at the earth's surface and at great heights, and the increase of wind velocity with height. Several important stations were already in existence, and the establishment of others was strongly recommended. Herr Ignaz Rojacher, the proprietor of the Rauris gold mines, having proposed to the Committee of the German and Austrian Alpine Club, in the year 1884, the erection of a meteorological station at the Miners' House on the Sonnblick, in the province of Salzburg, situated at an elevation of 7550 feet, about halfway between Kolm-Saigurn and the summit of the Sonnblick, Dr. Hann, director of the Austrian Meteorological Service, gladly took advantage of the suggestion, and in December of that year the station was equipped by the Austrian Meteorological Institute. But it was soon found that the site was unfavourable for the purpose, and Herr Rojacher decided that the only suitable position would be the summit of the mountain. After surmounting many difficulties, the work was satisfactorily carried out in the early part of 1886. The Alpine Club undertook the expense of the erection of a wooden house, while the Austrian Meteorological Society provided the self-recording instruments and undertook the building of a substantial tower for the anemometer and the establishment of telephonic communication between the summit and Rauris, a distance of 15½ miles, and, further, to supply instruments to the base station at Kolm-Saigurn. The accompanying illustration shows the position of the Observatory on the peak of the mountain; it is situated at a height of about 10,150 feet, and is the highest station in Europe. The difficulties of dragging the materials for the construction of the Observatory over glacier and snow for a distance of about 900 yards can hardly be overrated. Each trip occupied from three to four hours, and it was at this stage of the work that the greatest assistance was given by Herr Rojacher and his men. His intimate knowledge of the conditions of the glacier and *névé*, obtained from thirty-five years' residence in the neighbourhood, enabled him to select a favourable



site and to carry out successfully the construction of the building. Dr. J. M. Pernter has given a graphic description of the difficulties of an ascent which he made in February 1888 (*NATURE*, vol. xlii. p. 273), during which the foremost guides sank to their hips at every step, despite their use of snowshoes. The maintenance of the station in winter was a matter of great difficulty; but it was materially facilitated by the fact that the Miners' House workmen were at hand for the conveyance of fuel and for carrying out any necessary repairs. But in the year 1888 Rojacher was compelled, from failing health, to sell the mine, and in 1889 operations were discontinued; he succumbed in January, 1891, and then Koim was abandoned altogether. Under these circumstances, the difficulty of continuing the Sonnblick Observatory was increased. The observer could not remain alone on the summit, separated from all human communication by

materially modified the prevalent ideas relative to the nature and origin of storms. In the present report Dr. Hann gives a general account of the climate deduced from observations taken up to the present time. From this it is seen that in each winter the temperature has fallen below minus 22, and in March, 1890, it fell to minus 30°·3. The warmest month is August with a mean temperature of 33°·6, and the coldest month is February, mean temperature 5°·5. The precipitation is mostly in the form of snow; even in the six summer months, May to October, fully 85 per cent. of the fall consists of snow; out of about 200 wet days in the year, rain only fell on 21 days, and then it was often a kind of sleet. The greatest rainfall measured in one day was 2·8 inches on September 1, 1890. The amount of cloud is perhaps of most importance to tourists; this is most prevalent in June and least in December, just the opposite to what obtains in the lowlands. The month of June has only a quarter of the possible amount of sunshine, while in December it has about half the possible amount. Thunderstorms are less frequent on the Sonnblick than in the lower regions, and generally are not so severe. The Observatory is protected by a properly erected lightning conductor, and contains a room suitable for anyone who may wish to carry on researches at a great altitude. This room is entirely reserved for scientific purposes; another apartment, capable of accommodating twenty persons, has been provided for ordinary visitors. The Sonnblick Society deserves the thanks of all meteorologists for carrying on the work in their Observatory. The establishment of the mountain station has led to the elucidation of many obscure problems, and still more important results can confidently be expected.



a difficult journey of several hours over the snow, and it became necessary to hire men specially to carry up the fuel. The Salzburg section of the Alpine Club gave up the use of the house on the Sonnblick, and their contribution was, to a great extent, withdrawn, so that the maintenance of the Observatory was jeopardised. It was under these conditions that the Sonnblick Society, whose first report for 1892 we received a short time ago, was formed for the purpose of aiding in the expense of continuing this most important station. The Society already numbers 280 members, and, in addition to several other contributions, receives considerable subventions from the Austrian Government and the Committee of the German and Austrian Alpine Club.

Since the establishment of the Observatory in 1886, several valuable discussions on the conditions of the atmosphere in the higher regions have emanated from the pen of Dr. Hann and others, and these have already

#### NOTES.

Mlle. KLUMPKE, who has just gained the degree of Doctor in Mathematical Sciences at the Sorbonne, is the first lady who has obtained that distinction. The full title of her thesis was "Contribution à l'étude des anneaux de Saturne," and the following is a translation from *La Nature* of the complimentary terms in which M. Darboux addressed the gifted authoress in granting her the degree:—"You have occupied yourself with one of the most interesting questions in astronomy. The great names of Galileo, Huyghens, Cassini, and Laplace, without speaking of those of my illustrious colleagues and friends, are connected with the history of each of the great advances in the attractive but difficult theory of the rings of Saturn. Your work is not a slight contribution to the subject, and it places you in an honourable position among the ladies who have devoted themselves to the study of mathematics. During last century Mlle. Marie Agnesi gave us a work on the differential and integral calculus. Since then Sophia Germain, as remarkable for her literary and philosophic talent as for her mathematical faculties, was held in esteem by the great geometers who honoured our country at the beginning of this century. And but a few years ago the Academy of Sciences, on the report of a commission in which I had the honour to take part, awarded one of its best prizes to M<sup>me</sup>. Kowalewska, placing her name by the side of those of Euler and Lagrange in the history of discoveries relating to the theory of the movement of a solid body around a fixed point. In your turn you have entered upon your career. We know that for some years you have devoted yourself with great zeal and success to investigations connected

with the star-chart. Your thesis, which you have prepared according to our course of higher mathematics, with an assiduity that we could not ignore, is the first that a lady has presented and successfully sustained before our Faculty to obtain the degree of Doctor of Mathematical Sciences. You have worked in a deserving manner, and the Faculty has unanimously decided to declare you worthy of the grade of Doctor."

M. MAREY has accepted the Presidency of the French Photographic Society, in succession to Dr. Janssen, who has retired after completing his full term of office—three years.

THE *British Medical Journal* says that a branch of the Pasteur Institute will be established at Algiers next year.

THE death is announced of Dr. E. Lellmann, Professor of Chemistry at Giessen University.

WE regret to announce that Prof. A. Sprenger, the celebrated orientalist, died on December 19, at the age of seventy-five.

MR. W. L. H. DUCKWORTH has been elected to a Natural Science Fellowship at Jesus College, Cambridge. The new Fellow took a First Class in both parts of the Natural Science Tripos (1892-93), attaining distinction in Human Anatomy and Anthropology, and has published several papers on points connected with these sciences. His election is creditable both to his College and to the rising School of Anthropology which Prof. Macalister has founded in Cambridge.

THE *University Correspondent* says that the late Mr. Alexander Low Bruce, son-in-law of Dr. Livingstone, the explorer, has left £3,000 for the purpose of founding a Chair of Public Health in the University of Edinburgh.

THE Franklin Institute has awarded the following John Scott Legacy Medals and Premiums:—Mr. J. B. Edson, for his invention of a pressure-recording gauge; Mr. N. W. Perry, for his system of series electric traction for railways; Mr. J. T. Wilkin, for a method and apparatus for generating cycloidal surfaces; Mr. W. F. C. Morsell, for an application of polarised light to the systematic study of colour and crystal patterns for design, and Mr. F. Shuman, for his machine and process for embedding wire-netting in glass.

THE report of the Meteorological Council for the year ending March 31, 1893, which has recently been issued, contains an account of the progress in the various discussions in hand. In the branch of ocean meteorology, much valuable information has been added to the current charts for the Atlantic, Pacific, and Indian oceans, from the log-books of H.M. ships, and from data furnished by Foreign Governments. The latter observations are mostly for the Pacific Ocean, where they are comparatively scarce. For another investigation, the district between the Cape of Good Hope and New Zealand, all available data have been dealt with in the construction of monthly charts of the various elements, and the council have decided that the next district to be discussed shall be the South Atlantic. The work in the branch of weather telegraphy and forecasts continues to increase; comparisons of the results of forecasts issued during the hay harvest season, and of those regularly issued at night for the morning newspapers, show respectively a success of 88 and 79 per cent., taking an average of all districts, but for some localities the success was considerably higher. The work included under the climatology of the British Isles is steadily continued, and among the various investigations may be mentioned a discussion of the results of the harmonic analysis of the daily curves for temperature at the observatories, which has been laid before the Royal Society by General R. Strachey, chairman of the council, and of which an abstract is given in the report. Among the miscellaneous

subjects we notice a description of a proposed new form of pressure gauge, which is the outcome of the investigations on wind measurements that have been carried out by Mr. W. H. Dines; and, also, that the council have commenced the regular tabulation of the hourly values of sunshine for seven observatories, since the year 1881. The results of an inquiry into fog observations, by Mr. Scott, for the years 1875-90, have been published by the Royal Meteorological Society.

AT the meeting of the French Meteorological Society on December 5, M. Angot stated that while investigating the diurnal range of the amount of cloud at Paris, and representing it by a harmonic series, he had found that the semi-diurnal period showed a range absolutely opposite to that of the diurnal variation of the barometer, so that the maximum of the semi-diurnal period in the amount of cloud corresponded to the minimum of pressure, and *vice versa*. We agree with M. Angot that it would be interesting to find whether the same relation holds for other places, in which case a proof would be given of the influence of the diurnal variation of the barometer upon the amount of cloud.

A DIFFERENTIAL method of determining the refractive index of solutions to which the interferential refractometer is not adapted, is described by W. Hallwachs in the current number of *Wiedemann's Annalen*. The former instrument is only applicable to measurements of differences of refractive power between very dilute solutions and their solvents. For higher concentrations the prism method has been generally used. But between these degrees of concentration and the former there lies a long series of solutions to which neither method is well suited. For these, Mr. Hallwachs has adopted the following arrangement. A beam of sodium light falls upon a plane-parallel plate of glass at an incidence of nearly a right angle, and is refracted into the glass and out on the other side, thus only skimming the surface on one side. The glass plate divides the solution from the solvent, and stands at right angles to another vertical plane-parallel plate, the two forming a combination in the form of a T. The beam traverses the solution and the second plate, and emergence at an angle with the first plate, which is read by a scale and micrometer. For differences of refractive index of 0.001, 0.005, and 0.1 the angles were in one case 6°, 13°, and 63° respectively, where with a prism of 60° they would only have been 0.15°, 0.8°, and 16°. In practice, the beam was first sent from the medium into the solution, and then from the solution into the medium, thus eliminating any errors in the position of the plates. The difference of refractive index was equal to the square of the sine of the angle of emergence divided by the sum of the two refractive indices. It was found that the molecular refractive index of the substance is decidedly affected by changes in concentration, accompanied by changes of molecular volume, while the specific refractive power of the substances is, curiously enough, very little disturbed. It appears that the effects of dissociation chiefly influence the density.

FOR some weeks there have been appearing in the *Electrician* accounts of devices for compensating the effects of hysteresis of the iron which is used in measuring instruments. The current number of that journal contains a short account, by Messrs. Field and Walker, of some experiments they have made, at Prof. Perry's suggestion, with this object in view. The principle of the method employed is to place a piece of hard magnet steel as a shunt between the poles of the electromagnet used in the instrument. When the magnetised current is passing, some of the lines of force pass through this shunt. When the current is broken, the lines of force in the air gap, due to the residual magnetism in the electromagnet and in the hard steel, will be in opposite directions, and by suitably proportioning the

length and section of the steel, it is possible to arrange that the two residual magnetisms shall just neutralise each others effect in the air gap. A rather novel method was employed to measure the current. A small rectangular tunnel was made in an ebonite plate, placed between the pole-pieces of the electromagnet, connecting two large flat cylindrical vessels, one of which communicated with an almost horizontal glass tube. Electrodes were fixed on opposite sides of the tunnel, at the part of the field it was required to measure, so that a current could be passed across the tunnel. Under these circumstances, when there was a magnetic field between the pole-pieces, on passing a current between these electrodes and through the mercury, the mercury tended to flow from one of the cylinders to the other. A little alcohol placed above the mercury in the one cylinder flows along the inclined tube, and by its position indicates the pressure exerted by the mercury. The current through the mercury being constant, the pressure is proportional to the strength of the field. The authors say that by the above means it is possible to obtain visible readings for minute variations of the field, whether it be strong or weak.

In the Proceedings of the Boston Society of Natural History, vol. xxvi. July, 1893, we note that Mr. Warren Upham re-asserts his theory of the formation of drumlins in the neighbourhood of Boston. He now brings forward as confirmatory evidence the occurrence of deflected glacial striæ in Somerville, north-west of Boston. Mr. Upham's theory, which was fully expressed a year ago (Proc. B.S.N.H. vol. xxvi. December, 1892), supposes a rapid accumulation of the drumlins taking place during a period of rapid melting of the ice-sheet. Such periods were episodal occurrences, followed temporarily by re-advance of the ice or cessation of its melting; they mark the oscillatory nature of the influences which brought about the final recession of the ice from these areas. The material forming the drumlins was primarily collected by the ground-ice carried upwards through the ice-sheet as a result of the differential velocities of flow in the superficial and ground-ice. It became, after tracing a steep parabolic curve, part of the super-glacial drift, and began then a slowly descending movement, owing to surface-melting during the retreat of the ice. As the superficial drift was washed onwards and downwards over the melting ice, it was gradually transformed into true till. If now an advance of the ice-sheet took place, the super-glacial and englacial drift would be caught between a more rapidly-moving upper current of ice and a thin lower stratum of slowly-moving ice. The drift would suffer, therefore, from shearing movements, and be gathered into great lenticular masses, or sometimes long ridges, of drumlins, probably farther altered and added to before their final exposure. These are the main arguments of Mr. Upham's theory, to several of which grave objections have already been made by Prof. Davis, Mr. G. H. Barton, and others.

In *Petermann's Mittheilungen*, November, 1893, a coloured map is published in illustration of Sir Thomas Elder's Australian Expedition of 1891-92. The map is reduced from the original to scale 1:3,000,000. The routes of travel, the stations at which the various observations were taken, and the geographical features of the country traversed, are all fully entered. The editor gives a brief statement of the objects of the expedition and its attendant success (pp. 269-270).

A WRITER in "Insect Life" (vol. vi. No. 1.), issued by the U.S. Department of Agriculture, describes a remarkable example of mimicry by a spider. At Jamesburg, N.J., in August of this year, his attention was drawn to what was apparently a gall, perfectly formed, and growing upon the upper surface of a leaf of a small oak tree. On handling the leaf, however,

the supposed gall rolled off, and when it was picked up was found to be in reality a spider (*Ordgarius Cornigerus*, Hentz) which had been resting on the leaf, its curiously formed abdomen simulating exactly both in form and colour the common oak gall, even to the tiny punctures through which the gall insect makes its exit when mature.

GUSTAV EISEN has commenced the description of the earth-worms of California; though a dry and rainless country for six months in the year, it still would seem to possess a worm fauna rich both in species and individuals. With the exception of two very imperfectly described species by Kinberg, no true earth-worms have been recorded from this part of the world. While reserving a detailed account for the Transactions of the Californian Academy, Mr. Eisen gives diagnoses of *Deltania*, a new genus near *Microsolex*, with three new species; *D. elegans* (pretty widely diffused, and the largest species of the genus, being from two to four inches in length); *D. troyeri* (from Golden Gate Park, San Francisco); and *D. benhami* (Alameda County). *Argilophilus* is a new genus near *Plutellus*; *A. ornatus*, n. sp., is the most common earth-worm of the region, and *A. papillifer*, n. sp., is a more southern form. (*Zoe* for October, 1893, vol. iv. p. 248.)

THE current number of *Danckelman's Mittheilungen* contains an account of an exploring trip made to the upper regions of Togo, between the years 1890 and 1892, by Captain E. Kling and Dr. R. Büttner. Copious extracts from Captain Kling's diary of his journey are given, with sketches of the features, tattoo marks, and head-dresses of the various tribes of natives he met with; there is also figured a hobby-horse played with by the children, which was made from a strong stalk of millet (in the drawing it looks like a bamboo cane), the head of a horse with ears and bridle being carved out of the root. Very extensive collections of the natural history of the countries visited were made, and astonishingly complete details, considering the time that has elapsed since the specimens were received in Berlin, are given. The lists of the mammals, reptiles, and amphibia of the Togo district are by P. Matschie, the birds of the environs of Bismarckburg are named by Dr. Ant. Reichenow, the fish and crustacea by Dr. F. Hilgendorf, the mollusca by Prof. E. Martens, the insects by Drs. H. Stadelmann and F. Karsch and H. J. Kolbe, the worms by A. Collin. The collection of plants has been only in part worked out, about 560 flowering plants species of were found, and a small number of ferns, lichens, and fungi. In a series of thirteen plates made from photographs taken by Dr. R. Büttner, there are views of Bismarckburg, of the natives of Adeli, Bimbila, &c. With investigations like these in addition to those pursued by our own countrymen, the tropical parts of Africa will soon be better known than the northern regions of the continent which lie within the sight of Europe.

THE order of the Laminariaceæ is one of the most distinct and well defined among the Phæosporeæ, the members of this order of sea weeds are all of comparatively large size, while the species of *Macrocystis* reach a length, even surpassing that of some tropical "climbers," and those of *Lessonia* possess stems which in appearance resemble the trunks of some trees. Since the date (1848) of J. G. Agardh's "Species Algarum" no attempt has been made to classify the numerous genera of this order, but in a very interesting memoir on the classification and geographical distribution of the Laminariaceæ, by W. A. Setchell, which appears in a recent number of the Transactions of the Connecticut Academy (vol. ix. 1893), we find the order divided into three tribes: I. Laminariideæ, with (1) *Laminariæ*, containing the three genera, *Chorda*, *Saccorhiza*, and *Laminaria*; (2) *Agarææ*, with *Agarum*, *Thalassiphylum*, *Costaria*, *Cymathære*, and perhaps *Arthrothamnus*. II. Les-

soniideæ, with (1) Lessoniæ and the genera Dictyonuron, Lessonia, Postelsia, and Nereocystis; (2) Macrocytæ, with Macrocytis. III. Alariideæ, with (1) Alariæ, containing Alaria and Pterygophora; (2) Eckloniæ with Ulopteryx, Ecklonia, and Eisenia; (3) Egregiæ with Egregia. A synopsis of these nineteen genera is given, and also a list of all the known species with localities. The Laminariaceæ are inhabitants of the colder waters of the globe, it is the summer temperature which seems to act as a limit to their distribution, as heat not cold is inimical to their growth, they can endure almost any degree of cold that occurs even in polar seas, but speedily die away where the waters are at all warm.

IN support of his theory that the toxic products elaborated by pathogenic bacteria partake of the nature of ferments, Dr. Ushinsky (*Centr. b. Bakt.* 1893) quotes some very interesting experiments made by Courmont and Doyon, published in two lectures given before the Société de Biologie in March and June last. These investigators, in their studies on tetanus-poison, point out that the toxic action of this material is not hastened by greatly increasing the quantity of toxine introduced into an animal. Thus 200 c.c. of the filtrate obtained from a tetanus-broth-culture were injected into the blood of one dog, and from 3-4 c.c. of the same filtrate into another dog; in both cases tetanus symptoms developed on the third day after the injection. These investigators also state that they were able to induce symptoms of tetanus in animals, by simply injecting some of the blood derived from an animal rendered tetanic as above, similar results being also obtained with muscle-extract. That the quantity of the toxine introduced into the system of an animal does not influence the ordinary period of incubation characteristic for each variety of animal, was confirmed by experiments made by Dr. Ushinsky on rabbits; for by the injection of from 40-50 times the usual quantity of tetanus-toxine into these animals, he was not able to hasten the appearance of the tetanus symptoms. On the other hand, he failed to confirm the remaining results obtained by Courmont and Doyon, for on injecting 6-7 c.c. of the blood of rabbits suffering from tetanus into guinea-pigs and frogs, no symptoms of tetanus made their appearance in these animals. It is possible, however, that the French investigators used larger quantities of tetanus blood for their inoculations, and that this may account for the divergence in the results obtained.

TWO contributions have recently been made towards the ætiology of the particular form of nervous disease known as delirium acutum. Early in the year Prof. Bianchi and Dr. Piccinino published a paper in the Transactions of the R. Accad. Med.-chirurg. of Naples, entitled "Sull'origine infettiva di una forma di delirio acuto," and in the *Centralblatt f. Bakteriologie*, vol. xiv. No. 16, Dr. Rasori has described the results of his observations on the ætiology of a particular case of delirium acutum which passed into his hands in the Bologna lunatic asylum. The investigations were, however, carried out in Prof. Tizzoni's laboratory, and under his direction. The clinical aspect of the case suggested some source of infection as the primary cause of the disease, and at the autopsy some of the fluid underneath the dura mater was removed and inoculated into sterile bouillon and agar-agar respectively, and kept at 37° C. In both these media bacterial growths made their appearance, which were found to be due to a small bacillus, the microscopic and macroscopic description of which is shortly given. The next step was to ascertain if this organism was endowed with pathogenic properties, and for this purpose  $\frac{1}{4}$  c.c. of a pure culture in broth of the bacillus was introduced, with the usual rigid antiseptic precautions, under the dura mater of a healthy rabbit. This animal died in two days, and the bacillus was found in large numbers in the blood and in the

marrow taken direct from the brain and spinal cord. Similar results were obtained when the organism was introduced subcutaneously or into the nasal membrane, the bacillus being detected in the nerve substance as well as in the blood of the animal. The organism was, therefore, possessed of virulent pathogenic properties, being able to exist and multiply in the body of the rabbit, and by elaborating some toxic substance to induce its death in from one and a half to six days, according to the point selected for inoculation. Dr. Rasori, in making this preliminary communication, reserves to himself the task of trying to trace out the special circumstances which favour this bacterial infection, and the manner in which it may gain access to the human subject.

AN excellent photograph of the late Prof. Tyndall appears in Part 52 of "The Cabinet Portrait Gallery," published by Messrs. Cassell & Co., and is accompanied by a sketch of his career.

IN a Supplementary Paper, just issued by the Royal Geographical Society, Messrs. D. G. Hogarth and J. A. R. Munro give an account of "Modern and Ancient Roads in Eastern Asia Minor."

WE have received the *Monthly Weather Review* for July, 1893, prepared under the direction of Mr. A. Pedler, F.R.S., meteorological reporter to the Government of India.

THE third volume of Prof. Blake's "Annals of British Geology," 1892 (Dulau and Co.), has appeared. In previous volumes an objectionable feature was the insertion of criticisms among the abstracts of papers, but in this Prof. Blake's opinions are collected together in the form of an introductory review. We are afraid that the following extract from the preface heralds the death of the "Annals": "On the reception accorded to the present volume depends the continuance of the publication; the experimental stage is ended. The co-operation, therefore, is invited of all those who desire a record of geological literature of any kind, for the 'Geological Record' having fallen through, and the 'Year Book of Science' being discontinued, if these 'Annals' cannot be put on a firm basis the only remaining hope would be that the Geological Society should undertake a 'Record' at their own expense, by the aid of paid recorders."

AT the November meeting of the Institution of Engineers and Shipbuilders in Scotland, Prof. J. H. Biles read a paper on "The Strength of Large Ships," in which he gave the results of a series of calculations undertaken with a view of determining the relative stresses upon ships of more than 400 feet in length. Capt. J. Bain gave an account of experiments made with six large screw steamers to test "The Effect of Reversing the Screw of a Steamship upon the Steering." His experiments lead him to the following conclusions:—(1) If the helm is put hard apart on board a screw steamer, with a right-handed propeller, going full speed, or nearly full speed, ahead, and at the same instant the engines are reversed full speed, her head (provided there are no disturbing influences present) will cant to port instead of to starboard. (2) If the helm is put, or rather allowed to run hard astarboard, the instant the engines are reversed full speed ahead her head will cant to starboard as if on a pivot. (3) If a steamer, with a right-handed screw, going full speed ahead, has another vessel close to on her starboard bow, and in trying to clear her the helm is put hard astarboard and the engines reversed full speed, a collision is almost certain. With regard to the *Victoria* disaster Capt. Bain says: Had both the vessels started from their respective divisions at, say, under half speed ahead, with the port screw reversed on board the *Victoria*, and the starboard screw reversed on board the *Camperdown*, while the other screw on each of them was

kept at full speed ahead, the collision would have been averted.

A FURTHER communication concerning the explosive metallic derivatives of acetylene is contributed to the *American Chemical Journal* by Dr. Keiser. He has previously shown that the compounds obtained by the action of acetylene upon ammoniacal solutions of cuprous chloride and silver nitrate possess the composition  $C_2Cu_2$  and  $C_2Ag_2$ , and that they are to be regarded as substitution products of the hydrocarbon. The action of acetylene upon aqueous and alkaline solutions of mercuric salts has since been studied, and the results are now published. When acetylene acts upon silver nitrate, either in aqueous or ammoniacal solution, the same product,  $C_2Ag_2$ , appears to be produced. But in the case of mercuric salts the action appears to be essentially different in aqueous and alkaline solutions. When acetylene is led through a solution of mercuric chloride in water, a white granular precipitate is produced, which is not explosive after drying, and which does not dissolve in dilute acids with evolution of acetylene gas. This compound contains chlorine, and is represented by the formula  $C_2(HgCl)_2$ . If, however, acetylene is passed into an alkaline solution of a mercuric salt, such as Nessler's solution, mercuric iodide dissolved in potassium iodide with the addition of caustic potash, a white flocculent precipitate is obtained, which when dry is extremely explosive and dissolves in dilute hydrochloric acid with evolution of acetylene. It is analogous in all its properties to the silver and copper compounds, and is a metallic substitution product of the same type,  $C_2Hg$ . This compound can only be obtained in the pure state by the use of pure acetylene, such as that prepared by treating ethylene dibromide with alcoholic potash. Decomposition of the substance commences at about  $100^\circ$ , and when it is rapidly heated to a temperature slightly higher than this it explodes with extreme violence, leaving a small residue of finely divided carbon and mercury. It is particularly interesting to learn that when the substance is treated with an alcoholic solution of iodine it unites with the latter, slowly even at the ordinary temperature and rapidly at the temperature of a water-bath, forming di-iodo-acetylene,  $C_2I_2$ . This compound upon standing a short time polymerises, and the polymer separates in the form of crystals which melt at  $187^\circ$  and appear to be hex-iodo-benzene,  $C_6I_6$ .

In the course of an investigation concerning the atomic weight of copper, Messrs. Richards and Rogers, of Harvard University, have observed that cupric oxide prepared by ignition of the nitrate always contains a considerable amount of occluded gas, chiefly nitrogen, while that prepared from the carbonate invariably shows no sign of occluded gas. This fact is of considerable importance inasmuch as the previous determinations of the atomic weight of copper are affected by it and will be rendered more or less inaccurate. It is no new observation, however, for it was pointed out by Frankland and Armstrong as long ago as 1868, but appears to have been largely overlooked. The Harvard chemists show, moreover, that the phenomenon is also exhibited by oxides of zinc, nickel, and magnesium, when prepared by ignition of the nitrate. In the case of magnesia the amount of occluded gas is extraordinarily large, exceeding a hundred cubic centimetres from ten grams of oxide. Hence it is considered necessary that the atomic weights of these metals should be subjected to revision, taking account of these facts, and until this is done the values hitherto accepted can only be considered as approximate.

THE additions to the Zoological Society's Gardens during the past week include a Mona Monkey (*Cercopithecus mona*, ♀) from West Africa, presented by Mrs. Frances Bell; a Bonnet Monkey (*Macacus sinicus*) from India, presented by Mr. Henry

Vane; three Black-backed Jackals (*Canis mesomelas*) from South Africa, presented by Mr. J. Matcham; four Bernicle Geese (*Bernicla leucopsis*), 2 ♂, 2 ♀ European, a Variegated Sheldrake (*Tadorna variegata*) from New Zealand, presented by Sir Henry Peek, Bt.; a Little Auk (*Merula alle*) British, presented by Mr. J. W. C. Stares; two Adorned Ceratophrys (*Ceratophrys ornata*) from Buenos Ayres, presented by Miss Mildred FitzHugh; a Mozambique Monkey, (*Cercopithecus pygerythrus*) from East Africa, deposited; six Smooth-clawed Frogs (*Xenopus laevis*) hatched in the Gardens.

OUR ASTRONOMICAL COLUMN.

SMALL DISTANCES MEASURED WITH THE HELIOMETER.—As the filar micrometer measures very precisely distances of a few seconds, so with equal accuracy does that important of modern instruments, the heliometer, measure distances ranging from a few minutes up to one or two degrees. With the former instrument one brings the thread (moved by the micrometer head) first to one side of the star and then to the other; or, if one has two threads, one places the star half-way between them, and thus reads off the distance. With the heliometer the distances are read off the scale at the object-glass end (from the eye end), the images of the two stars cast by the movable half of the object-glass being placed symmetrically first on one, and then on the other side of the images from the fixed half.

In the measurement of small distances with the heliometer it has been found that nearly every observer measures the distances too small, thus a small positive correction has to be applied to the observations. As an instance of the magnitude of the corrections to be added or subtracted for various distances, we give the following table:—

| Mean distance | CAPSTADT. |         |         | Yale Obs. Chase. | GÖTTINGEN. |         |
|---------------|-----------|---------|---------|------------------|------------|---------|
|               | Gill.     | Finlay. | Jacoby. |                  | Schur.     | Ambrom. |
| 1000          | +0'03     | +0'07   | +0'18   | +0'14            | +0'20      | +0'14   |
| 2000          | +0'01     | 0'00    | +0'13   | -0'08            | -0'03      | +0'02   |
| 3000          | +0'01     | -0'04   | +0'13   | +0'05            | -0'09      | -0'11   |
| 4000          | +0'01     | 0'00    | 0'00    | -0'01            | -0'08      | -0'11   |
| 5000          | -0'06     | -0'05   | -0'15   | -0'10            | -0'01      | -0'15   |
| 6000          | -0'04     | -0'13   | -0'21   | -0'18            | -0'12      | -0'22   |
| 7000          | 0'00      | -0'12   | -0'12   | -0'08            | -0'07      | -0'21   |

The necessity of such a correction has long been known, but its cause is yet unexplained, although suggestions, such as that of Dr. Gill, have been put forward. In *Astronomische Nachrichten*, No. 3197, Prof. Wilhelm Schur gives an interesting account of his investigations, which had for their aim the determination of the source of this error. Observations showed him that the explanation suggested some time back by Dr. Gill was not valid, at any rate for the Göttingen heliometer: it was finally thought that an explanation might be found by supposing an irregular guidance to occur to those parts of the instrument which carry the objective, but on investigation it was found that such was most improbable. Irregularity in the objective slides themselves was also eliminated, as the magnitude of the error necessary to produce such a large difference in the distance measured was too large to be at all considered. In the paper Prof. Schur is led to discuss some of the measurements made in the triangulation of the Præcipe, and he refers to the method he adopted to bring all the measures into harmony. Three ways were open to him to satisfactorily accommodate the distances in this work, they being, in the measurements of the three arcs, the employment of quantities which are too small to be of no account in the measures of distances in the large quadrilateral. Development of the formula on the assumption (as the observations indicate) that at the distance 1300' a maximum in the correction occurs, and for 0' and 5000' the "verbesserung" is 0, and  $\alpha$  is assumed to be 0'473. And lastly, the computation of the "verbesserung" after the expression  $0'264 s$ , which assumes a change in the scale value, which change, although inadmissible for large distances, brings, in the case of the distances here concerned, the measurements into a more satisfactory concord.

THE TAIL OF COMET BROOKS (c. 1893).—The tail of this comet seems to have undergone some interesting changes, and the following brief descriptions from two well-known observers will show the different appearances observed. Mr. Brooks describes the tail on October 21, 17h, as having a sharp curve close to the head towards the south and accompanied by a faint secondary tail, issuing from the head at an angle of  $30^\circ$  to the main tail towards the north (*Astronomy and Astrophysics* for December). On November 4, the tail assumed its usual straight form, but on November 9, 17h, it was straight for a length of half a degree from the head, where it became forked, the larger portion curving gracefully to the south, the fainter part straight, or nearly so, branching to the north, the two branches making an angle with each other of about  $25^\circ$ . Prof. Barnard, who has obtained several pictures, found that they showed undoubtedly that on October 21 the tail had encountered some outside or obstructive medium which badly shattered it. Rapid and some very remarkable changes in position angle were also gathered from an examination of the plates. The advantage of photography for obtaining cometary photographs, and especially for making analyses of the tails, will be at once grasped when one considers that Prof. Barnard, with the 12 in., could not trace the tail even to a distance of  $1''$ , while the photographs taken with the Willard lens (6 in. aperture, 31 in. focus) showed it fully for  $10''$ .

HYDROGEN ENVELOPE OF THE STAR D.M. +  $30^\circ 3639$ .—Prof. W. W. Campbell, in the December number of *Astronomy and Astrophysics*, communicates a very important observation with regard to the spectrum of one of the Wolf-Rayet stars. The star in question is of the 9.3 magnitude, D.M. +  $30^\circ 3639$ , and its spectrum is very rich in bright lines. The most striking features of the visual spectrum have been noted as the bright line  $\lambda 5694$ , the bright blue band at  $\lambda 4652$ , and the very bright hydrogen line H $\beta$ . By arranging the spectroscope so that each of these different parts of the spectrum is in focus, the line  $\lambda 5694$  is seen as "a very small image of the star." The band at  $\lambda 4652$  is "broad and lies wholly upon the narrow continuous spectrum," the H $\beta$  line observed with a narrow slit "is a long line extending to a very appreciable distance on each side of the continuous spectrum," and with an open slit is "a large circular disc 5" in diameter." Other hydrogen lines H $\gamma$  and H $\alpha$  also exhibit the same peculiarities. The explanation of this appearance is that the star in question must be surrounded by an envelope of incandescent hydrogen, for other lines in the same spectrum are not so changed. It is remarked also that in other stars of the same type no such image has been observed.

"L'ASTRONOMIE" FOR DECEMBER.—The December number of this journal commences with a most interesting article by Dr. Janssen on the Observatory at Mont Blanc. The article itself contains nothing of which our readers have not been informed in the previous columns of NATURE unless it be the illustration showing the summit of the mountain with the observatory "in winter." Two good illustrations of the appearance of the sun during the last total eclipse of the sun (April 16, 1893), the clichés of which were obtained by M. Schœberle and Prof. Deslandres. "Around the world of Jupiter in ten hours" is the title of a series of observations made at the observatory of Juvisy by M. Eugène Antoniadi. The writer gives twelve drawings of this planet, as made during this period, showing the various surface markings which were brought to view by rotation. Amateurs and others who at this time are observing this planet will find these drawings a most useful help in recognising many markings. The red spot is described as excessively pale: "Elle est colorée en rose; ses régions centrales sont claires, ses bords plus sombres; elle est entourée d'une auréole blanchâtre."

#### GEOGRAPHICAL NOTES.

THE death of Dr. H. Rink, on December 15, removes the greatest authority on Greenland and the Eskimo. His life-long devotion to the problems of the Arctic people gained for him the esteem of all geographers.

REUTER'S AGENCY announces that information has been received from Baron Toll to the effect that up to October 25 Dr. Nansen had not called at the Olenek river. This is practically decisive news that Dr. Nansen found the sea so open that he

determined to push northward without delaying to call anywhere; and it is improbable that we shall hear more of the intrepid traveller until we receive his own report of success or failure.

DR. MURRAY'S paper on the renewal of Antarctic exploration will be published in the January number of the *Geographical Journal*, which commences the third volume. It will be accompanied by a series of letters from distinguished foreign oceanographers and naturalists, strongly urging the importance of resuming systematic exploration in Antarctic seas.

DR. HILLIER has recently communicated a paper to the Vienna Academy of Sciences on the geography of the Pindus range, one of the few mountain systems of any extent in Europe which has never yet been adequately explored. He finds that the system consists of three parallel ranges, and he has unravelled the geological structure of each.

A COMMUNICATION to the Royal Geographical Society states that Mr. Crawshaw, a Government official in British Central Africa, has recently visited the Angoni country near Lake Nyasa. He found the Nyika Plateau, which was traversed on the way, a magnificent country, inhabited by a scattered population of Anyika, living in huts built on narrow terraces on the mountain-side or in caves, and cultivating peas as an almost exclusive crop. In this district there are some fine mountains, exceeding 8,000 feet in height, the principal town of the Anyika, on the slope of Kantorongondo, being nearly 6,000 feet above the sea.

#### EPIDEMIC INFLUENZA.<sup>1</sup>

THE present report, a welcome supplement to the epoch-making report on the epidemic of 1889-90, is divided into eight parts, the first seven by Dr. Parsons, and the last one by Dr. Klein. It includes statistical studies of the epidemic of 1890, an account of the recent epidemics in England and Wales, a history of influenza abroad in 1891 and 1892, considerations respecting the ætiology of the disease, notes on some clinical features of the later epidemics, reports on outbreaks in institutions, &c., remarks on the prophylaxis of the disease, and, in Dr. Klein's department, a report on influenza in its clinical and pathological aspects, to which photographic plates are appended exhibiting influenza bacilli.

Among the conclusions confirmed by the present report are the small influence of locality, or environment, and the invariably potent factors of exposure or proximity to the sick, and bad ventilation. Over and over again serious epidemics in a town or island have been traced to the arrival of one or two persons from an infected place. With regard to the later epidemics, it would appear that the contagion of the disease, scattered broadcast, had "retained its vitality, but in a suspended or inconspicuous form, perhaps by transmission from one human being to another in a succession of mild sporadic cases, perhaps in some medium external to the human body." Recrudescence has taken place chiefly in early spring and in autumn. Observers in various parts of the world have contributed their experience that the progress of influenza in a country is gradual. The most remarkable instances of rapid and wide diffusion were in the United States, especially in the Western States and to settlements far apart.

A good example of the usual manner of spread is given in Part IV. A teacher of music visited two relatives ill with influenza on April 6, and returned to his own locality, which had been hitherto unaffected. On April 9 he was attacked, but struggled through his work, and gave lessons to pupils at several houses. On April 11, ten of his pupils, and on April 12, the people with whom he lodged, developed the disease.

One medical officer states that he recollects no instance of the disease spreading from one member of a household to others where strict precautions for isolation and disinfection were taken. Unfortunately, however, it often happens that the first member attacked was not the only one who had been previously exposed to infection. Dr. Newsholme, medical officer for Brighton, states that the borough sanatorium, being very strictly isolated in every respect, escaped during the first two outbreaks, and in the third until a servant who had been absent

<sup>1</sup> Further report and papers on Epidemic Influenza, 1889-92. With an introduction by the Medical Officer of the Local Government Board. 1893.

returned and fell ill with influenza; strict isolation was even then successful in preventing its spread to the inmates.

Dr. Caldwell Smith's evidence as to ætiology is valuable and interesting. "It is to the life history of Pfeiffer's bacillus that we must direct our attention if we wish to understand the seemingly strange vagaries of the disease. An individual is infected by breathing at once the expired air from a person suffering from the disease, and I believe this to be the only method of infection."

The concourse of people is favourable to the spread of influenza in two ways, according to Dr. Parsons: firstly, by bringing the affected and the healthy near together; and secondly, by the poison being present in a more concentrated form in confined and vitiated air.

Among the discussions which throw light on the character of the disease, and bear upon the means of prevention, the following may be mentioned: on the degree of protection afforded to individuals and to communities by previous attacks, on the influence of occupation and of un-sanitary conditions, on the connection with pneumonia, on the period of infectiousness, on the clinical features of the later epidemics, and on relapses.

The researches of Dr. Klein, in respect to the effect of inoculation upon animals, gave results for the most part negative. His affirmative results, however, were "in full agreement with the results obtained by Pfeiffer and Kitasato." The bacillus was always abundantly present in the bronchial secretion of patients suffering from influenza, diminishing in number as the disease abated.

"It is to be feared," wrote Dr. Parsons, "that the contagion of influenza is still domiciled among us, and that a renewal of its epidemic activity within the next few years is by no means improbable." The expected revival is now only too apparent. A certain proverb declares, with the rashness of its class, that the man once bit is twice shy. In a literal sense, the saying may contain a good deal of truth, but to nations, or aggregations of individuals, it is quite inapplicable. The development of common sense for common action against these evils has still to take place. This country has now passed through three severe epidemics of influenza within four years, each outbreak drawing many sad maladies in its train, prostrating hundreds of thousands of breadwinners, cutting short many illustrious lives, and crippling many for years to come, and we are now running into a fourth epidemic in London, without any great organised attempt being made to counteract it.

The provisional memorandum of the Local Government Board, issued on January 23, 1892, impressed upon the public the fact that in its epidemic form influenza is an eminently infectious complaint, communicable in the ordinary personal relations of individuals with each other, that separation of the sick from the healthy should as far as practicable be carried out, that rooms, &c. should be disinfected, and that ventilation should receive special attention.

It would be some defence against a serious recrudescence of the pest if this memorandum, or an abstract of it, were supplied to every household on the first threatenings of an outbreak in any locality. In his article on prophylaxis, Dr. Parsons remarks on the difficulties which would frustrate any measures of notification and isolation on a large scale, but suggests that notification, with fees for early cases only, might be tried in certain districts, and that such a measure should be adopted "in the interval before another epidemic." So much experience has been gained in distinguishing the symptoms of influenza from those of other ailments, that the difficulty of diagnosis cannot now be an insuperable bar to attempts at prevention. It is well to remember that the pecuniary cost of prevention cannot be compared with the loss to the country by an epidemic, for this has been proved to amount to millions.

Among places and means of infection which may cause much mischief, but are not noticed in this volume, are bakers' shops, in which the baker or attendant suffers from influenza or severe cold; booking offices, post offices, banks, &c. in which the mouth and the ledger, &c. are in multiple communication; letters written and fastened by patients; and, most of all, railway carriages packed full and with windows closed, daily conveying vast numbers of people to and from the city, and containing perhaps the most organically polluted air which can easily be found in a civilised country.

The report closes with an interesting statement respecting the immunity of animals, including monkeys, at the Zoological Gardens.

R. RUSSELL.

ON A METHOD OF SEPARATING THE MINERAL COMPONENTS OF A ROCK.

IT is told of a famous German petrographer, that whenever appealed to by a student in difficulties over a problematical mineral in a rock-slice, his invariable advice was "Get it out."

It is hard dispassionately to reflect on the sufferings to which this simple process of "getting it out" have given rise. All we petrographers have passed through the vale! May we now indulge the pious hope that the following simple apparatus may bring some mitigation to the ordeal? It will certainly save a good deal of time and trouble when only small quantities of a particular mineral are required; enough, that is, for a blow-pipe analysis, a flame test, and microscopical examination.

A large test-tube (see Fig.), conveniently six inches in length by three-quarters in diameter, is filled with heavy solution, graded from specific gravity 3.3 to 2.5, so as to form after standing a diffusion column, as already described in NATURE, vol. xliii. p. 404, 1891. It is not necessary to wait till the change in density of the column is uniform from top to bottom; by introducing a sufficient number of specific gravity indexes the column is mapped out into a succession of lengths, within the limits of each of which the change of density is practically uniform, certainly sufficiently so for mineral determinations.

A fragment of the rock to be examined, about the size of a hazel-nut, is powdered in the usual way, sifted and washed, dried and then introduced into the diffusion column. Separation of the constituent minerals at once begins to take place, and in the course of a few hours is complete. Each species of mineral is then floating in liquid of its own specific gravity; the next problem is to get it out. A pipette as commonly used is not sufficient, for as it is introduced grains of minerals from other zones than that sought for, adhere to its sides; on removing the finger, the sudden inrush of fluid carries with it grains from surrounding zones, and finally on drawing up the pipette, fluids of zones lying above that to which it has descended displace the heavier fluid it already contains, carrying with them suspended grains, and thus bringing about the mixture which it is our desire to prevent.

With very little trouble these difficulties may be completely overcome. To prevent the sudden inrush of fluid the pipette, which should be of small calibre (in my experiments it measures 1.5 mm.), is fitted with a piston (A). This may be very simply made by winding a little unravelled cotton thread round the end of a stem of Esparto grass, such as is sold for cleaning tobacco-pipes. The piston is pushed down to the bottom of the pipette, which is then ready for use.

To extract grains from any zone the pipette is slid down into the diffusion column till its lower end is just immersed in the zone; a gentle shake given to it as it passes through the solution will serve to detach adhering particles; the piston is then slowly raised, and the fluid with its floating mineral grains quietly follows it, the other zones remaining undisturbed. To prevent the fluid of higher zones entering the pipette as it is withdrawn, it is necessary to plug its lower end; no very tight closure is necessary, since the piston, which now lies at the upper end of the pipette, by excluding the air ensures the retention of the contained column of fluid; all that is needed is a stopper, which will exclude solid particles. A very thin glass rod is rounded off at one end, which is then bent upwards into the form of a crook (C). The crook is let down into the diffusion column till its upward pointing lower end lies beneath the open extremity of the pipette, which it completely blocks up on being



A test-tube containing a diffusion column. The figures at the side indicate corresponding specific gravities: A, pipette fitted with a piston; B, crook by which the lower end of the pipette may be plugged.

raised into position. The pipette with the crook is then taken out of the fluid, and inverted. The crook is laid aside, and the outside of the pipette cleaned with blotting-paper, by which all adhering foreign grains are removed. The pipette now contains a pure gathering of the mineral required, and it only remains to discharge its contents, and this is of course accomplished by pushing down the piston.

Minerals may thus be removed from every zone of a diffusion column; and all the species which enter into the composition of a rock, except of course the very heaviest, may be separately obtained, with their specific gravity determined as an incident of the process.

In this absurdly simple fashion "getting it out" ceases to be a penance, and becomes a pleasure. W. J. SOLLAS.

### THE CLOUDY CONDENSATION OF STEAM.

THE air, as every one knows, is composed almost entirely of the two gases, oxygen and nitrogen. It also contains small quantities of other substances, of which the chief are carbonic acid gas and water vapour, and it is the latter of these constituents, water vapour, or "steam," as it is sometimes called, that will principally concern us this evening.

The quantity of invisible water vapour which the air can at any time take up depends upon the temperature; the higher the temperature of the air the more water it can contain. The proportion, however, never exceeds a few grains' weight of water to a cubic foot of air. Air at any temperature, containing as much water as it can possibly hold, is said to be "saturated," while the temperature at which air containing a certain proportion of water becomes saturated is called the "dew point."

The large glass globe, upon which the beam from the electric lantern is now directed, contains ordinary air, kept in a state of saturation, or nearly so, by the presence of a little water. You will observe that although heavily laden with water vapour the air is perfectly transparent. If, now, we turn a tap, and so connect the globe with an exhausted receiver, the air expands and becomes colder; the space inside the globe is no longer able to hold the same quantity of water as before in the form of vapour, and the excess is precipitated as very finely divided liquid water, which fills the globe and is perfectly visible as a cloud or mist. In a few minutes the cloud disappears, partly, no doubt, because some of the particles of water have fallen to the bottom of the vessel, but chiefly because the air becomes in time warmed up to its original temperature (that of the room), and the suspended water is converted back again into invisible vapour.

I once more rarefy the air, and admit a fresh supply while holding the flame of a spirit lamp near the orifice of the inlet pipe, so that some of the burnt air is carried into the interior of the globe. When the air is again expanded a cloud is formed which is far more dense than the others were. It appears on examination that the increased density of this cloud is not due to the condensation of a greater quantity of water. Little, if any, more water is precipitated than before. But the water particles are now much more numerous, their increased number being compensated for by diminished size. Within certain limits, the greater the number of particles into which a given quantity of water is condensed, the greater will be the apparent thickness of the mist produced. A few large drops will not impede and scatter light to the same extent as a great number of small ones, though the actual quantity of condensed water may be the same in each case.

Then comes the question, why should the burnt air from the flame so greatly increase the number of the condensed drops? An answer, though perhaps not quite a complete one, is furnished by some remarkable experiments made by M. Coulier, a French professor, nearly twenty years ago. He believed his experiments showed that water vapour would not condense at all, even at temperatures far below the dew point, unless there were present in the air a number of material particles to serve as nuclei around which the condensation would take place. All air, he says, contains dust; and anything that increases the number of dust particles in the air increases the density of the condensation by affording a greater number of nuclei. Air in which a flame had been burnt he supposed to be very highly charged with finely divided matter, the products of combustion,

<sup>1</sup> Extracted from a lecture on "Fogs, Clouds, and Lightning," delivered at the Royal Institution on May 5.

and thus rendered extraordinarily "active" in bringing about condensation. And that, according to Coulier's view, is the reason why such a dense fog was formed when air which had been contaminated by the spirit flame was admitted to our globe.

On the other hand, air, even burnt air, which has been filtered through tightly packed cotton wool, is found to be perfectly inactive. No cloud or mist will form in it, however highly it may be supersaturated. Coulier explained this fact by supposing that the process of filtration completely removed all dust particles from the air.

The experiments of Coulier were repeated and confirmed by Mascart. The latter also made one additional observation which may very probably turn out to be of great importance. He found that ozone, or rather, strongly ozonised air, was a very active mist producer, and that unlike ordinary air, it was not deprived of its activity by filtration.

Four or five years later, all the facts which had been noticed by Coulier, and others of an allied nature, were independently discovered by Mr. Aitken, who has devoted much time and study to them, and made them a foundation of an entirely new branch of meteorology.

Later, perhaps, we may see reason to doubt whether all the conclusions of Coulier and Aitken are quite accurate, especially as regards the action of so-called products of combustion.

Every one has noticed how dense and dark a thundercloud is. It shuts out daylight almost as if it were a solid substance, and the glimmer that penetrates it is often imbued with a lurid or copper-coloured tint.

I had always found it rather difficult to believe that these peculiarities were due simply to the unusual extent and thickness of the clouds, as is commonly supposed to be the case, and it occurred to me about three years ago, that perhaps some clue to the explanation might be afforded by the electrification of a jet of steam. On making the experiment I found that the density and opacity of the jet were greatly increased when an electrical discharge was directed upon it, while its shadow, if cast upon a white screen by a sufficiently strong light, was of a decidedly reddish-brown tint.

As a possible explanation of the effect I suggested that there might occur some action among the little particles of water of a similar nature to that observed by Lord Rayleigh in his experiments upon water jets. A jet of water two or three feet long is made to issue in a nearly vertical direction from a small nozzle. At a certain distance above the nozzle the continuous stream is found to break up into separate drops, which collide with one another, and again rebounding, become scattered over a considerable space. But when the jet is exposed to the influence of an electrified substance, such as a rubbed stick of sealing-wax, the drops no longer rebound after collision, but coalesce, and the entire stream of water, both ascending and descending, becomes nearly continuous.

There is one other point to which I wish to direct your particular attention. If the sealing-wax, or better, the knob of a charged Leyden jar, is held very close to the jet, so that the electrical influence is stronger, the separate drops do not coalesce as before, but become scattered even more widely than when no electrical influence was operating. They become similarly electrified and, in accordance with the well-known law, repel one another.

We will now remove the water jet, and in its place put a little apparatus for producing a jet of steam. It consists of a half-pint tin bottle, through the cork of which passes a glass tube terminating in a nozzle. When the water in the bottle is made to boil, a jet of steam issues from the nozzle, and if we observe the shadow of the steam jet upon the screen we shall see that it is of feeble intensity and of a neutral tint, unaccompanied by any trace of decided colour. A bundle of needles connected by a wire with the electrical machine is placed near the base of the jet, and when the machine is worked electricity is discharged into the steam. A very striking effect instantly follows. The cloud of condensed steam is rendered dense and dark, its shadow at the same time assuming the suggestive yellowish-brown colour.

I at first believed that we had here a repetition, upon a smaller scale, of the phenomenon which occurs in the water jet. The little particles of condensed water must frequently come into collision with one another, and it seemed natural to suppose that, like Lord Rayleigh's larger particles, they rebounded under ordinary circumstances, and coalesced when under the influence



of electricity. The great majority of the small particles ordinarily formed consisted, I thought, of perhaps only a few molecules, which were dispersed in the air, and again converted into vapour without ever having become visible, while the larger particles formed by their coalescence under electrical action were of such dimensions as to impede the more refrangible waves of light. Hence the brownish-yellow colour.

Other explanations have been proposed. There is the molecular shock theory of the late R. Helmholtz (who, as it turned out, had studied electrified steam jets before I made my own experiments). I shall refer to his speculation later. And there is the dust-nucleus theory, which no doubt appears a very obvious one.

Though I knew that my own hypothesis was not quite free from objection, neither of these alternative ones commended itself to me as preferable; and so the matter rested until a few months ago, when the steam jet phenomenon was discussed anew in a paper communicated to the Royal Society by Mr. Aitken. Mr. Aitken said that he did not agree with my conjecture as to the nature of the effect. This led me to investigate the matter again, and to make some further experiments, the results of which have convinced me that I was clearly in error. At the same time it seems to me that the explanation which Mr. Aitken puts forward is little less controvertible than my own. Mr. Aitken's explanation of the phenomenon is, like mine, based upon Lord Rayleigh's work in connection with water-jets; but, unlike mine, it depends upon the experiment which shows that water particles when strongly electrified are scattered even more widely than when unelectrified. He believes, in short, that electrification produces the effect, not by promoting coalescence of small water particles, but by preventing such coalescence as would naturally occur in the absence of electrical influence. In the electrified jet, he says, the water particles are smaller, but at the same time more numerous; thus its apparent density is increased.

The chief flaw in my hypothesis lies in the fact that the mere presence of an electrified body like a rubbed stick of sealing-wax, which is quite sufficient to cause coalescence of the drops in the water jet, has no action whatever upon the condensation of the steam jet. There must be an actual discharge of electricity. But it is by no means essential, as Mr. Aitken assumes, that this discharge should be of such a nature as to electrify, positively or negatively, the particles of water in the jet. If, instead of using a single electrode, we employ two, one positive and the other negative, and let them spark into each other across the jet, dense condensation at once occurs. So it does if the two discharging points are removed quite outside the jet. A small induction coil giving sparks an eighth of an inch in length causes dense condensation when the electrodes are more than an inch distant from the nozzle and on the same level. In one experiment a brass tube two feet long was fixed in an inclined position with its upper end near the steam jet, and its lower end above the electrodes of the induction coil. In about three seconds after the spark was started dense condensation ensued, and it ceased about three seconds after the sparking was stopped. No test was needed, though in point of fact one was made, to show that the steam was not electrified to a potential of a single volt by this operation. And the time required for the influence to take effect showed that whatever this influence might be it was not induction.

The inference clearly is that in some way or other the action is brought about by the air in which an electrical discharge has taken place, and not directly by the electricity itself. The idea has no doubt already occurred to many of you that it is a dust effect. Minute particles of matter may be torn off the electrodes by the discharge, and form nuclei upon which the steam may condense. The experiments of Liveing and Dewar have indeed shown that small particles are certainly thrown off by electrical discharge, and the idea that such particles promote condensation appears to be supported by the fact that if a piece of burning material, such as touch-paper, is held near the jet so that the products of combustion can pass into it, thick condensation is produced.

From a recent paper by Prof. Barus, published in the *American Meteorological Journal* for March, it appears that he also is of opinion that such condensation is in all cases due to the action of minute dust particles. Yet it is remarkable that Mr. Aitken, the high priest and chief apostle of the philosophy of dust, gives no countenance to the nucleus theory. He does not even advert to its possibility. I imagine that his experi-

ments have led him, as mine have led me, to the conclusion that it is untenable. And this not only in the case of electrical discharge, but also in the case of burning matter.

If we cause an electrical discharge to take place for some minutes inside a suitably arranged glass bottle, and then, ten or fifteen seconds after the discharge has ceased, blow the air from the bottle into the steam jet, the condensation is not in any way affected. Yet the dust could not have subsided in that time. And again, if we fill another large bottle with dense clouds of smoke by holding a bundle of burning touch-paper inside it, and almost immediately after the touch-paper is withdrawn, force out the smoke-laden air, through a nozzle, upon the jet—you can all see the black shadow of the smoke upon the screen—nothing whatever happens to the jet. Yet a mere scrap of the paper which is actually burning, though the ignited portion may not be larger than a pin's head, at once darkens the jet. Dead smoke (if I may use the term) exerts little or no influence by itself; there must be incandescent matter behind it. The question naturally arises, whether incandescent matter may not be sufficient of itself, without any smoke at all. We can test this by making a piece of platinum wire red-hot and then holding it near the jet. It is seen to be quite as effective as the burning touch-paper. Yet here there can be no nuclei formed of products of combustion, for there is no combustion; there is simply ignition or incandescence.

One other point I may mention. It is stated by Barus, in the paper above referred to, that the fumes given off by a piece of phosphorus constitute a most efficient cause of dense condensation. This is true if they come directly from a piece of phosphorus; but if phosphorus fumes are collected in a bottle and then directed upon the jet, all traces of unoxidised phosphorus being first carefully removed, they are found to be absolutely inoperative. Phosphorus in air can hardly be said to be incandescent, though it is luminous in the dark; but it appears to act in the same manner as if its temperature were high.

All these facts seem to indicate that the several causes mentioned, electrical, chemical, and thermal, confer upon the air in which they act some temporary property—certainly not due to mere inert dust—in virtue of which it acquires an abnormal power of promoting aqueous condensation.

I thought that possibly some clue as to the nature of this property might be obtained by observing how some other gases and vapours behaved; but though the experiments I made perhaps tend to narrow the dimensions of the mystery, I cannot say that they have completely solved it. Indeed some of the results only introduce additional perplexities.

One of the most natural things to try is hydrochloric acid, which is known to have a strong affinity for water. If we heat a little of the acid solution in a test tube, closed with a cork, through which a glass tube is passed, and direct the issuing stream of gas upon the jet, the densest condensation results. The vapours of sulphuric and nitric acids also cause dense condensation, and I suppose both of these have an affinity for water. But so also, and in an equally powerful degree, does the vapour of acetic acid; yet the affinity of this acid for water, as indicated by the heat evolved when the two are mixed, is very small.

Ammonia gas, when dissolved in water, causes the evolution of much heat. Yet a stream of this gas directed upon the jet has no action.

Ozonised air, which Mascart found so effective in his experiments with the closed vessel, is quite inoperative with the steam jet. Equally so is the vapour of boiling formic acid, which I believe is chemically a much more active acid than acetic, and has a lower electrical resistance. (See Table.)

#### CONDENSATION OF STEAM JET.

##### *Active.*

Air, oxygen, or nitrogen, in which electrical discharge is occurring.

- Burning and incandescent substances.
- Fumes from phosphorus.
- Hydrochloric acid.
- Sulphuric acid vapour.
- Nitric acid vapour.
- Acetic acid vapour.

*Inactive.*

Air, &c., in which electrical discharge has ceased for about ten seconds.

Smoke without fire.  
Bottled phosphorus fumes.  
Ammonia.  
Ozone.  
Steam.  
Alcohol vapour.  
Formic acid vapour.  
Sulphurous acid.

It seems that we have here a pretty little problem which might, perhaps, be solved without much difficulty by a competent chemist, but which quite baffles me.<sup>1</sup> Is it possible that the condensing vapours may contain dissociated atoms?

To return to the electrical effect. There are only two kinds of chemical change that I know of which could be brought about in air by an electrical discharge. Either some of the oxygen might be converted into ozone, or the oxygen and nitrogen of the air might be caused to combine, forming nitric acid or some such compound. The former of these would not account for the action of the air upon the jet, because, as we have seen, ozone is inoperative; the latter might. But if the activity of the air is due to the presence in it of a compound of oxygen and nitrogen, then it is clear that an electrical discharge in either nitrogen or oxygen separately would fail to render those gases active.

I arranged a spark bottle, inside which an induction-coil discharge could be made to take place; two bent tubes were passed through the cork, one reaching nearly to the bottom for the ingress of the gas to be tested, the other, a shorter one, for its egress. The open end of the egress tube was fixed near the steam jet, and first common air, then oxygen and then nitrogen were successively forced through the bottle while the coil discharge was going on. All produced dense condensation, but I thought that oxygen appeared to be a little more efficient than common air, and nitrogen a little less.

This last experiment points to a conclusion to which at present I see no alternative. It is that the action on the jet of an electrical discharge is due in some way or other to dissociated atoms of oxygen and nitrogen. There is nothing else left to which it can be due.

So far as Robert Holmholtz's explanation coincides with this conclusion, I think it must be accepted as correct. As to the precise manner in which he supposed the dissociated atoms to act upon the jet, it is more difficult to agree with him. He thought that the abnormal condensation was a consequence of the molecular shock caused by the violent recombination of the dissociated atoms in the supersaturated air of the jet, the action being analogous to that which occurs when a supersaturated solution of sulphate of soda, for example, is instantly crystallised by a mechanical shock.

To me this hypothesis, ingenious as it is, seems to be more fanciful than probable, but I can only hint very diffidently at an alternative one. To many chemical processes the presence of water is favourable or even essential. Is it possible that the recombination of free atoms may be assisted by water? And is it possible that dissociated atoms in an atmosphere of aqueous vapour may obtain the water needed for their union by condensing it from the vapour?

According to Holmholtz, flames and incandescent substances generally cause dissociation of the molecules of oxygen and nitrogen in the surrounding air. This, I believe, is generally admitted. I do not know whether slowly oxidising phosphorus has the same effect.

If it is conceded that the atmospheric gases are dissociated by electrical discharges, and that the presence of such dissociated gases somehow brings about the dense condensation of water vapour, we may still regard the electrified steam jet as affording an illustration of the abnormal darkness of thunder-clouds.

Perhaps another source of dissociated atoms is to be found in the ozone which is generated by lightning flashes. A molecule of ozone consists of three atoms of atomic oxygen, while one of ordinary oxygen contains only two. Ozone is an unstable kind of material, and gradually relapses into ordinary oxygen, the process being that one atom is dropped from the three-atom molecules of ozone, these detached atoms in course of time

uniting with one another to form pairs. Thus two molecules of ozone are transformed into three of oxygen. A body of ozone is therefore always attended by a number of dissociated atoms which are looking for partners.

In the steam jet experiment there is not time for the engagement of a sufficient number of isolated atoms from a blast of ozone to produce any sensible effect. But the case is otherwise when the vapour is confined in a closed vessel, as in Mascart's experiment, or when it occurs in the clouds, where the movement of air and vapour is comparatively slow.

Ozone, it will be remembered, was found by Mascart to produce dense condensation in a closed vessel even after being filtered through cotton wool. Similar filtration seems to entirely deprive the so-called products of combustion of their active property, a fact which has been adduced as affording overwhelming evidence in favour of the dust nucleus theory. Coulier himself, however, detected a weak point in this argument. He produced a flame which could not possibly have contained any products of combustion except steam, by burning pure filtered hydrogen in filtered air; yet this product was found to be perfectly capable of causing dense condensation, and, as in his former experiments, filtration through cotton wool deprived it of its activity.

These anomalies may, I think, be to a great extent cleared up if we assume that the effect of the cotton wool depends, not upon the mere mechanical obstruction it offers to the passage of particles of matter, but upon the moisture which it certainly contains, and which may act by attracting and facilitating the reunion of dissociated atoms before they reach the air inside the vessel. According to this view ozone would remain an active condenser in spite of its filtration, because free atoms would continue to be given off by it after it had passed the cotton wool. The filtration experiment should be tried with perfectly dry cotton wool, which, however, will not be easily procured, and if my suggestion is right, dry wool will be found not to deprive ordinary products of combustion of their condensing power.

To sum up. I think my recent experiments show conclusively that the dense condensation of the steam jet is not due directly either to electrical action or to dust nuclei. The immediate cause is probably to be found in dissociated atoms of atmospheric gases, though as to how these act we can only form a vague guess.

SHELFORD BIDWELL.

## SCIENTIFIC SERIALS.

*American Journal of Science*, December.—An apparent time-break between the eocene and Chattahoochee miocene in south-western Georgia, by Raphael Pumpelly. The Red Clay Hill region, a plateau extending through the south-western part of Georgia and adjacent northern Florida, has a maximum altitude of 300 feet, is sharply limited on the north by a declivity facing the eocene flat-land country, and consists of miocene deposits resting on eocene, both of which dip about 13 feet per mile to the south. The base of the plateau is formed by the white calcareous beds of the Chattahoochee group. A time-break between the latter and the eocene is evidenced by the almost general presence of a limestone conglomerate at the base of the Chattahoochee, immediately overlying eocene fossils, and the irregularity of the surface of demarcation. It seems possible that during miocene time the present plateau of southern Georgia was outlined by submerged islands of the eocene limestone. The Gulf Stream, after the creation of the central American barrier, found its way back to the Atlantic sweeping over southern Georgia and northern Florida, and supplying the food needed to build up the great organic beds of the Chattahoochee and Chipola. The lower flat-land country of central Georgia may represent the contemporaneous course of the cold current carrying less pure water and less nutriment.—The rise of the mammalia in North America, by H. F. Osborn. This second part deals with ancient and modern placental differentiation, the succession of the perissodactyls and the artiodactyls, a discussion of the factors of evolution, and a diagram illustrating the supposed descent of the mammalia from their jurassic prototypes.—On the thoracic legs of *Triarthrus*, by C. E. Becher. Some very perfect specimens of *Triarthrus Bechi*, Green, in which nearly the entire calcareous and chitinous portions are represented by a thin film of iron pyrites, show, besides the antennæ already noticed, a complete series of thor-

<sup>1</sup> Two chemists of the highest eminence have been good enough to consider the problem for me, but they are unable to throw any light upon it.

acic legs becoming shorter towards the pygidium, but without any essential differences amongst each other. Each limb consists of two nearly equal members, one of which was evidently used for crawling, and the other for swimming. These two members and their joints may be correlated with certain typical forms of Crustacean legs among the *Schizopoda*, *Cumacea*, and *Decapoda*, and may be described in the same terms.—On the diamond in the Cañon Diablo meteoric iron and on the hardness of carborundum, by George F. Kunz and Oliver W. Huntington. The carborundum made by Mr. Acheson, of Pittsburg, is capable of scratching most varieties of corundum, but not the diamond.

### SOCIETIES AND ACADEMIES.

#### LONDON.

**Anthropological Institute**, December 12.—Prof. A. Macalister, F.R.S., President, in the chair.—Mr. Cuthbert E. Peek exhibited some specimens of fishing-line made of human hair, some needles constructed from ribs of feather, and two message-sticks from the extreme north of Queensland.—Mr. W. L. Duckworth read a paper on the collection of skulls of Aboriginal Australians in the Cambridge University Museum, and the following papers were also read:—On an unusual form of rush basket from the northern territory of South Australia, by Mr. R. Etheridge, jun.—On a modification of the Australian Aboriginal weapon, termed the *leonile*, *langeel*, *bendi* or *buccan*, by Mr. R. Etheridge, jun.—An Australian Aboriginal musical instrument, by Mr. R. Etheridge, jun.—The Aborigines of North-West Australia, by Mr. P. W. Bassett-Smith.—Rites and customs of Australian Aborigines, by Mr. H. B. Purcell.—Japanese onomatopes and the origin of language, by Mr. W. G. Aston.

**Mathematical Society**, December 14.—A. B. Kempe, F.R.S., President, in the chair.—On the stability of a deformed elastic wire, by A. B. Basset, F.R.S.—This paper commences with a discussion of the different methods of determining the stability of a deformed elastic wire which is in equilibrium, and then proceeds to discuss two special problems. When a naturally straight wire is deformed into a helix having  $m$  convolutions, the helical form is unstable unless its pitch is greater than  $\sec^{-1} 2 m$ . This result shows that it is impossible to deform the wire into a helix of *small* pitch and having a great many convolutions, such as the spring of an ordinary spring-balance, unless the wire is given a permanent set. The two special cases in which the terminal stresses consist, (1) of a thrust and a flexural couple, (2) of a couple alone, are also noticed; and in the latter case the helix is unstable when the length of the wire exceeds half a convolution. When the natural form of the wire is a circular coil, which is unrolled and the ends joined together without twist, so that the wire forms a circular ring, the ring will be unstable when the length of the wire is greater than about one and a half convolutions. The ring is stable from displacements in its plane, and consequently will not collapse like a boiler flue; but it is unstable for displacements perpendicular to its plane, which involve torsion as well as flexion. The stable figure will consequently consist of a closed tortuous curve.—Papers were also read by R. J. Dallas, on the linear automorphic transformations of certain quantics; and by Dr. Hobson, F.R.S., on Bessel's functions and relations connecting them with spherical and hyperspherical harmonics.—Messrs. Love, Greenhill, Macmahon, and the President spoke on the subject of the communications.—The following papers were taken as read:—A theorem of Liouville's, by Prof. G. B. Mathews; note on non Euclidian geometry, by H. F. Baker; note on an identity in elliptic functions, by Prof. L. J. Rogers; and note on a variable seven-points circle analogous to the Brocard circle of a plane triangle, by J. Griffiths.

**Royal Meteorological Society**, December 20.—Dr. C. Theodore Williams, President, in the chair.—Mr. C. Harding gave an account of the great storm of November 16 to 20, 1893. This storm was the most violent of recent years, and, so far as anemometrical records are concerned, the wind attained a greater velocity than has previously been recorded in the British Islands. The velocity of the wind was 96 miles in the hour from 8.30 to 9.30 p.m. on November 16 in the Orkneys,

where the hurricane burst with such suddenness that it is described as like the shot of a gun, and the wind afterwards attained the very high rate of 90 miles and upwards, in the hour, for 5 consecutive hours. At Holyhead the storm was terrific; the anemometer recorded a wind velocity of 89 miles in the hour, and it was 80 miles or above for 11 hours, while the force of a whole gale, 65 miles an hour and upwards, was maintained for 31 hours, and for  $4\frac{1}{2}$  days the mean hourly velocity was 54 miles. Many of the gusts were at the rate of 115 miles an hour, and at Fleetwood a squall occurred with the wind at the rate of 120 miles in the hour. The storm was felt over the entire area of the United Kingdom, and the wreck returns show that disasters occurred with almost equal frequency on all coasts. Four weeks after the storm the official records gave the total loss of life on our coasts as 335, while there were 140 vessels which had been abandoned, or had foundered, stranded, or met with other severe casualty, involving either loss of life, or saving of life by some extraneous assistance. There were 600 lives saved on our coasts by aid of the Lifeboat Institution and other means. The author has tracked the storm from the neighbourhood of the Bahamas on November 7, across the Atlantic and over the British Islands to Central Europe on November 20.—The other papers read were on rainfall and evaporation observations at the Bombay Waterworks, by Mr. S. Tomlinson; and on changes in the character of certain months, by Mr. A. E. Watson.

#### DUBLIN.

**Royal Dublin Society**, November 22.—Prof. W. N. Hartley, F.R.S., in the chair.—Prof. T. Johnson communicated a paper on the systematic position of the *Bangiaceæ*. The author, with Berthold and others, regards the group as true *Florideæ*, and discusses in his paper the views expressed by Schmitz, in a recent number of *La Nuova Notarisia*, against their *Floridean* nature.—Mr. Thomas Preston gave an elementary explanation of the system of waves attending a bullet moving at a high speed through the atmosphere.—Mr. W. E. Adeney read a note on the present condition of the water in the Vartry reservoir at Roundwood, co. Wicklow, and Mr. Richard J. Moss gave the results of an examination of the Vartry water as at present supplied to Dublin.

#### PARIS.

**Academy of Sciences**, Annual Public Meeting, December 18.—M. de Lacaze-Duthiers in the chair.—After some commemorative words on the deaths of Sir Richard Owen, Kummer, and de Candolle, Foreign Associates, and those of Chambrelent, Admiral Pâris and Charcot, Members of the Academy, by the President, M. Bertrand, one of the Secretaries, announced the names of those to whom prizes had been awarded. In *Geometry*, the Prix Francœur was awarded to M. G. Robin for mathematical physics, and the Prix Pocelet to M. G. Kœnigs, for geometrical and mechanical work.—*Mechanics*: The extraordinary prize of 6000 francs offered by the Département de la Marine for contrivances increasing the efficiency of the Navy, was distributed among M. Bourdelles (for lighthouse illumination), M. Lephy (compass with luminous index), and M. de Frayssieix (system of optical pointing); the Prix Montyon of 700 francs to M. Flamant (hydraulics), the Prix Plumey of 2500 francs to M. Lebasteur (steam engine appliances); the Prix Fourneyron of 500 francs, to M. Brousset (fly-wheels).—*Astronomy*: The Prix Lalande of 540 francs, to M. Schulhof (Comets); the Prix Valz of 460 francs, to N. Berberich (Minor Planets). The Prix Janssen of a gold medal, to Mr. Samuel Langley (Astronomical Physics).—*Physics*: The Prix La Caze of 10,000 fr., to M. E. H. Amagat (gases and liquids).—*Statistics*: The Prix Montyon of 500 fr., to Dr. Marvand (diseases of soldiers).—*Chemistry*: The Prix Jecker of 10,000 fr., to M. D. Forcrand and M. Griner in equal parts, with a special prize to M. Gautier.—The Prix La Caze of 10,000 fr., to M. Lemoine (Phosphorus Compounds).—*Mineralogic and Geology*: The Grand Prix, to M. Marcellin Boule (The Central Plateau of France). The Prix Bordin of 3000 fr. was distributed amongst MM. Bourgeois, Gorgen, Michel, and Duboin for their researches in mineral synthesis. The Prix Delesse of 1400 fr., to M. Fayol (Commentary Strata). The Prix Fontannes of 2000 fr., to M. R. Zeiller (Palæontology).—*Botany*: The Prix Desmazières of 1600 fr., to M. C. Sauvageau (Algæ). The Prix Montagne, to MM. Cardot (Mosses) and Gaillard (Fungi).—*Agriculture*: The Prix

Morogues, to M. Millardet (Mildew).—*Anatomy and Zoology*. The Prix Thore, to M. Corbière (Muscinee)—*Medicine and Surgery*: The Prix Montyon was distributed between MM. Huchard (Heart Diseases), Delorme (Army Surgery), and Pinard and Vernier (Pathological Atlas). The Prix Barbier, 500 fr. each to MM. Sanson (Heredity) and Dr. Mauclair (Osteo-Arthritis). The Prix Bréant, being the interest on a sum of 100,000 francs offered for a cure for cholera, was distributed amongst MM. Netter and Thoinot (French Cholera, 1892) and MM. Grimbret and Burlureaux (Treatment of Tuberculosis by Creosote Injections). The Prix Godard of 1,000 francs, to Dr. Tourneux (Physiological Atlas). The Prix Serres of 7500 francs, to M. Pizon (Blastogenesis), with small portions to MM. Sabatier (Spermatogenesis) and Letulle (Inflammation). The Prix Bellion, of 1400 francs, to Dr. C. Chabric (Physiology of the Kidney) and Dr. Coustan (Fatigue). The Prix Mège to Dr. Herrgott (History of Obstetrics). The Prix Lallemand of 1800 francs, to M. Trolard (Venous System).—*Physiology*: The Prix Montyon of 750 francs, to M. Laulanié (Respiration) and MM. Abelous and Langlois (Renal Capsules). The Prix La Caze, of 10,000 francs, to M. d'Arsonval (Physiological Effects of Electricity). The Prix Pourat to M. E. Meyer (Renal Secretion). The Prix Martin-Damourette, of 1400 francs, to Dr. Gérard (Albuminuria).—*General Prizes*: The Arago Medal to Mr. Asaph Hall (Satellites of Mars) and Mr. E. E. Barnard (Jupiter's First Satellite). The Prix Montyon, for improvements in unhealthy industries, was divided between MM. Garros (Porcelain Manufacture) and Coquillon (Fire-damp Meter). The Prix Trémont, of 1100 francs, to M. Jules Morin for his useful hydrostatic and other inventions. The Prix Gegner of 4000 francs to M. Serret. The Prix Petit d'Ormoz of 10,000 francs, to M. Stieltjes (Mathematics), and another of the same amount to M. Marcel Bertrand (Physics of the Globe). The Prix Tchihatchef of 10,000 francs, to M. Grégoire Groum-Grschimailo (The Pamirs). The Prix Gaston Planté, of 3,000 francs, to M. Blondlot (Electric Interference). Mme. de Laplace's Prize, consisting of Laplace's works, to M. Bès de Berc, of the École Nationale des Mines.

BERLIN.

Physical Society, December 1.—Prof. Schwalbe, President, in the chair.—Prof. Neesen demonstrated a method of coating aluminium with other metals. This consists in dipping the aluminium in a solution of caustic potash or soda, or of hydrochloric acid, until bubbles of gas make their appearance on its surface, whereupon it is dipped into a solution of corrosive sublimate to amalgamate its surface. After a second dipping into caustic potash until bubbles of gas are evolved, the metal is placed in a solution of a salt of the desired metal. A film of the latter is rapidly formed, and is so firmly adherent that, in the case of silver, gold, or copper, the plate can be rolled out or polished. When coating with gold or copper, it is well to first apply a layer of silver. When thus treated the aluminium may be soldered with ordinary zinc solder.—Dr. Wien spoke on the entropy of radiation.

Meteorological Society, November 7.—Prof. von Bezold, President, in the chair.—Dr. Arendt spoke on the transport of heat by means of aerial currents on the earth's surface, based on calculations derived from material provided by the Hamburg station. He first determined for each month of the year the direction and rate of the wind, from which he calculated the resultant volume of air transported over Hamburg. From the temperature and speed of the winds he obtained, under certain assumptions, numerical values for the amount of heat carried towards Hamburg during each month of the year.

December 5.—Dr. Vettin, President, in the chair.—Prof. Hellmann presented a book on "Snow-crystals," and gave an account of its contents, during which he discussed fully the structure and classification of snow-crystals. All the crystals belong to the hexagonal system, and are either flat or columnar. The radiating stars, the plates, and mixed forms belong to the first category; while the prisms and much more rare pyramids belong to the second.—Dr. H. Meyer communicated the results of his observations, made in conjunction with Prof. Köppen, on the cloud-conditions of various climates. They had rejected as valueless mean values based on determinations which are largely influenced by the personal opinion of the observer, and had in preference calculated the frequency of the occurrence of clouds. They had in this, for simplicity's sake, distinguished between three groups: (1) Complete absence of clouds; cloudiness zero. (2)

Intermittent occurrence of clouds; cloudiness 1 to 9. (3) Total cloudiness represented by 10. Taking a series of stations in various climates, they had calculated and graphically represented the frequency of the three groups for the morning, midday, and evening for each month. It appeared that for Hamburg and the whole of middle and north Europe, in passing from the cold to the warm periods of both the day and year, the intermittent cloudiness increases: while complete cloudiness, which is most frequent in winter, and in the morning and evening, diminishes. Complete cloudlessness is always the most rare condition. The above characters change gradually towards the Mediterranean, even at Lesina, and more markedly at Alexandria. In mid-Asia, East Siberia, China, Batavia, and Rio Janeiro, and on the elevated station of Pike's Peak, and also on the Atlantic Ocean, the change in cloudiness in passing from winter to summer is reversed.

BOOKS and SERIALS RECEIVED.

BOOKS.—A Text-Book on Gas, Oil, and Air-Engines: B. Donkin, Jun. (Griffin).—An Elementary Treatise on Fourier's Series: Dr. W. E. Byerly (Boston, Ginn).—Umplanar Algebra: Dr. J. Stringham (San Francisco, Berkeley Press).—Science and Hebrew Tradition: T. H. Huxley (Macmillan).—Dictionary of the Active Principles of Plants: C. E. Sohn (Bailière).—The Country and Church of the Cheryble Brothers: Rev. W. H. Elliot (Selkirk, Lewis).—Hints to Travellers, 7th edition (Royal Geographical Society).—The Story of the Sun: Sir R. Ball (Cassell).  
SERIALS.—Insect Life, Vol. 6, No. 2 (Washington).—Cabinet Portrait Gallery, Part 52 (Cassell).—Astronomy and Astro-Physics, December (Wesley).—Economic Journal, December (Macmillan).—Journal of the Franklin Institute, December (Philadelphia).—Internationales Archiv für Ethnographie, Band vi. Heft 6 (Kegan Paul).—Journal of the Royal Microscopical Society, December (Williams and Norgate).—Royal Geographical Society, Supplementary Papers, Vol. III. Part 5 (Murray).

CONTENTS.

|                                                                                                                           | PAGE |
|---------------------------------------------------------------------------------------------------------------------------|------|
| Quaternions as an Instrument in Physical Research.<br>Prof. P. G. Tait . . . . .                                          | 193  |
| The Manufacture of Painter's Colours and Varnishes . . . . .                                                              | 194  |
| British Fungus Flora. By Dr. M. C. Cooke . . . . .                                                                        | 195  |
| Our Book Shelf:—<br>Dawson: "Some Salient Points in the Science of the Earth." . . . .                                    | 196  |
| Cvijić: "Das Karstphänomen."—T. G. B. . . . .                                                                             | 197  |
| Letters to the Editor:—<br>The Origin of Lake Basins.—R. D. Oldham, Dr. A. R. Wallace, F.R.S. . . . .                     | 197  |
| The Second Law of Thermodynamics.—G. H. Bryan . . . . .                                                                   | 197  |
| Flame.—Prof. Arthur Smithells . . . . .                                                                                   | 198  |
| The "Zoological Record."—R. I. Pocock; F. A. Bather . . . . .                                                             | 198  |
| On the Bugonia-Superstition of the Ancients—Baron C. R. Osten Sacken . . . . .                                            | 198  |
| The Earliest Mention of the Kangaroo in Literature.—Baron C. R. Osten Sacken . . . . .                                    | 198  |
| On an Undescribed Rudimentary Organ in Human Attire.—Prof. Marcus Hartog . . . . .                                        | 199  |
| Early Asterisms. III. By J. Norman Lockyer, F.R.S. . . . .                                                                | 199  |
| The Secondary Education Movement. By Sir H. E. Roscoe, M.P., F.R.S. . . . .                                               | 203  |
| The Sonnblück Mountain Observatory ( <i>Illustrated</i> ). Notes . . . . .                                                | 204  |
| Our Astronomical Column:—<br>Small Distances Measured with the Heliometer . . . . .                                       | 209  |
| The Tail of Comet Brooks (c 1893) . . . . .                                                                               | 210  |
| Hydrogen Envelope of the Star D.M. + 30°3639 . . . . .                                                                    | 210  |
| <i>L'Astronomie</i> for December . . . . .                                                                                | 210  |
| Geographical Notes . . . . .                                                                                              | 210  |
| Epidemic Influenza. By the Hon. R. Russell . . . . .                                                                      | 210  |
| On a Method of Separating the Mineral Components of a Rock. ( <i>Illustrated</i> ). By Prof. W. J. Sollas, F.R.S. . . . . | 211  |
| The Cloudy Condensation of Steam. By Shelford Bidwell, F.R.S. . . . .                                                     | 212  |
| Scientific Serials . . . . .                                                                                              | 214  |
| Societies and Academies . . . . .                                                                                         | 215  |
| Books and Serials Received . . . . .                                                                                      | 216  |

THURSDAY, JANUARY 4, 1894.

RECENT CONTRIBUTIONS TO  
METEOROLOGY.

*Report on the Present State of our Knowledge respecting the General Circulation of the Atmosphere.* By L. Teisserenc de Bort. (London: Stanford, 1893.)

*On Hail.* By the Hon. Rollo Russell, F.R.Met.Soc. (London: Stanford, 1893.)

*Weather Lore: a Collection of Proverbs, Sayings, and Rules concerning the Weather.* Compiled and arranged by Richard Inwards, F.R.A.S. (London: Elliot Stock, 1893.)

WHILE meteorologists are generally prepared to admit the salient points of the theory of the atmospheric motions as outlined by Ferrel, there are to be met discussions by various authors, accentuating not only differences in the details of the scheme, but also defects in the theory on which the general circulation of the atmosphere is based. The latest contribution to the literature of the subject illustrating these points, is from M. Teisserenc de Bort, Meteorologist to the Central Bureau, and General Secretary of the Meteorological Society of France; for this authority cannot accept, in its entirety at least, either Ferrel's deductions or his method of conducting the inquiry. Ferrel, it is well known, having deduced the equations for the horizontal motion of the atmosphere, relative to the earth's surface, applied, with effect, the condition of continuity and the law of conservation of areas, or, what would possibly be a better term, the preservation of the moment of rotation, and demonstrated the existence of an easterly motion of the atmosphere in the higher latitudes, and a westerly motion in the lower. To define the limits of these zones, Ferrel remarked that the sum of the moments with reference to the axis of the earth, of the air forming the easterly winds, ought to be equal to that of the westerly winds, and that this condition was fulfilled on a hemisphere, if the easterly winds prevailed up to  $30^\circ$  latitude, and westerly winds to the pole. This line of argument receives some support from the suggestion, that otherwise there would be a residual unexpended force, tending to change the velocity of the earth's rotation. But M. de Bort replies, with some force, that this argument is inadequate, because there is no evidence that the earth's rotation is uniform; and, indeed, the action of the tides and the diurnal variation of the barometric pressure, point, pretty conclusively, in an opposite direction. If the effects of friction are omitted, the author seems prepared to admit the validity of Ferrel's argument, and it would be very unjust to deny that Ferrel neglected friction altogether, or failed to modify his original result, obtained without friction. Further, Oberbeck especially has considered the effects of friction, and he has assigned a lower limit to the zone of change of direction not greatly different from Ferrel's value. Apart, however, from this point of theory, the author differs from Ferrel as to the cause of the belts of maximum pressure, north and south of the equator, and adds an explanation of the low pressure zone in latitude  $55^\circ$  and of the polar maximum.

But the most interesting, and possibly the most valuable portion of the paper, is the insistence on the connection traced between temperature and distribution of pressure, and the effort to explain the observed variation of pressure along parallels of latitude by the presence of thermic anomalies. The author sees in the variation of temperature over continents and seas in the same latitude, and the consequent changes in the density of the lower strata of the atmosphere, the origin of many of the irregularities that mark the isobaric curves, and a cause not inferior in its effects to the rotation of the earth in establishing the prominent features of the general circulation.

M. de Bort has also made an ingenious attempt to compute from theory the mean isobars of January and July, and to compare the results with actual observations. This is a step in advance, but the measure of success that has attended the effort must be left to the decision of individual judgment. Two approximations, or two distinct attempts, have been made. In the first, it has been assumed that at an altitude of 16,000 feet the irregularities in the distribution of the isobars disappear, and only the influence of latitude remains. Consequently the observed barometric pressure at the surface should be given by adding to the mean pressure, corresponding to the latitude, the weight of the column of air of variable density extending from the surface to this altitude. When this operation is effected, a comparison with the observed quantity discloses the fact that the computed pressures are too great, and further shows a tendency to exaggerate the barometric minimum over the North Atlantic, while it exhibits a maximum of pressure over North America which does not really exist. There is therefore, admittedly, a more marked difference in the computed isobars over continents and seas than is actually observed. Two causes are assigned for the failure to reproduce actual facts, both of which are probably operative. The one is that the density of the column of air does not diminish uniformly with the temperature, which hypothesis, for the purpose of computation, it is necessary to assume. The other is that probably the slope of the surfaces of equal pressure from the equator towards the poles is greater where the temperature is already low, than where the temperatures are high, in the upper regions of the atmosphere.

The second attempt to reproduce the observed pressure is arranged to take into account the influence of the unequal distribution of temperature upon the form of the upper isobars, and it is contended that the computed values of the surface pressure "show close analogy with those representing the isobars deduced from direct observation."

Not content with surveying the conditions of our atmospheric circulation, the author proceeds to discuss those that obtain on the planets, and submits two ideal pictures of the earth with its surrounding cloud as seen from space. These are compared with a photograph of Jupiter, but we strongly doubt whether the author gleans any additional facts in support of his views. The red spot is a conspicuous feature in this photograph, and whatever may be the true explanation of that phenomenon, the tolerable permanence of its character forbids us to ascribe it to atmospheric circumstances. But M. de Bort

is disposed to regard the dark markings, in which the red spot would be included, probably, as the real surface of Jupiter, seen through an unobscured atmosphere, and the position of the belts on Jupiter is thought to support the suggestions of the author. But we doubt whether astronomers are agreed that the dark markings represent clear sky, and the lighter portions cloudy vapour. Mars would seem to be the one planet in which we might expect to find atmospheric conditions similar to those here prevalent; but we are told that there are "probabilities based upon scientific reasons, that the clouds upon Mars are not distributed in the same manner as upon the earth." Though when we consider what a presumably comparatively unimportant factor the solar heat is upon Jupiter, and that, moreover, the axis of rotation is nearly perpendicular to the plane of the orbit, on a superficial view, this observation seems to be more applicable to Jupiter than to Mars. From the remark with which the paper closes, we gather that the author intends to prosecute this subject of investigation on the planets. We wish him success.

Of the second work mentioned at the head of this notice, it is rather difficult to speak. Although the author has not sketched the plan and scope of the work in any introductory chapter, it is easy to understand the principle that has guided him in the construction of the book. He has evidently been at great pains to bring together all that is valuable, or that he thought valuable, in the descriptions that have been given of hailstorms in the past, not only in the accompaniments of the hailstorms, or of the characteristics of the hailstones themselves, but also of the theories that various authorities have suggested to explain their occurrence. When we consider that in the case of nearly every hailstorm, some one is found to describe it, it is evident that the materials from which Mr. Russell can draw his information are very widely scattered. The list of authors quoted is a long one, and could no doubt have been made much longer, did not the reiteration of the same facts become wearisome. Having collected his information, the author has attempted to digest it, and has given us a summary of the characteristics of hailstones with a graphic description of the development of a hailstorm. One consequence of this method of dealing with the subject is that about three-fourths of the book consist of extracts from various authors, and only the remainder is original matter. This class of work, if not very brilliant, is, no doubt, valuable; and inasmuch as most of the extracts are given in the words of the author, with distinct references to the sources from which they are taken, this book may save much searching of original authorities, and a proportionate saving of time. Whether the materials are arranged in the most advantageous manner, is a question about which some doubt may be entertained. It would seem sometimes as though the extracts had been printed in the order in which they had been encountered, without any attempt at arrangement at all. To take the first chapter, "descriptions of hailstorms and hailstones," at first sight it would look as though some chronological order was to be maintained, for we begin in 1680, and pass next to the early years of this century; but when we get into the middle of the century, we flounder about from 1890 to 1870, and back again, without any guide. Neither is

locality any rule, for we are taken all over the world, without method or system. Nor is it easy to trace any gradual scientific progress in the descriptions. We have simply more or less complete descriptions of some fifty hailstorms, or of the salient features that distinguished them.

The second chapter gives us observations of temperature, clouds, and winds at great altitudes, principally confined to the accounts of balloon ascents. In this chapter, which is very short, there might have been found room to discuss in more detail the observations made at some of the meteorological stations at considerable altitudes. The results obtained at Pike's Peak, Colorado, would seem to be of the highest importance in this connection; but the author prefers to drop this topic, though apparently germane to his subject, in order to discuss, or rather to collect, the opinions and observations of those meteorologists who have noticed the connection of electricity with the occurrence and formation of hail.

The chapter on theories of hail is interesting. In it is given the opinions of most of those whose opinions are worth recording, but in the popular and not the scientific language which some of the authorities quoted would have used. Von Bezold especially suffers from inadequate description, and, if we are not mistaken, Hertz's name is not mentioned. It would seem almost as though the author were not acquainted with much of the hydrodynamical analysis that has been applied to the atmosphere, or being acquainted with it, disapproves of its application to the present inquiry.

In the chapter on the development of a hailstorm, objection will probably be taken to the insistence and stress that is laid upon the part played in the mixture of air of different temperatures, as a primary cause in producing precipitation, whether it be of hail or any other form of moisture. The numerical example worked out to illustrate the author's point is not very clearly expressed; and even granting the figures of the author, he is obliged to fortify his case by a continual mixture. But the continual mixture would tend to produce uniformity of temperature, and disturb the accuracy of the original calculations. Undoubtedly we have present, in what it is usual to call the hail stadium, an amount of dry air which it is convenient to separate, in theory at least, from the saturated vapour also present, the drops of water, and the particles of ice or snow which probably constitute the germ of the large hailstones, and then, if the conditions are favourable, we get hail; and it is difficult to see that our author has carried the explanation much further. Nor possibly does the application of the mechanical theory of heat, however legitimate its methods may be, advance our knowledge very materially, at least in a practical direction. The local, and often confined, area over which hailstorms occur, is a marked feature of their occurrence, and is likely, for a long time to come, to baffle the applications of a general theory, and prevent any sufficient precautions being taken against the damage they produce, which it may be supposed is the practical outcome that sufferers hope to derive from the studies and inquiries of meteorological observers.

In the final chapter, headed "Conclusions," there is an attempt to gather up the results of the observations recorded in the previous chapters. It is a pretty fair

record of our general knowledge of the subject, exhibiting a tolerably complete grip of all the circumstances attending these phenomena. It does not show much originality, perhaps, but it does show very extensive reading, accurate observation, and power of condensation.

The third book mentioned is scarcely of the kind that compels one to sit down and read off-hand. It is precisely what it professes to be—a collection of the many weather proverbs which possibly the wit of one, rather than the wisdom of many, has perpetuated. If these adages did contain the results of long-sustained and well-directed observation of the habits of birds, animals, and insects, they would possess a distinct value, though it is difficult to see how the information so gleaned could indicate the severity or the mildness of the coming season; but it is to be feared they too frequently record the opinion of one who is capable of a jingling rhyme, or of one whom his comrades consider to be wise in such matters.

There are also quotations from the poets, ancient as well as modern, and all bearing on the subject of weather prediction. The hope of the author is that the perusal of such a collection may induce students to take more intelligent notice of meteorological conditions, and to avail themselves of accurate instrumental means, rather than to rely upon hackneyed quotations. A somewhat similar collection of "wise saws" was published by the United States Signal Service, but we fail to see any reference to this work in Mr. Inwards's introduction. A study of these sayings would probably furnish some additional quotations, and as the compiler aims at greater completeness in the next edition, we would refer him to this source. The book is well printed and admirably "got up," and will no doubt be welcome to many interested in folk and weather lore.

#### PHYSICO-CHEMICAL MEASUREMENTS.

*Hand- und Hilfsbuch zur Ausführung physiko-chemischer Messungen.* Von W. Ostwald. (Leipzig: W. Engelmann, 1893.)

THIS manual must be regarded as the only guide to measurements in physical chemistry which has yet been published. The book is not intended to completely cover this field of investigation, but has evidently been devised with the primary object of assisting Prof. Ostwald in his course of instruction at Leipzig. It is not an introduction to the subject, as the detail supplied, both in connection with apparatus and methods, is insufficient for the requirements of the beginner; nor is it a treatise wherein a representative collection of methods may be consulted. The book is rather to be viewed as an aid to the teacher, or as indicating to the chemist or the physicist methods which for the most part the author has found to be of service in his own laboratory.

The information contained in the opening portion of the volume is of the kind usually met with in a physical text-book: modes of calculating results, the influence of errors, the use of corrections, the measurement of length, the balance and weighing, and the measurement and regulation of temperature. Succeeding chapters

take up the more common operations in glass-working, the measurement of pressure, the measurement of the volume and density of solids and liquids, and the ordinary methods of measuring vapour density. Here it may be noted that Perkin's modification of Sprengel's pyknometer, which is perhaps the most useful of all the various patterns, is not included among those described. Kopp's pyknometer also is rendered more serviceable if a short mm. scale instead of a single mark be etched on the neck.

The thermal properties of liquids are next briefly considered. Modes of determining expansion and molecular volume at the boiling-point are given with a moderate amount of detail. The determination of the boiling-point itself is, however, described in the most meagre way. Of the various methods of measuring vapour pressure the dynamical process introduced by Ramsay and Young alone finds a place. Critical temperature and critical pressure are determined in separate pieces of apparatus in the manner recently described by Altschul. No general method is indicated whereby the relation between pressure and volume may be determined under varying conditions of temperature, and no practical method can thus be given for estimating critical volume, although the principle of the new method due to Mathias is mentioned.

Calorimetry is now dealt with, and short accounts are given of the simpler methods of estimating specific heat and the thermal changes accompanying vaporisation, dissolution, combustion, and reactions in dilute solution.

Descriptions of optical measurements relating to refractive indices, spectroscopy including spectrum photometry, calorimetry, and rotatory polarisation are now introduced, and are followed by a chapter on viscosity and surface tension. In connection with viscosity, the apparatus represented is only adapted for obtaining relative values, and is quite unsuited for investigating the effect of temperature. What appears to be the correct value of the kinetic energy correction used in calculating viscosity coefficients is ascribed to Finkener and Wilberforce, whereas the first published account of the mode of deducing it is due to Couette. None of the methods given for measuring surface tension are free from the objection that air is in contact with the liquid surface.

The remaining chapters are devoted to measurements on solutions. Methods of estimating the solubility of solids, liquids, and gases, and of determining molecular weights from the freezing-points and boiling-points of solutions are given at considerable length. At still greater length, and thus in marked contrast with the treatment elsewhere, electrical measurements are next set out. Here are found accounts of the methods of measuring electromotive force and conductivity, dissociation constants, the basicity of acids, &c. The last chapter takes up elementary problems in chemical dynamics relating to the velocity of chemical change, the catalysis of methyl acetate and the inversion of cane-sugar by dilute acids being given as examples.

From what has been said it is evident that the operations dealt with in the book are only such as are frequently performed, or which at the present time are considered to be of importance. Some of these even are

occasionally omitted; no mention is made, for example, of the ordinary methods of obtaining melting-points.

It is noteworthy also that processes relating to the purification of substances for physical study are not touched upon. Accounts of the best systems of fractionation, either by distillation or crystallisation, or of distillation under reduced pressure, &c., have, it seems to us, a better right to a place in a book of this kind than, say, the chapter on glass-blowing. Again, no particular notice is taken of methods which have to be used when only a small quantity of material is available. It frequently happens that a substance can only be obtained sufficiently pure in but small quantity, and if methods of obtaining boiling-point, density, refractive index, &c. in such cases were more widely known, physical constants would no doubt be more generally estimated in the course of ordinary chemical investigations.

It is needless to state that the book is full of useful hints both on methods and apparatus, and will be indispensable to those for whom it is specially designed. It is also worthy of special recognition as being yet another effort on the part of Prof. Ostwald to place physical chemistry on a level with other departments of experimental investigation. J. W. RODGER.

#### OUR BOOK SHELF.

*Handbook of British Hepaticæ.* By M. C. Cooke, M.A., LL.D. 1 vol. 8vo. 310 pp. 7 plates. 200 woodcuts. (London: W. H. Allen and Co., 1894.)

PROBABLY no group in the British flora has received so little attention as the Hepaticæ. This is due partly to the ordinary botanical text-books describing merely the life history of the ubiquitous *Marchantia polymorpha*, and ignoring or passing over with but scanty reference the foliaceous group. But chiefly is it due to the want of a handbook by which beginners could identify their plants and obtain references to the literature of the subject. Sir W. J. Hooker's magnificent monograph, which appeared in 1816, contained plates with copious descriptions of all the British species then known; but it is now scarce, costly, and having all the species described under one generic name, *Jungermannia*, it becomes necessary, after identifying a plant by it, to refer to some other source to ascertain the now accepted name. Hooker's "English Flora," vol. v., in dealing with the same group, divides the frondose group into several genera, but retains the generic name of *Jungermannia* for the whole of the foliaceous group.

In 1865 Dr. M. C. Cooke published, as a supplement to *Science Gossip*, a catalogue with outline figures of all the British species. This is now out of print. Since then notes scattered through various journals have formed the whole of the British literature upon the subject, except the commencement of a monograph by the late Dr. B. Carrington.

Dr. M. C. Cooke has now filled up the gap by producing a "Handbook of the British Hepaticæ," containing full descriptions of all the species, about two hundred in number, known to inhabit the British Islands. The volume opens with an introduction of 20 pp., describing the position, structure, reproduction, and subdivisions of the group. This is followed by a detailed account of the species, each arranged upon the same plan. First come the diagnostic characters, followed by copious synonymy, then the habitat, and finally a full description. Each species is also represented by an outline figure, either in the text or in one of the seven plates at the end of the

volume. A bibliography and index complete the work. The size and clearness of the type will be appreciated by those who use the book, as it should be, in conjunction with microscopical examination of specimens. Altogether a very useful work has been produced, which ought to fill a gap already too long vacant. C. H. W.

*The Royal Natural History.* Edited by Richard Lydekker. Parts 1 and 2. (London: Frederick Warne and Co., 1893.)

YET another "Natural History." There is certainly a demand for such, and without doubt there is a supply. The work is to be in six volumes, and the parts, published monthly, will complete the series in three years. The paper and typography leave nothing to be desired. The illustrations are in almost every instance, so far as our knowledge of the published parts goes, excellent; many of them are as artistic as they are accurate; and when we add that the editor of the series is an able and well-known zoologist, there can be no doubt but that the reader or purchaser will get full value for their expenditure of time or money.

In noticing a work of this nature, when the facts are as above stated, there is but little room for criticism, and despite the shock which the first blazing sound of its advent conveyed to our senses, despite the fact that "it is not compiled or translated from foreign sources," and that "the co-operation of the Bibliographic Institutes of Leipsic and Vienna" has been secured so as to obtain "all that is best and newest among the productions of the greatest natural history publishers of Europe," we yet most heartily recommend the work to all our readers, and we anticipate that most of those who take any interest in zoology will place it on their book shelves.

Of the six volumes, as was to be expected in a work of this kind, the larger number (five) is to be devoted to the backboneed animals, and but one to the boneless crew; and of the first five volumes, two and a half will relate to the mammals, one and a half to the birds, and but one to the reptiles, amphibians, and fish. It is not at all a fair division, but then the mammals are thought to be the most generally interesting class, and we are promised a lot of information about "the larger game." The first two parts are devoted to the monkeys, and we have an account of nearly all the known species, accompanied with an immense number of illustrations. One suggestion occurred to us while reading over the account of the habits of the baboons; that when plants are referred to they should, when their scientific names are used, be quoted specifically as well as generically; thus a "very remarkable kind of West African plant" is mentioned as the "welwitschia," but the editor would never think of quoting the Anubis baboon as the "cynocephalus." We hope it will be a long time before *Welwitschia mirabilis* will be exterminated by the baboons. From a natural history stand-point there is really no such plant as an "ixia," but there are several species of the genus *Ixia*, upon the bulbous stems of which it would appear these baboons feed.

#### LETTERS TO THE EDITOR.

[The Editor does not hold himself responsible for opinions expressed by his correspondents. Neither can he undertake to return, or to correspond with the writers of, rejected manuscripts intended for this or any other part of NATURE. No notice is taken of anonymous communications.]

#### The Origin of Lake Basins.

I WELCOME the criticism of my article on the glacial origin of a certain class of lakes by an experienced geologist like Mr. Oldham, because it probably embodies the strongest argument that can be adduced on the other side—at all events as regards



the one aspect of the problem which he alone touches upon. He urges that my paper contains a fallacy and a misrepresentation. The alleged fallacy is, that because the lakes in question are found in glaciated and not in otherwise similar non-glaciated regions, "therefore the rock-basins in which the lakes lie were excavated by glaciers." But this is not my argument, and therefore not my fallacy. What I say is—"there must be some causal connection between glaciation and these special types of lakes. What the connection is we shall enquire later on." That there is a "causal connection" Mr. Oldham asserts as strongly as I do myself, though it is a different, and as I have endeavoured to show, an untenable one.

This brings us to the alleged misrepresentation, which is, that I have imputed to the opponents of the ice-erosion theory, the view that the earth movements which, as they allege, produced the lakes, occurred in the period just before the ice-age came on. Mr. Oldham says, this is an unreasonable and unfounded limitation, since the movements in question probably occurred throughout the glacial period itself. I quite admit the validity of this criticism, and that I should have added, "or during the glacial period itself," to, "immediately before" it. I certainly had this probability in my mind, and the reason I did not express it was twofold. In the first place, all the advocates of the earth-movement theory appeared to assume, either directly or implicitly, the preglacial origin of the lakes; and secondly, this assumption gave them the strongest argument against my views, and I therefore gave them the benefit of it. Mr. Oldham appears to have overlooked this. Yet it is clear that the shorter you make the time since the formation of lake basins by earth-movements the more difficulty there is in explaining the total absence of valley-lakes from all the non-glaciated mountain regions of the world, since there is less time for them to have been all silted up. When arguing this point I said—in the passage evidently referred to by Mr. Oldham—"The only way to get over the difficulty is to suppose that earth-movements of this nature occurred only at that one period, just before the ice-age came on, and the lakes produced by them in all other regions have since been filled up." I thus gave my opponents the benefit of an extreme supposition which was all against myself; while the more reasonable view, that earth-movements are just as likely to have occurred during and since the glacial epoch as before it, renders my argument from the geographical distribution of lakes much stronger, since it is impossible to believe that, if lake basins as large and as deep as those of Geneva, Maggiore, Como, Constance, and Garda, were formed in non-glaciated regions as recently as the middle or latter part of the glacial epoch, a considerable number of them would not be still in existence.

Of course, if it can be shown that filled up lake-basins exist in tropical and subtropical regions, corresponding in number, position, size, and depth, with those of glaciated areas, the argument from geographical distribution will break down. At present I am not aware of any evidence that such is the case. But even if it were so, there remains the singular correlation between the size and depth of lake basins and the known size of the glaciers that occupied these valleys; together with the surface and bottom contours of the lakes themselves, so strongly opposed to their production by any form of valley-subsidence or earth-movements.

A friend has pointed out an unsound argument in my article on the above subject in the *Fortnightly Review*, and I therefore ask to be allowed to state what it is, and thus avoid its being possibly made the subject of discussion in the pages of NATURE. As a proof of the very great erosive power of ice I have adduced Dr. Helland's estimate of the quantity of Scandinavian *débris* in Northern Europe. But it is evident that this only proves the great carrying power of the ice, since the rock and gravel would be mostly of sub-aerial origin. It, however, indicates a very long period during which the ice-sheet was at work, while the clayey element in it would be due to erosion. The larger part of this, however, would certainly have been carried away into the North Sea during the passage of the ice-sheet across the Baltic. The enormous quantity of boulder-clay in North America, which I have also referred to, is a better indication of true ice-erosion.

ALFRED R. WALLACE.

THE question you have allowed me to raise is too important and far reaching to justify its dissipation upon personal issues. It cannot be thought unreasonable that those geologists who propound transcendental theories should justify the mechanical

postulates on which they claim to base them. This is all I have asked.

Dr. Wallace asks me to explain what will happen when sufficient pressure is applied to ice not only to crush it, but to induce regelation. I have already explained in my work, that the notion of fracture and regelation taking place in glaciers is at issue with the details of their differential motion as tested by experiment. There is no evidence that ice which on pressure being applied to it has ample room to move, will undergo regelation at all. The pressure when crushing ensues will be dissipated in the direction of least resistance, and most probably upwards. This emphasises Mr. Deeley's statement, and he wrote as a champion of Dr. Wallace, that "fracture and regelation have little to do with the question."

Dr. Wallace then returns to his charge against me that I have in some way committed myself in my work to a position inconsistent with the one I am now maintaining. I can assure him that if he has read this meaning into my words, it was not what they were meant to convey. In giving the history of the "Glacial Nightmare," I entered largely into the views of Charpentier, and in so far as he championed glaciers as against ice sheets I agree with him. I have said that his views "are for the most part sound and unanswerable, since they finally established for the Alpine country and for Switzerland the fact that glaciers were formerly much more extensive," &c. Beyond this I could not go, since my work was written to prove the unscientific character of the extravagant conclusions of the later glacialists, including Charpentier himself after he became a follower of Agassiz. Apart from this, however, what your readers I am sure would welcome would be an *argumentum ad rem*, and not one *ad hominem*.

In demanding that the advocates of the glacial theory in its extravagant form should justify their premises and postulates, I must not be understood to decline to meet the geological case against the glacial excavation of lobes. I have met it at great length already in my recent work, but not so ably and not so thoroughly as Mr. Spencer met it in his elaborate and crushing examination of the critical case of the North American lakes, which I commend most heartily to the study of enthusiastic champions of omnipotent ice.

The geological question, however, is necessarily contingent upon the mechanical question, and no amount of ingenuity will in the long run enable those who invoke ice as the author of all kinds of geological work to evade the duty of proving its capacity to do that work, and notably to explain how it can travel over hundreds of miles of level country, or suddenly begin to excavate deep and extensive lake basins after it has been moving gently over its own bed of soft materials for many miles, or, indeed, how it can excavate on level ground at all. The first step is to show that ice can convey thrust in a way to compass these ends; the second one is to show whence this thrust is to be derived. Your readers who are committed to no theories unsupported by facts, will not quarrel with the reasonable demand that these first steps should be surmounted before we advance any further. Those who like to traverse cloud-land on the wings of fancy may be otherwise satisfied. To them I would only say that the result cannot be science; it must remain nothing more than poetry.

HENRY H. HOWORTH.

30 Collingham Place, Earls Court, December 30, 1893.

#### Hindoo Dwarfs.

In your issue of November 9, 1893, is a notice of some photographs, by Colonel A. T. Fraser, of two dwarfs, taken in the Kurnool district of the Madras Presidency, near Bellary. From the account given of these dwarfs—the hereditary nature of the deformity, its limitation to the males of the family, the inability to walk, the normal bodily growth up to six years of age—it seems possible, if not probable, that the family is afflicted with the disease known as pseudo-hypertrophic paralysis (Duchenne's paralysis). Any physician could settle the question immediately on seeing one of the subjects in question; and very probably a study of the photographs would be sufficient. I have had cases of this disease in my wards at the General Hospital, sent from Bellary. Perhaps Colonel Fraser would kindly send me a copy of one of the photographs, or show them to another medical officer, and tell us his opinion.

A. E. GRANT.

Madras, December 2, 1893.

EWART'S INVESTIGATIONS ON ELECTRIC FISHES.<sup>1</sup>

THIS is a magnificent memoir containing the very interesting observations of Prof. Ewart concerning some of the most important chapters of comparative anatomy. Everyone who has an idea of the enormous difficulties connected with these investigations will admire the great skill and successful perseverance with which the author has followed up many dark problems and thrown light upon a number of the most obscure questions.

My studies have been in the same direction for nearly twenty years, and I congratulate my companion in work upon his great success.

It might appear a bold attempt for a foreigner to debate the complicated problems treated in the work; but, on the other hand, there is apparently a strong interest attached to the endeavour to enlarge the field of international intercourse, and this will serve as an excuse for any awkwardness of language.

There is no doubt that science is the chapter of knowledge most entitled to international treatment, and Prof. Ewart himself has done his best to acknowledge the merits of foreign authors. Still, I wonder whether he is aware of the fact that in many places his deductions bear a more or less national character. The proof of that fact cannot be compressed in a few notes, but it may suffice to point out the places where the differences of treating these matters between British and continental writers seem to be most apparent.

Everybody will probably agree that the whole of Prof. Ewart's work deserves very high praise. The plates, which have been accurately drawn by the author himself, are beautifully printed, and yield very ample and useful instruction to anyone who wants anatomical and histological information about these interesting, and yet very imperfectly known, organs. They give a clear account of the immense work the author had to accomplish before he could give so exact and complete representations of the electric organs as well as the cranial nerves and the sense organs.

It will remain to Ewart's undisputed credit that he has brought before the public a large amount of information on the anatomy and histology concerned. The explanation of the plates facilitates the understanding of them, and forms the connecting link between the figures and the tenour of the deductions. It is proved by comparing a great number of organs in different species of Raja, that there are two distinct kinds of electric organs, viz. "cup-shaped," which occurred in *R. circularis*, *radiata* and *fullonica* of the British seas, in *R. eglanteria* from abroad, and, on the other hand, "disc-shaped," which he found in *R. batis*, *macrorhynchus*, *alba*, *oxyrhynchus*, *maculata*, *clavata*, and *microcellata*.

Everywhere Ewart confirms the statement of former writers, that the electric organs were derived from muscles of the tail which became changed into electric tissue. With great care and skill he has followed the development of these organs in the embryo, and showed how the muscles gave up their firm hold on the sinews, and shrivelled up to discs or cups.

There remains yet one difficulty to be overcome, which the author has not considered; that is to say, he finds the termination of the nerves for each element at the proximal end of each muscular club, and compares them (as other authors do) to the motor end plates of common muscles, which are fixed alongside the striped fibres, and not at the end.

That is, of course, a subordinate question, and I am very glad to repeat here what I have stated in former publications of mine, that the muscular origin of the electric

organ in the skate also appears beyond doubt, and that I thoroughly agree with Prof. Ewart, not only in that principal question, but also in his deductions regarding the phylogenetic development.

One of the general deductions appears rather strange, not only to me, but to most authors on the continent interested in the matter. How is it possible to consider the electric organs of the skate as such of "vestigial character" before any evidence is given in favour of a retrograde development, which takes place at any period of life? Are not all the statements of Ewart, as well as of former authors, clear proofs that the development is progressive, or at least resting at a certain degree of perfection, after having left the starting-point (muscular tissue) only for a comparatively short distance?

The organs might still advance to further perfection (which I presume they do), or they might become rudimentary again; but so long as there is only progressive and no retrograde motion in the development, it is hardly worth while to argue about the probability of their vestigial character.

I differ only so far from Ewart, as he does not convince me that the electric organs of the skate are as equally perfect as the organs of the Torpedo. In the skate, and up to a certain degree also in Mormyrus, the striated layer of the organ is histologically and optically (in polarised light) proved to be the rest of the original muscular tissue. If there is so much left of the former state of things, it proves, in my opinion, that the process of transformation going on is not so far perfected as in another case (Torpedo), where nothing of the muscular character is left.

I may be permitted to quote here a suggestion I made in a former number of this journal (January 19, 1893) regarding the probable way of phylogenetic development in these organs. It seems to me possible that a kind of physiological alteration changes certain muscles so gradually into electric tissue that a comparatively still imperfect element under favourable circumstances might give an electric shock, which proves useful to the skate for maiming small animals upon which it preys; and so the fish might continue to improve the organ by using it.

Ewart (*R. circularis*, p. 546) argues exactly in the same way as I did, but hesitates to assume that weak electric shocks might be of any use to the skate. It should be kept in mind that small aquatic animals are often extremely sensitive to electricity, and that an unexpected weak electric shock startles even a human individual. At another place, where the author treats the same theory, and grants the possibility of all the other presumptions, he holds back from the universally accepted principle, that constant use makes an organ increase. (Skate, p. 411).

Of course, up to a certain degree, the phylogenetic development of the electric organs contains still a good deal of mystery, and will, I fear, always lack the scientific proof so eagerly looked for; but I must repeat my conviction, that it is easier to imagine the transformation of striped muscle in electric tissue, than to explain by natural selection the development of any distinct, lively-coloured pattern on the wing of an insect.

The cautiousness of the author is, however, to be praised, and it is very interesting to follow his arguments about the *pro et contra* in these complicated matters.

I cannot admire as much another chapter of his paper, where Prof. Ewart does not seem to be quite up to the international mark; it is that in which he compares the number of electric elements in the different electric fishes. (Skate, p. 397). The total of electric elements for each organ in *Torpedo marmorata* he gives as 250,000, and in spite of the great difference of this number with the sum found by other writers before Ewart, he does not say one

<sup>1</sup> "Electrical and Lateral Sense Organs, and on the Cranial Nerves of Elasmobranchs." By Prof. J. C. Ewart. (Edinburgh, 1893.)

word about that divergence. I spent much time in counting the elements in the organ of Torpedo, and confirmed my results by counting also the ganglionic cells belonging to the plates. My total comes very near to that of Valentin, but amounts only to 179,625 in each organ.

Prof. Ewart cannot expect me to give up my number in favour of his, published much later, before he proves that I made a wrong estimate. He speaks also of the large Torpedo of America, and calls it *Torpedo gigantea*. It seems he is not aware of the fact that the name of *Torpedo gigantea* is given to the petrified species from the Monte Bolca, whilst the American species got the name of *T. occidentalis* (Storer). He ignores, or neglects, at the same time, the fact that a near related species, which has about the same number of electric elements, generally named *T. nobiliana* (Bonap.), occurs also in the British seas.

If it is difficult to explain such want of harmony with other authors; it amounts to an impossibility for a foreigner to give a clear account of the following papers concerning the cranial nerves of Elasmobranch fishes. Not that I mean to blame my learned colleague for this; on the contrary, I admire the papers very much, and recommend them with all my heart to everyone who wants instruction about the finer details of these nerves; but with regard to the nomenclature employed. I am afraid very few continental authors will agree with the homologies stated by Ewart. When he in a certain place says against Sappey, "that nerve is all but universally acknowledged to be a part of the facial," Sappey will most decidedly state "that nerve is all but universally acknowledged to be a part of the trigeminal."

Considering it of little use to discuss the confusion of names in the papers quoted by Ewart, I wish it to be borne in mind that the leading principle of the author to prove his homologies is the equality of distribution of the nerves in the peripheric organs. If that holds good, as I am convinced it does, how can he at the same time give the name of a true motor nerve (*N. facialis*) to a cephalic nerve of a true sensitive character? Perhaps he will answer, "All, or at least most, of the other authors do, why shouldn't I do the same?" Putting aside the protest many continental authors (myself included) make against such nomenclature, at any rate his principle of innervation is given up, and I am firmly convinced that the comedy of errors in the nomination of cranial nerves in comparative anatomy will not cease until quite new names or, perhaps still better, only numbers are applied to them according to the place of origin in the substance of the central nervous system. Motor and sensitive nerves must be kept separated by all means, segmental and not segmental nerves may be designated at the same time in any proper way.

It is in this respect that the want of an international understanding is most severely felt, and we must hope that the future may provide an advancement of science also in the matter; for before a firm and clear base for these homologies of nerves is given, we might just as well talk Chinese toge her.

Professor Ewart's investigations about the cranial nerves had for their chief purpose a clearer insight into the innervation of certain organs of sense, treated in another paper annexed to the same volume. I am very glad to state that the impossibility of accepting his homologies does not interfere with his results as regards the innervation of these sense organs.

The anatomical skill of the author is best shown in the treatment of the structure of these organs. So far as my own experience in these matters goes, I am led to ask, Are his statements and figures of the sensory canals and the nerves belonging to them very correct and complete? He overreaches the previous writers treating the same objects by the admirable finish of his papers

which, as far as I see, ought to be followed by another concerning the ampullary canals.

In this chapter I have also to object to his way of treating the literature and of stating homologies in spite of his own principles.

The sense organs I discovered on the skin of Raja, and called "Spaltpapillen," named "pit-organs" by Ewart, were not found by any other author before. It is not true that Merkel saw them on the back of *Mustelus* and at the mouth of *Spatina*; he described only "freie Nervenbügel" (*free nervous collines*) in these places. The name itself proves that the sense organs described by Merkel belong to another group altogether, and so does their position.

How Ewart, who places such importance in the distribution of the nerves, can find that the "Spaltpapillen" probably correspond to organs of *Squatina* placed at the mouth of a very different make and different innervation, he may know himself, but the reader finds it impossible to follow such argument.

The figure he gives of the pit-organ (sensory canals, pl. 3, Fig. 10) does not show such an organ fully developed. Otherwise the split would be narrow and straight, the cells by which it is lined flattened and columnar, not rounded, the papilla itself much higher raised above the surface of the epithelium, and pigment cells frequently found between the epithelial cells. (Comp. my paper: "Über Bau und Bedeutung der Canalsysteme unter der Haut der Selachier." *Sitz. Ber. d. Berlin Akad. d. Wissensch.*, 1888, s. 291.)

The papilla is, in the adult, a good deal raised above the level of the skin, so that even the sense organ at the bottom of the split in the papilla has still a somewhat elevated position. This position prevents me from admiring the name of "pit-organs," as a pit ought to mark a depression below the main level. Continental writers will also shake their heads in reading that a differentiated group of epithelial cells forming a sense organ, and resting between them, is called a "follicle," which by all means wants a kind of stronger envelope enclosing the cells. But I quite agree that in England Latin words might be admitted, which would not do on the continent.

Before Prof. Ewart proceeds to describe the ampullary canals, I recommend him once more to study the paper of Savi concerning these canals. He places the French author amongst those who take also the ampullary canals for sense organs, which is a great mistake, as Savi affirms in most decided terms the excretory function of the ampullary canals. (Mateucci et Savi, "Études Anatomiques sur le Système Nerveux et sur l'Organe Electrique de la Torpille," p. 331.)

But such objections very slightly detract from the great merit of the author. They only prove the strong interest which the perusal of Prof. Ewart's papers has aroused in me, as it will do in all other readers. I cannot conclude my remarks without acknowledging once more, with all my heart, the magnificent results obtained by him, and I trust that he may succeed further in the same direction. GUSTAV FRITSCH.

NAVIGATION BY SEMI-AZIMUTHS.<sup>1</sup>

THE year 1893 should be an interesting one to nautical men. A new Daniel has come to judgment in the person of Mr. Ernest Wentworth Buller, M.R.A.I., M.R.U.S.I., M.I.E.E., the inventor of the semi-azimuth system of navigation, who is equally earnest in denouncing the shortcomings of the existing systems of

<sup>1</sup> "Semi-Azimuths. New Method of Navigation, being a combination of Spherical Trigonometry and Mercator's Sailing." (London: Nurie and Wilson, 1893.)

navigation, and in advocating the merits of his own. For the precise object of the new method let our author speak for himself. In page iv. of the preface we read: "It is here claimed for the semi-azimuth method that it renders double altitudes unnecessary; that a better result than they have been supposed to yield can be obtained from either observation singly, and this also with a great saving of time and trouble."

Again on page 27: "The range of the General Method extends, either from the meridian, or from the limit at which the direct method becomes uncertain, viz., three points from the meridian, up to an azimuth of seven points, or more, that is to say to within less than one point from the prime vertical, which may be considered the practical limit of the semi-azimuth method. . . . It may safely be affirmed that nothing like this extent of range in the computation of latitude has ever been attained by the current systems of navigation."

The feats which our new teacher claims to have accomplished are two in number.

(1) The discovery of a new formula for reduction to the meridian.

(2) By a somewhat tedious system of approximations to obtain by the semi-azimuth method from either of two observations for double altitude the same or a better result than would under the usual double altitude method be derived from the two combined, subject only to the limitation that the body must not be within a point of azimuth from the prime vertical.

Let us consider (1) and (2) in detail.

First with regard to (1), the formula obtained is this:

$$\text{Reduction} = h \cos l \times \text{arc } \frac{1}{2} \text{ azimuth.}$$

The formula is a simple one, and now that hour angle is so easily converted into azimuth by the Burdwood and Davis' tables, there seems no objection to its adoption by those who prefer to work out their correction rather than to take it direct from the tables.

Mr. Buller deduces the formula from a somewhat elaborate construction on the Mercator's chart. It is, however, merely an old friend masquerading in a new dress, and he might, if he pleased, have easily obtained it from the expression in ordinary use.

Thus in the formula

$$\sin \frac{\theta}{2} = \sin p \sin c \operatorname{cosec} \alpha \sin \frac{2h}{2},$$

where  $\theta$  is the correction,  $p$  the polar distance,  $c$  the colatitude,  $\alpha$  the zenith distance, and  $h$  the hour angle, if we assume that

$$\frac{\sin \frac{h}{2}}{\sin \frac{A}{2}} = \frac{\sin h}{\sin A} = \frac{\sin c}{\sin p'}$$

where  $A$  is the azimuth, we obtain

$$\sin \frac{\theta}{2} = \sin c \sin \frac{h}{2} \sin \frac{A}{2},$$

or

$$\theta = \frac{1}{2} \sin c \cdot h \cdot A \cdot \sin r',$$

the Buller formula in a logarithmic shape.

The use of this formula is first exemplified by its application to examples from Jeans' "Navigation," and so long as the azimuth is small it answers well enough. But our author is tempted further afield, and so soon as he gets well away from the meridian his formula begins to give trouble, and he is only able to obtain an accurate result by a process of approximation so cumbrous as to be quite useless for practical purposes. As an instance of this, witness the example of which the results, but not the full work, are shown on p. 14. Were the work to be shown in full, it would occupy more nearly two pages than one page of the text.

Now let us suppose it had not been given to Mr. Buller

to discover the methods lately presented to the nautical world, and that he had been content to follow mere ordinary processes.

Imagine, for instance, that he had selected the well-known formula

$$\text{vers Mer Zen Dist} = \text{vers } \alpha - \sin p \sin c \text{ vers } h$$

in order to work out example § 16, p. 12.

Then, upon his own assumption that the latitude was  $51^\circ$ , or  $12'$  in error, he would obtain as a first result lat.  $50^\circ 49' 42''$ . Repeating the process with this new latitude, a second approximation would be  $50^\circ 48' 16''$ , while a third repetition would result in  $50^\circ 48' 3''$ , the true value and this with less than one-third of the trouble.

The semi-azimuth had better, therefore, be confined to observations within a point or so of the meridian.

We pass on to the second and more important part of the task which Mr. Buller has set himself, namely, to show that the latitude within certain wide limits of azimuth may be obtained with accuracy from a single altitude without waiting for a second.

And this may be at once conceded, that by making the necessary adjustments for change of azimuth, and by successive approximations, an altitude may be reduced to the meridian, even when the azimuth is considerable.

But the same result may be obtained from the versine formula given above with far less trouble but greater accuracy.

The question, then, narrows itself to this: Why should we not in all cases of observation within seven points of the meridian, reduce the altitude to the meridian at once, by one method or another, and so obtain the latitude without waiting for hours to take a second altitude, and then making lengthy calculations?

Why have Robertson, and Raper, and Inman, and the other giants failed to hit the bull's-eye, while it is left to Mr. Buller to put his finger on the "blind spot"?

The answer is easily stated.

The "blind spot" is to be found not in the accepted custom of mariners, but in the author himself. Mr. Buller in arriving at his conclusions leaves out of consideration the real vital point which attaches to every observation taken ashore or at sea, but especially to the latter class, namely, what is well defined by Raper as the "Degree of dependence" to be placed on the observation.

In every observation off the meridian we have to deal in one form or another with a spherical triangle, in which three elements being given we have to find a fourth.

Now the three given elements are in general known only approximately, and it behoves us to find under what conditions an observation should be taken that the smallest possible error may be produced in the final result. In the problem under consideration, treated by the Buller process, the data are the polar distance, the approximate colatitude, and the zenith distance.

Of these the polar distance may fairly be regarded as accurately known, since the difference can only be at most but a few seconds.

The latitude is required to be known only approximately, the object of the observation being to find the amount it is in error, and it has already been admitted that the new process will suffice to obtain the correct latitude, *always supposing that the observed altitude is correct.*

What reason is there then to consider that the altitude is correct, and what will be the effect if it is incorrect?

When we take into account the haziness and uncertainty of the horizon, the difficulty of accurate observation on board a rolling ship, the varying effects of refraction, the imperfections of the sextant, and the personal error of the observer, it is probable that an average error of  $2'$  is a very moderate estimate.

Taking  $2'$ , therefore, as an average value, let us see

what will be its effect upon the typical examples in the text, worked first by the new process, and secondly by the old method of double altitude.

On page 30 an example (§ 32) is taken from Lecky, which will answer the purpose.

The data are as follows. Lat DR 32° 15' N.

|               | Times by chron. |       | Altitude. | Bearing.  |
|---------------|-----------------|-------|-----------|-----------|
|               | h. m.           | s.    |           |           |
| 11h. a.m. ... | 1 11            | 3' 8" | 50° 0' 0" | S. 25° E. |
| 3h. p.m. ...  | 5 11            | 1' 2" | 33 17 45  | S. 57° W. |

Sun's declination, 4° 59' 15" S. for first observation; 4° 55' 30" S. for second observation.

Let us suppose that an error of 2' occurs in the second altitude, the one treated for reduction to the meridian.

The error in latitude ( $dl$ ) produced by an error in altitude ( $dz$ ) is given approximately by the formula

$$dl = \sec A_1 \cdot dz,$$

where  $A_1$  is the azimuth of the body.

Thus  $dl = \sec 57^\circ \times 2'$ , or  $3' 40''$  nearly.

But if treated, so as to take in both observations, by the double altitude process,

$$dl = \frac{\sin A_2}{\sin (A_1 + A_2)} dz,$$

where  $A_1 = 57^\circ$ ,  $A_2 = 25^\circ$ , the azimuths being reckoned from south in each case. Thus

$$dl = \frac{\sin 25^\circ}{\sin 82^\circ} dz \text{ or } 51''.$$

So that in one case a reasonable error in altitude gives an error in latitude of nearly 4', in the other of less than 1'.

One other instance will perhaps suffice. On page 36 an example from Riddle is worked out, wherein an error of 2' in altitude would produce an error of 18' upwards in latitude.

Such a result at once condemns the observation. Indeed, for the purpose of accurate determination of latitude, the double altitude stands out among the various methods a very king. In other cases, as in the meridian altitude, we are satisfied if the latitude is no more in error than the original observation. In a double altitude, taken under advantageous conditions, only a fraction of the error in altitude appears in the final result.

It is somewhat remarkable that Mr. Buller's evident appreciation of Sumner methods has not made him more familiar with the main principles which apply equally to all classes of observations.

Every observation furnishes the observer with a circle upon the globe, a straight line upon the Mercator's chart, on which to place his position. The circle has the sun's projection on the earth for its centre. The line has the sun's line of bearing perpendicular to it.

If this line of position is inclined at a very acute angle to the meridian, that is, if the body observed is near the prime vertical, it is evident that a very small increase in the perpendicular drawn from the sun to the line of position, that is, a very small increase of zenith distance, will produce relatively a very large difference of latitude. And this condition, coupled with the impossibility of obtaining accurate altitudes at sea, is sufficient to account for the restriction of ex-meridian observations to a point or two in azimuth from the meridian.

The British seaman, therefore, had better pause before he throws overboard his Norie or his Raper, and takes to his heart the new Buller methods.

The greatest self-confidence, the most implicit belief in the reality of the mission to which he has been called, will not enable Mr. Buller to find the latitude accurately by a single altitude near the prime vertical, for the very simple reason that the error (even when supposed small) which must be expected

in the altitude produces a large error in the latitude, and thus vitiates the result.

If he would make the ex-meridian method available as he proposes to do, at almost any time of day, the author must supplement his treatise by the invention of some appliance for measuring altitudes very much superior to any now in use.

Pending its production the very pertinent question asked in page 36, "We have known long enough how to get a fairly correct A. T. S. from an observation near the Prime Vertical and the latitude D. R., but who has yet shown how to obtain the *True Latitude*?" must remain unanswered.

There is indeed freshness in the "New Method of Navigation," Part I., but no light. That perhaps will be supplied by Part II. G.

VOICES FROM ABROAD.

THE following literal translation of parts of an article recently published in the *Chemiker Zeitung* (Nos. 85 and 86, 1893) is an appropriate addendum to a recent article of mine in this journal. It must be sorrowfully admitted that in essential particulars the picture is a true one. HENRY E. ARMSTRONG.

"Notwithstanding the enormous industrial development of England, the appreciation of science by technical workers is inconceivably slight, the main cause being deficient comprehension. The Englishman is conservative in all his customs, in his way of living, and not less in his methods of manufacturing, so that there are still very many manufacturers who would be as little prepared to place the control of their works in the hands of a scientific chemist as to convert them into philanthropic institutions. At present great efforts are certainly being made to alter this condition of affairs by the aid of technical schools modelled on German lines, but opinions as to the value of these schools are as yet much divided; and, indeed, for various reasons their ultimate success is doubted. In the first place, it is to be borne in mind that these institutions are not under State control, but are governed and controlled by local boards. Moreover, the preliminary training which their students have received is not to be compared with that of students in the German institutions, as an education such as is given in the German Realschulen and Gymnasiums—of the character given in England at most by the grammar schools—is only procurable by those who are well off, owing to the enormously high school fees (about £20 or 400 marks a year). The possibility of consolidating and widening the technical training by a short subsequent course of scientific study at the University is absolutely out of the question in most cases, owing to its extreme costliness. It is therefore probable that these schools will but produce a number of half-educated persons who will take up positions as chemists and will thereby but bring the chemist proper into discredit.

"It is clear that under these circumstances there is but very little prospect that a chemist coming to England will find a suitable position. I cannot sufficiently strongly caution 'young chemists' against coming to England on the chance of picking up something good, even when provided with good introductions. So few analysts are in demand here that the chance of securing such a post is most uncertain. Works and laboratories in which scientific work is systematically carried on scarcely exist, not one even of the English aniline colour works having a scientific laboratory worthy of the name. The 'young chemist' has therefore very little chance of securing an appointment, as he does not possess the necessary qualification for a works post, that is to say experience,

and the volunteer nuisance is scarcely known here even by name. I can therefore only repeat that it is a very risky enterprise for a young, inexperienced chemist to come to England without a definite engagement, as so often happens. The result, with very few exceptions, is disillusionment, and many get into most unfortunate positions through financial pressure. The outlook is somewhat better for a chemist who has had experience and practice in works. But even such will find it infinitely more difficult to find posts in England than it is either in Germany or Austria, and will do well to go to England only when offered a definite appointment. The thorough scientific training and business capacity of the German chemist is unreservedly recognised by all unprejudiced judges in contradistinction to that of his English colleague. In carrying on routine operations, the English chemist is doubtless as competent as the German chemist, even if he be not his superior, but in conducting and developing chemical industries on a scientific basis the latter is far in advance of the former.

"I need refer but briefly to the great chemical industries, as they are well enough known. Of these the first to be mentioned is the soda industry, including that of sulphuric acid and chlorine; furthermore, tar-distilling, dyeing, calico-printing, the manufacture of iron, steel, copper, tin, and antimony, glass-making, the utilisation of fatty matters, the Scotch paraffin industry, and the manufacture of bichromate. These industries, excepting glass-making, employ a considerable number of chemists, although, in proportion to their output, not nearly so many as the German works. This is especially the case in dye works, calico-printing works, and in those dealing with fatty matters, many of which carry on their manufacture without chemists, or only with the aid of very imperfectly trained chemists, as every one here regards himself as a full-blown chemist who, after a most elementary preliminary training, has attended a technical course during one, or at most, two years. At least 80 per cent. of the chemists engaged in the industries mentioned are Englishmen, the remainder being either Germans or Swiss. I have never met a French chemist here. With few exceptions the condition of these industries during recent years must be characterised as dull and even as bad in some cases; they therefore offer the chemist little prospect of employment, and foreign capital is certainly not to be invested in them with advantage. Only dye-works and those utilising fatty matters offer a prospect to the experienced chemist, as these are both distinctly capable of being improved in position. The helpless condition of the English aniline colour works is peculiar, these having been simply stifled by the German works, which have developed with such giant strides. The English works eke out a miserable existence, and altogether do not employ as many chemists as are to be found in a similar German works of the fifth or sixth rank. Fuchsine, soluble blue, chrysoidine, Bismarck brown, and the few naphthol colours unprotected by patents, are almost the only colours manufactured. Not a single dyestuff of importance is made by any English firm alone, as scientific laboratories such as are a matter of course in every German works exist here only in the most rudimentary form. Most of the chemists engaged in English aniline colour works are German (?), but the demand for chemists in these works is very small. The erection of such a works in

England on the German model could only be achieved by the large German firms engaged in this industry; it is another question whether it would pay. But the manufacture of pigments—of mineral colours and lakes—is certainly capable of development here. It is true there are a number of such works, but these rarely employ a chemist, and still more rarely one who has had a thorough scientific training. Consequently, enormous quantities

of lakes are imported, especially for printing oil-cloths and carpets, which might equally well be manufactured on the spot. The necessary capital would be not an inconsiderable one, and may be estimated at, at least, 150,000 marks. Competent chemists in this branch can probably count on easily finding employment here.

"The manufacture of fine chemicals, which at present are almost entirely imported from Germany and France, is certainly capable of considerable development here. Of these may be mentioned especially, tannin, tartar emetic, pyrogallol, oxalic acid, cyanide of potassium, and most of the almost innumerable chemicals and preparations which are made use of in trade, and which are either not made here at all, or in altogether insufficient quantity and of poor quality. With reference to such articles, in the case of which wages form a considerable item in the cost of production, it is to be borne in mind that English wages are on the average considerably higher than German."

#### THE EFFECTS OF LIGHT ON THE ELECTRICAL DISCHARGE.

WHILE engaged on his classical experiments Hertz noticed that the appearance of the discharge between the two terminals of the oscillator was greatly changed upon the spark gap being illuminated by the light coming from another spark. This change was not due to an electrical action of the sparks, for it was equally well produced by other sources of light, such as the electric arc and burning magnesium, while all effect immediately ceased on interposing a plate of glass. Since the time when the above observations were made many experimentalists have investigated this subject and have obtained rather divergent results. In most cases the source of light employed has been the electric arc formed between carbon rods, though, with a view to increase the proportion of ultra-violet rays emitted, Bi hat and Blondlot used carbon rods with aluminium cores, while Righi used a zinc rod for one terminal. Other observers have used the spark of an induction coil passing between terminals of copper, zinc, or aluminium. While Hertz had only noticed that the illumination of the discharging knobs increased the facility with which sparks passed, Wiedemann, Ebert and Hallwachs found that it was only when the negative terminal was illuminated that this effect took place. More recent observations by Branly have led to this view being modified, for he finds that on illuminating a piece of zinc by the sparks of a large induction coil produced between aluminium terminals, if the source of light is sufficiently near to the plate, the loss of charge is nearly as rapid for a positive as for a negative charge. On increasing the distance between the spark and the charged plate, the decrease in the rate of loss of charge is much more rapid for positive than for negative charges, and thus at some distance from the source of light the negative charge is the only one which is appreciably affected. Hence radiation of certain kinds increases the rate at which a positively charged body loses its charge, just as in the case of a negative charge, but the rays which are active in the case of positive electricity are absorbed by even a small thickness of air, while those rays which are unabsorbed are still able to accelerate the discharge of a negatively charged body.

After having made a series of experiments in air at ordinary pressures, Stoletow on the one hand, and Righi on the other, have investigated the influence of pressure on the phenomenon, and have both found that the effect increases with a decrease of pressure, while Stoletow has shown that if the rarefaction is carried to the extreme limit there exists a pressure, after which the effect decreases as the pressure is further diminished.

An experiment of Bichat's seems to show that the loss

of electricity is due to convection currents, and this view has been further strengthened by Righi, who placed a plate of ebonite covered with tin foil on its upper side above a brass plate on which some figure, such as a cross, had been traced with varnish so that the plate was protected at these points from the effect of the illumination, the active rays being absorbed by the varnish. The negative pole of an electric machine was connected to this plate, the positive pole being connected to the tin foil, and the light of an electric arc allowed to fall on the under plate for a few seconds. The plate of ebonite being removed and powdered over with a mixture of sulphur and red lead a yellow cross on a red background was obtained of the same size as the one traced on the brass plate. As the sulphur attaches itself to those parts of the plate which are positively, and the red lead to those which are negatively charged, it follows that the parts of the lower plate which were not protected by the varnish have lost some of their negative charge, which has been carried on to the ebonite plate, and that this displacement has followed the lines of force of the electric field between the plates, which are in this case perpendicular to the two plates. This conclusion is further strengthened by observing that, if the electrified particles which escape from the lower plate are prevented, by means of a screen, from reaching the ebonite, a shadow of the screen is obtained.

The explanation that this convection is caused by the molecules of gas which, after being in contact with the body, become charged and are repelled, is hardly satisfactory, and the experiments of MM. Lénard and Wolf seem to show that it is particles of dust which carry the charge, for they suspended an insulated plate of metal in a box filled with air which had been carefully freed from dust. A plate of quartz fixed in one side of this box allowed the light from an electric arc to fall on the metal plate, while a stream of some vapour could be introduced through a side tube. Under these circumstances the vapour was condensed on allowing the light to fall on the plate if it was uncharged or negatively charged, while if the plate was positively charged no condensation took place. As it is known that a given space can become supersaturated with vapour when no dust is present, but that the introduction of the least trace of dust causes an immediate condensation, it appears that when a body either uncharged or negatively charged is illuminated it gives off some dust, and that the loss of charge is due to this dust. Further particulars of the work which has been done in this subject are given in a paper by M. Blondin in *Électricité*, p. 313, 1893. W. W.

NEOLITHIC DISCOVERIES IN BELGIUM.

THE fact that in Belgium flint was in certain districts largely worked during Neolithic times, for the manufacture of hatchets and other implements, has long been well known. The mines in the chalk near Mons, from which the rough blocks of flint were procured by the ancient flint-workers, have frequently been described, and bear a close analogy with the old workings at Grimes' Graves, near Brandon, and with the pits near that place, still being sunk by the flint-knappers of the present day. The fields in the neighbourhood of Mons have their surface strewn with roughly-chipped hatchets, and in other districts the occurrence of worked flints has been not unfrequently noted. In a memoir, recently published in the *Bulletin de la Société d'Anthropologie de Bruxelles* (Tome xi. 1892-93), M. G. Cumont has placed on record his discovery of two important Neolithic stations at Verrewinckel and Rhode-Saint-Genèse, neither of which places is far from the main road from Brussels to Charleroi, while both lie at but a short distance from the field of Waterloo. The forest of Soignes extended in early

times over the whole district, and though both stations are on promontories of high land, there are or were, in the neighbourhood of each, springs or ponds from which to obtain a supply of water and, possibly, of fish.

The principal of the two was that at Rhode-Saint-Genèse, whence, including flakes and scrapers, M. Cumont has obtained no less than 3591 worked flints, a few implements made of other kinds of stone being reckoned among them; while Verrewinckel is credited with 815 specimens. Of all the forms a good summary account is given, and characteristic examples are figured in five plates. A detailed map of the district is also given. That the manufacture was carried on at the stations is proved by the presence of upwards of 240 nuclei from which flakes have been dislodged; but few of these appear to have rivalled in size those of specimens near Mons. It is indeed suggested that the hatchets and larger implements were rough-hewn at Spiennes, and finished where they were found. That this was the case is further shown by the fact that some twenty *polissoirs* were collected by M. Cumont, who also regards the flint which forms the material of the implements as having been derived from Spiennes, Obourg, or the neighbourhood of Mons. Over a hundred arrow-heads figure in the lists, and some of these, as shown in the plates, exhibit skilful workmanship. A few quaternary or palæolithic implements from the same region have been described by M. Cumont in another paper. He is to be congratulated on the rich harvest that he has reaped by his labours, which have now extended over a period of eight years. J. E.

THE LATE SIR SAMUEL BAKER.

NOTHING impresses more vividly upon one the rapid unfolding of our knowledge of Africa than the fact that the pioneers who forced the first paths into the unknown interior have survived to see generation after generation of younger men, who followed in their footsteps, fall victims to the fatal fascination of that continent. Burton, Grant, and Oswell, the companion of Livingstone's earliest journeys, have died so recently that we realise with a feeling of sorrowful surprise that the last of the first great group of explorers has passed away in the person of Sir Samuel White Baker, on December 30, 1893.

He was born in London in 1821, and after his school education turned his attention to engineering, but his professional work never took so thorough a hold upon his mind as the love for travel and sport, which his private means fortunately enabled him to gratify to his heart's content. Baker first went to Ceylon for elephant shooting in 1845, and saw a great deal of the island in subsequent years. Two books resulted from this experience—"The Rifle and Hound in Ceylon," published in 1854, and "Eight Years' Wanderings in Ceylon," in 1855. The study which he made of the climate of the elevated part of Ceylon led him to establish a colony of English agriculturists, fully equipped with a stock of cattle and sheep, at Nowera Eliya, over 6,000 feet above the sea, which is now a noted health resort. On the death of his wife, in 1855, he went to the Crimea, and carried out some railway work subsequently on the Black Sea coast. In 1860 he married a Hungarian lady, who survives him, after being his devoted companion through the trying years of African adventures, and in the pleasanter wanderings of his later life.

In 1861 he went to Egypt, resolved to carry on an extensive scheme of exploration at his own expense. With this object he spent a year in Abyssinia, working out the complete hydrography of the Atbara and its tributaries, and then started from Khartoum to follow up the White Nile itself. In February, 1863, he met Speke and Grant at Gondokoro, returning from their great journey to the

Victoria Nyanza, and a year later Baker was able to supplement their discovery by arriving on the shores of the Albert Nyanza, the size of which he considerably over-estimated. He did not return to London until 1866, and found his fame as a traveller established. He received many honours, including that of knighthood and the gold medals of the Royal Geographical Society and the Paris Geographical Society; but in the following year, again accompanied by Lady Baker, he returned to Africa. The story of his first journey is recorded in two fascinating books—"The Albert Nyanza Great Basin of the Nile," in 1866, and "The Nile Tributaries of Abyssinia," in 1867. In 1869 he commenced the occupation of the upper White Nile provinces for the Egyptian Government, at the head of a body of Egyptian troops, and for five years laboured at the heavy task of restraining the slave-dealing Arabs and keeping in order his apathetic and often disaffected Egyptian subordinates. He established steam navigation on the Nile to the equator, and in his "Ismailia," published in 1874, told the story of the extension of Egypt. This completed his career as a pioneer and explorer; but a traveller he remained to the very end of life, and until last year he spent almost every winter either in Egypt or in India. He took a keen interest in the geography of Africa, and at critical moments in the course of recent developments in that continent he did not fail to give the benefit of his advice for the guidance of the country.

In 1879 he visited every part of the island of Cyprus, recording his impressions in "Cyprus as I saw it in 1879." The many reminiscences of his hunting adventures in every continent made his last book, "Wild Beasts and their Ways," a most valuable contribution to that liberal form of natural history which studies the lower animals as mankind is studied by the sociologist or historian rather than by the anatomist or physiologist. Baker was elected a Fellow of the Royal Society in 1869, and received the official recognition of several governments and innumerable learned societies in all countries for his services to geography and to humanity. His health kept up to within a month of his death, and to the last he remained a keen sportsman. He died in his residence at Sandford Orleigh, Newton Abbot, in Devonshire, and his funeral takes place at Woking to-day.

#### NOTES.

THE list of New Year honours contains the names of two men of science in the public service—Mr. Norman Lockyer, F.R.S., Professor of Astronomy in the Royal College of Science, and Mr. W. H. Preece, F.R.S., Engineer-in-chief to the General Post Office—upon both of whom have been conferred Companionships of the Bath.

WE note with much regret that Prof. Milnes Marshall, F.R.S., of the Owens College, Manchester, met with a fatal accident while ascending Scawfell, on Sunday, December 31. A notice of his life and work will appear in our next issue.

WE have to record the death of Mr. R. Bentley, Emeritus Professor of Botany in King's College, on December 24, at the age of seventy-two. Mr. Bentley became botanical lecturer at King's College in 1859, and three years later he was appointed professor of botany at the London Institute. He was twice—in 1866 and 1867—elected president of the Pharmaceutical Conference, and was well known for his works on pharmaceutical botany.

THE death is announced of Mr. R. Spruce, the well-known botanist and explorer, in his 67th year. Rather more than forty years ago Mr. Spruce visited South America on behalf of the Royal Gardens at Kew, and successfully carried out some very important scientific investigations. He explored the river

Amazon, and crossed the continent from the Atlantic to the Pacific. The introduction of the cultivation of cinchona into India was very largely the result of Mr. Spruce's work, and his fine collection of plants have done good service to commerce and to botanical science.

THE chair of Agricultural Chemistry in the University of Tokio has been accepted by Prof. Loew, of Munich.

MR. SMITH HILL has been appointed Principal of the Aspatria Agriculture College, in succession to the late Dr. Webb.

WE understand that the Queensland Government, in pursuance of their policy of retrenchment, have abolished the post of Government botanist hitherto held by Mr. F. M. Bailey.

PROF. W. H. CORFIELD has been appointed President, and Dr. P. F. Moline secretary, of the English committee of the International Congress of Hygiene and Demography to be held at Budapest this year.

DALZIEL'S correspondent at Copenhagen states that the time of Central Europe was adopted throughout Denmark on the first day of this year.

A PRIZE of 1250 francs is offered by the Natural History Society of Dantzig for the best means of destroying the poisonous insects in the forests of Western Prussia.

WE learn from the *Times* that the sum of £600 a year has been bequeathed to the trustees of the Mason College, Birmingham, by the late Mr. Aubrey Bowen, of Melbourne. In making the bequest the testator stipulates that the trustees shall apply the sum in founding six scholarships of £100 a year each in connection with the college, to be called respectively the first, second, and third Bowen scholarships, for the promotion of the study of metallurgy, and civil, mechanical, and electrical engineering; and the rest Priestley scholarships, for the promotion of the study of chemistry.

THE refusal of the S.P.C.K. to withdraw a book by Prof. Percy Frankland because in it experiments on living animals were approved, has led Lord Coleridge to address a letter to the secretary of the Society, in which he says: "I have learned from what seems unquestionable authority that those who administer the affairs of the Society for Promoting Christian Knowledge have finally determined to range the society in the number of those favouring the practice of vivisection and advocating its horrors. It is my duty, as I regard it, to separate myself at once from such a body, and I have accordingly directed Messrs. Childs not to pay any further subscription to the society. As I informed you of what I should feel bound to do in the events which have happened, I shall not occasion the society any inconvenience."

THE following officers of sections have been appointed for the meeting of the Australasian Association for the Advancement of Science, to be held at Brisbane this year:—Section A—Astronomy, Mathematics, and Physics: Vice-presidents, Mr. Clement Wragge and Mr. John Tebbutt; secretary, Mr. J. P. Thomson. Section B—Chemistry: Vice-president, Mr. J. B. Henderson; secretary, Mr. G. Watkins. Section C—Geology and Mineralogy: Vice-president, Mr. W. H. Rands; secretary, Mr. Hargreaves. Section D—Biology: Vice-presidents, Dr. A. Dendy, Mr. F. M. Bailey, and Mr. J. J. Fletcher; secretary, Mr. J. H. Simmonds. Section E—Geography: Vice-president, Mr. D. S. Thistlethwayte, C.E.; secretary, Major A. J. Boyd. Section F—Ethnology and Anthropology: Vice-presidents, Rev. James Chalmers and Mr. E. M. Curr; secretary, Mr. Archibald Meston. Section G—Economic Science and Agriculture: Vice-presidents, Mr. G. A. Coghlan and Mr.



James Tolson; secretary, Mr. Wm. Soutter. Section J—Mental Science and Education: Vice-presidents, his Grace Archbishop Dunne, Mr. G. J. Anderson, M.A., and Mr. D. Cameron.

An earthquake shock was felt in Shepton Mallet, Somerset, and neighbourhood on December 30, about 11.30 p.m., and another shortly after midnight. The direction of motion of the waves was apparently from north to south. Prof. F. J. Allen sends us the following description of what was noticed by some friends of his. "At about 11.20 p.m. a shock was felt by three persons in one house; and about an hour later a second and more severe shock was observed by two of these persons. In another house, a quarter of a mile distant, three distinct shocks were felt by several persons. Both these houses are situated on the south side of the valley, whereas the reports published in the papers refer more particularly to movements observed on the north side. For those who are not acquainted with the district, I would mention that the strata (Carboniferous limestone, with overlying Trias, Lias, and Oolite) are very much disturbed, and present many interesting studies of horizontal as well as vertical faulting. It is just the kind of spot in which one might expect to have superficial movements occurring from time to time."

A LETTER from Prof. S. J. Bailey, of the Harvard College Observatory, to the editor of *La Bolsa*, published at Arequipa, Peru, gives an account of the establishment of the meteorological station on the summit of the Misti, in the Peruvian Andes, at an altitude of 19,300 feet above sea level, this being at present the highest observatory in existence. The fatigues undergone by observers ascending the conical peak from Arequipa are such as to render exact observations impossible, and it was therefore found necessary to construct a mule-path to the summit from a stone hut erected at an elevation of about 16,000 feet. This hut was erected on the north-east slope, being the most accessible side of this peak, which maintains its aspect of an isolated symmetrical cone from all points of view. On September 27 the summit was reached by Prof. Bailey, his assistant, several Indians, and two mules. The latter could hardly be made to go more than twenty paces without a rest. On October 12 the summit was revisited with two members of the Arequipa observatory, twelve Indians, and thirteen mules carrying materials for erecting two huts, and the registering meteorological instruments, comprising a barograph, a thermograph, several mercury thermometers, an hygrometer and anemometers. Each of the registering instruments works for ten days, and a member of the observatory will visit the station three times a month. A store of provisions is kept at the stone hut, and of the wooden huts at the top, one, provided with double wooden walls, is intended for the observer, the other for the instruments.

WITH regard to meteorological work in Australia, Sir Charles Todd remarked at the last meeting of the Australasian Association for the Advancement of Science, that in New South Wales there were 175 meteorological stations and 1063 rain gauges; in Victoria, 31 meteorological stations and 515 rain gauges; in South Australia, 22 meteorological stations and 370 rain gauges. In Australia there were 385 meteorological stations and 2580 rain gauges. During the last four years the forecasts issued in South Australia have been justified to the extent of 73 per cent., partially justified 20 per cent., and wholly wrong 7 per cent.

THE radius of curvature of the cornea, together with the indices of refraction of the various refractive media of the eye, constitute the experimental data for determining the most important points about the eye. Drs. H. C. Chapman and A. P. Brubaker have measured this radius in fifty individuals by means

of the ophthalmometer (Proc. Acad. Nat. Sci., Philadelphia, 1893, p. 349), and they have found that in the average young man it amounts in the horizontal meridian to 7.797 mm., and in the vertical meridian to 7.552.

THE Director of the Central Meteorological Observatory of Mexico, Señor M. Bárcena, has published an interesting pamphlet on the climate of the city of Mexico, based on the hourly observations of sixteen years 1877-92. Mexico, from its position of 7431 feet above the sea, and latitude 19°, might be supposed to be subject to great extremes of temperature, but as one geographical element neutralises the other, the result is a temperate and agreeable climate. The mean annual temperature is 59°.7, and the monthly means vary from 53°.6 in December to 64°.6 in May. The absolute maxima in the shade vary from 73°.4 in December to 88°.9 in April, while the absolute minima vary from 28°.9 in December to 46°.8 in August and September. The greatest daily range amounted to 41° in the month of March. The mean annual rainfall amounted to 23.8 inches, the wettest months being June to September; the greatest fall in one day was 2.5 inches in August 1888. The prevalent wind is north-west, which blows during most part of the year, and is the coldest and wettest quarter. The strongest wind blows from the north-east; the greatest hourly velocity observed during the sixteen years was about 56 miles per hour.

A DETAILED investigation of the properties of mirror silver chemically precipitated on glass is published by Herr H. Lüdtke in *Wiedemann's Annalen*. The three modifications of silver obtained in the wet way, termed by H. Vogel the arborescent, the powdery, and the mirror variety respectively, have been recently enriched by Mr. Carey Lea through his discovery of colloid silver. Herr Lüdtke thinks that this last variety and mirror silver are closely allied; that the latter, when newly formed, is indeed identical with the former. The electrical resistance of several varieties of mirror silver decreases considerably with their age. No such decrease was, however, observed in the case of mirrors produced by Martin's process or by that of Liebig, *i.e.* reduction by means of milk-sugar. On introducing a pole of ordinary silver and one of allotropic mirror silver into a weak acid or salt solution, and closing the circuit, a current was obtained indicating a difference of potential of about 0.1 volt between the two varieties, the allotropic variety being the positive pole. These conditions were reversed if the solution was one of silver nitrate, but the difference of potential was less. Lehmann's surmise that the precipitation of the mirror on the glass is due to a thin layer of sodium silicate, was invalidated by precipitating it on mica, porcelain, quartz, and platinum by the same methods.

THE *Philosophical Magazine* for the present month contains a paper, by H. Nagaoka, on the hysteresis attending the change in length produced by magnetisation in nickel and iron. The author at first used the interference fringes produced between a plano-convex lens and a plate of plane glass attached to the end of the rod under examination to measure change in length. He found, however, that it was impossible to keep the temperature of the apparatus constant during the time necessary to make an observation, and also that there was considerable difficulty in counting the number of fringes displaced. To overcome the temperature difficulty the author has made use of the principle of the gridiron-pendulum, and has by this means succeeded in almost entirely overcoming this difficulty. In place of the interference bands he uses an optical lever, that is, a mirror fixed to a small base, to which are attached three needle points, two of these rest in a groove on the base-plate of the instrument, while the third rests on a small glass plate fixed to the end of the iron or nickel rod. The rod was placed along the axis of a solenoid which lay in a horizontal position pointing

magnetic east and west. The deflection of the mirror was measured by means of a microscope with a micrometer eyepiece, such that one division of the scale corresponded to a deflection of the mirror of  $0^{\circ}295$  of arc, or to an elongation of  $0.805 \times 10^{-7}$  c.m. Experiments were made on wires of iron and nickel of different lengths, and he finds in every case that the elongation in iron and the contraction in nickel by magnetisation is accompanied by marked hysteresis. The curve of hysteresis is symmetrical with respect to the line of zero magnetising force, so that the elongation or contraction during cyclic changes is an even function of the magnetising force. When a wire has been magnetised it cannot be brought to its original length by simply reversing the magnetic field.

IN a note communicated to the same number of the *Philosophical Magazine*, Prof. Knott calls attention to the similarity between the effects observed by Mr. Nagaoka, and those which he has himself observed in the case of magnetic-twist cycles for iron and nickel. A steady current was passed along the wire under observation, and the longitudinal field acting on the wire was gradually altered between the limits  $\pm H$ , and at suitable intervals observations of the twist made. It was found that with a small range of field the hysteresis curve obtained by plotting twist against field was very similar to the well-known hysteresis curve of magnetisation. With limiting fields, however, stronger than the field which produces the maximum twist, the hysteresis curve crossed itself twice and formed three loops. In the magneto-elongation cycle the change of sign of the magnetising force does not produce a change of sign in the elongation. On the other hand, in the magnetic-twist cycle, as the magnetic force passes through zero from positive to negative, the twist tends to do the same, though with a lag. The author considers that the twist, under a given combination of circular and longitudinal magnetising forces, depends not only upon the elongations but also upon some function of these forces which changes sign with each, and to which the existence of the maximum twist is largely if not entirely due.

AN entertaining chapter on minerals, and the popular superstitions connected with them in Germany, is contributed to *Die Natur* by Friedrich Klinkhardt. The fact that variety among minerals is less easily perceived than that among plants and animals, is emphasised by the great influence that "a stone" pure and simple, without further specification, is capable of exerting in the popular estimation. Children under the age of one may not play with stones, otherwise bread will be scarce. An ill omen may be made innocuous by throwing a stone into the road before taking the next breath. Chalk is credited with many virtues, and is used both for its own efficacy and for making signs with. Cows marked all down the spine with chalk consecrated at Epiphany, remain healthy, and always find their way home. Alabaster in water is used for curing sick children in Bohemia. A flint pebble from the brook, if thrown over the roof into the poultry yard, encourages the hens to lay eggs. The beliefs connected with "thunderbolts," which are sometimes flint instruments, or quartz crystals, or lightning tubes, are exceedingly numerous. In the Palatinate it is believed that thunderbolts, after penetrating seven yards into the ground, rise a yard every year; this reminds one of Mjolnir, Thor's hammer, which returned to his hand.

WE read an interesting paper "On the Kulm District of Lenzkirch in the Black Forest," by Dr. Rafael Herrmann. A geological map of the district is given, scale 1 : 50,000 (*Berichte der Naturforschenden Gesellschaft zu Freiburg i. B.*, June, 1893). In the Black Forest, just as in the Hartz and in Thuringia, two main series of carboniferous rocks are recognisable, an older group of dark shales, and a younger formation of conglomeratic rock. During the intermediate epoch, the upraising and folding

of the rocks took place, associated with intrusions of crystalline rock. The eruptive rocks of the district are granite, coarse and fine grained, granitite, granitic dykes, quartz porphyry, porphyritic dykes, and porphyritic breccias. Herrmann does not agree with Vogelgesang that the granite and granitite are petrographical varieties of one and the same rock united by a complete transitional series, but regards them as two independent masses of rock, differing in composition and structure. All the granitic rocks have been intensely affected by pressure, whereas the younger porphyry shows no appearance of it. Herrmann deduces, therefore, that the intrusion of porphyry marks what was probably the last phase of folding and overthrusting of rocks in the Black Forest during the Carboniferous period.

THE region watered by the upper part of the Yenisei (which is known to the Mongols under the name of Ulu-Khem, and is made up by the confluence of the Bei-khem and the Kha-khem) belonged until lately to the least known parts of north-west Mongolia. The opinion expressed in the "General Sketch of the Orography of East Siberia" (*Zapiski of the Russian Geographical Society*, vol. v. 1874), to the effect that it must be a high plateau, and that the so-called circular chain Erghek-targak-taiga is nothing but a border ridge, or often but the steep slope of the plateau, had been contested. Now it finds its full confirmation in the recent exploration of the region by Mr. Kryloff, published, with a map, in the *Izvestia of the Russian Geographical Society* (vol. xxix. 4, 1893). The whole region really has the above-mentioned character. After having left the valley of the main river, which has, even at the junction of the two Khems, an altitude of 1873 feet, Mr. Kryloff had to travel all the time on the level of the high plateau, never finding altitudes less than 3000 feet, till he returned to the Russian dominions in the basin of the Tuba. Mr. Kryloff's journey having been performed for the St. Petersburg Botanical Garden, special attention has been paid by the explorer to the flora of the region; and he found that the vegetation on the plateau assumes in many places the character of a Steppe vegetation, namely, in the flat but high valleys of the rivers, which are dotted by numerous small lakes. At the sources of the Bei-khem, the flat surface of the water parting, as well as large portions of the plateau itself, raise above the level of the tree-vegetation, usually marked by the cedar, and are covered with Alpine meadows. As to the ridges which rise above the surface of the plateau, they attain heights of over 7000 feet, and over 8000 feet in the Tannu-ola ridge in the north of Lake Ubsa-nor.

THE same number of the *Izvestia* contains a paper by M. M. Pomortseff, on his extremely valuable observations on the directions and angular speed of motion of clouds. The method resorted to for these observations is described at length, and the instrument which was used for this purpose is figured on a plate. The chief results are given on 94 separate small maps. The author himself sums up his results as follows:—(1) The middle of the cumulus clouds moves almost in the direction of the isobar which passes through the place of the observer. (2) The cirrus, cirro-cumulus, and cirro-stratus clouds move on a pretty long distance as a broad and nearly straight-line current—the direction of the stream being almost parallel to the part of the 760 mm. isobar which stands on the line connecting together the centres of two nearest and contiguous regions of high and low pressure. (3) There is doubtless a connection between the distribution of atmospheric pressure and the march of the barometer on the earth, and the vertical circulation of the atmosphere; but this connection does not extend farther than the height of the upper, *i.e.* cirrus clouds.

IN a letter addressed to the Russian Geographical Society from Lan-chou, in March last (*Izvestia*, vol. xxix. 4), Mr.

Obrucheff wrote that while crossing the plateau of Shan-si, he was enabled to supplement to some extent the observations of Richthofen; namely, he has discovered some fossil plants in the middle parts of the series of deposits which cover in China the carboniferous formation, and which Richthofen had described under the names of *Ueberkohlen-sandsteine* or *Plateau-sandsteine*. The plants unearthed by Mr. Obrucheff would indicate that the middle portions of this formation belong to the Mesozoic age, and are Triassic or Liassic. This formation spreads from Shan-si into the Shensi, the Alashan, and Gan-su, without losing in thickness, and probably represents an uninterrupted series of deposits from both the Mesozoic and the first half of the Cainozoic times.

WE notice in the *Memoirs (Trudy)* of the Kazan Society of Naturalists (vol. xxvi. No. 2) a very interesting work by N. Wnukow, on the bacilli of leprosy. In addition to his own experimental researches, the author has carefully studied the West European and Russian literature of the subject, and has divided his memoir into three parts: the localisation of leprosy bacilli in the tissues of the human body; the inoculation of the bacilli to animals; and the artificial culture of the bacilli. The paper is accompanied by a coloured plate. The author's conclusions are:—The *Bacillus lepræ* is motile, and is found both within and outside the cells; but it has never been discovered in the cells of the epithelial layers of the skin or the mucous membranes. In the wounds the bacilli are brought to the surface, and undoubtedly may be transported on the skin of other individuals, thus becoming a cause of infection. Neither the injection of the pus containing leprosy bacilli, nor the grafting of pieces of skin taken from leprosy patients to rabbits, could provoke leprosy in these animals. The bacilli introduced from man into rabbits and fishes, diminish in numbers after a time, and ultimately disappear. Most inoculated rabbits contract tuberculosis, but the illness must be ascribed in such cases to other causes than infection proper. As to the artificial culture of the *Bacillus lepræ*, it has failed with all culture media experimented upon by the author; the culture of *B. Uffreduzzi*, described by Eisenberg as leprosy, cannot be recognised as such.

AN elaborate paper, entitled "Les Vibrions des Eaux et l'Étiologie du Choléra," by Dr. Sanarelli, has recently appeared in the *Annales de l'Institut Pasteur*, vol. vii. Numerous bacteriological examinations were made of the river Seine water above and below Paris, as well as of drain water, and the effluent of sewage after irrigation. In all no less than thirty-two vibrios were isolated, morphologically distinct, four of which gave the indol reaction, and in their pathogenic action on guinea-pigs could not be distinguished from the cholera-bacillus. Dr. Sanarelli is of opinion that there exist many varieties of vibrios, morphologically distinguishable, but capable of exciting in man and animals a disease in its morbid and clinical aspects identical with those regarded as typical of cholera, and that the conception of a restricted monomorphism is no longer tenable in the diagnosis of the cholera-vibrio. In all the more or less contaminated waters which were examined vibrios were present, finding in these surroundings conditions highly favourable to their existence and multiplication. It is possible that although the larger number of such vibrios may exist in the saprophytic or harmless state, yet probably pathogenic vibrios are more frequently present in such waters than has hitherto been suspected. Dr. Sanarelli points out that the saprophytic condition of some at least of these vibrios is, in all probability, due to the modification in and attenuation of their biological functions which residence in such media has produced. Thus an extremely virulent vibrio was reduced to a harmless saprophyte deprived of its pathogenic properties and power of

producing the indol reaction, by being kept in boiled Seine water for a month, whilst even after three months it had undergone no change in its morphological condition. In the same manner that pathogenic organisms may be deprived of their virulence, it is conceivable that circumstances may arise under which they may recover their toxic character; so far, however, bacteriology has been unable to establish the correctness of this hypothesis, either in the laboratory or in actual experience.

FOR several years the State of Massachusetts has been attempting to exterminate the Gipsy Moth, and a Bill has recently been introduced into the House of Representatives to appropriate 100,000 dollars to rid the State of that troublesome insect. The *American Naturalist* points out, however, that the desired end can never be attained by merely hunting the moths in trees, hedgerows, and garden patches. In its future work, the Gipsy Moth Commission of Massachusetts should employ at its head a trained entomologist who should devote his time to finding and introducing some natural enemy to the pest. Moths, eggs, larvæ, and cocoons will escape the most careful of field agents, whereas insect parasites will keep the pest in continual check.

MESSRS. T. D. A. COCKERELL AND WALTER E. COLLINGE have published "A Check-list of the Slugs." It is a reprint from the *Couchologist*, vol. ii., 1893. The authority for the list is the first-named author; Mr. Collinge adds an appendix and notes; 628 species are recorded with very numerous varieties. There would appear to be a very ardent discussion as to the respective value of morphological and anatomical characters for the due determination of the species and varieties among these molluscs; but surely here, as elsewhere, the rational method would be to employ all such points of difference, whether external or internal, as may be found constant.

THE Association for the Promotion of Home and Foreign Travel has issued a programme of tours arranged for this winter.

THE December number of *Insect Life* is almost entirely taken up with the proceedings of the meeting of the Association of Economic Entomologists, held at Madison in August last.

MR. C. MELDRUM, the Director of the Royal Alfred Observatory, Mauritius, has issued his report for the year 1891, and also the results of meteorological observations made at the Observatory during 1892.

A PAPER on "Technical Education in Glasgow and the West of Scotland: a Retrospect and a Prospect" read before the Philosophical Society of Glasgow in November last, by Dr. Henry Dyer, has been issued in pamphlet form. It is of interest to all concerned with matters of technical instruction.

MR. W. WARDE FOWLER, a disciple of Gilbert White, has put on record his observations of the Marsh Warbler (*Acrocephalus palustris*) in Oxfordshire and Switzerland, and the differences between it and the Reed Warbler. His paper (issued by Simpkin, Marshall, & Co.) will be read with pleasure by all lovers of nature.

THE number just issued of the *Journal of the Royal Agricultural Society* (vol. iv. part 4) contains several important articles. Mr. Carruthers describes the "Cross-fertilisation of Cereals," and his paper is given additional interest by means of seven good illustrations. "Water in Relation to Health and Disease" is treated by Prof. J. Wortley Axe, and under the title "Peat and its Products," Dr. Fream gives an account of the occurrence and utilisation of peat in various peat-producing countries of Europe.

MESSRS. BAILLIÈRE AND SON have recently added to their series of works on chemical industries a volume entitled "Le

Cuivre," by M. Paul Weiss, in which the origin, mode of occurrence, properties, metallurgy, applications, and alloys of copper are fully treated. The author has visited the chief copper mines and works in Europe, and his book is a very useful *résumé* of the fundamental principles of the copper industry. The ninety-six figures inserted in the text include twelve excellent sections illustrating the molecular structure of various metals and alloys.

THE structure of snow-crystals photographed by G. Norden-skiöld formed the subject of an article in our last volume. Another important contribution to the subject has recently been published, namely, Prof. G. Hellmann's "Schneekrystalle" (Rudolf Mückenberger, Berlin). The work begins with a brief history of the study of snow-crystals, illustrated by reproductions of the various forms observed and drawn by different observers, from the spikes, crescents, and daggers of Magnus in the sixteenth century, to the elaborate and perfectly symmetrical stars designed by Glaisher. But in meteorology as in astronomy, photography is rapidly taking the place of the observer; so much, indeed, is this the case that the modern meteorologist and physical astronomer views visual observations with more or less suspicion. At any rate, the remarkably fine series of micro-photographs of snow-crystals obtained by Dr. Neuhaus during the winter 1892-3, and reproduced in Prof. Hellmann's work, indicates that eye-observations of their forms are no longer necessary. After discussing the structure of snow-crystals, Prof. Hellmann proposes a classification into tabular and columnar crystals, the former class being subdivided into radiating stars, plates, and a combination of the two, and the latter into prisms and pyramids. A descriptive bibliography is given, thus increasing the value of a work upon a subject of which much more can yet be said.

THE cause of the violent explosion which usually occurs when any considerable quantity of metallic sodium is brought in contact with water in a more or less confined space, forms the subject of a communication to the *Journal für praktische Chemie*, by Prof. Rosenfeld. It has been hitherto supposed to be due to the formation of a quantity of sodium peroxide, by the decomposition of which oxygen is liberated, which mixes with the hydrogen produced in the main reaction, thus forming an explosive mixture. Prof. Rosenfeld has fully investigated the question experimentally. It was first established that steam may with impunity be passed over sodium contained in a slightly bent iron tube, no explosion ever occurring under these conditions. This would be quite compatible with the above explanation of the cause of the explosions, for any explosive mixture would be rapidly carried from the seat of the reaction by the escaping hydrogen or the excess of water vapour. No oxygen, however, was ever detected in the gas thus liberated. In all the experiments in which explosion was brought about by the action of water, whether in open vessels or in vessels closed by a water column, it was invariably observed that the sodium was blown to powder from the centre outwards—that is to say, the seat of the explosion was the interior of the piece of metal experimented with. Prof. Rosenfeld comes to the conclusion, from the whole of the phenomena observed, that the explosion is brought about by the sudden dissociation of a hydride of sodium which is formed in the first stage of the reaction. As such a compound can only be produced in an atmosphere of hydrogen, the only safe mode of decomposing water by metallic sodium is considered to be that previously mentioned, of passing a rapid current of steam over the metal; for the hydrogen is then removed from the sodium as quickly as it is produced, and the formation of hydride, and therefore all risk of explosion, is

consequently avoided. In order to carry out this reaction an iron crucible is best employed which is capable of being closed in a gas-tight manner by means of an iron plate, which can be pressed firmly down against a flange on the edge of the crucible by means of a screw threading through a suitably supported nut. Steam is blown into the body of the crucible containing the sodium by means of a side tube, and the escaping hydrogen is led away by a similar tubulus upon the other side. If the supply of steam is arrested the moment hydrogen ceases to escape, solid caustic soda is obtained, mixed in a curious manner with more or less finely divided iron, probably owing to the formation of a quantity of an alloy of iron and sodium, which is subsequently decomposed with liberation of iron. Silver is likewise attacked in a similar manner. The method may also be employed to prepare solutions of soda of known strength. Thus, if twenty-three grams of sodium are employed, and the escaping hydrogen is washed through a little water, an exactly normal solution of soda can at once be obtained by dissolving the product in water, adding the wash water, and making up to a litre.

AN interesting investigation of the amount and nature of the gases occluded in the coal derived from several collieries in the Durham coal field has been carried out by Mr. W. McConnell, of the Durham College of Science. The collieries from which samples were taken are situated at different points along the same seam, known in Durham as the Hutton seam. It is bituminous coal used as gas-coal and as steam-coal. The coal or coal-dust was placed in an apparatus constructed entirely of glass, and which was capable of continuous exhaustion while heated in baths to known temperatures varying from 100° to 180°; the gas previously occluded by the coal was delivered by the pump into a receiving gas-holder, and subsequently measured and analysed. The coals from the Ryhope colliery were found to contain as combustible gases considerable quantities of occluded free hydrogen, marsh gas, ethane, and other members of the paraffin series of hydrocarbons as far as pentane. Moreover, a portion of the gas, consisting chiefly of the higher members of the paraffins and smaller quantities of olefines, is so firmly retained that crushing to fine powder and heating to 180° under reduced pressure is insufficient to remove it. It is also singular that the coal retains a remarkably high proportion of free oxygen in the occluded form, even after heating to 180°. In the case of the Hebburn colliery, a notably "gassy" mine, in which frequent "blowers" are met with, the results are especially interesting. The "blowers" deliver such large quantities of gas that some of it is actually "piped" up to the bank and burnt under the boilers. The combustible constituent of the gas thus utilised is found to be entirely marsh gas. The coal itself is found to contain a relatively very large volume of occluded gas, the combustible constituents being mainly marsh gas and ethane; and the ground coal and coal-dust yield in addition considerable quantities of higher members of the paraffin series. From the whole of the results derived from the various collieries, there can be no doubt that the coal-dust largely owes its sensitiveness to ignition to the denser occluded gaseous hydrocarbons which it retains so tenaciously.

THE additions to the Zoological Society's Gardens during the past week include a Leopard (*Felis pardus*, ♂, black variety), from India, presented by the Duke of Newcastle; a Herring Gull (*Larus argentatus*) from Jersey, presented by Mr. John Stanton; an Alligator (*Alligator mississippiensis*) from the Mississippi, presented by Mr. C. Knox Shaw; a Diamond Snake (*Morelia spilotes*) from Australia, presented by Commander A. Burgess, R.N.R.; and a Diamond Snake (*Morelia spilotes*) from Australia, purchased.

OUR ASTRONOMICAL COLUMN.

PRIZES AT THE PARIS ACADEMY.—Among the numerous prizes presented by the Paris Academy (*Comptes Rendus*, No. 25, Dec. 18), those devoted to the science of astronomy were as follows:—M. Schulhof, the Lalande Prize, for his magnificent researches on comets; Dr. Berberich, the Valz Prize, for his well-known connection with the calculations of cometary and (minor) planetary orbits; and Prof. Langley, the Janssen Prize, for the work he has done relating to the distribution of the heat in the normal solar spectrum, and to the influence exerted on this distribution by both the solar and terrestrial atmospheres. Among the general prizes we notice that the Arago medal has been awarded to two American astronomers, Profs. Asaph Hall and Barnard. The former receives this medal as he was the discoverer of the two satellites of Mars, although on a former occasion he was the recipient of the Lalande prize for the same reason. The latter, it is needless to say, owes this honour to the fine use he made of the great 36-inch telescope of the Lick Observatory, in searching out the fifth, or, as it should be named, the first satellite of Jupiter.

THE TAIL OF COMET BROOKS (c 1893).—Last week, under this heading, we referred to Prof. Barnard's remark that the fall of this comet had encountered some outside or obstructive medium. It is interesting, in the face of this, to look at the drawings of the great comet of 1882, and to notice the fragments and their relative positions and forms. With the drawing before us (Young's "Astronomy," 1888, p. 427) the following description is given:—"Besides this" (referring to that curious phenomenon called the *sheath*) "at different times, three or four irregular shreds of cometary matter were detected by Schmidt, of Athens, and other observers, accompanying the comet at a distance of three or four degrees when first seen, but gradually receding from it, and at the same time growing fainter. Possibly they may have been fragments of the tail which belonged to the comet before passing perihelion, or of the matter repelled from the comet when near perihelion. Since the comet, in passing the perihelion, changed the direction of its motion by nearly 180° in less than three hours, it was, of course, physically impossible that the tail it had before the perihelion passage could have made the circuit of the sun in that time. . . . Visible or invisible, the particles of the old train must have kept on their way under the combined action of the sun's gravitation and repulsion. . . ." Would not a more simple explanation in this case be that these fragments were the result of collisions near perihelion passage, for here most certainly we should expect to be in the presence of meteoritic matter in abundance, and these travelling at high speed?

THE PLANET VENUS.—This planet, which forms such a brilliant object in the evening sky, will during this month become brighter, reaching its maximum brilliancy on the 10th of January. For observers in northern latitudes its position is becoming more favourable for observation, owing to its movement northward in declination. A conjunction with the moon takes place on the 10th of January, so that about the day before and after that date these two bodies will form a striking pair.

GEOGRAPHICAL NOTES.

WITH the first of January the weekly South German geographical paper, *Das Ausland*, edited by Dr. Sigimund Günther, of Munich, and established as long ago as 1827, comes to an end, having sunk its identity by amalgamating with *Globus*, which for thirty-two years has been its North German contemporary and rival. *Globus* will continue to be published, with numerous illustrations, as heretofore, and with the additional attraction of Roman type being substituted for the old German character. It is somewhat remarkable that weekly papers of this kind, entirely devoted to geography and travel, with no political purpose, should be so thoroughly established in Germany and France, while no successful attempt has ever been made in an English-speaking country to start a similar publication.

THE Russian geologist, W. A. Obrucheff, who started in the early part of 1893 for a journey into the little known region of Ordos, lying in the great bend of the Hoang-ho, has (says *Globus*) been able to make many new observations. Leaving Tai-Yuen-fu, the farthest point reached by Richthofen in this

direction, on January 18, and crossing the Hoang-ho on the ice on the 28th, he selected the route to Ning-hsia, across the south-western edge of Ordos, as the least known, with the intention of proceeding to study the mountains of Alashan and the left bank of the Hoang-ho, up to the Nan-shan range. On his way Obrucheff was able to throw some light on the hills between the plateau of Shan-si and Kansu, and the plain of Ordos, which he found to be only the denuded edge of the plateau, and in no sense a range. The portion of Ordos which he intended to cross is a blank on all maps, and the whole district in the great bend of the Hoang-ho north of the Great Wall is practically unknown territory.

THE last number of the *Verhandlungen* of the Berlin Geographical Society contains a short note on a journey to Hadramaut undertaken last year by a German explorer named Hirsch, whose experience gives some clue to the difficulties now being encountered by Mr. and Mrs. Bent. At the outset Herr Hirsch met with opposition from the British Resident at Aden, but overcoming this he reached Makalla and started for the interior, with two camels and a small party, on July 1. He ascended the Wadi Howere to the great plateau, and crossed the watershed at an elevation exceeding 6,000 feet. From the barren plateau Hirsch descended to the fruitful and populous Hadramaut valley, several of the towns of which were visited. At Terim he was very badly received, subjected to insults, and compelled to leave at very short notice, returning to Makalla through the scarcely known Wadis Bin Ali and Odyim. Altogether the journey in the interior only lasted forty days, but observations of considerable value were made, which are now being prepared for publication.

A REMARKABLE discovery has been announced by the Austrian Institute for Historical Research, in the form of a copy of a map by Columbus, drawn on a letter written from Jamaica in July, 1503. This, although only a rough pen-and-ink sketch, shows exactly the opinion of Columbus himself as to the part of the world he had reached, which he believed to be the east coast of Asia. The original map, drawn by Columbus and his brother Bartholomew, was presented to Frate Hieronymo, who gave the map and a description to Alexander Strozzi, a noted collector of early voyages. He is supposed to have copied the original map on the margin of the letter of Columbus, which he had bound in a volume with other documents, and this volume is now in the National Library at Florence, where the existence of the map was discovered by Dr. R. v. Wieser, the Professor of Geography at Innsbruck.

NEW FRENCH LAW FOR THE PREVENTION OF FOREST FIRES.<sup>1</sup>

THE wooded tract of country comprising the hill ranges of Les Maures and l'Estérel in the departments of Le Var and Les Alpes maritimes, in the south-east of France, has been annually ravaged by forest fires from time immemorial. It is stocked with conifers, *Pinus Halepensis*, and *P. Pinaster*; the cork oak, and the pubescent variety of *Quercus sessiliflora*, and there is a dense undergrowth of *Erica arborea*, the roots of which are used for briar (*bruyère*) pipes, also of *Erica scoparia*, lavender, juniper, broom, dwarf palms, wild olive, and *Arbutus*, &c. During the months of June, July, August, and September, the drought, high temperature, and the violent *mistral* wind which prevail, increase the danger from forest fires and their severity.

Owing to the great destruction of property which these fires cause, a law was enacted in 1870, to be in force for twenty years, and has given excellent results, the frequency and extent of forest fires in the region having diminished by half during the period 1870-90. This law was renewed up to the present time, in order to allow Government to draw up a permanent law on the subject. The Minister of Agriculture accordingly drafted a bill, which, after consideration by a Committee of the Chamber of Deputies, and some unimportant amendments, was passed by the legislature, and received the consent of the President of the Republic, as a law, on August 19, 1893.

The principal clauses of the Act deal with methods of prevention and extinction of fires: thus the first clause prohibits, during the dangerous season above mentioned, all fires in forests

<sup>1</sup> The text of this Law is given in the *Revue des Eaux et Forêts*, vi. xix. part 18, for September 25, 1893.

or shrubby waste lands, or within a distance of 200 metres from their boundaries. The period during which these fires were declared illegal by the former Act of 1870, was fixed annually by the prefects, but experience has shown that it can now be fixed once for all by the law. As exceptions to this law, Clause 2 also authorises the prefects to allow charcoal-makers and other woodmen to light fires at their own risk, in case of damage arising, and subject to certain rules made by the prefects.

Among the fires prohibited during the close season is the so-called *petit feu*,<sup>1</sup> by which strips of undergrowth were carefully burned every six or seven years in the cork forests, to save the valuable cork oak trees from more dangerous uncontrolled fires. This system costs only 3s. 6d. an acre, as compared with £4 an acre for uprooting the dangerous undergrowth. It is evidently more hurtful to the forest than the other method, as the fire occasionally gets out of control, and, in any case, the burning diminishes the fertility of the soil.

The ninth clause directs that all landed proprietors, whose land has not been entirely cleared of all woody growth, may be compelled by an adjoining proprietor to keep a strip of land between the two estates entirely free from shrubs or conifers. The breadth of this strip will vary, according to circumstances, between 20 and 50 metres.

It is further enacted in Clause 11 that similar bare strips 20 metres broad shall be kept up along all lines of railway through a wooded area, and that these strips in adjoining property shall be kept clear at the expense of the railway companies. As it may not always be necessary to keep up these fire lines along the railways, a committee, consisting of a departmental councillor (*conseiller général*), a forest officer, and a railway engineer, shall decide when they may be omitted. All proprietors, whose woods are cut down in clearing these strips, are to obtain indemnities. This is a new provision, and called for owing to the extension of railways. The Act looks to the future in a clause exempting railway companies from this liability if they should use electric motors, or other inventions which cannot cause a forest fire.

In case any fire should break out, and it may appear advisable to light a counter fire, the two fires meeting and extinguishing one another for want of inflammable material, the local mayor, or his deputy, or failing these the most senior forest officer present, is to take charge of all measures to extinguish the fire, and no indemnity arises for woods burned under such circumstances. As in India, it is found in the south-east of France that fire is frequently caused by sportsmen, or poachers during the dry season, and the prefect is therefore authorised to delay the commencement of the shooting season until the commencement of the rains, which generally happens before the end of September.

As it is found that the construction of a network of roads greatly facilitates fire protection, by giving more value to forest produce, and rendering it possible to transport the material cleared from fire lines, and as roads serve as lines from which counter fires may be started, the State offers a subvention of 3000 francs per kilometre (£200 per mile) for roads constructed in the district, up to a total outlay of 600,000 francs (£24,000).

It appears that since 1870, 479,000 francs (£19,160) have been spent by the State on new roads in the State forests of the Esterel. The penalties attached to the breach of the first clause of this law are one to five days' imprisonment, or fine of 20 to 500 francs, and both fine and imprisonment can be inflicted, so that magistrates can make the penalty proportional to the gravity of the offence, and all police, forest guards, whether belonging to the State or to private properties, are directed to carry out the law by reporting offences, their written statements being received as evidence in cases which may arise. If the railway companies do not clear the fire lines along the railways, these lines will be cleared at their expense by the French Forest Department.

Although much land which might otherwise be planted is wasted in England owing to heather fires, and not only is a large area of pine forest destroyed annually by fire, but also the increase of destructive pine beetles is thus greatly favoured, there is little hope of our Legislature interfering; but the matter is more serious in North America, and along the Northern Pacific Railway about 1000 miles of treeless country exists, where the forests have been destroyed by fires, whilst the immensely valu-

able pitch-pine forests of the Southern States are rapidly disappearing from the same cause.

Matters have been dealt with in British India much more prudently, and regulations against forest fires have been enacted for the last twenty years at least in all the provinces under our control, and also to a certain extent within the native States. As a result of these regulations, and the careful management of the Indian Forest Department, 23,144 square miles of State forest in India were protected from fire in 1891 at a cost of 9 rupees per square mile, and this in addition to large areas of evergreen forest where no danger from forest fires exists.

W. R. FISHER.

#### PRIZE SUBJECTS OF THE PARIS ACADEMY OF SCIENCES.

THE following are the subjects for which prizes will be awarded by the Paris Academy in the years 1894, 1895, 1896, and 1898:—

1894. *Grand Prix for Mathematical Sciences*—The development of an important point in connection with the deformation of surfaces. *Prix Borel*—The study of problems in analytical mechanics admitting of algebraic integrals with regard to velocities, and especially quadratic integrals. *Prix Francoeur*—Discoveries or useful works on the progress of pure and applied mathematical sciences. *Prix Poncelet*—To the author of the most useful work on the progress of pure and applied mathematical sciences. *Extraordinary Prize of six thousand francs*—For any work tending to increase the efficacy of French naval forces. *Prix Montyon*—Mechanics. *Prix Plumey*—To the author of an improvement of steam engines or any other invention which promotes the advance of steam navigation. *Prix Dalmont*—To the engineer of bridges and highways who presents the best work to the Academy. *Prix Lalande*—Astronomy. *Prix Damoiseau*—Improvement of the method of calculating the perturbations of minor planets so as to give their positions within a few minutes of arc for an interval of fifty years; also the construction of tables which allow the principal parts of the perturbations to be rapidly determined. *Prix Valz*—Astronomy. *Prix Janssen*—Astronomical physics. *Prix Montyon*—Statistics. *Prix Jecker*—Organic chemistry. *Prix Vaillant*—Study of the physical and chemical causes determining the existence of rotatory power in transparent bodies, especially from the experimental point of view. *Prix Desmazières*—To the author of the most useful work on all or part of the cryptogams. *Prix Montagne*—To the authors of important works having for their subject the anatomy, physiology, development, or description of the lower cryptogams. *Prix Thore*—Awarded alternately to works on the cellular cryptogams of Europe, and to researches on the habits or anatomy of a species of European insect. *Prix Savigny*—To young zoological explorers. *Prix da Gama Machado*—On the coloured parts of the integumentary system of animals, and on the fertilising matter of living things. *Prix Montyon*—Medicine and surgery. *Prix Breant*—For a means of curing Asiatic cholera. *Prix Godard*—The anatomy, physiology, and pathology of genito-urinary organs. *Prix Parkin*—Researches on the curative effects of carbon in its various forms, and more especially in the gaseous form of carbon dioxide, in cholera, different kinds of fever, and other ailments. *Prix Barbier*—For a useful discovery in surgery, medicine, pharmacy, or botany in connection with the art of healing. *Prix Lallemand*—For the recompensation or encouragement of works relating to the nervous system, accepting the widest meaning of these words. *Prix Bellion*—To the writers of works or discoverers of facts of special importance to the health of human beings or the improvement of mankind. *Prix Mège*—For the completion of Dr. Mège's essay on the causes that have retarded or favoured the progress of medicine. *Prix Montyon*—Experimental physiology. *Prix Ponsat*—On the influence exercised by the pancreas and suprarenal capsules on the nervous system, and reciprocally, on the influence that the nervous system exercises on these glands, studied especially from a physiological point of view. *Prix Gay*—The study of subterranean waters; their origin, direction, the strata they traverse, their composition, and the animal and vegetable life that live in them. *Prix Montyon*—Unhealthy occupations. *Prix Cuvier*—For the most remarkable work on the animal kingdom, or on

<sup>1</sup> Vide "A Forest Tour in Provence and the Cévennes," by Colonel Bailey, R.E., in Transactions of the Botanical Society of Edinburgh, vol. xvi. part 3, 1876.

geology. *Priz Trémont*—To the savant, artist, or mechanic requiring assistance to attain an object of use or benefit to France. *Priz Gagner*—For the assistance of the savant distinguished for his contributions to the positive sciences. *Priz Delalande-Guérineau*—To the young French explorer, or the man of science, who shall have rendered the greatest service to France or science. *Priz Jerome Ponti*—To the author of scientific work of which the continuation or development is important to science. *Priz Tchihatcheu*—To the naturalist of any nationality who shall have pursued explorations in the Asiatic continent or neighbouring islands, having for their object the advancement of any branch of natural, physical, or mathematical science. *Priz Houllévoigne*—Awarded in rotation by the Academy of Sciences, and by the Academy of Fine Arts. *Priz Cahours*—For the encouragement of young workers known for their interesting researches, and more especially for researches in chemistry. *Priz Alberto-Lévy*—For a means of preventing or curing diphtheria. *Priz Laplace*—To the head student of the Ecole Polytechnique.

1895. For the improvement of the theory of the relation between the flywheel and the regulator. *Priz Gay*—For a study of the régime of rain and snow over the whole surface of the earth. *Priz L. La Caze*—To the authors of the best work on physics, chemistry, and physiology. *Priz Delesse*—To the author of a work dealing with geology or mineralogy. *Priz Bordin*—For the memoir that adds most to the knowledge of natural history (zoology, botany, or geology) of Tonkin or one of the French possessions in Central Africa. *Grand Priz des Sciences Physiques*—For the work that contributes most to the advancement of French palæontology by dealing in a thorough manner with the vertebrata of the coal measures, and those of the secondary epoch, and comparing them with existing types. *Priz Chaussier*—For important works in legal or in practical medicine. *Priz Petit d'Ormoy*—Pure and applied mathematics or natural science. *Priz Leconte*—To be awarded (1) to the authors of new and important discoveries in mathematics, physics, chemistry, natural history, or medical sciences; (2) to the authors of new applications in these sciences. *Priz Gaston Planté*—To the French author of a discovery, invention, or important work in the domain of electricity.

1896. *Priz Janssen*—Astronomical physics. *Priz Serres*—On general embryology, applied as far as possible to physiology and medicine. *Priz Jean Renaud*—For the best work published during the preceding five years.

1898. *Priz Damoiseau*—For a development of the theory of the perturbations of Hyperion, the satellite of Saturn discovered simultaneously by Bond and Lassell in 1848, principally taking into account the action of Titan. Also to compare observation with theory, and thence deduce the mass of Titan.

### SCIENCE IN THE MAGAZINES.

PROF. J. W. JUDD contributes to the *Fortnightly* an article on "The Chemical Action of Marine Organisms," dealing with the nature of the ocean-floor, and showing that the operations going on there are similar to those described by Darwin in his work on vegetable mould and earthworms. Prof. Judd favours the organic view of the origin of manganese nodules, and believes that the chemical theory is improbable. He says:—

"All the facts collected by the deep-sea exploring expeditions point to the conclusion that accumulation of material is going on with the most extreme slowness at these abysmal depths where the manganese nodules are found in greatest abundance, and it may well be that these slowly accumulating muds have been passed through the bodies of marine worms or other organisms an almost infinite number of times. At each passage of the clay through the organism a small addition of manganese and iron oxides would be made to the mass by the action of the living structure on the sea water, and thus in the course of time these oxides might be sufficiently concentrated to build up, by concretionary action, the remarkable nodules on the ocean-bed.

"Such action would be in complete analogy with processes going on both in fresh and salt water, by which calcareous, silicious, phosphatic, and ferruginous deposits are being everywhere formed in the waters of the ocean, while all theories of the direct separation of the manganese and rarer metals from their state of excessively dilute solution in sea-water by chemical

reactions appear to me to be beset with the greatest difficulty. All the observations that have been made in recent years upon the deposits of the ocean-floor point to one conclusion, namely, that where materials have once passed into a state of solution in the waters of the sea they can only be separated from it in the open ocean by the wonderful action of living organisms."

Prof. Buechner discusses "The Origin of Mankind," his article being more or less a review of a pamphlet by Abel Hovelacque, entitled "Les débuts de l'humanité," in which the results derived from archaeological researches are compared with the observations of travellers as to the lowest types of the human family that can exist. Captain Gambier, R.N., writes on "The True Discovery of America." He shows that Jean Cousin, a sea-captain of Dieppe, discovered the River Amazon in 1488, that is, four years before Columbus discovered San Salvador. There is clear evidence that Cousin was thoroughly conversant with all that was known of geography, hydrography, and nautical astronomy in his day, and that he sailed up the Maragnon, which was his name for the River Amazon as he heard it from the natives. On board Cousin's ship, as second in command, was a man named Vincent Pinçon, and Captain Gambier's contention is that this Pinçon was the same man as the Vincent Pinçon who is known to have commanded one of the ships under Columbus. The Pinçon that sailed with Cousin was tried by court-martial for insubordination when the ship returned to Dieppe, and was condemned to perpetual banishment from the soil of France. He went to Genoa, and from there to Palos, in Andalusia, where his two brothers carried on the business of shipowners and traders, making occasional voyages themselves. It is not too much to suppose that Columbus met the Pinçons, and was indebted to them for information about Cousin's voyage. Jealousy and human self-interest will explain why Cousin's name was carefully omitted from all writings referring to the discovery that was afterwards made by Columbus and the three Pinçons who accompanied him on the celebrated voyage.

In addition to these articles, the *Fortnightly* contains one in which Dr. Thin comments upon the most important points brought out in the Report of the Leprosy Commission in India.

The *New Review*, which appears for the first time this month as an illustrated review, contains an article on the late Prof. Tyndall, by Mr. P. Chalmers Mitchell. Sir William Flower contributes to *Good Words* an excellent description of the structure and action of "Birds' Wings." "The Vanishing Moose and their Extermination in the Adirondacks" is the title of a well-illustrated article by Mr. Madisson Grant in the *Century*. Mr. Grant says that the last moose in New York State was killed on the east inlet of Raquette Lake, in the autumn of 1861. In the *Century* also is related the circumstances that led to the first employment of chloroform, in 1847, by Sir James Simpson, the scribe being his daughter, Miss E. B. Simpson. Since chloroform may soon be superseded by some newer anæsthetic, it is well that the events which established it as the great alleviator of animal suffering have been recorded. Other magazines received by us are the *Humanitarian*, which reprints the address on "Biology and Ethics," recently delivered by Sir James Crichton Browne at Sheffield, *Scribner*, the *National Review*, *Contemporary*, the *Modern Review*, and *Longman's*, but none of these contain any articles of scientific interest.

### THE RISE OF THE MAMMALIA IN NORTH AMERICA.

#### I.

IN a remarkable address delivered before the Zoological section of the American Association for the Advancement of Science, at the Madison meeting, in August, Prof. H. F. Osborn gave an account of the recent achievements of exploration and research in connection with the rise of the mammalia in North America, and suggested the lines along which further advances were desirable. The length of the address precludes its complete publication here, but the most important features will be found in the following extracts. Among the omitted portions are sections dealing with the origin and evolution of Trituberculism, the succession of the Perissodactyls, and that of the Artiodactyls, and the relation of the Ancylopodæ (Cope) to the law of correlation.

Twenty years ago an era opened in the mammalian palæontology of Europe and America. Partly inspired by the *Odontographic* of Rüttimeyer, Kowalevsky completed and published in 1873 his four remarkable memoirs upon the hoofed mammals. He wrote these four hundred and fifty quarto pages in three languages not his own, in French upon *Anchitherium* and the ancestry of the horses, in English upon the *Hypopotamids*, in German upon *Gelocus*, *Antiracotherium* and *Entelodon*, including the first attempt at an arrangement of a great group of mammals upon the basis of the descent theory. These memoirs swept aside all the dry traditional fossil lore of Europe; they breathed the new spirit of Darwin, to whom the chief one was dedicated, making principles of descent of more importance than new genera and species. Kowalevsky thus summed up the contemporary palæontology:

"After the splendid osteological investigations of Cuvier had revealed to science a glimpse of a new mammalian world of wonderful richness, his successors have been bent rather upon multiplying the diversity of this extinct creation, than on diligently studying the organisation of the fossil forms that successively turned up through the zeal of amateurs and collectors. . . . With the exception of England (referring to Owen, Huxley, Falconer, and others), where the study of fossil mammalia was founded on a sound basis, and some glorious exceptions on the Continent (referring to Rüttimeyer, Gaudry, Fraas, Milne-Edwards), we have very few good palæontological memoirs in which the osteology of extinct mammals has been treated with sufficient detail and discrimination; and things have come to such a pass, that we know far better the osteology of South American, Australian, and Asiatic genera of fossil mammals than of those found in Europe."

At the same time, between 1871 and 1873, the pioneers of American palæontology, Leidy, Marsh, and Cope, began the exploration of our ancient lake basins rich in life. The first ten years of their work not only revolutionised our ideas of mammalian descent, but brought together the data for the generalisations of the second decade: for Marsh's demonstration of the laws of brain evolution in relation to survival; for Cope's proof of ungulate derivation from types with the simple foot resting upon the sole, and with the ancestral conic or bunodont molar tooth; and finally for Cope's demonstration of the tritubercular molar as the central type in all the mammalia. These four generalisations furnished a new working basis for morphology and phylogeny.

In these twenty years, thanks to energetic field work, we have accumulated vast materials for the history of the rise of the mammalia, enough for ten students where there is one, and the questions arise: How shall we take best advantage of it? What methods shall we adopt? In this address, besides bringing before you the more recent achievements of exploration and research, I will try to illustrate the advances already made in lines of thought, observation and system in palæontology, and indicate other advances which seem to me still desirable. In the problem of how to think and work most effectively, and with most permanent results, all the sciences meet on common ground.

It is to the renown of the veteran Rüttimeyer and of Kowalevsky, whose death we have to deplore, that, while their main inductions suffer by American discoveries, their methods of thought have not been displaced. It matters little that their theory that ungulate molars sprang from lophodont or crested forms, has been disproved; that Kowalevsky's tables of descent are full of errors; that his main generalisation as to the persistence of adaptive and extinction of inadaptable foot types does not hold good; that the horses and Anchitherium spring not from Palæotherium as he supposed, but from *Pachynolophus* and *Hyracotherium*, types which he carefully studied and yet omitted from the horse line! It is the right system of thought which is most essential to progress; better in the end wrong results such as the above, reached by the right method, than right results reached haphazard by a vicious method. If a student asked me how to study palæontology, I could do no better than direct him to the *Versuch einer natürlichen Classification der fossilen Nuthiere*, out of date in its facts, thoroughly modern in its approach to ancient nature. This work is a model union of the detailed study of form and function with theory and the working hypothesis. It regards the fossil not as a petrified skeleton, but as moving and feeding; every joint and facet has a meaning, each cusp a certain significance. Rising to the philosophy of the matter, it brings the mechanical

perfection and adaptiveness of different types into relation with environment, the change of herbage, the introduction of grasses. In this connection it speculates upon the causes of the rise, spread and extinction of each animal group. In other words the fossil quadrupeds are treated *biologically*—so far as is possible in the obscurity of the past. From such models and from our own experience we learn to abandon such traditions in the use of the tools of science as mere methods of description and classification, and to regard priority only in the matter of nomenclature.

To illustrate some of these modern methods, let us first look at the evolution of the teeth in the rise of the mammalia. The teeth and the feet are the foci of mammalian evolution, the only direct points of contact with food and the earth. Their combined use in phylogeny has increased in interest, because their evolution has proved to be wholly independent. We recall Cuvier's famous claim, of which Balzac said at the time: "Rebuilt like Cadmus, cities from a tooth."

No generalisation has been more thoroughly routed than that of a necessary law of correlation between tooth and foot structure. Besides the orthodox clawed carnivores and hoofed pachyderms of the great French anatomist, we have discovered hoofed carnivores such as Mesonyx, and clawed pachyderms such as Chalicotherium. Even the apparently lasting barriers of correlation, which Owen raised between the even and odd-toed ungulates, have been broken down by Ameghino's discovery of a Litoptern odd-toed horse with an even-toed type of astragalus. Not only is there no correlation of type, but none in the rate of evolution. Hipparion, the most progressive horse in tooth-structure, probably owed its extinction to its conservative preservation of its ancestral three toes. For these reasons the teeth and feet, owing to the frequent parallels of adaptation, may wholly mislead us if taken alone; while, if considered together, they give us a sure key; for no case of exact parallelism in both teeth and feet between two unrelated types has yet been found, or is likely to be. This, I believe, is the one lesson of later work which reverts to older methods; we should not base either classification or descent upon the teeth or feet alone. Every additional character diminishes the chances of error.

#### *Lower Mesozoic Pro-mammalia.*

With the exception of the triassic *Theriodesmus* of Seeley, no mammal is known by its limbs or skeleton until we reach the basal Eocene; in studying the first steps in the rise of the mammalia, we are thus practically driven to the teeth and jaws alone. In these straits of the fossil-hunter, embryology has lately come to our aid.

Assuming their remote reptilian origin, agreeing with Baur and Kükenthal that the theriomorph reptiles were parallel with rather than ancestral to the mammals, and therefore placing before both groups the hypothetical *Sauro-mammals* in or below the Permian, we come to the old question which Huxley discussed in his famous anniversary address: "Was there a succession between Monotremes, Marsupials, and Placentals, or a parallel development from a common pro-mammalian type?" Then we look to the newer questions: "When were the Edentates and Cetaceans given off?"

Modern tooth science springs first from the recent demonstration of Rüttimeyer's hypothesis of 1869, that the teeth of all the mammals centre around a single reptile-derived type. With a single exception, which I believe can be disposed of, various stages of tritubercularism or a three-cusped condition have become the standard for the teeth, as pentadactyly has long been for the feet, except that this is developed within the mammalian stem, while our five fingers are a reptilian legacy. Second, it springs from the recent thorough exploration of the youngest jaws for evidences as to the primitive form and succession of the teeth. This also supports the reptile theory of tooth descent by proving, what has been in considerable doubt, that the Pro-mammalia had a multiple succession of teeth like the reptiles, and that even some of the modern mammals retain dim traces of four series of teeth.

The brilliant discoveries of Kükenthal, Leche, and Röse begin to show how in various ways the mammals early modified the regular succession of all the teeth by suppression of parts of the multiple series. This is the first thing to consider. The next is how heterodontism arose, how the rows of conic teeth were specialised in different parts of the jaw for three or four functions. As a certain number of teeth took up each function, the question arises whether their number or dental formula was



ever the same in all the mammals, for we know it is very different now. After the teeth were thus divided, some functions became more important than others, and established a monopoly, causing first a marked difference in the relative development of the series, which we may express in a dental curve, resulting finally in a loss of certain teeth. In the meantime began the special evolution of the form of the back teeth, or molars. Was this alike in all mammals; was it tritubercular? It is surprising how many problems of early relationship are at stake in the discussion of these simple processes.

*Primitive Diphyodontism.*

What does *succession* really consist in? It now appears that Baume was right in denying that the first tooth is the mother of the second; for the teeth of the lower as well as the upper series spring from the common epithelial dental fold (Schmelzleiste) which dips down from the surface and extends the whole length of the jaw; at intervals it buds off the dental caps (Schmelzkeim) of the first series; after these are separated off, the dental fold sinks and buds off the dental caps of the second series, always below and inside the first; thus the fold is the mother and the caps are sisters, twins, or triplets, according to the number of the series. In all young mammals, including the traditional monophyodont Cetaceans and Edentates, and excepting only the still unexplored Monotreme embryos, traces of two series of teeth have been found. Both Leche and Röse have detected evidence that the dental fold sometimes buds off parts of a third series, thus explaining the occasional reversion of supernumerary teeth on the inner side of the second series, and Leche has seen traces of budding preceding the first series—thus giving us vestiges of four successions!

All our perplexities as to the relations of the milk and permanent teeth, and the ingenious but mistaken hypotheses of Baume, Flower, Wortman, and Cope have sprung from our want of evidence of the regular and complete diphyodontism of the stem mammals. The solution is in brief that the "milk teeth" and the "true molars" are descended from the first series, while the second series is represented by the "permanent incisors, canines, and pre molars" and rudiments of dental caps beneath the true molars. The mammals early began to diverge from this primitive diphyodontism in many ways; apparently adapting the first and second series, respectively, to their infant and mature feeding habits; losing parts or all of one series or the other, and in some cases pushing teeth of the second series in among the first; this intercalation has been a most confusing factor to us.

In the Marsupials (Kükenthal) almost the entire first series became permanent; thus from the Jurassic period to the present time only a solitary fourth premolar of the second series has pushed out its elder-sister tooth, and Röse has observed that an outer upper-incisor also pushes up from the second series; the remainder of the second series still persist as rudimental dental caps beneath the first, even beneath the first and second molars! There are wide variations among the Placentals; thus in the lowest existing forms, the Insectivora, Leche finds that in the Shrew (*Sorex*) the second series is suppressed entirely, while in the Hedgehog (*Erinaceus*) of the twelve permanent teeth in the anterior part of the jaws five belong to the first series and seven to the second. We thus meet with the paradox, that among the "primitive" Marsupials and Insectivores the regular reptilian succession was early interrupted, while in all the "higher" mammals the reptilian succession of two series was retained in the anterior part of the jaw. Beneath the posterior highly-specialised molar teeth of both Marsupials and Placentals, the second teeth were early suppressed, although in the Edentates, which also originally had specialised molars, there is a typical succession of seven teeth behind the canine. These discoveries prove that the whale teeth, like their paddles, have acquired a secondary adaptive resemblance to those of the Ichthyosaurs. How did the single and simple teeth of the Edentates and Cetaceans develop? Clearly by retrogression. As Leche points out in the aquatic Carnivora, in which the first series are degenerating, the single-series condition (monophyodontism) advances step by step with retrogressive simplification of the tooth form (homodontism); thus in the true seals, the eared seals and the walruses, as the permanent teeth become simpler, the milk teeth become smaller. The Edentates, so widely separated genetically, parallel the seals in tending to suppress the first

series of teeth and simplify the crowns of the second series at the same time. We might jump to the conclusion that this gives us an explanation of the homodont and apparently monophyodont condition of the toothed whales, especially as it has been supposed they sprang from aquatic carnivora, but in this Order matters were reversed, for the first series persisted and the second series were suppressed and persist as a rudimental row of tooth caps buried in the jaw.

Each dental series has an adaptive evolution of its own, in Erinaceus the first series has an ancient and the second a modern form; in Ericulus both series are alike; in the Bats the first series is homodont, the second is heterodont (Leche); in the Edentates the first series is ancient and heterodont, the second is modern and homodont (Thomas, Rheinhardt), so among the Cetacea and Ungulata.

What deep and ancient clefts the different laws of succession mark between the Marsupials and these three Placental groups!

*Primitive Heterodontism and Formula.*

Now that all mammals are led back to a distant diphyodont stem, it is also true that the further we go back both in palinogenesis and embryogenesis, the more widespread heterodontism is—all modern homodontism proving to be secondary. The simple conic teeth of the porpoise, for example, bear a misleading resemblance to those of a reptile. Flower, Weber, Julin, and Kükenthal agree that the ancestral whales and edentates were heterodont and had a smaller number of teeth than the existing forms.

Heterodontism is the second problem. Did the differentiation of the teeth into incisors, premolars, and molars occur before or after the Monotremes, Marsupials, and Placentals separated? It is well settled that the canine was the first maxillary tooth, and developed from the most anterior bi-fanged premolar; also, from the discovery of complete succession, we must now define the first molar as the most anterior specialised or triconid tooth, not as the most anterior permanent tooth. It seems to me we now find strong evidence that the stem mammals had a uniform number of each kind of teeth; in other words, a uniform dental formula. The Monotremes are most doubtful as the existing forms point only to primitive heterodontism. It will be a great step forward when we learn whether or not the Multituberculates are Monotremes—the resemblance of their molars to those of the duck-bill is very superficial, for the duckbill upper molars lack the intermediate row of tubercles universally seen in the Multituberculates, and look to me rather like degenerate Trituberculate teeth. Cope has recently found in the cretaceous rocks a remarkable Trituberculate, which he names *Thalcoodon*; the jaw of this animal is neither Placental nor Marsupial; it is like that of the Multituberculates—and both resemble remotely the degenerate modern Monotreme jaw. All we can say, therefore, is that the Multituberculates are an archaic group, highly specialised even in the Trias, that they were *probably* Monotremes, and neither structurally nor functionally akin to the Diprotodont Marsupials (Owen), nor to the Microbiotheridæ (Ameghino). With a dental mechanism and a condyle exactly like that of the rodents, they show no trace of canines, and the mode of evolution of their peculiar molars was probably paralleled later in the rodents. They present vestiges of a primitive dental formula like this:  $I_3. C_2. P_4. M_4+$ . *Thalcoodon* shows  $C_1. P_4. M_3$ . Thus, so far as this doubtful palæontological evidence goes, the Monotremes had a typical formula.

Our next step is to unify the typical 5. 1. 3. 4 of recent Marsupials with the 3. 1. 4. 3 of higher Placentals. Thomas has shown in his studies of recent Marsupials that they have probably lost one of the four typical premolars (*pm.* 2); this observation, fortunately, is partly confirmed by Röse's finding an embryonic germ of this tooth. Ignoring the incisors of the Jurassic Marsupials, Thomas raised the number of ancestral incisors to five, the highest number known among recent Marsupials; Röse therefore made another step towards uniformity when he showed that the Marsupial *i.* 5 is probably a member of the second series of incisors, and should not be reckoned with the first. Now, if we suppose that the Placentals have lost one incisor, and one molar, abundant evidence of which is found in Otocyon, Centetes and Homo, we derive as the ancestral formula of both orders:  $I_4. C_2. P_5. M_4$ .

The aberrant placental Cetacea point in the same direction, as we read in the conclusion of Weber's fine memoir: "All the

Cetacea sprang from a stem with a heterodont, but only partly specialised dentition (something like that of Zeuglodon, *I. 3. C. 1. P. & M.*). . . not direct from Carnivores or Ungulates, but from a generalised mammalian type of the Mesozoic period, with some affinities with the Carnivora. . . Zeuglodon itself branched off extremely early from the primitive line, and the heterodont Squalodon" (mark its formula, 3. 1. 4. 7.) "branched off later from the toothed whale line, after the teeth had begun to increase in number and before homodontism had set in." It would be easier for us while speculating to take Squalodon and the Odontocetes directly from the Jurassic mammalian formula (*3. 1. 4. 8.*). As for the multiplication of this formula, we have found the way, says Kükenthal, by which numerous homodont teeth have arisen from a few heterodont molars, namely, by the splitting up of each of the molars of the Jurassic ancestors into three. He substitutes this hypothesis for the one advocated by Baume, Julin, Weber, and Winge, that the multiple cetacean teeth represent the intercalation or joint appearance of both the first and second series of teeth, owing to the elongation of the

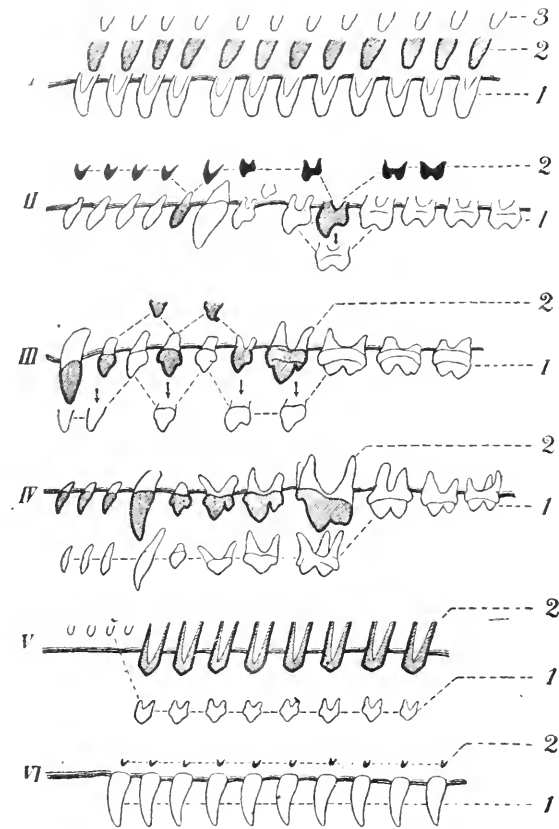

Relations of the First and Second Series of Teeth.

I. Reptiles. II. Marsupials. III. Insectivores (*Erythacus*)  
IV. Higher Placentals. V. Edentates. VI. Cetacea, Odontocetes

jaw—a view which is now disproved by Kükenthal's discovery of the second row beneath the first. Since even by Kükenthal's hypothesis the typical Mesozoic mammals could not furnish as many teeth as are found in some of the dolphins, a likelier explanation than his seems to be that as the jaws were elongated the dental fold was carried back and the dental caps multiplied. The Edentates, like the Cetaceans, point back to diphyodontism, and somewhat less clearly to a typical dental formula. We are here indebted to Flower, Rheinhardt, Thomas, Kükenthal, and Röse. It is their rudimental and useless first series which gives the evidence of heterodontism, while the second series has become adaptively rootless and homodont. The especially aberrant feature is that a double succession exists in the typical "true molar" region. The adult nine-banded Armadillo presents only eight maxillary teeth, seven of

which are preceded by two-rooted milk teeth (Tomes); in the embryo Leche finds fifteen dental caps, of which only thirteen are calcified; this number probably includes the four rudimentary incisors observed by Rheinhardt. In the aberrant *Orycteropus* (Aard-Vark), with ten adult teeth, Thomas finds seven milk teeth behind the maxillary suture (thus taking us into the molar region of the typical heterodonts). The last of these milk teeth is large, and two-rooted; behind this are three large permanent posterior teeth, apparently belonging to the first series. The large lateral tooth of *Bradypus* is suggestive of a canine. From this rapidly accumulating evidence it appears probable that the ancestral Edentates had four incisors, a canine and eight or more teeth behind it, the double succession extending well back, so that the first series did not become permanent at the fifth tooth behind the canine, as in the Marsupials and higher Placentals. If these are primitive conditions, as seems probable from comparison with fossil Edentates, they carry the divergence of the Edentates, like that of the Cetaceans, back into the Mesozoic period. Comparative anatomy and embryology thus point back to highly varied branches of a generalised placental heterodont stem in the Mesozoic, and a much earlier divergence than we formerly imagined. Now let us see to what the early Mesozoic mammals point.

There are three distinct and contemporary Jurassic types, the Multituberculates, the Triconodonts, and the Trituberculates. Are not these the representatives of the Prototheria, Metatheria, and Eutheria? In the archaic Multituberculates we have seen a monotreme type of jaw and vestiges of a typical ancestral formula. The Triconodonts are a newer group, perhaps derived from the Domotheriidae (incipient Triconodonts) of the Trias, although these appear to be aberrant; the typical forms extend from *Amphilestes* to Triconodon, and exhibit the first stages of development of the inflected Marsupial jaw. The Trituberculates include the Amphitheriidae and Amblotheriidae with true tuberculo-sectorial lower molars, like those of modern Insectivores; they alone exhibit the typical angular placental jaw—no reason can be assigned for calling them Marsupials, excepting the traditional reverence for the Marsupial stem theory. Now, it is very significant that the average dentition of these old but highly diverse forms, namely, Multituberculates, 3. ? 4. 6., Triconodonts, 4. 1. 4. 7., Trituberculates, 4. 1. 4-5. 8., is also the dentition to which the existing mammals apparently revert.

The third problem is from what type of molar tooth did the mammalian molar diverge?

(To be continued.)

#### SCIENTIFIC SERIALS.

*Symons's Monthly Meteorological Magazine*, December 1893. —In an article entitled "March to October, 1893," Mr. Symons deals with the temperature of the last eleven years in the north-west of London, with instruments identical in themselves and in exposure, with especial reference to the exceptional summer of the year 1893. The first two tables give the average monthly maximum in the shade, and the average maximum in the sun for 1883-92, compared with the mean values for 1893. In both cases the means of 1893 exceeded the average in each month, the excess of the shade maximum ranging from 1°·2 in September to 9°·7 in April, while the sun maximum shows an average excess of 7°·1, ranging from 1°·8 in July to 10°·8 in May. The tables showing the extreme maxima in shade and sun for each month of 1893, with the average of the highest reading in the ten corresponding months, again have plus signs in every instance in 1893, the greatest excess of the former being 10°·5 in April, while the mean of the eight months (March to October) shows an excess of 6°. The severe test of comparing the highest reading for each month of 1893 with the absolute highest reading in the corresponding month during the preceding ten years, shows that the season as a whole was unprecedented. The shade maxima were unequalled in April, June, July and August, the excess in April amounting to 5°·4, whereas in no other year of the ten have unequalled shade maxima occurred in more than two months. In some particulars August 1893 is unparalleled in thirty-six years. The shade temperature at 9h. a.m. on the 18th, viz. 84° 3, was 3°·5 higher than any other 9h. a.m. reading, and the shade maximum on the 16th to 19th all exceeded 90°, the only instance of this temperature being reached on three consecutive days.

*Wiedemann's Annalen der Physik und Chemie*, No. 12.—On the change of intensity of light polarised parallel to the plane of incidence by reflection on glass, by Paul Glan. The light reflected from a glass prism was compared with that of a petroleum flame by means of a polarising arrangement consisting of a doubly-refracting prism and a Nicol, between which a Hofmann prism was placed in order to obtain a spectrum of the reflected light. For crown glass, the ratio of the intensity of the reflected to that of the incident light polarised in the plane of incidence ranged from 0.055 at  $30^\circ$  to 0.293 at  $70^\circ$ , the corresponding values for flint glass being 0.070 and 0.327.—Hydrodynamico acoustical investigations, by W. König. The turning moment exerted by a moving column of a fluid upon a disc suspended in it was subjected to experimental investigation, the torsion being balanced by a magnet. For very small velocities of the column of air employed the form of flow was uniform, but it was found impossible to keep it so in the case of any considerable velocities. The contemplated determination of all the dynamical conditions of Rayleigh's disc swinging in an organ pipe, and its application to the absolute measurement of sound intensities has not yet succeeded.—Experimental investigations concerning elastic longitudinal and torsional fatigue in metals, by Louis Austin. The wires experimented upon were 23 m. long, and were suspended in the tower of the Strassburg Physical Institute. It was found that longitudinal and torsional fatigue phenomena are subject to similar laws. The fatigue effects in copper, silver, and brass were, for torsion, as 7 : 3 : 2, and for tension, as 4 : 3 : 2 approximately.—On the properties of various modifications of silver, by H. Lüdtke.—On thermopiles made of electrolytes and unpolarisable electrodes, by A. Gockel.—On the magnetism of iron cylinders, by O. Groirian.—On the passage of electric waves through layers of electrolyte, by G. Udry Yule.—On some modifications of the Thomson quadrant electrometer, by F. Himstedt.—A calibrated electro-dynamometer, by J. W. Giltay.—A new method of measuring self-potentials and induction coefficients of induction, by L. Grätz.

### SOCIETIES AND ACADEMIES.

#### LONDON.

**Chemical Society**, December 7, 1893.—Dr. Armstrong, President, in the chair.—The following papers were read:—An apparatus for the extraction and estimation of the gases dissolved in water, by E. B. Truman.—The magnetic rotation of hydrogen chloride in different solvents, and also of sodium chloride and of chlorine, by W. H. Perkin. The author confirms his previous observations on this subject, and also shows that isoamylic oxide and hydrogen chloride do not appreciably interact. The magnetic rotation of hydrogen chloride in isoamylic oxide solution is 2.245, in alcoholic solution 3.324, and in aqueous solution 4.300. The magnetic rotations of sodium chloride and of chlorine were also determined.—Analysis of water from the Zem-Zem well in Mecca, by C. A. Mitchell. The author gives analyses of water obtained by the late Sir R. Burton from the holy well in Mecca.—The preparation and properties of bromolapachol, by S. C. Hooker. Bromolapachol is obtained by reducing dibromolapachone; when dissolved in sulphuric acid it yields bromo- $\beta$ -apachone. The latter is converted into bromo- $\alpha$ -lapachone by the action of hydrobromic acid, whilst the reverse change occurs on dissolving the  $\alpha$ -isomeride in sulphuric acid.—Studies on citrazinic acid (Part ii.), by T. H. Easterfield and W. J. Sell.—The oxides of the elements and the periodic law, by R. M. Deeley. The author obtains a new periodic diagram by plotting the atomic weights of the elements against the numbers obtained on dividing the densities of the oxides by the atomic weights of the corresponding elements.—The freezing points of alloys in which the solvent is thallium, by C. T. Heycock and F. H. Neville. The mean depression of the freezing point by the addition of one atomic proportion of gold, silver, or platinum to one hundred atomic proportions of thallium is 6.31; the addition of lead to thallium, however, raises the freezing point.

**Geological Society**, December 20, 1893.—W. H. Hudleston, F.R.S., President, in the chair.—The following communications were read:—On the stratigraphical, lithological, and palæontological features of the Gosau beds of the Gosau district, in the Austrian Salzkammergut, by Herbert Kynaston. The author, after referring to the previous literature of the

subject, treated of the situation and physical aspects of the Gosau valley, the distribution of the Gosau beds, their stratigraphy, palæontology, and geological horizon, and the physical conditions under which they were deposited, and a comparison was instituted between the Gosau beds and the equivalent beds of other areas. He showed that Hippurites occur at two horizons in the Gosau beds—a hippurite-limestone immediately above the basement-conglomerate being characterised essentially by *Hippurites cornuaccinum*, which is overlain by *Actinella*- and *Nerina*-limestones and an estuarine series, and above these was a second hippurite-limestone characterised essentially by *Hippurites organisans*. It was pointed out that Toucas similarly distinguishes two hippurite zones in Southern France, the lower, characterised essentially by *H. cornuaccinum*, being placed by him at the top of the Turonian system, whilst the second, with *H. organisans*, is referred to the summit of the Senonian; and the author gave reasons for regarding the Gosau zones as the equivalents of those of the South of France, in which case the Gosau beds will represent the uppermost Turonian and the whole of the Senonian, i.e. the zones of *Holaster planus*, *Micraster*, *Marsupites*, and *Belemnitella mucronata* in England, whilst the upper unfossiliferous beds may be the equivalents of the Danian beds. The strata are, on the whole, of shallow-water origin, and were deposited in shallow bays in the Upper Cretaceous sea of Southern and Central Europe, on the northern flanks of the Eastern Alps. Probably towards the close of Upper Cretaceous times the southern area of the Gosau district was cut off from the sea to form a lake-basin in which the upper unfossiliferous series was deposited. Mr. W. Whitaker, Sir John Evans, and Prof. J. F. Blake spoke on the subject of the paper, and the author briefly replied.—Artesian boring at New Lodge, near Windsor Forest, Berks, by Prof. Edward Hull, F.R.S. The boring described in this paper was carried down from a level of about 220 feet above Ordnance datum through the following beds:—London Clay and Lower London Tertiaries, 214 feet; Chalk, 725 feet; Upper Greensand, 31 feet; Gault, 264 feet; Lower Greensand, 7 feet. The chalk was hard, and contained very little water; but on reaching the Lower Greensand the water rose in the borehole to a height of 7 feet from the surface. The author discussed the probability of the Lower Greensand yielding a plentiful water supply in the Windsor district. In the discussion that followed, the President said it was satisfactory to learn that there was an area near West London in which the Lower Greensand was full of water. He thought that the section exhibited by the author explained why it was full in that particular locality, for the rainfall about the extensive area of Hindhead, which lay nearly due south, must be considerable. Mr. W. J. Lewis Abbott and Mr. W. Whitaker also spoke, and the author replied.—Boring on the Booysen Estate, Witwatersrand, by D. Telford Edwards. An account was given of a boring on the Booysen estate, situated about two miles from Johannesburg, and about 5000 feet south of the nearest point of outcrop of the "Main Reef" of the Witwatersrand. The "Bird-Reefs" crop out generally at a distance of 4000 feet south of the Main Reef. The borehole, 1020 feet deep, passed through sandstones (often micaceous), quartzites, and conglomerates, the last-named having a collective thickness of 91 feet 7 inches, the two thickest reefs being respectively 26 and 22 feet thick. The dip of the beds was 35°. Traces of gold were obtained. All the reefs were highly mineralised, principally with iron pyrites, and belonged to the "Bird-Reef" series which overlies the Main Reef.

#### PARIS.

**Academy of Sciences**, December 26.—M. de Lacaze-Duthiers in the chair.—On the motion of Jupiter's fifth satellite, by M. F. Tisserand. A calculation of the displacement of the "perijove" of the fifth satellite due to the polar depression of Jupiter shows that it would amount to  $882'$  per annum, or one revolution in nearly five months. It is hoped that powerful instruments will enable observers to verify this.—On the propagation of electricity, by M. H. Poincaré. Starting from the "telegraphists' equation," the author shows that when an electrical disturbance proceeds along a wire, the head of the disturbance moves with a velocity such that, in front of this head, the disturbance is nil, as in the case of light and of plane sound waves, with the difference, however, that the electric disturbance leaves behind a residue of finite magnitude.—Numerical verifications relating to the focal properties of plane diffraction

gratings, by M. A. Cornu. The verification of the theory of focal anomalies in gratings already published, by testing actual gratings showing such anomalies, was based upon the following theorem: When the observed pencils make a constant angle with the incident beam remaining fixed, half the sum of the azimuths of the grating corresponding to spectra of symmetric orders is constant, and equal to the azimuth corresponding to the reflected beam.—Remarks on the spontaneous heating and ignition of hay, by M. Berthelot. Hay dried and stacked under normal circumstances loses moisture and oxidises slowly, without being sensibly heated. The initial heating, where it takes place, is due to the action of ferments, but not the higher stages of the process. When the ferments are no longer capable of further raising the temperature without endangering their own existence, it often happens that purely chemical action steps in, and leads up to the ignition of the haystack. The temperature of ignition for these materials is far below red heat.—On the composition of winter drainage waters from bare and from cultivated soils, by M. P. P. Dehérain.—Observations of the minor planets 371 and 372 (1893) made with the great equatorial of the Bordeaux Observatory, by MM. G. Rayet and L. Picart.—The analysis of commercial butters, by M. C. Viollette.—On the approximate development of the disturbing function in the case of inequalities of higher orders, by M. M. Hany.—Investigation of that part of the coronal atmosphere of the sun which is projected upon the disc, by M. H. Deslandres.—Is there oxygen in the sun's atmosphere? by H. Duner.—New applications of the tables of increasing latitudes to navigation, by M. E. Guyon.—On the successive radii of curvature of certain curves, by H. R. Godfrey.—Calculation of electro-magnetic forces, according to Maxwell's theory, by M. Vaschy.—On the diurnal variation of the tension of aqueous vapour, by M. Alfred Angot. The observations made at the top of the Eiffel Tower since the end of 1889 have shown that at the height of 300 m. the change of vapour tension during winter does not exceed a few hundredths of a mm. During the eight months beginning with March, a single maximum was observed during the day at 9 a.m., and a minimum at 5 p.m., while in the adjacent Parc Saint-Maur, there were two maxima, at 9 a.m. and 8 p.m., and two minima, at 4 a.m. and 4 p.m. It appears that the variation of vapour tension, as observed in ordinary meteorological stations, is a local phenomenon, limited to the lower strata of the atmosphere.—On the diurnal variation of atmospheric electricity, observed near the summit of the Eiffel Tower, by M. A. B. Chauveau. The indications of an electrometer registering photographically the potential of the air, lead to conclusions similar to those of the preceding paper. The two sets of maxima and minima observed on the ground are replaced by one set only, consisting of a maximum at about 6.30 p.m. and a minimum at 4 a.m. The potential, which sometimes exceeded 10,000 volts, was reduced to a convenient amount by the interposition of condensers in cascade.—On the weight of a litre of normal air, and the density of gases, by M. A. Leduc.—Sketch of a system of atomic weights of precision, founded upon the diamond as standard substance, by M. G. Hinrichs.—General method for the volumetric estimation of silver under any form, by M. G. Deniges.—On the stability in air of a 0.001 solution of corrosive sublimate, by M. Tanret.—Remarks on the critical pressures in the homologous series of organic chemistry, by M. E. Mathias.—On casein and the organic phosphorus of casein, by M. A. Béchamp.—On a new source of rhodinol, by MM. P. Monnet and Ph. Barbier.—Presence of camphene in essence of aspic, by M. G. Bouchardat.—On the volatile carbides of the essence of valerian, by M. Oliverio.—Contribution to the study of the ptomaines, by M. Echsner de Coinck.—Influence of certain causes upon receptivity; bacterian associations, by M. V. Gattier.—Toxicity of the blood of the viper (*Vipera aspis* L.).—Modifications of the emissive power of the skin under the influence of the electric brush discharge, by M. Lecerde.—Influence of iron upon the vegetation of barley, by M. P. Petit.—Influence of bark-stripping upon the mechanical properties of wood, by M. E. Mer.—On the natural desiccation of grains, by M. H. Coupin.—On the oolitic strata of the Paris Tertiary, by M. G. F. Dollfus.

BERLIN.

Physiological Society, December 8.—Prof. Munk, President, in the chair.—Prof. A. Kossel gave an account of his further researches on nucleic acid, carried on in conjunction with Dr. Neumann. The acid, as obtained from the thymus, differs from that obtained from other sources, in that during its decomposition it yields only adenin; it has hence been dis-

tinguished as adenylic acid. It occurs in two forms: one readily soluble, the other soluble with difficulty. When boiled with water, this acid yielded a paranucleic acid, which contained no adenin. By boiling with dilute hydrochloric acid a fourth acid (thyminic) was obtained, from which crystalline thymin could be obtained. All the above well-characterised substances possess, when analysed, an extremely complex constitution; thus the molecule of adenylic acid contains 75 atoms of carbon, and that of paranucleic acid 90 atoms. Dr. H. Kossel had studied the action of nucleic acid on bacteria, and found that cholera-germs and streptococci are readily killed by small quantities of the acid; whereas anthrax germs are much more resistant. He therefore considered that the bactericidal action of lymph-cells was attributable, in part at least, to this action of nucleic acid.—Dr. Rawitz spoke on spermatogenesis in Hydromedusæ. Unlike all other animals, the spermatozoa in this animal are developed in the outer layer of the bell, and are discharged direct into the surrounding fluid. The same speaker further described curious large branching villi in the jejunum of Macacus, not met with in the intestine of other species of monkey.

BOOKS PAMPHLETS, and SERIALS RECEIVED.

BOOKS.—The Canadian Ice Age: Sir J. W. Dawson (Montreal)—The Genus Salpa, 2 Vols., Text and Plates: Prof. W. K. Brooks (Baltimore)—The Butterflies and Moths of Teneriffe: A. E. H. White (L. Reeve)—Journal of Microscopy and Natural Science, Vol. 3, Third Series (Baillière).—Linnean Society of New South Wales, the Macleay Memorial Volume: edited by J. J. Fletcher (Dulau).  
PAMPHLETS.—Origin of the Pennsylvania Anthracite: J. J. Stevenson (Rochester).—On the Use of the Name "Catskill": J. J. Stevenson (Rochester).—The Marsh Warbler, &c.: W. W. Fowler (Oxford, Blackwell).—On Technical Education in Glasgow and the West of Scotland: H. Dyer (Glasgow).—Imperial Institute Series, Handbooks of Commercial Products, Indian Section, Nos. 1-22, 24-25, 27-29 (Calcutta).—Guides to Commercial Collections, Indian Section, No. 1 (Calcutta).—Agricultural Ledger Series, Nos. 1-13 (Simla).  
SERIALS.—Bulletin de l'Académie Royale des Sciences de Belgique, 63 Année, No. 11 (Bruxelles).—Journal de Physique, December (Paris).—Zeitschrift für Physikalische Chemie, XII. Band, 6 Heft (Leipzig).—Zeitschrift für Wissenschaftliche Zoologie, LVII. Band, 1 Heft (Leipzig).—Bulletins de la Société d'Anthropologie de Paris, December 15 (Paris).—Verhandlungen des Gesellschaft für Erdkunde zu Berlin, Band xx. Nos. 8 and 9 (Berlin).—Verhandlungen der Gesellschaft für Erdkunde zu Berlin, Band xxviii. No. 4 (Berlin).—American Naturalist, December (Philadelphia).—Journal of the Royal Agricultural Society of England, Third Series, vol. iv. part 4 (Murray).—L'Astronomie, January (Paris).—The Asclepiad, No. 39, vol. x. (Longmans).—Geological Magazine, January (K. Paul).—Séances de la Société Française de Physique, April-July, 1893 (Paris).

CONTENTS.

|                                                                                                                | PAGE |
|----------------------------------------------------------------------------------------------------------------|------|
| Recent Contributions to Meteorology . . . . .                                                                  | 217  |
| Physico-chemical Measurements. By J. W. Rodger . . . . .                                                       | 219  |
| Our Book Shelf:—                                                                                               |      |
| Cooke: "Handbook of British Hepaticæ."—                                                                        |      |
| C. H. W. . . . .                                                                                               | 220  |
| Lydekker: "The Royal Natural History" . . . . .                                                                | 220  |
| Letters to the Editor:—                                                                                        |      |
| The Origin of Lake Basins.—Dr. Alfred R. Wallace, F.R.S.; Sir Henry H. Howorth, K.C.I.E., M.P., F.R.S. . . . . | 220  |
| Hindoo Dwarfs.—Surgeon-Captain A. E. Grant . . . . .                                                           | 221  |
| Ewart's Investigations on Electric Fishes. By Prof. Gustav Fritsch . . . . .                                   | 222  |
| Navigation by Semi-Azimuths. By G. . . . .                                                                     | 223  |
| Voices from Abroad. By Prof. Henry E. Armstrong, F.R.S. . . . .                                                | 225  |
| The Effects of Light on Electrical Discharge. By W. W. . . . .                                                 | 226  |
| Neolithic Discoveries in Belgium. By J. E. . . . .                                                             | 227  |
| The Late Sir Samuel Baker . . . . .                                                                            | 227  |
| Notes . . . . .                                                                                                | 228  |
| Our Astronomical Column:—                                                                                      |      |
| Prizes at the Paris Academy . . . . .                                                                          | 233  |
| The Tail of Comet Brooks (c 1893) . . . . .                                                                    | 233  |
| The Planet Venus . . . . .                                                                                     | 233  |
| Geographical Notes . . . . .                                                                                   | 233  |
| New French Law for the Prevention of Forest Fires. By Prof. W. R. Fisher . . . . .                             | 233  |
| Prize Subjects of the Paris Academy of Sciences . . . . .                                                      | 234  |
| Science in the Magazines . . . . .                                                                             | 235  |
| The Rise of the Mammalia in North America. I. (With Diagram.) by Prof. H. F. Osborn . . . . .                  | 235  |
| Scientific Serials . . . . .                                                                                   | 238  |
| Societies and Academies . . . . .                                                                              | 239  |
| Books, Pamphlets, and Serials Received . . . . .                                                               | 240  |

THURSDAY, JANUARY 11, 1894.

## THE KEW INDEX OF PLANT-NAMES.

*Index Kewensis plantarum phanerogamarum nomina et synonyma omnium generum et specierum a Linnaeo usque ad annum mdccclxxxv complectens nomine recepto auctore patria uniuersique plantae subjectis.* Sumptibus Caroli Roberti Darwin, ductu et consilio Josephi D. Hooker, confecit B. D. Jackson. Fasciculi II. (Oxonii: E prelo Clarendoniano, MDCCCXCIII.)

THE appearance in rapid succession of the first two fasciculi forming the first volume of this splendid work, to be fittingly known to all time as the "Index Kewensis," is an event of supreme importance not only to the widely limited section of the scientific world which is professedly botanical, but also to the much wider circle of those who are interested in plants, whether this be from their more strictly technical side as the source of economic products, or from their more general and popular one, as objects of pleasure in cultivation and decoration. With the completion of the work in the second volume, which we are glad to know is not likely to be delayed beyond the current year, everyone will have within reach a book of reference in which may be found the correct name, the synonymy, the authority for the name, and the title of the work in which it is first published, along with an indication of the native country of any flowering plant described before the end of the year 1885.

It is to Charles Darwin we owe primarily this valuable work. In a short preface to the first fasciculus, Sir Joseph Hooker gives the following concise narrative of its origin:

"Shortly before his death Mr. Darwin informed me of his intention to devote a considerable sum in aid or furtherance of some work of utility to biological science; and to provide for its completion, should this not be accomplished during his lifetime. He further informed me that the difficulties he had experienced in accurately designating the many plants which he had studied, and ascertaining their native countries, had suggested to him the compilation of an index to the names and authorities of all known flowering plants and their countries, as a work of supreme importance to students of systematic and geographical botany, and to horticulturists, and as a fitting object of the fulfilment of his intentions.

"I have only to add that, at his request, I undertook to direct and supervise such a work; and that it is being carried out at the herbarium of the Royal Gardens, Kew, with the aid of the staff of that establishment."

Everyone who has had dealings with plants will have realised the difficulties referred to by Mr. Darwin, and will welcome the issue of the "Index Kewensis" to which his munificence has given birth, and will congratulate Sir Joseph Hooker and Mr. Daydon Jackson on the result of their fifteen years' labour as the instruments through which the practical wish of Mr. Darwin is in process of being carried out. In passing, it is not uninteresting, from the point of view of history, to note the association of the name of Darwin with this Index. The biological sciences, whilst owing an eternal debt of gratitude to Linnæus for the order which he brought out of their preceding chaos, and for the binomial nomenclature his

genius so deftly constructed as an alphabet of system, have reason to regret the retarding influence on their progressive development of the dogma of constancy of species which his scholasticism tacked on to his nomenclature, and which the nomenclature served to perpetuate. From the trammels of this dogma the genius and work of Darwin gave to biology final emancipation, and now by his forethought and munificence this enumeration of genera and species is being provided, the foundation of which rests on the enduring portion of the work of the great Swedish naturalist.

It is impossible to emphasise too strongly the value of the book before us. The most recent work of similar kind is the "Nomenclator Botanicus" of Steudel. But this was completed in 1841, and since that date the activity of botanists and the exploration of the world's surface has added so enormously to the known plants, that for practical purposes Steudel's Nomenclator has been for long out of date. The "Index Kewensis" is not, however, cast on quite the same lines as Steudel's work, and possesses valuable features absent from it. The Nomenclator was confessedly a critical botanical book, expressing the views of the limitation and relationship of genera and species held by the author, and consequently new names on the authority of Steudel occur throughout. The "Index Kewensis" makes no such profession. It takes the literature as it existed at the end of the year 1885, and from it is compiled, in conformity with certain definite guiding principles of plant-naming, the correct nomenclature, based, so far as the limitation of genera and species is concerned, upon the work of the most competent and trustworthy writers. The "Genera Plantarum" of Bentham and Hooker gives the standard of limitation of genera, and for species the conclusions of monographers and recognised authorities in the different groups supply the basis for the synonymy. The Index is therefore essentially a literary work carried out under effective botanical supervision, and the circumstances surrounding its production are most favourable. No one more qualified for this detailed work than Mr. Daydon Jackson, by his extensive knowledge of botanical literature and critical judgment, could have been found; in Sir Joseph Hooker the work has the supervision of the most experienced systematic botanist of the day; and Kew, the natural birthplace of a British book dealing with all flowering plants, affords unrivalled facilities for the investigation involved in such a work.

We have said the "Index Kewensis" gives the correct name of all plants described before the end of the year 1885. This brings up the much-discussed question of what is the correct name of a plant? Under what rules is it to be fixed? In its bearing on this question the Index appears most opportunely, and it may be regarded as the manifesto of the working British systematic botanists upon the vexed subject of plant-nomenclature; and a thoroughly practical one it is. Briefly the guiding rules of the Index are these:—The starting point for genera is the first edition of the "Systema" of Linnæus, published in 1735; the starting point for species is the first edition of the "Species Plantarum" of Linnæus, published in 1753; the correct name is that given by the author who first placed the plant in its proper genus. There is a soundness in these principles which should

appeal to any unprejudiced mind. If nomenclature dates from Linnæus, who founded the system, naturally the first editions of his works dealing satisfactorily with genera and with species, are respective points of departure for the names of these, and in dealing with the species described by subsequent authors a similar course must be pursued. This code has been the tradition of the representative British botanists, and to it the former leaders of American botany also subscribed. It is the simple rule that priority determines the name. But, as with other rules framed by frail humanity for its guidance, this, if applied with rigorous inflexibility, would defeat the object it is designed to serve. To drop a name which has become generally accepted as the designation of a plant, and with which it is always associated, and take up for it some unknown name, simply because some one has discovered that this one preceded that by a few months in publication, or because it occurs a few lines earlier on the page of the same work, may mean logical adherence to the rule of priority, but is subversive of the purpose of nomenclature. Conformity with the code has therefore on the part of the botanists mentioned been governed by circumstances of practical expediency. They have kept in mind that nomenclature is only an aid to, not the aim of, the study of plants, and that a theoretically perfect nomenclature is inconsequent by the side of one which in practice admits of the ready recognition of the plants named; they have thought more of the identity of the plant and of its relationships than of the technical accuracy of the name under generally guiding principles, and have not therefore hesitated to cite older and obscure names as synonyms, and to ignore them if their use would replace others which had come to be generally and widely known. This principle of expediency and convenience, it has been said, is an unstable one, and to workers in fields of science in which it is not admitted may appear to be a mistake. But in the past of botany, in the hands of men really endeavouring to increase the general store of knowledge of plant-life, it has worked well. No doubt inconsistencies and mistakes may be found in the works of botanical writers who have acted upon it, traceable to a laxity which it introduces; but it has been a strong conservative element in nomenclature, whereas the application of the rule of strict priority has been most unsettling. For there are, unfortunately, men endowed with antiquarian zeal mated with sentiment which deems the naming of a species honour, and of a genus glory, who ferret through the pages of forgotten or unknown tracts or obscure journals, which perchance may contain a name, given by an author whose work has perhaps had no effect whatever upon the progress of the science, with which, under strict priority rules, they may supplant one custom has made part of popular language: or who rake out of correspondence (alas, that its preservation should serve such end) the history of private quarrels and jealousies of men whose names, as the roll of time has handed them down to us, carry only the attribute of scientific distinction, with the object of showing that one may have ignored the work of another, preceding it by a few days or weeks, and that consequently firmly established names must give place to those which strict priority demands. It is

through such work, revelling in the overturning of authorities, which does not contribute to the progress of botany, and is essentially non-botanical, that many of the difficulties in nomenclature arise, and it merits the censure of all true botanists. Such work proves the wisdom of the botanists who have held aloof from binding agreement to strict priority rules, and against the load of synonymy and the confusion the strict priority rule would in these ways inflict upon plant-nomenclature, expediency and convenience are the protection to which appeal can be made. We are glad to note that in the "Index Kewensis" discretion has been exercised, and familiar and generally known names have not been sunk, although under the strict priority rule they should have been replaced by other and obscure ones.

That the procedure in the Index will meet with the universal acceptance of botanists may be hoped for; it cannot be expected immediately, when we have regard to the existing divergencies upon fundamental points. The laws of nomenclature formulated by the Paris Botanical Congress of 1867, made strict priority the basis of nomenclature, and were so generally adopted by systematic botanists out of England, that little was heard of the subject in subsequent years until a revolt of the younger American botanists against the practice of their former leaders—adherents to the line of expediency—brought it so prominently under notice a few years ago, that it has since been a staple of discussion in some botanical journals. Strict priority was the cry of the Americans, and some of them, with a zeal tinged with pedantry rather than bred of thought for the good of the science, endeavoured, in the application of the rule, to carry back to Virgil, Catullus, and other classical writers the scientific nomenclature of plants. But the event which most roused the attention of European botanists was the publication, in 1891, by Otto Kuntze, of his "Revisio generum plantarum"—a book remarkable no less for the industry and linguistic powers it exhibits than for its audacity and unconscious humour. Having assumed the rôle of a reformer of nomenclature, the author begins business by changing the names of some thousand genera and thirty thousand species, the new ones being only certified by the coincidentally significant initials O. K.! As a curiosity of botanical literature the book will be historical; meanwhile its menace to systematic botany has had the effect of drawing from the Berlin school of systematists, which in recent years has shown so much activity, a statement of views which, after circulation, was submitted to the meeting of botanists at Genoa in 1892.

If the result of all the discussion and conference that has taken place has not been the establishment of a common agreement, they have at least served to bring out the points of divergence of view. We cannot, of course, discuss here the various issues upon which botanists are disagreed on this subject, but we may point out that the differences are mainly upon the starting point of nomenclature and the import of the specific name. The German school, which appears to carry with it a considerable bulk of continental opinion, prefers 1753 as the starting point for both genera and species to the date adopted in the Index, but makes an important declaration of adherence to the principle of

expediency as qualifying the strict priority rule. The Americans have come round to fix 1753 as the starting point of nomenclature, but unfortunately tack on to the priority rule a rider compelling the use of the earliest specific appellation wherever the genus is changed—a proper enough rule if botanists would only follow it, but which, if carried out retrospectively, as they propose, would involve a changing of plant names appalling to contemplate.

We have said sufficient to show the importance of the "Index Kewensis," and to make clear that its issue at this time is most opportune. The professed desire of all systematic botanists—although there is a wide gulf often betwixt their profession and their practice—is the establishing of a stable nomenclature. To this end the "Index Kewensis" is the most important contribution that has appeared since the "Genera Plantarum" of Bentham and Hooker was completed, and it supplements that work. What effect it will have in bringing about a modification of the views now held by continental and American botanists time will show. In the various discussions and conferences through which it has been attempted to settle questions of nomenclature, the Kew botanists have not taken active part; they have done better, and in the "Genera Plantarum," and now in this "Index Kewensis," we have practical expression of their views, and systematic botanical literature is enriched with what may be fairly termed the most valuable and important additions of the century. The "Index Kewensis" provides a book of reference which every library must possess, and there need be little doubt its nomenclature will take firm hold in this country at least.

For the detail and workmanship in the book we have nothing but praise. They are of a kind we are in the habit of associating with the race which has given us "the sausage for food and the encyclopædia for knowledge," but the book shows there is no monopoly in this sort of work. It is a lasting tribute to the painstaking industry, skill, and knowledge of Mr. Daydon Jackson. The citation of the place of first publication of a species is a most valuable feature in the book, supplying at once a clue through which its history may be followed, and the mention of the native country, necessarily general and brief in most instances, is a further helpful feature. We could have wished for a more extensive citation of the garden names of plants; in every-day life these are constantly turning up, and of no names is the history more difficult to run down. In a work such as this, the preparation of which has taken so many years, and the separate items of which are so multitudinous, slips, omissions, and inconsistencies must occur; but the number of these, so far as use has enabled us to judge, is remarkably small. "Menda non commemorata lector benevolens ipse corriget," says Mr. Daydon Jackson, as a preface to a list of "addenda et corrigenda" in each fasciculus; let us hope readers will also send them to Mr. Daydon Jackson, who may incorporate them in succeeding fasciculi.

It only remains to add, regarding the style and printing of the book, that the best work of the Clarendon Press is displayed in it.

NO. 1263, VOL. 49]

### ASTRONOMY FOR THE PUBLIC.

*In the High Heavens.* By Sir Robert S. Ball, F.R.S. (London: Isbister and Co., 1893.)

IT is not too much to say that at the present time Sir Robert Ball is the fashionable interpreter of astronomical science. He retails to the general public, by voice and by pen, the facts accumulated by astronomers who love their science for her own sake, the practical observer and the eloquent expositor thus mutually benefiting one another.

The book before us contains a collection of heterogeneous articles, several of which have appeared in the *Contemporary* and *Fortnightly*, and all of which are written in the style that pertains to magazines. To the student of science this diffuse method of expounding facts is distasteful. As Ruskin has remarked, "A downright fact may be told in a plain way; and we want downright facts at present more than anything else." The chapter on "The 'Heat Wave' of 1892" furnishes an example of what can be done in the way of connecting facts between which there is apparently no relation. The chapter begins with a description of the temperature observations in different parts of the world in July and August, 1892; it then passes to the movements of the moon, transits of Venus, and meteor-showers, in illustration of the accuracy of astronomical predictions as against the prediction of weather. The work of Lord Kelvin and Prof. G. H. Darwin on tidal prediction is next considered, and the tide-predicting machine of the former is described. Fourier's theorem is discussed, and some of the causes affecting the heights of tides mentioned, the chapter finally concluding with an account of Prof. Hale's photographs of a luminous eruption on the sun in July, 1892. The different scraps of information in this *omnium gatherum* are joined together with an ingenuity that is only acquired after long practice; but in spite of this, the article gives one the impression that the author has spun out his subject in order to provide copy.

The star 1830 Groombridge is a "King Charles' Head" to Sir Robert Ball, the reason being its large proper motion. We doubt whether he has ever written a book in which the number of miles per second, per minute, per hour, per day, per annum, &c. through which 1830 Groombridge travels, is not enlarged upon; and in the volume under review this runaway star is twice inflicted upon the reader. So persistently, indeed, does 1830 Goombridge appear, that we begin to wonder whether it is hurrying through space at a great rate in order to afford subject-matter for popular lecturers and writers on astronomy.

Another subject that has often given Sir Robert Ball an opportunity of exercising his descriptive faculty is the correlation between solar and terrestrial phenomena. But in view of the facts recently brought out in these columns and elsewhere, he may find it necessary to modify or substantiate the statement that "great outbursts on the sun have been immediately followed, I might almost say accompanied, by remarkable magnetic disturbances on the earth."

For the sake of historical accuracy, it may be well to

point out that Prof. Rowland first made the striking remark that "were the whole earth heated to the temperature of the sun, its spectrum would probably resemble that of the sun very closely" (*Johns Hopkins University Circular*, No. 85, February, 1891). In referring to Prof. Rowland's work in August, 1891, at the British Association meeting of that year, Dr. Huggins made practically the same remark, and Sir Robert Ball (p. 169) quotes his words, and gives him the credit for the idea they contain.

Two of the chapters in the book refer to shooting-stars, meteors, and meteorites; and in them the author discusses the origin of meteorites and the relation between meteorites and comets. In his opinion, meteorites are masses of matter ejected from terrestrial volcanoes in a primeval condition of the earth; but we fancy that the analyses of most meteorites do not favour this origin. How, for instance, is the absence of quartz accounted for? But, as a matter of fact, Sir Robert Ball is almost the only astronomer who holds the volcanic view, and the same can be said with regard to his denial of the connection between comets and meteorites, and between meteorites and shooting-stars. The work of Schiaparelli and Newton, Tisserand, and Schulhoff, not to mention many others, considerably outweighs all that Sir Robert Ball has ever said upon the matter. The spectroscopic evidence upon the connection is dismissed in half a dozen lines, while page upon page is devoted to a description of what might happen to masses of matter projected from the moon or a minor planet. In fact, by discussing and judging these theories in a volume designed for the general reader, Sir Robert Ball has made a mistake. Though he has done some excellent mathematical work, astronomers are not at all ready to recognise him as a judge on matters of astronomical physics. His function is to expound and popularise discoveries in celestial science, and when he is exercising it he is at his best.

There are some good points about the book, and anyone desirous of obtaining information upon a few of the recent important discoveries in astronomy will profit by reading it. The illustrations are not so numerous as they ought to be, but what are included are mostly very good, though the illustration on p. 156, of the region of the Milky Way about  $\beta$  Cygni, should have been a positive instead of a negative, for in its present form it looks more like a pathological section than anything else.

It would be an advantage if, in a future edition, the author would give the name of the observer of the solar eruptions figured on pp. 271, 273, 338, and 339. We fancy that Father Fenyi was the original draughtsman of the prominence forms there illustrated, but cannot find his name mentioned in the text relating to them.

R. A. GREGORY.

#### OUR BOOK SHELF.

*Practical Agricultural Chemistry for Elementary Students.* By J. Bernard Coleman, A.R.C.Sc., F.I.C., and Frank T. Addyman, B.Sc., F.I.C. (London: Longmans, Green, and Co., 1893.)

"THE course of instruction described in this book has been in use for some years at University College, Nottingham." After a few instructions as to the use of apparatus, there follows a short course of experiments on

oxygen, air, carbonic acid, water, and hydrogen. The third section treats experimentally of soils, manures, feeding materials, and dairy produce, and gives a number of simple experiments that serve to show many of the most important properties of these substances. For example, the differences between the sulphur present in gas-lime and in gypsum respectively, and the various conditions in which phosphoric acid occurs in superphosphates, bone phosphates, reverted phosphate, and slag phosphates are made the subjects of experiment. Tests are given for the various constituents of manures. Oilcakes, grass and hay, roots, flour, milk, butter and cheese, are dealt with in a similar manner. The fourth section of the volume gives a few reactions of a select number of metals (viz. seven) and acids, with a few other matters, and tables for the qualitative analysis of substances containing them. We would remark in reference to this, that to allow students to fuse insoluble substances in porcelain crucibles, in order to test for silica, is, to say the least of it, undesirable.

Regarding the volume as a whole, it forms an excellent addition to an ordinary student's course of agriculture, whether this is, as is too often the case, only a matter of listening to a few lectures, or whether practical agriculture forms an essential part of it. Perhaps it is hardly possible for a teacher to take much account of the danger that is proverbially inseparable from a little knowledge; but in cases where this is particularly liable to manifest itself, it may be his duty to do what he can to obviate the evil. Speaking from experience, we fear there are students who, after having worked through these seventy-one pages, would not hesitate to state that they had studied inorganic and organic practical chemistry at whatever college they might have done the work. In this way it is at least possible for grave discredit to be brought undeservedly upon the usual course in chemistry at such a college; for there are many people with no technical knowledge of these matters, who attach considerable value to the mere fact that a specific routine of study has been gone through at a well-known educational establishment. It appears, therefore, to be highly desirable to do whatever may be possible to prevent such a chemical course as that in this volume from being in any way confused with even the most elementary course that is arranged to impart a knowledge of chemistry itself. A similar danger doubtless exists in many other cases, but it may probably be said with truth, that there is in none other likely to be so great a temptation to misrepresent facts by an incomplete statement of the truth.

C. J.

*Bionomie des Meeres.* Von Johannes Walther. Erster Theil einer Einleitung in die Geologie als historische Wissenschaft. (Jena: Gustav Fischer, 1893.)

PROF. WALTHER has set before himself an ambitious programme, which, if carried out, should result in a geological treatise of great interest; we fear also of portentous length. The first instalment is a modest little book of 200 pages, with a preface summarising the travels and researches which the author made for ten years with a view to fit himself for the task, and a separately paged introduction defining the scope of the contemplated work, and enunciating the ontological method in geology. Bionomy is the study of the life-habits of organisms in relation to their environment, and it is obvious that the bionomy of the ocean at the present time must be the clue to all deductions from the character of marine fossils regarding the physical conditions in which they were produced.

Prof. Walther is extremely systematic, and in twenty numbered sections he summarises a vast amount of recent work on the relation between marine organisms and physical conditions. His numerous references to original memoirs might be profitably increased by the inclusion of more British, French, and American work, and espe-



cially by some indication of such piles of raw material for discussion as have been accumulated by the Fishery Departments of many governments. A compilation of this sort depends for its value on its completeness, as the reason for adopting one theory or classification rather than another must be the outcome of an attempt to weigh evidence. After a brief discussion of the conditions of life, there follow sections on the life-districts of the ocean, Hæckel's classification of marine organisms, a concise discussion of the influence of light, temperature, salinity, tides, waves, and currents on marine life, and a short statement of the flora and fauna of the littoral, shallow water, estuarine, open sea, deep sea, and oceanic archipelago divisions, concluding with a few pages on the geological changes of ocean basins.

It would be premature to express an opinion of Prof. Walther's contemplated work. The sketch he gives of its plan stimulates interest and curiosity, and we can heartily congratulate him on the orderly way in which he has collected and laid down the building-material, while we wish him success in his labours.

#### LETTERS TO THE EDITOR.

[The Editor does not hold himself responsible for opinions expressed by his correspondents. Neither can he undertake to return, or to correspond with the writers of, rejected manuscripts intended for this or any other part of NATURE. No notice is taken of anonymous communications.]

#### Correlation of Solar and Magnetic Phenomena.

The opinion of Mr. Whipple, quoted at p. 2 of NATURE for November 2, to the effect that the solar outburst observed by Messrs. Carrington and Hodgson on September 1, 1859, was not the cause of the coincident magnetic perturbations, corresponds to my own conclusion in regard to the matter based upon evidence of an altogether different character. There was a recurrence of strong magnetic perturbations and auroras twenty-seven days later than the great magnetic storms of August 28 and September 1, 1859, thus following the general rule which is found to apply in such cases, there being a well-marked periodicity of such outbreaks at this precise interval corresponding to the time of a synodic rotation of the sun. Such recurrence manifestly could not exist if outbreaks upon the sun were able to produce terrestrial magnetic effects indifferently in all locations. In order that there may be recurrence at the synodic period the magnetic effects must proceed from the sun at some particular angle exclusively, and fortuitous outbursts elsewhere, no matter how violent, must fail to have any perceptible effect. In the estimation of the writer there is no point more important in connection with solar physics than the determination of this period and this angle with the greatest accuracy possible.

M. A. VEEDER,

Lyons, N. Y., December 26, 1893.

MY letter in NATURE (vol. xlix. page 30), amongst other interesting communications, has brought one from Mr. Lawrence (vol. xlix. page 101) and the accompanying letter from Dr. Veeder. Mr. Lawrence's graphic account well describes the circumstances attending the manifestation of 1882 (November 17). The magnetic disturbance which broke out at 10 a.m. on that day set us all on the look-out for aurora in the evening. Neither were we disappointed; the display was remarkable. But the question in this case, as with the Carrington-Hodgson and Young instances, is still whether the solar and magnetic phenomena were directly related or simply coincident. This cannot be said to be determined, and nothing less than proof, in so important a matter, will serve. Better to advance surely if slowly towards truth, rather than accept too hastily evidence that is incomplete. We must remember that on the occasion of the solar disturbance seen by Trouvelot, the magnets were especially quiet, not only at the time but also before and after. But any explanation of these phenomena must include all cases. The position of things, as stated in my first letter, referred to above, still I consider holds, qualified only by the circumstance that instead of one presumed case of direct relation, three are now adduced, with a fourth case (the Trouvelot observation), which unquestionably was not accompanied by magnetic disturbance.

NO. 1263, VOL. 49]

If we further consider that, since the year 1859, when attention became distinctly drawn to this question, there has occurred magnetic movement, equal to and in very many cases far exceeding that accompanying the Carrington-Hodgson observation, on some 400 different days, we see on how slight a foundation the presumption for direct relation, that is of a nature more or less instantaneous in action, exists, although the general relation between the two classes of phenomena remains undoubted.

Dr. Veeder, from his own point of view, supports the contention that the 1859 solar outburst cannot be taken as causing the accompanying moderate magnetic movement; indeed there was far greater movement some three days previously, and again early on the morning of the following day; but in regard to his affirmation that there exists a well-marked periodicity in magnetic outbursts corresponding to the period of the sun's rotation, whilst this in a limited sense may be in some degree true, I cannot say that my personal acquaintance with magnetic records during very many years enables me at present to accept such conclusion as a general one, or indeed what as a consequence follows, that anything really depends on the position in rotation which the sun occupies relatively to the earth.

The whole subject is, however, exceedingly interesting, and various considerations arise. One bearing on the present question may be mentioned. Great terrestrial magnetic disturbances are evidently in character cosmical, produced, it would seem, or stimulated, by some external cause. For it has been shown (Proc. Roy. Soc. vol. lii. p. 191) that, on occasions of unusually sudden magnetic disturbance, the commencement of disturbance, at places so widely separated on the earth's surface as Greenwich, Pawlowsk, and Bombay, is simultaneous within a much smaller limit of time than had before been supposed. Such sudden simultaneous action would thus appear to indicate an impulse, solar or otherwise, from without, but whether one distinctly solar, or in what other way produced, is a question yet to be determined.

WILLIAM ELLIS.

Greenwich, January 6.

#### The Mendip Earthquake of December 30-31, 1893.

I SUBMIT the following notes for the use of any of your readers who may be collecting information on the subject:—

So far as I can judge, from statements obtained directly from inhabitants of the locality, and from the experiences of various persons, recorded in the *Shepton Mallet Journal* of January 5, the movements in this earthquake occurred chiefly along the south flank of the Mendip Hills between Shepton Mallet on the east-south-east, and Draycott (near Cheddar) on the west-north-west. The shock extended as far southwards as Evercrech and West Pennard; it reached as high up as Priddy, which is near the axis of the hills, and was also noticed at Chewton, several miles distant on the northern flank.

The force of the shocks appears to have been very irregularly distributed, in some houses the movements being quite alarming, while in others not far distant they were trifling though unmistakable. Some persons failed to hear the sound, which was very evident to others. Persons out of doors heard the sound most distinctly, even when they felt no shock.

A lady at Shepton Mallet, who had previously experienced an earthquake in New Zealand, recognised at once what was occurring, but was not in any way alarmed. She says that her bed began suddenly to shake or rock, and as suddenly ceased. She was also conscious of a movement of the whole house, and in the sharper shock heard the furniture rattle; but she did not observe any rumbling. Another lady in the same house noticed particularly the "funny unusual sort of noise." Again, in the same house a man describes the movement as resembling a wave moving from east to west. A school master and mistress got up under the impression that the water-heating apparatus had burst. At West Compton a lady in a farmhouse thought from the sound and movement "that some one was about the house, or that a barrel of cider had burst." At Westbury-below-Wells the shock was sharp enough to cause alarm.

The policeman on duty at Shepton Mallet very naturally referred the sound to the direction of the Midland Railway, which runs high on the hills in such a way that the rumble of its trains is heard at a great distance. It is well known that we have but little certainty in localising sounds, especially if of indefinite character, and that we usually refer them to positions whence we expect them.

The area in which the earth-movements seem to have been

most felt, corresponds with a series of outlying masses of carboniferous limestone, which are separate from the main mass of carboniferous limestone of the Mendip anticlinal. Whether these are parts of another anticlinal, or owe their position to faulting, I do not know. Westward of Wells these outliers form little knolls, as at Draycott and Westbury. Further east, in the area between Wells, Shepton Mallet, and West Compton, they form a group of prominent hills, whose valleys are occupied by later formations. If such outliers exist east of Shepton Mallet, they are deeply hidden by the oolitic strata.

Evercreech and West Pennard lie off this carboniferous limestone, but it extends beneath the valley in which these villages lie. Priddy is on the main anticlinal of the Priddy Mendip hills, and Chewton is separated from all the foregoing by the exposure of Old Red Sandstone. It would be interesting to know how far the Old Red Sandstone shared the movements; but information is likely to be scanty, as the sandstone forms a bleak and sparsely inhabited region.

F. J. ALLEN.

Mason College, Birmingham, January 6.

Quaternionic Innovations.

THAT Prof. Tait should not be able to do justice to those who prefer to treat vectors as vectors, and quaternions as quaternions, instead of commingling their diverse natures, with the result, in the latter case, of confusion of physical ideas (and geometrical also, for of course geometry is itself ultimately a physical science, having an experiential foundation), is naturally to be expected. He does not know their ways, either of thinking or of working, as is abundantly evident in all that he has written adversely to Prof. Willard Gibbs and others. It is, however, a little strange, in view of Prof. Tait's often expressed conservatism regarding Quaternions, that he should tolerate any innovations therein, such as Mr. MacAulay has introduced. The latter may perhaps take this as a compliment to his analytical powers, which compel the former's admiration, and toleration of his departures from quaternionic usage. For myself, I welcome any quaternionic innovations that may (ultimately) tend in the direction of the standpoint assumed by Prof. Gibbs and others, and foresaw some two years since (when a very bulky manuscript came to me for my opinion) that there would be some quaternionic upstirring.

Prof. Gibbs has already pointed out how the development of Quaternions has involved first the elimination of the imaginary, and next the gradual elimination of the quaternion! Now there is a capital illustration of this innate tendency in Prof. Tait's review (NATURE, December 28, 1893), where, on p. 194, he explains by an example the meaning of a startling innovation of Mr. MacAulay's. Put it, however, in vectorial form, and let us see what it comes to then. Take the case of a stress and the force to correspond (which is a little easier than Prof. Tait's example, though not essentially different). Let  $\phi$  be a stress operator (pure, for simplicity), so that  $\phi\mathbf{N}$ , or  $\mathbf{N}\phi$ , is the stress per unit area on the  $\mathbf{N}$  plane,  $\mathbf{N}$  being any unit vector. Now we know, by consideration of the stresses acting upon the faces of a unit cube, that the  $\mathbf{N}$  component of the force  $\mathbf{F}$  per unit volume is the divergence of the stress vector for the  $\mathbf{N}$  planes. That is,

$$\mathbf{F}\mathbf{N} = \nabla\phi\mathbf{N}, \tag{1}$$

for any direction of  $\mathbf{N}$ . I employ my usual notation for the benefit of readers (now becoming numerous) who, though they cannot follow the obscure quaternionic processes, can understand the plainer ones of pure vector algebra. Now, may we remove the vector  $\mathbf{N}$  (which is any one of an infinite number of vectors), and write

$$\mathbf{F} = \nabla\phi \text{ or } \nabla\phi\mathbf{N} \tag{2}$$

simply, as the complete expression for the force? Certainly we may. For, in full, we have

$$\nabla = \mathbf{i}\nabla_1 + \mathbf{j}\nabla_2 + \mathbf{k}\nabla_3, \tag{3}$$

$$\phi = \phi_1.\mathbf{i} + \phi_2.\mathbf{j} + \phi_3.\mathbf{k} \text{ or } = \mathbf{i}.\phi_1 + \mathbf{j}.\phi_2 + \mathbf{k}.\phi_3, \tag{4}$$

where  $\nabla_1, \&c.$  are the scalar components of the vector  $\nabla$  (not a quaternion, of course) and  $\phi_1, \&c.$  are the vector stresses on the planes of  $\mathbf{i}, \&c.$ , so that  $\phi_1 = \phi_1\mathbf{i}, \&c.$  Direct multiplication gives at once

$$\nabla\phi = \nabla_1\phi_1 + \nabla_2\phi_2 + \nabla_3\phi_3, \tag{5}$$

which is  $\mathbf{F}$ . We may also write it  $\phi\nabla$ , because  $\phi$  is pure.

On the other hand, when  $\phi$  is rotational, let its conjugate be  $\phi'$ , then instead of (1) we have

$$\mathbf{F}\mathbf{N} = \nabla\phi'\mathbf{N}, \tag{6}$$

and therefore

$$\mathbf{F} = \nabla\phi' = \phi\nabla. \tag{7}$$

Here if  $\phi$  is given by the first expansion in (4),  $\phi'$  is given by the second.

Now there are several things that deserve to be pointed out about the above, which should be compared with Prof. Tait on p. 194. First, that the result  $\mathbf{F} = \phi\nabla$ , irrespective of pureness, or  $\mathbf{F} = \nabla\phi$  also when the stress is pure, when got quaternionically seems to be a great novelty to Prof. Tait, and to give him a "severe wrench," involving a "dislocation" and a "startling innovation." Perhaps, however, it is only Mr. MacAulay's peculiar way of arriving at the result, that Prof. Tait is alluding to. Moreover, secondly, in the vector algebra of Willard Gibbs and others the use of equation (2) or of (7) to express the force complete, by removal of the intermediate vector  $\mathbf{N}$ , is neither new, nor does it involve any straining of the intellect, for it is actually a part of the system itself, done naturally and in harmony with Cartesian mathematics. See Gibbs's "Elements of Vector Analysis" (1881-4) for the direct product of  $\nabla$  and  $\phi$ . (Also for the skew product, a more advanced idea; it, too, is a physically useful result.) Thirdly, note how very differently the same thing presents itself to Prof. Tait according as it is clothed in his favourite quaternionic garb or in vectorial vestments. In the latter case it is either unnoticed or is contemptible; in the former, it may be a novel and valuable improvement.

I do not think that Prof. Tait does justice to Mr. MacAulay in making so much of a trifle such as passes unnoticed or unappreciated in the previous work of others. There is, I know, much more in Mr. MacAulay's mathematics than Prof. Tait has yet fathomed. For my own part, I like to translate it into vectors, not merely because it is then in a form I am used to, and is plainer, but also because the true inwardness of these processes involving linear operators is properly exhibited by the dyadical way of viewing them in conjunction with vectors, without the forced and unnatural amalgamation with quaternions, and the attendant obscurities. This seems to me to be particularly true in physical applications. I should not be writing this note were it not for the misconceptions that Prof. Tait indulges in about what he does not know, viz. vector algebra apart from quaternions. At the same time, to avoid possible misunderstanding, I disclaim any hostility to Mr. MacAulay's quaternionic innovations, although I must agree with Prof. Tait as to the "singular uncouthness" of some of his expressions in their present form. I hope he may be able to see his way to do his work vectorially. It will be more amenable to innovations, I think, without mental wrenches. At any rate he is a reformer, and not afraid to innovate when he thinks fit.

OLIVER HEAVISIDE.

Paignton, Devon, December 30, 1893.

The Second Law of Thermodynamics.

I APOLOGISE to Mr. Bryan for unintentionally reading into the Report, Article 17, what he did not intend to be there. I understand now that according to his view conservative systems are not alone to be included in the Clausian proof.

My point, however, is (or was) that they ought to be excluded, at all events when there is only one controllable coordinate  $\nu$ , because (1) in conservative systems the virial equation gives a relation between  $T$  and  $\nu$ , so that only one of them is independent. That, I submit, is true in fact. And (2) the second law, I said, requires two independent variables. That, however, is a question of definition, and if Mr. Bryan were to take the equation

$$\int \frac{\partial Q}{T} = 0$$

for a complete cycle, whatever be the nature of the system, as a definition of the second law, I see no valid objection to that definition.

I admit, and did admit, that for a conservative system, moving in a complete cycle,

$$\int \frac{\partial Q}{T} = 0,$$

and therefore I admit that if Mr. Bryan attaches his wheel and windlass to my piston of constant mass, we should get

$$\int \frac{\partial Q}{T} = 0$$

for each complete turn of the wheel. Whether that equation can be correctly said to express the second law, where there is only one independent variable, is a question of definition of the second law.

I said, also, that if we are at liberty to vary the mass of the piston, we have two independent variables, but no longer a conservative system. Mr. Bryan, with greater generality, points out that the same effect would be produced by altering the gravitation-potential.

The objections to Clausius's proof generally cannot be more forcibly stated than they are in the Report. What is required is a definition of the time "i." The absence of that definition is to my mind not only an objection, but a quite fatal objection. If, as I proposed, we make

$$i = \frac{v}{T},$$

that answers the purpose for the very limited class of cases in which

$$\partial \bar{\chi} = \frac{d\bar{\chi}}{dv} dv.$$

A treatment of the subject in generalised coordinates is as follows:—Let  $y_1 \dots y_n$  be the unconstrainable,  $q_1 \dots q_r$  the controllable coordinates, concerning which latter I assume, as does Boltzmann, that  $\dot{q}$  or  $\frac{dq}{dt}$ , and also  $\frac{d^2q}{dt^2}$  are to be neglected. Let  $\chi$  be the potential,  $\tau$  the kinetic energy,  $T$  the mean value of  $\tau$ . Then we have generally

$$\frac{\partial Q}{T} = \partial \log T + \frac{1}{T} \left\{ \partial \chi + \sum \left( \frac{d\tau}{dq} - \frac{d\bar{\chi}}{dq} \right) dq \right\}.$$

In some cases the term  $\frac{dT}{dq}$  does not appear, and therefore in this class of cases

$$\frac{\partial Q}{T} = \partial \log T + \frac{1}{T} \left( \partial \bar{\chi} - \sum \frac{d\bar{\chi}}{dq} dq \right).$$

Now let  $f dy_1 \dots dy_n$  be the chance that in the stationary motion with the  $q$ 's constant, the coordinates shall lie between the limits  $y_1$  and  $y_1 + dy_1$ , &c., so that

$$\bar{\chi} = \int \int \dots \chi f dy_1 \dots dy_n$$

and

$$\frac{d\bar{\chi}}{dq} = \int \int \dots \frac{d\chi}{dq} f dy_1 \dots dy_n.$$

This makes

$$\partial \bar{\chi} - \sum \frac{d\bar{\chi}}{dq} dq = \int \int \dots \chi \partial f dy_1 \dots dy_n,$$

and

$$\frac{\partial Q}{T} = \partial \log T + \int \int \dots \frac{\chi}{T} \partial f dy_1 \dots dy_n.$$

In order that  $\frac{\partial Q}{T}$  may be a complete differential, we must make

$f = \phi \left( \frac{\chi}{T} \right)$ , where  $\phi$  is an arbitrary function. That is the general solution.

Now it will be found that this general solution agrees exactly with that given by Mr. Nichols. For his condition is

$$\frac{1}{T} \left( \frac{d}{dv} \bar{\chi} - \frac{d\bar{\chi}}{dv} \right) = - \frac{d}{dT} \frac{d\bar{\chi}}{dv}.$$

Now the use of these averages necessarily implies the existence of a function  $f$ , such that

$$\bar{\chi} = \int f \chi d\sigma, \quad \frac{d\bar{\chi}}{dv} = \int f \frac{d\chi}{dv} d\sigma,$$

the integrations being with proper coordinates, and therefore

$$\frac{d}{dv} \bar{\chi} - \frac{d\bar{\chi}}{dv} = \int \chi \frac{df}{dv} d\sigma.$$

Mr. Nichols' condition may therefore, without loss of its generality, be put in the form

$$\int \chi \frac{df}{d\sigma} d\sigma = - \int \frac{d\chi}{d\sigma} \frac{df}{d\chi} d\sigma.$$

The general solution of this is

$$f = \phi \left( \frac{\chi}{T} \right),$$

as before

That equation,

$$f = \phi \left( \frac{\chi}{T} \right),$$

seems to me to define the limits of the second law for all cases in which the term  $\frac{dT}{dq}$  does not appear in Lagrange's equations.

I hope if Mr. Bryan comes to discuss the virial proof, he will give his opinion on this point.

I think that the term  $\frac{dT}{dq}$ , when it exists, can be made to lead to a somewhat similar condition. If, namely,  $F$  be the chance of a given combination of the velocities,

$$\begin{aligned} \frac{1}{T} \frac{d\tau}{dq} &= \int \frac{F}{T} \frac{d\tau}{dq} d\sigma = - \int \frac{\tau}{T} \frac{dF}{dq} d\sigma \\ &= - \int \frac{\tau}{T} \partial F d\sigma + \partial \log T, \end{aligned}$$

whence  $F$  must be a function of  $\frac{\tau}{T}$ .

I have to thank Mr. Bryan for reminding me of Mr. Nichols' paper, which I had forgotten, though I had some discussion with its author at the time. S. H. BURBURY.

**The Fauna of the Victoria Regia Tank in the Botanical Gardens.**

PROF. LANKESTER'S account of the "Freshwater Medusa," in NATURE, December 7, 1893, shows how with very little trouble the interests of zoologists may be served by those who have the charge of botanical gardens like that in the Regent's Park. All that is necessary is to refrain from periodically cleaning out the tanks in which tropical water plants are grown. When these latter are imported from abroad they often carry with them various aquatic animals of novelty or interest like the medusa mentioned. This particular tank has recently produced quite a number of remarkable animals. Mr. Bousfield, some years since, found certain new or little known species of *Devo* therein, and more recently Prof. A. G. Bourne met with a new form of the Naid genus *Pristina* in the same tank. I have been able, thanks to the courtesy of Mr. Sowerby, to examine water and decaying weed therefrom on more than one occasion, and I discovered a series of rare or novel species of *Oligochæta*. The most remarkable form was one which I described a year or two since as a new genus *Branchiura*; this worm, with the general characters of a *Tubifex*, possesses a row of dorsal and ventral branchial processes, besides showing other points of interest. In the same sample of water were large quantities of a Naid, called by its original describer, Prof. Bourne, who met with it in the town of Calcutta, *Chaetobranchnus semperi*. This worm has also a series of branchiæ, but they are lateral in position, and enclose the long dorsal setæ of the Annelid, thus suggesting the parapodia of the marine Chaetopods. I have also found the rare species *Æolosoma niveum* in the same locality, and a freshwater Nematine (*? Tetrastreruma aquarium dulcium*), besides a number of *Oligochæta* which I did not at the time identify.

FRANK E. BEDDARD.

**! Rudimentary (Vestigial) Organs.**

PROF. HARTOG'S letter in your issue of the 28th ult. is interesting as an illustration of the extreme danger of regarding an organ as vestigial and functionless merely because our superficial investigations have not revealed to us its use.

If Prof. Hartog had examined the distal knob of the modern eyeglass, even by the old-fashioned macroscopic methods, he would have seen that there passes through a screw, whose function is to hold the two sides of the oval frame together, and thus retain the lens in place.

The knob is also useful as a convenient point to lay hold of

in drawing the two lenses apart. We may, I think, prophesy that these two functions will secure the organ against disappearance.

W. E. H.

ALLOW me, as a wearer of the modern style double eye-glass, to point out to Prof. Marcus Hartog that the knob on the distal frame owes its survival to its utility. Though no longer of service as a lock on a folder, it yet serves to lay hold of when drawing the frames asunder to put on the nose. It is one of the drawbacks of the modern eye-glass that it takes both hands to fix or remove.

C. MOSTYN.

National Liberal Club, Whitehall Place, S.W., January 4.

### FRESH LIGHT ON THE AINU<sup>1</sup>

MR. A. H. SAVAGE LANDOR, grandson of the poet, and himself a talented artist, recently made a remarkable journey round the island of Yezo, and up



many of its large rivers, repeating Captain Blakiston's route in 1869 so far as regards the north-east and west coasts, but supplementing that traveller's journey along the whole east coast and in the interior. He travelled alone, with practically no equipment except for painting; and during five months he lived almost exclusively with the Ainu, even sharing their food. He visited in this way nearly every native village in Yezo, and estimates the total number of pure-bred Ainu now on the island at about 8000, while

<sup>1</sup> "Alone with the Hairy Ainu: or, 3800 Miles on a Pack Saddle in Yezo, and a Cruise to the Kurile Islands." By A. H. Savage Landor. (London: John Murray, 1893.)

the Japanese estimate of the whole Ainu population, including half-breeds, is from 15,000 to 17,000. Mr. Landor gives a lively and straightforward account of his journey, illustrated by numerous portraits, pieces of landscape, and drawings of houses and implements, which is replete with incidental information as to the ways of the primitive people and the minor adventures of the road. No European has previously covered so much ground in Yezo, and we are surprised at the modest size of the volume in which so many fresh observations are recorded for the first time. The geographical results of the journey were communicated, shortly after his return, to the Royal Geographical Society, and published, with a map of the island (reproduced, with some additions, in this volume), in the last part of the Society's "Supplementary Papers." We are not aware that the anthropological data have yet been submitted to specialists, but we feel confident that they will assist notably in forwarding our knowledge of the difficult problems of Ainu ethnology. The author as an artist has a keen and discriminating eye for form and colour, so that his observations carry much more weight than the chance remarks of most non-scientific travellers. It seems a pity that some of the portraits are not reproduced in colour, and we trust that an effort will be made to secure for anthropological collections some of the original pictures, which we understand are still in Mr. Landor's possession.

In the course of the narrative a chapter is inserted on the Koro-pokkuru, or early pit-dwellers, the supposed aborigines of Yezo; ten chapters at the end are devoted to Ainu architecture, art, and graves, Ainu heads and their physiognomy, movements and attitudes, clothes, ornaments and tattooing, music, poetry and dancing, heredity, crosses, psychological observations, physiological observations, pulse-beat and respiration, odour of the Ainu, the five senses, superstitions, morals, laws and punishments, marital relations and the causes that limit population.

These and an appendix giving measurements of the Ainu body constitute a definite addition to science, which loses but little of its value through being expressed in popular language. Indeed, it is a matter of some importance that such facts should be disseminated by a book which, altogether apart from its intrinsic value, will be widely read on account of its fascinating human interest.

The illustrations which we reproduce are extremely characteristic portraits, showing admirably the hairy character

of the men, and the well-known fashion of tattooing a moustache on the women.

The average measurements of ten pure Ainu (five men and five women) of Frishikobets, on the upper Tokachi river, were as follows:—Height,  $62\frac{1}{2}$  inches for men,  $58\frac{3}{4}$  inches for women; length from tip to tip of fingers with arms outstretched,  $65\frac{3}{4}$  inches for men,  $61\frac{1}{4}$  inches for women; chest measurement,  $37\frac{1}{16}$  for men,  $34\frac{1}{2}$  for women. The pure Ainu physiognomy is described as follows:—"When seen full-face the forehead is narrow and sharply sloped backward, the cheek-bones are prominent, and the nose is hooked, slightly flattened, and broad, with wide, strong nostrils. The mouth is generally

large, with thick, firm lips, and the underlip well developed. The space from the nose to the mouth is extremely long, while the chin, which is rather round, is comparatively short and not very prominent. Thus the face has the shape of a short oval. The profile is concave, and the mouth and eyebrows are prominent . . . . In the supraorbital region the central boss is extremely well marked; also the brow ridges, which, however, are slightly less conspicuous than the central boss. The ears are usually large, flat, and simply-developed." Mr. Landor shows, by a series of detailed contrasts, that the pure Ainu has no similarity whatever to the Mongolian type. The colour of the skin he found to be light reddish brown. The eye is particularly contrasted to the Mongolian eye, having a similar form and setting to that of North Europeans, while the iris is light brown or dark grey—rarely black or dark brown, except in the case of half-breeds. The eyes are very expressive, and show the emotions in an interesting way. In adults the hair is black, wavy, and inclined to form large curls; children have lighter hair, and in the north-east of Yezo several men were seen with reddish hair and beard. Mr. Landor never saw the

valence of insect parasites being remarkable. They seem to have an acute sense of smell, distinguishing between the odour of an Englishman and a Japanese, but oblivious to their own very marked perfume—an intensified form of the "peculiar odour of an uncleaned monkey's cage." The sense of touch is singularly defective, and even when the extremes are painful, they cannot distinguish the sensation of heat from that of cold. Their hearing is very acute.

Mr. Landor is severe on those writers whose imperfect acquaintance with the Japanese half-castes on the southern coast has led them to theorise on Ainu religion. He acknowledges only "a rudimentary kind of totemism" in connection with the bear festivals, and "a certain amount of fear and respect for anything that supports their life or can destroy it."

In every respect the new observations now published make the Ainu appear to be the most primitive of primitive races in the northern hemisphere. The author brings forward reasons which led him to believe that the Ainu, coming from the north of Asia, and possibly of the same stock as the North Europeans, conquered and dispossessed the Koro-pok-kuru who had come to Yezo from the Aleutian Islands and were akin to the Eskimo.

H. R. M.

THE PURIFICATION OF SEWAGE BY BACTERIA.<sup>1</sup>

THE diffusion of bacteriological knowledge amongst the general public is already beginning to affect the patent list, and numerous inventions which the world is at present asked to take advantage of claim to have some special efficacy in regard to micro-organisms. The pamphlet before us is intended to introduce to public notice one of these bacteriological inventions in a field which has already exercised the ingenuity of many inventors—both professional and amateur—viz., the purification of sewage. In this case the invention is called the "cultivation filter-bed," and the inventor is Mr. Scott Moncrieff, whilst the investigation of its efficiency has been made by Dr. A. C. Houston. The new process of treatment consists essentially in passing the sewage upwards through a filtering medium 14 inches in depth, and composed of successive layers of flint, coke, and gravel. To quote the words of the report, "the rationale of this system of sewage disposal seems to depend on the following well-recognised truths:—

- "1. That bacteria under favourable conditions are capable of indefinite multiplication.
- "2. That bacteria exist in sewage which are capable of peptonising solid organic matter, or, in other words, of preparing it, by a process comparable to that of digestion, for its final disintegration.
- "3. That in nature the purification of the refuse of the organic world is effected by the life-history of these or similar micro-organisms."

Having thus learnt what the nature of the method of treatment is—viz. upward filtration without aëration, or, in other words, putrefaction, we turn in the next instance for information as to the effect of this treatment. The report contains a number of analytical tables, but not one of the analyses shows us the composition of the crude sewage, and consequently the numerous analyses of the effluent furnish no data whatsoever as to the purification effected. Turning to the analyses of the effluent, however, we are not surprised to learn that it has generally an unpleasant odour, whilst the albuminoid ammonia in an average sample was 1·1 part per 100,000; but why this should be regarded as "very small," we are

<sup>1</sup> "Report upon the Scott Moncrieff System for the Bacteriological Purification of Sewage." By Alex. C. Houston, M.B., D.Sc. Edin. (London: Waterlow Bros., 1902.)



pure Ainu laugh, though on one occasion he induced a man to "roar" with surprise and delight. The various emotions are expressed by slight changes of posture or gesture, but the Ainu do not care to show their feelings; they have no sense of shame, and even fear appears hardly to be known.

The women do most of the hard work, but the men when hunting can walk forty miles a day without fatigue, although they usually prefer to ride, ponies being plentiful and of a good breed. In moving a load or heavy object the Ainu never push, but always pull towards them. They appear to use the feet and toes very freely to help their hands and fingers, and they readily employ their teeth, preferring to pull with the teeth than the hand when an unusually heavy haul is necessary. The whole appearance struck Mr. Landor as exactly like the reconstructions of the primitive man of northern Europe, and many of their movements recalled those of the anthropoid apes.

In sexual matters the Ainu appear to have no definite rules, but a form of endogamy is common, which scarcely differs from promiscuity. The people are extremely filthy, both in their persons and in their huts, the pre-

at a loss to discover. Nor was even the inventor apparently satisfied, for we are told in the report that "in order to still further improve the quality of the effluent by longitudinal filtration, by oxidation, and by the action of micro-organisms, Mr. Scott Moncrieff devised what he has termed nitrifying channels. These in their simplest form consist of half-channel pipes joined together with cement and filled with coke." These channels were originally 30 feet in length, but subsequently they were increased to 80 feet. As regards the efficiency, or rather inefficiency of these channels, we are able to form an opinion from analyses given on pp. 19 and 20 of the report; from these it appears that the free ammonia *before* was 3·2 parts per 100,000, and *after* passing through the 80 feet channel 3·6 parts, whilst the albuminoid ammonia was '8 part *before*, and '64 part *after*, respectively, whilst in no case was more than a very small proportion of nitrate discovered in this effluent, showing that these channels are "nitrifying" in name only.

If we now inquire into the machinery involved in producing these results, we find that for a household of ten to twelve persons, the filter-bed was 10 feet long by 2½ feet wide, or 25 square feet in area, whilst the so called nitrifying channel superadded to this was 80 feet in length (the diameter of these channels is not given). For a population of 1000 persons, therefore, a filter-bed, upwards of 2000 feet square, and a nitrifying channel, between 6000 and 7000 feet in length, would be necessary.

It is difficult to discover what claim to novelty Mr. Moncrieff's system possesses; the upward filtration of sewage was practised years ago, and has been generally abandoned on account of the far superior results obtained by downward intermittent filtration. As regards the nitrifying channels, these are simply downward filters of a very clumsy and expensive form, the inefficiency of which is attested by the analyses published in the report. One novelty indeed there is in Mr. Moncrieff's filters, to which they doubtless owe their "up-to-date" title of "cultivation filter-beds," for we are informed that when a new filter-bed is started it is "inoculated" with the liquid contents of an old one! As already pointed out, in the absence of any analyses of the raw sewage, the report gives us no information as to the work really done by the "cultivation filter-bed," but the effluent coming from it certainly contrasts very unfavourably with good effluents obtained either by filtration, irrigation, or chemical precipitation; as regards the work done by the "nitrifying channels," the analyses demonstrate this to be simply deplorable.

In conclusion, we would remark that the chemical analyses might advantageously have been made more complete, so as to render the figures comparable with those given in the best investigations on the purification of sewage; and we would point out that an analysis is not rendered more exhaustive either by expressing each determination in parts per 100,000 as well as in grains per gallon, or by drawing out the results in elaborate but meaningless curves of divers colours.

#### ARTHUR MILNES MARSHALL.

A GLOOM has been cast over the opening year by the news of what can only be described as a national calamity. Like his friend, Prof. F. M. Balfour, Milnes Marshall has been cut off in the midst of a life of scientific usefulness by an accident among the mountains which he loved. On the last day of 1893 Prof. Marshall, with several companions, started from the hotel at Wasdale Head for a day's climbing among the precipices of Scawfell. All the dangers and difficulties had been passed, and the party were looking for suitable views to photograph. Dr. Marshall had mounted a few feet higher than the others, and called out, "Here is the best place

for the camera," when almost immediately a large stone was seen to fall, followed by his apparently lifeless body. The precise details of the mishap will never be known—whether he stepped or sat down upon a rock loosened by the frost, or whether, as is thought by some well qualified to judge to be more likely, a stone fell upon him from above—must remain a matter for conjecture. The melancholy fact is sufficient that a young and brilliant student of nature passed in an instant from the full enjoyment of health and strength to the "cold obstruction" of death.

Arthur Milnes Marshall was born in 1852, and inherited a love of natural science from his father, a gentleman well known in engineering circles, as well as an enthusiastic naturalist and a microscopist of no mean reputation. He was educated first at a private school, and in 1871 entered St. John's College, Cambridge, where he was one of the earliest students of that school of biology of which he afterwards became so distinguished an ornament. In 1876 he obtained the entrance scholarship in natural science at St. Bartholomew's Hospital, and entered upon the study of medicine. It is hardly too much to say that this step was taken as a *pis aller*. He looked forward with anything but satisfaction to the life of a medical practitioner, and when, in 1879, he was elected to the newly-created chair of zoology in the Owens College, he entered with delight upon a career devoted to the advancement of his favourite science.

As might have been expected from the friend and companion of Balfour his first work was embryological, and consisted of a series of papers on the Cranial Nerves, published in the *Journal of Anatomy and Physiology* and the *Quarterly Journal of Microscopical Science* between the years 1877 and 1881. Though in matters of detail these papers may need correction, and though the "Segmental Value of the Cranial Nerves" is as much open to discussion as it was when Marshall wrote his thesis, these memoirs were at the time solid contributions to our knowledge, and have furnished a basis upon which other men have wrought. The culmination of his work in this direction has been the great work on "Vertebrate Embryology," of which an appreciative notice appeared in these columns so recently that it is not needful to do more than allude to it.

In 1881 the dredging operations of the Birmingham Natural History Society gave him the opportunity of studying the Pennatulida, and in the following year a report upon these animals was issued under the joint authorship of himself and his father. In this and in his subsequent papers on the "Pennatulida of the *Porcupine* and *Triton* Expeditions," and of the "Mergui Archipelago," written partly alone and partly in conjunction with Dr. G. H. Fowler, he carefully elaborated the distinctions between the various forms of zooids and traced the relationships of the genera on morphological grounds. Strong reasons were adduced for dissenting from the classification propounded by Kölliker, though Marshall never considered that he had enough material at command to justify him in proposing an alternative arrangement. On the whole it is probable that these memoirs will form his most lasting contribution to zoological science.

A paper on "The Nervous System of Antedon," containing the results of an Easter vacation spent at Naples, was valuable as establishing beyond question the views of the Carpenters regarding the nervous function of the central capsule and axial cords of Crinoids, but it is still more interesting as an example of Marshall's clear and logical method.

Marshall was a born teacher; his mind was of that rare order which not only sees a problem clearly itself, but is cognisant of every step taken in understanding it, and hence is able to enter into the position of those who approach it for the first time, and to see where their diffi-

culties will lie. His lectures were illustrated not only by wall diagrams, prepared by himself, but by sketches on the blackboard drawn with the clear decided stroke of a master-hand whilst he was talking. He was second to none in appreciating the importance of drawing as a means of fixing the details of a structure upon the student's mind, and it was his custom to offer annually a prize for the best note-book produced by a member of the class.

In his own investigations it was his practice to begin with the illustrations, and in this way the whole of the figures in his "Vertebrate Embryology" were drawn before a line of the text was written. This power of clear exposition and his long experience as a teacher rendered him a singularly competent writer of text-books, as is evidenced by "The Frog," and "Practical Zoology," each of which has passed through several editions.

His powers as a teacher and his powers as an athlete rendered him extremely popular with the students; his advice was often sought and was valued because it was always candid, whilst his geniality and kindness were such that his most outspoken criticism never gave offence.

It is no disparagement, however, to his powers as a scientific investigator and as a teacher, to say that his greatest distinction was his capacity for organisation, though this was as yet only known to those associated with him in administrative work; it is not too much to say that the great success which attended the Manchester meeting of the British Association was mainly due to his efforts as local secretary, whilst his services first as secretary and then as chairman of the Board of Studies rendered no small aid to the Victoria University in the early stages of its growth.

The University Extension movement in Lancashire and Cheshire loses one of its most ardent supporters. Though well aware of the necessary failings of this method of imparting instruction, he was firmly persuaded of its usefulness as a means of stimulating an interest in intellectual studies. He was an ideal Extension lecturer; his singularly lucid style enabled him to expound difficult biological problems to large popular audiences, whilst the truths he taught were indelibly impressed upon his audience by the striking and generally humorous language in which they were couched.

Marshall was elected a Fellow of the Royal Society in 1885, and served upon the Council for the year 1891-2. By his death the scientific world loses a conscientious and brilliant worker; the college and university a successful teacher and administrator; but what of those who are privileged to be his friends? He was a most stimulating influence in work, and a cheery companion in pleasure, whose geniality was never known to be ruffled by ill-temper or irritation. He concealed a deep seriousness beneath a jocular and almost boyish demeanour and phraseology, and whilst rejoicing in an unbounded flow of animal spirits himself, the sorrows of others touched him to the quick and called forth his practical sympathy. Science will progress and the college and university hold on their course but the place of our friend can never be taken by another.

#### NOTES.

IT is with deep regret that we announce the death of Prof. Hertz, the eminent investigator whose work marks an epoch in the history of electrical science. The information comes as a surprise to us, and we are grieved that one from whom so much more might have been expected has been cut off in the prime of his life. The gap produced in the ranks of scientific investigators by his death will not readily be filled.

PROF. P. VAN BENEDEN must be added to the list of men of science who have recently passed away, and whose loss

we mourn. He has just died at Louvain, at the age of ninety-three, but his works live and will always do honour to his name. He was a member of the Brussels Academy of Sciences, and had been professor at Louvain University for nearly sixty years.

WE regret to record the death of Prof. Forchhammer, the well-known archaeologist; of Prof. K. L. Michelet, Berlin at the age of ninety-two; of Dr. S. Guttman, Geheimer Sanitäts-Rath, and editor of the *Medicinisches Wochenschrift*; and of Dr. L. Kraemer, Ordinary Professor of State Medicine in Halle University.

By the death of Dr. George Gordon, natural history in the north of Scotland has lost one of its most enthusiastic and oldest supporters. He died at the advanced age of ninety-two years, on December 12, after working nearly three-quarters of a century in the cause of science.

A COMMITTEE of eminent men of science, art, and literature, with M. Pasteur at its head, has been formed in Paris for the purpose of raising the funds to erect a monument to the memory of the late Dr. Charcot.

DR. R. BRAUNS has been appointed Professor of Mineralogy in the Darmstadt Technical High School.

A BOTANIC garden and arboretum has been established at Buenos Ayres, by M. C. Thays.

PROF. G. SCHWEINFURTH has started on his third botanical exploring visit to the Italian colony of Eritrea, on the Red Sea.

PROF. F. DELPINO, of Bologna, has been appointed Director of the Botanic Garden at Naples, and Professor of Botany in the University.

ONE of the bequests in the will of Mr. A. Peckover, who died last month, is the sum of £100 to the Linnean Society.

MR. F. E. IVES has been awarded the Elliott Cresson gold medal of the Franklin Institute for his system of colour photography, known as composite heliochromy.

THE Society for the Encouragement of Industry in the Netherlands offer a prize equivalent to £30, and a gold medal, for the best memoir on the production of electricity by wind-mills. Intending competitors must send in their schemes before July 1, to the Secretary of the Society, Haarlem, Holland.

ELECTRICAL engineers have as yet been unable to perfect a system of working tramways electrically along crowded thoroughfares. Inventors have long been engaged endeavouring to overcome the difficulties, and as an incentive to them to throw themselves into their task with renewed vigour is an announcement in the *Times* that the Metropolitan Traction Company of New York City has offered the handsome award of about £10,000 for a system of street-car propulsion which will be superior or equal to the overhead trolley system, but without possessing the objectionable feature of the trolley for crowded thoroughfares.

THE Committee on Science and the Arts of the Franklin Institute has issued a circular in which attention is directed to three awards under its control. The character and conditions of these awards are, briefly, as follows:—The Elliott Cresson Medal is of gold, and may be granted for some discovery in the arts and sciences, or for the invention or improvement of some useful machine, or for some new process, or combination of materials in manufactures, or for ingenuity, skill, or perfection in workmanship. The John Scott Legacy Premium and Medal (twenty dollars and a medal of bronze) is awarded for useful inventions. The Edward Longstreth Medal of Merit is

of silver, and may be awarded for useful invention, important discovery, and meritorious work in, or contributions to, science or the industrial arts. Full directions as to the manner and form in which applications for the investigation of inventions and discoveries should be made will be sent to interested persons on application to the Secretary of the Franklin Institute, Philadelphia.

IN the annual report just issued by the University of Edinburgh, acknowledgment is made of several benefactions. We read that a legacy of £1000 has been bequeathed by the late Mrs. Elizabeth Trevelyan for the foundation and endowment of a scholarship in engineering and mechanical and useful arts, and another bequest, by the late Mr. George Scott, of £1000 is destined for the foundation of a scholarship in arts. Since the close of the previous academic year a handsome bequest of £5000 by the late Mr. Alexander Low Bruce, to assist in the foundation of a chair of public health, has been intimated. Of very special interest and value is a collection of Arctic and other relics and curiosities, made by the late Dr. John Rae, the distinguished Arctic explorer, along with his bust, presented by his widow.

WE would call attention to a new departure in University College. During the Easter Term Dr. L. E. Hill, Assistant Professor of Physiology, will give a practical course of instruction in psycho-physiology. The course will take the student methodically over the several senses, and familiarise him with the methods by which the new branch of science known as physiological-psychology or psycho-physics determines the precise manner in which sensation varies both quantitatively and qualitatively with variations of the stimulus, of the particular portion of the sensitive surface stimulated, and so forth. This is, we believe, almost the first attempt in this country to give to students systematic laboratory instruction in those experimental methods of investigating sense-phenomena which have already borne such valuable fruit in Germany and America. As supplying an exact and practical method of measuring sensibility the course should further prove valuable to teachers and others.

THE increasing interest in psychological investigation in America is shown by the establishment of many psycho-physical laboratories, and by the formation last year of the American Psychological Association, which drew to Columbia College at its second meeting, December 27 and 28, a distinguished gathering of original investigators. The programme, besides the annual address of the president, Prof. G. T. Ladd, of Yale University, included the following papers:—The psychological standpoint, by Prof. G. S. Fullerton, University of Pennsylvania; the case of John Bunyan, by Prof. Josiah Royce, of Harvard University; some account of investigations at Columbia College, by Prof. Cattell; same at Harvard University, by Prof. Münsterberg; same at Yale, by Prof. Scripture; experiments on visual memory, by Mr. H. C. Warren, of Princeton University; Do we ever dream of tasting? by Prof. J. C. Murray, of McGill College, Montreal; an early anticipation of Mr. Fiske's doctrine as to the meaning of infancy, by Prof. N. M. Butler, of Columbia College; accurate work in psychology, by Dr. E. W. Scripture, of Yale University; the problem of psychological measurement, by Mrs. G. H. Mead, of the University of Michigan; the perception of magnitude and distance, by Dr. J. H. Hyslop, of Columbia; pain and pleasure, by Mr. H. R. Marshall, of New York; pain contrasts, by Prof. Edward Pace, of Catholic University, Washington; the confusion of content and function in the analysis of ideas, by Prof. D. S. Miller, of Bryn Mawr College. Prof. James, of Harvard, was elected president for the ensuing year, and Princetown was named as the place of the meeting on December 27 and 28 of this year.

AT the general meeting of the Association for the Improvement of Geometrical Teaching, to be held at University College, London, January 13, a new undertaking will be proposed by the Council, viz., the establishment of a journal of elementary mathematics, to appear three times a year, and to be specially devoted to such subjects as are usually taught in secondary schools.

A COURSE of lectures on matters connected with sanitation will be given at the Sanitary Institute from January 26 to April 2. Among the lecturers are Sir Douglas Galton, Profs. Corfield, H. Robinson, A. W. Blyth, A. B. Hill, Dr. J. F. J. Sykes, Dr. A. Newsholme, and Dr. Hamer. The lectures have been arranged for the special instruction of those desirous of obtaining a knowledge of the duties of sanitary officers.

ON Tuesday next (January 16), Prof. Charles Stewart, the newly elected Fullerian Professor of Physiology in the Royal Institution, will begin a course of lectures on "Locomotion and Fixation in Plants and Animals." The Friday evening meetings will begin on January 19, when Prof. Dewar will discourse on the "Scientific Uses of Liquid Air."

THE annual general meeting of the Royal Meteorological Society will be held on January 17, when the report of the council will be read and the election of officers and council for the ensuing year will take place. The president of the society will deliver an address on "The Climate of Southern California."

A PERIOD of very severe weather has recently been experienced over these islands and the whole of Western Europe. On the 1st inst. an anticyclone lay over Scandinavia, and subsequently spread over the northern parts of this country, causing frost in many places, while snow showers occurred in England, accompanied by bitter easterly gales. For some days the frost and snow continued with increased intensity. The reports issued by the Meteorological Office show that on the morning of the 6th inst. the minimum temperature in South London fell to 13°, while on the previous day a temperature of 16° was recorded at Jersey, being 22° below the average minimum for January, and at Biarritz a reading of 14° was recorded on the 4th, being 20° lower than the reading at Bodö in Norway, within the Arctic Circle. Towards the end of the week the easterly gales had subsided in the south-east, but had spread to the northern parts of the kingdom. On Saturday morning the Meteorological Office reported a temperature of 5° in the Midland Counties and 6° in the centre of Ireland, but later information in the *Weekly Weather Report* shows that the absolute shade minimum recorded was minus 4° at Braemar and in the Midlands on that day. With reference to the temperature in the north-west of London, Mr. Symons recorded 13°·1 on the 5th, and a maximum temperature of 18°·4. His long series of observations shows that the severity of the night of the 4th and 5th was only exceeded three times in the last thirty-five years, viz. December 25, 1860, January 4, 1867, and January 17, 1881 (the day preceding the blizzard); while as regards the maximum, there has been only one day as severe during the same period, viz. January 4, 1867, when the temperature did not exceed 16°·9. The frost continued until the morning of the 8th, when a deep depression appeared off the south-west of Ireland, causing southerly winds and a considerable rise of temperature, and by Monday evening a thaw had set in generally.

OWING to delay at the Government Printing Office, Mr. H. C. Russell, the Government Astronomer for New South Wales, has only just been able to issue the results of rain, river, and evaporation observations made in that colony in 1892. In addition to the usual matter, the report contains the results of an attempt to determine the average rainfall of Australia. It will



be many years before the rainfall of Australia will be measured in all parts, but taking the values already obtained, and weighing them in proportion to the area of each colony in which they were made, the average annual value of the rainfall for the whole of the mainland of Australia comes out as 21·15 inches. Another matter which Mr. Russell has investigated is the effect of altitude upon temperature. In works of reference it is usually stated that a rise of 300 feet causes a fall of 1° Fahr., but this quantity must evidently vary with the locality. A comparison of the average temperatures at ten different places with that of Sydney, making an allowance at the rate of 1° Fahr. for a difference of one degree of latitude, gave 344 feet as the mean elevation required to produce a fall of 1° Fahr. The report concludes with an average rainfall map, constructed on the plan described in these columns on December 21; a new rainfall map for the year; a map showing the monthly distribution of rain over each square degree of New South Wales, and curves showing the height of the western rivers of that colony throughout 1892.

THE *Transactions* of the Devonshire Association for the Advancement of Science for 1893 contain a good account of the climate of Torquay, by A. Chandler, from trustworthy instruments. This health resort is favoured by a large amount of sunshine; dividing the year into two periods the summer has an average of 43·4 per cent., and the winter 30·5 per cent. of the possible amount. The average mean shade temperature is 50°·2, and the mean annual range 11°·4. The mean temperature of summer is 56°·5, and of winter 43°·8. The highest summer temperature during the year 1892 was only 78°·2, and the lowest winter temperature was 22°·4. The mean annual rainfall for twenty-five years, 1864-88, was 37 inches; June is generally the driest month, with an average of about 2 inches, and January the wettest, with a mean of a little over 4 inches. The prevalent winds are warm, being from south-west, and the town enjoys great freedom from storms. The observations are now organised and provided for by the Town Council.

WRITING upon the persecution of the Great Skua (*Stercorarius Catharticus*) in the *Annals of Scottish Natural History* for January, Mr. W. E. Clarke points out that a fact worth remembering in the history of those birds which have become extinct within the present century, is that their extermination had, in all instances, become an accomplished fact for several years before such was realised to be the case. In order to lead ornithologists to do something to prevent the Great Skua from a similar fate, Mr. Clarke gives an account of the persecution to which the bird is subject, and the wholesale stealing of its eggs. The evidence he brings forward shows that unless some measure of protection is immediately afforded to the Great Skua, this fine bird must soon cease to exist in Europe.

MISS E. A. ORMEROD contributes to the *Times* of Monday some observations on insect attacks upon crops and trees in this country during last year. She points out that the attacks of the year were much influenced by the exceptional deficiency of rainfall in the early half of 1893, from March onwards, and by other weather peculiarities. With regard to the imported locust appearances, the specimens which reached her alive proved to be of a South European species, which is not gregarious, and in its own country, though of large size, is known to do no appreciable damage. From the climatic requirements of locusts, therefore, and also from recorded experience, there does not appear to be any reason to fear even a possibility of locusts effecting a settlement in this country. It is pointed out by Miss Ormerod, however, that the presence of locusts in great quantities in fodder might be detrimental to the health of animals fed upon it.

ANOTHER note on locusts, more or less connected with the above, is contained in a statement recently issued by the Government of India (*Agricultural Ledger Series*, No. 2, 1893). Dr. Gunther suggested to the Government, some time ago, that dried locusts might be used for insectivorous cage-birds and game-birds which are now reared at great expense upon ants' eggs. His letter was submitted to Mr. E. C. Cotes, of the Indian Museum, Calcutta, who has reported favourably upon it, but thinks there would be a difficulty in keeping up the supply from India at the present time. But though the invasion of India by the locust *Acridium peregrinum*, Oliv., is now practically at an end, Mr. Cotes says that Northern Africa, which was badly invaded in 1892 by the same insect, and is still infested, might offer a favourable ground for experiment.

THE silk-spider of Madagascar forms the subject of an interesting article in *Die Natur*, by Dr. Karl Müller. Its native name is Halabé, meaning great spider. This Halabé, or *Nephila Madagascariensis*, spins threads of a golden colour, and strong enough, according to Mairdron, to hang a cork helmet by. The female spider may attain a length of 15 c.m., while the male does not exceed 3 c.m. A single female individual, at the breeding season, gave M. Camboué, a French missionary, some 3000 m. of a fine silken thread, during a period of about twenty-seven days. The thread was examined with a view to creating a new industry. Specimens tested at a temperature of 17° C. showed an elongation of 12·48 per cent. under a weight of 3·27 gr. Small textures woven of these threads are actually used by the natives for fastening flowers on sunshades, and for other purposes.

PROF. J. WIESNER, who has recently been studying the influence of artificial rain upon European and exotic plants, gave an account of his results at a recent meeting of the Vienna Academy. Some of the plants, called by Prof. Wiesner *ombrophobe*, can only for a short time stand continuous rain, and soon shed their leaves and decay. Others, called *ombrophil*, can stand it for months together. Plants growing in dry places are, as a rule, ombrophobe, but the reverse cannot be said of plants growing under wet surroundings. Leaves appear to gain in power of resisting rain as they develop, and to reach a climax in this respect at the period of their greatest vital activity, after which they lose much of that power. Leaves which can be wetted by water are usually ombrophil, those which cannot are usually ombrophobe, but in cases where leaves are both ombrophobe and easily wetted, they are extremely sensitive to rain. Prof. Wiesner thinks that ombrophobe leaves are enabled to resist the putrefactive action of water, especially at high temperatures, by certain antiseptic substances which they contain. The same may be said of hydrophil roots and submerged parts of aquatic plants.

THE edible lichen of Japan, known as "iwatake," is described in the *Botanisches Centralblatt* (1893, No. 45) by Dr. M. Miyoshi, under the name *Gyrophora esculenta*, sp.n. Its commercial value is due to the large amount which it contains of starch and of some gelatinous substance; and it is also extensively used in Japanese cookery as a condiment, having a pleasant flavour and being free from purgative properties. In some parts of Japan, especially the mountainous districts, it completely covers the moist granite rocks. After drying it is sent into the towns, and a large quantity is annually exported.

IN a recent number of the *Electrical World* (of New York), Lieut. F. Jarvis Patten has described a novel method of obtaining sinusoidal alternating currents of very low frequency. The apparatus, which the inventor calls a "liquid commutator," consists of a circular vessel, provided with two conducting electrodes fixed at the opposite extremities of a diameter. A con-

tinuous current is passed from one of these electrodes to the other, through the liquid contained in the vessel, the strength of the current being controlled by an internal resistance. A vertical spindle at the centre of the trough carries a revolving arm provided with conducting plates or electrodes at its extremities. These plates are insulated from one another, and are connected to two ring contacts carried by the central spindle. Two brushes bear on these rings, and convey the alternating current. By suitably altering the connections and electrodes, it is possible in the same manner to obtain multiphase currents. The author finds that the currents obtained are practically sinusoidal, and he suggests that they will be of considerable physiological use.

At a recent meeting of the Société Française de Physique, M. Hurmuzescu showed some experiments on electrical convection in air. He finds that if you cause dissymmetry between the two discharging knobs of a Wimshurst electrical machine, by fixing a point to one of them, then, on placing a sensitive gold-leaf electroscope at a distance of about two metres, when the machine is worked, the discharging knobs being separated, the electroscope becomes charged. The electroscope becomes more highly charged when it is fitted with a point than when it has only a varnished ball at the end of its electrode. That the charge is not due to induction, but to convection through the air, is shown by the fact that the interposition of a metallic screen does not interfere with the effect, while if the electroscope is covered over by an insulating shade no electrification is observable. In addition, it is found that the charge on the electroscope is of the same sign as that of the terminal of the machine on which the point is fixed. The most marked and rapid results are obtained when the point on the machine is negatively electrified, while no effects are observed if the point is turned towards the plates of the machine.

AN account of Victor Schumann's successes in photographing rays of very short wave-lengths is given in No. 50, of the *Naturwissenschaftliche Rundschau*. These successes are entirely due to the elimination of absorption by the material used in the prisms and lenses and, what is especially noteworthy, of the layers of air intervening between the luminous source and the plate used for photographing the spectrum. This elimination has resulted in the exhaustive exploration of the hitherto doubtful ultra-violet region between  $231.4$  and  $185.2 \mu\mu$ , and the annexation of the region down to  $100 \mu\mu$  to the known spectrum. For this it was necessary to get rid of the absorption due to the film of gelatine in which the sensitive silver salt was embedded, and this was accomplished by the substitution of a pure silver bromide plate. The camera, the spectro-copic apparatus, and the spark tube were all connected together and exhausted. The very first exposure on the hydrogen spectrum showed that the known radiations of that gas only represent a portion of its total radiance. The newly-traced portion turned out to be extremely rich in lines, with a maximum at about  $162 \mu\mu$ , and consisted of fifteen groups of lines disposed pretty evenly, containing altogether about 600 lines, with intensities decreasing from the maximum in both directions, rapidly at first, and then very gradually. The wave-lengths of these lines are as yet undetermined. Provisionally, that of the smallest wave-length recorded is estimated at  $100 \mu\mu$ . The spectra of aluminium, cadmium, cobalt, and other metals end at about  $170 \mu\mu$ . A layer of normal air 1 mm. in thickness appears capable of absorbing all radiation of smaller wave-length than that. Dry gelatine absorbs eagerly all waves beyond  $217 \mu\mu$ . Quartz is not suitable for prisms and lenses, and white fluor-spar is, so far, the only material that answers all requirements. The accurate determination of the new wave-lengths, the further investigation of the absorption due to air, and the further extension of the

ultra-violet region, are the problems which Herr Schumann is now working at.

IN a note published in NATURE on July 20, attention was drawn to the manner in which the virulence of the typhoid bacillus may be increased by the products of other organisms being inoculated along with it into animals. In an elaborate paper, recently published in the *Annali dell' Istituto d'Igiene di Roma*, vol. iii. 1893, p. 117, Roncali shows how the virulence of the tetanus bacillus may be intensified by similar means. Thus an animal inoculated with this organism usually succumbs in three days; if, however, the soluble products of this bacillus be accompanied with those of some other organism, death ensues with tetanic symptoms in from 12-26 hours. It was also found that if by some means or other the power of resistance inherent in the animal was first diminished, the action of the tetanus toxine was greatly accelerated. This condition of diminished resistance was obtained by either first inoculating some other organism, or by introducing putrid infusions of meat or vegetables in themselves proved to be perfectly harmless to the animal in question. To further illustrate this point, symptoms of chronic tetanus were induced in animals by the inoculation of the soluble products of the tetanus bacillus obtained after from 3-4 days' growth. After from 8-10 days, if pathogenic or non-pathogenic organisms were introduced, the animals died in from 16-18 hours, whilst if they were not subsequently interfered with, they usually recovered in from 20-35 days. In the course of these investigations the interesting discovery was made that the bacillus of rabbit septicæmia, which is usually non-pathogenic to mice, may be rendered fatal to the latter by cultivation on agar-agar containing the soluble products of the tetanus bacillus. These experiments indicate how harmless saprophytes, such as the *b. prodigiosus*, may under given conditions become the servants of disease organisms, either by diminishing an animal's power of resistance, and so preparing the way for the entrance and work of pathogenic bacteria, or by hastening the lethal action of the latter by subsequent intrusion into the system of the infected animal.

WE have received three fascicules of the forthcoming volumes of the *Memoirs (Zapiski)* of the Russian Geographical Society. One of them contains D. Pokotilov's elaborate paper, "U-tai, its Past and Present," given to the description of the holy mountain of the Buddhists and its numerous monasteries. M. Pokotilov has followed the same route as Dr. Jos. Edkins ("Religion in China"), and also describes his journey from Peking to the U-tai Mountain; but he also gives a detailed description of the Buddhist sanctuary, and the history of the development of Buddhist monasteries at this spot. The learned Russian scholar has utilised, moreover, the Chinese works devoted to the same subject. Taken in connection with Prof. Pozdnev's large work, "Sketches of the Life of Buddhist Monasteries and Buddhist Clergy," lately published in the *Memoirs* of the same Society (Ethnography, vol. xvi., 1887), M. Pokotilov's paper is a very valuable addition to the literature of the subject. Another fascicule of the *Zapiski* (Geography, vol. xv. No. 3) contains F. Schwartz's report on his astronomical, magnetical, and barometrical observations in Bokhara, Darvaz, Karateghin, and Russian Turkestan, made in 1886. A third fascicule (Statistics, vol. vii. No. 2) contains a detailed description of the Eritrean colony of Italy, by M. A. Troyansky.

THE Physical Society of London has just issued the third part of vol. xii. of its Proceedings.

THE first part is published of the new *Flore de France* (including Corsica and Alsace-Lorraine), by MM. G. Rouy and J. Foucaud.

WE have received No. 8 of the first volume of "Contributions from the U.S. National Herbarium." It is chiefly occupied by the description of American grasses, a large number of new species being described.

THE current number of the *Asclepiad* (vol. x. No. 39), edited by Sir B. W. Richardson, F.R.S., contains a good account of the works of Robert Boyle, and an autotype of that eminent investigator, from an engraving by R. Woodman.

THE second edition of Clowes' and Coleman's "Quantitative Analysis" (J. and A. Churchill) is about to be issued. The authors have thoroughly revised the book, and have introduced many recent modifications in processes, as well as new methods of analysis.

THE *Journal of the Royal Statistical Society* (part iv. vol. lvi.) has been received by us. It contains, among other papers, the presidential address delivered by Mr. Charles Booth in November last, and that given by Prof. Nicholson before the Economic Science and Statistical Section of the British Association at the Nottingham meeting.

WE have received "Eau Sous Pression," by M. F. Bloch, being a new volume in the Aide-Mémoire Series published by Gauthier-Villars, Paris. The early chapters in the book are devoted to enunciating hydrostatic and hydrodynamic principles, and stating the general theory of pumps, hydraulic rams, and accumulators. The subject is then treated from a practical point of view. The book contains thirty illustrations in the text, and does credit to an excellent series.

The Technical Instruction Committee of the County Council of Cumberland has issued a Directory of the Science and Art Classes, &c., under its control. We learn from this source that the average attendance of students at science classes held under the committee's jurisdiction is 1328. The subject that obtains the highest average is theoretical chemistry; then come agriculture, mathematics, plane and solid geometry, and physiography. Sound, light, and heat shows, by far, the lowest number of students, the average attendance for the whole county being only eight.

THE third volume (Series 3) of the *International Journal of Microscopy and Natural Science* has been published. The journal is the organ of the Postal Microscopical Society of London, which has for its object the circulation, study, and discussion of microscopic objects. The volume just received contains a large amount of information of use to microscopists, and several excellent papers, notably one on polarised light and its applications to the microscope, by Mr. G. H. Bryan, and a translation from *La Diatomiste* of Dr. Miquel's long article on the artificial cultivation of diatoms. The journal is well illustrated and does credit to the society the proceedings of which it reports. We have noticed two misprints, one on p. 8, where "Leek" is printed instead of Lick, and on p. 69 "Wills" is printed instead of Wells.

A USEFUL series of "Handbooks of Commercial Products" has been provided to the Imperial Institute by the Government of India. The books contain descriptions of the economic products of India, and among several of them recently received is one on Indian coal, in which a large number of facts concerning the geology and working of the coal districts are brought together. The iron resources and iron industries of the southern districts of the Madras Presidency are described in another of the handbooks, the account being accompanied by a plate showing the process adopted for the manufacture of wrought iron. The furnace employed is roughly circular in horizontal section, four feet high, two feet in diameter at the

base, and only nine inches in diameter at the throat. Two other handbooks of interest to us summarise the present state of knowledge concerning the characters and occurrence of Indian micas and steatite.

A NUMBER of new reactions of formaldehyde, resulting in the preparation of several new compounds, are described by M. Henry in the *Bulletin de l'Académie Royale de Belgique*. This lowest number of the series of aldehydes, HCHO or O=CH<sub>2</sub>, appears to be endowed with very considerable chemical energy, as indicated by the readiness and frequently the violence with which it reacts with a large number of substances. The reactions now described are those which occur between formaldehyde and the primary and secondary amines. If a solution of methylamine is added to one of formaldehyde, in small portions at a time, a very energetic reaction occurs with evolution of so much heat that great loss occurs unless the vessel in which the operation is performed is surrounded by a freezing mixture. When the reaction is complete, the two substances being then present in equivalent quantities, the addition of solid potash precipitates methyl methylenamine, H<sub>2</sub>C=N-CH<sub>3</sub>, from the solution. This substance is readily purified, and proves to be a colourless mobile liquid, readily soluble in water, and boiling at 166°. At the temperature of a freezing mixture of ether and solid carbon dioxide it solidifies, and may be melted again at -27°. The ethyl compound may be similarly obtained, and is likewise a liquid; it boils at 207-208°, and melts after solidification by ether and solid carbon dioxide at -45°. Two molecular equivalents of dimethylamine react with even greater avidity in aqueous solution with one molecular equivalent of formaldehyde, and the reaction can only be safely carried out at a very low temperature. The product is tetramethyl methylene-

diamine  $\text{CH}_2 \begin{matrix} \diagup \text{N}(\text{CH}_3)_2 \\ \diagdown \text{N}(\text{CH}_3)_2 \end{matrix}$ , a colourless and very mobile liquid

which fumes strongly, dissolves in water, and boils at 85°. Ether and solid carbon dioxide will not solidify it. The tetraethyl compound, prepared in an analogous manner, is also a fuming liquid; it boils at 168°. All these compounds are insoluble in strongly alkaline liquids. They readily absorb water, like the amines, formaldehyde and the substituted ammonia being regenerated. A somewhat curious fact is observed in connection with the boiling-points. Methyl methylenamine CH<sub>2</sub>:NCH<sub>3</sub> boils at 166°, and methyl isocyanate CONCH<sub>3</sub>, the analogous oxygen compound, at 43°; so that the replacement of two atoms of hydrogen by one of oxygen is accompanied in this case by a reduction of the boiling point by 123°. On the other hand, while the compound  $\text{CH}_2 \begin{matrix} \diagup \text{N}(\text{CH}_3)_2 \\ \diagdown \text{N}(\text{CH}_3)_2 \end{matrix}$  boils at 85°, the corresponding oxygen compound tetramethyl urea boils at 177°, nearly a hundred degrees higher.

IN a further communication to the *Bulletin* of the Belgian Academy, M. Henry describes a new mode of preparing halogen substitution products of the oxides (ethers) of the alkyl radicles. The monochlorine derivative of methyl ether CH<sub>2</sub>Cl·OCH<sub>3</sub> was prepared in 1877, by Friedel, by chlorination of the ether. It is now shown to be much more readily obtained by mixing a concentrated aqueous solution of formaldehyde with methyl alcohol and saturating the cooled solution with hydrochloric acid gas. The compound separates as a colourless liquid layer at the surface of the solution, and by distillation the pure substance is at once obtained, boiling at 60°. The monobromine derivative may be obtained in a precisely similar manner, and proves to be a pungently-fuming liquid, boiling at 87°. The iodine compound is also afforded by the analogous reaction with hydriodic acid, the pure liquid boiling at 124°; but, in addition, the di-iodine

derivative  $\text{CH}_2\text{I}\cdot\text{O}\cdot\text{CH}_2\text{I}$  is simultaneously formed. Incidentally M. Henry observed that phenol reacts in a most violent manner with formaldehyde, great heat being evolved, and a remarkable porcelain-like substance being produced which is insoluble in all the usual solvents.

THE additions to the Zoological Society's Gardens during the past week include a Black-handed Spider Monkey (*Ateles ater*, ♀) from Eastern Peru, presented by Mr. L. Clarke; a Coot (*Fulica atra*) European, presented by Mrs. L. Spender; two Wedge-tailed Eagles (*Aquila audax*) from Australia, presented by Mr. F. W. Burgess; a Long-billed Butcher Bird (*Barita destructor*) from New Holland, deposited; a Salvin's Amazon (*Chrysotis salvini*) from South America, two Purple-capped Lories (*Lorius domicella*) from Moluccas, purchased; a Yak (*Popagus grunniens*) born in the Gardens.

#### OUR ASTRONOMICAL COLUMN.

HARVARD COLLEGE OBSERVATORY REPORT.—In this, the forty-eighth annual report to the President of the University, Prof. Pickering, the director of the Astronomical Observatory of Harvard College, has a fine record of work to refer to, which has been carried out during the twelve months ending October 31, 1893. We make the following brief extracts from the accounts given of the various branches of work done in the several departments. The East Equatorial was on the whole worked by Mr. O. C. Wendell, and employed for the systematic observation of variable stars upon the system lately adopted. Photometric observations of Jupiter's satellites (twenty-five in number) were made; forty-eight series of wedge photometer observations (3354 measurements) for determining the brightness of 1118 stars occurring in the Durchmusterung, were also made. Among other uses of this instrument were the observations of comets, measurements with the polarising photometer, &c. The Meridian Circle has been, as usual, at work under the direction of Prof. W. Rogers, while good progress has been made in the reductions of the observations of the southern stars with the meridian photometer. The observing list for the latter observations contains about 6000 stars, and excluding the 4000 already contained in the Harvard Photometry, three quarters have now been made. Mr. W. Reed, with the West Equatorial, on eighty-seven evenings has made observations on variable stars (489), comparison stars (1318), and ten on the brightness of Comet Holmes.

With regard to the Henry Draper Memorial, Mrs. Fleming has given us, as usual, her list of stars with peculiar spectra, and her examination has resulted in the discovery of the new star in Norma. In addition to a classification of the 20149 spectra of stars for the new catalogue, work has been done with the 8-inch and 11-inch, resulting in the production of 2424 and 1037 photographs respectively. A most interesting series (213 photographs) of  $\beta$  Aurigæ has also been obtained.

In the Boyden Department, in addition to an expedition to observe the total solar eclipse in April last, important work was done by the 13-inch telescope, which was devoted to a study of the members of the solar system, an account of which has been previously referred to in this column. Prof. Bailey, the director of the third expedition, began work on April 4, and with an 8-inch and 13-inch telescope has obtained 1516 and 852 photographs with these two instruments respectively; some of these pictures show some very remarkable southern clusters. This observatory has also a meteorological station on Mount Chachani, 16,650 feet, the highest in the world; a second one has now been established on the volcano El Misti, at an elevation of 19,200 feet, with self-recording instruments. The Bruce photographic telescope will now be soon completed and ready for work, but the Bruce transit photometer has already made some progress towards the observations of tenth magnitude stars as standards for faint stellar magnitudes. Zodiacal phenomena have also been systematically observed. The new brick building for the thirty thousand glass photographic plates is finished, and the plates have been transferred. In his concluding remarks Prof. Pickering alludes to the difficulty, now becoming more and more significant every year, with regard to the observation of faint objects, owing to the increasing number of electric lights in the neighbourhood. An "electric tram" trouble seems also approaching a focus in

the near future. We hope Prof. Pickering will successfully override these difficulties.

THE "GEGENSCHHEIN."—In order to find out the origin of this peculiar phenomenon an effort has been made to obtain observations as nearly contemporaneous as practicable, and made at widely separated points. The distribution of light in the zodiac, and particularly of the slight maximum nearly opposite the sun, and known as "Gegenschhein," or Counter-glow, has for some time past attracted the attention of astronomers, and we hope the present systematic attempt will be rewarded with successful results. Those cooperating in this work are Prof. Barnard, of the Lick, Prof. Bailey at Arequipa, Prof. Searle and Mr. Reed at Strafford, Vermont, and Mr. Douglass at Cambridge, U.S.A. Prof. Barnard, after describing the general appearance of this phenomenon (*Astr. Journal*, No. 308), besides noticing the change of form and its connection with a zodiacal band, finds that his observations show that the "Gegenschhein" lags behind exactly opposite the sun, or, in other words, that its longitude is not quite  $180^\circ$  greater than that of the sun. His numbers are:—

|                     | From | $\lambda - \odot$ . | $\beta$ . | No. obs. |
|---------------------|------|---------------------|-----------|----------|
| 1883-1887           | ...  | 179.4               | +0°.4     | 16       |
| 1888-1891           | ...  | 179.4               | +1°.3     | 16       |
| Sept. and Oct. 1893 | ...  | 179.6               | +0°.5     | 22       |

His observations show no decided parallax to the object, but an appreciable north latitude, as seen from the value of  $\beta$  in the table above, will be noticed.

Prof. Barnard believes that the latitude of the "Gegenschhein" and the lagging in longitude to be due to "atmospheric absorption, and that the object is exactly opposite the sun, and that it lies in the ecliptic, and if its centre were a definite point the position of the sun could be accurately determined from observations of the 'Gegenschhein' by changing the sign of the declination and subtracting twelve hours from the Right Ascension."

#### GEOGRAPHICAL NOTES.

THE Arctic expedition planned by Dr. Stein, of the U.S. Geological Survey, as the first of a series for the gradual exploration of the Arctic regions from a base in Ellesmereland (see *NATURE*, vol. xlix. p. 18), is being actively prepared. According to Reuter's agency the command of the expedition has been offered to Baron Nordenskiöld, who has contributed £250 to its fund and has arranged by cable to keep a place open for a Swede on the staff. Dr. Stein has agreed to the latter proposal, and has stated that his first duty will be to search for the Swedish naturalists Björling and Kalstennius, whose tragic story has been briefly told in this column (p. 85). The possibility that the unfortunate party was able to reach the Eskimo of Ellesmereland and live with them for two years is very slight, but as long as the faintest chance remains it is satisfactory to find that arrangements are being made for a search and possible succour.

M. E. A. MARTEL, whose researches on the subterranean watercourses of France and Greece are well known, has been investigating the Adelsberg Grotto and other karst phenomena of Carniola, in company with Herr Putick. They were able to solve conclusively some points in the hydrology of the river Piuka, and found their way into parts of the Adelsberg cavern never before reached, proving that the whole length of the underground passages in connection with it is not less than 10 kilometres.

WITH the publication of vol. xix., dealing with South America, M. Elisée Reclus' great work, "Nouvelle Géographie Universelle: La Terre et les Hommes," has been completed. Twenty years have elapsed since the first volume was published, and these years have seen immense advances of geographical knowledge; but by the device of treating the less known continents at the end of the work, it has not fallen seriously out of date. Its great features are the philosophic grasp of the relation of man to his natural surroundings, and the working out of this relation for each continent and country. It is unfortunate that the state of public feeling on the continent makes it impossible for the University of Brussels to carry out the appointment of M. Reclus to a professorship there (see *NATURE*, vol. xlvii. p. 327 on account of his political views.

At a meeting of the Royal Scottish Geographical Society, held last week at Edinburgh, with Prof. J. Geikie in the chair, to consider the question of Antarctic research, the following resolution by the council of the Society was read:—"That at this meeting, held for the discussion of Antarctic research, the Royal Scottish Geographical Society resolves to give its hearty support to the promotion of further exploration in the Antarctic. The Society's council is of opinion that at the present time a properly equipped Government expedition would, with the increased advantages of steam and modern appliances, have every prospect of successful explorations in the South Polar regions. The council is also convinced that the additions which might be made to our knowledge of climatology, terrestrial magnetism, geology, and natural history, would be of such practical scientific value as to fully justify the equipment of such an expedition at national expense. Towards the promotion of this object the council considers it desirable to submit a memorial on this subject to her Majesty's Government, and in this action they invite the cooperation of all the leading scientific societies of Scotland. To this end the Society appoints an Antarctic committee, consisting of Dr. John Murray, Prof. James Geikie, Dr. Buchan, and Mr. J. G. Bartholomew, together with the delegates of the other scientific societies, with instructions to draft such a memorial and take such steps towards the promotion of Antarctic exploration as is deemed desirable." A committee of the Royal Geographical Society was formed on the occasion of Dr. Murray's paper (NATURE, vol. xlix. p. 112), and has already been at work for some time with a view to bring the whole question of Antarctic exploration before Government. The course of action of this committee we understand to be the memorialisation of the Royal Society, requesting that body to take the lead in approaching the Government after ascertaining the feeling of all the leading scientific societies of the United Kingdom.

## THE RISE OF THE MAMMALIA IN NORTH AMERICA.<sup>1</sup>

### II.

#### *Primitive Trituberculism.*

There is a very general tendency among the vertebrates as a whole, fishes and reptiles as well as mammals, to form what are called "triconodont" crowns by the addition of lateral cusps to simple cones. In the mammals alone, these three cusps pass into higher stages of evolution, through what is called "trituberculy," in which these cusps form a triangle. The discovery of primitive widespread trituberculy by Cope was a great step forward. In looking over the odontographies of Cuvier, Owen, Tomes, and Baume, we find there is no suspicion of this common type around which the highly diverse mammalian molars centre. The molars of the clawed and hoofed mammals can now be compared, as we compare the hand or foot of the horse with that of the cat, because they spring from a common type. All the specialised mammalian series—ungulates, primates, carnivores, insectivores, rodents, marsupials—are found playing similar yet independent adaptive variations upon one type. We thus have a clue to the comparison of all molars with each other and with the reptile cones; take the human grinders, for example. The anterior outer cusps in the upper jaw, and the anterior inner cusps in the lower jaw, are homologous with each other and with the reptilian cone. Leaving aside for the moment Multituberculates and Monotremes, every known triassic, jurassic, cretaceous and basal eocene mammal (excepting *Dicrocyon*) is in some stage of trituberculy; all the known cretaceous molars are simple triangles above; all later fossil mammals also converge to trituberculy, until in the lowest eocene every molar is tritubercular, and the early stages of divergence are so similar that it requires a practised eye to distinguish the molar of a monkey from that of a horse. Embryology supports the evidence of these fossil series. Thanks to the recent admirable researches of Röse and Tæcker, we find in the primates, ungulates and marsupials, that in the calcification of its dental caps every molar is heralded by *three cones placed in a triangle*, and in the lower jaw these three cones invariably appear in the same order (protocone, paracone, and

metacone) in which they arose during the remote geological periods.

It is necessary to mention this overwhelming palæontological evidence, because "trituberculy" is still not universally recognised; Fleischmann and others have questioned the homologies of the upper and lower triangles, and two able writers, Röse and Forsyth Major, have independently proposed an opposition theory that "multituberculy" or "polybony" is the mammalian archetype, the latter author believing trituberculy has become a "dogma." So far, however, from there being any decline of evidence, I am now able to add the Cretaceous mammalia to the tritubercular lists and bring forward evidence that the multitubercular molar instead of being primitive was derived from the tritubercular; moreover, all the researches I have been quoting tend to draw the mammals without exception into one of three great primary forms. The haplodont form, from which *Dromotherium* is just emerging in the Trias, is the oldest and nearest the reptiles: the triconodont, or three cones in line, was a predominating lower Jurassic type; the tritubercular, or three cones in a triangle (trigonodont, Rüttimeyer), was the prevailing upper Jurassic and later form. The final predominance of the tritubercular over the others was due to its possibilities of mechanical adaptation to work of every kind—its *potential* in evolution. Upon the polyphyletic theory of the origin of the mammals here advocated, we must admit, first, the independent evolution of trituberculy in different phyla; and second, the branching off of several great groups in the pre-tritubercular stages.

The tendency of late research is to show that all stem mammals were related in their diphyodontism, in their dental formula, and in their primitive molar form. These features point, not to a succession, but to a unity of ancestry of the Monotremes, Marsupials, and Placentals.

#### *Divergence of the Three Groups.*

The discovery of the complete double series seems to have removed the last prop from the theory of the Marsupial ancestry of the placentals, for the peculiar mode of suppression of the second series in the Marsupials has been constant since the Purbeck; this difficulty is added to the structure of the jaw, the epipubic bones, the profoundly different mode of fetal nutrition. None the less, any conclusion we can draw now as to the primary relations of the three great groups is more or less of a "Schwindelbau," and I put together the results of these later discoveries with a full realisation of the temporary character of present conclusions.

The Permian Sauro-Mammalia (Baur) with a multiple succession of simple conical teeth divided into: A, Theromorpha, which lost the succession and in some lines acquired a heterodont dentition and triconid single-fanged molars; B, Pro-mammalia.

The hypothetical lower Triassic Pro-mammalia retained a double succession of the teeth; they became heterodont, with incipient triconid double-fanged molars; dental formula approximating 4. 1. 4-5. 8. They gave rise to three groups: I. The Prototheria which passed rapidly through the tritubercular into the multitubercular molars in the line of Multituberculates, and more slowly into trituberculy and its later stages in the line of Monotremes. II. The Metatheria or Marsupials tended to suppress the second series of teeth, except those intercalated with the first; by this and by reduction the formula became 5. 1. 3. 4-6; the molars passed slowly through the triconodont into the typical tritubercular type. III. The Eutheria or Placentals divided early into a number of branches, in which there was heterodontism, but no uniform modification of succession.

We may distinguish four chief branches among these, as follows: (A) forms suppressing the second series in the molar region only, and acquiring a typical Eutherian dentition, 3. 1. 4. 3-4. 1. The Insectivores tended to partly suppress the anterior teeth of the second series or intercalate them with teeth of the first series; the molars became tritubercular. 2. The higher Placentals retained the succession of the first and second series as far back as the first molar; the molars entered rapidly into trituberculy and its higher stages. (B) forms retaining the double succession in part of the molar region, and retaining more of the primitive dentition, 4. 1. 4. 8. 3. The Edentates branched off from an early triconodont or tritubercular

Continued from p. 238.

diphyodont stage, with numerous molars, and secondarily suppressed the first heterodont series, and established a numerous homodont second series. 4. The Cetacea also branched off from a diphyodont, heterodont stage, and secondarily established a numerous homodont first series, suppressing the second series.

*Breaks and Links in the Mesozoic Fauna.*

By our hypothesis all three sub-classes flourished together during the American Mesozoic; the Marsupials disappeared, then the Monotremes, and by the end of the basal Eocene the Placentals were in exclusive possession of the northern continent.

Although we have great reason to congratulate ourselves upon the rapid progress of discovery, there still remain great gaps in Mesozoic time between certain horizons, and in the lineal phyletic series of both the Mesozoic and Cenozoic. For a time standard we may take advantage of the remarkably constant evolution of the Plagiaulacidae in the Mesozoic, and of the Equidae in the Cenozoic—as certain invertebrates are made use of in older rocks. The grooves and tubercles of Plagiaulax and the cusps and styles of the horses are added with the precision of clockwork, and supposing that the rate of evolution has been about the same, we can approximately estimate both the periods of deposition and the intervals as follows.

| PLAGIAULACIDÆ.          |              |          |          |                     |
|-------------------------|--------------|----------|----------|---------------------|
|                         | Stonesfield. | Purbeck. | Laramie. | Puerco. Cernaysian. |
| Number of Premolars,    | 4-3          | 2        | 2-1      | 1                   |
| Grooves on Premolars,   | 7-9          | 11-14    | 12-15    | 14                  |
| Molar Tubercles: outer; |              |          |          |                     |
| inner;                  | 4:2          | 6:4      | 6:4      | 9:6                 |

Estimating the geological intervals by dental evolution and faunal succession, there is first the great gap between the Trias of Microlestes and Dromatherium and the Jurassic of the Stonesfield slate; there is a relatively shorter interval, but still a considerable one between this and the Purbeck or Atlantosaurus beds. Then follows another long and very important interval between the Atlantosaurus beds and the Laramie (Upper Cretaceous). The gap between the Laramie and Puerco was relatively short, as indicated by the comparatively limited evolution both of the Plagiaulacids and Trituberculates. The Puerco was itself a long period in which the Plagiaulacids underwent considerable changes. Then follows an interval which it is most important to fill by future exploration, for between the Puerco and the Wahsatch the differentiation of the even and the odd-toed ungulates must have occurred. The Wahsatch proper does not mark a very extensive evolution of the forms it contains. It passes, after a slight break, into the base of the Bridger (Wind River), and then begins that splendid and almost uninterrupted succession of lake basins, terminating in the Pliocene. I append a table, to be compared with that published by Marsh in his admirable address of 1877, and which exhibits the great progress of the last sixteen years.

THE SUCCESSION OF THE NORTH AMERICAN MAMMALIA.

| PERIODS.                | HORIZONS.                                  | CHARACTERISTIC GENERA.                                                                                                                                                                                                                                                               | NEW TYPES APPEARING.                                                                                                                                                                                                                                                                                                                | TYPES BECOMING EXTINCT.                                                            |
|-------------------------|--------------------------------------------|--------------------------------------------------------------------------------------------------------------------------------------------------------------------------------------------------------------------------------------------------------------------------------------|-------------------------------------------------------------------------------------------------------------------------------------------------------------------------------------------------------------------------------------------------------------------------------------------------------------------------------------|------------------------------------------------------------------------------------|
| Post or Upper Pliocene. | EQUUS.                                     | <i>Equus</i> , 5 species. Elephant, <i>E. primigenius</i> . Mastodon, Llamas, Camels, <i>Eschatus</i> , <i>Holomeniscus</i> . Elk, <i>Alces</i> . <i>Platygonus</i> . Sloths, <i>Myiodon</i> , <i>Glyptodon</i> . <i>Ursus</i> .                                                     |                                                                                                                                                                                                                                                                                                                                     |                                                                                    |
| True Pliocene.          | BLANCO.                                    | <i>Equus</i> , 3 species. <i>Mastodon</i> , 3 sp. Llamas, <i>Plianchenia</i> , <i>Platygonus</i> . Sloth, <i>Megalonyx</i> . <i>Felidae</i> . (?) <i>Hyonide</i> . <i>Mustelidae</i> .                                                                                               |                                                                                                                                                                                                                                                                                                                                     |                                                                                    |
| MIOCENE.                | LOUP FORK.                                 | <i>Protolophos</i> , <i>Hipparion</i> . <i>Mastodon</i> . Rhinoceroses, <i>Aphelops</i> , 5 species. <i>Canide</i> . <i>Felidae</i> . Rodents, Edentates. Camels and Llamas, <i>Procamelus</i> , <i>Protolabis</i> . Oreodons, 3 genera. Deer, <i>Blastomeryx</i> , <i>Cosoryx</i> . |                                                                                                                                                                                                                                                                                                                                     | Extinction of Oreodons and hornless rhinoceroses.                                  |
| Upper.                  | DEEP RIVER.                                | <i>Protolophos</i> , <i>Anchitherium</i> . First Mastodons. Oreodons, <i>Cyclopidius</i> , <i>Chalicotherium</i> . Tylopoda.                                                                                                                                                         | Oreodons, <i>Cyclopidius</i> .                                                                                                                                                                                                                                                                                                      | Disappearance of <i>Chalicotherium</i> . Extinction of Oreodons, <i>Hyonides</i> . |
| Middle.                 | JOHN DAY. WHITE RIVER.                     | <i>Miohippus</i> . Two-horned Rhinoceros, <i>Diceratherium</i> . <i>Hyopotamus</i> . Peccaries. Oreodons. Rodents. <i>Canide</i> , <i>Felidae</i> . Tylopoda.                                                                                                                        | <i>Diceratherium</i> . <i>Hyopotamus</i> . Peccaries. Rodents. <i>Canide</i> , <i>Felidae</i> .                                                                                                                                                                                                                                     | Extinction of Elotheres and <i>Hyopotamus</i>                                      |
|                         | PROTOCEFRAS. (Upper.)                      | (?) <i>Miohippus</i> . <i>Artionyx</i> .                                                                                                                                                                                                                                             | Appearance of tragulines, Elotheres, <i>Hyopotamus</i> , pigs and peccaries, true dogs, cats, monkeys. <i>Leptauchenia</i> . <i>Colodon</i> . <i>Chalicotherium</i> . <i>Aceratherium</i> . <i>Protapirus</i> , <i>Agriochorus</i> . Opossums. Tylopoda, <i>Poebrotherium</i> . Creodonts, <i>Hyonodon</i> . Rodents. Insectivores. | Extinction of Hyracodons.                                                          |
| Lower.                  | OREODON. (Middle.) TITANOTHERIUM. (Lower.) | <i>Mesohippus</i> . <i>Amynodon</i> .                                                                                                                                                                                                                                                | <i>Mesohippus</i> . <i>Amynodon</i> .                                                                                                                                                                                                                                                                                               | Extinction of <i>Amynodons</i> . Extinction of Titanotheres.                       |
| EOCENE.                 | UINTA.                                     | <i>Ephippus</i> , <i>Amynodon</i> . Titanotheres, <i>Diplacodon</i> . First Oreodons, <i>Protoreodon</i> . First Tylopoda, <i>Leptotragulus</i> . Tapirs. Hyracodons. Rodents. Creodonts, <i>Mesonyx</i> .                                                                           | First Oreodons, <i>Protoreodon</i> . First Tylopoda, <i>Leptotragulus</i> . Tapirs.                                                                                                                                                                                                                                                 |                                                                                    |
| Upper.                  | BRIDGER. WASHAKIE. (Upper.)                | <i>Pachynolophus</i> . Appearance of <i>Amynodons</i> and horned Titanotheres. <i>Palaosyops</i> . <i>Hyrachyus</i> . <i>Triplopus</i> . <i>Achanodon</i> .                                                                                                                          | Appearance of <i>Amynodons</i> and horned Titanotheres. <i>Palaosyops</i> . <i>Hyrachyus</i> . <i>Triplopus</i> . <i>Achanodon</i> .                                                                                                                                                                                                | Extinction of Dinocerata, of some Creodonts.                                       |
|                         | BRIDGER. (Middle.)                         | <i>Pachynolophus</i> . Appearance of Insectivora, Chiroptera, Hyracodons. <i>Uintatherium</i> . <i>Palaosyops</i> . Creodonts.                                                                                                                                                       | Appearance of Insectivora, Chiroptera, Hyracodons. <i>Uintatherium</i> . <i>Palaosyops</i> . Creodonts.                                                                                                                                                                                                                             | Extinction of Tillodontia.                                                         |
| Middle.                 | WIND RIVER. (Lower.)                       | <i>Hyracotherium</i> , <i>Palaosyops</i> . Dinocerata. <i>Coryphodon</i> . <i>Phenacodus</i> .                                                                                                                                                                                       | <i>Hyracotherium</i> , <i>Palaosyops</i> . Dinocerata. <i>Coryphodon</i> . <i>Phenacodus</i> .                                                                                                                                                                                                                                      | Extinction of <i>Coryphodontia</i> and <i>Condylarthra</i> .                       |
|                         | WAHSATCH.                                  | <i>Hyracotherium</i> . Appearance of Artiodactyls, Perissodactyls: tapirs, horses, titanotheres, lophiodons. First Rodents. First <i>Coryphodons</i> , Lemurs and Monkeys. Creodonts, 6 families, <i>Palaonictis</i> .                                                               | Appearance of Artiodactyls, Perissodactyls: tapirs, horses, titanotheres, lophiodons. First Rodents. First <i>Coryphodons</i> , Lemurs and Monkeys. Creodonts, 6 families, <i>Palaonictis</i> .                                                                                                                                     | Extinction of Arctocyonans.                                                        |
| Lower.                  | Interval.                                  | (Differentiation of modern clawed and hoofed placentals.)                                                                                                                                                                                                                            |                                                                                                                                                                                                                                                                                                                                     |                                                                                    |
|                         | PUERCO.                                    | <i>Ptilodus</i> , <i>Neoplagiaulax</i> , <i>Polymastodon</i> . Ancient types of Ungulates, Carnivores and Insectivores: Amblypoda, <i>Condylarthra</i> , <i>Creodonta</i> , <i>Tæniodonta</i> , <i>Tillodontia</i> . Lemurs.                                                         | Ancient types of Ungulates, Carnivores and Insectivores: Amblypoda, <i>Condylarthra</i> , <i>Creodonta</i> , <i>Tæniodonta</i> , <i>Tillodontia</i> . Lemurs.                                                                                                                                                                       | Extinction of Multituberculates (?) Monotremes).                                   |
|                         | Interval.                                  | (Differentiation of ancient clawed and hoofed placentals.)                                                                                                                                                                                                                           |                                                                                                                                                                                                                                                                                                                                     | Disappearance of Marsupials.                                                       |
| UPPER CRETACEOUS.       | LARAMIE.                                   | <i>Ptilodus</i> . <i>Bolodontide</i> (Multituberculates). <i>Thalacodon</i> , Trituberculate Placentals and Marsupials. Typical dentition.                                                                                                                                           | <i>Ptilodus</i> . <i>Bolodontide</i> (Multituberculates). <i>Thalacodon</i> , Trituberculate Placentals and Marsupials. Typical dentition.                                                                                                                                                                                          |                                                                                    |
| MIDDLE JURASSIC.        | Atlantosaurus.                             | <i>Ctenacodon</i> , <i>Plagiaulax</i> , <i>Bolodon</i> , Multituberculates (?) Monotremes). Triconodonts (?) Marsupials). Trituberculates (?) Placentals). Primitive dentition.                                                                                                      |                                                                                                                                                                                                                                                                                                                                     |                                                                                    |
| UPPER TRIASSIC.         | Chatham Coal Beds.                         | <i>Protodonta</i> , <i>Dromotherium</i> , <i>Microconodon</i> , primitive Triconodonts (?) Monotremes).                                                                                                                                                                              |                                                                                                                                                                                                                                                                                                                                     |                                                                                    |

The general faunal succession is marked by the sudden appearance and disappearance of certain series and rise and fall of great groups. In the Trias appears the remarkable protodont or primitive-toothed *Dromotherium*; we cannot determine its order at present. We still have no American fauna corresponding to the intermediate Stonesfield of England. In the Jurassic *Atlantosaurus* beds the three supposed representatives of the *Monotremes* (multituberculates), *Marsupials* (triconodonts), and *Placentals* (trituberculates), appear in equal numbers; the latter are generally characterised by the primitive dental formula. In the Laramie the *Multituberculates* continue in great profusion, and the *Marsupials* and *Placentals* are also numerous.

The serial succession of the *Trituberculates* from the Mesozoic is still an unknown chapter; we are utterly unable to connect the *Dromotheriidae* of the Trias, the *Triconodontidae*, *Amphitheriidae* and *Amblotheriidae* of the Jura with each other, or with any Cretaceous or lower tertiary mammals. The serial relations of the *Multituberculates*, on the other hand, have been made much clearer by the discovery of the Laramie fauna. Cope and Marsh in this country, and Smith Woodward in England, have at last broken into the long barren Cretaceous. In studying the accurate figures published by Marsh and a large collection of teeth recently made for the American Museum by Wortman and Peterson, I find that this Laramie fauna is widely separated from the Jurassic in its general evolution, and as Gaulty, Lemoine, and Cope have observed, it approaches more nearly the basal Eocene of the Puerco and the Cernaysian of France. The *Multituberculates* of the Laramie include the *Plagiaulacidae*, represented by *Ptilodus*, the form with two premolars, and *Meniscoessus*, with two premolars and crescentic tubercles. *Meniscoessus* has a smaller fourth premolar, and is found to lead off to the huge *plagiaulacide* *Polymastodon* of the Puerco. The only other *Multituberculates* found are those related to *Bolodon* of the Jurassic and *Chirox* of the Puerco. The other mammals of the Laramie range from the mouse to the opossum in size; they have superior molars of the simple tritubercular type—the low cusped or bunodont molar predominating in the upper jaw, and the tuberculo-sectorial in the lower. The dental formula is mostly the typical p. 4, m. 3. Yet, judging by the angular region of the jaws, we have here both *Placentals* and *Marsupials*. Some of the teeth remind us strongly of those in the Puerco; their determination, however, is very difficult, for the jaws and teeth are almost entirely isolated. From another exposure of the Laramie, Cope has recently found the remarkable type *Thlæodon*—remarkable because it is a highly specialised trituberculate of typical dentition with a jaw which bears resemblance to that of the *Multituberculates* and of *Ornithorhynchus*. There is no placental angle nor strong marsupial inflection. This raises the supposition that *Thlæodon* may be one of the persistent trituberculate *Monotremes* which we are now looking for.

In the Puerco or basal Eocene, a very marked change occurs, for the American fauna loses some of its cosmopolitan character, the *Multituberculates* or *Monotremes* die out and the *Marsupials* are not found at all; in fact they do not reappear in North America until the Miocene.

*Ancient and Modern Placental Differentiation.*

The Puerco is essentially an archaic fauna and is to be regarded as the climax of the first period of placental differentiation, a culmination of the first attempts of nature to establish insectivorous, carnivorous and herbivorous groups. These attempts began in the Cretaceous, and some of the types thus produced died out in the Puerco, some in the Wahsatch and Bridger; only a few flesh-eaters survived to the Miocene. It is most important to grasp clearly the idea of this functional radiation in all directions of this old Puerco fauna, resulting in forms like the modern insectivores, rodents, bears, dogs and cats, monkeys, sloths, bunodont and selenodont ungulates, and lophodont ungulates. This was an independent radiation of placentals, like the Australian radiation of marsupials. What was the cause of the wide-spread extinction of these types? So far as the ancient clawed types are concerned, their teeth and feet seem to be as fully adaptive in many cases as those of the later unguiculates; the hoofed types were certainly inferior in tooth evolution, for all their molars evolved on the triangular basis instead of the sextitubercular; the most sweeping defect of both the clawed

and hoofed types was the apparent incapacity for brain-growth, their bodies went on developing while their brains stood still. Thus the stupid giant fauna, the *Dinocerata*, which rose out of this period, gave way to the small but large-brained modern types. It is noteworthy that the latest survivors of this wreck of ancient life were the large-brained *Hyænodons*.

Some of the least specialised spurs of this radiation appear to have survived and become the centres of the second or mid-Tertiary radiation from which our modern fauna has evolved. Yet we have not in a single case succeeded in tracing the direct connection. To sum up, we find on the North American continent evidence of the rise and decline and disappearance of *monotremes* and *marsupials*, and two great periods of placental radiation, the *ancient radiation* beginning in the mesozoic, reaching a climax in the Puerco and unknown post-Puerco, and sending its spurs into the higher tertiary, and the *modern radiation* reaching its climax in the Miocene, and sending down to us our existing types.

Another Eocene centre was lower South America, which has of late dimmed the prestige of North America in yielding strange forms of life. One theory of this Patagonian fauna is that it was an independent centre of functional radiation like the Puerco and Australian, full of adaptive parallels, but not yielding to Europe or America any of their older types. But Ameghino, to whose energetic researches we are chiefly indebted, believes that he finds a lower Eocene life zone—a sort of *south polar* centre—which supplied both America and Europe. The Puerco he believes is no older than the Santacruzian, which in turn is very much older than the Parana and Pampean formations, which Burmeister has made so well known. This yields the *Homunculus Patagonicus* which parallels Cope's *Anaptomorphus* in presenting a dentition as advanced in reduction as that of man. Ameghino finds here the ancestors of the *Macrauchenidae*; he believes the *Homodontotheriidae* are the ancestors of the *Chalicotheriidae*—thus deriving a bunodont from a lophodont type; the *Protheriidae*, he believes, replace the *Condylarthra* and *Hyracotherium* in the ancestry of the horses. Similarly the *Microbiotheriidae* are the stem of the creodonts and carnivores. I cannot coincide with any of these views. The *Multituberculates* are far older and widely different from the *Abderites* to which Ameghino traces their ancestry. I fully concur with the opinion of Cope, Zittel, Scott and others that this fauna is of somewhat later age, that it was directly connected with Australia and somewhat later with North America, supplying us, as has always been supposed, with our sloths. I quote from a recent address by Scott:—

“The oldest mammals from South America are those from Patagonia, which Ameghino has referred to the Eocene, but which are more probably Oligocene or Miocene. This fauna is of extreme peculiarity and isolation; it is made up chiefly of edentates, rodents and ungulates of those very aberrant types known as *Litopterna* and *Toxodontia*, which are so widely different from the hoofed mammals of the northern hemisphere; together with some primitive forms of primates, creodonts and marsupials. The marsupials are of extraordinary interest, for they comprise not only forms allied to the opossums, but also to recent Australian forms such as *Thylacinus*, *Dasyurus* and *Hypsiprymnus*. This is a most unexpected fact, and seems to point unmistakably to a great southern circumpolar continent.”

The Puerco thus remains the most extensively known and most productive lower Eocene centre, yet we have very slender threads of positive evidence to connect its fauna with the later placental radiation.

The *Creodonts* of Cope occupy the same relation to the modern insectivores and carnivores that the *Condylarthra* do to the ungulates. The American group has been recently enriched by the discoveries of Wortman, and the literature by the careful revision of Scott. This author has divided them into eight families, placing the forms which most resemble the *Insectivora* in the new family, *Oxycænidæ*. These families illustrate superbly the same law of functional radiation later repeated in the placental and marsupial carnivores. The *Mesonyx* family presents some analogies to the *Thylacines*. The modern bears are paralleled in the *Arctocyon*s, with their low tubercular molars; Wortman and myself, with fresh materials, have recently added *Anacodon* to this family, a genus which was doubtfully regarded by Cope as an ancient ungulate. The *Cats* and *Hyænas* are imitated in the *Oxyænas* and *Hyænodons*, some of the Miocene forms of which Scott

suggests developed aquatic habits; as above noted, some of this family acquired large brains, and persisted late into the Miocene. A still more remarkable likeness to the cats is exhibited in the Palæonictis family, which, unlike the Hyænodons, forms its sectorials out of exactly the same teeth as the true cats. The first American Palæonictis was found two years ago by Wortman, and this author and myself have suggested that this may be the long-sought ancestor of the Felidæ. The Civets are anticipated in the Proviverridæ; yet both: Cope and Scott, the highest authorities on this subject, believe that the dog-like Miacidæ alone formed the connecting link between the Creodonts and the true Carnivora.

The foot structure of the ancient Puerco ungulates is still only partly known. Cope has divided these animals into the Amblypoda and Condylarthra. The Amblypoda are represented in the Puerco by a large form called Pantolambda, with selenodont triangular upper molars, and possibly by Peripitychus, with bunodont triangular molars. The Pantolambda molars were, as Cope has shown, converted into those of Coryphodon, the great lophodont Amblypod of the Wahsatch, by a process exactly analogous to that in which the anterior half of a Palæotherium molar was formed, that is, they acquired outer and anterior crests but no posterior crests. This Coryphodon molar type was still later converted into the Uintatherium type by swinging around the outer crest into a transverse crest. I have recently made a careful study of the fore and hind feet of Coryphodon, and have found that while the fore-foot was subdigitigrade like that of the elephant, the hind-foot was fully plantigrade, the entire sole resting upon the ground. The relation or connection between the Bridger Dinocerata and these earlier Amblypoda is still unknown. The Puerco Peripitychus left no descendants. The other ungulates of the Puerco were the Condylarthra, the primitive Phenacodontidæ, the supposed ancestors of the Artiodactyls and Perissodactyls. Much remains to be done to clear up this question.

Thus an immense number of problems still await solution, and demand the generous co-operation of European and American specialists in the use of similar methods of research, in the prompt publication of descriptions and figures, and in the free use of museum collections. I may be pardoned for calling general attention to the service which the palæontological department of the American Museum is trying to render in the immediate publication of stratigraphical and descriptive tables of western horizons and localities.

#### *The Factors of Evolution.*

A few words in conclusion upon the impressions which a study of the rise of the mammalia gives as to the factors of organic evolution. I refer also to recent papers by Cope, Scott, and myself.

The evolution of a family like the Titanotheres presents an uninterrupted march in one direction. While apparently prosperous and attaining a great size, it was really passing into a great corral of inadaptation to the grasses which were introduced in the Middle Miocene. So with other families and lesser lines extinction came in at the end of a term of development and high specialisation. With other families no causes for extinction can be assigned, as in the lopping off of the smaller Miocene perissodactyls. The point is that a certain trend of development is taken leading to an adaptive or inadaptive final issue—but extinction or survival of the fittest seems to exert little influence *en route*.

The changes *en route* lead us to believe either in predestination—a kind of internal perfecting tendency—or in kinetogenesis. For the trend of evolution is not the happy resultant of many trials, but is heralded in structures of the same form all the world over and in age after age, by similar minute changes advancing irresistibly from inutility to utility. It is an absolutely definite and lawful progression. The infinite number of contemporary developing, degenerating, and stationary characters preclude the possibility of fortuity. There is some law introducing and regulating each of these variations, as in the variations of individual growth.

The limits of variation seem to lie partly in what I have called the "potential of evolution." As the oöspERM or fertilised ovum is the potential adult, so the Eocene molar is the potential Miocene molar. We have seen that the variations of the horse and rhinoceros molars, apparently so diverse, are really uniform—is not this evidence that the perissodactyl stem

had these variations *in potentia*, waiting to be called forth by certain stimuli? This capacity of similar development under certain stimuli is part of the law of mammalian evolution, but this does not decide the crucial point whether the reaction is spontaneous in the germ or inherited from the parent. I incline to the latter opinion.

H. F. OSBORN.

### *A DYNAMICAL THEORY OF THE ELECTRIC AND LUMINIFEROUS MEDIUM.<sup>1</sup>*

#### I.

IT is only at the end of the last century that the somewhat vague principle of the economy of action or effort in physical actions—which, like all other general principles in the scientific explanation of nature, is ultimately traceable to a kind of metaphysical origin—has culminated in the hands of Lagrange in his magnificent mathematical generalisation of the dynamical laws of material systems. Before the date of this concise and all-embracing formulation of the laws of dynamics there was not available any engine of sufficient power and generality to allow of a thorough and exact exploration of the properties of an ultimate medium, of which the mechanism and mode of action are almost wholly concealed from view. The precise force of Lagrange's method, in its physical application, consists in its allowing us to ignore or leave out of account altogether the details of the mechanism, whatever it is, that is in operation in the phenomena under discussion; it makes everything depend on a single analytical function representing the distribution of energy in the medium in terms of suitable co-ordinates of position and of their velocities; from the location of this energy, its subsequent play and the dynamical phenomena involved in it are all deducible by straightforward mathematical analysis.

The problem of the correlation of the physical forces is thus divisible into two parts, (i.) the determination of the analytical function which represents the distribution of energy in the primordial medium—which is assumed to be the ultimate seat of all phenomena; and (ii.) the discussion of what properties may be most conveniently and simply assigned to this medium, in order to describe the play of energy in it most vividly, in terms of the stock of notions which we have derived from the observation of that part of the interaction of natural forces which presents itself directly to our senses, and is formulated under the name of natural law. It may be held that the first part really involves in itself the solution of the whole problem; that the second part is rather of the nature of illustration and explanation, by comparison of the intangible primordial medium with other dynamical systems of which we can directly observe the phenomena.

The chief representative of exact physical speculation of the second of these types has been Lord Kelvin. In the older attempts of this kind the dynamical basis of theories of the constitution of the æther consisted usually in a play of forces, acting at a distance, between ultimate elements or molecules of the medium; from this we must, however, except the speculations of Greek philosophy and the continuous vortical theories of the school of Descartes, which were of necessity purely descriptive and imaginative, not built in a connected manner on any rational foundation. It has been in particular the aim of Lord Kelvin to deduce material phenomena from the play of inertia involved in the motion of a structureless primordial fluid: if this were achieved, it would reduce the duality, rather the many-sidedness, of physical phenomena to a simple unity of scheme; it would be the ultimate conceivable simplification. The celebrated vortex theory of matter makes the indestructible material atoms consist in vortex rings in a primordial fluid medium, structureless, homogeneous, and frictionless, and makes the forces between the atoms which form the groundwork of less fundamental theories consist in the actions excited by these vortices on one another through the inertia of the fluid which is their basis—actions which are instantaneously transmitted if the fluid is supposed to be absolutely incompressible.

In case this foundation proves insufficient, there is another idea of Lord Kelvin's by which it may be supplemented. The characteristic properties of radiation, which forms so prominent an element in actual phenomena, can be explained by the

<sup>1</sup> A paper read before the Royal Society on December 7, 1893, by Dr. Joseph Larmor, F.R.S., Fellow of St. John's College, Cambridge.



existence of an elastic medium for its transmission at a finite, though very great, speed; such a medium renders an excellent account of all its relations, if we assume it to possess inertia and to be endowed with some elastic quality of resistance to disturbance roughly analogous to what we can observe and study in ordinary elastic solids of the relatively incompressible kind, such as indiarubber and jellies. Lord Kelvin has been the promoter and developer of a view by which the elastic forces between parts of such a medium may be to some extent got rid of as ultimate elements, and be explained by the inertia of a spinning motion of a dynamically permanent kind, which is distributed throughout its volume. If we imagine very minute rapidly-spinning fly-wheels or gyrostats spread through the medium, they will retain their motion for ever, in the absence of friction on their axes, and they will thus form a concrete dynamical illustration of a type of elasticity which arises solely from inertia; and this illustration will be of great use in realising some of the peculiarities of a related type, which I believe can be thoroughly established as the actual type of elasticity transmitting all radiations, whether luminous and thermal or electrical—for they are all one and the same—through the ultimate medium of fluid character of which the vortices constitute matter.

It has always been the great puzzle of theories of radiation how the medium which conveys it by transverse vibrations, such as we know directly only in media of the elastic-solid type, could yet be so yielding as to admit of the motion of the heavenly bodies through it absolutely without resistance. According to the view of the constitution of the æther which is developed in this paper, not only are these different properties absolutely consistent with each other, but it is, in fact, their absolute and rigorous coexistence which endows the medium with the qualities necessary for the explanation of a further very wide class of phenomena. The remark which is the key to this matter has been already thrown out by Lord Kelvin, in connection with Sir George Stokes's suggested explanation of the astronomical aberration of light. The motion of the ultimate homogeneous frictionless fluid medium, conditioned by the motion of the vortices existing in it, is, outside these vortices, of an absolutely irrotational character. Now, suppose the medium is endowed with elasticity of a purely rotational type, so that its elastic quality can be called into play only by absolute rotational displacement of the elements of the medium; just as motion of translation of a spinning gyrostat calls into play no reaction, while any alteration of the absolute position of its axis in space is resisted by an opposing couple. As regards the motion of the medium involved in the movements of its vortices, this rotational elasticity remains completely latent, as if it did not exist; and we can at once set down the whole theory of the vortical hydrodynamical constitution of matter as a part of the manifestations of an ultimate medium of this kind.

The explanation of the laws of physical optics advanced by Fresnel, and verified by comparison with the phenomena which was possible in several very exact ways, chiefly by himself and Brewster, was, about the year 1835, engaging the attention of several of the chief mathematicians of that time—Augustin Cauchy in France, Franz Neumann in Germany, George Green in England, and James MacCullagh in Ireland. The prevalent mode of attacking the problem was through the analogy with the propagation of elastic waves in solid bodies; and the comparison of Fresnel's laws of propagation in crystalline media with the results of the mathematical theory of the elasticity of crystalline bodies gave abundance of crucial tests for the verification, modification, or disproof of the principles assumed in these investigations.

The greatest achievement of MacCullagh is that contained in his memoir of 1839, entitled an "Essay towards a Dynamical Theory of Crystalline Reflexion and Refraction." He is in quest of a dynamical foundation for the whole scheme of optical laws, which had been notably extended and confirmed by himself already. He recognises, I think for the first time in a capital physical problem, that what is required is the discovery of the potential-energy function of Lagrange on which the action of the medium depends, and that the explanation of the form of that function is another question which can be treated separately. His memoir is subsequent to, but apparently quite independent of, that of Green, in which Green restricted the medium to a constitution like an elastic solid, laid down the general laws of such constitution for the first time, and made a magnificent failure of his attempt to explain

optical phenomena on that basis. If this thing was to be done, the power, simplicity, and logical rigour of Green's analysis might have been expected to do it; and nothing further has come of the matter until the recent new departure of Lord Kelvin in his speculation as to a labile elastic-solid æther. To return to MacCullagh, he is easily able to hit off a simple form of the potential-energy function, which—on the basis of Lagrange's general dynamics, or more compactly on the basis of the law of Least Action—absolutely sweeps the whole field of optical theory so far as all phenomena are concerned in which absorption of the light does not play a prominent part. He is confident, as any one who follows him in detail must be, that he is on the right track. He tries hard to obtain a dynamical basis for his energy-function, that is, to imagine some material medium that shall serve as a model for it, and illustrate its possibility and its mode of action; he records his failure in this respect, but at the same time he protests against the limited view which would tie down the unknown and in several ways mysterious and paradoxical properties of the luminiferous medium to be the same as those of an ordinary elastic solid.

The form of MacCullagh's energy-function was derived by him very easily from the consideration of the fact that it is required of it that it shall produce, in crystalline media, plane-polarised waves propagated by displacements in the plane of the wave front. Though he seems to put his reasoning as demonstrative on this point, it has been pointed out by Sir George Stokes, and is indeed obvious at once from Green's results, that other forms of the energy-function beside MacCullagh's would satisfy this condition. But the important point as regards MacCullagh's function is that it makes the energy in the medium depend solely on the absolute rotational displacements of its elements from their equilibrium orientations, not at all on its distortion or compression, which are the quantities on which the elasticity of a solid would depend according to Green.

Starting from this conception of rotational elasticity, it can be shown that, if we neglect for the moment optical dispersion, every crystalline optical medium has three principal elastic axes, and its wave-surface is precisely that of Fresnel, while the laws of reflexion and refraction agree precisely with experiment. Further, it follows from the observed fact of transparency in combination with dispersion, that the dispersion of a wave of permanent type is properly accounted for by the addition to the equations, therefore to the energy-function, of subsidiary terms involving spacial differentiations of higher order. To preserve the medium hydrodynamically a perfect fluid, these terms also must satisfy the condition that the elasticity of the medium is thoroughly independent of compression and distortion of its elements, and wholly dependent on absolute rotation. It can be shown, I believe, that this restriction limits the terms to two kinds, one of which retains Fresnel's wave-surface unaltered, while the other modifies it in a definite manner stated without proof by MacCullagh; but the first terms depend on an interaction between the dispersive property and the wave motion itself, while the second terms involve the square of the dispersive quality. It seems clear that the second type involves only phenomena of a higher order of small quantities than we are here considering; thus an account of dispersion remains which retains Fresnel's wave-surface unaltered for each homogeneous constituent of the light, while it includes the dispersion of the optic axes in crystals both as regards their magnitudes and directions—results quite unapproached by any other theory ever entertained.

In this analysis of dispersions, all terms have been omitted which possess a unilateral character, such as would be indicated in actuality by rotatory polarisation and other like phenomena. The laws of crystalline material structures seem to prohibit the occurrence of such asymmetry as these terms would indicate, except to the very small extent evidenced by the hemihedral faces of quartz crystals. The influence of this asymmetric arrangement of the molecules on the optical medium must be very much smaller still, for the rotatory terms are in all media exceedingly minute compared with the ordinary dispersive terms. The form of these rotatory terms in the energy-function is at once definitely assigned by our condition of perfect fluidity of the medium, both for crystals and for rotational liquids such as turpentine, and this form is the one usually accepted, on MacCullagh's suggestion, as yielding a correct account of the phenomena.

When dispersive terms are included in the energy function,

our continuous analysis is not any longer applicable to the problem of reflexion; the conditions at the interface are altogether too numerous to be satisfied by the available variables. There is in fact discontinuity at the interface in the discrete molecular structure, such as could not be representable by a continuous analysis. But if we proceed by the method of rays, and assume that there is a play of surface forces which do not absorb any energy, while they adjust the dispersal part of the stress, it appears that reflexion is independent of dispersion.

The problem of the æther has been first determinedly attacked from the side of electrical phenomena by Clerk Maxwell in quite recent times; his great memoir on a "Dynamical Theory of the Electromagnetic Field" is of date 1864. It is in fact only comparatively recently that the observation of Oersted, and the discoveries and deductions of Ampère, Faraday, and Thomson had accumulated sufficient material to allow the question to be profitably attacked from this side. Even as it is, our notions of what constitute electric and magnetic phenomena are of the vaguest as compared with our ideas of what constitutes radiation, so that Maxwell's views involve difficulties, not to say contradictions, and in places present obstacles which are to be surmounted, not by logical argument or any clear representation, but by the physical intuition of a mind saturated with this aspect of the phenomena. Many of these obstacles may, I think, be removed by beginning at the other end, by explaining electric actions on the basis of a mechanical theory of radiation, instead of radiation on the basis of electric actions. The strong point of Maxwell's theory is the electromotive part, which gives an account of electric radiation and of the phenomena of electromagnetic induction in fixed conductors; and this is in keeping with the remark just made. The nature of electric displacement, of electric and magnetic forces on matter, of what Maxwell calls the electrostatic and the magnetic stress in the medium, of electrochemical phenomena, are all left obscure.

We shall plunge into the subject at once from the optical side, if we assume that dielectric polarisation consists in a strain in the æther, of the rotational character contemplated above. The conditions of internal equilibrium of a medium so strained are easily worked out from MacCullagh's expression for  $W$ , its potential energy. If the vector  $(f, g, h)$  denote the curl or vorticity of the actual linear displacement of the medium, or twice the absolute rotation of the portion of the medium at the point considered, and the medium is supposed of crystalline quality and referred to its principal axes, so that

$$W = \frac{1}{2} \int (a^2 f^2 + b^2 g^2 + c^2 h^2) d\tau,$$

where  $d\tau$  is an element of volume, it follows easily that for internal equilibrium we must have

$$a^2 f dx + b^2 g dy + c^2 h dz = -dV,$$

a complete differential, and that over any boundary enclosing a region devoid of elasticity the value of  $V$  must be constant. Such a boundary is the surface of a conductor;  $V$  is the electric potential in the field due to charges on the conductors;  $(f, g, h)$  is the electric displacement in the field, circuital by its very nature as a rotation, and  $(a^2 f, b^2 g, c^2 h)$  is the electric force derived from the electric potential  $V$ . The charge on a conductor is the integral of  $(f, g, h)$  over any surface enclosing it, and cannot be altered except by opening up a channel devoid of elasticity, in the medium, between this conductor and some other one; in other words, electric discharge can take place only by rupture of the elastic quality of the ætheral medium.

At the interface between two dielectric media, taken to be crystalline as above, the condition comes out to be that the tangential electric force is continuous. When the circumstances are those of equilibrium, and therefore an electric potential may be introduced, this condition allows discontinuity in the value of the potential in crossing the interface, but demands that the amount of this discontinuity shall be the same all along the interface; these are precisely the circumstances of the observed phenomena of voltaic potential differences. The component, normal to the interface, of the electric displacement is of course always continuous, from the nature of that vector as a flux.

It may present itself as a difficulty in this theory that, as the electric displacement is the rotational displacement of the medium, its surface integral over any sheet should be equal to

the line integral of the linear displacement of the medium round the edge of the sheet; therefore that for a closed sheet surrounding a conductor this integral should be null, which would involve the consequence that the electric charge on a conductor cannot be different from null. This line of argument, however, implies that the linear displacement is a perfectly continuous one, which is concomitant with and required by the electric displacement. The legitimate inference is that the electric displacement in the medium which corresponds to an actual charge cannot be set up without some kind of discontinuity or slip in the linear displacement of the medium; in other words, that a conductor cannot receive an electric charge without rupture of the surrounding medium; nor can it lose a charge once received without a similar rupture. The part of the linear displacement that remains, after this slip or rupture has been deducted from it, is of elastic origin, and must satisfy the equations of equilibrium of the medium.

We can produce in imagination a steady electric current, without introducing the complication of galvanic batteries, in the following manner, and thus examine in detail all that is involved, on the present theory, in the notion of a current. Suppose we have two charged condensers, with one pair of coatings connected by a narrow conducting channel, and the other pair connected by another such channel, as in the annexed diagram, where the dark regions are dielectric

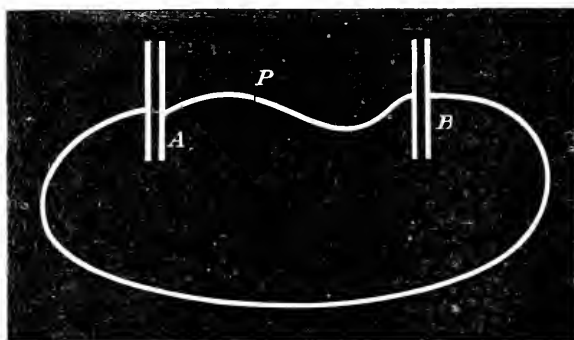

and the white regions conducting. If we steadily move towards each other the two plates of the condenser A, a current will flow round the circuit, in the form of a conduction current in the conductors and a displacement current across the dielectric plates of the condensers. Let us suppose the thicknesses of these dielectric plates to be excessively small, so as to minimise the importance of the displacement part of the current. There is then practically no electric force and therefore no electric displacement in the surrounding dielectric field, except between the plates of the condensers and close to the conducting wires. Consider a closed surface passing between the faces of the condenser A, and intersecting the wire at a place P. A movement of the faces of this condenser alters the electric force between them, and therefore alters the electric displacement across the portion of this closed surface which lies in that part of the field; as we have seen, there is practically no displacement anywhere else in the field except at the conducting wire; therefore to preserve the law of the circuital character of displacement throughout the whole space, we must suppose that this alteration is compensated by a very intense change of displacement at the conducting wire. So long as the movement of the plates continues, as long does this flux of displacement along the wire go on; it constitutes the electric current in the wire. Now, in calculating the magnetic force in the field, which is the velocity of the æthereal medium, from the change of electric displacement, we must include in our integration the effect of this sheet of electric displacement flowing along the surface of the perfectly conducting wires, for exactly the same reason as in the correlative problem in hydrodynamics, of calculating the velocity of the fluid from the distribution of vorticity in it, Helmholtz had to consider a vortex sheet as existing over each surface across which the motion is discontinuous.

(To be continued.)

## SCIENTIFIC SERIALS.

*American Meteorological Journal*, December.—The winds of the Indian Ocean, by W. M. Davis. The facts for this discussion are drawn from the "Atlas of the Indian Ocean," published by the *Deutsche Seewarte*, and the author reproduces two charts (1) for January and February, when the heat equator and the belt of low barometric pressure have advanced to about latitude  $10^{\circ}$  south in the middle of the Indian Ocean, and (2) for July and August, showing the position of the high pressure belt about  $5^{\circ}$  more northward than before, in consequence of the increased velocity of the circumpolar whirl. The most striking feature of this second chart is the extension of the south-east trade wind across the equator, as the south-west or summer monsoon. The author clearly points out the sufficiency of the rotation of the earth to influence the course of the winds, and explains the causes of the monsoons. He shows that it is not only true that continents are unessential to their development, but that they may even destroy their normal conditions.—South American meteorology, by W. H. Pickering. This paper chiefly deals with the climate of Arequipa, Peru; altitude 8,060 feet. The temperature seldom falls below  $40^{\circ}$  or rises above  $75^{\circ}$ . The winds blow with great regularity, except in the rainy season, a sea-breeze prevailing during the day, and a land-breeze for some hours before sunrise. The mean annual rainfall does not exceed four inches, while on the sea-coast rain is a great rarity; the rainy season occupies the first three months of the year; rain in the morning is practically unknown. (This and the previous paper were read before the New England Meteorological Society on October 21 last).—A South American Tornado, by W. G. Davis. This tornado occurred on November 13, 1891, and devastated the village of Arroyo Seco, near Rosario. An illustration, taken from a photograph, shows a number of heavily laden railway carriages which were upset or carried to a distance by the violence of the wind. The cause appears to have been the differences of temperature and humidity in adjacent strata of the atmosphere.—Errors of the psychrometer, by H. A. Hazen. This is a summary of a paper recently read by Mr. W. W. Midgley before the Royal Meteorological Society. The important point is that Prof. Hazen entirely confirms a statement made by Mr. F. Gaster at that meeting, that the temperature of the dry bulb thermometer is not affected by the proximity of the water cup of the wet bulb thermometer, a statement which was contrary to the general opinion of the meeting. We believe that a further confirmation of this fact will be brought forward by Mr. Gaster later on, from recent careful experiments.

*L'Anthropologie*, Tome iv. No. 4, July-August, 1893.—Mons. Maurice Delafosse contributes an interesting paper on a little-known tribe of fair negroes, called the *Agni*, who dwell on the Ivory Coast between the River Tanoué on the east, and the Rio San Pedro on the west. These albinos are neither so tall as some of the tribes of Senegal, nor so powerfully built as the natives of Dahomey. Their height varies from 1.65 m. to 1.80 m.; their body is well proportioned, they are quick and graceful in their movements, and they have sharp, bright eyes of unquestionable beauty. Their colour is in general of a beautiful bronze, more often light than dark. The *Agni* tattoo themselves, but the men are not circumcised. In the same number M. Eugène Mouton describes a *digito-dorsal* movement peculiar to man; and there is a paper by M. D'Acy on ornamented neolithic hammers, tomahawks, and axes.

## SOCIETIES AND ACADEMIES.

## LONDON.

Royal Society, December 14, 1893.—"Note on some Changes in the Blood of the general Circulation consequent upon certain Inflammations of an acute local character," by Dr. C. S. Sherrington, F.R.S.

Linnean Society, December 21, 1893.—Prof. Stewart, President, in the chair. Gen. Sir H. Collett and Mr. H. H. Johnson were admitted, and Messrs. G. E. Greene and A. G. Tansley were elected.—Mr. P. L. Simmonds exhibited a collection of New Zealand mosses found by Mr. G. W. Simmonds while surveying in H.M.S. *Pandora*. Mr. Murray offered some remarks on the nature and value of the collection, which the owner was understood to say would be presented to the Botanical Department of the British Museum.—The Presi-

dent exhibited and described two curious examples of associated ants and plants, namely, *Iridomyrmex aulicus* with *Myrmecodia Beccari* and *Camponotus flavatus* with *P. ulmyrma belli*, the plant being *Acacia Hindii*.—Mr. J. E. Harting exhibited some shells of *Planorbis cornu*, which had been found by the river-side at Weybridge, which from some unascertained cause were curiously bisected. Alluding to the piscivorous habits of the water shrew, *Sorex fodiens*, he suggested that it might be the work of this little animal. Mr. A. D. Michael thought it likely to be the result of frost, the lower half of each shell being preserved by being imbedded in or adherent to the frozen mud. Referring to a MS. letter of Dr. Stephen Hales the author of "Vegetable Statics," and a friend and neighbour of Gilbert White, which was exhibited by Mr. G. Murray, an excellent engraved portrait of him was exhibited by Mr. Harting, who made a few remarks upon his life and work. As this portrait was not to be found amongst the 600 engravings of "scientific worthies" lately presented to the library by the late Lord Arthur Russell, he offered it for the acceptance of the society.—On behalf of Mr. H. N. Ridley, Director of the Gardens and Forests Department, Singapore, the Secretary read a paper dealing with all the *Orchidaceae* hitherto recorded from Borneo. In the discussion which followed, Mr. C. B. Clarke made some remarks on the distribution of these plants in the Indian and Indo-Malay regions, and on the way in which a knowledge of the species had been gradually acquired and extended.—On behalf of Mr. R. Spruce (whose death since the reading of this paper the Society has to deplore), Mr. A. Gepp read a paper on the *Hepaticae* collected by Mr. W. R. Elliott in the islands of St. Vincent and Dominica, and took occasion to describe in some detail the nature and extent of Mr. Spruce's work, which he characterised as a most careful and excellent contribution to botanical science. The paper was accompanied by a series of minute and beautiful drawings.

Royal Microscopical Society, December 20, 1893.—Mr. A. D. Michael, President, in the chair.—Mr. E. M. Nelson exhibited and described a new pattern microscope specially designed for agriculturists.—Mr. Nelson also exhibited a new form of metallic chimney for microscope lamps.—On behalf of Mr. J. W. Lovibond, Mr. Nelson exhibited some new coloured screens for use with the microscope.—Mr. J. W. Gifford read a paper on a new monochromatic light screen, illustrating the subject by means of the lantern.—Mr. T. F. Smith read a paper on the resolution of *Peurostigma angulatum*, illustrated with photomicrographs shown by the lantern.

## PARIS.

Academy of Sciences, January 2.—M. de Lacaze-Duthiers in the chair.—A mechanical problem, by M. J. Bertrand.—On the equation to the derived partials occurring in the theory of the propagation of electricity, by M. Emile Picard. An application of Riemann's method to the problems considered by M. H. Poincaré at the previous meeting.—A chemical study of the nature and causes of the green colouration in oysters, by MM. Ad. Chatin and A. Muntz. The authors trace a connection between the percentages of iron contained in the coloured parts and colourless parts of the oysters and the intensity of the colouration. The branchiæ contain much more iron than the remainder of the body, and are most deeply coloured. The proportion of iron corresponding to a deep green or brown coloration is about 0.07 to 0.08 per cent. of the dried branchiæ. The mud of the oyster beds where colouration occurs contains a large proportion of sulphide of iron. Though it is insoluble in the solvents for chlorophyll and hæmatosin, the green colouring matter resembles those pigments in containing a large proportion of iron.—Graphic determination of position at sea, by MM. Louis Favé and Kollet de l'Isle.—Regulation of the compass by observations of the horizontal force, by M. Caspari.—A new isomeride of cinchonine, by MM. E. Jungfleisch and E. Léger. A base to which the name cinchonine  $\delta$  has been given is obtained from hydrobromocinchonine by boiling with 85 per cent. alcohol and subsequent separation of unaltered base, apocinchonine, and cinchoniline. It forms very long prisms insoluble in water, but soluble in alcohol, benzene, chloroform, and acetone. It melts at  $150^{\circ}$ . For a 1 per cent. solution in 97 per cent. alcohol  $\alpha_D = +125.2'$ . In aqueous solution  $+2HCl$ , we have  $\alpha_D = +176.9'$ , and with  $4HCl$  its rotation becomes  $\alpha_D = +178.2'$ . The base and its salts decompose rapidly in air with formation of brown products less alkaline than the base itself. The salts of cinchonine

$\delta$  are generally very soluble in water, but the hydrochloride, hydrobromide, and basic oxalate form exceptions, and may be easily crystallised.—On the ophites of the Western Pyrenees, by M. P. W. Stuart-Menteth. The author controverts the supposed necessary connection between the Trias and the Ophites of this region, and shows that the presence of the latter is due to the faults of the district. He also shows that the intercalation of the ophites parallel to the surrounding beds is not an invariable case, many instances being now known of penetration of neighbouring strata, and that the granites, porphyries, and ophites of the Pyrenees are not independent of each other, but rather that the latter become important as the former die out.—On the composition of the waters of the Dranse du Chablais and the Rhone at their entrance into the Lake of Geneva, by M. A. Delebecque. The varying quantities of solid residue in the waters of these two rivers are given for various times in the year. The proportions of the substances dissolved vary, calcium sulphate being found more abundantly in winter, and the alkalis in greater proportion in summer. An approximate calculation gives for the amounts of dissolved matter carried annually into the Lake of Geneva by the Rhone and by the whole of its affluents, respectively, the figures 750,000 and 1,150,000 tons.

## NEW SOUTH WALES.

Linnean Society, November 29, 1893.—Prof. David, the President, in the chair.—The following papers were read:—A Thylacine of the earlier Nototherian period in Queensland, by C. W. De Vis. The occurrence of a Thylacine, for which the name *Thylacinus rostralis* was proposed, larger than the existing species, and differing from it in other expressive features, was recorded from the Darling Downs deposits. A number of fragmentary portions of the cranium have been for some time in the Queensland Museum; but the most valuable evidence has been furnished by a recent acquisition, in the shape of the major part of the left side of an adult skull, with all the teeth except the second upper premolar in place, together with the first four cervical vertebrae.—A second note on the *Carnivores*, with descriptions of new species, by T. G. Sloane. Nine new species were described, and the opportunity of reviewing the classification of the group has been taken, synoptical tables of the more important genera being furnished.—Additions to and emendations in the reference list of the land and freshwater mollusca of New Zealand, by Henry Suter. In the "Reference List" published in last year's Proceedings, a further account of several new species was promised. Descriptions, which will be fully illustrated, of these novelties have now redeemed this promise. Critical notes on various other New Zealand land mollusca accompany the descriptions. The existence in New Zealand of an undetermined species of *Gundlachia*, the young of which were formerly mistaken for an *Ancylus*, was also announced.—On the Australasian *Gundlachia*, by C. Hedley. Two Australian species, *G. Petterdi*, Johnston, and *G. Beddomei*, Petterd, were figured and described, and the dentition of the former was also elaborated. A summary was given of the whole genus, with especial reference to its discontinuous distribution, and probable path of migration.—Description of *Cecum amputatum*, an undescribed mollusc from Port Jackson, by C. Hedley. The newest addition to the Port Jackson molluscan fauna, figured and described by the author, stands nearest to *C. auriculatum*, de Folin, from the Mediterranean. It is the first of its genus observed in extratropical Australia.—Notes on the red-crowned parakeet (*Cyanorhamphus Cooki*) of Norfolk Island, by A. J. North. Having recently examined two specimens of this parakeet forwarded by Dr. P. H. Metcalfe, of Norfolk Island, the author has found it to be specifically distinct from *C. novae-zealandiae*, as maintained by Count Salvadori, in whose views as to the incorrectness of the habitat assigned to *C. Cooki* by Gray, and the necessity of regarding *C. Rayneri* as a synonym of *C. Cooki* he therefore concurs.—Fourth contribution to a knowledge of the geographical distribution of Australian batrachia, with description of a new cystignathoid frog, by J. J. Fletcher. The collections recorded are mainly from the Lower Clarence and the Northern Tableland of N.S.W.; and a new species of *Crinia*—with vomerine teeth, the tympanum indistinct, the throat very dark, the belly maculate and granulate, a light vertebral line—from Jervis Bay, proposed to be called *C. Haswelli*, was described.—Description of a new Australian *Acacia*, by J. H. Maiden and R. T. Baker. A well-defined and somewhat remarkable species from Murrumbidgee, near the Goulburn River, N.S.W., was described.

It bears some superficial resemblance to *A. decurrens*, var. *normalis*, but the length of the leaflets, the fewness of the glands, the pinnae, and the flowers in the heads (six or eight only), are the principal distinctive differences upon which the specific rank is based. This species commemorates Baron Ferd. von Mueller, the eminent botanist, to whom we are indebted for the classical "Iconography of Australian Acacias."

## NETHERLANDS.

Zoological Society, November 25, 1893.—M. Hubrecht in the chair.—M. Hubrecht contributed a paper on the development of the Shrew (*Sorex vulgaris*), and especially on its placentation. The placenta is an embryonal organ; the part which the tissue of the mother plays in its formation is considerably smaller than has been supposed.—M. Seydel exhibited models of embryonal skulls of Anguis and Lacerta, made of wax after the method of Born.—M. Bolsius dealt with the anatomy especially of the generative organs of *Branchiobdella parasita*.—M. Vosmaer treated on the so-called membrane of Sollas, in sponges of the genus Sycon.—M. Hoek described a hermaphroditical ray (*Raja clavata*). A specimen of a length of 44 centimetres (without the tail) was in possession of a single pterygopodium (the left one) only. On dissecting it was found to be furnished with a complete set of female reproductive organs (ovaries, oviducts, oviductal glands, uteri), and at the left side with a well-developed testis containing mature spermatozoa.

## BOOKS, PAMPHLET, and SERIALS RECEIVED.

BOOKS.—Electromagnetic Theory: O. Heaviside, Vol. i. (*Electrician Publishing Company*).—Eau Sous Pression: F. Bloch (Paris, Gauthier-Villars).—Anuario publicado pelo Observatorio do Rio de Janeiro, 1893 (Rio de Janeiro).—The Crinoidae of Gotland, Part 1.—The *Crinoidae Inadivato*: F. A. Bather (Stockholm, Norstedt).—Index-Catalogue of the Library of the Surgeon-General's Office, U.S. Army, Vol. xiv. (Washington).—Results of Rain, River, and Evaporation Observations made in N.S.W. during 1892: H. C. Russell (Sydney).

PAMPHLET.—Report of the Meteorological Council to the Royal Society for the year ending March 31, 1893 (Eyre and Spottiswoode).

SERIALS.—Geographical Journal, January (Stanford).—Natural Science, January (Macmillan).—Handbuch der Palaeontologie Erste Abthg. iv. Band, 3. Liefg. (Williams and Norgate).—Observatory, January (Taylor and Francis).—Bulletin of the New York Mathematical Society, December (New York, Macmillan).—Revue Générale des Sciences, No. 24 (Paris).—Annals of Scottish Natural History, January (Edinburgh, Douglas).—American Journal of Science, January (New Haven).—Journal of the Royal Statistical Society, December (Stanford).—The Physical Society of London, Proceedings, Vol. xii. Part 3 (Taylor and Francis).—Contributions from the Botanical Laboratory of the University of Pennsylvania, Vol. i. No. 2 (Philadelphia).—Medical Magazine, January (Southwood).

## CONTENTS.

|                                                                                                                                      | PAGE |
|--------------------------------------------------------------------------------------------------------------------------------------|------|
| The New Index of Plant-Names . . . . .                                                                                               | 241  |
| Astronomy for the Public. By R. A. Gregory . . . . .                                                                                 | 243  |
| Our Book Shelf:—                                                                                                                     |      |
| Coleman: "Practical Agricultural Chemistry for<br>Elementary Students."—C. J. . . . .                                                | 244  |
| Walther: "Bionomie des Meeres" . . . . .                                                                                             | 244  |
| Letters to the Editor:—                                                                                                              |      |
| Correlation of Solar and Magnetic Phenomena.—Dr.<br>M. A. Veeder: William Ellis, F.R.S. . . . .                                      | 245  |
| The Mendip Earthquake of December 30-31, 1893.—<br>Prof. F. J. Allen . . . . .                                                       | 245  |
| Quaternionic Innovations.—Oliver Heaviside, F.R.S. . . . .                                                                           | 246  |
| The Second Law of Thermodynamics.—S. H.<br>Burbury, F.R.S. . . . .                                                                   | 246  |
| The Fauna of the Victoria Regia Tank in the Botanical<br>Gardens.—Frank E. Beddard, F.R.S. . . . .                                   | 247  |
| Rudimentary (Vestigial) Organs.—W. E. H.; C.<br>Mostyn . . . . .                                                                     | 247  |
| Fresh Light on the Ainu. ( <i>With Illustrations.</i> ) By<br>H. R. M. . . . .                                                       | 248  |
| The Purification of Sewage by Bacteria . . . . .                                                                                     | 249  |
| Arthur Milnes Marshall . . . . .                                                                                                     | 250  |
| Notes . . . . .                                                                                                                      | 251  |
| Our Astronomical Column.—                                                                                                            |      |
| Harvard College Observatory Report . . . . .                                                                                         | 256  |
| The "Gegenschein" . . . . .                                                                                                          | 256  |
| Geographical Notes . . . . .                                                                                                         | 256  |
| The Rise of the Mammalia in North America. II.<br>By Prof. H. F. Osborn . . . . .                                                    | 257  |
| A Dynamical Theory of the Electric and Lumini-<br>ferous Medium. I. ( <i>With Diagram.</i> ) By Dr. Joseph<br>Larmor, F.R.S. . . . . | 260  |
| Scientific Serials . . . . .                                                                                                         | 263  |
| Societies and Academies . . . . .                                                                                                    | 263  |
| Books, Pamphlet, and Serials Received . . . . .                                                                                      | 264  |

THURSDAY, JANUARY 18, 1894.

## HEINRICH HERTZ.

THE last day of 1893 witnessed the tragic death of Prof. Milnes Marshall on Scawfell: on the New Year's Day Prof. Heinrich R. Hertz passed away, and his death will be even more severely felt in many circles and more widely mourned. For some time he had not been in good health. Last winter a severe illness prevented him from discharging his professional duties: for some weeks he was confined to his bed, and fears were entertained that he might not recover. During the summer-semester he got better and was again able to lecture; a casual observer would scarcely have thought that there was anything wrong with him. He was in excellent spirits, and his friends hoped that the vacation would complete his restoration to health and strength. But with the returning winter there came a relapse. A chronic, and painful, disease of the nose spread to the neighbouring Highmore's cavity and gradually led to blood-poisoning. He was conscious to the last, and must have been aware that recovery was hopeless; but he bore his sufferings with the greatest patience and fortitude.

Hertz is best known through his magnificent series of researches on electric waves. He was led, somewhat indirectly, to these by a problem proposed in 1879 by the Berlin Academy of Sciences, viz. to establish experimentally a relation between electromagnetic forces and the dielectric polarisation of insulators. At this time Hertz was assistant in the Berlin Physical Institute, and his attention was directed to the problem by Prof. von Helmholtz. The oscillations of Leyden jars and of open induction-coils first attracted his attention; but he reluctantly came to the conclusion that any decided effect could scarcely be hoped for. Yet he kept the matter in mind; and certain experiments made a few years later—when he had become Professor of Physics at the Karlsruhe Polytechnic—led him to the production and examination of electric oscillations of very short period (about a hundred-millionth of a second). The paper "On very Rapid Electric Oscillations," which was published in 1887, was the first of a splendid series of researches which appeared in *Wiedemann's Annalen* between the years 1887 and 1890, and in which he showed, with ample experimental proof and illustration, that electromagnetic actions are propagated with finite velocity through space. These twelve epoch-making papers were afterwards republished—with an introductory chapter of singular interest and value, and a reprint of some observations on electric discharges made by von Bezold in 1870—under the title *Untersuchungen über die Ausbreitung der elektrischen Kraft*. (An English translation of this book, with a preface by Lord Kelvin, has just been published.)

As early as 1883, Prof. G. F. Fitzgerald read a paper at the Southport meeting of the British Association, "On the Energy Lost by Radiation from Alternating Currents," and at the same meeting pointed out that electromagnetic waves of as little as two metres wave-length, or even less, could be obtained by discharging an accumulator through a small resistance. In a paper on "The Theory of Lightning-Conductors," published in the *Phil. Mag.* in August, 1888, Dr. O. J. Lodge suggested that waves of 20 or 30 c.m. length from a small condenser might be concentrated upon some sensitive detector; that shorter waves still might be obtained by discarding the condenser and simply producing oscillations in a sphere or cylinder by giving it a succession of sparks; and that light-waves in all probability were only smaller editions of these. It was reserved for Hertz to discover, and apply with marvellous ingenuity, the necessary "detector," a

resonating circuit with an air-gap, the resistance of which is broken down by well-timed impulses so that visible sparks are produced. It was only after this paper was written that Dr. Lodge read how Hertz had succeeded in detecting electromagnetic waves in free space, in investigating their reflection, and measuring their velocity; and at the end of a postscript to the same paper announcing the news there occurs the sentence: "The whole subject of electrical radiation seems working itself out splendidly." How amply this statement has been substantiated we now know.<sup>1</sup>

When his earlier papers on electric oscillations were written, Hertz was not aware of von Bezold's observations, nor that the subject was engaging the attention of physicists in Great Britain. He readily and gracefully acknowledged the value of the work done by others; and it is equally pleasant to recollect that, when he had attained the goal towards which others were striving, Profs. Oliver Lodge and Fitzgerald were foremost in announcing his success and in preparing the English-speaking world to appreciate the importance of the discoveries which he had made and might yet be expected to make. None, we may be sure, more deeply mourn the death of this brilliant investigator—in his thirty-seventh year—than those who have travelled along the same path, and can fully appreciate the value of his work.

It would perhaps be an exaggeration to say that the news of Hertz's discoveries (with his consequent appointment as successor to Clausius in the chair of Physics at Bonn) reached Germany by way of England. But at the time when these researches were undertaken Maxwell's theory does not appear to have been very widely known in Germany, and it is certain that its importance was not generally recognised. It seems that Hertz himself did not at first appreciate how rich and suggestive it was. But when he showed how worthily he could follow in the footsteps of Faraday and Maxwell, his work received instant and ample recognition in England. In December, 1890, he came over to England to receive the Rumford medal, which was conferred upon him by the Royal Society for his researches on electromagnetic radiation. He was delighted with the warm welcome which he received, and often spoke of it with obvious pleasure.

It might be thought that a world-wide reputation so rapidly attained would produce in a young man some feeling of elation and pride, and in his colleagues somewhat of envy. But Hertz's modesty was proof against the one, and his unvarying courtesy and ready recognition of the merits of his co-workers made the other well-nigh impossible. He was a most lovable man, and was never happier than in giving pleasure to others. He was always ready to show hospitality to scientific men from England and America who came to Bonn. Even under the restraint of a foreign tongue (he spoke and wrote English with considerable fluency) his conversation was charming. When entertaining friends he kept the learned professor well in the background, and his one desire was to make every guest feel at ease and happy. Many of his students will remember with pleasure certain trips to the Siebengeberge, and delightful evenings spent in his house in the Quantius-Strasse.

Absolutely devoid of any desire to pose before the public, Hertz yet showed on occasion that he could ably act as a popular exponent of experimental research. After the publication of his fascinating researches on electric radiation—its rectilinear propagation, reflection, refraction, and polarisation—he was invited to address the *Naturforscherversammlung* (which corresponds to our British Association) at Heidelberg, in 1889. He

<sup>1</sup> It may not be out of place to observe here that Hertz appears to have made a mistake in saying that Poincaré first pointed out the error of calculation in his important paper "On the Finite Velocity of Propagation of Electromagnetic Actions." (English edition, pp. 9, 15, 270.) It seems clear that Lodge (*Phil. Mag.* July, 1886) first drew attention to it.

chose as his subject "The Relations between Light and Electricity." The lecture, afterwards published by Strauss, of Bonn, attracted great attention in Germany, and rapidly passed through half a dozen editions; it deserves to be better known in England. To students of science it will be a pleasure—not unmixed with sadness—to know that shortly before his untimely death he completed the manuscript of a new work on "The Principles of Mechanics." This book is already being prepared for publication, and those who have learned to value the insight and originality of the gifted author will eagerly watch for its appearance. D. E. J.

PROF. DR. RUDOLF WOLF.

IN Prof. Dr. Rudolf Wolf astronomical science loses one of her most devoted servants, and his death will be deplored not only by his countrymen and the observatory which he has directed since its foundation, but by astronomers all over the civilised world.

The services which he has rendered to astronomical science have not been restricted to one branch, although his name is generally spoken of with reference to sunspots.

Born on July 7, 1816, at Fällanden, near Zurich, he attended in his youth the higher schools in the last-mentioned city, where he made the acquaintance of the astronomer Horner, and began his first studies in mathematics and astronomy. He then went to the Vienna University in order to study astronomy under Littrow, and later to Berlin, at which place and time were Encke and Poggenдорff. The year 1838 saw him in his home again, and this time his opportunities for astronomical studies were few and far between, as he had little time to spare, owing to his having accepted the post of a teacher in mathematics and physics at the town "Realschule" in Berne. In the year 1844 he commenced lecturing at the university, and in 1852 he obtained his Doctor's degree from the Berne Faculty, the same year becoming a member of that body itself by being appointed an *Ausserordentliche* Professor. About this time Wolf busied himself with a series of fine pieces of mathematical work, some of which were published singly, and others in various "Fachblättern," and in this year (1852) he published his "Taschenbuch der Mathematik, Physik, Geodäsie und Astronomie," a book which, owing to its clearness of exposition, passed quickly through a series of editions. One of the last pieces of work at which he was employed before he was overtaken by his illness was the sixth edition of this small book. The year 1847 was a very important one in the life of Prof. Rudolf Wolf, for it was at this period that he was appointed to the directorship of the small observatory of Berne. It was there that he began his well-known series of observations on sunspots, which he carried on without intermission to the end of his life, and which in connection with previous observations led to such important results. Owing to his memorable discovery of the relation between sunspots and earth magnetism his name first became better known, and it was more especially on this account that he received his promotion and a professorship of mathematics at the Berne University. In the year 1855 we find him returning as Professor of Astronomy to the newly-founded Swiss Polytechnikum, and at the same time to the university in his "Vaterstadt," where at a later date (1864) he received the appointment as director of the newly-built observatory in which he worked with great zeal to the end of his life.

The chief work which Prof. Wolf set himself to do was to obtain a continuous record of the spots on the solar surface; this led him later to examine older observations, and finally to compare their periods with those obtained from magnetic observations. As an astronomical observer Prof. Wolf was most diligent. Besides busy-

ing himself with observations of many different kinds, he made a point of regularly watching the sun's surface. For fifty years, it is said, he did not allow a single day, in which the sun was at all visible, to pass without observing its surface with one of the observatory instruments, or with a small pocket telescope he carried about with him for that purpose. The importance of Prof. Wolf's work will be gathered from the following brief historical sketch.

In 1851 Lamont, the Scotch director of the Munich Observatory, in reviewing the magnetic observations made at Göttingen and Munich from 1835-50, perceived that they gave indications of a period of 10½ years. Sabine, in the following winter, ignorant of Lamont's conclusion, undertook a similar examination with very different data, and found that there was a maximum of violence and frequency about every 10 years; he it was, also, who first noted the coincidence between this result and Schwabe's sunspot period. The memoir containing this remarkable communication was presented to the Royal Society March 18, and read May 6, 1852; but on the 31st July following, Prof. Rudolf Wolf at Berne, and on the 18th August, Alfred Gautier at Sion, both announced similar conclusions, arrived at quite separately and independently. Prof. Wolf's work began then in real earnest, and he corrected Schwabe's decennial period to one a little larger than eleven (11.11), and pointed out the better agreement in the ebb and flow of magnetic change than Lamont's 10½ year cycles. So minute and exact were his inquiries that by 1859 he found that very considerable fluctuations on either side of the mean period, which he had previously deduced, were noticeable; for might not two maxima rise to sixteen and a half years, or sink below seven and a half years? Prof. Wolf pointed out later (1861) that the shortest periods brought the most acute crises, and *vice versa*; he it was, also, who suggested the idea of a longer sunspot period (55½ years).

Among other branches of astronomy to which Prof. Wolf turned his attention may be mentioned that of variable stars. It was in 1852 that he pointed out the striking resemblance between sunspot curves (representing frequency) and curves representing the changing luminous intensity of many variable stars. Auroræ, too, received Prof. Wolf's attention, and it was in the same year that, as he was examining Vogel's collection of Zürich chronicles for evidence to connect the weather with sunspots, he was led to associate luminous manifestations with solar disturbances. He also interested himself with regard to the announcement of the discovery of Vulcan, and collected all information of recorded appearances (?) of what were thought to be intra-Mercurian planets.

From his youth up, Prof. Wolf had a great liking for historical study, and was as familiar with the history of his science as he was with the special branch which he made his own. For several years he collected and brought together a great amount of "quellenmaterial," which was published in the form of his "Geschichte der Astronomie." Perhaps his "Handbuch der Astronomie" may be said to be his best work, for there his thorough knowledge of his science and his cleverness had complete scope. The matter in this book is treated with both scientific accuracy and literary ability, and is a wonderful instance of his still youthful capacity for work.

Towards the end of November last the first sign of illness showed itself, and during the first few days of December quickly developed, resulting in his death on December 6, at the age of 77.

Wholly devoted to the science which he loved, and a large contributor to astronomical knowledge, his name will be handed down to posterity. When the principles played with to-day are thoroughly perfected at some future date, and we can produce perfect pictures of all solar phenomena on a single plate, our future astronomers will

still look back on the work accomplished by Prof. Rudolf Wolf as a germ from which their work had developed, and as a monument of pains and industry. In his death, besides a true friend, we lose a thorough devotee to science, and we can ourselves mourn with his friends who say, "Und heute stehen seine Freunde aus allen Gauen des Vaterlandes trauernd am offenen Grabe, der Erde die sterbliche Hülle eines Mannes übergebend dessen geistige Grösse, persönliche Bescheidenheit und herzlichste, oft aufopfernde Liebenswürdigkeit allen die ihn gekannt haben unvergesslich bleiben wird" W. J. L.

CLOUD PHOTOGRAPHY.

*L*A NATURE recently printed an article by M. A. Angot on the methods he has been employing in order to obtain the excellent photographs of clouds exhibited at the Paris Physical Society at the beginning of last year. The following is a free translation of the article:—

It is well known that ordinary photographic plates are most sensitive to blue and violet rays: hence the blue background of the sky acts, in general, nearly as much upon the plates as the white parts of clouds, which are thus rendered almost or entirely indistinguishable upon the photograph. It is possible, however, easily to obtain views of an interesting effect when, on a background of blue sky, large clouds pass before the sun. The edges of the clouds are then lit up to such an extent that they make much stronger impressions upon the sensitive plate than the sky itself; the remainder of the cloud is, on the contrary, dark, grey or black, and does not come out as well as the sky. To obtain an accurate picture under these conditions it is necessary to develop with great care: or better, to use a dilute pyro developer—a few drops of bromide of potassium solution and very little pyro to begin with; the development is then slowly carried on with the addition of carbonate of soda, and pyro is only added again towards the end if the plate lacks clearness.

This method ceases to give good results when it is applied to ordinary clouds, and becomes altogether useless for cirrus clouds. But these are precisely the clouds the study of which is most interesting; they are composed not of water vapour, but of ice-needles; and their forms and movements are closely connected with changes of weather. Cirri are the most difficult to photograph because, being farther from us than other kinds, they are less brilliant; and further, when they are seen, the sky is very frequently pale blue in colour, or covered with a milky veil, which diminishes the contrast.

Numerous plans have been proposed to photograph cirrus clouds. The first consists in photographing from the summits of high mountains, but that method is not within the reach of everybody. At such places the sky is, in general, much darker, and the clouds are better seen upon the background, so that excellent photographic images can be obtained without special devices. Another method has been proposed by Prof. Riggenbach, and appears to have some advantages. It consists in photographing the sky, using a diaphragm so small and giving an exposure so short that only a trace of the cloud-image

appears after development. The plate is then intensified, and the image brought out by means of bichloride of mercury and sodium sulpho antimoniate. This method, however, has little to commend it. In the first place, intensification is always inconvenient and destroys details, and further, the sodium salt very rapidly deteriorates, so there is always a risk of the plates being spoiled by becoming a very intense yellow colour, or being covered with a metallic deposit.

Prof. Riggenbach has suggested another and a better method, which is found to give excellent results. The method is based upon the fact that the blue light of the sky is partially polarised, whilst the light of clouds does not possess the same property. If, therefore, a convenient analyser (a Nicol's prism or black glass inclined at 55°) is placed in front of the lens of the camera, only a portion of skylight is obtained, while the light of the



FIG. 1.—Cirrus Cloud preceding a Storm (March 31, 1892).

clouds remains unaltered, and the increased contrast renders it an easy matter to obtain a good picture. But at the same time, this method possesses inconveniences. The proportion of polarised light is far from being the same in all parts of the sky; hence it is not possible to photograph clouds in any direction. Moreover, many photographers object to the complications which are

involved in the introduction of an analyser in front of the lens of the camera.

There is still another method, unquestionably the most simple one, and the one which, at the same time, gives the best results: it is the employment of coloured screens. In front of the lens of the camera is placed a screen which transmits yellow and green rays, but is opaque to blue and violet rays. The light of clouds is rich in yellow and green rays; hence a large proportion of it is able to traverse the screen, and act upon the photographic plate, while, on the other hand, the blue background of the sky emits very little yellow light; in fact, the proportion of rays of this refrangibility decreases as the blue colour increases in depth, so its action upon the sensitive film is considerably diminished or altogether obviated. The only inconvenience of this method is that yellow and green rays have very little

now to have almost been abandoned. But this difficulty has been practically overcome by the production of the orthochromatic or isochromatic plates of commerce, which are sensitive to yellow [and green light.

M. Angot finds that the best brands of plates for use in cloud photography are the Lumière orthochromatic and Edwards' isochromatic. Other brands have been tried, but none gave better results than these. As to the yellow screen, the best is obtained by placing a cell having parallel faces, about five or seven millimetres apart, in front of the lens, and filling it with an almost saturated solution of bichromate of potash to which a few drops of hydrochloric or sulphuric acid have been added. A mixture of saturated solutions of bichromate of potash and copper sulphate in the proportion of three of the former to one of the latter may also be employed. In either case the cell is hermetically sealed, and it can easily be fixed in front of the lens or behind it in the bellows of the camera.

Evidently it would be simplest to use a screen of coloured glass, and, as a matter of fact, certain glasses give as good results as the cell containing one of the above-mentioned solutions. But most yellow glasses are quite inadequate for the purpose. It is to be hoped that coloured-glass manufacturers will soon make a glass which will transmit exactly the same rays as the solutions. It will be a good thing to have a series of glasses of graduated tints; the clearest to serve for very bright white clouds standing out boldly upon a fine blue sky, while the darkest could be used for faint clouds when the blue colour of the sky is not so pronounced. The time of exposure must, of course, be increased as the glass used is increased in tint.

The two illustrations here given are reduced copies of two of M. Angot's negatives. The originals are eighteen centimetres long by thirteen wide.

Fig. 1 was obtained on March 31, 1892; it shows some patches of cumulus cloud, and an extremely remarkable sheaf of cirrus which preceded a violent storm by two hours. The second illustration (Fig. 2) shows a form intermediate between cirrus, properly so called, and cirro-cumulus, observed on February 19, 1893. Both these pictures were obtained by means of Lumière orthochromatic plates, with a cell containing a solution of potassium bichromate and copper sulphate, and a wide angle lens having a focal length of 0.160 metres. The aperture was cut down by means of a diaphragm of about one-twentieth the focal length, and the time of exposure for Fig. 1 was three-quarters of a second, and one-half a second for Fig. 2. The usual developers may be employed, but pyrogallic acid was used by M. Angot on account of the latitude of exposure it permits.

As photography is being widely used in the future to increase our knowledge of clouds, it is recommended that the date and hour of exposure be written upon each picture. M. Angot's photographs are a sufficient testimony of the excellence of his method of work, and their multiplication in different parts of the world would considerably extend our knowledge of cirrus clouds, and very probably prove of use in forecasting weather.



FIG. 1.—Cirrus and Cirro-cumulus (February 19, 1893)

action upon an ordinary photographic plate. Under these circumstances it would be necessary to give a very long exposure, which is impossible in cloud photography on account of the movements of the objects and the rapid changes of form. It is probably for this reason that coloured screens, which were adopted in the earliest stages of cloud photography, appear



LETTERS TO THE EDITOR.

[The Editor does not hold himself responsible for opinions expressed by his correspondents. Neither can he undertake to return, or to correspond with the writers of, rejected manuscripts intended for this or any other part of NATURE. No notice is taken of anonymous communications.]

The Directorship of the British Institute of Preventive Medicine.

THE position of Director of the above-named Institute is one which corresponds to that of M. Pasteur in Paris, and to that of Dr. R. Koch in Berlin, and is therefore one of great importance.

The Institute is now about to be built, and it is of the utmost consequence that the first holder of the office in question should be very carefully chosen, as he will necessarily have a great deal to do with the arrangement of the plans of the laboratory, and the organisation of the work to be done in it. The Institute is intended to do in England the work done in France by the Institut Pasteur, and in Germany by the Berlin Hygienisches Institut; and the Council have already in their hands sufficient money to begin to build and carry on a laboratory on a scale comparable to that of the great continental ones referred to.

The Directorship is a scientific post, and there are certain customs regarding the election to such offices which it is, in my opinion, extremely unwise to neglect.

It is customary, for example, to advertise that such a post is vacant, and to examine the qualifications of the candidates who apply for the office. These and other customary modes of procedure having without sufficient reason been disregarded at a recent meeting of the Council of the Institute, I feel constrained to make a public protest.

Since the Institute was first initiated at my suggestion on December 5, 1889, the meetings of the executive committee and Council have been very ill-attended, a fact for which I believe the office-bearers have been mainly responsible; the result, in any case, being that the officers of the Council have gradually come to control the decisions of the meetings to a much greater extent than I have experienced in any council, syndicate, or board of which I have been a member.

While I was one of the hon. secretaries of the council, I noted what seemed to me grave irregularities in the mode of conducting the business of the council, against some of which I protested in writing to Mr. Ernest Hart (who had occupied the chair at the previous meeting), and verbally to Sir Joseph Lister, who then, as now, was chairman of the Council. Mr. Ernest Hart disclaimed all knowledge of or sympathy with the measures to which I objected, but our chairman not seeing the full point of my protests, I emphasised my strong disapproval of the measures in question by resigning my post of Hon. Secretary.

On Monday, the 11th ult., I received a notice, signed by the Hon. Secretary (Dr. A. Ruffer), calling a meeting of the Council of the Institute for December 13, with the agenda (which I append) containing, amongst formal business, the statement that the "report of committee appointed at last meeting" would be considered.

At the Council meeting of December 13, I saw for the first time a copy of the report in question. This, with the instructions to the committee which supplied the report, I append. The question was at once asked why a report concerning a subject of this importance, had not been, as is customary, distributed to members of the Council before the meeting, seeing that there are among the Council gentlemen who are directors of laboratories, whose aid in considering so important a subject must be of the utmost value, but which could not be given without time to consider the hastily drawn up and imperfect report submitted to the meeting?

To this it was replied from the Chair that the matter was considered so pressing by the office-bearers, that there had been no time to send round copies. As the Institute has been four years reaching its present position, during the whole of which time the office-bearers knew that a Director would have to be appointed, this reply did not appear to me to carry any weight with it. To the question why, assuming for the moment that the adoption of some such report were pressing, its nature had not been clearly indicated in the agenda, in order that those members of Council whose opinion would be of special value in discussing it, might try to arrange, even at some sacrifice, to be present. To this no satisfactory answer was given. As less

than a third of the members of the Council were present at the meeting, I, and others, strongly urged that the consideration of the report be adjourned for, say, a week, in order that it might be distributed in the usual way. This being opposed by the two office-bearers present, viz. the Chairman and the Treasurer (Sir H. Roscoe), was not agreed to, their opinion in such a matter necessarily carrying great weight.

If the appended report be examined, it will be seen that the instructions to the committee give no authority to nominate a Director. This view was upheld by one of the members of Council present, who had been appointed member of the committee, but had been unable to be present at its meetings (although that is obviously not the view of the members of committee who signed the report). The Council decided, however, to leave out the name of the Interim Director from Clause 1 of their report. The report so modified was then considered, and although I and others expressed strong disapproval of its being pressed forward without due consideration by the Council, it was, with a few verbal alterations, adopted.

It was then proposed to add to it a tenth clause nominating the Hon. Secretary to the Directorship. This was objected, however, that such a nomination could not be appended in this way to the report, and this objection was upheld by the Council.

The motion was still, however, pressed forward by the signers of the report, which was, as I take it, hopelessly irregular, and which was strongly objected to. It was urged that notice of such a motion should have appeared on the agenda; that the committee had not apparently made any inquiries as to possible candidates, or their qualifications for so important a post; that they had no authority to nominate any candidate, and were therefore acting *ultra vires* in doing so; that in proposing to elect one of themselves in this irregular manner the two office-bearers present were exposing their action to serious misconstruction. In spite of these and other protests, which I need not detail, the motion was pressed, and was eventually formally proposed, seconded, and carried.

I will not seek to state the arguments advanced by our Chairman and Treasurer for their action as office-bearers, seeing that these can be best stated by themselves; nor will I do more in the meantime than mention that on leaving the Council meeting I at once protested in writing to the Chairman, and have since done my utmost to get the election re-terminated.

It is unnecessary for me to make more than one or two comments on the above-stated facts. The legality of the election in question may reasonably be doubted, as members of Council had not sufficient notice that it was to take place. There can, however, be no doubt as to the harm to science in the election to a scientific post being carried out in this manner. I am also of opinion that, independently of the manner of conducting it, the election itself was a grave mistake in so far as the interests of the Institute are concerned.

CHARLES S. ROY.

Pathological Laboratory, Cambridge, January 8.

[APPENDIX.]

Agenda of Meeting of Decem. 13, 1893.

1. Completion of purchase of site.
2. Appointment of building committee.
3. Sealing of deed with college of State medicine.
4. Report of committee appointed at the last meeting.
5. Memorandum to be addressed to the trustees of the Berridge bequest.

REPORT OF THE COMMITTEE APPOINTED AT THE LAST MEETING OF THE COUNCIL.

The committee appointed to consider the appointment of the director, his duties and salary, and his relations to the council and staff of the institute, met on December 12, 1893.—Present: Sir Henry Roscoe, Professor Victor Horsley, and Sir Joseph Lister.

They beg to report as follows:

1. That Dr. Ruffer be appointed interim director of the institute for a period of three years, at a salary of £200 a year.
2. That Dr. McFadyen receive the title of lecturer on bacteriology and that he be entrusted with the systematic instruction in that subject.
3. That the director and the lecturer on bacteriology should

have each his own laboratory and rooms where research may be conducted under his supervision.

4. That the scheme of any course of lectures delivered at the institute, whether by the director, the lecturer on bacteriology, or anyone else whom the council may appoint, be submitted to the council for their approval.

5. That the director should exercise a general supervision over the conduct of the institute, and be responsible for it to the council.

6. That all matters of expenditure at the institute should pass through the hands of the director, and that he should be entrusted with the appointment and dismissal of the servants of the institute.

7. That anyone desiring instruction at the institute, or wishing to engage in original research there, should make application to the director, who should have power to admit him.

8. That the director should present to the council a quarterly statement of the work carried on at the institute, and furnish a written annual report.

9. That leave of absence be granted by the council to the director and the lecturer on bacteriology, on the understanding that in each case an efficient substitute, approved by the council, be provided.

(Signed) H. E. ROSCOE.  
VICTOR HORSLEY.  
J. LISTER.

#### Electromotive Force from the Light of the Stars.

ON the invitation of Mr. W. E. Wilson, I came here a few days ago for the purpose of trying whether it was possible or not to obtain measurable electromotive forces from the light of the planets and of the fixed stars. The sensitive cells which we employed are seleno-aluminium-cyanthol cells, and (excepting the liquid) are the same as the seleno-aluminium-acetone cells which I described in the *Phil. Mag.* for March, 1892.

Last night was the only one on which observations were possible; and, owing to the state of the weather, it does not seem likely that, in the time at our disposal for joint-work, any more photo-electric measures can be made. The result of last night's work is to prove that the electromotive force of starlight is easily measurable.

The electrometer which we employed is Clifton's form of the quadrant electrometer of Lord Kelvin. It was placed in a room beneath that in which the telescope is fixed, and was thus kept quite dry and free from draughts. The telescope is Mr. Wilson's two-foot reflector; and the photo-electric cell, attached to a cell-carrier, was connected with the telescope in place of the eye-piece, and could be moved into or out of the image of the star at pleasure. The poles of the cell were connected with those of the electrometer by naked but well insulated fine wires led through a hole in the floor of the observatory. The area of the sensitive plate in the cell is about 3 square millimetres.

An E.M.F. of 1 volt was represented by 460 divisions of the scale, and the light of Venus gave about 40 divisions. Only about one quarter of the disc of the planet is at present illuminated, so that the E.M.F. of the whole light of the planet would have been represented by 80 divisions. [The square of the E.M.F. is proportional to the incident energy.] Thus the light of Venus concentrated by this telescope is represented by about 17 volts.

With Jupiter about 14 divisions on the scale were obtained; but no conclusion can be drawn from this, because the image of Jupiter covered much more than the area of the sensitive plate. Hence the energy of his light corresponds to a much larger number than that given.

From the light of Sirius we obtained an E.M.F. of about 0.02 volts (a little over 9 divisions on the scale).

An attempt on Aldebaran was not productive of any certain result, and was interfered with by an accident to the cell.

However, we consider that we have succeeded in our object, and we hope that, with a slightly improved cell-carrier and a much more sensitive electrometer, results will be obtained from the lights of a large number of fixed stars.

I would observe, in conclusion, that the relative values of the lights of Venus and of Sirius as given in the "Encyc. Brit." ("Photometry"), are most probably erroneous. It seems to me that the light of Venus very much exceeds the value there given.

GEORGE M. MINCHIN.

Daramona House, Westmeath, January 8.

#### THE THYROID GLAND.

(WITH APOLOGIES TO MRS. HEMANS).

"WE hear thee speak of the thyroid gland,  
But what thou say'st we don't understand;  
Professor, where does that acinus dwell?  
We hashed our dissection, and can't quite tell.  
Is it where the macula lutea flows,  
And the suprachoroidal tissue grows?"  
—"Not there, not there, my class!"

"Is it far away where the bronchi part,  
And the pneumogastric controls the heart?  
Where endothelium endocardium lines,  
And a subpericardial nerve intertwines?  
Where the subpleural plexus of lymphatics expand?—  
Is it there, Professor, that gruesome gland?"  
—"Not there, not there, my class!"

"I have not seen it, my gentle youths,  
But myxœdema, I'm told, it soothes.  
Landois says stolidly, 'functions unknown':  
Foster adopts an enquiring tone.  
Duct does not lead to its strange recess.  
Far below the vertex, above the pes,  
It is there, I am told, my class!"

R. M.

#### NOTES.

PROF. ERNST HAECKEL completes his sixtieth year on February 16 next. On the following day a marble bust of him is to be placed in the Zoological Institute at Jena. Dr. Richard Simon, of Jena, is the treasurer for the fund opened for this purpose, and the following Englishmen are on the general committee:—Mr. F. Darwin, Dr. Gadow, Prof. Huxley, Prof. Ray Lankester, Sir John Lubbock, Prof. Alfred Newton, Mr. Poulton, Mr. Adam Sedgwick, Mr. Sollas, Mr. Herbert Spencer, and Sir Wm. Turner.

THE competition for the prize of 500 francs, founded by De Candolle for the best monograph on a species or a family of plants, has been opened by the Société de Physique et d'Histoire Naturelle of Geneva. The memoirs may be written in Latin, French, German, English, or Italian, and should be sent to the President of the Society before January 15, 1895. Members of the Society are not admitted into the competition.

M. MAREY has been elected vice-president of the Paris Academy of Sciences for the ensuing year.

THE death is reported, at Vienna, on December 2, 1893, at the age of 62, of Dr. J. Boehm, well known for his researches on the circulation of the sap in plants.

THE death is also announced of Baron K. von Küster, eminent in botanical circles; of M. Quinquand, known for his investigations on nutrition and toxicology, and other important physiological works; and of Dr. Heider, Privatdocent in Hygiene in Vienna University.

WE regret to record the death of Herr W. von Freeden, which occurred at Bonn, on the 11th inst., after a short attack of inflammation of the lungs. Herr v. Freeden is best known to science as the founder and first director of the Norddeutsche Seewarte of Hamburg, which in 1875 was developed into the Deutsche Seewarte, under Dr. George Neumayer. Herr v. Freeden was born at Norden, in Hanover, in 1822; he was first appointed Teacher of Physics and Modern Languages at the Gymnasium at Jever, a post which he exchanged for the Headmastership of the Navigation School at Elsflath, near

Bremen. During his stay at Elsfleth he took an active part in the founding of the North German Lloyd's Company. In 1867 he resigned his position, and moved to Hamburg, where he established the Norddeutsche Seewarte, and in connection therewith organised the first system of storm warnings for the German coasts. The activity of this institution, which existed under the above title for eight years, was most creditable to its management. In February, 1875, the organisation was taken up by the Imperial Government, and Dr. v. Freeden was relieved of his office. He retired to Bonn, where he occupied himself with editing the *Hansa*, a nautical newspaper which he had started. He was for five years from 1871 Member for Hamburg of the Reichstag, but he declined re-election on removing his residence to Bonn.

THE *New Bulletin* says that Mr. W. Scott has been appointed Director of Forests and Botanical Gardens in Mauritius, in succession to Mr. J. Horne, who has recently retired.

DR. W. MIGULA has been appointed Professor of Botany at Karlsruhe Technical High School, Dr. W. Laposchukoff Professor of Botany in Tomsk University, Siberia, and Dr. Zelinka Extraordinary Professor of Zoology in Graz University.

THE medals and funds to be given at the anniversary meeting of the Geological Society of London to be held on February 16 next, have been awarded as follows:—The Wollaston Medal to Prof. Karl A. von Zittel; the Murchison Medal to Mr. W. T. Aveline; the Lyell Medal to Prof. John Milne, F.R.S.; the balance of the proceeds of the Wollaston Fund to Mr. A. Strahan; that of the Murchison Fund to Mr. G. Barrow; that of the Lyell Fund to Mr. William Hill; and a portion of the proceeds of the Barlow-Jameson Fund to Mr. Charles Davison.

DR. E. SYMES THOMPSON will deliver four lectures at Graham College from January 22-26, his subject being "The Sense of Touch."

THE forty-seventh annual general meeting of the Institution of Mechanical Engineers will be held on February 1 and 2, when the President, Dr. William Anderson, F.R.S., will retire, and will be succeeded by Prof. A. B. W. Kennedy, F.R.S.

A COMPLETE skeleton of a Plesiosaurus, about 3½ yards long, has been found, with other fossil remains, at Holzmaden in Württemberg. It is being taken to the Berlin Museum.

PROF. CARR informs us that a very extensive and valuable collection of British and foreign plants has been presented to the Nottingham Natural History Museum by Mr. H. Fisher, late of Newark. Some idea of the nature and extent of the collection may be gathered from the following enumeration of the more important series included in it: (1) A practically complete herbarium of British plants, comprising about 2000 species and varieties, and about 10,000 specimens. (2) A European collection, comprising many thousand species from France, Germany, Switzerland, Austria, Roumania, Russia, Norway, Sweden, &c. (3) Several thousand species from North America. (4) A very fine collection from the Bombay Presidency. (5) About 1500 species from Natal, the Transvaal, and other plants of South Africa. (6) A small collection from Australia. Of the above collection that from Russia is of quite exceptional value and interest. It comprises species from all parts of the Russian Empire—from St. Petersburg, Lapland, and the Crimea, through Siberia to Kamtschatka and Turkestan, also from the Trans-Caucasus and the Caspian region. The Spanish collection is an extremely fine and valuable one—probably one of the best in existence. In order to hand over the collection to the town in as complete and accessible a form as possible, Mr. Fisher is himself arranging and labelling the collection.

NO. 1264, VOL. 49]

MUCH has been written and conjectured as to the origin of music, and the rhythmical movement of the body which is intimately associated with musical sounds. Dr. S. Wilks, F.R.S., discusses this problem in the January number of the *Medical Magazine*. He points out that it is felt by many that the origin admits of a physiological explanation; but others prefer to regard music as a purely spiritual faculty. All, however, who have considered the nature and origin of music believe that rhythm, as exemplified by movement, is very closely connected with it. The latest work on primitive music is by Wallaschek, and the conclusion he arrives at is that rhythm, or keeping time, lies at the very foundation of the musical sense. But rhythm and the time sense can be referred to muscular contraction and relaxation, for it has been long maintained by physiologists that the muscular sense is the measure of time, and intimately bound up with the idea of music. As Dr. Wilks remarks, there must be an up and down movement or rhythm in all muscular action, and this seems to be the same thing as the sense of time or rhythm of which Wallaschek speaks. In fact, the rhythmical sense insisted on by Wallaschek as the basis of music is, in all probability, the muscular sense which physiologists believe to form an intimate part of the musical faculty. Not in the different passions of the mind, but in muscular action, therefore, music appears to have had its origin.

THE internal temperature of trees has formed the subject of some investigations by M. W. Prinz (*La Nature*). The results show that the mean annual internal temperature of a tree is practically the same as that of the surrounding air, but the monthly means differ by two or three degrees. In general it takes a day for a thermal variation to be transmitted to the heart of a tree. On some days the internal temperature differs by as much as 10° C. from the air outside, but generally the difference is only a few degrees. When the air-temperature falls below the freezing point, the internal temperature of a tree descends to a point near that at which the sap freezes, and appears to remain there. The maximum temperature of the interior of the trunk of a tree may occur some time before the maximum is reached by the surrounding air, owing to the action of the spring sun upon the tree while devoid of foliage. During the high temperatures of summer, the internal temperature was proved by the investigations to be about 15° C. with a variation of 2° C. at the most. Speaking generally, a large tree is warmer than the air in cold months, and a little colder than the air during the summer months.

DURING the recent frost, large masses of ice containing numerous freshwater eels were carried down the River Arun to Littlehampton. This affords an interesting example of the manner in which freshwater fish in a perfect state of preservation may be buried in some number in marine deposits.

MR. J. STIRLING, in his second special report on the Victorian Coal-fields, describes the various areas in detail, referring amongst other points to littoral and subaerial denudation and to the origin of soils. In the Kilcunda district numerous boreholes for coal have been put down by Government—one to a depth of 1153 feet.

MR. J. J. STEVENSON, in the *Bulletin* of the Geological Society for America, vol. v., discusses the origin of the Pennsylvania anthracite, and shows that there is no relation between the amount of disturbance of the strata and the production of anthracite. The coal becomes more anthracitic as the seams thicken towards the north-east; in this direction the coal seam, whilst in process of formation, would be longer exposed to chemical change.

DR. W. F. HUME read a paper on "The Genesis of the Chalk" before the Geologists' Association on January 5. He

showed that, viewed in its general aspect, the Chalk Period bears evidence of the almost continuous gain of elevation over depression influence. According to his researches, the Upper Greensand is the expression of coast-line conditions, the currents transporting shore material being sufficiently strong to make their influence felt over 150 miles from land. The chloritic marl probably represents the denuding effect of the advancing sea upon the sinking land. The chalk marl and grey chalk seen to have been deposited in areas of gradual subsidence; judging from the change in the Foraminifera, the gradual reduction in size and quantity of quartz and glauconitic grains, and the absolute disappearance of heavy minerals (zircon, &c.) in the higher zones of the Lower Chalk. The great purity of the chalk in the *Terebratulina gracilis* zone, and the almost entire absence of a heavy residue, indicates that the maximum depression for the Middle Chalk period very probably occurred about the time of the laying down of its central beds. From this zone onwards the chalk becomes more and more marly, passing finally into the condition of the chalk rock, that is, a truly nodular bed. The reappearance of quartz and glauconite grains, and heavy minerals (Tourmaline, Augite, and Hornblende), all point to this rock as having been formed during a period of elevation. The zones of the Upper Chalk show typically the continuation of great depression, for the flints gradually become reduced in size, and pass through various changes of shape, that is to say, from irregular to zoned, and finally to the tabular form.

An important experimental research on the "Decomposition of Liquids by Contact with Powdered Silica," was described by Dr. G. Gore at a recent meeting of the Birmingham Philosophical Society. The method of experiment employed was simply to take 25 centims. of a solution of an acid, salt, or alkali, of known composition, which had no chemical action upon pure precipitated silica (or other suitable insoluble powder), in a stoppered bottle; add to it 50 grains of the powder, thoroughly agitate the mixture, set it aside, usually about sixteen hours, and analyse the clear liquid portion. This enabled the chemical composition of the film of liquid which adhered to the powder to be approximately ascertained, and the influence of surface tension upon such composition to be examined. The experiments show that the chemical composition of films of liquid adhering to solids may be approximately ascertained by this method. They further show that the power of abstracting dissolved substances from liquids is a common property of finely divided solid bodies, and that the amount abstracted varies with the kind of powder employed; the degree of fineness of the powder, and consequently the amount of its surface; the kind of dissolved substance; the proportion of powder to dissolved substance; the kind of solvent; the proportion of solvent to powder; the proportion of dissolved substance to solvent; and, in a small degree, with the temperature. The union takes place quickly, and a long period of time has but little influence. Finely precipitated silica possesses the property in the greatest degree, and alkaline substances are the most affected; with very dilute alkaline solutions more than 80 per cent. of the dissolved substance was abstracted by the silica. The results appear to throw some light upon the purification of water by filtration through the earth and upon agriculture, and to show that the alkaline constituents of soils are retained much more by the silica than by the alumina. The effects of silica upon weak solutions of potassium cyanide indicate that the great loss of the latter substance in the commercial process of extracting gold and silver from powdered quartz is largely due to the "adhesion" of that salt to the silica. And the results obtained with silica and a very weak solution of iodine indicate a possible method of extracting the latter substance from solutions, and the recovery of

the iodine from the silica by distillation. The research brings more closely together the subjects of physics and chemistry.

THE *Annales* of the Roumanian Meteorological Institute, vol. vii., contains an account of a glazed frost, or smooth coating of ice, which occurred on November 11 and 12 last over a very large tract of country, and caused much damage to trees and telegraph lines: some of the trees had not only their boughs, but even their trunks broken by the weight of the deposit. Dr. Heptes states that in this case the cause of the formation of the glazed-frost was not that the rain fell upon objects at a temperature below zero, as the phenomenon has sometimes been explained, but that it is probable that the drops of rain were in a state of superfusion, and became frozen on touching the objects on which they fell. When the glazed-frost commenced, the temperature on the ground was  $36^{\circ}5$ . In the neighbourhood of Bucharest the telegraph wires were coated with ice an inch in diameter, and were thickly studded with stalactites of ice. The weight of this coating over the length of a metre of the wire was thirteen times as heavy as the wire itself.

THE numerous attempts which are at the present time being made to utilise the energy which runs to waste wherever there is a waterfall, and which have lately had considerable public attention drawn to them on account of the publication of Prof. Forbes' paper on the utilisation of the Niagara Falls, have received an interesting addition in the attempt that is being made on the canal between the Seine and Saône. It occurred to M. Galliot, an engineer at Dijon, to utilise the water power of the fall of water at the lock sluices to drive turbines and dynamos, the current obtained being used to propel the boats on the canal. The electric power is conveyed along the canal by means of a wire supported on posts, and each tow-boat is provided with a motor which takes its current from this wire. The propulsion of the tow-boat is effected, not by means of a screw propeller on the boat, but by a train of gear wheels connecting the motor to a chain which extends along the bottom of the canal, and by means of which the boat drags itself along. In addition to working the canal boats, the electric power is utilised to light up the interior of a tunnel through which the canal passes.

A PROPOSAL for a standard of "normal air" is made by M. A. Leduc in the *Comptes Rendus*. It is to be one litre of air taken at a place outside any town in a level country, and during calm weather. Freed from carbonic acid and water vapour, as well as traces of other accidental gases, such a litre of air would contain 23.2 per cent. by weight of oxygen. Since this proportion is variable in the same place by about 4 units in the second decimal place, it is useless to determine the weight of this litre of air to within more than 1,0000 of its value. A careful series of determinations gave 1.2932 gr. for this weight at  $0^{\circ}\text{C}$ ., at the latitude of Paris, and at 760 mm. pressure. Under 1 C.G.S. atmosphere, this weight would be 1.2758 gr. This standard would be sufficiently well defined for most practical purposes, but where greater accuracy is required, M. Leduc proposes to employ nitrogen as a standard of reference for gas densities. The weight of the normal litre of nitrogen at Paris is 1.2570 gr., or 1.24 gr. under 1 C.G.S. atmosphere, within 0.1 mgr.

THE *Journal de Physique* for December contains a paper by M. Violle, on the electric furnace and the light given out by, and the temperature of, the electric arc. In a former note a description of the form of furnace used by M. Violle has been given. The author considers that his experiments show that the electric arc is the seat of a perfectly definite physical phenomenon, namely, the ebullition of carbon, for the arc is characterised by a constant brightness (*i.e.* the light given out by a given

area of the positive crater is constant), and by the temperature being always the same, as well as by all the circumstances which characterise normal ebullition. The constancy of the character of the light given out by the arc has been noted by Abney and Festing, who have adopted it as the standard of white light, and the author's observations show that whatever be the watts consumed in the lamp, the brightness remains constant. This he has shown by direct comparison with a standard light, and also by photographing the positive carbon, when the density of the image remained constant.

PROF. S. P. LANGLEY, who has recently been giving a large amount of attention to aerodynamics, contributes a remarkable paper to the current *American Journal of Science* on what he calls "The Internal Work of the Wind." The conclusions attained in this paper lead the author to the confident assertion of the mechanical and practical possibility of a heavy body, provided with suitable plane or curved surfaces, being suspended indefinitely in a wind, or even advancing against it without connection with the ground or the expenditure of internal energy. This is to be brought about by utilising the heterogeneous structure of wind, which Prof. Langley shows to consist of puffs succeeding each other several times per minute. This was proved by the records of some very light anemometers with paper cups, mounted on the roof of the Smithsonian Institution, at 153 feet above the ground. The electric record was made at every half revolution. In one case a wind of 23 miles an hour rose within 10 seconds to a velocity of 33 miles an hour, and fell to its initial speed in another 10 seconds. It then rose within 30 seconds to 36 miles an hour, and so on, passing through a series of maxima and minima separated by intervals of about 10 seconds, and sometimes stopping altogether. This observation may serve to solve the long-discussed problem of the soaring of birds. A wind acting against a free plane at a suitable angle will urge it upwards until the plane has assumed the velocity of the steady wind. If the wind-velocity is then reversed, absolutely or relatively, and the inclination of the plane is reversed at the same time, the plane will be urged still further upwards, and the more so the greater its weight. If a heavy body can thus rise, it follows at once that it can also advance against the wind if not too strong, by utilising the energy thus acquired, and descending in the direction whence the wind blows. The main difficulty in constructing a contrivance to effect this would lie in the adjustment of the inclination to a varying wind, but Prof. Langley is confident that this difficulty will not prove insuperable.

THE alleged discovery of the northern end of Greenland in the Nordenskiöld Inlet seems to have been based upon a very bold interpretation of Peary's observations. Peary himself has, in his first account, said nothing about having discovered a passage from Nordenskiöld Inlet to Independence Bay, and the report now issued by his companion, J. Astrup (*Geogr. Selsk. Aarbog.*), which gives particulars of what was actually observed, does not allow any conclusion as to a waterway connecting them. It would be strange indeed if Astrup let the discovery of the north end of Greenland unmentioned, as if it were something unessential.

AN ingenious method for making permanent microscopic preparations of particular colonies on a gelatine plate, has been recently devised by Hauser (*Muenchener med. Wochenschrift*, 1893, No. 35). It was found that when exposed for some time to the vapour of formalin, gelatine becomes so rigid that no temperature is able to melt it; even submitting it to the heat of a bunsen flame, or boiling it in a soda solution, fail to liquefy it. This formalin-gelatine becomes, moreover, strongly antiseptic, for when freely exposed to the air no colonies make their

appearance, and neither will those organisms grow which are purposely introduced into it. Gegner, in an earlier number of this journal, states that although solutions of formalin had a bactericidal action, the vapour was a far more powerful antiseptic; this investigator also notes that gelatine exposed to this vapour would not melt at 37 C. To prepare bacterial colonies for microscopic examination, Hauser takes a thin film of the solid gelatine containing the particular growth required, and places it on an object glass, and, superposing a cover-glass, seals it from the outer air by a rim of melted gelatine. The preparation is then placed in the formalin chamber for twenty-four hours, during which it becomes quite solid, and on being removed may be further protected by a border of sealing-wax. If it is desired to stain the colonies before the formalin process, the gelatine film should be immersed for twenty-four hours in a weak aqueous solution of fuchsin, by which means the bacterial growth becomes fairly strongly coloured, whilst the gelatine itself only assumes a much paler hue.

We have received the 1894 *Annuaire* of the Brussels Académie Royale des Sciences, des Lettres et des Beaux-Arts.

"THE Elements of Co-ordinate Geometry." Part I, by W. Briggs and G. H. Bryan (Univ. Coll. Press), has reached a second edition.

A THIRD edition, enlarged and revised, of Dr. T. Dutton's little book on "Indigestion" (Kimpton, and Hirschfeld Bros.) has been published.

MR. WILLIAM CLAY, Edinburgh, has issued a new catalogue, No. 60, of standard second-hand and new books on physical science offered for sale.

DR. H. WAGNER gives an account, in the *Oesterreichische Botanische Zeitschrift*, of his botanical exploration of the Balkans, in company with Herr J. Stipanics, entomologist.

THE *Journal of Anatomy and Physiology* for January contains an article by Mr. A. Keith, on the ligaments of the Catarrhine monkeys, with references to corresponding structures in man. Profs. J. C. Ewart and A. Macalister are among the other contributors to the number.

THE first part is published of Dr. H. Trimen's "Handbook to the Flora of Ceylon," containing descriptions of all the species of flowering plants indigenous to the island, and notes on their history, distribution, and uses. It is issued under the authority of the Government of Ceylon.

THE Calendar just issued by the Department of Science and Art contains the following names of recently appointed Inspectors of Science and Art Schools:—Dr. E. J. Ball, R. Blair, S. F. Dufton, C. Geldard, Dr. H. H. Hoffert, D. E. Jones, Dr. MacNair, C. McRae, T. Preston, F. Pullinger, Captain T. B. Shaw, R.E., and H. Wager.

THE National Footpath Preservation Society, of which the late Prof. Tyndall was a member, has issued its ninth annual report. The large number of cases of footpath interference, encroachments, &c. described in the report, shows that the society exerts a salutary influence upon those who are inclined to disregard ancient rights.

SUBSCRIPTIONS are invited by Laidley and Co., of Port Elizabeth, to the issue of a complete botanical collection for the Cape Colony, Kaffraria, Natal, Zululand, Swaziland, Matabeleland, Bechuanaland, Mashonaland, the Transvaal, Orange Free State, and the Portuguese territories of the Zambesi. The flora is computed to exceed 20,000 species.

MESSRS. BLACKIE AND SON have sent us several of their Guides to the Science Examinations of the Department of Science

and Art. The books contain some useful hints to intending examinees, and answers to questions that have been set at the Departmental examinations. A number of test-papers in mathematics, arranged by Mr. R. Roberts, has also just been published by Messrs. Blackie.

“*La Terre avant l'apparition de l'Homme*” (MM. Baillièrre et Fils) is a bulky tome by Prof. F. Priem, in Brehm's *Merveilles de la Nature* series. In it the author recounts the numerous changes through which our globe has passed in geological time. He describes the distribution of land and water during the well-marked periods of this world's history, and deals particularly with the fauna and flora of bygone days. In the latter half of the work, the geology of France is dealt with in a very detailed manner. The book is *au courant* with recent investigations in geology and palæontology; it contains 850 figures illustrating fossils, geological sections, picturesque regions and interesting formations, and is worthy of a high place in the fine series to which it belongs.

During the last few months we have had the pleasure of commenting upon several chatty books on natural history matters—books in which instruction is happily combined with interest. Another volume of a similar kind, “*Random Recollections of Woodland, Fen, and Hill*,” by Mr. J. W. Tutt (Swan Sonnenschein and Co.), has recently been published. We recommend the book to the nature-lover and entomologist because it contains a large amount of information brightly put and generally accurate; and all who can appreciate the beauties of natural creatures and things would do well to read it.

A VERY important collection of works is being offered for sale by Messrs. W. Wesley and Son. We refer to the Paracelsus Library of Dr. E. Schubert, who died at Frankfort-on-the-Main in 1892. The library contains 194 editions of the writings of Paracelsus, 548 works which partly or chiefly treat of Paracelsus, description of his times and the places where he worked, publications of his friends and opponents, and a selection of 351 works on alchemy. Altogether this unique collection comprises about eleven hundred books, manuscripts, portraits, and tracts, and it is richer in original editions of Paracelsus than that of the British Museum. It is satisfactory to know that no part of the library will be disposed of separately, with the exception of the portion on alchemy.

AN investigation of the mechanics of the interaction of ethyl alcohol and hydrogen chloride is communicated from Prof. Lothar Meyer's laboratory to No. 12, 1893, of the *Zeitschrift für physikalische Chemie* by Mr. Cannell Cain. Solutions of hydrogen chloride of different strengths were obtained by leading the dry gas into the dry alcohol, which was coated by a freezing mixture. A definite quantity of such a solution was then sealed up in a small glass tube, and kept for a definite length of time at a constant temperature in a water bath. The composition of the solution before and after the interaction was ascertained by titrating a known amount with decinormal soda solution. The results show that concentration and time of reaction being the same, the extent of the chemical change increases rapidly with the temperature. Up to 15° there is no appreciable interaction, but in a solution containing 100 equivalents of alcohol and 81 of hydrogen chloride at 80° some 15 per cent., and at 99 some 50 per cent. of the latter enter into combination in one hour. For a given temperature and concentration the amount of decomposition increases with the time at a rate which gradually diminishes, and finally becomes zero. Temperature and time of reaction being the same, it is also shown that increase in the quantity of alcohol in the above solution, or addition of water or ethyl chloride, retard the rate of change. By experiments with water and ethyl chloride the

author makes clear the reversible character of the action, and next makes observations to ascertain the relative proportions of the substances present when equilibrium is established. In these experiments various solutions of hydrogen chloride in alcohol, alone, and in presence of different amounts of water are employed. Here it is shown that Guldeberg and Waage's law is obeyed, as the product of the active masses of alcohol and hydrogen chloride bears a constant ratio to the product of those of water and ethyl chloride unless in cases where ethyl chloride separates out, and the solutions thus become heterogeneous. If the alcohol and hydrogen chloride be present in equivalent amounts the results indicate that the equation  $C_2H_5OH + HCl + 3C_2H_5Cl + 3H_2O$  approximately represents the condition of things when equilibrium is attained.

IN the review of Mr. Richard Inwards' “*Weather Lore*,” that appeared in these columns on January 4, p. 219, the author's attention was commended to a collection of “*wise saws*” made for the U. S. Signal Service by Major Danwoody. Mr. Inwards points out to us that his book contains extracts from this collection, and that he acknowledges his obligations to it in the introduction. We regret that this acknowledgment was overlooked by the writer of the notice.

THE additions to the Zoological Society's Gardens during the past week include two Mozambique Monkeys (*Cercopithecus pygerythrus*) from East Africa, presented respectively by Mr. H. P. East and Mrs. Adams; two Common Marmosets (*Hapale jacchus*) from South-east Brazil, a Common Hamster (*Cricetus frumentarius*) European, presented by Mrs. Brightwen; two Jackdaws (*Corvus monedula*) British, presented by Miss Williams; a Clifford's Snake (*Zamenis Cliffordi*) from Egypt, presented by Mr. W. L. Tod; a Malaccan Parrakeet (*Palaornis longicauda*) from Malacca, deposited; a Snow Leopard (*Felis uncia*) from Lahoul, Punjab, Himalayas, an Alpine Marmot (*Arctomys marmotta*) European, two Hairy Armadillos (*Dasyurus villosus*), a Black-necked Swan (*Cygnus nigricollis*), two Rufous Tinamous (*Rhynchotus rufescens*), two Brazilian Caracaras (*Polyborus brasiliensis*), two Common Teguxins (*Tupinambis teguxin*), a Common Boa (*Boa constrictor*) from South America, a Melodius Jay Thrush (*Leucoliotron canorum*) from China, purchased; two Lapwings (*Vanellus vulgaris*), two Dunlins (*Tinga alpina*) British, received in exchange.

#### OUR ASTRONOMICAL COLUMN.

SUNSPOTS AND SOLAR RADIATION.—Spectroscopic observations, the discussion of the frequency of tropical cyclones, and cyclical variations of barometric pressure, indicate that the greatest amount of heat is received from the sun by the earth during a maximum epoch of solar activity. But, on the other hand, the discussions of statistics of air temperature and solar radiation suggest that the sun's heat is greatest when his surface is least spotted. Some new facts in connection with this paradox are described by M. R. Savélief in the current *Comptes Rendus*, and seem to combat the latter result. He has made a large number of observations with a Crova's actinograph since June 1890, and compared them with the late Dr. Wolf's numbers showing the relative frequency of solar spots. A few observations are given indicating that the solar constant increases with the increase of solar activity. M. Savélief has also calculated the mean quantity of heat received on one square centimetre of horizontal surface on the ground during one day, and for an hour of solar radiation. The results obtained by this method, like those deduced from the solar constant, point to the conclusion that the calorific intensity of solar radiation increases with the activity of the phenomena visible upon the surface of the sun, that is to say, with the increase of solar spottedness. These results are diametrically opposed to those obtained by previous investigators (see NATURE, vol. xliii. p. 583), and, if they are confirmed, a real difficulty in the way of explaining the correlation of solar and meteorological phenomena will have been removed.

THE MEASUREMENT OF STELLAR DIAMETERS.—When the objective of a telescope is covered with a screen having two slits in it, the image of the object under observation takes the form of a series of fringes lying in the direction of the slits; and every one with an elementary knowledge of physics knows that this appearance is due to the interference of the beams of light traversing the instrument. Fizeau appears to have been the first to point out that the size of the fringes depends upon the angular dimensions of the luminous source producing them, and that this fact might be utilised to determine stellar diameters. The means by which Prof. Michelson has applied the principle to the measurement of the diameters of Jupiter's satellites has already been described in these columns (vol. xlv. p. 160); but the subject is so important that we give here the gist of a discussion of the theory of the matter, contributed by M. Maurice Hamy to the number of the *Bulletin Astronomique* just issued. By means of Prof. Michelson's interferential refractometer—an instrument with a life of usefulness before it—it is possible to measure diameters down to 0.01, that is, to the angle which the sun would subtend if it were removed to the distance of  $\alpha$  Centauri. In fact, there is little doubt that the diameters of stars are measurable by this means. All that is necessary theoretically is to cover the object glass of the telescope with a screen having two rectangular, parallel slits, equal and of variable width. The interference fringes produced at the focus of the instrument are made to disappear by separating the slits, and when the fringes corresponding to light of a wavelength represented by  $\lambda$  have vanished, the distance ( $l$ ) between the centres of the slits must be measured. The exact formula which enables the diameter ( $\epsilon$ ) of the object under examination to be determined from these data is, according to M. Hamy,

$$\epsilon = 1.22 \frac{\lambda}{\sin l}$$

There are, of course, a few difficulties in the way of perfectly realising the theory, but they are being overcome, and it is not too much to say that the interferential refractometer will add very considerably to astronomical knowledge before the end of this century. It would be interesting to measure the diameters of Algol, and some of the spectroscopic binaries, and compare the results with those deduced from observations of motion in the line of sight.

THE MOON AND WEATHER.—The solitary observable effect of the moon on our atmosphere was believed by Sir J. Herschel to be exhibited in the tendency of clouds to disappear under a Full Moon. He attributed this to the heat radiated from the lunar surface. Humboldt speaks of this connection as well-known in South America, and Arago indirectly supports the theory by stating that more rain falls about the time of New Moon than at the time of Full Moon; the former period being cloudy, and the latter cloudless, according to theory. With the idea of obtaining information upon the matter, the Rev. S. J. Johnson has examined the state of the sky at moonrise and at midnight on the day of Full Moon only for the last fifteen years. His results were communicated to the Royal Astronomical Society on January 12, and they confirm the opinion now held by almost every astronomer, viz. that the Full Moon has no effect in breaking up clouds.

GEOGRAPHICAL NOTES.

MRS. BISHOP (Miss Isabella Bird) has set out *via* Canada for Korea, where she intends to spend some time studying the country, and whence she may afterwards make a journey into Manchuria.

THREE Christmas lectures to young people by Mr. Douglas W. Freshfield, were arranged by the Royal Geographical Society, and were delivered in the second week of January to an interested audience. The subject was mountain-study as a branch of geography, and the lectures were illustrated by a large collection of extremely fine photographic views of the Alps and Caucasus.

MR. H. J. MACKINDER commenced the second series of his lectures on the relation between geography and history, in pursuance of the Royal Geographical Society's Educational Scheme, on January 11, in the theatre of the Royal United Service Institution, Whitehall Yard. The lecture was intro-

ductory to the present course, which will be continued weekly, and consisted of an epitome of last year's lectures, showing that physical and geographical conditions largely determine the order of history and the movements of peoples. The remaining lectures will deal with a series of concrete examples, focussing the essential features of the relation between the geography and history of the chief countries of Europe, and especially of the British Islands.

THE *Zeitschrift* of the Berlin Geographical Society publishes an interesting paper, by Dr. Wegener, on the Chinese map of northern Tibet and the Lob-nor District, being a sheet of the official Chinese Atlas compiled by the labours of the Jesuit missionaries at the Court of Peking, who trained and superintended Chinese surveyors. It was first published in 1718, and an enlarged edition appeared in 1863 extending over the greater part of Asia. This work still is the basis of the European maps of many parts of Tibet, and the careful index of names prepared by Herr Himly, which accompanies the report, is of extreme value, as, not content with the Chinese lettering, he has had recourse to the original Tibetan, Turki, and other native names, which he transliterates with great care.

AUGUST ARTARIA, the eminent Austrian map publisher, who has done much to maintain the character of scientific cartography, died at Vienna on December 14, 1893, aged 87.

MM. SCHRADER AND DE MARGERIE, whose long study of the geology of the Pyrenees is well known, have contributed to the last volume of the *Annuaire* of the French Alpine Club a concise discussion of the geographical conditions of the chain illustrated by a large-scale coloured orographical map. The denudation of the northern slope has been much more complete than that of the southern; the tertiary strata remain on the latter, but on the French side have been eroded away to form the vast fans of alluvium of the lower plain. Despite their general form, the Pyrenees are not composed of ranges running east and west, but of mountain knots and short ranges oblique to the general direction running towards E. 30° S. and then turning towards E.N.E. as a rule. The mean altitude of the chain is about 1000 metres, or say 3300 feet. Elie de Beaumont, on the assumption that the southern slope was strictly similar to the northern, made his estimate of the mean height 500 metres greater. The mass of the Pyrenees, if spread over the surface of France, would raise the level of that country by 102 metres, or 330 feet.

A NEW SULPHIDE OF CARBON.

A NEW liquid sulphide of carbon of the composition C<sub>3</sub>S<sub>2</sub> has been isolated in a somewhat remarkable manner in the chemical laboratory of the university of Buda-Pesth, by Prof. von Lengyel, who contributes an account of it to the current *Berichte*. In addition to the well-known disulphide of carbon, several other substances supposed to be compounds of carbon and sulphur have from time to time been described; but as they appear to have been amorphous insoluble solids very difficult to purify, there is very little evidence of their being definite compounds. The substance now described, however, appears to be a very well characterised liquid compound of unmistakable odour and corrosive action upon the skin, and capable of being distilled under diminished pressure.

The method of preparing it was accidentally discovered during the elaboration of a number of lecture experiments illustrating the synthesis and decomposition of carbon disulphide. It was long ago pointed out by Berthelot that this familiar substance decomposes at a temperature but slightly higher than that at which its formation from its constituents occurs. Buff and von Hofmann subsequently showed that the temperature of a glowing platinum wire was ample to bring about slow dissociation of the vapour, and that the disruption of the compound occurred very rapidly indeed at the temperature of red-hot iron wire. An experiment was therefore arranged to ascertain whether rapid removal of the vapour of the synthesised compound from the heated sphere of action would largely prevent the loss by dissociation, and in order that the test should be a severe one, the rapidly moving vapour was subjected in its passage to the high temperature of the electric arc. It was during this experiment that the new sulphide of carbon was unexpectedly produced.

A little more than a hundred cubic centimetres of carbon

disulphide were placed in a flask arranged over a water bath. A large globe had been previously sealed on to the neck of the flask, through tubuli in which the carbon electrodes were inserted. To a third tubulus of the globe an upward condenser was fitted, the interior tube of which was finally bent downwards to serve as a gas delivery tube. The water bath was then heated and the carbon disulphide maintained in rapid ebullition, the electrodes were approached until the powerful current from accumulators was transmitted, and then withdrawn so as to generate the arc. The electric arc in carbon disulphide vapour under these conditions is a remarkable phenomenon: it is seamed with a dark band passing along its centre from pole to pole, and the brightest spots of the incandescent terminals are just where the band appears to touch them. The carbon disulphide was kept boiling and the arc passing for a couple of hours, during which the globe was filled with the vapour, which condensed in the condenser, and fell back into the flask. The interior of the apparatus soon commenced to blacken with liberated carbon, which collected upon the surface of the liquid, and an extraordinarily strong tear-exciting odour soon made itself evident in the neighbourhood of the apparatus. At the conclusion of the experiment the residual liquid was decanted in colour, and was transferred to a closed vessel containing copper turnings in order to remove the free sulphur present. After being thus left for a week it was filtered, and the carbon disulphide evaporated at a low temperature in a current of dried air, in order, if possible, to isolate the substance endowed with the powerful odour. Eventually a few cubic centimetres of a deep red liquid, the new sulphide of carbon, were left, which possessed the odour in greater intensity, a trace of the vapour producing a copious flow of tears, accompanied by violent and persistent catarrh of the eyes and mucous membrane. A drop of the liquid, moreover, at once blackened the skin.

The specific gravity of this liquid is 1.2739, so that it sinks under water, with which it does not mix. When heated it polymerises into a hard black substance. If the rise of temperature is gradual the change occurs quietly, but when rapidly heated to 100-120° the polymerisation takes place with explosive force, the interior of the vessel being covered with projected deposits of the black substance. Analyses both of the liquid and of the black solid indicate the same empirical formula,  $C_3S_2$ , and molecular weight determinations of the liquid, dissolved in benzene, by Raoult's method, agree closely with the molecular weight corresponding to that formula. The liquid can be partially distilled at 60° *in vacuo*, a small portion, however, always polymerising. The liquid, moreover, spontaneously changes in a few weeks into the more stable black solid modification. The solutions of the liquid in organic solvents likewise slowly deposit the black form.

The liquid readily ignites, burning with a luminous flame, and forming dioxides of carbon and sulphur. Caustic alkalis dissolve it, forming dark coloured solutions from which dilute acids precipitate the polymerised black compound. With alcoholic potash the action is very violent. A drop of concentrated sulphuric acid causes instant passage to the black form accompanied by a hissing noise. Nitric acid provokes an explosion and ignition, but 70 per cent. acid dissolves it completely and quietly.

The black polymeric modification is readily soluble in caustic alkalis, but acids reprecipitate it unchanged. When heated it undergoes a remarkable change, sulphur subliming, and a gas, inflammable and containing sulphur, but not carbon disulphide, is liberated, the nature of which is reserved for a further communication.

The liquid sulphide combines readily with six atoms of bromine, with evolution of heat. The substance is readily isolated when bromine is dropped into a solution of  $C_3S_2$  in chloroform, as it is insoluble in that solvent. Strangely enough this compound,  $C_3S_2Br_6$ , is endowed with a pleasant aromatic odour, two substances of frightful odours thus uniting to form an agreeably odiferous compound, a striking example of the effect of chemical combination.

A. E. TUTTON.

#### DR. GREGORY'S JOURNEY TO MT. KENIA.

At the meeting of the Royal Geographical Society on Monday evening, Dr. J. W. Gregory read a paper, of which the following is a full abstract:—

It has long been known that the lakes of Equatorial Africa are developed on two types, first those which have low shores

and are rounded in shape, and second those which have high, steep shores and are long and narrow. The lakes of the latter group, moreover, are distributed on a definite plan, occurring at intervals along lines of depression across the country. The chief of these runs from Lake Nyasa through a large series of lakes, including Natron, Nawasha, Baringo and Basso Narok (Lake Rudolf); from the last of these the line of depression runs through Abyssinia into the Red Sea, which continues the same type of geographical structure for 15° to the north; thence it can be followed up the Gulf of Akaba to the Dead Sea and Jordan Valley. It seems not unlikely that the whole of this great line is due to one common earth movement of no very great age, for the traditions of the natives around Tanganyika, of the Somalis and Arabs, and of the destruction of Sodom and Gomorrah may have reference to it. It was the interest which these problems excited that led to Dr. Gregory's desire to visit the district, as he was recently enabled to do, by the permission of the Trustees of the British Museum. He started with a large expedition, intended to explore this "Rift Valley" in the neighbourhood of Lake Rudolf, which landed at Lamu, and thence started up the Tana Valley, where it unfortunately collapsed. On his return to Mombasa Dr. Gregory himself organised a small caravan of forty Zanzibaris, and travelled to the highest part of the "Rift Valley" between Nawasha and Baringo, examining its structure and natural history. The most risky part of the journey was crossing the high plateau of Leikipia, which has only twice before been traversed, by Teleki and Hohnel in 1887, and by the German Emin Relief Expedition under Dr. Peters in 1889-1890. Mr. Joseph Thomson reached its western side, but had to abandon his camp and escape under cover of night. The expedition crossed Leikipia by a new route, and traversing the plateau which is marked as the site of the "Aberdare Mountains," reached Northern Kikuyu without trouble, except for want of food. The natives at first refused to sell any, as some white men who had visited a neighbouring district had seized food without payment, shot the elders, and carried off the young men as porters. After much "shauri" the natives were satisfied as to the peaceful object of the expedition, the right of blood-brotherhood was celebrated, and food obtained. The party then turned north, to the western foot of Mount Kenia. Most of the men were left in the camp while Dr. Gregory and twelve men started for the central peak. Three days were spent cutting away through the dense forest and bamboo jungle on the lower slope. Owing to the damp, mist, and cold, this work was very severe on the Zanzibaris. On the fourth day they emerged on to the Alpine pastures, only to be caught in a furious blizzard of snow and hail, which necessitated camping for the night on a frozen peat bog. Next day a tent was carried higher up, as a base for reconnoitring excursions. The most important of the peaks on the south slope was ascended, and named Mount Hohnel, after the Austrian explorer. Five glaciers and eight lakes were discovered, as well as an interesting flora and fauna. A small shelter-tent was taken to near the end of the largest glacier, in readiness for an ascent of the central peak. A snow-slip during a severe storm in the night nearly buried this, and did cover all the food. The ascent had therefore to be attempted after a night's exposure to a severe storm, and without food. The main glacier, which was named after the late Prof. Carvell Lewis, was explored, and the *net* field at its head crossed to the main south *arête*. After ascending this for some distance it became badly coniced, the risks of further progress were too serious to be encountered alone, and after reaching the height of a little over 17,000 feet it was necessary to return. In a subsequent attempt on the west *arête*, Dr. Gregory was caught in a severe snowstorm, which rendered the route followed in the ascent impassable, and might have entailed serious consequences. He was then recalled to attend to his men, many of whom were suffering severely from the cold and altitude, and an immediate descent to Leikipia was necessary; he had, however, achieved the five purposes for which he visited the mountain.

During the return to the coast much new ground was covered with some interesting topographical results; but except for securing a passage across Kikuyu, by curing the chief of tooth-ache, this part of the journey presented little of general interest.

In conclusion, some of the scientific results of the expedition were summarised, though it was said to be too early to do this properly. Among the more interesting results was the discovery of the former greater extension of the glaciers of Mount



Kenia, as their moraines were found 5000 feet below their present level; this would have a great influence in the distribution of the Alpine flora in equatorial Africa. In spite of the numerous detailed studies of Kilima Njaro, no such evidence had been recorded from that mountain. The fish faunas are remarkably mixed, and show, as has long been surmised, that the distribution of the African rivers was once very different from the present. The geological results of the expedition suggest that at one time the Nile did not flow from the Nyanza, but rose in the mountains to the north; and the drainage of the lakes flowed away to the east and then to the north, past the site of Lake Rudolf to the Red Sea. Thus it was pointed out that the exploration of this part of Africa is of value not merely as supplying topographical information, but from its bearing on some important problems of geographical evolution.

### THE GEOLOGY OF AUSTRALIA.

IN the distant future the antiquity that this country can ever possess is the history of the occupation by its present holders; its aboriginal people have not furnished any evidence of a past history, inasmuch, had it happened that they had become extinct a quarter of a century before their discovery, the only traces of prior occupation would have been in the form of stone knives and hatchets and flint spearheads. Interwoven with the history of the progress of discovery and occupation is that of the successive additions to our knowledge of its physical structure and its natural history. The records of botanical science and of geographical exploration have been brought up to a recent date; but the annals of the history of geological progress have not yet been consecutively placed on record. In the selection of a subject for my address I had experienced great difficulty in discriminating between personal interest and representative duty, and in choosing a "century of geological progress" for my theme I have sacrificed the former.

The labour involved in the preparation of this address has been very heavy, as I have read a hundred volumes to produce a very modest account; thus what I have done looks small when I recall the continuousness of the effort that accomplished it. The history of the progress of geology in Australia is intimately associated with that of its geographical discovery and of its advancement in scientific culture; it will constitute a chapter in the early history of modern Australia, and I venture to give some connected view of it, which, however bad it may be, is better than to have no view at all; moreover, there are associated with the subject personal histories which should be recorded whilst the knowledge of them is still within our memory. And although it is my special object to depict actual culminating results without any extended notice of the facts and events which may have led up to them, yet to a certain extent a knowledge of such facts and events is essential to their proper appreciation, and may be productive of increased interest.

Just prior to the close of the last century, the controversy between the Wernerian and Huttonian schools, or between Vulcanists and Neptunists, relating to the origin of the crust of the earth, was at its height. The Huttonian theory, which prevailed, recognises that the strata of the present land surfaces were formed out of the waste of pre-existing continents, and that the same forces are still active. The characteristic feature of Hutton's theory is the exclusion of all causes not recognised to belong to the present order of nature. With the opening of the present century a new school arose, which laid the foundation of modern geology. Three men were largely concerned in this achievement—Cuvier, Lamarck, and William Smith: the two former in France had all the powers which great talent, education, and station could give, whilst the last was an English land surveyor without culture or influence. George Cuvier laid the foundation of comparative osteology, recent and fossil; Lamarck that of invertebrate paleontology; whilst Smith established the fundamental principles of stratigraphical paleontology, viz. the superposition of stratified rocks and the succession of life in time.

The earliest geological observations relating to Australia antedate by only a few years the beginning of this century, so

that the history of our progress in geology is concurrent with that of modern geology, and it affords grand illustrations of the methods of application of the laws as they were successively evolved in the European schools, to an area so distantly removed from that which gave them birth. Thus our history begins at a most fortuitous period. No prejudices or scholastic disputations have retarded our progress, for those who have aided in the work were disciples in the modern school of geology. And though, on a retrospective glance, we may hesitate to attach any high value to the labours of pioneer geologists, yet we should not forget that our horizon is so much vaster than theirs was, and to the extension of it they had lent their aid. And though it may be true that if the geological progress of the first half of this century were quite ignored, we would not probably suffer any great loss, as I believe that nearly all the areas explored at the earliest period have been re-examined in later times by men more carefully trained than was previously possible, nevertheless the gradual accumulation of data supplies us with a history, and makes us better acquainted with the causes that at certain times made that progress slow, or even retarded it. For the first three or four decades of this century our geological knowledge had been almost entirely the outcome of maritime surveys, whilst in later years it has been largely supplemented by inland exploration; thus, for a half-century or so the geological progress is part of the history of topographical discovery, which explains why our earlier geological information is inseparable from the achievements of such renowned geographers as Flinders, Baudin, King, Sturt, Mitchell, Stokes, Wilkes, Leichardt, Gregory, &c. The subsequent history of our geological progress commences with the establishment of systematic geological surveys in New South Wales and Victoria, which afterwards led to their extension to the other provincial areas. Almost simultaneously, universities were founded at Melbourne and Sydney; thus whilst the surveys dealt with geology more in its industrial applications, the universities upheld its value on purely scientific grounds. By these agencies a large interest was awakened in the science, and many in whom zeal had been latent were added to the ranks of geological investigators. Much of the knowledge gained in these various ways is expressed on the geological map of Australia, published by the Victorian Government in 1887. The several steps by which this map has been built up, I will endeavour to make known to you, and though my geological reminiscences do not extend far back, yet they embrace some of the most important discoveries made on this continent; at the same time I would wish to avoid the mistake of claiming too large an authority on account of my years.

Though the discovery of Australia may date back to the middle of the sixteenth century, yet it continued a *terra incognita*, at least from a scientific point of view, until Cook—the Columbus of the south—began in 1770 the present phase of scientific expeditions; and though geology reaped no gain, yet in botany was laid the foundation of a knowledge of that marvellous and peculiar flora of Australia through the labours of Banks and Solander, the companions of Cook.

Vancouver, who discovered King George Sound in 1791, describes the summit of Bald Head to be covered with a coral structure, amongst which are many sea-shells, and argued a modern date of elevation. However faulty the interpretation of the nature of the data may be, yet the deduction is sound, and that may be claimed as the first recorded geological observation for Australia, made 102½ years ago.

Coal was discovered in New South Wales in 1797, first to the south of Sydney, and in the same year on the banks of the River Hunter, at what is now Newcastle.

Flinders and Bass, jointly and separately, between the years 1797 and 1798, had explored the coast-line southward from Sydney, reaching as far west as Western Port, and embracing the circumnavigation of Tasmania. The more prominent rock phenomena were described. In 1801 Flinders was commissioned to complete the examination and survey of New Holland. The coast-line of Australia was traced with care as far as the tropics; Flinders paid much attention to physiographic features, whilst Brown collected rock specimens. The rock specimens collected on this survey were reported on by Dr. Filson in 1825, but beyond their mere enumeration and their agreement with those of the same denomination from other parts of the world, no attempt was made to chronologically arrange them; others collected by Brown, during his sojourn in New South Wales, were reported on by Dean Buckland in 1821, hereafter referred to.

Contemporaneously with the marine survey by Flinders was

<sup>1</sup> A part of the inaugural address delivered at Adelaide, on September 26, 1893, by Prof. Ralph Tate, the newly elected President of the Australian Association for the Advancement of Science.

that by the French under Baudin. The scientific equipment was unrivalled in the annals of Australian exploration. To Depuch and Bailly were entrusted the mineralogical and geological researches. The former left the ship at Sydney to return to Europe, but he died at Mauritius, and his manuscripts, which he had taken with him, and were to serve for a geological history of New Holland, were irrecoverably lost. Peron was the senior zoologist, and the author of the narrative of the expedition. Peron's account of the physiography and geology of the places visited is not only graphic but rich in details; he closely investigated the nature and origin of the Eolian calciferous sandstones, and fully recognised their relationship to the blown-sand of the dunes. The entombed calcified snags of branches and stems of trees were correctly recognised, though Vancouver and Flinders had erroneously considered them as coral reefs. He rightly referred the fundamental rocks of Kangaroo and King Islands to different kinds of primitive schists, and the superimposed fossiliferous limestone at the former place was correctly observed, though not attributed to any particular epoch. The occurrence of corals and marine shells of recent appearance at considerable elevations on the coast was justly regarded by him as demonstrating the "former abode of the sea" above the land, and very naturally suggested an inquiry as to the nature of the evolutions to which this change of situation is to be ascribed. Few geologists have been more in advance of the age in which they lived, or have suffered so long an undeserved oblivion, as Peron. After the termination of the survey by Flinders, through the loss of his ship, and subsequent detention by the French, in which France was the first to debase, as she was the first to promulgate, that principal axiom of international law, "Causa scientiarum, causa populorum" (the cause of science is the cause of the people), twelve years elapsed before England's attention was diverted from the battle-field to geographical discoveries in Australia by the appointment of Captain King to complete the coast surveys left unfinished by Flinders, which occupied him from 1818 to 1822. King could spare but little time to land, and, with few exceptions, merely traced the coast. The paucity of geological information is thus accounted for, and the few references are merely lithological. John Oxley, Surveyor-General, to whom we owe the earliest topographical map of New South Wales, took charge in 1817 of an expedition to ascertain the character of the western interior, a practicable route across the Blue Mountains having been opened in 1815. He traced the Lachlan down to longitude 144°, and completed the discovery of the Blue Mountains, which constitute the prominent physiographic feature of New South Wales. In 1818 he traced the Macquarie River to its junction with the Darling. In the volume of his narrative are brief references to the occurrences of different rocks, amongst which the more noteworthy are coal at Port Macquarie Harbour, coal indications at the head of the Macleay River, and limestone at Limestone Creek on the Lachlan, and at Wellington Valley on the Macquarie, "which is the first that has hitherto been discovered in Australia." The geological specimens which were collected during the two expeditions were reported on by Dean Buckland as affording indications of primitive rocks (granite, mica, slate, clay-slate, and serpentine), trap, and limestone (resembling the transition limestone of England), as also those gathered by Robert Brown on the Hunter River, which are described as coal and shale with plant impressions, and the author states that there is analogy between the coal formation of the Hunter River and that of England, whilst certain fossiliferous rocks from Hobart are nearly, if not quite, identical with those of the mountain limestone of England and Ireland. This is the first application of palæontology to the stratigraphical chronology of the Australian rocks, and a successful one, as the positions assigned by Buckland to the two formations are substantially those accepted by the local geologists of to-day. Scott (Rev. Archdeacon) refers to the strata of the Newcastle coalfield as the "coal formation," and to the limestone as resembling in the character of its organic remains the "mountain limestone" of England, and thus independently arrived at the same conclusions as Buckland.

Jesson, the naturalist to the French surveying ship, *La Coquille*, and author of the history of the voyage during the years 1822-25, describes the geological features about Port Jackson. His arrangement is a great advance on prior contributions, as it establishes a definite successional order of deposits, and for the first time, though foreshadowed by his countryman Bailly,

the superposition of the Sydney sandstone on the coal measures, and of the coal measures on the granites, is recognised. Up to this date no described fossil had been referred to as occurring in Australian deposits, and it was not till 1828 that Alex. Brongniart described *Glossopteris bronwniana* and *Phyllothea Australis* from the Newcastle coal measures.

Sturt, in 1829, on his passage down the Murray, arrived at Overland Corner, and noted the sudden change from cliffs of sand and clay to fossiliferous limestone, which continued uninterruptedly to Lake Alexandrina. Sturt referred examples of the fossil mollusca, echinoids, and polyzoa, to species of the Eocene of England, Paris, and Westphalia, and thus established by similarity of organic remains, an old tertiary formation in Australia.

Mitchell (Major, afterwards Sir Thomas), in 1832 penetrated north, and reached the River Darling. His western limit in 1835 was the junction of the rivers Bogan and Darling, and the southern, in 1836, was Portland Bay. The chief geological facts recorded by Mitchell are: (1) That the higher ground about the sources of the tributary of the Murrumbidgee is composed of granite, on the flanks of which rests a fossiliferous limestone "much resembling the carboniferous of Europe," and another limestone containing corals belonging to the genus Favosites, and crinoids; (2) in Victoria, north of the divided range, granites and syenites are signalled, and clay slate on the river Campaspe; (3) the lower part of the Glenelg River and the coast districts as far as Portland Bay are occupied with a fossiliferous tertiary formation, frequently interrupted by trap and vesicular lava; hills of lava often occur, and one at least, Mount Napier, is described as still exhibiting a perfect circular crater.

The palæontological collections, which were made during Mitchell's three expeditions, were deposited in the British Museum, and reported on by specialists. The results appended to Mitchell's work demonstrated the presence of representatives of the following life epochs: Carboniferous and Mesozoic. The collection included also a portion of the guard of a belemnite obtained near Mount Abundance. Its occurrence is noted on Mitchell's chart, though not referred to in the letter-press. This is the first secondary fossil recorded for Australia, though it was not till 1880 that it was brought to scientific notice.

*Diprotodon Period.*—The ossiferous caves of the Wellington Valley and at Buree were discovered by Mitchell in 1830, and an account of the survey of them was published in 1831. In 1835 more extended researches were undertaken, and the particulars respecting the animal remains then found were supplied by Owen (afterwards Sir Richard), who demonstrated that the existing marsupial fauna was preceded in the same area in later tertiary times by a similar one, differing specifically for the most part, and to some extent, generically; some of them presenting colossal forms in comparison with their largest modern representatives; such are *Diprotodon* and *Nototherium*. This early work of Owen's was only the commencement of those investigations which culminated in that monument of marvellous industry and talent, the "Fossil Mammals of Australia." Charles Darwin was naturalist to the surveying ship, the *Beagle*, on her second voyage, 1832-36. The *Beagle*, on her homeward passage, called at Sydney and King George's Sound, and the geological observations relating to those places are brief, and, to a large extent, had been anticipated by Mitchell in respect of the first, and by Peron as to the second, though in the latter connection Darwin corrected some of the erroneous observations recorded by Vancouver and Flinders. Lonsdale describes some Australian carboniferous polyzoa, and Sowerby some Spiriferidæ, and we have thus another instance of the early application of palæontology to the determination of the correlative age of stratified deposits.

Lieutenant Grey (now Sir George) was commissioned to explore the coastline between Prince Regent River and Swan River. In 1839 he was shipwrecked in Gantheaume Bay, and his party was forced to make an overland journey to Perth, in the course of which he discovered the Murchison and other rivers, and carboniferous rocks in the Victoria Range.

Commander Wickham was commissioned in 1837 to the *Beagle's* third voyage, but in consequence of his retirement in March, 1841, owing to ill-health, the command devolved on Captain Stokes, who is the author of the narrative of the six years' voyage. The objects of the survey did not permit of any connected observations of the geological structure of the islands or coast, and though the author disclaims any pretensions to be versed in geological science, yet some of his

recorded observations have the merit of discoveries which have stood the test of critical investigation. The escarpment of the table-land of Arnhem Land is described as constituted of horizontally-bedded sandstone overlying slaty rock; a somewhat similar arrangement is noticed at Tale Head and Fort Hill, Port Darwin; the covering, fine-grained sandstone, the stratigraphical position of which was first observed by Stokes, has lately acquired considerable importance by the discovery of Radiolarians within its mass.

Strzelecki (Count).—To this highly accomplished man of science we are greatly indebted for arduous and gratuitous researches and labours in the field of Australian geology, the outcome of five years' travel, commencing from his traverse of Gippsland in 1840, and embracing the survey of 7,000 miles. The rocks of New South Wales he arranges in an ascending successional series, and in this first attempt to construct a table of the stratified deposits of New South Wales he laid the foundation of stratigraphical geology in Australia. Strzelecki's volume is accompanied by a map in which the areas occupied by each epoch are indicated by colours, and is the first attempt at geological mapping in Australia.

Leichardt (Dr. Ludwig).—In 1844 this lamented traveller started on his adventurous journey from Moreton Bay to Port Essington, a distance of 3000 miles. The narrative of Dr. Leichardt contains as much botany as geology. The accompanying maps and illustrations supply important information respecting the physiographic and geologic features. Necessity compelled him to abandon one portion after another of his collections, so that the opportunity of determining the age of the various deposits encountered, from the nature of their fossil contents, was lost. This is much to be regretted, because for long years this line of country was geologically known only through Leichardt's memoranda, which still contain for some portions the only information extant.

Dana (Prof. James D.) was naturalist to the United States exploring expedition during the years 1838-42, under the command of Charles Wilkes. Sydney was visited in 1839-40, but as the geology of the expedition was not published till 1849, Dana's observations were to some extent anticipated. Nevertheless, the credit must remain to Dana of having laid the foundation of the classification of the great carboniferous development in New South Wales, both in respect of its palæontology and stratigraphy.

Sturt (Captain Charles), in 1844, under the authority of the Imperial Government, pushed into the central parts of Australia. From the River Darling, at what is now Menindie, he reached the Barrier and Grey Ranges, and became entangled in the delta-like ramifications of the River Cooper; thence he penetrated in a north-west direction into the sand-dune country to the north-east of Lake Eyre, and thus missed the object of his ardent search. Sturt describes the general structure of the Barrier Range as of slates, gneiss, and other metamorphic rocks, and notes the prevalence of iron ores. In one case he describes what is evidently the ironstone outcrop of a massive mineral lode, and though I cannot identify the locality, yet it is not at all improbable that one of the silver lodes of the Barrier (if not Broken Hill itself) is here referred to; in the same connection that prominent landmark, Piesse's Knob, is indicated. The most noteworthy observations recorded by Sturt are those relating to the physical character of the interior of Australia, which will be considered hereafter. A tribute is due to Sturt's scientific merit and sagacity, and I would add my mite to the general testimony of admiration for that learned traveller; he stands pre-eminent among land explorers for the accuracy of his observations—evincing the most patient and thoughtful investigation—for the great power of generalisation which throws a charm over all his narratives, and for his highly philosophical deductions. Sturt never received that honour in his lifetime which was his due; and much of his geological work and speculations have either been overlooked or ignored, because it was thought, by reason that geology then was not in a very advanced state, he was not a very experienced geologist. In his work, "A Sketch of the Physical Structure of Australia" (1850), the author gives a connected outline of the geology of Australia, so far as it was known to him. The great merit of this attempt to exhibit approximately the principal features of this continent is that of piecing together the isolated observations of previous authors into a connected outline, which, because of his personal knowledge of considerable portions of the coastline of Australia, he was, of all others, the best able to do successfully,

The result is a general but distinct notion of the geological structure of Australia, which is further illustrated by a geologically-coloured map, the first on so broad a survey. The author added nothing to our previous knowledge, but systematised what was known, and the speculations and generalisations which he ventured have, for the most part, proved correct. Some of the most valuable contributions of later authors will be found to have been foreshadowed, or even clearly noted, by Jukes, whilst some actual discoveries were anticipated by him.

The last of the maritime surveys under Imperial direction which concerned Australia was that conducted by Captain Owen Stanley, of H.M.S. *Rattlesnake*; it is also noteworthy from the high scientific attainments of its officers. The commander, who was the only son of Dean Stanley, an eminent ornithologist, took a keen interest in natural history; he died soon after the final return of the ship to Sydney, from a severe illness, contracted during the last cruise, but after the successful accomplishment of the chief object of his mission. The assistant-surgeon was Thomas H. Huxley, a name familiar to all, who achieved fame at this early period of his career by the zoological researches made during the voyage.

A. C. Gregory.—The discouraging character of the interior of Australia, as made known by Sturt, and the utter disappearance of Leichardt's expedition of 1848, checked the progress of exploration for a few years; but in 1855 a successful effort was made to penetrate the interior from the north-west by the North Australian expedition, which was fitted out by the Imperial Government, and was the last of the series. The expedition was placed under the leadership of Mr. A. C. Gregory, who was accompanied by Dr. (now Baron Sir F. von) Mueller as botanist. The Victoria River was ascended to its source, and the country to the south of the Dividing Range was explored beyond the northern limits of the great interior desert. The physiographic features of the Lower Victoria had been made known by the descriptions of Stokes: the region about the Upper Victoria was found to consist chiefly of extensive valleys of good soil, well grassed, and of more arid sandstone table-land, varied with outcrops of basalt, constituting rich grassy downs. The table-land rises abruptly from the coastal tracts. By removal of the upper strata deep gorges 600 feet in height are formed, which open out into large valleys or plains. Mr. Gregory struck across from the Lower Victoria to the head of Roper River, and thence followed the base of the table-land from which he had descended, passing near the sources of the rivers discharging into the Gulf of Carpentaria. From the Albert River to Brisbane he followed Leichardt's route of 1844. This extraordinary achievement is second to none in point of interest of unknown country traversed, and of the scientific results gained, a vast void in the geological map was filled in. Since Gregory's expedition the interior of Australia has been traversed in various directions; and with such efforts are honourably associated the names of Stuart, Burke and Wills, Warburton, Giles, J. Forrest, &c., but the geological gain has been of a purely local importance. I may therefore be pardoned if I make exception by the mention of the expedition recently fitted out by Sir Thomas Elder. The object—to fill up the blank spaces in the topographical and geological maps of Australia—was ambitious, and the scientific equipment of the expedition gave hope that permanent results would be gained, but its premature disbandment has indefinitely protracted the realisation of this cherished consummation. So far as the area traversed is concerned, a very great deal was accomplished. It was a failure simply by reason of the limitation of the original scheme. In geology nothing new has been brought to light, though certainty has replaced previous guesswork or speculation. Nevertheless, such problems as the exact relation of the fossiliferous Silurian to those of older date, the stratigraphy and fossils of the marine Cretaceous, and its relation to the supra-cretaceous rocks, still await solution. The geologist to the expedition has done his work so conscientiously and thoroughly, that the poverty of his report is to be ascribed to nature's deficiency. In other departments of natural history our expectations have been satisfactorily realised. May we hope that the Australian Mæcenas of our time will crown his efforts to unfold some of the mysteries of our dry interior by directing a systematic exploration of some well-defined area, such as the oasis of the MacDonnell Range.

The year of 1851 marks an epoch in the history of Australia, because in that year the rich goldfield of Ophir was discovered. Gold was scientifically discovered by Strzelecki, in 1839, and by

Clarke in 1841, though its existence would appear to have been known as early as 1823. In 1844, without being aware of these discoveries, Sir Roderick Murchison pointed out the similarity of the rock structure of the eastern cordillera of Australia to that of the Ural Mountains, and predicted the occurrence of gold. Subsequent events afforded a proof that geology, like the more exact sciences, is capable of advancing philosophical inductions to very important results. But the precious metal was not commercially discovered, so to speak, till 1851, by Hargreaves, who had spent some of his earlier years as a stock-raiser in Eastern Australia; in 1849 he was gold mining in California, and his experiences there gained convinced him of the similarity in structure of the auriferous rocks of California and certain districts in New South Wales. He revisited New South Wales early in 1851, to put to the test his geological instinct and the accuracy of his observations; in this he succeeded, and ultimately, under Government direction, the gold-field of Ophir in the district of Bathurst was declared open. He was awarded £10,000 for his discovery, and in 1876 a pension was granted him. He died in 1891, at the age of 75 years. The practical discovery of gold proved a source of an enormous amount of wealth to New South Wales, and was soon followed in the same year by the discovery of much richer goldfields in Victoria, which had just then been separated into an independent colony, and thus added a powerful factor to the economic and scientific advancement of the continent. The consequent stimulus to a higher intellectual culture resulted in the foundation of the Universities of Sydney and Melbourne, and the establishment of systematically organised geological surveys. By the concurrence of the memorable events just alluded to, the history of geological progress enters a new period. Up to 1854 our exact knowledge of the sedimentary deposits, as derived from the organic remains, was confined to the Carboniferous, to a late Tertiary (represented by the Diprotodon period), and a more recent Eolian formation; no distinct identification to prove the existence of Upper Silurian, Devonian, or Eocene had been forthcoming, though it was implied, whilst the only evidence of a Mesozoic epoch was a single imperfect example of a Belemnite. Restricted means of communication in a vast extent of country was the main cause which retarded advancement in geological investigation; with increasing population this barrier is gradually being removed. Expansion of our pastoral occupation, and the opening out of new trade routes bring new fields within the horizon of geological vision. It is, therefore, not a matter for surprise that in the next decade great and rapid advances were made in establishing a comparison on palæontological grounds with corresponding geological systems of Europe. The history of geological progress in the second half-century is mainly that of the geological surveys, and the chronological treatment of my subject must be abandoned at this stage.

It is a general impression that Australia is a very old continent; undoubtedly it is, because it presents an equal range of the geological record as other continental masses. But this impression is based on illogical deduction, derived solely from the fact that certain characteristic types of the Jurassic fauna of the northern hemisphere still linger in the Australian area, such as *Trigonia*, *Ceratodus*, and Marsupials among animals, Cycads and certain Conifers among plants. But the physiographic aspects of Australia have not always been absolutely continental. Since Upper Devonian times there have always been land-surfaces, at any rate in Eastern Australia, where partial interruption to an absolute continuity (and the area locally affected is not relatively great) was frequent during the deposition of the Carboniferous series, which is, however, in a large measure littoral. It may safely be asserted that Australia, verily so far back as the deposition of the extensive marine Cretaceous occupying the low level tracts of the interior, preserved the aspect of a vast archipelago. At the close of that epoch the various insular masses became welded together, so that the antiquity of Australia as a whole is only post-Cretaceous. In early Eocene or late Cretaceous times, the flora was of a cosmopolitan type, consisting of an admixture of generic forms, some of which are now proper to the temperate and sub-temperate parts of the northern hemisphere, such as oaks, birch, alder, &c., and others exclusively Australian, such as eucalypti, banksias, Araucarias, &c. The differentiation of the Australian flora has therefore been brought about during the post-Eocene times. The antiquity of Australia, as inferred from its almost exclusive marsupial types, is erroneous, because there is every reason to doubt the correctness of the statement thereby implied that

marsupials originated in Australia. Despite the recurrences of land surfaces from late Palæozoic times to the present day—and it is not improbable that some of them may have been permanent throughout, or for a greater part of that long interval—yet no marsupials as old as those of Europe and North America have yet been found; neither its coaly strata nor its ancient lake basins have yielded any of the higher types of fluviatile or terrestrial vertebrates. Indeed, the only instance of a fossil representative of the Marsupialia older than Pliocene in the Australian area is that of a diprotodontoid in the Eocene beds at Table Cape, Tasmania; whereas we must look for a polyprotodontoid as the early ancestor of the class. Recent researches point to South America as the area from which the Australian marsupial fauna has probably been derived, which possesses in the Eocene marsupial fauna close alliances with certain existing polyprotodontoid types in Australia.

#### A DYNAMICAL THEORY OF THE ELECTRIC AND LUMINIFEROUS MEDIUM.<sup>1</sup>

##### II.

THE next stage in this mode of elucidation of electrical phenomena is to suppose, once the current is started in our non-dissipative circuit, that both the condensers are instantaneously removed, and replaced by continuity of the wire. We are now left with a current circulating round a complete perfectly conducting channel, which in the absence of viscous forces will flow round permanently. The expression for the kinetic energy in the field is easily transformed from a volume integral of the magnetic force, which is represented by the velocity of the medium  $\frac{d}{dt}(\xi, \eta, \zeta)$ , to an integral involving the current  $\frac{d}{dt}(f, g, h)$ , which is in the present case a line integral round the electric circuit. The result is Franz Neumann's celebrated formula for the electro-magnetic energy of a linear electric current,

$$T = \frac{1}{2} \mu^2 \iint r^{-1} \cos \epsilon \, d\zeta \, d\zeta';$$

or we may take the case of several linear circuits in the field, and obtain the formula

$$T = \frac{1}{2} \Sigma \mu^2 \iint r^{-1} \cos \epsilon \, d\zeta \, d\zeta' + \Sigma \mu_1 \mu_2 \iint r^{-1} \cos \epsilon \, d\zeta_1 \, d\zeta_2,$$

which is sufficiently general to cover the whole ground of electro-dynamics.

Our result is in fact that a linear current is a vortex ring in the fluid æther, that electric current is represented by vorticity in the medium, and magnetic force by the velocity of the medium. The current being carried by a perfect conductor, the corresponding vortex is (as yet) without a core, *i.e.* it circulates round a vacuous space. The strength of a vortex ring is, however, permanently constant; therefore, owing to the mechanical connections and continuity of the medium, a current flowing round a complete perfectly conducting circuit would be unaffected in value by electric forces induced in the circuit, and would remain constant throughout all time. Ordinary electric currents must therefore be held to flow in incomplete conducting circuits, and to be completed either by convection across an electrolyte, or by electric displacement or discharge across the intervals between the molecules, after the manner of the illustration given above.

Now we are here driven upon Ampère's theory of magnetism. Each vortex-atom in the medium is a permanent non-dissipative electric current of this kind, and we are in a position to appreciate the importance which Faraday attached to his discovery that all matter is magnetic. Indeed, on consideration, no other view than this seems tenable; for we can hardly suppose that so prominent a quality of iron as its magnetism completely disappears above the temperature of recalcinescence, to reappear again immediately the iron comes below that temperature; much the more reasonable view is that the molecular rearrangement that takes place at that temperature simply masks the permanent magnetic quality. In all substances other than the

<sup>1</sup> A paper read before the Royal Society on December 7, 1893, by Dr. Joseph Larmor, F.R.S., Fellow of St. John's College, Cambridge. (Continued from p. 262.)

magnetic metals, the vortex atoms pair into molecules and molecular aggregates in such way as to a large extent cancel each other's magnetic fields; why in iron at ordinary temperatures the molecular aggregates form so striking an exception to the general rule is for some reason peculiar to the substance, which, considering the complex character of molecular aggregation in solids, need not excite surprise.

We have now to consider the cause of the pairing together of atoms into molecules. It cannot be on account of the magnetic, *i.e.* hydrodynamical, forces they exert on one another, for two electric currents would then come together so as always to reinforce each other's magnetic action, and all substances would be strongly magnetic. The ionic electric charge, which the phenomena of electrolysis show to exist on the atom, supplies the attracting agency. Furthermore, the law of attraction between these charges is that of the inverse square of the distance, and between the atomic currents is that of the inverse fourth power; so that, as in the equilibrium state of the molecule these forces are of the same order of intensity and counteract each other, the first force must have much the longer range, and the energy of chemical combination must therefore be very largely electrostatic, due to the attraction of the ions, as von Helmholtz has clearly made out from the phenomena of electrolysis and electrolytic polarisation.

But in this discussion of the phenomena of chemical combination of atoms we have been anticipating somewhat. All our conclusions, hitherto, relate to the æther, and are therefore about electromotive forces. We have not yet made out why two sets of molecular aggregates, such as constitute material bodies, should attract or repel each other when they are charged, or when electric currents circulate in them; we have, in other words, now to explain the electrostatic and electrodynamic forces which act between conductors.

Consider two charged conductors in the field; for simplicity, let their conducting quality be perfect as regards the very slow displacements of them which are contemplated in this argument. The charges will then always reside on their surfaces, and the state of the electric field will, at each instant, be one of equilibrium. The magnitude of the charge on either conductor cannot alter by any action short of a rupture in the elastic quality in the æther: but the result of movement of the conductors is to cause a rearrangement of the charge on each conductor, and of the electric displacement (*f, g, h*) in the field. Now the electric energy *W* of the system is altered by the movement of the conductors, and no viscous forces are in action; therefore the energy that is lost to the electric field must have been somehow spent in doing mechanical work on the conductors; the loss of potential energy of the electric field reappears as a gain of potential energy of the conductors. We have to consider how this transformation is brought about. The movement of the conductors involves, while it lasts, a very intense flow of ideal electric displacement along their surfaces, and also a charge of actual displacement of ordinary intensity throughout the dielectric. The intense surface flow is in close proximity with the electric flows round the vortex atoms which lie at the surface; their interaction produces a very intense elastic disturbance in the medium, close at the surface of the conductor, which is distributed by radiation through the dielectric as fast as it is produced, the elastic condition of the dielectric, on account of its extreme rapidity of propagation of disturbances compared with its finite extent, being always extremely nearly one of equilibrium. It is, I believe, the reaction on the conductor of these wavelets which are continually shooting out from its surface, carrying energy into the dielectric, that constitutes the mechanical force acting on it. But we can go further than this; the locality of this transformation of energy, so far as any rate as regards the material force, is the surface of the conductor; and the gain of mechanical energy by the conductor is therefore correctly located as an absorption of energy at its surface; therefore the force acting on the conductor is correctly determined as a surface traction, and not a bodily force throughout its volume. One mode of representing the distribution of this surface traction, which, as we know, gives the correct amount of work for every possible kind of virtual displacement of the surface, is to consider it in the ordinary electrostatic manner as a normal traction due to the action of the electric force on the electric density at the surface; we conclude that this distribution of traction is the actual one. To recapitulate: if the dielectric did not transmit disturbance so rapidly, the result of the commotion at the surface produced by the motion

of the conductor would be to continually start wavelets which would travel into the dielectric, carrying energy with them. But the very great velocity of propagation effectually prevents the elastic quality of the medium from getting hold; no sensible wave is produced and no flow of energy occurs into the dielectric. The distribution of pressure in the medium which would be the accompaniment of the wave motion still persists, though it now does no work; it is this pressure of the medium against the conductor that is the cause of the mechanical force.

The matter is precisely illustrated by the fundamental experiment of Sir George Stokes with regard to the communication of vibrations to the air or other gas. The rapid vibrations of a tuning fork are communicated as sound waves, but much less completely to a mobile medium like hydrogen than to air. The slow vibrations of a pendulum are not communicated as sound waves at all; the vibrating body cannot get a hold on the elasticity of the medium, which retreats before it, preserving the equilibrium condition appropriate to the configuration at the instant; there is a pressure between them, but this is instantaneously equalled throughout the medium as it is produced, without leading to any flow of vibrational energy.

Now let us formally consider the dynamical system consisting of the dielectric media alone, and having a boundary just inside the surface of each conductor; and let us contemplate motions of the conductors so slow that the medium is always indefinitely near the state of internal equilibrium or steady motion, that is conditioned at each instant by the position and motion of the boundaries. The kinetic energy *T* of the medium is the electrodynamic energy of the currents, as given by Neumann's formula; and the potential energy *W* is the energy of the electrostatic distribution corresponding to the conformation at the instant; in addition to these energies we shall have to take into account surface tractions exerted by the enclosed conductors on the medium, at its boundaries aforesaid. The form of the general dynamical variational equation that is suitable to this problem is, for currents in incomplete circuits, and therefore acyclic motions,

$$\delta \int (T - W) dt + \int dt \int \delta w dS = 0,$$

where  $\delta w dS$  represents the work done by the tractions acting on the element *dS* of the boundary, in the virtual displacement contemplated. If there are electromotive sources in certain circuits of the system, which are considered to introduce energy into it from outside itself, the right-hand side of this equation must also contain an expression for the work done by them in the virtual displacement contemplated of the electric coordinates. Now this variational equation can be expressed in terms of any generalised coordinates whatever, that are sufficient to determine the configuration in accordance with what we know of its properties. If we suppose such a mode of expression adopted, then, on conducting the variation in the usual manner and equating the coefficients of each arbitrary variation of a coordinate, we obtain the formulæ

$$\Phi = \frac{d}{dt} \frac{dT}{d\dot{\phi}} - \frac{dT}{d\phi} + \frac{dW}{d\phi},$$

$$E = \frac{dW}{d\epsilon}.$$

In these equations  $\Phi$  is a component of the mechanical force exerted on our dielectric system by the conductors, as specified by the rule that the work done by it in a displacement of the system represented by  $\delta\phi$ , a variation of a single coordinate, is  $\Phi\delta\phi$ : the corresponding component of the force exerted by the dielectric system on the conductor is of course  $-\Phi$ . Also *E* is the electromotive force which acts from outside the system in a circuit in which the electric displacement is  $\epsilon$ , so that the current in it is  $\dot{\epsilon}$ ; the electromotive force induced in this circuit by the dielectric system is  $-\dot{E}$ .

These equations involve the whole of the phenomena of ordinary electrodynamic actions, whether ponderomotive or electromotive, whether the conductors are fixed or in motion through the medium: in fact, in the latter respect no distinction appears between the cases. They will be completed presently by taking account of the dissipation which occurs in ordinary conductors.

These equations also involve the expressions for the electrostatic ponderomotive forces, the genesis of which we have already attempted to trace in detail. The generalised component, corresponding to the coordinate  $\phi$ , of the electrostatic

traction of the conductors on the dielectric system, is  $dW/d\phi$ ; therefore the component of the traction, somehow produced, of the dielectric system on the conductors is  $-dW/d\phi$ .

The stress in the *æther* between two electrified bodies consists of a tangential traction on each element of area, equal in magnitude to the tangential component of the electric force at that place and at right angles to its direction. The stress in the *material* of the dielectric is such as is produced in the ordinary manner by the surface tractions exerted on the material by the conductors that are imbedded in it. The stress in the dielectric of Faraday and Maxwell has no real existence; it is, in fact, such a stress as would be felt by the surface of a conductor used to explore the field, when the conductor is so formed and placed as not to disturb the electric force in the dielectric. The magnetic stress of Maxwell is simply a mathematical mode of expression of the kinetic reaction of the medium.

The transfer of a charged body across the field with velocity not large compared with the velocity of electric propagation carries with it the whole system of electric displacement belonging to the body, and therefore produces while it lasts a system of displacement currents in the medium, of which the circuits are completed by the actual flow of charge along the lines of motion of the different charged elements of the body.

According to the present theory of electrification, a discharge of electricity from one conductor to another can only occur by the breaking down of the elasticity of the dielectric *æther* along some channel connecting them; and a similar rupture is required to explain the transfer of an atomic charge to the electrode in the phenomenon of electrolysis. We can conceive the polarisation increasing by the accumulation of dissociated ions at the two electrodes of a voltmeter, until the stress in the portion of the medium between the ions and the conducting plate breaks down, and a path of discharge is opened from some ion to the plate. While this ion retained its charge, it repelled its neighbours; but now electric attraction will ensue, and the one that gets into chemical contact with it first will be paired with it by the chemical forces; while if the conducting path to the electrode remains open until this union is complete, the ion will receive an opposite atomic charge from the electrode, which very conceivably may have to be also of equal amount, in order to equalise the potentials of the molecule and the plate. This is on the hypothesis that the distance between the two ions of a molecule is very small compared with the distance between two neighbouring molecules. A view of this kind, if thoroughly established, would lead to the ultimate averaging of atomic changes of all atoms that have been in combination with each other, even if those charges had been originally of different magnitudes. The assignment of free electric charges to vortex atoms tends markedly in the direction of instability; though instability under certain circumstances is essential to electric discharge, yet it must not be allowed to become dominant.

The presence of vortex atoms, forming faults so to speak in the *æther*, will clearly diminish its effective rotational elasticity; and thus it is to be expected that the specific inductive capacities of material dielectrics should be greater than the inductive capacity of a vacuum. The readiness with which electrolytic media break down under electric stress may be connected with the extremely high values of their inductive capacities, indicating very great yielding to even a small electric force.

In all that has been hitherto said we have kept clear of the complication of viscous forces; but in order to extend our account to the phenomena of opacity in the theory of radiation and of electric currents in ordinary conductors, it is necessary to introduce such forces and make what we can of them on general principles. It is shown that the introduction of the dissipation function into dynamics by Lord Rayleigh enables us to amend the statement of the fundamental dynamical principle, the law of Least Action, so as to include in it the very extensive class of viscous forces which are proportional to absolute or relative velocities of parts of the system. This class is the more important because it is the only one that will allow a simple wave to be propagated through a medium with period independent of its amplitude; if the viscous forces that act in light propagation were not of this kind, then on passing a beam of homogeneous light through a metallic film it should emerge as a mixture of lights of different colours. The viscous forces being thus proved by the phenomena of radiation to be derived from a dissipation function, it is natural to extend

the same conclusion to the elastic motions of slower periods than radiations, which constitute ordinary electric disturbances. We thus arrive, by way of an optical path, at Joule's law of dissipation of electric energy, and Ohm's linear law of electric conduction, and the whole theory of the electro-dynamics of currents flowing in ordinary conductors; though the presumption is that the coefficients which apply to motions of long period are not the same as those which apply to very rapid oscillations, the characters of the matter-vibrations that are comparable in the two cases being quite different. If it is assumed that the form of the dissipation function is the same for high frequencies as for low ones, we obtain the ordinary theory of metallic reflexion, which differs from the theory of reflexion at a transparent medium simply by taking the refractive index to be a complex quantity, as was done originally by Cauchy, and later for the most general case by MacCullagh. And, in fact, we could not make a more general supposition than this for the case of isotropic media; while for crystalline media the utmost generality would arise merely from assuming the principal axes of the dissipation function to be different from those of the rotational elasticity, a hypothesis which is not likely to be required.

The considerations which have here been explained amount to an attempt to extend the regions of contact between three ultimate theories which have all been already widely developed, but in such a way as not to have much connection with one another. These theories are Maxwell's theory of electric phenomena, including Ampère's theory of magnetism and involving an electric theory of light, Lord Kelvin's vortex-atom theory of matter, and the purely dynamical theories of light and radiation that have been proposed by Green, MacCullagh, and other authors. It is hoped that a sufficient basis of connection between them has been made out, to justify a restatement of the whole theory of the kind here attempted, notwithstanding such errors or misconceptions on points of detail as will unavoidably be involved in it.

Lord Kelvin has proposed a gyrostatic adynamic medium which forms an exact representation of a rotationally elastic medium such as has been here described.<sup>1</sup> If the spinning bodies are imbedded in the *æther* so as to partake fully in its motion, the rotational force due to them is proportional jointly to the angular momentum of a gyrostic and the angular velocity of the element of the medium, in accordance with what is stated above. But if we consider the rotators to be free gyrostatics of the Foucault type, mounted on gymbals of which the outer frame is carried by the medium, there will also come into play a steady rotatory force, proportional jointly to the square of the angular momentum of the gyrostic and to the absolute angular displacement of the medium. An ideal gyrostatic cell has been imagined by Lord Kelvin in which the coexistence of pairs of gyrostatics spinning on parallel axes in opposite directions cancels the first of these forces, thus leaving only a static force of a purely elastic rotational type. The conception of an *æther* which is sketched by him on this basis,<sup>2</sup> is essentially the same as the one we have here employed, with the exception that the elemental angular velocity of the medium is taken to represent magnetic force, and in consequence the medium fails to give an account of electric force and its static and kinetic manifestations. A gyrostatic cell of this kind has internal freedom, and therefore free vibration periods of its own; it is necessary to imagine that these periods are very small compared with the periods of the light waves transmitted through the medium, in order to avoid partial absorption. The propagation of waves in this *æther*, having periods of the same order as the periods of these free vibrations, would of course be a phenomenon of an altogether different kind, involving diffusion through the medium of energy of disturbed motion of the gyrostatics within the cells.

The electric interpretation of MacCullagh's optical equations, which forms the basis of this paper, was first stated by Prof. G. F. Fitzgerald (*Phil. Trans.*, 1880). An electric development of Lord Kelvin's rotational *æther* has been essayed by Mr. Heaviside, who found it to be unworkable as regards conduction-current, and not sufficiently comprehensive (*Phil. Trans.*, 1892, § 16; "Electrical Papers," vol. ii, p. 543). A method of representing the phenomena of the electric field by the motion of

<sup>1</sup> Lord Kelvin (Sir W. Thomson), *Comptes Rendus*, September 16, 1839; "Collected Papers," vol. iii., 1890, p. 467.

<sup>2</sup> Lord Kelvin (Sir W. Thomson), "Collected Papers," vol. iii., 1890, pp. 436-472.

tubes of electric displacement has been developed by Prof. J. J. Thomson, who draws attention to their strong analogies to tubes of vortex motion ("Recent Researches . . .," 1893, p. 52).

Prof. Oliver Lodge has kindly looked for an effect of a magnetic field on the velocity of light, but has not been able to detect any, though the means he employed were extremely searching; the inference would follow, on this theory, that the motion in a magnetic field is very slow, and the density of the medium correspondingly great.

#### UNIVERSITY AND EDUCATIONAL INTELLIGENCE.

OXFORD.—The lectures announced by the various departments of Natural Science are for the most part a continuation of the courses given during the last term. In all, thirty-two separate courses of lectures are announced, nine in Physics, eight in Chemistry, two in Geology, four in Animal Morphology, four in Physiology, two in Botany, and three in Anthropology. The Hope Professor of Zoology, Mr. E. B. Poulton, is absent from Oxford this term, and the charge of the collection devolves on his assistant. In addition, Mr. Hatchett Jackson has consented to give any information that may be required respecting the Hope Collections.

The next examination for admission to a Radcliffe Travelling Fellowship will be held on March 1. Candidates are required to have obtained a first class in one of the honour schools, or to have gained an open University prize or scholarship, and to undertake a course of medical study with the view of proceeding to a medical degree.

CAMBRIDGE.—Mr. J. E. Purvis, of St. John's College, has been appointed Assistant to the Professor of Chemistry in the room of Mr. H. Robinson, who died on January 4. Mr. Robinson had held his office for sixteen years, and had, with Prof. Liveing and independently, conducted a number of important researches. Those on lanthanum and didymium, and on certain points in bacteriological chemistry deserved greater notice than they received. Mr. Robinson's work in agricultural chemistry, in which he was an expert, will be carried on by Mr. T. B. Wool, of Caius College. Dr. Lorrain-Smith and Dr. Wesbrook, John Lucas Walker Students in Pathology, will this term conduct, in Prof. Roy's laboratory, a new course of instruction in pathological chemistry. The lectures will be given on Mondays and Saturdays at noon, beginning on January 20. Mr. H. Yule Oldham, University Lecturer in Geography, will resume his lectures in physical geography on Thursdays at noon in the lecture theatre of the chemical laboratory; and will give informal instruction and assistance to students of geography in King's College on the same days at six o'clock. The election to the £100 studentship, offered by the Council of the Royal Geographical Society for members of the University attending the lectures, will be held on March 12.

An influential deputation, representing the University Colleges of Wales, waited upon the Chancellor of the Exchequer on Friday last, to ask for an annual grant of £3,000 to the new Welsh University. In reply, Sir W. Harcourt said he would request the Government to grant the request for the present year, but he could promise nothing for the future.

#### SCIENTIFIC SERIALS.

*Bulletin de l'Académie Royale de Belgique.*—Stas's determinations of atomic weights, by E. Vogel. In spite of Stas's conclusion that the atomic weights of the elements have no common measure, Prout's hypothesis has recently been regaining ground. Hinrichs's experiments have thrown doubt upon Stas's atomic weight determinations; and the suppositions made by Stas himself place it beyond doubt that all his atomic weights without exception are inaccurate. The cause of the great discrepancies in the values found by Stas himself lies in the variation of the weights of the substances taken. When to a solution of an alkaline chloride is added nitrate of silver to slight excess, a precipitate will be formed on adding more chloride. But experiment shows that a precipitate is also formed on adding more nitrate, up to a certain limit which

Mulder termed the limit of silver, as distinguished from the limit of salt for the addition of the chloride. The author shows that the true atomic weight cannot be derived from the mean between these two limits, and proves from Stas's own data that they may be equally well interpreted for entire as for fractional multiples of the atomic weight of hydrogen.—Chronometric determinations relating to the regeneration of nerves, by C. Vanlair. The experiments, conducted by the physiological method, were made upon a motor nerve, the facial, a nerve whose simultaneous bilateral section is inconsistent with life, the pneumogastric, and a mixed sensory nerve, the sciatic. The right facial nerve of an adult rabbit, the two inferior branches of which were cut as they emerged from the parotid, required eight months for their regeneration. The right pneumogastric of an adult dog was cut in June 1889, and the left, one year afterwards. In August, 1891, the right nerve was cut again, but, after some initial troubles, the dog's health remained perfect throughout. Since the simultaneous section of the two branches is invariably fatal, it follows that during the time intervening between the sections the branch last cut must have reunited. This gives a velocity of reproduction of 3 c.m. per month, or 1 mm. per day. In the dog, and doubtless also in man, nervous regeneration, undisturbed by any accidental obstacle, takes place with an almost perfect chronological regularity. The average time necessary for initial proliferation is about forty days. For a section of about 1 c.m. length, the development of the new fibres takes place at a rate of 0.25 mm per day. The speed is greater at 2 c.m. but decreases again for greater lengths in proportion to such lengths.

*Mémoires de la Société d'Anthropologie de Paris*, Tome i. (3e Série) 1er Fascicule.—A new series of the memoirs of the Anthropological Society of Paris commences with this number, and opportunity has been taken to introduce a few modifications into the manner of their publication. In future each memoir will be pagged separately, and will be sold at the price of three centimes a page. This part contains an essay by M. A. Dumont, on the birth rate in the canton of Beaumont-Hague. The author says that France is menaced by five great perils: (1) Foreign invasion; (2) advance of plutocracy; (3) increase of clericalism; (4) lowering of the birth-rate; (5) increase of rural emigration. With regard to these last two dangers, it is of the utmost importance to determine their extent, their causes, and their remedies. The tables given by the author show that in almost all the villages in the canton of Beaumont-Hague the population has steadily diminished within the last sixty years, in some cases as much as fifty per cent., and this large diminution of population appears to result from the excess of the death rate over the birth rate. In one parish only has the population increased, and this has been due to the fact that a number of those employed in the Government works at Cherbourg have taken up their residence here within the last few years since 1886. M. Dumont discusses at length the causes of the very low birth rate throughout the canton, and comes to the conclusion that it is closely connected with the emigration of the more well-to-do inhabitants, and that increase in population is in inverse proportion to individual effort for personal advancement.

#### SOCIETIES AND ACADEMIES.

**Royal Society**, Dec. 14, 1893.—"Sugar as a Food in the Production of Muscular Work." By Dr. Vaughan Harley.

In the above paper the author first gave the chemical reasons that led him to believe that sugar was the principal factor in the production of muscular energy.

He then went on to prove that it could be experimentally demonstrated that the addition of large quantities of sugar to the diet caused an increased capability of doing muscular work.

By means of the ergograph it was possible to estimate the amount of work accomplished under various circumstances by the middle finger of each hand, weights of 3 and 4 kilogrammes being raised. The total height to which the weight was lifted, being multiplied by the weight used, expressed in kilogramme metres the amount of work accomplished.

The first step was to ascertain the value of sugar when taken alone in the production of muscular work. During a twenty-four hours' fast, on one day, water alone was drunk; on another, 500 grammes of sugar was taken in an equal quantity of water. It was thus found that the sugar not only prolonged the time

before fatigue occurred, but caused an increase of 61 to 76 per cent. in the muscular work done.

In the next place, the effect of sugar added to the meals was investigated.

The muscle energy producing effect of sugar was found to be so great that 200 grammes added to a small meal increased the total amount of work done from 6 to 39 per cent.

Sugar (250 grammes) was now added to a large mixed meal, when it was found not only to increase the amount of work done from 8 to 16 per cent. but increase the resistance against fatigue.

As a concluding experiment, 250 grammes of sugar was added to the meals of a full diet day; causing the work done during the period of eight hours to be increased 22 to 36 per cent.

Mathematical Society, January 11.—Mr. A. B. Kempe, F.R.S., President, in the chair.—The President communicated to the members present the intelligence which had just reached him of the death of Dr. H. K. Hertz, an honorary member of the society. The following communications were made:—"The Types of Wave-motion in Canals," by Mr. H. M. Macdonald; "On Green's Function for a System of Non-intersecting Spheres," by Prof. W. Burnside, F.R.S.

PARIS.

Academy of Sciences, January 8.—M. de Lacaze-Duthiers in the chair.—Studies on the formation of carbon dioxide and the absorption of oxygen by the detached leaves of plants, by MM. Berthelot and G. André. The authors have studied, under the most varied conditions, wheat, *Sedum maximum*, and *Corylus avellana*. Carbon dioxide is evolved from leaves in the absence of oxygen, but much more in the presence of oxygen and moisture. More oxygen is absorbed than is required for the production of the excess of carbon dioxide produced in an oxidising atmosphere. These reactions only occur in the presence of water.—Remarks on a note by M. Duncr, entitled "Is there Oxygen in the Atmosphere of the Sun?" by M. J. Janssen. The author considers M. Duncr's method unable to decide this question, and quotes experimental evidence to show that the effects considered are terrestrial.—Conclusions relative to the manipulation of the soil of oyster parks, and as to the causes of oysters becoming green, by MM. Ad. Chatin and A. Muntz.—On the approximate expressions for the higher terms in the development of the perturbation function, by M. N. Coculesco.—On the influence exercised by solar spots on the quantity of heat received by the earth, by M. R. Savéclief. The author discusses the relationship of the activity of the solar surface and the calorific intensity of the solar radiation at the limits of the atmosphere, and draws the conclusion that with increase of solar activity, as evidenced by increase in the number of sunspots, there is increase of calorific intensity.—Thermodynamics of gases. Comparative values of the approximations of Joule's law and of Mariotte's and Gay-Lussac's laws, by M. Jules Andrade. Joule's law and Mariotte's and Gay-Lussac's laws are obeyed by gases within limits of the same order of magnitude.—The law of the magnetisation of soft iron, by M. P. Joubin. The author compares the formulæ representing the intensity of magnetisation of soft iron, in terms of the strength of field and the susceptibility of the material, with Van der Waal's formula for fluids, and concludes that the phenomena of the magnetisation of iron are analogous to the phenomena presented by a saturated fluid, and might be calculated by similar formulæ. Feebly magnetised bodies obey laws analogous to those of fluids far from their points of saturation.—On the absolute value of the magnetic elements on January 1, 1894, by M. Th. Moureaux. The values are given for Parc Saint-Maux and Perpignan.—On the composition of aqueous solutions, according to their indices of refraction, by M. Paul Bary. From the examination of a series of dilute solutions of metallic salts the result is deduced "that, if the theory of M. Arrhénius is admitted, the dissociated salts behave with regard to refraction as if the dissociation does not exist."—Researches on the chemical action of *abrostol* (calcium naphthylsulphonate) on wine, by M. Scheurer-Kestner.—On the presence of poison glands in adders, and on the poisonous properties of the blood of these animals, by MM. C. Phisalix and G. Bertrand. The poisonous principles of adder's blood proceed from the internal secretion of the superior labial glands, and the similarity of these principles to echidnine explains the immunity of the adder for viper poison.—Nitrates in living plants, by M. Demoussy.

—On the influence of light and altitude on the striation of the valves of diatomacæ, by Frère J. Héribaud.—The insertion of the spores and the direction of the partitions in protobasidia, by M. Paul Vuillemin.

BOOKS, PAMPHLETS, and SERIALS RECEIVED.

Books.—Geological Survey of Canada, Annual Report, Vol. v. 2 Parts and Maps (Ottawa)—Human Physiology: J. Thornton (Longmans)—The Elements of Co-ordinate Geometry: W. Briggs and J. H. Bryan, Part 1, 2nd Edition (Clive).—Illustrated Guide to British Mosses: H. G. Jameson (Eastbourne, the Author).—A Text-book of Solid or Descriptive Geometry: A. B. Dobbie (Blackie).—A Pocket-Book of Marine Engineering, Rules and Tables: A. E. Seaton and H. M. Rounthwaite (Griffin).—Do you Know it? &c. C. E. Clark (Saxon).—Annuaire de l'Académie Royale des Sciences, &c., de Belgique, 1894 (Bruxelles).—Forschungsberichte aus der Biologischen Station zu Ploën; Theil 2: Dr. O. Zacharias (Berlin, Friedländer)—Elements of Synthetic Solid Geometry: Prof. N. F. Dupuis (Macmillan).—Electric Waves: Dr. H. Hertz, translated by D. E. Jones (Macmillan).—Discovery of Lakes Rudolf and Stefanie, 2 Vols.: Lieut. L. von Höhnel, translated (Longmans). PAMPHLETS.—Guide to the Examinations in Agriculture, and Answers to Questions, Advanced Series (Blackie)—Ditto, Physiology, Elementary Series (Blackie)—Ditto, Elementary Metallurgy, ditto (Blackie).—Ditto, Elementary Principles of Mining, ditto (Blackie).—Ditto, Chemistry, ditto (Blackie)—Test Papers in Mathematics: R. Roberts (Blackie).—Twenty-third Report of the Aeronautical Society of Great Britain (Greenwich, Richardson).—Report on the Destruction of Beer-casks in India by the Attacks of a Boring Beetle: W. F. H. Blandford (Eyre and Spottiswoode).—The Palm Weevil in British Honduras: W. F. H. Blandford (Eyre and Spottiswoode).—Annales de l'Observatoire Magnétique de Copenhague 1892: A. Paulsen (Copenhague). Entwurf einer Neuen Integralrechnung auf Grund der Potenzial-Logarithmal- und Numeralkrechnung. Zweites Heft: Dr. J. Bergbohm (Leipzig, Teubner). SERIALS.—Actes de la Société Scientifique du Chili, Tome 3, 1 and 2 Livr. (Santiago).—Engineering Magazine, Souvenir No. (New York).—Journal of Anatomy and Physiology, January (Griffin).—American Meteorological Journal, January (Ginn).—Himmel und Erde, January (Berlin).—Xenia Orchidacea, Dritter Band, Sechstes und Siebenies, Heft (Leipzig, Brockhaus).—Mnd, January (Williams and Norgate).—Bulletin Astronomique, December (Paris).

CONTENTS.

PAGE

Heinrich Hertz. By D. E. J. . . . . 265
Prof. Dr. Rudolf Wolf. By W. J. L. . . . . 266
Cloud Photography. (Illustrated.) . . . . 267
Letters to the Editor:—
The Directorship of the British Institute of Preventive Medicine.—Prof. Charles S. Roy, F.R.S. . . . . 269
Electromotive Force from the Light of the Stars.— Prof. George M. Minchin . . . . . 269
The Thyroid Gland. By R. M. . . . . 270
Notes . . . . . 270
Our Astronomical Column.—
Sunspots and Solar Radiation . . . . . 274
The Measurement of Stellar Diameters . . . . . 275
The Moon and Weather . . . . . 275
Geographical Notes . . . . . 275
A New Sulphide of Carbon. By A. E. Tutton . . . . . 275
Dr. Gregory's Journey to Mt. Kenia . . . . . 276
The Geology of Australia. By Prof. Ralph Tate . . . . . 277
A Dynamical Theory of the Electric and Luminiferous Medium. II. By Dr. Joseph Larmor, F.R.S. . . . . 280
University and Educational Intelligence . . . . . 283
Scientific Serials . . . . . 283
Societies and Academies . . . . . 283
Books, Pamphlets, and Serials Received . . . . . 284

SUPPLEMENT.

The Story of our Planet . . . . . iii
Cayley's Papers. By Major P. A. MacMahon, R.A., F.R.S. . . . . iv
The Pamirs. (Illustrated.) . . . . vi
The Genus Madrepora. By Prof. Alfred C. Haddon . . . . . ix
Physiological Chemistry. By Dr. J. S. Edkins . . . . . x
An Essay on Newton's "Principia" . . . . . xii
Wells on Engineering Design. By N. J. Lockyer . . . . . xiii
The Egyptian Collections at Cambridge . . . . . xiii
Horns and Hoofs . . . . . xiv



THURSDAY, JANUARY 25, 1894.

## RECENT PUBLIC HEALTH WORKS.

*A Treatise on Hygiene and Public Health.* By T. Stephenson, M.D., F.R.C.P., and Shirley F. Murphy. Vol. ii. (London: J. and A. Churchill, 1893.)

*Public Health and Demography.* By Edward F. Willoughby, M.D., D.P.H. (Macmillan and Co., 1893.)

*Methods of Practical Hygiene.* By Prof. K. B. Lehmann. Translated by W. Crookes, F.R.S. In two vols. (London: Kegan Paul, Trench, Trübner, and Co., Limited, 1893.)

IN our review of vol. i. of the "Treatise on Hygiene and Public Health," it was pointed out that the various articles comprising it were written by men whose knowledge and experience upon the subjects allotted to them for treatment was a sufficient guarantee of good work, and that any faults that the reviewer might possibly detect in the volume must almost of necessity be those of omission. To this second volume—which contains matter of the greatest possible interest and importance to the student and practitioner of preventive medicine—the same remarks apply. It is at least equal in all-round excellence to vol. i.; but here and there a few points might, in our opinion, have been more fully dealt with than they are, especially in a book which is destined to become essentially the work of reference for those interested in public health matters.

Article I treats of "The Pathology of Infectious Disease," and is written by Dr. Klein. This is an excellent *résumé* of what is undoubtedly the most important branch of preventive medicine, and it forms one of the best features of the book. No one can question the authoritative value of an article coming from such a source; and the fact that it is well written, and the various stages of the study are carefully arranged and treated of in admirable sequence, make this difficult subject both easy and pleasant reading. Appended to the article is a wealth of illustrations, comprising plates of a large number of cover-glass specimens of cultures of the different bacilli, all beautifully clear, and many coloured to show the characteristic staining of bacilli and fungi in tissues and fluids; sections through pathological tissues, &c.; specimens of blood, mucus flakes and pus, showing bacilli; representations of a large number of tube cultures—streak, stab, shake, and surface; cultures on potato, and plate cultures. We fancy that a few illustrations of the apparatus employed in bacteriological research would be acceptable, and we note that no mention is made of Haffkine's work in anti-choleraic vaccination; this might certainly have been included, notwithstanding the circumstance that a valuable piece of destructive criticism, emanating from Dr. Klein, has thrown considerable doubt upon the value of the method.

The article which very appropriately follows upon the first is contributed by Dr. T. W. Thompson, upon the subject of "The Natural History of Infectious Diseases"; it is a careful and well-written article, leaving but little to be desired. The subject of the communicability of phthisis is, however, worthy of a little more space than

that allotted to it, more especially as during the past two years a conviction has established itself among health officers that there is at present an enormous amount of preventible mortality from that disease, by reason of the fact that the malady is frequently traceable to infection from a pre-existing case; and there is every prospect, in the near future, of phthisis being brought more directly under the control of preventive measures.

Article 3, by Dr. J. C. McVail, gives an excellent summary of the work that has resulted in our present system of vaccination, and deals fully enough with the subject of anti-vaccination. The article contains many useful diagrammatic expressions of the deaths from small-pox, and the general incidence, age and sex incidence, types, &c. of the disease among both the vaccinated and the unvaccinated.

The subject of vital statistics has been entrusted to Dr. Ransome for treatment. It is, of course, a good article, but rather short, and hardly explanatory enough in some respects for the purpose of those who will doubtless consult the volume upon points which they have either not been able to understand or to gather from the perusal of the smaller works upon public health.

The main scope of Article 5 is the hygiene of those who live at sea, in ships as their houses, and with the sea and air as their environments. It is appropriate, therefore, that under the heading of "Marine Hygiene" the writer should treat of sea-water in its chemical and physical aspects; the various kinds of ships, and the material used in their construction; shipping and passenger statistics: the cubic space, ventilation, and temperature of cabins and bunks; the water supply of ships; and the sailor, his food and its preservation, his clothing, and the diseases to which he is especially subject. The best feature, and the most useful, of this admirable article is that bearing upon port sanitation, and Dr. H. E. Armstrong is to be congratulated upon a careful and valuable contribution.

The sixth article, upon military hygiene, is by Prof. J. L. Notter. It is substantially that which appears in the same writer's edition of Edmund Parke's work upon practical hygiene. It is well written and sufficiently exhaustive.

The article which deals with disposal of the dead consists of two parts. Part i. is contributed by Sir T. Spencer Wells, and treats of the various methods employed by different sects and nationalities. It is admirably written, extremely interesting, and is a powerful vindication of cremation. The second part is written by Mr. Frederick Walter Lowndes, who, while he discusses the question in a spirit of impartiality, maintains that there need be no difficulties and dangers in the prevailing method of disposing of the dead, if proper care be exercised in the selection of the site of the burial-ground and its subsequent management.

The volume is concluded by an excellent article upon the medical officer of health, by Dr. Ashby; and we are glad to find the writer advocating whole time service, though deprecating the altogether inadequate emoluments which are offered in return. This will be found one of the most valuable contributions in the whole volume for those who, having secured an appointment as medical officer of health, wish to have brought before them the whole

requirements, duties, and routine work appertaining to that office.

All those interested in public health can but be grateful for the opportunity, which this valuable and well-bound volume affords, of gaining an excellent and reliable knowledge of the many subjects which it embraces.

The second volume, of which the title is given at the head of this notice, is a third edition, considerably enlarged and improved, of the "Principles of Hygiene,"—a small handbook written by Dr. Willoughby, for the special use of the students of hygiene in the Science and Art Department, South Kensington.

The author very justly infers that with a material increase in its bulk, the scope of its utility has been extended, and that it will now meet the requirements of the medical man, the student, and the teacher. We do not, however, quite agree with the author in his assertion that the contents will be found almost if not quite sufficient for most examinations in public health. The book undoubtedly deals fully enough with the *principles* of hygiene, but the student for diplomas in public health will find it necessary to consult other works upon special subjects—such as Water, Air, and Food Analysis, Offensive Trades, and Sanitary Legislation. We do not wish it to be inferred, however, that Dr. Willoughby's book is inferior in any way to most of the other small manuals dealing with the same subject, neither of which is sufficient in itself to meet the requirements of those seeking public health diplomas. The present volume is well adapted to rank with others of its kind as a very useful manual, and its appearance adds to the difficulty which teachers already experience of concluding as to which is the best all-round book for students bent upon securing a degree in hygiene. This difficulty experienced by teachers arises from the fact that all such manuals are, of necessity from their small bulk, somewhat unequal; in all it is easy to lay one's finger upon some important points which are dismissed far too cursorily. The present volume is no exception in this respect; the chapters on food, school hygiene, and demography are excellent, and probably the best that have yet found their way into any of the smaller public health publications; but, on the other hand, there is practically nothing about offensive trades, with reference to the nature and source of the various nuisances which each gives rise to, and the means by which these can be abated; the subject of the collection, storage, and distribution of water for town supplies might be amplified with advantage; and if it is necessary to introduce the examination of air, surely its importance justifies the author in giving at least two full pages to it.

The manual suffers somewhat from a dearth of illustrations; these are prized highly by the student who comes green to the subject, and Dr. Willoughby would have done well to give more than thirty-nine illustrations in his manual of nearly 500 pages.

In the preface the author writes: "Some of my statements, especially as to cholera, diphtheria, and the influence of small-pox hospitals, may appear somewhat dogmatic and opposed to traditional teaching." But we do not think that the bulk of sanitarians will differ from Dr. Willoughby in the views which he holds upon either

of these subjects, and we commend his opposition to traditional teaching when this teaching is not in accordance with more recently acquired knowledge. The work is for the most part very well done, and those interested in the study of public health matters will do well to read it.

Mr. Crookes can be congratulated in so far as he has well translated a work which serves to give us an insight into the German methods of practical hygiene. These methods are for the most part similar to those in vogue in this country, but in many important respects we differ from our neighbours; and it is mainly on this account that the work will not become the text-book for English students of practical hygiene, valuable as it undoubtedly must be to German students.

The book is characterised by what appears to be almost a studied ostracism of everything British. The methods selected and advocated are almost exclusively German, and with very rare exceptions (possibly half a dozen in the two volumes) continental views and opinions are alone given.

In view of the fact that in the preface the author writes: "Thus I hand over my book to the nation which has taken the lead of all modern civilised peoples in the sphere of practical hygiene," it is strange that he should have so persistently ignored everything English in the work. Surely in water-analysis we might reasonably expect to find some mention made of Wanklyn's, Frankland's, or Tidy's processes; and a perusal of the section upon the hygienic examination of dwelling-houses discloses several discrepancies which exist between English and German views on house sanitation. Such a sentence, for instance, as "The overflow pipes of cisterns should not open into the soil-pipe of a w.c. without the intervention of a siphon," would certainly not find its way into our sanitary literature. The use throughout the work of the term "typhus" for "typhoid" or "enteric," and the fact that the "degrees" of hardness are always *German* degrees, will certainly create a little confusion among English readers; and here and there are instances where the information is either imperfect or misleading when viewed from the English standpoint. One such instance has already been given, and we now furnish a few others:—

The author writes: "The danger of chronic poisoning by drinking water has probably never existed." He estimates the ammonia by adding the Nessler reagent to the original water, and does not appear to attach sufficient importance to its presence; the indigo process is the only one given for estimating the nitric acid in water; the organic matter in water is alone determined by the amount of oxygen which it will consume, according to Kubel-Tiemann. The microscopical examination of foreign matter in water occupies about a page, and no illustrations are given save of the ova of the more common intestinal parasites. Organic matter in the air is dealt with very cursorily and unsatisfactorily, and the only means of estimating it is by the oxygen which it will absorb from permanganate, which, the writer is at pains to point out, suffers from grave defects. The microscopical characters of the different starch grains are treated in a very poor and insufficient manner. The

tract of the ether vapours in the Soxhlet apparatus is wrongly described, and the treatment of the subject of soil examination is crude.

Although it is not difficult to thus indicate many points with which a critic in this country may find fault, the work may with profit be consulted on many subjects, and none with greater advantage than that of Food.

The book is capitably printed and bound in two handy-sized volumes.

#### THE LATEST TEXT-BOOK OF GEOLOGY.

*Text-Book of Geology.* By Sir Archibald Geikie, Director-General of the Geological Survey of Great Britain and Ireland. Third Edition, revised and enlarged. (London: Macmillan and Co., 1893.)

IT goes very much against the grain, for it savours of ingratitude, to begin by picking holes in a book that has been a trusted companion, that has proved itself worthy of trust, and to which I have been so largely indebted, as the volume before me. But the strictures I feel bound to make are not very severe, and the blots I cannot help noticing do not impair seriously the value of the work—do not, indeed, detract at all from its usefulness in the case of a large number of readers.

The first point on which I have always differed from the author is this. In Book i., which deals with the cosmical aspects of geology, we are introduced to some of the darkest and most unsettled problems that arise when we concern ourselves with the earth's history; the stability of its axis, the degree of its rigidity, the causes of the changes of climate which have occurred in bygone days. Besides their obscurity these points have not a little in common, and much may be said in favour of grouping them together. But when we find it stated in the preface that the method of treatment adopted is one which the author has found, while conducting his geological class, to afford the student a good grasp of the general principles of the science, it is hardly possible to avoid doubting the wisdom of bringing them in at so early a stage. To do this is to run counter to that prime canon of teaching, which bids us start with the concrete, simple, and known, and lead thence up to the abstract, complex, and hypothetical. To the advanced student, who has already made the acquaintance of these unsettled points, such a summary as we have here of what has been done towards their solution is most valuable; but it is rather strong meat for the beginner. On just the same grounds I would object to putting in the forefront speculations as to the state of the earth's interior or her age. Something may be said in favour of an early notice of the nebular hypothesis, for it looks like beginning at the beginning. But to do this successfully we must have some certain knowledge of what the beginning was, and this we assuredly have not in the case of the earth. So greatly do I differ from the author's view as expressed in the preface that I always recommend students to omit large portions of Books i. and ii. on their first reading. In the same connection one may note that, on the principle that the father comes before the children, hypogene action precedes epigene action in Book iii. But on grounds already stated, I should be inclined to reverse the order.

Further, while all that style could do to render the work attractive has been done, I have found that the arrangement of its matter tends to render it at times rather hard reading. It is somewhat irritating, when you have begun to grow warm on some subject and want to know everything that is known about it, to be told that no more can be said here, but that some information has been given in a previous book, and that the subject is further discussed in a subsequent book. It is no great hardship to have to turn backwards or forwards, though a little hunting may be required to find the exact passage sought; yet these cross references do act as a check on the even flow of one's thought, and they occur pretty frequently. A little more elasticity and a little less consistency may be desiderated. Take the case of metamorphism. In Book ii. part 7, section iii. we have a description of the chief varieties of metamorphic rocks; then, under the head of Dynamical Geology, in Book iii., instances of the changes produced by metamorphism; lastly, in Book iv., which treats of the architecture of the earth's crust, we are told of some additional metamorphic changes and of the processes by which metamorphism is brought about. It is difficult to see why the last two sections should have been so widely separated for the process of metamorphism, specially of regional metamorphism, is a dynamical operation. It would have been a convenience and would have saved some repetition, to have had all these sections in continuous sequence; and it is instructive to notice how impossible is rigid adherence to systematic arrangement, for even in the descriptive section there are constant anticipations of the dynamical problems which are treated more fully later on.

There are other cases in which, for a similar reason, it will be found troublesome to gather into a connected whole all that the book has to tell on a specific subject; but the trouble will be well repaid, for it is a book almost exhaustive in its fulness, copiously illustrated, lucid in its descriptions, and a model of English in style. As an illustration of its thoroughly practical character, we may point to the minute directions on the subject of fossil-collecting at the end of Book v. On some of the more recondite and obscure problems of geology, the author has wisely refrained from attempting to decide between rival hypotheses; but he has summarised the more important speculative solutions that have been put forward, and has given such full references to the papers in which these appear, that the reader, who is so minded, can easily follow out the questions for himself. Indeed, throughout what may be called the physical side of geology, the book is a most exhaustive and trustworthy compendium, such as could be produced only by one who has a wide acquaintance with the literature of the subject, and who has also been brought face to face with what he describes by life-long and varied work in the field.

When we come to stratigraphical geology, it behoves the critic to be wary in his judgments. To treat this satisfactorily seems to me to be the most trying ordeal to which the writer of a text-book can be subjected. At the very threshold we are met with one of the most perplexing of geological problems, when we are called upon to decide between the rival claims of contemporaneity and homotaxis. The subject is discussed at some length by

our author. A reference to Prof. Huxley's Anniversary Address (*Q. J. Geol. Soc.* xxvi. [1870] p. 43) might be usefully added to the note on p. 658. And when we pass from theoretical questions to matters of actual fact, the treatment of this branch of geology is no less difficult. How often does it consist of little else but tables of names of formations (comparative or otherwise), lists of fossils, and other statistical information, that make it about as lively as a parish register or a regimental roll-list. How often do we ungratefully curse for its dismalness a book of this kind, to which we are glad enough to turn for reference. And at first it looks as if this could not be helped, for if we are to give within reasonable compass only a summary of what is known of the stratigraphy of the world, what space is left for more than dreary statistics? Fortunately there are two matters directly arising out of the bare facts of stratigraphy, which give life to its dry bones: the light which the rocks of a region throw on its physical geography at the time they were formed, and the connection between the fossils of geological epochs and the general evolution of life on the earth. For these space must be found, because without these our narrative is no more geology than a list of dates is history. These points have not been lost sight of in the present text-book.

The oldest rocks of the earth's crust are in the present edition prudently grouped together under the head of pre-Cambrian. Of the many names given to these rocks all but this have involved more or less of unjustifiable assumption; but in this there is comparative safety, for whatever difference of opinion there may be about the upper limit of the Cambrian, there is a fairly general provisional agreement as to where its base is to be placed. The account of the pre-Cambrian rocks has been recast and amplified; the term is not used as a "dumping ground for everything of unknown age," but the claims of the rock groups described under this head to the antiquity which the name implies are canvassed. Additional details as to the recent work of the Geological Survey in the North-west Highlands are introduced. Attention is also called to the fact that portions of the Archæan schists have in more than one locality been shown to be intrusive, and that the amount of the Archæan has thereby been materially reduced. But it must not be overlooked in this connection that the pebbles in the conglomerates of the Torridian and other pre-Cambrian clastic rocks prove the existence of crystalline schists of Archæan type before these beds were deposited, and so leave a residue of Archæan rocks that no future discoveries can abolish. Further additions in the present edition deal with the rocks of the Central Highlands provisionally classed as Dalradian, and the researches of American geologists among their Fundamental Complex and Algonkian. The amount of new matter in this part of the book makes it practically a new work.

Within the space of this article it will not be possible to do more than glance at the many subsequent improvements. The account of the Silurian Rocks of North Wales is hardly up to date, and specially the treatment of the May Hill Beds leaves somewhat to be desired. The insertion of a table giving the results of Prof. Lapworth's work in the Southern Uplands of Scotland is a recognition that all geologists will welcome. The De-

vonian section is enriched by an account of the researches of Mr. Usher and Prof. Kayser. Under the head of the Carboniferous System the account of the distribution of the fossils of the English coal measures is hardly up to the mark. It is scarcely brought out with sufficient distinctness that the marine shells are found only in a few thin bands, and that these are by no means confined to the Ganister Beds. It is questionable, too, whether it was worth devoting so much space to the attempts of Grand'Eury and others to zone the carboniferous rocks by means of their plants. There are those among us who yet recollect Hooker's warning as to the value of specific distinctions between fossil plants, which has been since enforced by the discovery that two genera so seemingly distinct as *Lepidodendron* and *Halonina* are really different parts of the same plant. A most important addition to the Permian section is an account of the marine type of the Permian rocks, which, if I mistake not, now finds for the first time a place in an English text-book. Under the Jurassic section attention is called to Neumayr's speculations as to the climatic belts of that period. Among the Cretaceous deposits due notice is taken of the work of Mr. Lamplugh and Prof. Pavlow on the Specton Clay. The treatment of the Gault and Upper Greensand is hardly satisfactory. The views as to the relationship of these two groups, by no means new but largely enforced by the work of Mr. Jukes-Browne, are only indicated; and the reader will hardly gather that, as is stated so unhesitatingly in the last report of the Director-General of the Geological Survey, the two groups really constitute one formation. Have red-tape regulations here forbidden the author to give to the public the benefit of survey discoveries till they have been announced in an official form? This seems a pity, but red-tape is hardly likely to see it in this light. In the Gossau Beds we find a striking instance of the difficulty of keeping a book up to date; not many weeks have passed since a paper was read before the Geological Society, which will probably largely increase our knowledge of this somewhat exceptional formation. One very useful addition among the Tertiary Rocks is a fuller notice of Mr. Clement Reid's studies of the Cromer section.

The last book, on *Physiographical Geology*, is a little disappointing. The author has made earth-sculpture and other branches of this division of geology so specially his own, that we could have wished for more under this head than the concise summary he has given. True, he would have been repeating what he has said oftentimes before; but his contributions to this most fascinating subject are rather scattered, and a full summary would have been very welcome.

The above notes, which are not the result of a systematic collation of this and the previous edition, but have been culled at random, suffice to show that no pains have been spared to bring before the reader the latest results of geological inquiry. In a rapidly growing science the task of keeping edition after edition of a text-book up to date must be toilsome; it is fortunate when we have an author who has the courage to stick to the work, and power to carry it out with success. It is a welcome fact that this third edition, in spite of its 150 additional pages, is less bulky than the second.

A. H. GREEN.

## THE CHEMISTRY OF THE BLOOD.

*On the Chemistry of the Blood, and other Scientific Papers.* By the late L. C. Wooldridge, M.D., D.Sc., Assistant Physician to, and co-Lecturer on Physiology at Guy's Hospital. Arranged by Victor Horsley, F.R.S., and Ernest Starling, M.D., with an introduction by Victor Horsley (London: Kegan Paul, Trench, Trübner, and Co., Ltd., 1893.)

TO all who are interested in the progress of medical science and of physiology, the publication of the scientific papers of the late Dr. Wooldridge will be very welcome. Dr. Wooldridge always impressed those who knew him well as possessing many of the attributes of genius. Full of ideas in connection with the subject he chose for his work (chemical physiology), he was not content to limit himself to the expression of ideas simply, but resorted to experiment to test the accuracy of his conceptions. The experiments and observations which he made, it may be said, dealt with one of the most complicated subjects in physiology, viz. the chemistry of the substances (proteids) closely related to the life of the cell and of the organism. A man of Dr. Wooldridge's capacity and originality could not long remain trammelled by the traditions of academic science. Although he received a very full academic training (and his early original work on the blood bears the impress of this training), he soon discovered new paths of research, and elucidated facts combating old ideas, and shedding light on the phenomena of life. It was perhaps inevitable that so original a man should come into conflict with what may be called the "academic mind"; the man of great originality always does. What happened to Dr. Wooldridge in this respect is stated very clearly, and not too forcibly, in the excellent introduction to this volume by Prof. Victor Horsley. It is only necessary here to state that although Wooldridge's work was appreciated on the continent, his Croonian lecture, embodying his views on the coagulation of the blood, was refused publication by the Royal Society. It is not wise, perhaps, to lay too much stress on this error of judgment, but it may be said that Wooldridge did not publish papers containing visionary ideas, but all his conclusions were based on well-conducted experiments, and that he was a modest and sincere seeker after truth. His work, in spite of the drawbacks and disappointments of his short life, is now beginning to be appreciated, and in two or three directions he led the way to discoveries which are of great importance to physiological and pathological science.

It would be out of place here to give anything like a full synopsis of the scientific work done by Wooldridge. It may be said that his chief work dealt with the phenomena of the coagulation of the blood: phenomena clearly showing the passage of a living tissue into a dead. The investigation of such phenomena is in many respects more difficult and complicated than a purely physical or chemical research; for in a chemical study of so complicated a liquid as the living blood, the mere separation of one of its constituents may so alter its nature as to lead to a misapprehension of its real properties. This was clear to Wooldridge during the whole course of his work. The phenomena of the coagulation of the blood

was explained by Alexander Schmidt and his pupils of the Dorpat school, as consisting in the action of a "ferment" on a proteid body called fibrinogen; the chief change in the blood preceding the formation of fibrin being a destruction of the white corpuscles. This theory was taught in the schools, and accepted not as a final explanation, but as a very probable explanation, the chief idea being that a "ferment" was essential to produce coagulation. Now Wooldridge showed conclusively by his experiments that a ferment is not necessary to coagulation; he, in fact, separated from the blood plasma a fibrinogen which became transformed into fibrin without the aid of a ferment. This change he found in many cases was accelerated by lecithin. Wooldridge viewed coagulation as a change occurring in the plasma of the blood, and not so much in the white corpuscles; his ideas, therefore, were in direct opposition to those of the Dorpat school, and have been in part confirmed by subsequent researches. For all the details of his work in this respect, his papers must be consulted; mention must, however, be made of his brilliant discovery of a means of causing intra-vascular coagulation.

It was known that by injecting a solution of peptone into the circulation of certain animals the coagulation of the blood was prevented when drawn from the body. No method was known by which the blood could be made to coagulate in the vessels during life. Wooldridge discovered that the injection of an extract of certain parts of the body, *e.g.* the thymus gland, the testis, and lymphatic glands, produced this. It is impossible to overestimate this result, since it throws light on the phenomena of coagulation occurring in the vessels in many cases of disease. The body producing this effect is a proteid and called "tissue-fibrinogen." His study of this body, or bodies (for there may be several closely allied), induced Wooldridge, when he began to do work for the Medical Officer of the Local Government Board, to see whether it possessed any immunizing properties; whether, in fact, the profound change it produced in the blood was unfavourable to the development of bacteria invading the body. He found that in the case of the bacillus anthracis that it had this property; that in rabbits injected with this tissue fibrinogen the death from anthrax (inoculated at the same time) was delayed. Moreover, he found that he could produce a better result if the bacilli were grown for a short time in a solution of tissue fibrinogen. There is no doubt that Wooldridge, in these experiments, was the first worker who clearly showed the possibility of chemical vaccination for infective disorders; and there is but little doubt that if he had lived to continue this work, he would have clearly demonstrated what others have since shown, viz. vaccination against a bacterial disease by means of the chemical products of the specific micro-organism.

Sufficient has been said to show what the well-arranged volume under consideration demonstrates at length—that Wooldridge's work was of the highest order; and it was fitting that his scientific papers should be arranged by Prof. Victor Horsley, who was Professor-Superintendent of the Brown Institution when Wooldridge did much of his work there, and by Dr. Ernest Starling, who succeeded him as co-Lecturer at Guy's Hospital.

AGRICULTURAL BOTANY FOR EXTENSIONISTS.

*An Elementary Text-Book on Agricultural Botany.* By M. C. Potter, M.A. Small 8vo. Pp. 250, with ninety-nine illustrations in the text. (London: Methuen and Co., 1893.)

THIS is a very good little book up to a certain point, but it is neither better nor worse than the general run of elementary works on botany, in which there is an attempt to cover the whole field. The physiological and anatomical parts are the best; yet we see no reason why the title should be "Agricultural Botany." Indeed, we fear the author has been a little too ambitious; laudably ambitious, perhaps, though wanting the practical knowledge necessary to achieve his object—not that it is one within easy reach. This is an extract from his preface: "My aim in these few pages has been to lay a foundation which may serve to guide the future operations in the field, and form a basis for intelligent trial and experiment. In these days of competition and struggle for existence, every little tells, and the farmer who, understanding, can apply his knowledge, is more likely to succeed than one who labours without the advantage of this knowledge."

No doubt a man would not necessarily be a worse farmer because he possessed some knowledge of vegetable physiology, nutrition, or even classification, and he might possibly derive a more intelligent enjoyment—if there be any left—from his occupation; but if he knew all the botany in Mr. Potter's book, and all that is not in his book, we doubt whether he would be any nearer making farming pay, which is the main object, after all, of the majority of those who engage in the pursuit. Success in farming does not depend so much on scientific knowledge as on practical knowledge. Science has doubtless done much to advance farming—especially mechanical science; and we should be the last to discourage making botany a subject of study for the budding farmer. But we think the macroscopic side is too much neglected in favour of the microscopic side. For instance, we sought the distinctions between rye (*Secale*) and barley (*Hordeum*); but although the anatomical structure of the stem of the former is described and illustrated in some detail, it is not included in the chapter on grasses where the floral structure is described. In the description of the natural order Leguminosæ, it is stated that the fruit is always composed of a single carple; that the leaves are never opposite; and that the seeds are always destitute of endosperm. It is unnecessary to give examples disproving these statements. On the next page the flowers of the sub-order Cæsalpinæ (*sic*) are said to resemble the Papilionacæ, but to differ in having the standard inside the wings. There is one element of truth in this. The nature and extent of the information given under some of the genera of Leguminosæ may be gathered from the following: *Sarothamnus*—the broom is common on sandy waste lands. *Ononis*—a small plant with pink flower, commonly known as the rest harrow. There are two species, one with spines and one without. Looking under *Pisum*, we discover that *P. arvense*, the field pea, is not mentioned. Under *Vicia*, the tare, *V. sativa*, is described as having a weak stem, partly erect, and purple flowers, often in pairs; with the

further information that it is often cultivated. In short, this part of the book needs thorough revision before it can be considered as useful or satisfactory. At half a dozen other places where we opened the pages, we noticed the same incompleteness and want of precision.

THE PRINCIPLES OF HOSPITAL CONSTRUCTION.

*Healthy Hospitals: Observations on some Points connected with Hospital Construction.* By Sir Douglas Galton, K.C.B., F.R.S., &c. (Oxford: The Clarendon Press.)

THE object of this book, as its author, Sir Douglas Galton, tells us, is to bring together the principles of hospital construction which now lie scattered through various publications, and to show what points are essential to health in hospital establishments. This task has been admirably fulfilled by the author, and we cannot but recognise the skilful manner in which, from chaos he has brought together and condensed in the small compass of 282 pages such a vast amount of useful information.

Sir Douglas Galton has already a high reputation for the application of scientific methods to the construction of barracks and hospitals. Few men have had larger opportunities of acquiring such knowledge in the public service, and very few have been able to investigate the questions involved so thoroughly as the author of "Healthy Hospitals," whose zeal has induced him to visit every place, as well in America as on the continent, where he could obtain sound practical knowledge on the subject by personal observation and inquiry. We therefore gladly welcome this book, which is the outcome of his great experience.

In the preliminary chapter Sir Douglas Galton enters very briefly into the historical part of his subject, and dates the great improvement in the construction of hospitals from the close of the Crimean War, the American War of Secession, and the Franco-German War of 1870-71.

He subsequently lays down the first principles on which the successful treatment of disease depends, the selection of site, the conditions of air supply, of warming, lighting, and water supply. Many of the rules laid down are of course not new, but they are nevertheless valuable, and bear to be repeated and emphasised.

The rules to be followed are defined so clearly and concisely, that it becomes a simple matter to apply them in a practical form. The chapter on site is one that will at a glance show the importance of the subject, and at the same time the difficulties it often has to contend with. Many errors are pointed out which have been committed in the selection of plans for some of the large hospitals in England and on the continent. This is one of the most important and best chapters in the work before us.

In the chapters on the constitution and movements of the air, and on ventilation and warming, which are dependent in a great degree on these changes, the author enters very fully into the consideration of these important subjects. He accepts De Chaumont's standard as the

best guarantee for keeping an air space pure and wholesome—a point of no small importance, since latterly a lower standard has been advocated. He recognises the importance of investigating the micro-organisms in air, but states “that our knowledge of this science and of the nature of the organisms is too recent to allow us to lay down any fixed rules for judging of what are dangerous characteristics of air in wards measured by this standard.” This is no doubt true up to a certain point, but the Ratio <sup>Bacteria</sup> <sub>Moulds</sub> as pointed out by Carnelly and Haldane (*Philosophical Transactions of the Royal Society*, 1887), should not be overlooked in investigations on this point.

The chapters on warming and lighting are complete monographs on these subjects, as we might expect from the distinguished author who has made them his special study.

In discussing the various methods of ventilation which have been applied to hospitals, is mentioned the mechanical extraction of air as practised by propulsion. This plan has never found favour in England, but has been introduced into some continental hospitals. We note that on several occasions when three of the most important hospitals were visited in Europe and the United States, in which ventilation depended on propulsion, on every occasion the propulsion happened to be out of use for the time; in some cases evidently with the object of saving the expense of fuel!

The latter chapters are devoted to the consideration of the ward unit and the administration buildings. Every detail has been most carefully noted, and the closest criticism fails to find an omission. The rules are laid down with a simplicity and clearness which render it very difficult to notice them without quoting them in detail, and the plans which accompany the letter-press show at a glance the principles which should be followed.

We regret that the writer has not entered more fully into the question connected with isolation hospitals for infectious diseases. No plan is given of any such hospital, although mention is made of the Local Government Board rules for the London fever hospitals.

The isolation pavilion of the Johns Hopkins' Hospital seems to be so admirably constructed, and the structural details so carefully carried out, that the plan would be a valuable addition to the present work. In infectious hospitals, the position of the administration block to the wards would also differ to the plan usually adopted for general hospitals.

Sir Douglas Galton is opposed to the expense which some of the costly and palatial hospitals of the present day have entailed, and advocates simplicity of design and economy in construction as leading conditions to be observed in building hospitals for the future. If the rules he has so clearly given throughout his work be attended to, these important qualities will naturally follow.

We commend this book not only to the architect and sanitarian, but to all interested in hospital work. It is eminently practical, and its author must be congratulated on the completion of a work of no ordinary merit, and one which is a fitting companion volume to his “Healthy Homes.”

NO. 1265, VOL. 49]

### OUR BOOK SHELF.

*The Vault of Heaven.* By Richard A. Gregory, F.R.A.S. (London: Methuen and Co., 1893.)

THE aim of this volume of the University Extension Series of text-books is to give “an elementary account of some of the marvels that have been revealed by the use of the telescope and two of its most indispensable adjuncts,—the spectroscope and the photographic camera.” In the space of about 180 pages the author contrives to give an admirable introduction to the study of modern physical astronomy, and the whole is set forth in a manner calculated to awaken a permanent interest in this most fascinating subject. The book is eminently readable, and contains none of the mathematical expressions which are so liable to arrest the progress of the general reader. Astronomical telescopes, including equatorials and meridian instruments, form the subject of the first chapter. Then follow two chapters giving an excellent account of the sun and of the various methods by which our knowledge of that luminary has been gradually accumulated. The reader is next presented with bright and brief pictures of the moon and planets, comets and shooting-stars, and of the various bodies which are met with as we proceed further outwards into “boundless space.” The “Chemistry of Stars and Nebulæ,” and “Celestial Photography,” define the scope of the final chapters. Many novel illustrations are given to assist the reader in comprehending the significance of astronomical data. The subject-matter is quite up-to-date, and in matters not yet quite clear the author has wisely refrained from taking sides in controversies. The historical references are fairly complete, and space is found for some most interesting extracts and diagrams from Galileo’s “Sidereal Messenger,” published in 1610.

Where all the various parts of the subject are so well explained, it is difficult to single out points for special mention, but we may say that the author is particularly successful in his treatment of celestial photography, though we cannot help regretting that more is not said about the immense gain to astronomy which has followed from the application of photography to the study of the spectra of the heavenly bodies. We are glad to see, however, that he says (p. 33) with regard to the Carrington-Hodgson observation of 1859, “the statement that the outburst was *immediately* followed by a magnetic storm does not appear to be founded on fact. From an examination of the magnetic records kept at Kew, it appears that at the time of the observation the needles were unaffected, and it was not until *fifteen hours* after that a magnetic storm occurred.”

A word of praise is due to the author for the careful preparation and selection of diagrams and photographs, all of which are excellently reproduced; many of them make their first appearance in this volume. There are a few misprints—as, for instance, on p. 113, where 14 times 60,000 is given as 84,000; but they are not so serious as to be misleading. A classified list of astronomical books for the use of those desiring to extend their reading beyond the limits of an introductory text-book, concludes a volume which is well adapted to impart the preliminary knowledge essential for a proper understanding and appreciation of the fresh results which are constantly being obtained in the various observatories throughout the world.

*A Journey through the Yemen, and some General Remarks upon that Country.* By Walter B. Harris, F.R.G.S. (Edinburgh and London: William Blackwood and Sons, 1893.)

THE Yemen is an indefinite tract stretching inland from the south-western corner of Arabia, and the “general remarks” upon its geography and history are placed first in this volume, the personal narrative of the author’s

journey, in which alone is there any original information, occupying the second place. From Aden Mr. Harris started inland and crossed the Turkish frontier under the pretence of being a Greek shopkeeper from Port Said. In this way he obtained access to the disaffected province of Yemen during the progress of a rebellion, reached Sanaa, and was naturally imprisoned by the Turkish officials there, who refused to recognise his English passport. The author finds fault with the Foreign Office for not coming to his rescue, apparently forgetful that he wilfully concealed his nationality at the outset, and so gave rise to suspicion, and forfeited any privileges to which it might entitle him. From Sanaa he was sent under escort to Hodeida. The illustrations are interesting as types of the scenery and people of the Yemen, but the book has no other claim to scientific notice.

#### LETTERS TO THE EDITOR.

[The Editor does not hold himself responsible for opinions expressed by his correspondents. Neither can he undertake to return, or to correspond with the writers of, rejected manuscripts intended for this or any other part of NATURE. No notice is taken of anonymous communications.]

#### The Directorship of the British Institute of Preventive Medicine.

WE observe in your issue of the 18th inst. a letter, signed by Prof. Roy, respecting the appointment of a "Director" to the Institute of Preventive Medicine, and purporting to recount what occurred at the meetings of the Council.

As Prof. Roy has misstated the principal facts, and has withheld others which are fatal to his allegations, it is possible that some of your readers may be misled, and it is therefore advisable that the real state of the matter should be published.

(1) The present appointment being one of a purely temporary nature (for three years only) and at a nominal salary, is not, as Prof. Roy implies, equal to that of Dr. Koch, neither is it to that of M. Pasteur, who, by the way, is not, as Prof. Roy implies, the Director of the Pasteur Institute.

(2) The qualifications necessary for the office were fully considered by the Council, and by committees of the Council, and consequently Prof. Roy's statements to the contrary are not correct.

(3) Prof. Roy's statement that he initiated the idea of the Institute is not according to the fact. He was entrusted with moving the resolution proposing the establishment, at the meeting where the matter was first publicly discussed, but the founding of the Institute had been in the minds of the members of the Mansion House Committee and discussed among them long before.

(4) Prof. Roy implies that he resigned his position as secretary to the Council (*sic*) as a kind of protest against the latter's mode of transacting business.

This statement is incorrect. In the first place, Prof. Roy was one of the secretaries to the Executive Committee, and not to the Council. In the second place, Prof. Roy resigned that position without making any protest whatever to the committee, by whom his resignation was at once and unconditionally accepted.

(5) The subject of the temporary directorship was discussed by "gentlemen who are" or have been "directors of laboratories." Prof. Roy implies it was not so discussed by experts. The error of this allegation is probably due to the fact that he was absent from the Council meeting at which the question was first brought up, and that he was not a member of any committee. It may be noted that Prof. Roy complains of non-attendances. On this point his statement may at once be conceded so far as he personally is concerned, since in 1893 he attended but three meetings.

(6) The question of appointment of a temporary Director was stated on December 13 to be urgent, and the urgency was admitted by the whole Council with the exception of Prof. Roy. Prof. Roy tells your readers that the statement "carried no weight with him." Possibly this may have been because he was absent from the previous Council

meeting when the point of urgency was fully discussed; but such ignorance, even if admitted to be an excuse, does not account for Prof. Roy now withholding the fact that when he was present on the 13th ult. the reason of the urgency was fully communicated to him. Also, it is not right for him to withhold, as he does, the fact that the acceptance of the report of the sub-committee, which was wholly conditioned by that urgency, was agreed to by the Council *nem. con.*

(7) Prof. Roy speaks as though the Council strongly objected to the resolutions laid before it. He ignores the fact that on the 13th it was but two members, including himself, and on the 19th only himself, who so objected.

(8) Prof. Roy suppresses the fact that a special meeting of the Council was held on December 19 to re-examine the whole question, and to confirm or reject the minutes of the meeting of December 13, and that those minutes were circulated to every member of the Council, and that the meetings of the 13th and 19th were well attended. He omits to mention that he circulated beforehand, and produced at the meeting on the 19th, a document which he termed a "protest," and that, as it contained offensive statements plainly contrary to fact, the Council declined to proceed with the business of the meeting until Prof. Roy withdrew his "protest" unconditionally. He also suppresses the fact that he did so, and that this preliminary having been executed, the minutes of December 13 were then put and confirmed *nem. con.*

If any of your readers, after this historical statement, consider that Prof. Roy's letter is justified in any sense, further information can be supplied.

In conclusion, it may perhaps be interesting to note the names of those present on December 19. These were, for the appointment of the temporary Director—Sir Joseph Lister (chairman), Sir Henry Roscoe, Sir Joseph Fayrer, Prof. Burdon Sanderson, Prof. Michael Foster, Prof. Victor Horsley, Mr. Watson Cheyne; while there was opposed to the appointment—Prof. Roy.

J. FAYRER,

VICTOR HORSLEY,

Mover and seconder of the motion for confirmation of the minutes of December 13.

#### The Origin of Rock Basins.

IN my previous letter I confined myself to one aspect of the controversy relative to the origin of rock basins now occupied by lakes, as all the other arguments adduced by Dr. Wallace—with one exception, of which more hereafter—have already been answered, and the case on either side so fully presented that each one may draw his own conclusions as to which is right. The particular confusion of argument I referred to has not been so fully dealt with, and Dr. Wallace's letter shows that it was one which required to be met, for the heading of his letter itself shows that he has not fully appreciated the particular point at issue, which is the cause of origin of rock basins irrespective of whether they are or have ever been occupied by lakes. Leaving out of question the opinions of other opponents of the glacial erosion theory of the origin of lakes, as this would introduce too large a subject for the correspondence columns of NATURE, and confining myself to the defence of the views put forth in my former letter, I may point out that the preglacial origin of rock basins by deformation is by no means the strongest form of the alternative explanation; on the contrary, it appears to me to be subject to nearly as many objections as the hypothesis of glacial erosion of rock basins. If a rock basin is produced by deformation in a region where the valleys are not filled by glaciers, the ordinary action of the streams will usually be able to prevent a lake from being produced by the erosion of the barrier, the filling up of the hollow, or both combined. When, however, a rock basin is formed by differential movements in a glacier filled valley, it would be filled with ice, and so protected from sedimentation, and on the retreat of the glacier would at first be filled with water, and only gradually filled with solid matter, while the stream, having deposited its solid burden in the lake, would be unable to exert any erosive action on the barrier. From this it appears that there is a probability that rock basins formed beneath the glaciers during their extension in the glacial period should remain to the present day as lakes only partially filled up by solid *débris*.

Seeing then that there is an inherent probability that rock basins formed in non-glaciated regions would never become



lakes, except when the movements were unusually rapid or extensive, the argument from geographical distribution fails; for we have no evidence to show whether rock basins are more or less abundant in regions that have been glaciated, than in those that have not; and seeing, further, that differential movements are known to take place, while it has never been proved that a glacier is physically capable of excavating a rock basin, the *onus probandi* rests with the advocates of the glacial theory; and until they have shown that rock basins are less common in regions that have been glaciated than in those that have not, this argument is not logically admissible. Observations on this point are very desirable, but it must be remembered that filled up lake basins are not the only thing to be looked for; what is desired is evidence of the production of rock basins, or of such differential movements as would have led to their formation, had the erosion of the barrier been less rapid. In the Himalayas such rock basins appear to have been formed in quite as great abundance as in the mountains of Europe, and to correspond with them in position and form; but the elevation of the mountains has been so recent, and the rainfall is so great, that the processes of nature are more rapid than in Europe, and the rock basins have consequently not only been filled up, but the barrier has afterwards in many cases been destroyed, and the deposits largely removed by erosion, so that the fact of their having originally been accumulated in a rock basin is not always easily recognisable.

The one new argument of Dr. Wallace's is that derived from the supposed difference between the outlines of existing lakes and those that would result from the submergence of river valleys. In the selected instances, however, he has compared mountain lakes with submerged lowland valleys instead of with mountain valleys. In the latter, long stretches are frequently found where the slopes of the beds of the side streams are much steeper than that of the main valley; these valleys if submerged would give rise to lakes of great length in comparison with their breadth, and without the numerous deep embayments of the shore line which would be usually found in a submerged lowland valley. As a single easily verified instance to show that a submerged mountain valley need not have numerous deep bays, I may instance the Pangong lake in the Himalayas, which will be found on any good map of India, and is nothing more than a submerged subaërially formed river valley; on a smaller scale the Malwa Tal near Naini Tal and the Pil lake in the hills east of Quetta, both of which are river valleys dammed by landslips, have simple outlines without any embayments. The instances I have chosen are from regions where there has not been a great extension of the glaciers, and where the form of the valley before its submergence was entirely produced by subaërial denudation.

R. D. OLDHAM.

On the Change of Superficial Tension of Solid-Liquid Surfaces with Temperature.

IN a recent very interesting communication to the Birmingham Phil. Soc. (*Bir. Phil. Soc. Proc.*, vol. ix. part 1, 1893), upon the effect of a solid in concentrating a substance out of a solution into the superficial film in accordance with Prof. J. J. Thomson's investigation ("Applications of Dynamics to Physics," p. 191), Dr. Gore has quoted an observation of Pouillet's (*Annales de Chimie*, 1822, vol. xx. pp. 141-162), that when inert powders like silica are mixed with liquids that do not act on them heat is evolved. On the other hand, when the superficial area of contact between a liquid and its gas is increased heat is absorbed. This latter is known to be the case because the superficial tension diminishes with rise of temperature. In the case of the solid-liquid surface being produced, it would appear at first sight to follow that the superficial tension should increase with increased temperature. The matter is, however, somewhat more complicated. When a dry solid is mixed with a liquid we are substituting a solid-liquid surface for a solid-air surface, and from the fact that most liquids soak up into a mass of dry powder, we may conclude that the superficial potential energy of the solid-liquid is less than that of the solid-air surface, *i.e.* that more work must be done to separate the liquid from the solid than is developed by the air getting at the solid. If these actions are reversible, we may apply the laws of thermodynamics, and conclude that as heat is evolved when the system does work, *i.e.* when the solid-liquid surface is increased, that it must require more work

to separate the solid from the liquid at high temperatures than at low ones, and in the case of silica and water, for instance, that is very much what one would expect from the action of water at very high temperatures on silica. If we could assume that the superficial tension of air-solid were zero, it would follow from this that the superficial tension of a solid-liquid surface is negative, *i.e.* that there is a superficial pressure, and that the liquid has more attraction for the solid than for its own particles, and that this difference increases with increased temperature, *i.e.* the superficial pressure increases.

The whole subject deserves careful investigation and quantitative treatment, but the difficulty of measuring the superficial tensions of solid-liquid surfaces seems almost insurmountable, so that it would be very difficult to verify the theory. Perhaps something might be done with finely divided liquids that did not mix, and whose superficial tensions might be measured.

Trinity College, Dublin.

GEO. FRAS. FITZGERALD.

A Lecture Experiment.

WHEN charcoal, which has been allowed to absorb as much sulphuretted hydrogen as it can take up, is introduced into oxygen gas, the charcoal will burst into flame owing to the energy of the action of the oxygen upon the sulphuretted hydrogen.

This fact is stated in most text-books on chemistry, but no description that I have ever seen of this experiment is calculated to bring about the effect with certainty. The following is a simple method for illustrating this reaction upon the lecture table, which I have never found to fail:—

A few grammes (from five to ten) of powdered charcoal are introduced into a bulb which is blown in the middle of a piece of combustion tube about twenty-five centimetres long. A gentle stream of coal gas is then passed over the charcoal, which is heated by means of a bunsen lamp until it is perfectly dry. This point may be ascertained by allowing the issuing gas to impinge upon a small piece of mirror, and when no further deposition of moisture takes place the charcoal may be considered to be dry, and the heating may be stopped. The charcoal is then allowed to cool in the stream of coal gas until its temperature is so far reduced that the bulb can just be grasped by the hand, when the coal gas is replaced by a stream of sulphuretted hydrogen. The sulphuretted hydrogen should be passed over the charcoal for not less than fifteen minutes, by which time the bulb and its contents will be perfectly cold, and the charcoal will have saturated itself with the gas. (In practice it will be found convenient to prepare the experiment to this stage, and allow a very slow stream of sulphuretted hydrogen to continue passing through the apparatus until the experiment is to be performed.) The supply of sulphuretted hydrogen is then cut off, and a stream of oxygen passed through the tube. Almost immediately the charcoal will become hot, and moisture will be deposited upon the glass. The supply of oxygen should be sufficiently brisk to carry the moisture forward from the charcoal, but not so rapid as to prevent it from condensing on the glass tube beyond the bulb. In a few moments the temperature of the charcoal will rise to the ignition point, when it will inflame and continue to burn in the supply of oxygen.

G. S. NEWTN.

Royal College of Science, London.

PIERRE JOSEPH VAN BENEDEN.

THIS distinguished Belgian zoologist was born on December 19, 1809, at Malines, in the province of Antwerp, a town once well known for its extensive manufacture of lace. He received an excellent education, and early showed a decided taste for natural history; his native town being built on the borders of a tidal river, his attention was soon called to the examination of the littoral fauna of Belgium, though it will be remembered that Belgium only evolved itself into a kingdom in the year 1830, when Beneden came of age. His first promotion was to the keepership of the Natural History Collections at Louvain, and in 1835 he was made an assistant professor in the University of Gand, a post which he appears to have held for only one Term, as we find him in the same

year professor of the Catholic University at Louvain, which professorship he continued to fill for more than half a century. Van Beneden belonged to a generation of zoologists that connected Cuvier with the present age, and followed so far in this great master's steps, that they worked at almost all the branches of the animal kingdom. If we were to give a summary of the very extensive writings of van Beneden we should begin with his memoirs on apes, seals, whales, and so through the various classes, with perhaps the exception of the birds and reptiles, to the gregarines. Circumstances made him devote a great deal of attention to the groups of parasitic worms and Annelides. Most of his papers on these forms were communicated to the Brussels Academy of Sciences or to the Paris Academy; the latter we find reported on by Quatrefages. He took a leading part in the, at one time, exciting controversy about the "alternation of generations," with the elder Sars, D'Udekem, and others.

Among the more important works of Beneden may be mentioned "The Natural History of the Fresh-water Polyzoa," in collaboration with Du Mortier, published in 1850, which obtained the Grand Prize of the Paris Academy; the "Zoologie Médicale," in 1859, of which Paul Gervais was joint author; the "Recherches sur la Faune Littorale de Belgique" (Polypes), in 1866. In connection with this work it may be mentioned that Beneden's artistic powers were quite remarkable, and that many of his memoirs owe a great deal to his excellent illustrations. A good correspondent, he kept himself acquainted with the work of most of his contemporaries, and he was the writer of many of the short biographical sketches referring to zoologists that appeared from year to year in the Reports of the Brussels Academy. Some of our readers may remember what an active part he took in the Liverpool (1870) meeting of the British Association; Rolleston was president of the biological section, and gave a morning to the discussion of the subject of "commensalism," which at that time Beneden's mind was occupied with, and about which he afterwards (1875) published a volume in the "Bibliothèque Scientifique Internationale," that has been translated into German and English. Peradventure some too may remember how delighted Beneden, with Stricker, Dohrn, and some of the other "foreigners" present at that meeting were, to find that a little nucleus of the great body combined to make the "Association Sunday" as little sad as possible by the practice of a proper commensalism. Full of honour after a long life well and usefully spent, Beneden had the additional reward of seeing his son Edward take a high rank in the modern biological school, in this resembling his great contemporary Henri Milne Edwards. Beneden was a member of very many of the Academies and Societies of Europe, and was an honorary LL.D. of the University of Edinburgh. He died at Louvain on January 8, 1894.

#### THE GREAT GALE OF NOVEMBER 16-20.

THE past autumn and early winter were especially characterised by a mild and humid atmosphere, due to the very marked prevalence of south-westerly winds which have blown with great persistence from the Atlantic. These conditions are without doubt intimately associated with the frequency with which gales have occurred.

The violent storm which was experienced over the entire area of the United Kingdom, as well as over the sea and the parts of the continent adjacent to our islands, from November 16 to 20, was more severe than the other gales which have recently occurred, and it is necessary

to refer back many years before a storm so violent and so destructive can be found to have traversed the country.

Prior to the advent of the storm an anticyclonic area, with fairly high barometer readings, was situated over our islands, and north-easterly winds were prevalent. On November 14 and 15 a small cyclonic disturbance travelled over the south-western portion of the kingdom, and caused a general giving way in the area of high barometer readings, while the large anticyclone over Europe also materially decreased in its energy. At this time a large cyclonic disturbance was out in the Atlantic, and was rapidly approaching our western coasts; the first intimation of a renewal of bad weather was shown by a fresh fall of the barometer which set in at Valencia at 4 p.m. 15th, and an hour or so later the wind was freshening from the south-east.

On November 16 the conditions had so far changed that at eight o'clock in the morning the weather chart prepared by the Meteorological Office gave unmistakable indications of an important disturbance at no great distance from the Irish coast, and the Official Weather Report has the following remark:—"A large depression is approaching our western coasts from the south-westward, and is likely to cause rough wet weather over the kingdom generally, especially in the west and north." At this time a strong south-easterly wind was blowing in the south-west, but the force of the wind had not attained to that of a fresh gale (force eight of Beaufort notation) in any part of the United Kingdom, although the wind, which on the previous day had been north-easterly, was now everywhere southerly. The self-recording barograph at Valencia shows that the lowest barometer occurred at 7 p.m. 16th, and between eight and nine in the evening the wind shifted from east by south to west-south-west. The central area of the storm was not far distant from Valencia at this time, and during the succeeding night it traversed Ireland in a direction from south-west to north-east, the whole storm-system progressing at the rate of of about twenty-five geographical miles an hour. By the morning of November 17 the heart of the storm had reached the west of Scotland, the lowest barometer reading reported to the Meteorological Office being 28.53 ins. at Ardrossan. Strong gales had blown during the preceding night in the north and west, and the force of a gale was still reported at many places on our coasts, while the wind had shifted to the north-westward over Ireland. The weather information for the evening of the 17th shows that the storm had continued its course to the north-eastward, and at six o'clock the centre of the disturbance was not far from Wick, where the barometer was 28.57 ins. The north-westerly gale was still blowing over the western portion of the kingdom, but there was a decided lull in the strength of the wind in the east and south-east of England. It was shortly after this time that the greatest violence of the storm burst suddenly over the northern part of the country, and at Deerness, in the Orkneys, the wind at 6 p.m. shifted suddenly from east by north to north by east.

The subsequent track of the storm had a most important influence on the increased violence of the wind, and there seems no reason to suppose that if the disturbance had continued its north-easterly track the gales experienced would have been at all unusual. A very important change in the distribution of atmospheric pressure was in progress over Western Europe, and the change of track and subsequent violence is clearly to be traced to these barometer changes. The anticyclone over Central Russia, which had given way for the small disturbance which first traversed the southern portion of England on the 14th and 15th, was now reasserting itself, and this formed a most effectual barrier to the further north-easterly progress of the storm. In addition to

this, the "ridge" of high barometer which was following the storm was of a very pronounced character, and caused a rapid recovery of pressure in the rear of the disturbance. As the result of these two regions of high barometer, or anticyclones, between which the storm system, or cyclone, was situated, the central area of the storm was brought to bay, and abruptly struck out on a path to the south-eastward, in which direction there was the least resistance to its progress. This halting and indecision and abrupt change of path on the part of the storm area caused the high pressure system in the rear to considerably gain on it, with the result that exceptionally steep gradients were caused for northerly gales, which continued to blow for a period of two or three days over our islands.

The diagram showing the barometer and wind for 8 a.m. November 18, indicates a decided change in the course of the disturbance, and at that hour the lowest

November 16, 10 a.m., to November 20, 9 p.m.—4½ Days.

| Station.        | Maximum velocity. |             |       | Hours with velocity 45 miles and above, Force 8 of Beaufort notation. | Mean hourly velocity for 4½ days. |    |
|-----------------|-------------------|-------------|-------|-----------------------------------------------------------------------|-----------------------------------|----|
|                 | Miles.            | Direction.  | Rate. |                                                                       |                                   |    |
| Valencia ... .. | 60                | N. N. W.    | 18    | 4 a.m.                                                                | 31                                | 33 |
| Scilly ... ..   | 66                | N. W. b. N. | 18    | { 2 a.m.<br>6 a.m. }                                                  | 41                                | 41 |
| Holyhead ... .. | 89                | N. b. W.    | 18    | 11 a.m.                                                               | 76                                | 54 |
| Orkney ... ..   | 95                | N.          | 17    | 9 p.m.                                                                | 40                                | 39 |
| North Shields   | 69                | N.          | 18    | { 9 a.m.<br>10 a.m. }                                                 | 16                                | 33 |
| Yarmouth ... .. | 64                | N. E. b. N. | 20    | 5 a.m.                                                                | 31                                | 33 |
| Kew ... ..      | 33                | N. N. W.    | 18    | 7 p.m.                                                                | 0                                 | 23 |

BAROMETER AND WIND.

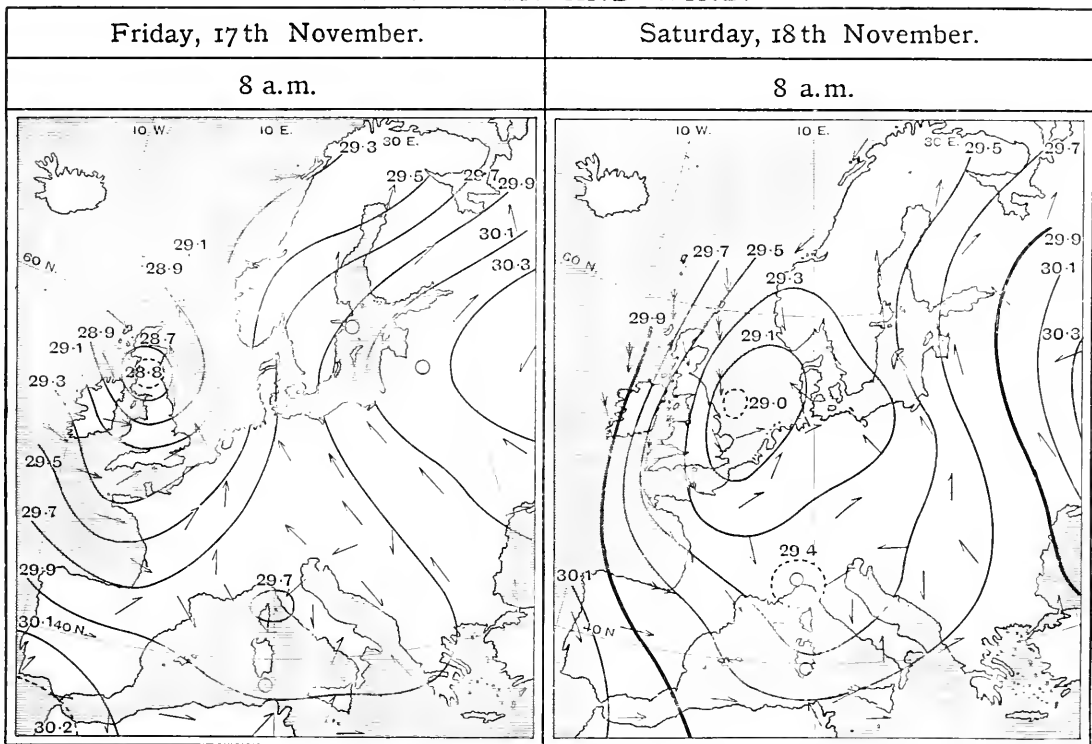

Diagram to illustrate the storm during the period of its greatest violence on November 17 and 18. The barometer is expressed by isobars, the pressure corresponding to each line being given in inches and tenths. The winds are shown by arrows which are drawn flying with the wind. ☉ = a calm; → = a light or moderate wind; →→ = a fresh or stormy breeze; →→→ = a gale.

barometer was 28.99 inches at Spurn Head, the centre of the disturbance being situated about 50 miles to the east of Scarborough, and travelling south-eastwards down our east coast. On the 19th the disturbance had reached Cuxhaven, where the barometer was reading 29.10 inches, and on the 20th it was passing away over central Europe, but gales were still blowing in the south-east of England and in parts of the North Sea.

The following table shows the strength of the wind in miles per hour as recorded by the velocity anemometers under the supervision of the Meteorological Council, who have kindly allowed access to the anemographs and tabulations:—

The factor 3 is used with all the anemometers for obtaining the velocity of the wind.

The hourly velocity at Orkney was 90 miles or above for 5 consecutive hours—from 9 p.m. 17th, to 1 a.m. 18th—and both this and the maximum velocity of 96 miles in the hour is in excess of any previous record in this country, the highest velocity in the hour previously recorded being 91 miles at Fleetwood in a gale which occurred on May 20, 1887. At Holyhead the wind was 65 miles or above, force 10 of Beaufort's notation, for 31 hours, and was 85 miles an hour or above for 4 hours.

The storm appears to have originated on November 7 to the east of the Florida coast, near the Bahamas, and

it can be tracked completely across the Atlantic to our islands, and eventually to central Europe on November 20. Several vessels keeping logs for the Meteorological Office, with standard instruments on board, have recorded observations on the storm during its passage across the Atlantic, and the Cunard steamship *Lucania* was under the influence of the disturbance during the whole of her passage from America to England. During the storm no fewer than 335 lives were reported as lost on or near our own coasts, this number being the result of reports received during the four weeks subsequent to the storm.

CHAS. HARDING.

PAUL HENRI FISCHER.

THE Museum of Natural History of Paris has suffered a great loss in the person of Dr. Paul Henri Fischer, the well-known zoologist and palæontologist, who died on November 29, after a long and painful illness. Born at Paris, on July 7, 1835, he received his early classical and medical education at Bordeaux. He became *Interne des Hôpitaux* of Paris in 1859, and obtained his degree of Doctor of Medicine in 1863. The study of medicine did not prevent him from devoting himself also to that of the natural sciences; for in 1861 he entered as Demonstrator in the Laboratory of Palæontology of the Museum of Paris, under the direction of M. d'Archiac. His researches chiefly concerned the living and fossil mollusca, and from 1856 he edited the *Journal de Conchyliologie* in collaboration with M. Crosse. From the position of Demonstrator he rose to be *aide-naturaliste* (assistant), and studied with great success the marine animals of the coasts of France, their geographical and bathymetric distribution. He indicated the depths at which a large number of foraminifera, cœlenterata, echinodermata, mollusca, bryozoa, &c. can be collected on the coasts of the west of France. In collaboration with the Marquis de Folin he undertook the study of the animals dredged in the extremely interesting region of the Gulf of Gascony, to which the name "Fosse du Cap Breton" has been given. The two savants discovered a large number of forms hitherto unknown, and many which recalled species only known in the fossil condition. With M. Delesse he made researches on the submarine sediments of the French shores. He was elected member of the Commission of Dredging, and took part from 1880 to 1883, on board the *Travailleur* and the *Talisman*, in the celebrated expeditions directed by Prof. Milne Edwards. In the course of these expeditions he noted the enormous extension of a cold fauna characterised by boreal and arctic species, and reaching as far as Senegal, where it lives beneath a superficial fauna with intertropical characters. Among the writings of Dr. Fischer, which number not less than 300 titles, including books, pamphlets and memoirs, we may cite: "Palæontologie de l'Asie mineure" (in collaboration with MM. d'Archiac and de Verneuil); "Mollusques de Mexique et de l'Amérique Centrale"; "Species général et iconographie des coquilles vivantes"; "Animaux fossiles du Mont Léberon" (in collaboration with MM. Gaudry and Tournouer); "Palæontologie de l'île de Rhodes"; "Cétacés du Sud-Ouest de la France"; "Catalogue et distribution géographique des mollusques terrestres, fluviatiles et marins d'une partie de l'Indo-Chine"; "Sur les caractères de la faune conchyliologique terrestre et fluviatile récemment éteinte du Sahara"; "Sur la faune conchyliologique de l'île d'Hainan"; numerous memoirs on the malacological fauna of Lord Hudson Island (Pacific Ocean), of Cambodge, of the islands of the Caledonian Archipelago, of Aleutian islands, of the Bay of Suez, &c. In collaboration with M. E. L. Bouvier he published papers on the anatomical peculiarities of certain groups of

molluscs. Finally, he wrote a remarkable treatise on conchology which has become classical ("Manuel de Conchyliologie et de palæontologie conchyliologique ou histoire naturelle des mollusques vivants et fossiles, suivi d'un appendice sur les Brachiopodes par Ehlert.") In this manual the author showed that the classification of molluscs ought to be based not alone on the form of the shell, but primarily on the anatomical characters.

Dr. Fischer was *Chevalier de la Légion d'Honneur* and *Officier de l'Instruction publique*. He obtained several prizes at the Paris Academy of Sciences, and had been President of the Zoological and Geological Societies of France. He possessed deep erudition, was a charming conversationalist, and after having treated a subject belonging to the domain of the natural sciences or of medicine, he was far from embarrassed if he had to discuss philosophy, literature, or æsthetics. The death of this savant, who was as affable as he was modest, has been a cause for general regret and for deep mourning among his large circle of friends.

EDMOND BORDAGE.

NOTES.

THE Academy of Natural Sciences of Philadelphia has awarded the Hayden Medal to Prof. Huxley. The medal is of bronze, and, with the balance of the interest arising from a sum of 2,500 dollars given to the Academy by the widow of the late Prof. F. V. Hayden, is awarded annually "for the best publication, exploration, discovery, or research in the sciences of geology and palæontology, or in such particular branches thereof as may be designated." The recipient in 1892 was Prof. E. Suess, and in 1891, Prof. E. D. Cope. Prof. J. Hall had the distinction of receiving the first award of the medal in 1890.

SIR HENRY ROSCOE has been appointed to the vacancy in the Senate of London University caused by the death of Sir William Smith.

AN Elliott Cresson Medal has been awarded to Mr. Nikola Tesla, by the Franklin Institute, for his researches in high frequency phenomena.

M. GUYON has been elected a member of the Section de Géographie et Navigation of the Paris Academy of Sciences, in the place of the late Admiral Paris.

DR. E. ZACHARIUS, Extraordinary Professor of Botany in Strasburg University, has been appointed Director of the Hamburg Botanical Gardens.

DR. J. K. HASSKARL, who introduced the cinchona plant into Java, died at Cleves, Germany, on January 5, at the age of eighty-two. In 1852 he was sent by the Dutch Government to South America to collect cinchona seeds and plants. He did not confine himself to collecting *Calisaya*, but gathered seeds and plants of other varieties, some of which were new. In 1854 he successfully carried about four hundred *Calisaya* plants to Java, but two years later he left Java, owing to differences between Dr. Junghuhn and himself on many vital principles of the system of cinchona culture. It is a singular fact, remarks the *Chemist and Druggist*, that the most valuable of all cinchonas, the *Laageriana* variety, was not introduced into the Indies by any of the collectors specially appointed by the British or Dutch Governments, but by a private trader in South America, the late Mr. Ledger.

THE annual general meeting of the Geologists' Association will be held at University College, London, on February 2. After the reading of the report and election of officers for the ensuing year, the President will deliver an address on "Geology in the Field and in the Study."

THE twenty-first annual dinner of the old students of the Royal School of Mines will be held on January 29. Among those who have promised to attend are Sir Lowthian Bell, F.R.S., Prof. Roberts Austen, C.B., F.R.S., Prof. Le Neve Foster, F.R.S., Prof. Thorpe, F.R.S., Prof. Rücker, F.R.S., Mr. P. C. Gilchrist, F.R.S., Mr. W. Topley, F.R.S., and other well-known authorities in the mining and metallurgical world.

IF succeeding numbers of the *Psychological Review* are of the same high character as the first, there is little doubt that the journal will meet with the success it deserves. The presidential address, delivered by Prof. Ladd, in December last, before the American Psychological Association, is included in this new *Review*, and several interesting contributions from the Harvard Psychological Laboratory. Among the latter is a paper in which an account is given of an experimental study of memory. The results show that, when isolated, the visual memory surpasses by far the aural, but when combined the aural excels the visual—in other words, in the united action of the senses of sight and hearing, their relative strength is just the reverse of what it is when they act independently. Another contribution from the Harvard Laboratory deals with the intensifying effect of attention. It is usually held that when the attention is directed to an object, the impressions received are intensified. The experiments at Harvard lead, however, to the remarkable result that all stimuli appear relatively less when the attention is from the outset directed to them. In addition to these original papers, the *Review* contains discussions of psychological subjects, and a survey of recent literature upon the subject.

WRITING in the U.S. *Monthly Weather Review*, Mr. Mark W. Harrington remarks that the influences of the wind and tide, and possibly the low barometric pressure of a storm area, in causing an unusual rise of water, is the occasion of much of the damage and loss of life that attends the storms of the Atlantic and Gulf coasts. Observations tending to fix the extent of this high water, and the special causes that produce it are, therefore, always desirable. Mr. Harrington has brought together the records of water, wind, and pressure for two storms, viz. June 4-5, 1891, at Galveston, and October 12-13, 1893, at South Island, Winyah Bay, S.C. The results show that in Winyah Bay, under the influence of winds that were estimated at 90 miles, although doubtless the maximum velocity of the open sea exceeded this, the actual height of the water exceeded that due to the natural tide by 7 or 8 feet. At Galveston, under the influence of easterly winds, whose measured velocity attained 44 miles, the maximum gauge reading was less than 4 feet above the slight natural tide. At these two stations, therefore, the rise in the water surface attributable to the winds is in both cases about twenty times greater than the height of a column of water that can be sustained by such winds in statical equilibrium, as in the Lind anemometer, and this factor is only slightly diminished by making some allowance for the rise of water due to the diminished barometric pressure.

DR. S. C. HEPITES has published, in the *Analele* of the Meteorological Institute of Roumania, a valuable *résumé* of the climate of Sulina from observations taken during fifteen years, 1876-90. The meteorological station is situated on the left bank of the Danube, very near to the sea, and was established by the European Commission of the Danube. The mean annual temperature is 51°·6, the mean difference between the hottest month, July, and the coldest month, January, being 43°·2. The absolute maximum observed was 98°·4, and the minimum -11°·2, which gives an extreme range of 109°·6. The mean relative humidity of the air is 76·5 per cent.; the autumn is damper than the spring. The annual amount of rainfall is only 17·3 inches, on sixty-four days; the wettest

month being June, and the driest, February. The greatest fall in twenty-four hours was 2·59 inches. The prevalent wind is from north-east, the relative frequency from this direction being 20 per cent. Thunderstorms are not of frequent occurrence; they occur mostly in June and July, and not at all in winter. Fog occurs on about twenty-five days in the year; considering the position of the town, we should have expected a more frequent occurrence of this phenomenon. Falls of dust have several times been noted; they apparently come from the Russian Steppes.

MR. J. GLAISHER, F.R.S., contributes to the Quarterly Statement just issued by the Palestine Exploration Fund, a paper on the fall of rain at Jerusalem in the thirty-two years from 1861 to 1892. The average annual rainfall is 25·23 inches, that is, very nearly the same as the mean for London, though the fall is very differently distributed throughout the year. A somewhat remarkable point brought out in the discussion is an evident increase of the fall of rain in the later years of the series of observations. The mean annual fall in the sixteen years from 1861 to 1876 is 22·26 inches, whereas in the sixteen years from 1877 to 1892 the mean is 28·20; therefore the mean annual fall in the second half of the series is 5·94 inches greater than in the first half.

THE honour of being the "oldest fossiliferous rock in Europe" has been claimed for certain strata in Bohemia. Barrande first worked out the Silurian and Cambrian basin in Bohemia, and described a "primordial fauna" at the base of the Cambrian slates near Skrej. Some time later, Prof. Kusta, of Rakonitz, found fossils in the strata below, which had been ranked as pre-Cambrian or Azoic by Barrande. Great interest naturally attached to this discovery of a so-called "ante-primordial fauna," and Prof. Kusta and others wrote several papers upon the fossils. Dr. Jahn, of the Austrian Survey, went for three weeks last summer to the same district, and found that many of the fossils occurred in strata interbedded with the Cambrian series, and had no right to be called "ante-primordial." In a short preliminary note sent to the *Verhandlungen der k. k. geol. Reichsanstalt*, September 30, 1893, he writes that the oldest of the "ante-primordial" horizons of Kusta rests above Cambrian shales and interbedded with them, while the so-called "youngest ante-primordial horizon" is in reality the oldest, resting immediately below the Cambrian of Barrande, and containing a similar fauna. As Dr. Jahn's statements rest on good stratigraphical evidence, we can only conclude that the "oldest fossiliferous rocks in Europe" have yet to be found.

THE Geological Commission of the Natural Science Society of Switzerland has just published vol. xxi. part i. of the "Contributions to the Geological Map of Switzerland" ("Beiträge zur Geol. Karte der Schweiz." Bern, 1893.) This part embraces the wide district of the Bernese Oberland Alps. The author, Dr. Edmund von Fellenberg, was always an enthusiastic mountain climber, and between the years 1862-1872 distinguished himself as a pioneer of some of the most difficult ascents in the Bernese group. He was asked, in 1872, by the Geological Commission to make a systematic geological survey of the district, and now gives in this volume of the "Beiträge" the complete result of his scientific labours. The maps which he used in surveying were on the scale of 1 : 50,000; those have been reduced to the scale of the Dufour map, 1 : 100,000. The value of the work is greatly enhanced by an elaborate "Atlas," containing eighteen plates and a map showing the routes undertaken by the author. The plates include an important series of coloured geological sections through the Breithorn, the Aletschhorn, the Jungfrau and the Finsteraarhorn mountains, a great number of sketches from nature illustrating in detail the geological features of the landscape, and several prints from photo-

graphs taken mainly for the purpose of demonstrating the intricate folding of the rocks and the varied effects of weathering in those glaciated Alpine areas. The "Atlas" merits a wider circle of admirers than merely the students of geology, for it reveals in the most effective manner the structure of one of the grandest regions of the Alps, a region which must be familiar to all English lovers of the Swiss lakes, Grindelwald, and the Rhone Valley.

THE *Electrician* of January 19 contains an interesting coloured map showing the electric-lighting districts of London. Our contemporary says that the chief alteration in the map, as compared with the one of last year, is the extension of the city mains. The Chelsea Company has run down the King's Road, but the London Company has followed it, and is in active competition. The Metropolitan Company and St. Pancras Vestry have thrown out a branch or two, but the additions to the mains have, on the whole, been made by "drawing in" additional conductors rather than by advance into new streets. In another place we read that the Owens College Physical Laboratory is prepared to test a limited number of electrical instruments free of charge. The testing will be carried out by qualified assistants, the electrical standards will be compared from time to time with those of the Board of Trade, and every effort will be made to ensure accuracy. All enquiries should be addressed to Prof. Arthur Schuster, Owens College, and headed "Physical Laboratory Testing Department."

THE recently published report of the Magnetic Observatory of Copenhagen for 1892 contains a description of the work which has been carried on in the "field," as well as tables containing the results of the observations made at the observatory. The tables given include the values of the declination, horizontal force, and vertical force for every hour for each day of the year (1892) as obtained from the self-recording instruments, the absolute value of the readings having been determined on five or six days in each month. There are also tables giving the diurnal variations which have been derived from measurements made on selected quiet days. Observations made in the island of Bornholm show that there exists considerable magnetic disturbance, for while if there were no disturbance the declination would vary between  $9^{\circ} 11'$  on the east side and  $9^{\circ} 29'$  on the west, it is found that at some places on the east shore the declination is  $11^{\circ}$ , and at one spot near the middle of the west shore values as low as  $7^{\circ}$  have been obtained. Observations which had been made in 1892 showed that the true lines of equal declination were in many cases closed curves, and thus the disturbances must extend to the surrounding water. With a view to tracing the isogonals after they leave the land, M. Hammer has made a series of declination observations on a raft which had been made without any iron, and a map showing the isogonals obtained is published in the report. The greater part of the island consists of granite containing iron, and a small piece of the rock when brought near the box containing the declination needle is found to give a deflection of from a few minutes to two degrees. A map showing by means of arrows the disturbances in horizontal force, indicates in a very clear and striking manner that there exists a strong centre of force a little to the north of the middle of the island. A special series of observations have enabled the magnetic effect of a number of dykes consisting of diabase to be shown and measured, a full account of which will be published in the *Bulletin de l'Académie Royale de Danemark*.

THE occurrence of true dropsical diseases of plants, not due to the activity of micro-organisms, has been placed beyond doubt by Mr. G. F. Atkinson, of Cornell University. Such a disease was noticed, as we read in a paper on the subject contributed to *Science*, in some tomatoes grown in the forcing-houses of

the University. The leaves were strongly curled, and the veins on the under side were swollen and whitened. The cells in the affected areas were stretched radially to an enormous extent. Finally they burst, giving out a large quantity of water, and leaving elongated, depressed, and blackened areas in various stages of decomposition. Inoculations of healthy plants with cultures from the diseased areas gave no result, and no fungi of ordinary dimensions could be discovered microscopically in the early stages of the trouble. The disease was purely physiological, and due to the preponderance of root-pressure over transpiration in the moist and warm atmosphere of the forcing-house, the leaves not being able to give out the moisture absorbed by the roots. The disease could be brought on artificially by subjecting healthy plants to pressure. Apple trees subjected to severe pruning during the winter suffered from a similar disease when growth began in the spring.

THE second part of vol. i. of "Contributions from the Botanical Laboratory of the University of Pennsylvania" is entirely occupied by a paper by Dr. J. W. Harshberger, entitled "Maize: a botanical and economic study." After a description of the anatomical and histological characters of *Zea Mays*, its origin is discussed at length, and this is followed by a treatise on its geographical distribution, and on its agriculture and economic value. The evidence appears to point, beyond a doubt, to the original home of the maize being Central Mexico, and not Asia, as some have supposed.

THE difficulty of satisfactorily differentiating between the typhoid bacillus and its constant companion the *B. coli communis* still remains, although numerous devices have from time to time been introduced, which have materially assisted in the separate diagnosis of these two bacilli. One of the most recent is that lately described by Dr. Schild (*Centralblatt f. Bakteriologie*, vol. xiv. p. 717), and is based upon the greater sensitiveness exhibited by the typhoid bacillus over the colon bacillus to the action of formalin vapour. Thus, whilst well-developed gelatine-cultures of the typhoid bacillus were destroyed when exposed for seventy-five minutes to the vapour derived from 5 c.c. of formalin, the *B. coli communis* was usually still alive after being similarly treated for two hours. The difference in this respect between these two organisms was still more strikingly brought out in their behaviour in broth to which formalin had been added, the typhoid bacillus being unable to grow in the presence of 1 : 15,000 parts of formalin, whilst the colon bacillus developed vigorously in broth containing 1 : 3000 parts. In order to turn this characteristic to practical account in the separate identification of the typhoid bacillus, Dr. Schild recommends that test-tubes containing 7 c.c. of sterile neutral broth should each receive 0.1 c.c. of a 1 per cent. solution of formalin, so that the formalin is present in the proportion of 1 : 7000; the inoculations are then made, and the tubes kept at  $37^{\circ}$  C. If typhoid bacilli are present, the solutions remain quite clear; but if the colon bacillus has been introduced, turbidity is apparent in twenty-four hours. By this method Dr. Schild states that he was able to separately identify the typhoid and colon bacilli in a sample of well water sent to him from a place where an epidemic of typhoid fever was prevailing.

A LARGE portion of the *Bulletin* of the Royal Gardens, Kew, Nos. 82 and 83, is occupied by an interesting report from Dr. King, of Calcutta, of a botanical exploration of the Sikkim-Tibet frontier, undertaken by Mr. G. A. Gammie. Other papers are on "Poling in Agave Plants," "Coffee Cultivation in the New World," and "The Resources of British Honduras."

A CATALOGUE has been issued showing the works on natural history, mathematical, and physical sciences, offered for sale by Mr. Bernard Quaritch.

THE number of the *Victorian Naturalist* for December, 1893, affords evidence of the activity of the study of various branches of natural history in that colony.

WE have received a paper, reprinted from the *Canadian Record of Science*, October, 1893, in which Mr. J. F. Whiteaves gives descriptions of two new species of ammonites from the Cretaceous rocks of the Queen Charlotte Islands.

DR. J. BERGEOHM has sent us a pamphlet entitled "Entwurf einer neuen Integral-rechnung," Heft ii., in which he develops a new method for the calculation of integrals, and deals with irrational, exponentials, logarithmic and cyclometric integrals, using his system.

MESSRS. C. GRIFFIN AND CO. have published a "Pocket-Book of Marine Engineering Rules and Tables," for the use of all engaged in the design and construction of marine machinery, naval and mercantile. The authors of the book are Mr. A. E. Seaton and Mr. H. M. Rounthwaite.

To those who purpose a tour in the Bernese Oberland, we can specially recommend a series of papers published in the recent numbers (211-214) of *Europäische Wanderbilder* (Zürich, 1893.) They are written by F. Ebersold, and give a general sketch of the country, as well as information about the new mountain-railways.

*Bulletin* No. 46 of the U.S. National Museum contains the collected writings, both published and unpublished, of the late Mr. C. H. Bollman, on the Myriapoda of North America. The papers have been edited by Prof. L. M. Underwood, who has added some notes and an introductory review of the literature of the North American Myriapods.

WE are pleased to see that the *Yorkshire Weekly Post* is now publishing weekly a well-written and accurate article dealing with the different branches of natural history, and in which the subject of ornithology and entomology in relation to agriculture is dealt with in a practical manner; miscellaneous science notes are also included, and their sources properly acknowledged.

THE "School Calendar and Handbook of Examinations and Open Scholarships," published by Messrs. Whittaker and Co., is now in its eighth year of issue. The book contains a mass of information concerning the conditions of entrance scholarships and fees in all our Public Schools, Universities, and educational institutions, and is invaluable to the schoolmaster and teacher.

A SECOND edition, revised and enlarged, has been issued of the Guide to Museum No. III. of Economic Botany at the Royal Gardens, Kew. The collection in this museum chiefly consists of specimens of timber, arranged in groups according to the countries producing them. The Guide contains much useful information with regard to the scientific character and economic value of the specimens.

MESSRS. MACMILLAN AND CO. hope to publish in a few days "The Theory of Heat," by Mr. Thomas Preston, Professor of Natural Philosophy, University College, Dublin. In this volume the science of heat is treated in a comprehensive manner, both in its experimental and theoretical aspects. The whole subject has been kept in view rather than the requirements of a particular examination, and the method of exposition is such that the general reader will be interested as well as the specialist.

THE number of *Anuario publicado pelo Observatorio do Rio de Janeiro*, which we have recently received, is the ninth that has been published, and is for the year 1893. In addition to various ephemerides and astronomical data, the volume contains some useful meteorological tables with data relating to the climatology and physics of the globe, tables for calculating altitudes from barometric observations, vapour tension, and several others for the use of physicists and those engaged in

chemistry. The fifth and concluding part gives the latitude and longitude of the chief places in Brazil, with the heights in metres of the chief cities above the sea-level, terminating with a brief sketch of the climate of Brazil in general. The tables seem all to have been carefully constructed and brought up to date.

"A HISTORY OF SCANDINAVIAN FISHES," by B. Fries, C. U. Ekström, and C. Sundevall, with coloured plates by W. von Wright, made its first appearance in 1836, and though it was issued in an incomplete form, it gained a wide reputation. As several unpublished paintings by v. Wright were preserved in the archives of the Royal Swedish Academy of Science, and the text of the work could be brought up to date with comparatively slight alterations, Messrs. Sampson Low, Marston, and Co. have decided to issue a new edition. The work of revision and enlargement has been entrusted to Prof. F. A. Smitt, the present occupier of Sundevall's post at the Royal Zoological Museum. The former edition contained descriptions and figures of 64 species; the new one will comprise about 220 Scandinavian species, besides several forms from neighbouring parts, and of special interest to the Scandinavian faunist. Thus the great majority of the fishes of Europe as well as of the Arctic piscine species will be represented in the work, and the new edition will be about four times as comprehensive as the former one.

THE interesting di-nitro derivative of marsh gas,  $\text{CH}_2(\text{NO}_2)_2$ , has been isolated in the pure state by Dr. Paul Duden, in the chemical laboratory of the University of Jena. As might be expected, it is a substance of little stability, and many of its metallic derivatives or salts, for the parent substance is endowed with acid properties, are dangerously explosive. The compound itself cannot be preserved, even in sealed tubes, for many hours, becoming converted into gaseous products of decomposition, but its potassium salt,  $\text{CHK}(\text{NO}_2)_2$ , is much more stable, and may be kept unchanged for months. The preparation of the acid is best achieved from this potassium salt, by decomposing it at a low temperature with dilute sulphuric acid. The potassium salt may be readily obtained by reducing the di-bromine derivative of dinitromethane by means of an alkaline solution of arsenious oxide. The di-bromine derivative is a substance obtained by distilling tribromaniline with nitric acid. It is added in small portions at a time to the strongly-cooled aqueous solution of the alkaline arsenite, in order to mitigate the violence of the reaction. After the completion of the change the potassium salt is deposited in small bright yellow crystals, which by recrystallisation from hot water yield the salt in perfectly pure large monoclinic prisms. The aqueous solution of these crystals is neutral to litmus, the strong acid being neutralised by the introduction of one atom of potassium. At a temperature near  $205^\circ$  the crystals detonate loudly, evolving a mixture of nitrogen, nitric oxide, and carbon dioxide. Concentrated acids violently decompose the crystals with evolution of red nitrous fumes, but if they are suspended in iced water, and a layer of ether is spread over the surface, they are quietly acted upon by dilute sulphuric acid with liberation of free dinitromethane, as above mentioned. The latter substance is dissolved by the ether, and the dried ethereal solution yields it after evaporation of the ether as a yellowish liquid of peculiar acid odour, and which soon begins to effervesce, owing to the elimination of products of decomposition. The free compound may be preserved much longer in ethereal or benzene solution. The silver salt,  $\text{CHA}_g(\text{NO}_2)_2$ , is the most remarkable of its salts. It crystallises in bright green tabular crystals, which are extremely sensitive to light. Mere boiling of their aqueous solution is sufficient to produce deposition of metallic silver. Either upon warming or by contact with a drop of hydrochloric acid, the crystals explode with great violence. Upon reduction of the iced solution of the potassium salt by sodium amalgam, a curious

substance of the composition  $\text{CH}_2\text{N}_2\text{O}$  is produced, which explodes below the temperature of boiling water. An account of the work is contributed to the current *Berichte*.

A NEW mode of preparing methylamine and ethylamine, based upon the reduction of the remarkable ammoniacal compounds of formaldehyde and acetaldehyde, is described by MM. Trillat and Fayollat in the current issue of the *Bulletin de la Société Chimique*. When aqueous solutions of formaldehyde and ammonia are mixed, a vigorous reaction occurs with considerable rise of temperature, and the evaporated liquid deposits hexagonal needles of the ammoniacal compound, the composition of which has been given by several chemists as  $\text{N}_4(\text{CH}_2)_6$ . It is now shown that the reaction can be much more simply explained in the light of the behaviour of the compound upon reduction, by accepting the simpler formula  $\text{N}_2(\text{CH}_2)_3$ . By the direct union of equal molecules of formaldehyde and ammonia, the substance  $\text{CH}_2 : \text{NH}$ , methylene imide, is supposed to be produced, two molecules of which then combine with another molecule of formaldehyde to produce the compound in question  $\text{CH}_2 \begin{matrix} \diagup \\ \text{N} : \text{CH}_2 \\ \diagdown \end{matrix}$  with elimination

of a molecule of water. This substance is rapidly broken up upon treatment with zinc dust and hydrochloric acid, and subsequent addition of caustic alkali, with liberation of methylamine. It is probable that four atoms of hydrogen are taken up during the reduction, thus fully saturating the molecule and

forming the compound  $\text{CH}_2 \begin{matrix} \diagup \\ \text{NH} \cdot \text{CH}_3 \\ \diagdown \\ \text{NH} \cdot \text{CH}_3 \end{matrix}$ ; this latter substance

then becomes converted into formaldehyde and methylamine by assimilation of water during the saponification with alkali. In order to prepare methylamine it is unnecessary to isolate the ammoniacal compound; formaldehyde and ammonia are simply mixed and immediately treated with zinc dust and dilute hydrochloric acid. The liquid is then saturated with caustic alkali, and the methylamine, together with excess of ammonia, expelled by a current of steam and received in dilute hydrochloric acid. Upon evaporation of the acid solution, a mixture of sal-ammoniac and methylamine hydrochloride is left, and the latter may readily be extracted by absolute alcohol. A second distillation of the methylamine hydrochloride with caustic alkali yields pure methylamine. Ethylamine may be similarly prepared by reduction and saponification of the well-known compound of acetaldehyde and ammonia.

THE additions to the Zoological Society's Gardens during the past week include a Himalayan Monkey (*Macacus assamensis*, ♀) from Sikhim, presented by Capt. Edmund A. Grubbe; a Bonnet Monkey (*Macacus sinicus*, ♀) from India, presented by the Rev. Thomas Rickards; two Japanese Pheasants (*Phasianus versicolor*, ♂ ♀) from Japan, presented by Mr. W. Rudge Rootes; two Spanish Terrapins (*Clemmys leprosa*) from Melilla, North Africa, presented by Mr. Bennet Burleigh; a Dwarf Chameleon (*Chameleon pumilus*) from South Africa, presented by Mr. E. Wingate; five Gigantic Salamanders (*Megalobatrachus maximus*) from Japan, deposited; a Cuvier's Podargus (*Podargus cuvieri*) from Australia, purchased.

#### OUR ASTRONOMICAL COLUMN.

REPORT OF THE WOLSHINGHAM OBSERVATORY.—The Rev. T. E. Espin is to be congratulated upon the large amount of good work he is carrying on at the Wolshingham Observatory. The system he adopts of sending out circulars announcing any new or strange phenomenon observed by him, is one that could be followed with advantage in many other observatories, for

astronomers thus have their attention drawn to interesting objects that they might otherwise have overlooked. We have noted the contents of these circulars from time to time, and the report that has just been issued sums up the work done in 1893. Sweeps for stars with remarkable spectra were made on fifty-three nights during the year. The total number of stars detected was 578, of which 489 were found to be new to Argelander's Chart. A thorough examination was made of the Red Region in Cygnus, and several new objects detected. Many nebulous objects were also met with, fifteen of which are not contained in the New General Catalogue. The Compton 8-inch photographic telescope was used during the year for photographing stars suspected of variation. The variability of four stars was confirmed, and three new variables were detected. Mr. Espin points out that it is much to be desired that the Compton instrument should be mounted separately, so that the large telescope could be devoted exclusively to spectroscopic work. During the latter part of the year photographic work was almost entirely discontinued, on account of the necessity of using the large telescope for spectroscopic observations. Early in last year the Observatory sustained a severe loss in the sudden death of Miss Brook, who equipped the Observatory with meteorological instruments, and generously defrayed all the incidental expenses. We hope a new benefactor will soon spring up and supply the much-needed mounting for the photographic telescope.

ANOMALOUS APPEARANCE OF JUPITER'S FIRST SATELLITE.—It will be remembered that in September 1890, Profs. Burnham and Barnard saw the first satellite of Jupiter, with the 12-inch telescope of the Lick Observatory, crossing the disc of the planet as a small dark double spot like a close double star (*Astr. Nach.* No. 2995). Various suggestions were made to account for this anomalous appearance, and it was even supposed for a time that the satellite was actually duplex. The explanation that found greatest favour in the eyes of astronomers, however, was that there was a permanent bright belt around the satellite, approximately parallel to Jupiter's belts, while the poles of this "Galilean star" are of a dusky hue. A repetition of the phenomenon was observed by Prof. Barnard, on September 25 of last year, with the 36-inch Lick telescope (*Astr. Nach.* No. 3206). The observations show that beyond doubt the second explanation is the true one. The satellite apparently rotates on an axis nearly perpendicular to the plane of its orbit. When it is over a portion of the Jovian disc as dark as its own polar regions, it appears more or less elongated, and parallel to the belts of Jupiter. But when it is projected on a brighter region it appears double, with the components in a line nearly vertical to Jupiter's equator, the dusky polar regions alone being visible. The smaller size of the southern component is very probably a perspective effect produced by a tilt towards Jupiter of the satellite's south pole.

ASTRONOMY AND ASTRO-PHYSICS.—The January number of *Astronomy and Astro-Physics* maintains the high reputation of that journal. Prof. W. H. Pickering describes a number of different telescope mountings in use in England and France, and compares them with some of those employed on the other side of the Atlantic. The history and work of the National Argentine Observatory forms the subject of a paper by Mr. J. M. Thorne, the director. The immense number of observations made in that Observatory testifies to the zeal of the astronomers as well as to the generally cloudless sky of Cordoba. Prof. S. W. Burnham gives a descriptive list of so-called double stars, of which the change of position is the result of proper motion. An important paper is contributed by Prof. F. H. Bigelow on the polar radiation from the sun, and its influence in forming the high and low atmospheric pressures of the United States. Prof. E. C. Pickering gives a brief account of the new star that appeared in the constellation Norma last summer, and was discovered by Mrs. Fleming on October 26, while examining a photograph of the spectra of the stars in its vicinity. An excellent plate accompanies the account, showing that the spectra of Nova Aurigæ and Nova Normæ were exactly alike, line for line. Among other articles of interest is one on Prof. Langley's recent progress in bolometer work at the Smithsonian Astro-Physical Observatory, and another on the object-glass grating, by Mr. L. E. Jewell. In the latter paper it is proposed to construct a photographic object-glass grating for use instead of the object-glass prism in obtaining photographs of stellar spectra. The plan suggested is to photograph a series of images of a long narrow slit. This



can be done by having a slit and photographic lens fixed and placing the sensitised plate upon the carriage of a dividing engine. The plate is moved along with the carriage, and when it has been exposed to the slit a desired number of times it is developed and fixed, the result being a photographic grating.

GEOGRAPHICAL NOTES.

A TELEGRAM from Zanzibar, dated January 16, states that over a hundred deserters from Mr. Astor Chanler's expedition had reached the coast and reported that he was left with only eighteen men at Daicho. It has already been mentioned (NATURE, vol. xlix. p. 112) that the expedition was deprived of Lieutenant von Höhnel's services, by an accident. We trust that Mr. Chanler may be able to reorganise his expedition, and push into the unknown country on the borders of which he has been so long detained.

The *Times* correspondent at St. Petersburg states that Mr. F. G. Jackson, after testing his sledges and other appliances in the neighbourhood of the Yugor Strait, is returning to England *via* Lapland, and that he has not been in the Yalmal peninsula. The proposed North Polar expedition *via* Franz Josef Land, will be, if it starts, as is expected, this year, the fourth in the field. The others are the private American expedition under Mr. Peary, working from the north of Greenland; the private Norwegian expedition of Mr. Ekroll, which left the north coast of Spitzbergen in summer, relying on a new convertible sledge-boat; and Dr. Nansen's expedition, drifting northward from the neighbourhood of the New Siberian Islands.

THE death is announced, on January 20, of General Sir C. P. Beauchamp Walker, the Foreign Secretary of the Royal Geographical Society.

THE memory of Prince Henry the Navigator, to whose persistent efforts the modern revival of oceanic exploration was mainly due, is to be honoured by the celebration of the 500th anniversary of his birth, in March, with great festivities at Oporto. The proceedings will to a certain extent resemble the Columbus celebration recently held in Spain. The event they are to commemorate was even more important, since the Portuguese explorers, as a direct consequence of the encouragement of the half-English prince, discovered the ocean-road to India, and incidentally the coast of South America also, independently of the Spanish voyagers who followed in Columbus' track.

SEVERAL recent experiments on oceanic currents by means of floats have been noticed in the newspapers within the last fortnight. Mr. J. E. Muddock states in the *Times* that a corked soda-water bottle containing an addressed slip of paper which was thrown overboard by him off the entrance to the Strait of Belleisle, on July 12, 1892, was picked up on November 28, 1893, on the Norwegian coast near Kvarno, in latitude 61° 4' N. The bottle was launched farther north than any of those placed in the water by the Prince of Monaco, but there is no clue to its course beyond that of the time elapsing before it was found, 485 days. Mr. Muddock assumes that the drift was 4000 miles, but the direct distance by sea is only 2500 miles, although it is probable that the bottle drifted south in the Labrador current before turning north-eastward with the Gulf Stream. Mr. Ballingall, of Largo, writes to the *Scotsman* that he launched a cork-covered bottle at Largo, on the Firth of Forth, on November 22, which was picked up at Akre, on the Norwegian coast (lat. 59° 19'), 460 miles distant, on December 29. Being only thirty-seven days in the water, the bottle must have drifted at the rate of not less than twelve miles a day. The bottle probably floated high and was helped by westerly winds; but in any case the rate of movement is rapid, and if the direction of the current was that usually assumed, first southward, then east, and finally north, the velocity is very remarkable.

EARTH MOVEMENTS.

EVERY year, every day, and possibly every hour, the physicist and observer of nature discovers something which attracts attention, causes wonder, and affords material for discussion. At one moment we are invited to see solidified air, at another to listen to telephonic messages that are being transmitted without a wire, or to pause with astonishment before a

pen which is producing a fac-simile of the writing, the sketches, and the erasures of a person who may be in a distant city. Not a day passes without a new creation or discovery, and novelties for our edification and instruction are brought to our notice at the meetings of societies and conventions which from time to time are held in various parts of the world. At the last meeting of the British Association, held in Nottingham, the attention of members was called to the reports of two committees summarising a series of facts which seem destined to open a new field in the science which treats of movements in the crust of our earth. For thirteen years one of these committees has devoted its attention to the volcanic and seismic phenomena of Japan, with the result that our knowledge of these subjects has been considerably extended. Now we observe that earthquakes, which are referred to as catastrophes in the processes of mountain formation and the elevation or depression along our coast-lines, are spoken of as "vulgar disturbances" which interfere with the observation of certain earth movements which are probably as common to England as they are to Japan.

Earthquake observations, although still capable of yielding much that is new, are for the present relegated to a subordinate position, while the study of a tide-like movement of the surface of our earth, which has been observed in Germany and Japan, earth tremors, and a variety of other movements, which we are assured are continually happening beneath our feet, are to take their place. Only in a few countries do earthquakes occur with sufficient frequency to make them worthy of serious attention. The new movements to which we are introduced are occurring at all times and in all countries, and we are asked to picture our continents as surfaces with a configuration that is always changing. We are told that every twenty-four hours the ground on which we live is gently tilted, so that the buildings in our cities, and the tall chimneys in our manufacturing towns, are slightly inclined like stalks of corn bent over by a steady breeze. The greatest tilting takes place during the night; in the morning all return to the vertical.

Why such a movement should exist, we are not told. All that we hear, is that it is too large for a terrain tide produced by lunar attraction. In Japan it appears possible that it may prove to be a concertina-like opening and shutting of the crumpled strata forming a range of mountains. To determine whether this intermittent puckering of strata, which would mean a daily increase and decrease in the height of mountains, explains the variability in the level of districts where observations have been made, is a matter for future investigation.

A problem which suggests itself in connection with this novel work will be to determine the limiting change in inclination, which we will assume means rock-bending, that culminates in sudden fracture and a jar, causing an earthquake.

Earthquake prophets up to the present appear to have lived upon the reputation of a few correct guesses, the non-occurrence of which would have been contrary to the laws of chance. As observation has shown us that a very large proportion of our earthquakes, like those which occur in the Himalayas and the Alps, and even those which occur in volcanic Japan, are produced by faulting or sudden breakages in crumpling strata, rather than by explosions at volcanic foci, it would seem that a study of the bending which leads to fracture would be a legitimate method to approach the vexed question of earthquake prediction.

Another class of movements to which our attention is called are our old acquaintances, the microseismic or tremor storms, which are now defined as long flat waves which give to the surface of our earth a movement not unlike the swell we so often see upon an ocean. Such disturbances are particularly noticeable whenever a district is crossed by a steep barometrical gradient. It is not unlikely that these movements, which are appreciable at considerable depths, have an effect upon the escape of fire-damp at our collieries, that they may influence the accuracy of delicate weighing operations—as, for example, during the determination of standard weights—that they may interfere with gravitational observations, and that they are a neglected source of error in certain classes of astronomical work. Our attention is next directed to the bending effect produced in certain districts by the rise and fall of the barometer, certain areas under variations in atmospheric pressure behaving as if they were the vacuum chambers of an aneroid.

Then there are the earthquakes of comparatively restful countries like our own. A large fault, by which mountains are suddenly lowered and valleys compressed, takes place in a distant country

like Japan. Near the origin of the dislocation the shaking brings down forests from the mountain-sides, and the neighbouring district is devastated. As the waves spread they become less and less violent until, after radiating a few hundred miles, they are no longer appreciable to our senses. But the earthquake has not ended. As long, flat, easy undulations it continues on until it has spread over the whole surface of our globe. The waves passing under Asia and Europe reach England first, while those crossing the meridian of our Antipodes and North America arrive somewhat later. At Potsdam, Wilhelmshaven, and in Japan, waves of this order have often been recorded, but for the rest of the world they are thus far unrecognised. Great cities like London and New York are often rocked gently to and fro; but these world-wide movements, which may be utilised in connection with the determination of physical constants relating to the rigidity of our planet's crust, because they are so gentle, have escaped attention.

That the earth is breathing, that the tall buildings upon its surface are continually being moved to and fro, like the masts of ships upon an ocean, are at present facts which have received but little recognition. Spasmodic movements which ruin cities attract attention for the moment, but when the dead are buried, and the survivors have rebuilt their homes, all is soon forgotten. It seems desirable that more should be done to advance our knowledge of the exact nature of all earth-movements, by establishing seismological observatories, or at least preventing those in existence from sinking to decay.

J. MILNE.

#### THE CLIMATIC AND NATIONAL-ECONOMIC INFLUENCE OF FORESTS.

IT is to German scientific men that we owe the first steps taken in order to ascertain data concerning the actual climatic effects of forests. Since then, however, most civilised countries, except Britain, have been actively engaged in the collection of accurate data concerning this very important subject. So far as those data have yet been collated and compared they lead to the following results.

It was not until the year 1867 that exact scientific observations were undertaken on an extensive scale to determine the actual influence which forests have in modifying the temperature of the air and of the soil within their own areas and over the surrounding tracts of country, and the first results were published in Ebermayer's celebrated work, *Die physikalischen Einwirkungen des Waldes auf Luft und Boden*, 1873.

1. *As regards Atmospheric Temperature.*—The average results of observations made during ten years (1876-85) throughout nearly the whole of Germany, and in parts of France and Switzerland, in different kinds of forest, at heights above the sea-level varying from 10 to 3000 feet, and at latitudes varying from  $47\frac{1}{2}^{\circ}$  to  $55\frac{1}{4}^{\circ}$ , prove conclusively that in general the annual average temperature within forests growing in closed canopy is lower than in the open, although the crowns of the trees are on the whole a little warmer in winter. The difference is greatest in summer, least in winter, and about midway between these extremes in spring and autumn; the mean annual difference, however, seldom amounts to over  $1^{\circ}$  Fahr. near the ground, and is scarcely  $\frac{1}{2}^{\circ}$  in the crowns. The prevention of insolation of the soil during the long hot days of summer, and the rapid transpiration taking place through the foliage, exert a greater influence on the atmospheric temperature than can be ascribed to shelter from wind and to decrease of nocturnal radiation.

The observations recorded prove (1) that the variations between the temperatures of the trees themselves and the air in the open exceed those between the woodland air and the latter except during winter, (2) that they are largest during the most active period of vegetation in summer, and (3) that they are greater in spring, when the circulation of sap begins, than during the autumn months, when vitality becomes sluggish and dormant.

In the crown of the trees, where insolation by day and radiation by night make their full influence felt, the difference in the daily average over the whole year is less than it is near the ground. In winter it averages little either above or below  $0^{\circ}$ , and in summer usually about the half of the reading at 5 ft. above the ground.

Observations made in Southern Germany establish the fact that in the forests it is cooler during the day and warmer during the night than in the open.

During the night the trees interfere with the radiation of heat, and in the day-time the shade afforded by the crowns keeps the air from being rapidly warmed by the sun's rays. These influences are naturally strongest during spring, summer, and autumn, when foliage is most abundant, whilst in winter the coniferous forests with evergreen foliage are milder than deciduous forests.

Owing to these differences in temperature, beneficial currents of air are induced between the forests and the open country, which follow the same law as obtains in regard to land and sea breezes. During the day the cooler and moister air of the forest sets outwards to take the place of the heated air ascending in the open; at night the current sets in from the open, cooled by radiation, towards the forest.

The statistics, upon which these deductions are based, prove that the immediate action of forests is to modify the daily maxima and minima of atmospheric temperature, whence it may be deduced that a comparison of the absolute extremes of temperature during the year must exhibit definitely the sum total of the influence exerted by forests on the temperature of the atmosphere. This modification of the extremes of temperature, which are bad alike for man and beast, and also for agricultural operations, is of immense importance from a national-economic point of view, since many places that were once fertile are now little better than barren wastes in consequence of the reckless denudation of forest.

In registering the data, however, it was observed that the geographical position, and the exposure of the forests to winds, exerted a certain amount of modifying influence in lessening the differences, and there are reasons to believe that towards the crown the forest temperature in winter is considerably higher than down nearer the ground. It was found, too, that certain forest trees exerted greater influence than others in consequence of the density of their foliage; for beech forests in summer exert, through their dense foliage and complete canopy, a considerably greater influence in diminishing the extremes of temperature than forests of spruce or Scots pine, although after defoliation their influence is merely similar to that of the pine forest, and only half so great as that of the more densely foliated spruce.

2. *As regards Soil-Temperature.*—The influence exerted on the soil temperature by forests growing in close canopy is of considerable importance, especially with regard to the soil-moisture. The observations made concerning this point seem to make it clear that the mean annual temperature of the soil in the forest is at all the above depths of observation cooler than in the open, and that the differences are greatest in summer, about the mean in spring and autumn, and very small in winter. In countries with warm summers this reduction of the soil-temperature over large areas by means of forest growth has a decidedly beneficial result. According to observations made in Württemberg, the difference between the maxima of soil-temperature in forests and in the open can extend so far as up to  $14^{\circ}$  Fahr.

It was also found that the daily differences in soil-temperature varied according to the season of the year, but that throughout nearly the whole year the upper layers of soil in the open were warmer in the afternoon than in the forenoon, whereas in the forest the variations were inconsiderable.

As with regard to the atmospheric temperature, the influence of the forest trees in equalising the soil-temperature throughout the year is greatest in the case of trees whose foliage is densest, spruce heading the list.

3. *As regards the Degree of Atmospheric Humidity.*—Observations recorded throughout Central Germany show that as regards the absolute humidity of the air forests have no appreciable climatic effect, for the annual averages showed merely slight traces of differences at 5 feet above the soil.

The differences between the relative humidity of the air in forests and in the open are, as might be expected, greatest in summer, although very different results as regard variations are obtained with changes of altitude and of other physical conditions.

The results of the various series of observations, corrected so as to eliminate, so far as possible, local differences due to altitude and other physical dissimilarities in the various meteorological stations, show that the mean annual relative humidity of woodland air is from  $3\frac{1}{2}$  to 10 per cent. greater than that of air in the open, but that the difference varies greatly according to the season of the year, being greatest in summer and autumn, and least in winter and spring. They show, too, that large

areas covered with spruce will be moister, as well as cooler, than those under woods of less densely foliaged species of trees. In Bavaria it was found that in summer, in consequence of the density of the foliage in beech forests during the most active period of growth, the difference even amounted to 13.6 per cent. of saturation over the relative humidity in the open.

4. *As regards the Precipitation of Aqueous Vapour.*—It has been shown above, not only that the atmosphere within the forest is cooler than in the open, but also that the temperature of the trees themselves is lower, especially in summer, than the air surrounding them; hence, when a current of air is wafted from the open into the forest, and comes in contact with the cooler trees, its temperature is reduced, and it is brought nearer to the point of saturation, *i.e.* its relative humidity increases. But if this air was already in the open at, or near, the point of saturation, then the effect of the cooling process is that a certain amount of surplus moisture beyond the aqueous vapour that can be held by the air up to a point of saturation at its reduced temperature must be released and precipitated in the form of dew. Woodlands, therefore, act as condensers of atmospheric moisture, and decrease the absolute humidity of the air whilst increasing its relative humidity; and in addition to this, they increase the humidity of the air by transpiration from the leaves, whilst the sap is being rendered available for structural purposes, and the work of assimilation is proceeding.

Endeavours have been made to establish, by means of careful observations, the effect of forests in regard to the precipitation of aqueous vapour in the form of dew or rain, but the results are often of so conflicting a nature that, up till the present, safe deductions cannot be drawn. In order to compare observations made in the forests with those made at the usual meteorological stations in the open, a correction would in each case be necessary to reduce the localities to the same sea-level, as air cools in rising and increases in relative humidity, *i.e.* it approaches the point at which it must precipitate some of the aqueous vapour held by it. Hence rainfall generally increases with the height of a locality above the sea-level, although no direct proportional increase can be proved. It fluctuates with the geographical position and the varying physical conditions of each point of observation, whilst variations in the direction of the moist winds of the locality also militate against the collection of reliable data for comparison with readings made in other localities.

The mean of the readings at 192 points of observation in Germany, corrected as carefully as possible with reference to these causes of difference, do not seem capable of giving any more exact inference than the general statement, that at high altitudes large extents of forest may considerably increase the local rainfall. As regards the quantity of rainfall and snowfall which is intercepted in forests by the leaves, branches, and stems of the trees, the observations made in Switzerland, Prussia, and Bavaria show that nearly one-fourth of all the precipitations of aqueous vapour is intercepted by the forest trees, and is given off again by evaporation, or is gradually conducted down the stems to the soil. In lofty forest-clad regions the mechanical action of the rains on the surface-soil is thus very much modified.

By means of their lower temperature, their greater relative humidity, and the mechanical obstruction they offer to the movements of currents of air, extensive forests act decidedly as condensers of the aqueous vapour contained in the atmosphere, and their influence in this respect is more marked at high altitudes and in mountainous districts than on plains or near the sea-coast, where other physical factors come into competition with and modify it. Further data are still requisite to enable us to determine with anything like certainty that forests directly cause increase of precipitations irrespective of such local considerations as the ruling direction of winds and peculiarities of situation; the generally accepted dictum is, however, that in the vicinity of extensive forests the rainfall is greater than at other localities under otherwise similar physical conditions.

In portions of the Russian Steppes, planted up nearly 50 years ago, the inhabitants assert that the summer rainfall has considerably increased, and that the danger to crops from drought is not so great as formerly, whilst the villages are also protected by the forest from the violence of the winter storms.

In summarising and criticising this point Prof. Endres of Karlsruhe remarks as follows:—

<sup>1</sup>Conrad, Elster, Lexis, and Loening's "Handwörterbuch der Staatswissenschaften," 1892, vol. iii. page 628.

"The data furnished from tropical countries must be accepted with the greatest caution, and in any case they afford no conclusive deductions for European circumstances. Blandford reports from India (*Meteorological Journal*, 1888) that in an area of 61,000 square miles, which was formerly denuded of woodlands, but has been planted up again from 1875, the rainfall has increased 12 per cent. since then. But H. Gannet (*Weather*, vol. v.) arrives at exactly the opposite conclusions for America, as his observations in the prairie region and in Ohio go to prove that the re-wooding of a tract exerts no perceptible difference on the amount of the aqueous precipitations. Lendenfeld also tries to prove that the clearance of woodlands in Austria has resulted in a better climate and an increase in rainfall, as the soil under eucalyptus remains hard as stone and inabsorptive, whilst it is rendered lighter and more porous by grass. (*Petermann's Geog. Mittheilungen*, vol xxxiv.)"

5. *As regards Evaporation of Soil-Moisture.*—The low temperature and the high relative humidity of the atmosphere in forests are unfavourable to rapid evaporation, which is still further reduced by the protection afforded to the soil against direct insolation and the action of winds. From observations extending over 10 years (1876-85) in various parts of Germany and Austria, the following relation is shown between evaporation in the forests and in the open in the vicinity of the forests: the differences would probably be greater if comparisons had been made with places in the open that were far removed from the modifying influence of the woodlands:—

|                                                                           | Water evaporated. |                                                                                                                                                                            |
|---------------------------------------------------------------------------|-------------------|----------------------------------------------------------------------------------------------------------------------------------------------------------------------------|
| In the open . . . .                                                       | 20.9 inches       | The practical importance of this will be seen, when it is recollected that the mineral food in the soil can be taken up by the rootlets only in the form of soluble salts. |
| In the forest . . . .                                                     | 9.5 "             |                                                                                                                                                                            |
| Lower in forest than in open by . . . .                                   | 11.4 inches       |                                                                                                                                                                            |
| Evaporation in forest expressed in percentage of that in the open . . . . | 46 per cent.      |                                                                                                                                                                            |

It was also found that the amount of evaporation depended on the class of forest, thus:—

| Species of Woodland.                | Percentage of Water.      |                        |
|-------------------------------------|---------------------------|------------------------|
|                                     | Evaporated in the Forest. | Remaining in the Soil. |
| Beech . . . . .                     | 40                        | 60                     |
| Spruce . . . . .                    | 45                        | 55                     |
| Scots pine . . . . .                | 42                        | 58                     |
| Clearing for reproduction . . . . . | 90                        | 10                     |

In these statistics no account has been taken of the quantity of water given to the air by transpiration through the leaves; but this is not of essential importance, as such supplies of moisture are drawn by trees, except during the earliest stages of growth, from the deeper layers of soil and subsoil not immediately and directly affected by the aqueous precipitations on the surface. This may be less true of spruce than of other trees.

The action of forests, therefore, is to retain in the soil a large proportion of the rainfall or of the moisture arising from the melting of snows, which, by percolation to the lower layers and the subsoil, tends to feed the streams perennially, and to maintain a constant supply of moisture, without which trees could not derive their requisite food-supplies from the soil.

The nature of the soil-covering below the forest trees exerts also considerable influence on the amount of moisture evaporated. From experiments conducted during five years in Bavaria it was found that a good layer of fallen leaves, and of *humus* or vegetable mould formed by their decay, is a powerful factor; it diminishes the evaporation by more than half, or reduces it to less than one quarter of that in the open, and thus adds very considerably to the surplus amount of moisture retained in the soil.

6. *As regards the Feeding of Streams and the Protection of the*

*Soil.*—From the above data it seems evident that the effect of extensive forests, more especially of those situated at high altitudes, is, by cooling the air and reducing its capacity for retaining aqueous vapour, to increase the precipitations. Whilst these precipitations are taking place the crowns of the trees intercept a large proportion of the total, and by breaking the violence of the rainfall protect the soil from the danger of being washed away during heavy storms. By the decomposition of fallen leaves and twigs a strongly hygroscopic soil-covering is formed, capable of imbibing and retaining moisture with sponge-like capacity. Rapid evaporation of the soil-moisture is counteracted through the protection afforded by the foliage against direct insolation during the day, and by the mechanical hindrance offered to currents of wind. The crown of foliage likewise prevents the soil cooling rapidly at night by radiation. The hotter the summer, the more marked are these beneficial effects of the woodlands.

When, therefore, large tracts of country are denuded of timber, increase of temperature during the days of summer, rapid radiation of soil-warmth by night, diminished precipitations (especially in the spring and summer), and unchecked evaporation of moisture, due to complete insolation of the soil by day and absence of any protection from winds, must be the inevitable consequences. Examples of such actual results can be pointed out in many parts of continental Europe, in Western Asia, and throughout India. In Great Britain and Ireland the effects of the wholesale clearance of woodlands have not been so marked, in consequence of the favourable influences exerted on our climate by the Gulf Stream.

In localities having no protective woodlands heavy rains wash away the surface-soil, torrents and freshets rush down the water-courses with great violence, laden with detritus and discoloured with the soil held in mechanical solution, whilst streams and rivers often overflow their banks in consequence, devastating large areas of low-lying tracts under cultivation. Forests, on the other hand, tend to break the violence of the rainfall, and retain for the time being about one-fourth of the total amount on the foliage and branches; the roots of the trees and of the undergrowth help to bind the soil firmly; the rainfall is retained by the vegetable mould and by the spongy growth usually found on the surface-soil, and thence gradually percolates to the deeper layers, where it is held in reserve, to be finally parted with in being utilised for the feeding of perennial streams having their sources on the wooded slopes.

Thus arose in the Alpine districts of Southern Europe the necessity for maintaining *ban-forests* as a protection against landslips, avalanches, &c., and legal measures were early adopted for safeguarding them in order to protect the lower tracts from erosion of the soil when sodden with rainfall or melted snow.

7. *As regards General Hygienic Effect on the Atmosphere.*—It is well known that on the one hand when large tracts of forest are cleared for cultivation, especially in tropical and sub-tropical countries, fever and ague are frequently the consequence, and on the other that the planting up of notorious fever districts, such as the Campagna di Roma, the Tuscan marshes, and the Russian Steppes, has decidedly diminished the insalubrity of these localities. But the causes are very probably rather due to the degree of direct insolation of the soil, freely afforded in the one case, and counteracted in the other, than to any hygienic property inherent in tree-growth. In the latter case, too, stagnating surplus of soil-moisture may have been got rid of by transpiration through the foliage, and this would of itself go far towards removing causes of insalubrity, and improving the climate.

It is generally accepted that ozone kills miasma in the air, and purifies it—at any rate impure air contains little or no ozone; the proportion of ozone is therefore usually taken as the measure of atmospheric quality. The belief that the woodland air is, like sea air, very rich in ozone has not yet been satisfactorily proved. Experiments in Bavaria showed that in the forests the percentage of ozone, though greater than that in the vicinity of towns, was slightly less than in the open in the vicinity of forests, and that there was no perceptible difference in this respect between coniferous and deciduous forests.

The woodland air was found to contain most ozone in winter, which shows that its production could not be due to any chemical action of the foliage, for there are no leaves on deciduous trees at that season, whilst conifers transpire merely, and do not assimilate. It also indicates that the excess is probably due

to the comparative freedom of air in the forest from the smoke, carbonic acid, and many other impurities with which air in the vicinity of towns is contaminated and defiled, and to the withdrawal of enormous supplies of oxygen from the air which takes place for the support of animal life at all populous centres. Thus whilst in general the quantity of carbonic acid in the atmosphere is somewhat under four volumes in 10,000, that is the normal amount in London air; but in thick fogs this proportion is frequently doubled, and has been known to be more than trebled, or even to exceed 14 volumes in the city.

Sunlight, however, has the power of decomposing carbonic acid in the presence of chlorophyll, the green colouring matter contained in foliage, the carbon being absorbed by the plant for its growth, and the oxygen set free. During darkness a contrary action takes place, oxygen being consumed by the foliage, and carbonic acid given off. As, however, particularly in the case of deciduous trees which are in leaf only from April till October, the hours of light far exceed in number those of darkness, the general hygienic effect of trees in cities and towns—apart from their invaluable æsthetic influence—tends decidedly towards the purification of the atmosphere from excess of carbonic acid.

Ozone again is an allotropic modification of oxygen obtainable by passing a series of electrical discharges through it; hence it is more than probable that in forests in exposed localities, more especially those at high altitudes, where storms and electrical disturbances of the air are most frequent, a greater quantity of ozone must be generated in the atmosphere than in localities less subject to such powerful ozonising influences.

Ebermayer, undoubtedly one of the greatest authorities on this subject, says<sup>1</sup> :—

“In the middle of the great ‘ozone-factory,’ which we must consider the forest to be, neither more oxygen nor less carbonic acid is offered to mankind for breathing than over large wooded areas.”

At another part of the same article he also adds<sup>2</sup> :—

“From the hygienic standpoint it is worthy of notice that, according to my examinations, the air in and immediately above the crowns, then that in the immediate vicinity of the forests, has more ozone than that in the interior of the forests, where a portion of the ozone is consumed by the decomposing foliage lying on the ground.”

It appears, therefore, to be his matured opinion at present that whilst more ozone is found in forests than in the open—which the Austrian students of the subject deny, or at any rate are not yet prepared to admit without further observations and proofs—yet the decomposing matter covering the soil consumes the surplus, and often more than that, so that no difference can be established in favour of the forest air. In this withdrawal of ozone in excessive quantities from the air by decomposing vegetable matter, the unhealthiness of tropical jungles, and the prevalence of malaria at all the lower elevations within the tropics usually covered by woodlands, seem easily explainable.

According to Endres and to Fernow<sup>3</sup> it is claimed that forests tend to resist the spread of epidemics, and to offer a bar to the progress of diseases like cholera and yellow fever.

Regarding the *Sanitary Influence of Forests*, the latter states (*op. cit.* p. 21) as his summary that “(1) the claimed influence of greater purity of the air due to greater oxygen and ozone production does not seem to be significant; (2) the protection against sun and wind, and consequent absence of extreme conditions, may be considered favourable; (3) the soil connections of the forest are unfavourable to the production and existence of pathogenic microbes, especially those of the cholera and yellow fever, and the comparative absence of wind and dust, in which such microbes are carried in the air, may be considered as the principal claim for the hygienic significance of the forest.”

Fortunately there are not many infectious diseases the germs of which can be carried by water; as yet only two are known with certainty, cholera and enteric fever. When outbreaks of these diseases occur in tropical countries, the infectious power of the germs is favoured by warmth and moisture; moreover, when epidemic, these diseases usually break out in thickly populated towns and similar localities, where it is impossible to submit

<sup>1</sup> “Hygienische Bedeutung der Waldluft und des Waldbodens” in vol. xiii. of “Forschungen auf dem Gebiete der Agricultur-Physik,” edited by Prof. Wollny, 1890, p. 429.

<sup>2</sup> *Op. cit.*, p. 455.

<sup>3</sup> “Forest Influences,” p. 172, 1893.

the soil-moisture or the water-supply to the filtrating action of belts of woodland.

8. *As regards the Agricultural Productive Capacity of Neighbouring Tracts, and the National-Economic Effect on the Soil generally.*—From an agricultural standpoint, a dry season is much preferable to a low temperature and excessive rainfall. In the former case the crops, although they may be somewhat scanty, are invariably of superior quality. A wet season may produce abundant crops, but they are generally of low quality.

With regard to the influence of forests on the aqueous precipitations throughout central Europe, Prof. Endres makes the following remarks<sup>1</sup>:—

“The question whether woodlands can influence the rainfall is one of the most important from a national-economic point of view. Even if this could be distinctly affirmed, the beneficial action of forests would only be established in the rarest cases, for throughout central Europe at present the number of too wet years exceeds that of dry years. *In districts where the rainfall is over 40 inches, any increase is undesirable.*”<sup>2</sup> For agriculture very dry years are on the whole less disastrous than extremely wet years. The precipitations of any district are influenced mainly by the position of the mountain ranges with reference to the cardinal points of the compass, by its elevation above sea-level, and its distance from the sea.”

But, as the American investigations prove (*idem.* p. 13), no influence upon the general climate which depends upon cosmic causes can in reason be expected from a forest cover. Only local modifications of climatic conditions may be anticipated, but these modifications, if they exist, are of great practical value, for upon them rest success or failure in agricultural pursuits, and comfort or discomfort of life, within the given cosmic climate. The same condition must be insisted upon with reference to forest influences upon waterflow, which can exist only as local modifications of water conditions, which are due in the first place to climatic, geologic, and topographic conditions.”

Even so early as in Roman times it was recognised that too great a clearance of woodland areas brought undesirable changes in the physical conditions of Italy, and affected the welfare of the inhabitants. That the destruction of the ancient forests throughout Great Britain and Ireland, to such an extent that only 3·8 per cent of the total area can now be classified as woodlands (*vide* Parliamentary Report on “Forestry,” dated August 5, 1887), was not followed by such disastrous climatic changes as were occasioned by similar causes throughout the Landes, Syria, Asia Minor, Greece, Russia, and many parts of India, we owe entirely to our insular position with its moist climate, and to the happy effects wrought by that portion of the Gulf Stream which reaches our western and southern shores.

Early in the present century, for example, the Agricultural Society of Marseilles reported that in consequence of the reckless destruction of the forests after the revolution of 1789:—

“The winters are colder, the summers hotter, and the beneficial spring and autumn showers no longer fall; the Uveaune, flowing from east to west, rushes down in flood with the least rain, carrying away its banks and flooding the richest pasturage, while, for nine months of the year, its bed lies dry owing to the drying-up of the streams.”

To a similar cause also Prof. Geffcken (in *The Speaker* of January 6, 1893) attributes the Russian famine of 1892 in the following terms:—

“We speak of the deficit (in the Russian Budget) of 1893 as certain, and it is easy to show that it will be so. *The principal cause of the present dearth is the drought during the last spring and early summer, and this absence of rain is greatly due to the devastation of the forests.* The area formerly covered with timber was enormous, the woods belonging to the Crown, to the great landed proprietors, and to the village communities. But the means of transport were then so imperfect and costly that only in the neighbourhood of large rivers did the felling of timber pay. This changed with the construction of railways

and the abolition of serfdom; the former gave the possibility of selling with profit, and the peasants abandoned their woods to speculators for what they thought a good price, little thinking of the future; the larger proprietors followed their example; the purchase money was spent in drink and luxurious living, and no one thought of replanting. *Too late has the Government issued a law for the protection of forests. Such a devastation going on for 20 years not only exhausts a source of wealth, but has also other bad consequences.* When the country is deprived of its trees, the earth is dried up and crumbles from the hills; the water coming down from heaven cannot be kept back as is the case with the woods, which act as a sponge, but rushes in torrents into the rivers and disappears in the sea, and the consequence is a gradual diminution of the fertility of the soil and the disappearing of numerous brooklets and small rivers, to help the larger ones show a low water-mark, which proves prejudicial to the navigation.”

This view is confirmed by the special correspondent of the *Times* (*vide* article “Through Famine-stricken Russia” in issue of April 18, 1892), who writes:—

“I have now travelled over most of the famine-stricken provinces, and I have been struck by the sameness of the picture. Everywhere reckless extravagance meets the eye, the forests have been cut away wantonly, the rivers are neglected, the climate is ruined.”

Such also appears to have been the opinion of Major Law, Commercial Attaché to the British Embassy at St. Petersburg, as expressed in his “Report on Agriculture in the South-Eastern Provinces of European Russia,” commented on in a leading article of the *Times* of September 17, 1892, in the following words:—

“It is said that this gigantic natural tillage farm (*i.e.* the ‘black-soil’ region) was formerly hedged in by belts of forest, which served the twofold purpose of sheltering it from the desert winds and of increasing the humidity of the climate. It is certain that these forests do not now exist, and that the black-soil country is often scourged by devastating blasts from the steppe, and not infrequently baked by prolonged droughts. The desert winds pile the snow in drifts into winter, which become the source of destructive torrents in the spring. In summer the same winds are so fierce and arid that in the space of a few hours they wither the corn as it stands, while, when they are laden with sands, they smite the soil itself with perpetual barrenness.”

All writers, indeed, who have recently published views on this subject, seem agreed as to the main causes of the recent Russian famine.<sup>1</sup>

In order to obtain the full national-economic benefits that are derivable from woodlands, the areas reserved as forests or planted up should be scattered over the face of the country as equally as possible. In all countries where the population is thin, and primeval forest is still to be found, measures with this end in view can easily be carried out without inflicting any apparent hardship on the existing community. But wherever danger from famine is apt to recur from time to time, it would at the same time seem to be worthy of consideration whether it would not be wise to expropriate tracts of the poorer and higher land here and there, and plant them up on a well-considered scheme for the purpose of ameliorating the climatic conditions for man and beast in the future.

J. NISBET.

### SCIENTIFIC SERIALS.

*American Journal of Science*, January.—Researches in acoustics, No. 9, by Alfred M. Mayer. This paper deals with the law connecting the pitch of a sound with the duration of its residual sensation, and with the smallest consonant intervals among simple tones. The residual sound, *i.e.* the sound perceived by the ear after the actual vibration has ceased, was investigated by means of an apparatus consisting of a tuning-fork vibrating close to the opening of a resonator. The nipple of the resonator was placed opposite a hearing-tube leading to the ear, and the sound was interrupted by a rotating perforated disc interposed between the nipple and the opening of the tube. The discs, which were made of mahogany covered with cardboard, had several circles of holes, and intercepted the sound very

<sup>1</sup> See also the article on “The Penury of Russia” in the *Edinburgh Review* for January 1893 (pp. 17-19), which may be said to contain a summary of the best opinions on the matter.

<sup>1</sup> “Hygienische Bedeutung der Waldluft und des Waldbodens” in vol. xiii. of “Forschungen auf dem Gebiete der Agricultur-Physik,” edited by Prof. Wolny, 1890. p. 607.

<sup>2</sup> This is a point of very great importance with reference to the proposals of Mr. Munro Ferguson, M.P. (*Contemporary Review* for October 1892, pp. 521, 522), for planting up the Highlands of Scotland, and Dr. Macgregor’s three questions in the House on the same subject on November 13, December 12, and December 19, 1893. For if there be already any tendency towards more rainfall during the summer months than is good for agricultural crops, an extensive increase in the acreage of woodlands in such vicinities is not desirable.

effectively. The discs were worked by a hand-pulley and fly-wheel, controlled by a clock beating seconds loudly. The residual sensations obtained, by noticing at what speed the sound became continuous, ranged from 0.0231 secs. in the case of  $U_{12}$ , frequency 128, to 0.0049 secs. in the case of  $U_{15}$ , frequency 1024. The smallest consonant intervals were determined by noticing when the beats coalesced into a smooth tone. The residual sensations deduced from these experiments were found to be about one-third greater than those obtained by the former method.—Petroleum in its relations to asphaltic pavement, by S. F. Peckham. While it has been well known for years that bitumens occur in great variety, the selection of a proper material for softening the asphalt, to the exclusion of others less desirable or wholly unfit, appears to have escaped attention. A properly selected material should enter into chemical union with both the constituents of the bitumen in the asphalt, thereby increasing its adhesive and binding properties upon the other constituents of the mastic. The proportion of bitumen to sand and other non-bituminous ingredients should be as 1 : 9, a larger amount of bitumen making the pavement too soft, and a smaller amount giving too little stability.—The age of the extra-moraine fringe in Eastern Pennsylvania, by E. H. Williams, Junr. All observations tend to the conclusion that there was but one ice age in Pennsylvania, and that a short and recent one.—The internal work of the wind, by S. P. Langley (see Notes).—Post-glacial æolian action in Southern New England, by J. B. Woodworth. This paper treats mainly of the action of blown sand in carving rocks and boulders.

In the *Botanical Gazette* for November, 1893, we find a paper on the Food of green plants, by Mr. C. R. Barnes, in which he proposes the term *photo-syntax* for the process of formation of complex carbon compounds out of simple ones under the influence of light.—Mr. H. L. Russell continues his account of the Bacterial flora of the Atlantic Ocean in the vicinity of Woods Holl, Massachusetts; and Miss F. D. Bergen, her useful Record of popular American plant names.

THE third and concluding part of vol. vi. of Cohn's *Beiträge zur Biologie der Pflanzen* contains three important papers.—Dr. M. Scholtz describes the changes in position which take place in the flower-stalk of *Cobea scandens* before and after flowering. It affords the first recorded instance of an organ with complicated anisotropy. During the development of the bud the flower-stalk exhibits strong negative geotropism and positive heliotropism. After the opening of the flower, which is strongly proterandrous, changes take place in the position of the stamens and style which bring the stigma nearly into the position previously occupied by the anthers.—Herr G. Karsten gives further details of the embryology of *Gnetum*: the development of the male, of the imperfect female, and of the perfect female flowers being described in detail. In the perfect female flowers there are always at first several embryo-sacs; and in some species two or three of these remain till the period of fertilisation, and are capable of impregnation. The actual process of impregnation presents some analogy, on the one hand, to that in the Coniferæ, on the other hand to that in the Casuarinæ. The generative nucleus of the pollen-grain divides within the pollentube, as in the Coniferæ. The two portions of this nucleus enter the embryo-sac and coalesce with one of its nuclei. In some species secondary embryos are produced.—R. Hegler gives details of experiments on the influence of mechanical traction on the growth of plants.

*Bulletins de la Société d'Anthropologie de Paris*, Tome iv. (4e Série), No. 10.—The greater part of this number of the *Bulletins* is occupied by the replies of M. J. M. van Baarda to the questions of the Anthropological Society with regard to the island of Halmahera, or Gilolo, in the Moluccas. M. G. de Mortillet contributes some palæographical notes on the lower valley of the Seine; and MM. E. Fournier and C. Rivière describe the discovery of objects of the Robenhausian period in the Grotto Loubière, near Marseilles.

#### SOCIETIES AND ACADEMIES.

##### LONDON.

Royal Society, January 18.—"On the Transformation of Optical Wave-Surfaces by Homogeneous Strain." By Oliver Heaviside, F.R.S.

"On the Reflection and Refraction of Light." By G. A. Schott, formerly Scholar of Trinity College, Cambridge.

NO. 1265, VOL. 49]

Chemical Society, December 21, 1893.—Dr. Armstrong, President, in the chair.—The following papers were read:—Corydaline. Part iii.: Oxidation with potassium permanganate, by J. J. Dobbie and A. Lauder. The authors have investigated corydalnic acid,  $C_{11}H_7N(OMe)_4(COOH)_3$ , obtained by oxidising corydaline with potassium permanganate.—The properties of  $\alpha$ -benzaldoxime and some of its derivatives, by W. R. Dunstan and C. M. Luxmore. Both  $\alpha$ -benzaldoxime and its acetyl-derivative may be obtained in the solid state by cooling. The authors are at present examining a number of addition products of the former substance with the halogen acids.—The interaction of acid chlorides and nitrates, by H. E. Armstrong and A. Lapworth.—The freezing points of triple alloys, by C. T. Heycock and F. H. Neville. The existence of a compound of silver and cadmium of the composition  $2AgCd$  seems probable from the results of freezing point determinations of mixtures of these metals in tin, lead, or thallium solution. The behaviour of solutions of silver and cadmium in bismuth points to the formation of the compound  $4AgCd$ . Aluminium and gold appear to form the compound  $AuAl_3$  when dissolved together in molten tin.—Synthesis of pentamethylenecarboxylic acid, hexamethylenecarboxylic acid, hexhydrobenzoic acid, and azelaic acid, by E. Haworth and W. H. Perkin, junr. The authors have prepared the acids mentioned above from the products of interaction of a mixture of tetra- and penta-methylene bromides and ethylic sodiomalonate.—The conversion of ortho into para- and of para- into ortho-quinone derivatives: I. The condensation of aldehydes with  $\beta$ -hydroxy- $\alpha$ -naphthylamine, by S. C. Hooker and W. C. Carnell.—The synthesis of lapachol, by S. C. Hooker. An isomide of lapachol is obtained by heating an acetic acid solution of hydroxynaphthoquinone with valeric aldehyde and hydrochloric acid.

Geological Society, January 10.—W. H. Hudleston, F.R.S., President, in the chair.—The following communications were read:—On the Rhetic and some Liassic Ostracoda of Britain, by Prof. T. Rupert Jones, F.R.S. The published observations on the occurrence of these Microzoa in the Rhetic and Lower Liassic strata of England, chiefly in Gloucestershire and Somerset, by the Rev. P. B. Brodie, H. E. Strickland, C. Moore, and others, were given; and the various notices of the so-called *Cypris liassica* in various palæontological works were considered. Numerous specimens submitted by the Rev. P. B. Brodie, the Rev. H. H. Winwood, and Mr. E. Wilson, and some few examined in the Geological Society's collection, have been studied, with the result of determining the characters and alliances of *Darwinula liassica* (Brodie) and of six or seven other species found in the same and the associated series of strata. The *Darwinula globosa* (Duff), from Linkinsfield, Morayshire, was also critically re-examined as one of this interesting series of Rhetic Ostracoda. The other species belong for the most part to *Cytheridea*; thus most of them probably lived in brackish or estuarine waters. The President and Dr. Henry Woodward spoke on the subject of the paper, and the author replied.—Leigh Creek Jurassic Coal-Measures of South Australia: their origin, composition, physical, and chemical characters; and recent subaërial metamorphism of local superficial drift, by James Parkinson. This paper dealt with the lignitic coal of Leigh Creek and associated rocks. Analyses were given, as illustrating comparisons between the Leigh Creek coal and Jurassic and other coal-bearing rocks found elsewhere. The author discussed the origin of the Leigh Creek deposits, and described certain peculiarities noticeable in the superficial materials. The President and Mr. Browne made a few remarks upon the subject of the paper.—Physical and chemical geology of the interior of Australia: recent subaërial metamorphism of Eolian sand at ordinary atmospheric temperature into quartz, quartzite, and other stones, by James Parkinson. South of the Flinders Range fragments of stone of all sizes are found on the ground, the origin of which the author discussed. He maintained that they were formed by subaërial metamorphism of Eolian deposits. A discussion followed, in which the President, Mr. R. D. Oldham, Prof. T. Rupert Jones, Dr. H. Woodward, Mr. Marr, Dr. G. J. Hinde, and Mr. E. T. Newton took part.

Zoological Society, January 16.—Sir W. H. Flower, K.C.B., F.R.S., President, in the chair.—The Secretary read a report on the additions that had been made to the Society's menagerie during the month of December, 1893.—Mr. Slater exhibited and made remarks on a drawing of the head of a monkey (*Cercopithecus erythrogaster*) in the Paris Museum, forwarded to him by M. Pousargues, of that institution.—An extract

was read from a letter received from Mr. C. B. Mitford, describing an invasion of locusts observed at Free Town, Sierra Leone. Mr. C. O. Waterhouse had referred the specimens of these insects sent home to *Pachytylus migratoroides*. A further extract from the same letter gave an account of the occurrence of the elephant in the district of Sierra Leone.—Mr. R. Lydekker gave an account of some of the principal objects observed during his recent visit to the La Plata Museum, calling special attention to the splendid series of remains of Dinosaurian reptiles, of Cetaceans, and of Ungulates of three different sub-orders. Mr. Lydekker also made remarks on some of the specimens of Edentates, and of the gigantic birds of the genus *Brontornis*.—Mr. Lydekker also exhibited a painting of the head of a wild goat (*Capra agagrus*) of unusual size.—On behalf of Mr. J. Jenner Weir, a specimen of the Tsetse Fly (*Glossina morsitans*) from the Transvaal was exhibited.—Mr. Tegetmeier exhibited a curiously barred variety of the common pheasant.—A communication was read from Prof. W. N. Parker, containing remarks on some points in the structure of the young of the Australian Echidna.—A communication was read from Mr. Roland Trimen, F.R.S., giving an account of a collection of butterflies made in Manica, Tropical South-east Africa, by Mr. F. C. Selous in the year 1892. Of 166 species represented in the series, 44 were stated to be of general distribution, and of the remainder (amongst which were nine apparently new to science) 26 were peculiar to the South-Tropical area of Africa.—A communication received from Dr. A. B. Meyer contained remarks on a rare African monkey (*Cercopithecus wolfi*), accompanied by a coloured drawing.—Dr. A. Günther, F.R.S., gave an account of a collection of reptiles and fishes made by Dr. J. W. Gregory during his expedition to Mount Kenia. The collection contained examples of 37 species of reptiles, 9 of Batrachians, and 13 of fishes. Several species of reptiles were new to science, amongst which were two new lizards—*Bufoenemis modesta*, g. et sp. n., of the family Geckotidæ, with imbricate scales and large scattered conical tubercles on the hinder part of the hind limbs; and *Agama gregorii*, allied to *A. cyanogaster*, but with lateral, not tubular nostrils. Six new fishes were also characterised and named:—*Chromis niger*, *Chromis spilurus*, *Alestes affinis*, *Labeo gregorii*, *Barbus tanensis*, and *Barbus taitensis*.

Royal Meteorological Society, January 17.—Dr. C. Theodore Williams, President, in the chair.—The council in their report stated that the Society had made steady and uninterrupted progress during the year, there being an increase in the number of Fellows, and the balance of income over expenditure being greater than in 1892. They also reported that Dr. C. Theodore Williams, previous to vacating the office of President, had expressed a desire for the formation of a fund for carrying out experiments and observations in meteorology, and that he had generously presented to the Society the sum of £100 to form the nucleus of a research fund.—The President, Dr. C. Theodore Williams, in his valedictory address gave an account of the climate of Southern California, which he made most interesting by exhibiting a number of lantern slides. In the autumn of 1892 Dr. Williams visited this favoured region, chiefly with a view of investigating its present and future resources, and its suitability for invalids. After describing the entrance into California from Utah and Nevada, the general geography, and the mountain ranges, he pointed out that the mountain shelter is tolerably complete, and that the protected area consists of (1) valleys, chiefly running into the coast range from the sea, and rising to various elevations, such as the fertile San Fernando and San Gabriel valleys, or else (2) more or less extensive plains, as those of Santa Ana and San Jacinto. Southern California is subdivided into two portions, eastern and western, by the Sierra Nevada, and its spurs, the San Gabriel and San Bernadino mountains. The climate of the eastern portion, which is an arid region, is very dry, very hot in summer, and moderate in winter. The climate of the western portion has three important factors, viz. (1) its southern latitude, (2) the influence of the Pacific Ocean, and especially of the Kuro Suvo current, which exercises a similar warming and equalising influence on the Pacific coast of North America as the Gulf Stream does on the western coasts of the British Isles and Norway; and (3) the influence of mountain ranges, these affording protection from northerly and easterly blasts, and also condensing the moisture from the vapour-laden winds blowing from the Pacific. Dr. Williams then gave particulars as to the temperature and rainfall at Los Angeles, San Diego, Santa Barbara, and Riverside. From these it appears that the climate of Southern California is warm and

temperate, and on the whole equable, with more moisture than that of Colorado, and that it is a climate which would allow of much outdoor life all the year round. The President next described the effect of the climate on vegetation, and showed what results had been obtained by diligent watering and gardening in this beautiful region. Wine and brandy are made in South California, but oranges and lemons are the leading crops, varied with guavas, pineapples, dates, almonds, figs, olives, apricots, plums and vegetables. On higher land, apples, pears and cherries bear well, and our English summer small fruit is also grown; while strawberries ripen all the year round, and are plentiful except in July and August. Dr. Williams concluded by saying that many an invalid has regained vigour and health, as well as secured a competence, in the sunny atmosphere of Southern California.—Mr. R. Inwards was elected President for the ensuing year.

Linnean Society, January 18.—Mr. W. Carruthers, F.R.S., Vice President, in the chair.—Messrs. T. B. Cato, W. Elborne, and R. E. Leuch were admitted, and the following were elected:—Sir Hugh Law, Messrs. G. B. Rothera and Thomas Sim.—The chairman, before proceeding to the business of the evening, referred to the loss which the Society had sustained by the recent death of Mr. Richard Spruce, who had travelled and collected much in South America, and who was the recognised authority on *Hepatica*. It was much to be regretted that, having but lately presented to the Society a valuable paper on this subject, containing descriptions of a great number of new species, and illustrated with careful and beautiful drawings, he had not lived to see the published result of his labours. The chairman also feelingly referred to the death of Mr. Algernon Peckover, of Wisbech, who had been a Fellow since 1827, and who by his will had bequeathed to the Society a legacy of £100.—Mr. E. M. Holmes exhibited a flowering specimen of a new species of *Cascarilla* (*C. Thomsoni*), and the bark of the tree from New Granada; also two new foreign seaweeds, *Gelidium Beckii* from South Africa, and *Leptocladia Binghamie* from California, and three new British marine algae, viz. *Entophysalis granulosa* and *Symploca atlantica* from Swanage, collected by himself; and *Vaucheria coronata* from Arbroath, collected by Mr. J. Jack.—Mr. Thomas Christy exhibited and made observations upon some remarkably long tendrils of *Landolphia Kirckii*, which served as an illustration to a paper subsequently read by Mr. Henslow.—Mr. J. E. Harting exhibited and made some remarks upon the plant *débris* ejected in the form of "pellets" or "castings" by rooks, and stated that a number of these pellets which had been examined were composed of the cuticles of the succulent root of the couch grass *Triticum repens*, commonly called "scutch," "squitch," and "twitch" grass, a most troublesome weed to the farmer. Mr. Harting also exhibited a rare Australian duck, *Stictonetta neozosa* (Gould), which had been obtained at Gippsland Lakes, Victoria, and of which very few examples were to be found in collections.—A paper was then read by the Rev. G. Henslow, on the origin of the structural peculiarities of climbing stems by self-adaptation in response to external mechanical forces. The purport of this paper was to prove, by an appeal to facts and experiments, the existence of the power in living protoplasm of responding to external and purely mechanical forces by enveloping supportive tissues, by means of which the plant is enabled to resist the effects of gravity, tensions, pressures, &c. In the case of climbers, not only is this principle illustrated wherever a force is felt, but whenever a strain is relieved of a force atrophy, or arrest of mechanical tissues takes place, supplemented, however, by an increase in the number and size of vessels. The conclusion arrived at was that while, on the one hand, the peculiar structures of climbers are all the outcome of a response to the external mechanical forces acting directly upon the stems, such structures are precisely those which are most admirably suited to the requirements of the stems themselves. The variations of structure characteristic of species, genera, and orders of climbing plants have been thus acquired in a definite direction, viz. of direct adaptability, this being effected, according to Mr. Darwin's statement, "without the aid of natural selection." The paper was criticised by Dr. D. H. Scott, Prof. Reynolds Green, and Mr. G. Murray, who, while testifying to the number of interesting facts brought forward by Mr. Henslow to support his views, were yet unable to agree with him in several of his conclusions. The paper was illustrated by a great variety of specimens and drawings, and was listened to with considerable interest by a very full meeting.

PARIS.

Academy of Sciences, January 15.—M. Lœwy in the chair.—The death of M. P. J. van Beneden was announced, and a short account of his scientific career given by M. Émile Blanchard.—On the theory of the photography of simple and compound colours by the interference method, by M. G. Lippmann. The mathematical theory of the action of light on the photographic film is developed at length.—On a problem in mechanics, by M. A. Potier. The author gives a simple solution of the problem proposed by M. J. Bertrand concerning the law of the forces for a point describing a conic section.—Studies on the formation of carbonic acid and the absorption of oxygen by the detached leaves of plants. Experiments made at the ordinary temperature with the concurrence of biological activity, by MM. Berthelot and G. André. The results for wheat, *Corylus avellana* and *Sedum maximum*, are compared with the results, previously obtained and described, of strictly chemical character, and hence the results of the biological activity of the living matter of the leaves are deduced.—On a method for the study of gaseous exchanges between living things and the atmosphere which surrounds them, by M. Berthelot. A method is indicated whereby, by means of periodical analyses of an atmosphere, which is large compared to the respiratory needs of the living specimen, the changes caused by the organism can be examined while it is living in the normal manner.—On the chronostylographic method, and its applications to the study of the transmission of waves in tubes, by M. A. Chauveau. A description of the use of some improved instruments such as might be used for the study of the movements of all kinds occurring in the animal economy.—Observations on the *Æpyornis* of Madagascar, by MM. A. Milne-Edwards and Alired Grandidier. A quantity of new material from Madagascar has been examined with the result that the remains have been classed in two main divisions, *Æpyornis* and *Mullerornis*, each with several described species.—Generalisation of some theorems in mechanics, by M. A. Kotelnikoff.—On the pendulum of varying length, by M. L. Lecornu. A mathematical study of the conditions during the oscillation of a pendulum of which the length varies in a definite manner.—Emission of sounds, by M. Henri Gilbault. It is shown that, in the ordinary case of vibrating bodies of three dimensions, the time occupied in communicating its energy to the air varies with the nature of the surface of each particular body.—Is there oxygen in the atmosphere of the sun? A note by M. Arthur Schuster. Attention is directed to a letter by the author published in NATURE (December 20, 1877) in connection with M. Duner's recent communication on this subject.—On the magnetisation of soft iron, by M. P. Joubin. The characteristic equation deduced from Rowland's experimental results is  $x = 1 + 0.33(1-y) \pm 1.3\sqrt{1-y}$  where  $x = \frac{I}{I_c}$  and  $y = \frac{K-K_0}{K-K_0}$ ; I is the intensity of magnetisation, and K the susceptibility of the material.—The relation of storms at Parc de Saint-Maur to the position of the moon, by M. E. Renou. The author believes that he has shown that, in this district, storms are more frequent with a northern than with a southern declination of the moon.—On the combination of hydrogen and selenium in an unequally heated space, by M. H. Pélabon. A thermodynamical study of the reaction, showing that the experimental results agree with the predictions.—Ceric bichromate and the separation of cerium from lanthanum and didymium, by M. G. Bricout. A crystalline bichromate is deposited electrolytically from a solution of cerous carbonate in chromic acid, lanthanum and didymium give no deposit on the positive pole from chromic solution, hence a method for the separation of cerium as a pure soluble salt.—Researches on the desiccation of starchy matters, by MM. Bloch.—On the liquid from albuminous perioritis, by M. L. Huzouenq. Analyses show that the perioritis exudation resembles that of "hydrathione" most nearly.—Influence of atmospheric agencies, particularly light and cold, on the pyocyanogenous bacillus, by MM. d'Arsonval and Charrin.—On the amibocytes, the oogenesis and the ovi-deposition of *Micronereis variegata*, by M. Émile G. Racovitz.—On the synchronism of the coal basins of Commeny and St. Etienne and its consequences, by M. A. Julien.—On the epidermis of the egg-bearing peduncles and seeds of *Bennettites Moreri*, by M. O. Lignier.

BOOKS, PAMPHLETS, and SERIALS RECEIVED.

BOOKS.—The Fauna of the Deep Sea: Dr. S. J. Hickson (Kegan Paul).—The Technique of Post-Mortem Examination: Dr. L. Hektoen (Chicago, Keener and Co.).—Climates of the United States, in Colors: Dr. C. Denison (Chicago, Keener and Co.).—Physiology Practicum: Dr. B. G. Wilder (the Author, Ithaca).—Biologischer Atlas der Botanik, Serie "Iris," Erläuternder Text: Dr. A. Dodel.—Ditto, Tafel 1 to 7 (Zürich, Schmidt).—The Royal Natural History, Vol. 1, Part 3 (Warne).—Ninth Annual Report of the Bureau of Ethnology (Washington).—Annals of the Astronomical Observatory of Harvard College, Vol. xxix. Miscellaneous Researches made during the Years 1883-93 (Camb. Mass.).—Ditto, Vol. xxv. Comparison of Positions of Stars &c., &c.: W. A. Rogers (Waterville, Me.).—Ditto, Vol. xl. Part 2, Observations made at the Blue Hill Meteorological Observatory, Mass., U. S. A., in the year 1892: A. L. Rotch (Camb. Mass.).—Ditto, Vol. xxxi. Part 2. Investigations of the New England Meteorological Society for the year 1891 (Camb. Mass.).—Heat, an Elementary Text-Book, Theoretical and Practical: R. T. Glazebrook (Cambridge University Press).—The Yoruba-Speaking Peoples of the Slave Coast of West Africa: A. B. Ellis (Chapman and Hall).—Congrès International de Zoologie. Deux. Session à Moscou, Deux. Partie (Moscou).

PAMPHLETS.—Sugar Maples, and Maples in Winter: W. Trelease (St. Louis, Mo.).—Royal Gardens, Kew, Official Guide to the Museums of Economic Botany, No. 3, Timbers, 2nd edition (Eyre and Spottiswoode).—Notes of Research on the New York Obelisk: A. A. Julien.—Some Ancient Relics in Japan: R. Hitchcock (Washington).—The Ancient Burial Mounds of Japan: R. Hitchcock (Washington).—Sinto, or the Mythology of the Japanese: R. Hitchcock (Washington).—The Ainos of Zezo, Japan: R. Hitchcock (Washington).—The Ancient Pit Dwellers of Zezo, Japan: R. Hitchcock (Washington).—Bibliography of the Saisihan Languages: J. C. Pilling (Washington).—The New Nauticality of the Nile: Drs. Sarruf and Niur (Cairo).—Report of the Superintendent of the U. S. Naval Observatory for the Year ending June 30, 1893 (Washington).—The Cincinnati Southern Railway: J. J. Hollander (Baltimore).

SERIALS.—Zeitschrift für Wissenschaftliche Zoologie, lvii. Band, 2 Heft (Williams and Norgate).—The Psychological Review, No. 1 (Macmillan).—The Botanical Gazette, December (Bloomington).—Gazzetta Chimica Italiana, Vol. 2, fasc. 12 (Palermo).—Palestine Exploration Fund, Quarterly Statement, January (Watt).—The Quarterly Journal of Microscopical Science, January (Churchill).—Quarterly Review, January (Murray).—Zeitschrift für Physikalische Chemie, xiii. Band, 1 Heft (Leipzig).—Journal of the Franklin Institute, January (Philadelphia).—Journal of Physique, January (Paris).—Proceedings of the Academy of Natural Sciences of Philadelphia, 1893, Part 2 (Philadelphia).—Bulletin of the U. S. National Museum, No. 46.—The Manapoda of North America: C. H. Bollman (Washington).—Rendiconto dell' Accademia delle Scienze Fisiche e Matematiche, Serie 2, Vol. 7, fasc. 8 and 12 (Napoli).—Astronomy and Astro-Physics, January (Firenze).—Nuovo Giornale Botanico Italiano. Nuova Serie (Vol. 1, No. 1 (Firenze).

CONTENTS.

PAGE

|                                                                                                                                        |     |
|----------------------------------------------------------------------------------------------------------------------------------------|-----|
| Recent Public Health Works . . . . .                                                                                                   | 285 |
| The Latest Text-Book of Geology. By Prof. A. H. Green, F.R.S. . . . .                                                                  | 287 |
| The Chemistry of the Blood . . . . .                                                                                                   | 289 |
| Agricultural Botany for Extensionists . . . . .                                                                                        | 290 |
| The Principles of Hospital Construction . . . . .                                                                                      | 290 |
| Our Book Shelf:—                                                                                                                       |     |
| Gregory: "The Vault of Heaven" . . . . .                                                                                               | 291 |
| Harris: "A Journey through the Yemen, and some General Remarks upon that Country" . . . . .                                            | 291 |
| Letters to the Editor:—                                                                                                                |     |
| The Directorship of the British Institute of Preventive Medicine.—Sir J. Fayer, K.C.S.I., F.R.S.; Prof. Victor Horsley, F.R.S. . . . . | 292 |
| The Origin of Rock Basins.—R. D. Oldham . . . . .                                                                                      | 292 |
| On the Change of Superficial Tension of Solid-Liquid Surfaces with Temperature.—Prof. G. F. Fitzgerald, F.R.S. . . . .                 | 293 |
| A Lecture Experiment.—G. S. Newth . . . . .                                                                                            | 293 |
| Pierre Joseph van Beneden . . . . .                                                                                                    | 293 |
| The Great Gale of November 16-20. (With Diagram.) By Chas. Harding . . . . .                                                           | 294 |
| Paul Henri Fischer. By Dr. Edmond Bordage . . . . .                                                                                    | 296 |
| Notes . . . . .                                                                                                                        | 296 |
| Our Astronomical Column.—                                                                                                              |     |
| Report of the Wolsingham Observatory . . . . .                                                                                         | 300 |
| Anomalous Appearance of Jupiter's First Satellite . . . . .                                                                            | 300 |
| Astronomy and Astro-Physics . . . . .                                                                                                  | 300 |
| Geographical Notes . . . . .                                                                                                           | 301 |
| Earth Movements. By Prof. John Milne, F.R.S. . . . .                                                                                   | 301 |
| The Climatic and National-Economic Influence of Forests. By Dr. J. Nisbet . . . . .                                                    | 302 |
| Scientific Serials . . . . .                                                                                                           | 305 |
| Societies and Academies . . . . .                                                                                                      | 306 |
| Books, Pamphlets, and Serials Received . . . . .                                                                                       | 308 |



THURSDAY, FEBRUARY 1, 1894.

## CHINESE CENTRAL ASIA.

*Russian Central Asia: a Ride to Little Tibet.* By Henry Lansdell, D.D., M.R.A.S., F.R.G.S., Author of "Through Siberia," "Russian Central Asia," "Through Central Asia," &c. Two Vols. (London: Sampson Low, 1893.)

THERE are few, if any, men who have travelled so extensively throughout the length and breadth of Asia as Dr. Lansdell, and in the work before us he has given an interesting account of his last great journey of 50,000 miles, which occupied "two years and seven months, of which 525 were travelling, and 425 were stationary days. The regions visited comprised five of the kingdoms of Europe, four of Africa, and every kingdom of Asia. The methods of travel were 18,000 miles by railway, 25,000 by water, and 7,000 by driving and riding on the backs of horses, camels, donkeys, yaks, elephants, mules, and men."

Dr. Lansdell is a privileged person, high in favour with influential men in Russia, as well as in England, and has always been permitted to travel freely in all parts of Russia, without let or hindrance, to an extent which would probably hardly be allowed to anyone else. He speaks with high praise of the civility and courtesy with which he was everywhere received, by officials and others; but apart from this, we are glad to find that now that the Russians have consolidated their power in Central Asia, they are gradually giving up their old exclusiveness, as witness the recent experiences of Lieut. Coningham.

Dr. Lansdell's primary objects, as before, were chiefly missionary. He distributed copies of the Scriptures in the various languages of the countries through which he passed; visited mission stations, and prisons, and noted everything likely to be useful for directing future efforts in the same direction. But he has avoided making this feature too prominent a part of his book; and we are glad to see that there is scarcely a word in reference to other religions which could give offence to the most fastidious, except, perhaps, in his sometimes speaking of Mohammed as "the false prophet."

One object which Dr. Lansdell set before him was to penetrate to Lassa; but, unfortunately, the difficulties which have baffled every recent traveller happened to be increased at the time by a war on the Indian frontier; and it is needless to say that he did not succeed. It is to be inferred from his historical notes that Tibet was originally closed against foreigners by the Chinese, and that the custom has since been maintained by the Tibetans.

The greater portion of the book is taken up with the personal narrative of the author's journey. He started from London to St. Petersburg, and thence to Baku, and *via* the Transcaspien Railway to ninety-one miles beyond Bokhara, where the line then terminated, though it was being pushed forward at the rate of three miles per day. Thence he proceeded to Issik-Kul, Vierny, Kuldja, Aksu, Yarkand, and over the Karakorum to India, China, Japan, &c., and then back to London *via* the Suez Canal, visiting many more countries on the way. It is,

however, only the early part of the journey, as far as India, which is described in detail.

The Transcaspien Railway was not in existence at the time of Dr. Lansdell's previous journey in Russian Central Asia in 1882; but as far as Kuldja the journey of 1888 frequently intersected and sometimes coincided with that of 1882, and the author observed and notes many changes which had taken place in Bokhara, Samarcand, Tashkend, &c., since his former visit. At Issik-Kul, and still more beyond Kuldja, he began to break entirely new ground, and it is here that the most interesting part of his narrative begins. We may note incidentally that he obtained a new fish (*Diptychus Lansdelli*, Günther) at Lake Issik-Kul.

It was not to be expected that during so long and difficult a journey the author should have been able to give attention to every possible subject of interest, but he succeeded in obtaining a large series of photographs of views and natives. Many of these photographs were used to illustrate magazine articles, and have been reproduced in this book. The author, therefore, apologises for the unfinished state of some of his illustrations, on the score of their having been originally prepared for the exigencies of rapid newspaper printing. The numerous types of races figured should make the book very useful to anthropologists; and the natural history appendices and lists of birds, insects, fish, &c., in which the author had the assistance of various eminent naturalists, will appeal to zoologists. Other matters worth noticing, from a literary and scientific point of view, are the maps, the bibliography and chronology (compiled by Mrs. Lansdell), and the geographical and historical information scattered through the book. To travellers about to set out for the same countries, the account of the author's personal experiences cannot but be of much value, though others can hardly expect to be so exceptionally fortunate as Dr. Lansdell.

Things are greatly changed for the better in Central Asia since the Russian occupation, and Dr. Lansdell was everywhere received as a guest, and treated with the utmost hospitality during the greater part of his journey. It was only between the Russian and British frontiers that he appears to have encountered any very serious hardships, and even these were in large measure due to the difficult nature of the country to be traversed.

Among the Kirghese tribes, near Issik-Kul, the idea of sympathetic cures is firmly fixed.

"Thus for an obstinate attack of yellow jaundice, they wear on the forehead a piece of gold, or better, cause the patient to look at it for a whole day, or if a piece of gold be lacking, which is generally the case, they substitute a glass basin."

At Vierny, Dr. Lansdell found many traces of the great earthquake which had devastated the town in the year previous to his visit. We believe that it is somewhat unusual for countries so far inland to be liable to earthquakes, and that Central Asia is exceptional in this particular.

At Kuldja, the author put up at "the best inn in the town; above the average of Chinese inns elsewhere."

"This was my first experience of a Chinese inn, and it made my flesh creep. Passing through a wide doorway, we entered a square courtyard, with rooms on two sides, and occupied in the centre and on a third side by

horses, carts, and drivers. The removal of such trifles as foul straw and manure was deemed superfluous, and through this I had to wade towards the door of a room, and there wait till the coal in it was swept into a corner, and what looked like a brewing apparatus removed.

"There was no flooring, not even of bricks, and no furniture, but at the end of the room was a *kang*, or platform of loose boards, over what appeared to be an ash-pit, though the cinders, no doubt, represented the remains of fires for winter heating. Over this receptacle for rubbish of various kinds I was to sleep and eat."

Besides this, there was an intrusive crowd at the door and window, a flour-mill at work, and the jingling of horse and mule bells in the yard. "This went on all day; and what with the stench of manure, distracting noises, windows unglazed, and inquisitive visitors, my lodging proved to be the worst I had ever had." One man defended his intrusion on the traveller's privacy by asking, "Cannot I come into a room in my own country?"

Here the author was invited to breakfast with Kabichang, the Commissary of Russo-Chinese affairs, where he found a variety of dishes, including black putrid eggs, a special delicacy in China.

After leaving China, Dr. Lansdell crossed the Tian Shan into Chinese Turkestan by the Muzart Pass, at a height of 11,000 or 12,000 feet. Here the Chinese picket did their best to smooth the way by laying boughs of trees across crevasses, and covering them with blocks of ice, for the men and horses to cross to the crest of the pass, a nearly perpendicular ice cliff with steps cut in it, down which horses are sometimes lowered by ropes; but in this case, one man took a horse's head, and another hung on by the tail, and thus, wonderful to relate, they contrived to descend in safety.

This formidable pass has, it appears, never been crossed before by any European; and from this point Dr. Lansdell proceeded to Aksu, the most important place on the way to Kashgar and Yarkand, where he found much to interest him, including criminals wearing the *cangue*, or wooden frame round the neck, a familiar punishment in China. Thence he travelled to Kashgar, passing, on the way, through a place called Maralbashi, where the chief mandarin has a drum before his door, and if this is struck, he is bound to attend at once to the appeal of any suppliant. But, to avoid any trouble, if the drum is struck, the mandarin orders the disturber of his peace one hundred lashes, and then asks his business.

From Kashgar Dr. Lansdell proceeded to Yarkand and Khotan, and at the latter place he witnessed a dance of dervishes, of which he gives an illustration. He was anxious, at Khotan, as well as elsewhere, to take photographs of some of the native beauties, but having no opportunity of seeing them unveiled, he was advised to tell his landlord that he wanted a pretty wife, and to ask him to bring him half a dozen on approval.

Here and there we meet with occasional natural history notes on collecting butterflies, or on birds, &c. observed. For example, we read (vol. ii. p. 270):—"Of aquatic birds I obtained specimens of the white-bellied dipper (*Cinclus leucogaster*) at Ak-Shor, and afterwards at Tribhun. We often noticed this little fisher boldly plunging into the swiftest torrents, seeking insects in a stream the half of which was congealed to solid ice." On the Kilian Pass, about the

height of Mont Blanc, Dr. Lansdell had his first experience of mountain sickness. He slid off his yak, and attempted to run up a hill to shoot partridges, but was seized with palpitation of the heart, and was forced to sit down to rest immediately. He appears to have suffered more here than even on the great Karakorum Pass further south (18,800 feet instead of 16,000).

Thus our author gradually made his way to India, where we will now leave him. There are so many detached points of interest mentioned in his work, that our limited space has only permitted us to select a few, here and there, to show its interesting and varied character.

The book is dedicated "To his August and Imperial Majesty, the Emperor of China, &c., &c., &c."

W. F. KIRBY.

#### HUXLEY'S COLLECTED ESSAYS.

*Collected Essays.* By T. H. Huxley. Vol. I. "Methods and Results." (London: Macmillan and Co., 1893.)

THERE is probably no lover of apt discourse, of keen criticism, or of scientific doctrine who will not welcome the issue of Prof. Huxley's essays in the present convenient shape. For my own part I know of no writing which by its mere form, even apart from the supreme interest of the matters with which it mostly deals, gives me so much pleasure as that of the author of these essays. In his case more than in that of his contemporaries it is strictly true that the style is the man. Some authors we may admire for the consummate skill with which they transfer to the reader their thought without allowing him, even for a moment, to be conscious of their personality. In Prof. Huxley's work, on the other hand, we never miss his fascinating presence: now he is gravely shaking his head, now compressing the lips with emphasis, and from time to time with a quiet twinkle of the eye making unexpected apologies or protesting that he is of a modest and peace-loving nature. At the same time one becomes accustomed to a rare and delightful phenomenon. Everything which has entered the author's brain by eye or ear, whether of recondite philosophy, biological fact or political programme, comes out again to us—clarified, sifted, arranged, and vivified by its passage through the logical machine of his strong individuality.

These essays were, he says in preface, "written for the most part in the scant leisure of pressing occupations, or in the intervals of ill-health." Though the oldest bears the date of 1866, he finds, so far as their substance goes, nothing to alter in them. "Whether," he concludes, "that is evidence of the soundness of my opinions or of my having made no progress in wisdom for the last quarter of a century, must be left to the courteous reader to decide."

The first volume of the nine, which are to be issued monthly, owes its title to the inclusion therein of the famous essay "On Descartes' Discourse touching the method of using one's reason rightly," and of samples of the application of that method in various fields. Amongst the latter are the essays on the physical basis of life, on the hypothesis that animals are automata, on administrative nihilism, and on the natural inequality of men.

The essay on animal automatism was delivered as an evening address at the meeting of the British Association at Belfast, when Tyndall was president. It was a truly marvellous performance, for it occupied nearly an hour and a half, and was delivered with an appearance of complete spontaneity and ease in the very words which are here printed, without a note or reference of any kind, by a man who, when he first attempted it, "disliked public speaking" and, as he tells us, had a firm conviction that he should break down every time he opened his mouth. To some readers, as to myself, the short "autobiography," with which the volume commences, will be new, and owing to its charming frankness and graceful reticence the most delightful chapter in it. Prof. Huxley, doubtless for good reasons, does not tell us where and under what circumstances each of these essays first saw the light, but the autobiography was apparently published with a photograph not many years ago. It is full of good things. The author confesses to having inherited from his father, as well as an inborn faculty for drawing, "a hot temper, and that amount of tenacity of purpose which unfriendly observers sometimes call obstinacy." He remembers preaching to his mother's maids in the kitchen, with his pinafore turned wrong side forwards in order to represent a surplice—"the earliest indication I can call to mind of the strong clerical affinities which my friend Mr. Herbert Spencer has always ascribed to me!" Of his schoolmasters he has nothing good to say—they "cared about as much for our intellectual and moral welfare as if they were baby-farmers." His great desire on leaving school was to be a mechanical engineer; but the fates were against this, and he commenced the study of medicine.

It is very interesting to those who know the value and range of his original researches in comparative anatomy to read the statement—

"I am afraid there is very little of the genuine naturalist about me. I never collected anything, and species work was always a burden to me; what I cared for was the architectural and engineering part of the business, the working out the wonderful unity of plan in the thousands and thousands of diverse living constructions and the modifications of similar apparatuses to serve diverse ends."

I venture to think that it is not only as a mechanical engineer *in partibus infidelium*, as he says of himself, that Prof. Huxley has dealt with organic form, but also as an artist, a born lover of form, a character which others recognise in him though he does not himself set it down in his analysis.

Some day, it is to be hoped, Prof. Huxley will fill in the outlines of this autobiography, and especially give us an account of those long years of arduous work, of discoveries, struggles, triumphs, and friendships from the time when he succeeded his friend Edward Forbes in 1854 to the present day.

No better introduction can be given to Prof. Huxley's collected essays than his own statement of the objects which he has had in view during the years in which, whilst producing also educational books and many larger and strictly scientific works addressed to the limited circle of biological experts, he has by these occasional addresses and articles taught a vast number

of his fellow-countrymen the value of scientific ways of thinking, and freed them from the fetters of orthodox superstition. These objects have been, he says—

"To promote the increase of natural knowledge and to forward the application of scientific methods of investigation to all the problems of life to the best of my ability, in the conviction which has grown with my growth and strengthened with my strength that there is no alleviation for the sufferings of mankind except veracity of thought and of action, and the resolute facing of the world as it is when the garment of make-believe by which pious hands have hidden its uglier features is stripped off. It is with this intent that I have subordinated any reasonable, or unreasonable, ambition for scientific fame, which I may have permitted myself to entertain, to other ends; to the popularisation of science; to the development and organisation of scientific education; to the endless series of battles and skirmishes over evolution; and to untiring opposition to that ecclesiastical spirit, that clericalism, which in England, as everywhere else, and to whatever denomination it may belong, is the deadly enemy of science. In striving for the attainment of these objects, I have been but one among many, and I shall be well content to be remembered, or even not remembered, as such."

E. RAY LANKESTER.

#### THE PSYCHOLOGY OF TO-DAY.

*Grundzüge der Physiologischen Psychologie.* Von Wilhelm Wundt. 4te Auflage. (Leipzig: Wm. Engelmann, 1893.)

A NEW edition of this well-known work will be welcomed by all interested in this developing branch of science, and the author is to be congratulated on the fact that a work of this magnitude should reach its fourth edition in nineteen years.

The general plan of the work and the general opinions are unaltered, but there has been much revision and addition of detail throughout. The most extensive alteration consists in the much more detailed description of experimental methods, especially in the chapters on the intensity of sensation, and on Time problems. The descriptions are admirably clear, and their value is greatly increased by the addition of numerous woodcuts illustrating the apparatus employed.

In the first half of the book, which deals with the anatomy and physiology of the nervous system, one turns with interest to learn what the author has to say on the subject of cerebral localisation. Wundt opposes the notion that the physiological substrata of complex mental processes can be localised in a limited area of the brain, though he appears later to disregard this when he suggests that his process of apperception is localised in the prefrontal lobes. While accepting, however, the localisation of motor and sensory processes in a more or less general way, he hesitates to accept that definite localisation which the facts now at our disposal seem to justify, at any rate so far as concerns the so-called motor area. His attitude on this question is influenced by the fact that he regards the prevailing view as an outgrowth from the doctrine of specific nerve energy, of which he is a determined opponent. One of his chief arguments is derived from the phenomena of compensation when a part of the brain has been destroyed. Wundt's view of this process is that the functions of the destroyed part are taken on

by another part which had previously had a different function; thus he speaks of an element, which under normal conditions gives rise to a visual sensation, becoming the seat of a tactile or muscular sensation. It seems much more likely that the new function in such a case is taken on by elements of the cortex previously undeveloped, and the fact that compensation occurs so much more readily in the young is in favour of the latter view. On the question which is at present so much debated among English neurologists, viz. whether the Rolandic area of the cortex is to be regarded as motor or sensory (kinæsthetic), Wundt does not express a very definite opinion; he speaks of this area generally as centro-motor, but does not exclude the presence of sensory elements, though of a tactile rather than kinæsthetic nature.

In the second half of this volume, dealing with sensation, the section on what is usually called the muscular sense has been considerably modified. The importance of the part taken by impressions arising in the joints is fully recognised, and in the case of passive movement, Wundt agrees with Goldscheider in ascribing to them a very preponderant rôle, but insists on the addition of elements from the muscles and tendons in the case of active movements. Sensations of innervation are also called in to explain active movement, though Wundt now recommends that this name should be given up, and that this component of the sensation-complex should be called central as distinguished from the peripheral components arising in the joints, muscles, tendons, and skin. The author, however, states, as indeed he did in the last edition, that such central components probably have their source in memory-images of movements previously carried out.

The theory of colour vision in another section of this part does not differ materially from that brought forward in the last edition, and in the fourth volume of "Philosophische Studien," though several matters, and especially the phenomena of contrast, which are referred to central conditions, are more fully considered.

A new section has been added on the physical accompaniments of pleasurable and painful feeling, in which recent work on the subject, and especially that of Lehmann, has been embodied. Wundt supposes that the circulatory and respiratory changes which accompany pleasure and pain are the results of central innervations concomitant with the feelings; pleasurable feelings being associated with increased rapidity, and painful with inhibition, of the central processes.

In the first part of the second volume, in which perception is dealt with, there is little new; the most noticeable addition is on the subject of geometric optical illusions. Such illusions are regarded as mainly dependent on sensations arising from movements of the eyes. The author does not altogether exclude the influence of association to which some psychologists would refer them, but he objects strongly to the way in which Lipps has explained them by "introducing indefinite æsthetic notions into psychology, instead of referring æsthetic effects to definite psychological factors."

We have already mentioned the improvements made in the chapter on Time by the description of apparatus and methods. In considering the estimation of time-

intervals, the work and theories of Münsterberg and Schumann are adversely criticised, and Wundt takes this opportunity to make a hit at the former psychologist for the large amount of work which he imposes on the muscle sensations in making them responsible for estimation of time and space, as well as for attention and the intensity of sensations.

A section is devoted to Hypnotism, in which the views recently advanced by the author are shortly expressed. The hypnotic condition is regarded as dependent on inhibition of active apperception, *i.e.* of will and voluntary attention. The explanation of the hallucinations and analogous phenomena of hypnotism is referred to a general law that when the greater part of the brain is out of action, the sensitiveness of the active remainder is increased; a law which also applies to the explanation of dreams.

The doctrine of Apperception, which is the most characteristic feature of Wundt's system, does not appear to have suffered any material change. Apperception, as used by the author, corresponds very closely to the attention of many English psychologists, and Wundt himself occasionally seems to use the terms "apperception" and "aufmerksamkeit" indifferently. The book combines the qualities of a text-book and of a philosophical treatise. It may be used with the greatest advantage as a means of learning the way in which the methods of experimental psychology are employed, and as an account of what we have learnt thereby; but it is also an able attempt to treat the whole subject of the connection between Mind and Body philosophically.

#### RAILWAY WORKS.

*Round the Works of our Great Railways.* By various Authors. (London: Edward Arnold, 1893.)

THIS volume consists of a reprint of a very interesting series of articles which appeared some few months ago in the *English Illustrated Magazine*, the authors in most cases being intimately connected with the railway companies' works they describe. Taken as a whole, this book is very readable, and contains much useful information.

The London and North-Western Works at Crewe are first described by Mr. C. J. Bowen Cooke, of the locomotive department. The Crewe Works have been so often described by many people, that the present author ran the risk of being unfavourably compared with the others; there is, however, no need to fear the comparison, for the article is well done. It is a pity that anything was written on the subject of building an engine in twenty-five hours; and the author of the article on the Great Eastern Works at Stratford does the same thing on p. 128, although in this case the time is reduced to ten hours. No doubt the statements are wonderful to the general public, but to locomotive builders they merely go to show how railway shareholders' money is sometimes wasted.

Chapter ii. (written by Mr. C. H. Jones, of the locomotive department) describes the Derby Works of the Midland Railway Company. In order to show the size of the staff on this railway in the locomotive department only, the following figures are of interest:—There are 13,150 men,

2328 locomotives, 302 stationary engines, 267 stationary boilers, 1023 hydraulic machines, and 416 cranes of every kind, besides many other mechanical appliances, the supervision of which come under the locomotive department.

Mr. A. J. Brickwell, of the surveyors' department of the Great Northern Railway, is the author of Chapter iii. describing the locomotive work of that company at Doncaster. High speed has always been associated with the Great Northern, and very properly so, for this company has always held the palm in this respect, thanks to the magnificent engines designed by Mr. Stirling, the locomotive engineer. A passable illustration of No. 776 engine, built in 1887, gives some idea of the bold outline of the "flyers" that daily tackle the "Scotchman" express, and seldom drop a minute on the road. What locomotive engineer, besides Mr. Stirling, of Doncaster, can point to engines like these, designed twenty-three years ago, and can still claim that the engines are able to hold their own with their present-day rivals, be they compound or otherwise?

Chapter iv., by Mr. Wilson Worsdell, the locomotive superintendent of the North-Eastern Railway, deals with the works of that company, and we naturally read a good deal about the virtues of the two-cylinder compound locomotive, besides the excellent description of the works. As this company is building some very powerful non-compound express engines, it would appear that compounding is not the source of economy hitherto claimed for this system.

The Great Eastern Railway Works at Stratford are described by the secretary to the locomotive superintendent, Mr. Alex. P. Parker. The article is well written and interesting, notwithstanding the absurdity of claiming credit for throwing an engine together in ten hours. Everything at Stratford is certainly on the most modern system of management and manufacture, and those responsible may well take credit for being "up to date."

Chapter vi. is of much interest, because it deals with the Great Western Railway Company's works at Swindon, and particularly so because of the now defunct broad-gauge system with Sir Daniel Gooch's noble engines. These are well illustrated in the text, and some exciting runs on the engine of the "Dutchman" are described. The following chapter deals with the new narrow-gauge engines built to take the place of the veterans when the line was converted to the narrow gauge.

The last chapter in the book is on the Cowlairs Works of the North British Railway, the only Scotch railway described, the author being Mr. A. E. Lockyer, of the locomotive department. This article is interesting, but it appears to be unduly curtailed, and has fewer illustrations than the other chapters; the illustrations that are included, however, are certainly the clearest in the book. The unique part of this chapter is the description of the working of the trains up the incline at Cowlairs from the Glasgow terminus at Queen Street, by means of a stationary engine and endless wire rope. The description of the works is good.

Altogether the volume is most interesting, and should be read by all connected with, or travelling by, the railways of this country, containing, as it does, much unique information on a subject little thought of outside the railway circle.

N. J. LOCKYER.

*ESSENTIALS OF CHEMICAL PHYSIOLOGY.*

*The Essentials of Chemical Physiology.* By Prof. W. D. Halliburton. (London: Longmans, Green, and Co., 1893.)

THERE is no doubt that this elementary text-book by Prof. Halliburton will be welcomed by students of chemical physiology. The teaching of physiology has come to be so much a matter of laboratory instruction that the demand for carefully written text-books dealing with the practical parts of the science, has become a very pressing one. This book is a companion volume to Prof. Schäfer's "Essentials of Histology." It is constructed on the plan originally adopted in the syllabus of lectures by Prof. Burdon Sanderson. At the beginning of each chapter there is a series of exercises which form practical illustrations of the subject with which the chapter deals. The exposition which follows the list of exercises is manifestly the work of one who is a master in the modern methods of teaching, and the frequent references to recent research give to these chapters an interest which is unfortunately sometimes absent from text-books. The elementary is followed by an advanced course, in which are given the more elaborate exercises on the subjects of the earlier chapters. In this course perhaps too little attention is paid to experiments on the living organism. The exercises given are concerned chiefly with those substances which can be extracted from the organism by some means or other. We have, for example, a chapter on hæmoglobin, in which we get instruction in regard to substances such as alkaline hæmatin, hæmochromogen, hæmatoporphyrin. There are no exercises on oxygen or carbonic acid, and yet the relation of these gases to the organism is surely of vastly greater importance in physiology than hæmochromogen. Similarly we have the analysis of urine considered even so far as to include the estimation of creatinine, while there are no exercises showing how the constituents are related to physiological conditions.

The function of such instruction as we find in this book is not only to bring physiology to practical expression, but to show its relation to the questions of practical medicine; and exercises, with this in view, are more to be desired than the estimation of creatinine. The difficulties in the way are not such as to prevent the introduction of experiments of the kind suggested.

In the appendix the author describes one or two examples of complicated apparatus, and gives some chemical tests. Apparatus in the complicated forms is always a burden to the physiologist, and any allusion to it should appear in an appendix, if at all. It is difficult to see why the author has placed Kjeldahl's method for estimating nitrogen in the appendix. The method is an easy one and is in universal use, and should be familiar to advanced students. It would also be well to present it to beginners in some simpler form than that which is given here.

Apart from its relation to experimental work the book is of interest in so far as it gives indication of a new departure in physiology. We are told that "the chemist cannot, at present, state anything positive about living matter." So far as we know apparently, we cannot say that there are any chemical changes in living cells.

The author also discards any physical or chemical account of absorption. The cells absorb in virtue of their "vital activity." Finally, in describing the process of respiration, he states his position generally in the following sentence:—"Much recent physiological research has shown that we must largely abandon physical theories for what are called vitalistic theories; in other words, the vital processes of selection possessed by the cell may counteract or supplement physical processes."

It is probably significant, as it is new for vitalism, as a theory of life, to put forward a claim to recognition in the name of "recent research." We are accustomed to the theory being classed among things which are not only characterised by the flavour of antiquity, but are familiar to those only who shun all kinds of experimental investigation. If vitalism be adopted as the true point of view in biology, it will clearly be necessary to reconsider the position of physiological chemistry as a science.

#### OUR BOOK SHELF.

*The Sacred City of the Ethiopians.* By J. T. Bent. (London: Longmans, 1893.)

IN the interesting volume before us, Mr. Bent gives us a very readable account of the journey to Ethiopia which he and his wife undertook in the year 1893. The work contains twelve chapters by Mr. Bent, a chapter of rather more than fifty pages by Prof. David Heinrich Müller, of Vienna, upon the inscriptions at Yeha and Aksum, an appendix on the morphological characteristics of the Abyssinians, by Dr. J. G. Garson; and a map of the country, showing Mr. Bent's route. Mr. Bent's purpose in visiting Ethiopia was archaeological, and he took considerable pains to visit all the sites of ancient cities, sometimes even seeming to carry his life in his hands in so doing. The principal sites examined by him were Asmara, Keren, Adoua, Yeha, and Aksum, and he made pilgrimages to the famous monasteries of Bizen and Debra Sina, into which last religious house Mrs. Bent succeeded in gaining admittance by assuming male attire. Throughout his travels Mr. Bent was shown the greatest courtesy by the Italians, and although many parts of the country were convulsed by civil war, yet under their direction Mr. Bent made his way in comparative security. Mr. Bent has noted many particulars of interest, and the illustrations made from photographs taken by Mrs. Bent give additional interest to his narrative; but the most important part of the book for the Orientalist are the translations of the Himyaritic and Ethiopic texts which Prof. D. H. Müller has made from Mr. Bent's excellent squeezes. These show that the Sabeans migrated into Ethiopia at a much earlier date than is usually supposed, and they are full of historical and archaeological interest. It is true that some of the texts have been copied and published before, but the new critical investigation by such a competent scholar as Prof. Müller has resulted in the elucidation of many important details. If Mr. Bent's book runs into a second edition, he will do well in revising his account of the Mohammedan conquest of Ethiopia to note several facts given in the account of the invasion, written in Ethiopic by a monk, the text of which has recently been published in Berlin by Dr. A. W. Schleicher, entitled "Geschichte der Galla." Meanwhile we thank Mr. Bent for the squeezes and the labour which he undertook to obtain them.

*Fra i Batacchi indipendenti.* Viaggio di Elio Modigliani, pubblicato a cura della Società Geografica Italiana. (Rome, 1892.)

SIGNOR MODIGLIANI communicated an account of his journey through Sumatra in 1890-91, to the Genoa Geographical Congress of 1892, and it is now published in book form, enriched with many excellent illustrations. He describes in some detail the Battak people of Central Sumatra, one of the most remarkable remnants of primitive culture in all Asia, as they retain their own forms of architecture, industry, and writing, together with their primitive religion and their political independence, although surrounded on every side by Mohammedan tribes and Dutch supremacy. The headquarters of the shrunken remnants of the Battaks is round the great lake of Toba, of the western side of which Signor Modigliani has made a large scale map, published in the book. The scenery of this lake is very fine, and a long panoramic view goes far to justify the enthusiasm of the author's description. The main object of the journey was to make ethnographical collections, and some excellent photographs of the Battak physical type are reproduced, together with examples of native art, architecture, and industry. Incidentally a good many adventures befel the author, and these he does not minimise. While there is little in these pages of real importance that has escaped the careful observation of the Dutch and German observers, who have made an almost exhaustive study of the Battaks, the narrative is interesting, and the collections should be very useful to students in Europe. A short meteorological appendix gives observations of temperature, pressure (aneroid), humidity, and rainfall from October, 1890, to April, 1891.

*Romance of the Insect World.* By L. N. Badenoch. (London: Macmillan and Co., 1893.)

THIS is a pleasantly written little book, which contains much interesting information on insect life and habit. The metamorphoses of insects, their food, hermit homes, social homes, defences and protection through adaptation are successively considered. Although there is not much evidence of individual observation, the author has been careful in his selection of authorities. The book is intentionally descriptive rather than explanatory, and, since the descriptions are picturesque without inaccuracy, may be safely recommended to those who seek for information in one of the most fascinating departments of natural history.

*Romance of the Insect World.* By L. N. Badenoch. (London: Macmillan and Co., 1893.)

THIS is a pleasantly written little book, which contains much interesting information on insect life and habit. The metamorphoses of insects, their food, hermit homes, social homes, defences and protection through adaptation are successively considered. Although there is not much evidence of individual observation, the author has been careful in his selection of authorities. The book is intentionally descriptive rather than explanatory, and, since the descriptions are picturesque without inaccuracy, may be safely recommended to those who seek for information in one of the most fascinating departments of natural history.

#### LETTERS TO THE EDITOR.

*The Editor does not hold himself responsible for opinions expressed by his correspondents. Neither can he undertake to return, or to correspond with the writers of, rejected manuscripts intended for this or any other part of NATURE. No notice is taken of anonymous communications.]*

#### The Postal Transmission of Natural History Specimens.

IN NATURE for November 30, 1893, p. 100, appeared a circular, issued by the Academy of Natural Sciences of Philadelphia, concerning the transmission of specimens of natural history by mail between different countries. This circular asked scientific bodies in certain countries therein named to request their respective Governments to favourably reconsider a proposition, made by the United States Post Office, to admit such specimens to the international mails under the rates for "samples of merchandise," this proposition having been once rejected by those countries.

In commenting upon this circular, Mr. R. McLachlan reproduces (NATURE, December 21, 1893, p. 172) a letter from the Secretary of the British Post Office, dated April 13, 1891, in which the Secretary promised that the British Post Office would not, in the future, stop scientific specimens sent by sample post and addressed to places abroad, but added that the delivery of such specimens abroad could not be guaranteed, for the reason that such specimens "do not come within the definition of sample packets as prescribed by the Postal Union." Mr. McLachlan adds that within the last month he had, "on two occasions, sent specimens abroad by sample post with per-

tectly satisfactory results." He continues: "But it is to be regretted that the United States Postal Department should, in another way, continue to maintain a barrier against cheap transmission and interchange of specimens. The sample post can, in any case, only be used for small packets, but larger packages can now be sent to nearly all foreign countries by parcel post, the introduction of which was an inestimable boon. The United States Government stands almost alone in persistently refusing to cooperate in this respect."

As chairman of the committee appointed by this Academy to prepare the circular, I have obtained from Mr. N. M. Brooks, Superintendent of Foreign Mails, U.S.P.O., certain official information which, it is believed, will throw a new light on Mr. McLachlan's comments, and make the desirability of sending specimens by sample post still more evident.

Mr. McLachlan's quotation from the letter of the British Postal Secretary mentions the fact that specimens of natural history do not come within the Postal Union's definition of sample packets. Mr. Brooks, in a letter of July 14, 1893, writes: "Said proposition [to admit such specimens as 'samples'] having been formally submitted to a vote of the countries of the Postal Union, and having failed to receive the support of the number of countries necessary to secure its adoption, no country of the Postal Union is at liberty to transmit by mail to another country of the Union, natural history specimens as 'samples of merchandise.'"

On the subject of the parcels post, Mr. Brooks states (letter of January 12, 1894): "It may be well to say that so far as *small packages* of natural history specimens are concerned, the parcels post would afford but few additional facilities over those offered in the regular mails if the rates were assimilated to those in force in Great Britain and Canada; for instance, the lowest charge in Great Britain on a package weighing 3 pounds *or less* addressed for delivery in Belgium is 1 shilling 3 pence (= 30 cents), and to France 1 shilling 4 pence (= 32 cents), while in Canada the charges for a pound *or less* would be to Belgium 46 cents, and to France 48 cents. While the sums above named may be low for the transmission of three-pound or one-pound packages, it must be remembered that these sums are the minimum charges, and must be paid also on smaller packages, even on packages weighing only one or two ounces. If the proposition of this department to admit natural history specimens to the mails as 'samples' had been adopted, small packages of such specimens would have been transmissible throughout the extent of the Postal Union at the rate of one cent for each two ounces, while the facilities offered by the parcels post for the transmission of larger packages would not have been curtailed. For example, under present conditions a package weighing 4½ ounces may be sent from Canada to Belgium or France as a *letter* upon the prepayment of 45 cents; as a parcels-post package the charge would be 46 and 48 cents respectively; as a 'sample' the charge would be 3 cents."

Such a large proportion of the packages contain specimens weighing less than a pound, that the establishment of a "samples" rate of postage for them is in the highest degree desirable.

In the present condition of affairs it would appear that the "hyper-protection," at which Mr. McLachlan hints in his concluding sentence, is not on *this* side of the Atlantic.

Philadelphia, January 18. PHILIP P. CALVERT.

### The Origin of Lake Basins.

THE present, while the origin of lake basins is under discussion in your pages, seems a favourable opportunity for collecting all that can be said for and against the glacier theory. Not being a geologist myself, I do not know whether the few remarks I have to make may be new or not. They are therefore submitted with great diffidence for the consideration of experts.

If lake basins have been excavated by boulder-shod glaciers, then it follows, that as these boulders do not act by cutting, but by grinding, the boulders will be worn away as much as the rock beneath them; that is, for every square yard excavated, there will be an equal amount of boulder material ground down. This will be so, as we are hardly entitled to assume that the boulders are on the average harder than the under rock, and as they are in smaller pieces, they will be liable to a greater amount of fracture. Are the glacialists, then, prepared to supply an amount of boulder material equal to the amount excavated?

and if not, how do they explain the greater cutting power of the moving blocks? Further, after the glacier has dug a basin, the flow of water under the ice will be very slow, owing to the widening of the glacier, and the water spreading across the whole breadth of the basin. How, under these conditions, is the abraded material got quit of? It will no longer be water-borne, but will probably be pushed upwards and forwards out of the basin by the ice and boulders, and should therefore form a deposit of a breadth nearly equal to that of the basin. Is there any evidence of this?

Another point to which I wish to refer is in explanation of the constant association of lakes with evidences of previous glacial conditions. It is possible, as has been pointed out by Mr. Oldham, that this relation may only be apparent, and that there may be rock basins that are not lakes, and that the only part the ice played was to keep these basins from being filled up by deposits. There, however, seems to be another way in which the ice may have acted and at least helped to make the lake basins. When we examine the position of the principal lakes in Switzerland and Italy, we find that many of them lie where the plains merge into the mountains, that is, close to the foot of the mountains. In many of them the lower part of the lake extends into the plains, while the upper part penetrates the mountain range. Now, the foot of the principal slope is where the greatest accumulation of ice will occur. The quick upper slopes supplying more ice than the lower slopes can take away, the consequence is that the ice accumulates until its greater depth compensates for its slower movement. If, then, the surface of the land was in equilibrium in the shape it was in before the ice made its appearance, then, owing to the unequal distribution of the load, it would evidently not be in equilibrium after the arrival of the ice, and the consequence would be that wherever the ice was deepest there would be the greatest tendency for a depression to form on the surface of the earth. In this way basins would tend to form under the places where the ice was deepest; this would naturally be in, and in front of, the main valleys in the line of the greatest flow of ice, at the point where the quick slope of the valley gives place to the slow slope of the plain, just where we find the principal Alpine lakes. The formation of lake basins in this way will of course be greatly modified by the nature of the under rock. We could easily imagine basins such as those of the Lake of Zurich and the Lake of Varese to be formed in this way, as the shores slope easily in all directions; but it is much more difficult to imagine the upper ends of the greater Alpine lakes, where the shores are precipitous, to be produced by sinking due to the load of ice. It might be objected that if these lake basins were produced in the way suggested, the earth's crust ought to have recovered its form after the Ice Age had passed. This, however, is by no means a necessary conclusion, because when sinking, the rocks being already fractured, deformation can take place comparatively easily; but when rising, the rocks, being in arch-form, are in a much better position to resist an upward thrust than they were to resist a downward one. The result of the snow and ice melting would probably be to cause a general elevation of the mountains as well as of the lakes.

JOHN AITKEN.

Darroch, Falkirk, January 20.

I HAVE been following with some interest the recent discussion in these columns concerning the power of ice to erode rock basins, since I have prepared for publication (presented at the December, 1893, meeting of the Geological Society of America) a paper describing some recent studies of my own upon this subject. After several years of study in the glacial belt of New England, having never found definite evidence of rock basins in lakes of large size, I came to the conclusion that the theory of rock basins had little value, particularly since, after having been before us for more than thirty years, so few instances have been proven. In my own case, and I believe also in others, the attempt had always been to trace a continuous rock line, and this I now believe to have been an entirely wrong method; for how many large lakes are there in which possible outlets may not be buried beneath drift areas?

By following an entirely different method I have been able to prove that Lake Cayuga in central New York, and probably also Lake Ontario, is in a rock basin. Lake Cayuga has a length of nearly forty miles, and a width varying from one to nearly four miles, while its depth is in one place four hundred and thirty-five feet, the bottom being considerably below sea-level.

The method followed was to find the distinctly preglacial valleys tributary in the preglacial stream valley, now deepened by glacial erosion, and occupied by Lake Cayuga. There are several of these with the broad valley and gently sloping sides so characteristic of old valleys, and so different from the steep side post-glacial gorges. Their directions are at all angles with that of the ice motion. If the main valley (the present lake valley) has not been sensibly deepened by the ice, these tributaries should not be rock bottomed. In the present instance the entire valley is found to be underlain by the Devonian shale in place (nearly horizontal); and the bottom of the preglacial valleys are there, at the lake margin, found to be over 400 feet above the deepest point of the lake.

There are three possible explanations of this phenomenon: either (1) the rivers had a fall of over 400 feet in less than a mile, while above this the slope was only very slight, or (2) the lake valley has subsided 400 feet, or (3) it has been deepened by ice erosion. Few will, I think, consider the first two to be possible, and there is evidence that they are not. For fuller details reference may be made to my forthcoming paper.

It seems to me that we have here a reasonable and possible method of testing the value of the rock basin theory, and I believe that its application in other regions will show that ice can, where conditions were favourable, excavate lake basins of large size, and has done so. This conviction comes to me in spite of distinct preconception and prejudice against the theory.

R. S. TARR.

Cornell University, Ithaca, New York, January 15.

#### Glacial Erosion in Alaska.

REFERENCES in your recent correspondence to my estimate of the rate of erosion by the Muir Glacier in Alaska, call for a supplementary statement. The estimate was made in 1886 by determining the amount of sediment per gallon brought down by one of the sub-glacial streams, and calculating as best I could the area of the glacial basin, the amount of annual rainfall, and the probable waste by evaporation and by the formation of icebergs. The result obtained was the removal of one-third of an inch of rock per annum over the glaciated area.

Since my visit to the Muir Glacier, Prof. H. F. Reid has spent two summers on the same ground with more ample preparations for collecting the facts. His report may be found in the *National Geographic Magazine* (Washington), vol. iv. p. 51. According to his calculation, the erosion amounts to three-quarters of an inch, or nearly three times as much as I had estimated. I have little question that Prof. Reid's estimate is more nearly correct than mine, since my calculation was based upon the removal of sediment from the entire drainage area of the glacial amphitheatre. Prof. Reid, however, rightly concludes that this is full twice as large as the actual bed of the glacier to which the glacial erosion was practically limited. Making that correction, our estimates are in close agreement.

It should be observed, however, that these observations do not bear directly upon the question of the erosion of lake basins by glaciers; for the Muir Glacier, whose sediment was estimated as above, is moving down a slope of about 100 feet per mile. The erosion over this slope, therefore, may be quite different from that at the foot of the glacier as it descends below the water-level into the head of the tidal inlet, where, I should presume, the erosive power would be soon reduced to a small quantity. Still, the mechanical problem involved in calculating the distribution of the force of a descending glacier as it reaches the foot of the incline is too complicated for ready solution. That there is some scooping out of a rocky basin in such cases seems amply proved by the facts which I have quoted in my "Ice Age" (pp. 237-239), from Prof. I. C. Russell, concerning the formation of cirques in the Sierra Nevada Mountains.

In my own observations two or three years ago, however, upon Lake Geneva in Switzerland, I was led to believe that whatever might be true of glacial erosion, attention enough had not been given to the theory of a possible buried outlet leading past Mount Sion and Frangy to Seyssel. Certainly the course of the Rhone across the spur of the Jura Mountains at Fort De l'Ecluse is very suggestive of recent occupancy. Among the great lakes of America there can be little doubt that Lake Erie and some others owe their existence almost wholly to the choking up of preglacial outlets of the valleys by glacial debris. The great depth of Lake Geneva, however, would render it improbable that it was wholly due to such a cause, and I do not

know that the conditions are such as to permit the supposition made above. I distinctly remember, however, that from the vicinity of Seyssel there was an unobstructed view between the mountains towards Geneva, and that the gravel deposits extend from Geneva far down towards those which appear about the head-waters of the small tributary to the Rhone which joins it at Seyssel. Perhaps this theory has been fully considered and refuted; if so, I have not seen the refutation.

G. FREDERICK WRIGHT.

Oberlin, Ohio, January 17.

#### On the Equilibrium of Vapour Pressure inside Foam.

It is known that the vapour pressure near a curved liquid surface is different from that near a flat surface, being less near a concave surface and greater near a convex surface than near a flat one. Now, inside foam bubbles the surfaces are approximately flat, except where three bubbles join to form an edge, and along these edges the surface inside any bubble is concave with a very small curvature. How does it happen that equilibrium can exist with the small pressure in these corners, and a larger pressure required near the flat surfaces? In the first place it may be that equilibrium cannot exist, and that all foam is essentially unstable; and it would be almost impossible to disprove this by a direct experiment. If, however, foam can be stable, it seems as if the only conclusion possible were that the flat surfaces will evaporate and thin down, the liquid condensing in the corners, until the flat parts are so thin that they are in equilibrium with a smaller vapour pressure than a thick liquid surface would require. In other words, that the vapour pressure near a very thin film may be less than it can be near a thick one at the same temperature. It is evident that inside or outside a solid box stability must be possible, so that the second alternative is the only solution.

We see a phenomenon of this latter kind in the hygroscopic films that cover glass. Being due to an attraction of the glass for water there results what I am describing, namely, that in an atmosphere incompletely saturated a film of such a thickness can exist that the vapour pressure near it is such as corresponds to the existing vapour pressure in the surrounding atmosphere.

If we knew the connection between the thickness of a film and the vapour pressure near it, it would be possible to calculate the shape of a bubble near a corner. The pressure at any point being that due to the thickness diminished by an amount proportional to the curvature. So that if  $f(y)$  be the pressure due to a film of thickness  $y$  and  $r$  be the radius of curvature of the surface of the liquid near a corner, we get as the equation of the surface

$$f(y) - \frac{T}{r(\delta - \sigma)} = \text{constant},$$

when  $T$  is the superficial tension which may be a function of  $y$  and  $\delta$  the density of the liquid and  $\sigma$  of the vapour of the liquid, which latter will depend on the vapour pressure inside the bubble. To determine this and the constant we should know how much liquid we have at our disposal ( $V = \int y dx$ ) to

lie round the bubble and to supply vapour inside, and it would appear that inside a cubical box falling freely, for instance, a bubble would always be spherical unless the quantity of liquid were sufficiently small to require the sides of the bubble to be flattened against the sides of the box: *i.e.* unless the volume of liquid were less than  $1 - \pi/6$  times the volume of the box.

In connection with my letter in last week's *NATURE*, I may suggest that a possible cause of warming of solid powders when mixed with liquids, is that the solids have already got a film of water over their surfaces, which being on the outside in contact with air, is at least on its outer surface in tension, and that this enormous area of air-liquid film disappears when the solid is immersed in liquid, and that the heat is due to the extinction of this great film. It would require very careful measurements of the heat evolved and estimates of the area of the film concerned, to decide whether this would account for the heating observed. In my former letter I assumed that liquids would soak up into *dry* powders, and that these latter warmed liquids when mixed with them. The suggestion I am now making would account for a warming being produced by damp powders, or by spray or cloud falling into a liquid.

G. F. FITZGERALD.

Trinity College, Dublin, January 29.



#### A Liquid Commutator for Sinusoidal Currents.

MY attention has been drawn to a note in *NATURE* of January 11 (p. 253) which quotes from the *Electrical World* of New York "a novel method of obtaining sinusoidal alternating currents of very low frequency," described by Lieutenant F. Jarvis Patten. The method is to make a pair of conducting plates revolve in a vessel of liquid which also contains a pair of fixed plates. This liquid commutator, however, is not new. It was the subject of a joint patent taken out by Mr. C. G. Lamb and myself a year and a half ago, and it was used in connection with the magnetic curve-tracer in my British Association lecture at Edinburgh on "Magnetic Induction," and again at the Royal Society soirée last May. It has been, in fact, for some time an item in Messrs. Nalder's catalogue of scientific apparatus. A description of it was published in the *Electrician* of November 18, 1892.

J. A. EWING.

Engineering Laboratory, Cambridge, January 26.

#### A Curiosity in Eggs.

A COMMON "barn-door" hen, belonging to a neighbouring farmer, recently laid an egg measuring  $4\frac{1}{2}$  inches in length by 7 inches in circumference; weight 6 ounces. On this egg being carefully broken a second perfect egg, with hard shell of ordinary size (3 inches by  $5\frac{1}{2}$  inches in circumference), was found floating in the contents of the outer one. The contents of both eggs appeared to be normal and healthy. This is surely a very unusual occurrence.

E. BROWN.

Further Barton, Cirencester, January 16.

#### RICHARD SPRUCE, Ph.D., F.R.G.S.

ALTHOUGH little known beyond a limited circle of botanists and South American explorers, the subject of this notice was in many respects a remarkable man, who, under more favourable circumstances, would have acquired a wider reputation. He was the son of a schoolmaster at the village of Ganthorpe, Yorkshire, and at an early age showed a taste for botany, having compiled a "List of the Flora of the Malton District" in 1837, when he was just twenty years old. For some years he was teacher of mathematics at the Collegiate School, York; and during his holidays he explored Eskdale, Teesdale, Killarney, and other districts, paying special attention to the mosses and hepatics, among which he discovered many new species, which he described in the *Phytologist*, the *Transactions* of the Botanical Society of Edinburgh, and in the *London Journal of Botany*. In 1845 he went to the Pyrenees, where he spent ten months, chiefly devoted to his favourite groups of plants, among which he discovered a large number of new or rare species. These were fully described in a paper published in the *Annals and Magazine of Natural History* in 1849.

The delicate state of his health requiring a warmer and more equable climate than that of his native Yorkshire, he decided, by the advice and with the assistance of the late Sir William Hooker, to visit the Amazon valley as a botanical collector, with the object, if possible, of reaching the head waters of the Orinoko and the eastern valleys of the Andes, districts whose riches had been indicated by the explorations of Humboldt and Bonpland at the beginning of the century, but which no experienced botanical collector had since visited. Invaluable assistance was also given by the late Mr. Bentham, who undertook the great labour of dividing and distributing the dried plants as they arrived in England, and sending sets to those who subscribed for them, thus acting as an unpaid but most efficient agent. The same eminent botanist described most of the new species of flowering plants as they arrived, thus making known the value of the collections, and ensuring the sale of the whole of the specimens.

In July, 1849, Mr. Spruce arrived at Para (where the

present writer first made his acquaintance), and during the succeeding fifteen years carried out successfully a series of voyages and explorations in equatorial South America, surpassing in extent, probably, those of any other scientific traveller. A mere enumeration of these journeys can alone be given here, in order to show how much was accomplished amidst all the difficulties due to climate, scarcity of food, scanty means, and imperfect means of transportation, aggravated by solitude and ill-health.

After a few months in Para and its vicinity, he moved to Santarem, at the mouth of the Tapajoz River. Here he remained for a year, collecting and studying the remarkable shrubby vegetation which surrounds the town, consisting largely of species then entirely new to botanists. During this time he made an exploration up the river Trombetas and its tributary the Aripicuru to the limit of canoe navigation. The following year was spent at Manaos (Barra do Rio Negro) exploring the surrounding forests and streams. He next ascended the Rio Negro in a large boat of his own, so as to be able to collect and preserve plants during the voyage. Two months were occupied in ascending the river as far as San Gabriel, situated on the cataracts of the Rio Negro, where he rested seven months, making numerous canoe excursions across the river to the various islands and to tributary streams, not without danger amid the roaring waters produced by the granite rocks and reefs which for some miles here fill the broad river-bed.

Spruce next ascended the Uaupes River as far as the first cataract at Panurú or San Jeronimo, which he made his headquarters for another seven months. Here he was delighted by the richness and novelty of the forest vegetation, which was almost wholly new in species, and even in some of the genera. Many of the loftiest trees had flowers of extreme beauty, especially those of the natural orders Vochysiaceæ, Tiliaceæ, Bombaceæ, Lecythideæ, Rhizoboleæ, and Rubiaceæ, and to add to the botanical interest of the district, when the rainy season brought the flowering of the forest trees to a close, the ground beneath them became ornamented with thousands of curious herbaceous plants, mostly leafless but adorned with delicate or brilliantly coloured flowers. These belonged mainly to the genera *Voyria*, *Burmannia*, *Ptychomeria*, and the *Triurideæ*. Here also fungi were more abundant than in any other locality visited, and about 200 species were collected, many of which were as varied and brilliant in colouring as the flowers themselves.

Leaving the Uaupes the traveller made his next headquarters at San Carlos, the first village in Venezuela situated on the north bank of the Rio Negro, not far from the entrance of the Cassiquiare. From this station excursions were made up the Rio Negro and many of its tributaries, and also through the entire length of the Cassiquiare to Esmeralda on the Upper Orinoko. He was now in the country explored by Humboldt and Bonpland nearly a century before, and collected hosts of plants, which were known only from the specimens sent home by those botanists, together with considerable numbers of new genera and species. In order to procure food in this notoriously hungry region, he made a special journey from San Carlos to the cattle district of the cataracts of Maypures on the Orinoko, travelling over the portage of Pimichin which forms a narrow watershed between the two great river systems. After twenty months in this district he descended again to Manaos, from which he had been absent three years, and prepared for his great journey to the Andes.

Ascending the main stream of the Upper Amazon, and entering its great southern tributary, the Huallaga, he passed beyond its first rapids, and by means of a small western affluent and a day's journey overland, reached Tarapoto. This is a town of about 7000 inhabitants,

beautifully situated in a level plain about 1200 feet above the sea, and almost entirely surrounded by forest-clad mountains of moderate height, from which abundant streams descend through narrow ravines, offering in every direction a rich harvest for the enthusiastic botanist. Here Spruce remained for nearly two years, exploring the country for twenty or thirty miles in every direction, occasionally remaining weeks at a time in the more promising mountain localities. Rich collections of all orders of plants were here obtained, especially of ferns and of his favourite groups the mosses and hepatics, while on the mountains—though only 5000 to 6000 feet in elevation, many north-temperate genera, such as *Ranunculus*, *Rubus*, *Stellaria*, and many others, made their first appearance.

In March, 1857, he left Tarapoto for the Andes of Ecuador by way of the Upper Amazon and its tributary, the Pastaza, reaching Canelos by a northern branch, the Bobonasa, and thence through the forest to Baños. On the way he had to cross the river Topo by bamboo bridges, constructed afresh by every traveller from rock to rock across the broad mountain torrent. The stream, however, was in flood, and he had to wait four days before the bridge could be constructed, and then the water was so high and the passage so dangerous that most of his baggage—books, manuscripts, microscope, &c.—had to be left behind under a thatch of leaves till they could be sent for, his party of sixteen persons being in danger of starvation had they waited longer. After reaching Baños, the packages were sent for, and recovered without injury. During his enforced stay on the banks of the Topo, he had found the forest so rich in plants—especially in his favourite hepatics—that after some weeks he returned there in order to obtain a more complete series of its botanical treasures, and again had the greatest difficulty and risk in passing the flooded river, of which he declares that the only pleasant recollection he retains is of the new and strange hepaticæ which he collected on its banks.

After some months at Baños, he devoted more than three years to the continuous exploration of the forests and higher mountains of Ecuador, visiting in turn Tunguragua, El Altar, Guayrapata, Azuay, Pichincha, and Chimborazo, but devoting most time to the first named. In the year 1860 he was commissioned by Mr. Clement Markham, on behalf of the Indian Government, to procure seeds and young plants of the *Cinchona succirubra*, one of the species which produces the best quinine, in order to establish plantations of this precious tree in the Nilghiries. For this purpose he settled himself in the forests on the western slope of Chimborazo, where this species is found between the heights of 3500 and 7000 feet above the sea-level. Assisted by Mr. Robert Cross, a gardener sent for the purpose of taking charge of the plants on the voyage to India, he collected abundance of ripe seeds and raised a quantity of young plants, all of which arrived safely, and helped to form those fine plantations which now supply an abundance of the valuable drug. He also wrote an elaborate report on the *Cinchona* forests, their vegetation, and the mode of collection and preparation of the bark, which is considered to be one of the best works of its kind that has ever appeared.

This expedition, undertaken and completed under the pressure of almost continual suffering, was the conclusion of Spruce's labours in South America. So long as he had remained in the warm equable climate of the equatorial plains his health had been better than when in England, and appeared to be fairly re-established, notwithstanding much privation and occasional attacks of fever. He suffered, however, from chronic diarrhœa; and the extremes of temperature and of moisture in the forests and mountains, having frequently to wade for hours in ice-cold water, and exposure to the severe and change-

able climate of the high Andes, which, as Mr. Whymper assures us, is the most detestable in the world, brought on an attack of some obscure malarial disease which rendered all further exertion impossible, and led to complications which rendered the remainder of his life that of a confirmed invalid. Under medical advice he removed to the hot and dry sea coast, remaining there for two years in the vain expectation of a recovery sufficient to enable him to extend yet further his botanical explorations.

All hope of renewed health being given up, he returned to England in 1864. After a few months in London, he went to live at Hurstpierpoint, Sussex, in order to be near his correspondent, Mr. William Mitten, who had undertaken to describe the whole of his new South American mosses. After remaining there two or three years, in varying conditions of health, he determined to remove to Yorkshire, where a cottage was offered him on the Castle Howard estate, and where his slender means would enable him to command greater comforts than elsewhere. This was rendered necessary by the loss of a large part of the money derived from the sales of his collections, owing to his having placed it at interest in a commercial house in Ecuador, which, unfortunately, became bankrupt. He was granted a small Government pension in recognition of his services in regard to the establishment of the Indian *Cinchona* plantations and his complete incapacity for any further remunerative work, and on this and the small remnant of his property he was able to live in some comfort, though with the very greatest economy. He resided first at Welburn and afterwards at Coneysthorpe, both small villages situated near Malton and in the immediate vicinity of the noble park of Castle Howard. Here he lived the life of a confirmed invalid, rarely of late years leaving the house, keeping in a room of uniform warmth and subjecting himself to a rigid system of diet. By these precautions he prolonged his life to the ripe age of seventy-six, and then only succumbed to an attack of influenza, from which his much enfeebled system was unable to rally.

During the twenty-five years of his secluded life in Yorkshire he was always occupied with some botanical work, although for much of the time he could only write or use his microscope while reclining on a couch. His more important works during this period were his "*Palmæ Amazonicæ*," forming vol. xi. of the botanical series of the *Journal of the Linnean Society*, and his "*Hepaticæ Amazonicæ et Andinæ*," in the *Transactions of the Botanical Society of Edinburgh*, 1885. During the last few years he published many papers on new Hepaticæ, both American and European, and carried on a considerable correspondence with students of that group in all parts of the world, by whom he was looked up to as one of the greatest, if not the greatest, of living authorities in their favourite study.

Having had the pleasure of Dr. Spruce's acquaintance from the time when he reached Para in 1849—an acquaintance which soon ripened into friendship during the many days spent together in various parts of the Amazon and Rio Negro, in London, at Hurstpierpoint, and during several visits to him at Welburn and Coneysthorpe—a few words descriptive of his appearance and character may not be out of place. Richard Spruce was tall and dark, with fine features of a somewhat southern cast, courteous and dignified in manner, but with a fund of quiet humour which made him a most delightful companion. He possessed in a marked degree the faculty of order, which manifested itself in the unvarying neatness of his dress, his beautifully regular handwriting, and the orderly arrangement of all his surroundings. Whether in a native hut on the Rio Negro, or in his little cottage in Yorkshire, his writing materials, his books, his microscope, his herbaria, his stores of food and clothing, all

had their appointed places in which they were always to be found. This habit of order made him an admirable collector, and I well remember, on visiting Kew after my return from the Amazon, the late Sir William Hooker took out some bundles of plants collected by Dr. Spruce and pointed out to me how well chosen and beautifully preserved they were, notwithstanding that they had been collected in one of the very moistest climates in the world, in which the care and labour required to produce such a result was very great. He was quick at languages; spoke and wrote French with ease; and in South America rapidly acquired the Portuguese and Spanish languages, for the latter of which he had a great admiration. He had literary tastes, and was fond of the old poets; he was full of anecdote, and even when suffering from illness an hour would rarely pass without some humorous remark or pleasant recollection of old times. He was an advanced Liberal in politics, a true lover of the working classes, and nothing more excited his indignant wrath than to hear of the petty, but cruel, persecutions to which they are often subjected. In all his words and ways he was a perfect gentleman, and to possess his personal friendship was a privilege and a pleasure.

Of his merits as a botanist it must be left to experts to speak; but his writings show that he had great powers of observation, and that nothing escaped him that could throw light on the peculiarities of the grand and luxuriant vegetation among which the best years of his life were passed. His papers and letters sufficiently prove that he possessed a clear and picturesque style of writing, and it is to be hoped that the journals kept during his fifteen years' exploration, which he was himself unable to prepare for publication but which must be full of interesting matter, may soon be given to the world. His sole executor is his old friend and neighbour, Mr. Matthew B. Slater, of Malton. A. R. W.

PRECIOUS STONES.

ONLY twenty-five years have elapsed since the existence of diamonds in South Africa was first made known, and during that period the diamond trade of the world has undergone a complete revolution. The working of diamond gravels in Brazil has been almost entirely abandoned, while the search for the gem in India, Borneo, and other districts has been seriously discouraged. The export of rough diamonds from South Africa rose gradually from 200 carats in 1867-68 to 3,841,937 carats in 1888, when it attained a maximum: since that date, however, there has been a slight decline in the output of the mines. The annual value of the diamonds raised in South Africa now exceeds £4,000,000. Strange to say, the discovery of the new and abundant source of diamonds has not had any serious effect in diminishing the market value of the gem. When the diamond was first discovered in South Africa, the estimated value per carat of the rough stones was about £1 10s.; in 1890 the price had risen to £1 13s. 3d., and last year it declined to £1 5s. 8d.

The foregoing particulars are taken from a recently published book which gives an admirable account of the origin of the diamond industry in South Africa, and of the successive changes made in the method of mining and washing the "blue-earth" which yields the gems.<sup>1</sup> This work originally appeared as a guide to the Kimberley exhibition of 1892, and contains so much valuable information in a small compass, that the author has been well-advised in issuing it in its present more permanent form.

<sup>1</sup> "Diamonds and Gold in South Africa." By Theodore Reunert, M.Inst.M.E., Assoc.M.Inst.C.E., with Maps and Illustrations. (London: E. Stanford; and Capetown, Port Elizabeth, and Johannesburg: J. C. Juta and Co., 1893.)

The working of the celebrated mines about Kimberley was commenced by adventurers working independently in their claims. But as the mining was carried to greater and greater depths, combined action became necessary, and gradually the claims were amalgamated and bought up by large companies.

Up to the year 1872 the working of the claims in the South African mines was carried on by a system of roadways, which were laid out when the concessions were first granted. About the date named, the use of these roads had to be abandoned in favour of a system of haulage by wire ropes—these making a network over the whole of the mines. The appearance of the mines under these two systems of working is admirably illustrated by photographs in the work before us. By the year 1884, the mine at Kimberley having been carried to a depth of 400

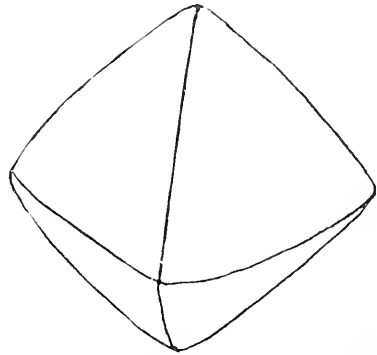

Exact size and shape of a diamond found in the De Beers Mine, and exhibited at the Paris Exposition, 1889. Weight, before cutting, 428½ carats, after cutting, 228½ carats.

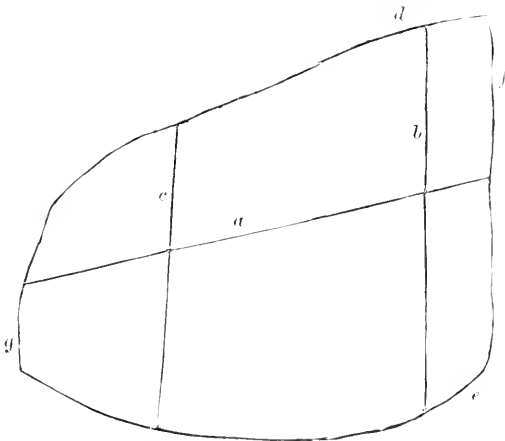

Diamond found in Jagersfontein Mine in June 1893. Length (a) 2½ in.; greatest width (b) 2 in.; smallest width (c) 1½ in. Thickness at (b) end 1¼ in.; thickness at (c) end ¾ in. Extreme girth in width (taken from e to d) 5½ in. Extreme girth in length (taken from f to g) 6½ in. Gross weight 969½ carats.

feet, and heavy falls of material having produced serious loss and inconvenience, it was felt that the time had come for carrying out a totally different system of mining there. Accordingly, in that year, inclined shafts, starting from the surface, outside the limits of the mine, were put down, and these inclined shafts have been since superseded by vertical ones.

The changes in the working of the Kimberley Mine have been followed by similar alterations in the nature of the operations carried on in the three other great mines in its immediate neighbourhood—De Beers, Bultfontein, and Dutoitspan. These four mines are in the vicinity of the townships of Kimberley and Beaconsfield in the British colony of Griqualand West. The only other im-

portant diamond mine in South Africa is that of Jagersfontein, situated in the Orange Free State, about eighty miles to the south-east of Kimberley.

The diamond mines of South Africa are not less remarkable for the size of the individual stones that they have yielded, than for the vast amount of the precious material with which they have flooded the markets of the world. The "Braganza" diamond, which belonged to the Emperor of Brazil, is said to weigh 1680 carats, but it has never been subjected to the inspection of experts, and there is every reason to believe that it is nothing but a colourless topaz. In the same way the reputed diamond of the Rajah of Matan in Borneo (367 carats) has been recently shown to be only a piece of quartz. The "Great Mogul," the Regent or Pitt diamond, and the Koh-i-nûr, the finest productions of the Indian mines, are said to have originally weighed  $787\frac{1}{2}$ , 410, and 193 carats respectively, but were reduced by cutting to  $279\frac{7}{16}$ ,  $136\frac{1}{2}$ , and  $102\frac{3}{4}$  carats. The Brazilian mines have yielded the Portuguese Regent and the Star of the South, the former of which, on cutting, yielding a gem of 215 carats, while the latter weighed  $254\frac{1}{2}$  carats in the rough.

The South African mines have, however, produced stones surpassing in size all those hitherto obtained either from India or Brazil. Some of these stones are, it is true, of a yellow colour, and therefore of comparatively small value; but others, like the Porter-Rhodes diamond (150 carats), the De Beers diamond ( $428\frac{1}{2}$  carats), and the Jagersfontein diamond ( $969\frac{1}{2}$  carats)—the last-mentioned having been discovered as recently as June 30, 1893—are remarkable for their freedom from any trace of yellow tint, and for the perfect whiteness or even blue-whiteness of their colour. We are able to give outlines drawn to the true scale of the two largest South African diamonds, the one characterised by its crystalline form (a regular octahedron), the other by its irregularity of shape. These are taken from Mr. Reunert's book.

Another book on precious stones that has recently appeared is of a very different character, and deals not only with the diamond, but with all the other materials held in esteem by jewellers.<sup>1</sup> The two works are, however, equally entitled to praise for the accuracy and fulness of the information they supply, and for the manner in which the latest sources of information have been utilised.

The distinguishing feature of Dr. Doelter's book upon precious and ornamental stones is the care which has been bestowed upon the directions for their easy and certain discrimination. In the earlier chapters, the descriptions of the various methods for determining and accurately defining the specific gravity, cleavage, hardness, refractive index and double refraction, as well as the colour, pleochroism, and absorption of minerals, are very full and entirely satisfactory. The second part of the work contains systematic descriptions of the minerals employed for purposes of ornament; and these, as might be expected from a mineralogist of Dr. Doelter's position, leave nothing to be desired in the way of completeness and accuracy. No less admirable are the accounts given of the artificial production of these minerals, of the materials made to imitate them, and of the value of gems and the modes of cutting them. Details of this kind are of much practical value, and add greatly to the usefulness of the book as a work of reference. The position of certain minerals in the estimation of jewellers is liable to variation as the popular taste changes, and it is certainly not the same in different countries. Dr. Doelter's classification will, however, we think be generally accepted as a judicious one. Of precious stones proper he admits

three classes, in the highest of which he places only the diamond, the various forms of corundum, the emerald, and the spinel, though possible exception may be taken to the high position allowed to the last of these. The second-class contains euclase, chrysoberyll, zircon, phenacite, topaz, the noble opal, garnet and tourmaline. To the third class are relegated the turquoise, olivine, cordierite, kyanite, andalusite, staurolite, hiddenite, axinite, vesuvian, and diopside. The "semi-noble stones" fall into two classes, in the higher of which are placed quartz, chalcedony, agate, felspars, lapis lazuli, and rhodonite, while the lower contains amber, fluor-spar, nephrite, agalmatolite, malachite, and serpentine. It is doubtful whether some of the forms of quartz, like amethyst and cat's-eye, are not deserving of a place among the noble stones proper.

The third part of the work contains a series of tables for the determination of the minerals which are employed as precious stones. These tables have been drawn up with great care, and cannot fail to prove of very great service to those studying gems and similar materials, either from the scientific or the commercial point of view. The table showing the trade names, and the scientific designations of the several gems, is very complete; and the whole work may be commended for its union of scientific accuracy with practical usefulness.

#### NOTES.

THE International Sanitary Conference, which was to have opened at Paris on January 24, has been postponed to February 7. We learn that President Cleveland has appointed Dr. Edward S. Shakespeare, of Philadelphia, Dr. Stephen Smith, of New York, and Dr. Preston H. Bailhache, of the United States Marine Hospital Service, delegates to represent the United States at the Congress.

A SLIGHT earthquake visited North Devon about 9 a.m. on Tuesday, January 23. The shock seems to have been felt over the whole of Exmoor as far as South Molton.

WE regret to note the death of Prof. A. Hirsch; he died at Berlin on January 28, at the age of seventy-six. We have also to announce the death of Dr. G. Adler, Professor of Mathematical Physics in Vienna University.

DR. K. VON ZITTEL, Professor of Geology in Munich University, has been made a member of the German Privy Council.

AT a public meeting held at Shrewsbury on Tuesday, it was resolved to raise a memorial to Charles Darwin, who was a native of that town. Another public meeting will be held to consider the best method of carrying out the proposal. The Mayor of Shrewsbury, in commenting upon the proposal, rightly remarked that in doing honour to one who had shed an imperishable lustre on his native town they were doing honour to themselves. In addition to the suggestion that a bronze statue of Darwin should be erected in front of the old Grammar School, now the public library and museum, it was proposed to found a scholarship to his memory in connection with Shrewsbury School. Another suggestion was that the memorial should take the form of a hall of science to be erected in Shrewsbury for the purposes of scientific and technical instruction.

IT is reported that a sum approaching £50,000 has been bequeathed by the late Mr. T. H. Adam, of Newport, for the purposes of technical instruction. The money is to be devoted to teaching practical and theoretical agriculture to men and youths, and a knowledge of dairying, housekeeping, and other subjects to women and girls, either by means of lectures or the establishment of a school or schools of agriculture at Edgmond or Woodseaves, in Shropshire, or Chadwell, in Staffordshire, or elsewhere; or by such other means as the trustees shall think fit.

<sup>1</sup> "Edelsteinkunde: Bestimmung und Unterscheidung der Edelsteine und Schmucksteine. Die Künstliche Darstellung der Edelsteine." Von Dr. C. Doelter, o. Prof. der Mineralogie an der K. K. Universität Graz. (Leipzig: Veit and Co., 1893.)

THROUGH the liberality of Mr. J. H. Veitch (says the *Kew Bulletin*), the Museum of the Royal Gardens at Kew has recently been enriched by the whole of the fine and extensive collection of vegetable products made by him during his recent travels in Japan. The collection is not only very extensive, but it is also very varied, and contains many things quite new to the Museum.

THE Rev. C. W. Langmore sends us a description of a fine lunar rainbow observed by him at Bracknell, Berks, about nine o'clock on the evening of Wednesday, January 17. At a distance of about four or five times the moon's apparent diameter a circle of brilliant white was seen. This was surrounded by a broad band of brown-orange of several gradations. Next came a narrow band of violet, followed by a broader band of green, and a narrower one of yellow. The whole series was encircled by a broad band of brown-orange.

A MEETING was held at the Society of Arts on Friday last for the purpose of formally constituting an Association of Technical Institutions. Representatives of almost every technical institution in the country attended the meeting. Principal F. G. Ogilvie, Edinburgh, presided, and it was agreed that the objects of the association should be (a) to provide a medium for the interchange of ideas amongst its members; (b) to influence, by combined action, where desirable, Parliament, County Councils, and other bodies concerned in promoting technical education; and (c) to promote the efficient organisation and management of technical institutions, and to facilitate concordant action among governing bodies, and aid the development of technical education throughout the United Kingdom. The council and officers of the association were elected, and a Parliamentary committee was appointed to take such steps as may be necessary to secure due representation for technical schools on the Commission for dealing with secondary education, and to watch the progress of legislation affecting such schools.

THE twenty-first annual dinner of old students of the Royal School of Mines was held on Monday. More than 150 guests were present, among them being Profs. W. C. Roberts Austen, Le Neve Foster, T. E. Thorpe, A. W. Rücker, and G. B. Howes, Sir H. Trueman Wood, Sir Lowthian Bell, Captain Abney, Mr. Bennett H. Brough, Mr. W. Topley, Mr. P. C. Gilchrist, Mr. R. D. Oldham, Dr. E. J. Ball, and Dr. Wynne.

THE weather has recently been very unsettled over the British Islands, owing to the influence of a succession of great atmospheric disturbances passing from the Atlantic to the northward of Scotland; strong gales have occurred in some parts daily for more than a week, accompanied at times with thunderstorms and snow or hail. During the latter part of last week reports from the Azores showed that the barometer there was two inches higher than in Scandinavia, and the steel barometric gradients over this country caused the wind to blow with the force of 10 of the Beaufort scale (0-12) in the north and west, both on Saturday and Monday. Although rain has fallen every day, the amount has only been heavy in exceptional cases; an inch and upwards in twenty-four hours was measured both in the north and south towards the close of the week. In the north of Scotland the fall for the week ended January 27 was much above the average.

DR. J. HANN has just communicated to the Academy of Sciences at Vienna a paper entitled "Contribution to the daily range of the meteorological elements in the higher strata of the atmosphere," containing (1) the calculation of the two-hourly observations of all the meteorological elements on the summit of the Ontake in Japan (10,023 feet), from August 1 to September 12, 1891, and at two base stations, with a thorough investigation of the results by harmonic analysis, by which means some interesting differences in the daily range are exhibited between the upper and lower stations; (2) the calcu-

lation and discussion of the observations made by self-recording instruments established by M. J. Vallot on Mont Blanc (15,770 feet), from July to September, 1887, together with observations at Grand Mulets (9875 feet) and Chamounix (3396 feet). The maximum temperature on Mont Blanc occurred at 1h. 30m. p.m., and at the other stations at 1h. p.m., but at Geneva it occurred at 2h. 30m. p.m. The mean temperature on Mont Blanc from July 18 to August 14 was 20°·5, and at Geneva 69°·8. The average decrease with height was therefore 1°·1 F. for each 100 metres (328 feet); the maximum decrease was 1°·3 at 3h. p.m., and the minimum nearly 1°·0 at 4h. a.m. The daily range of atmospheric pressure shows that notwithstanding the enormous height the double daily period still occurred. The author then discussed, with the aid of the Bavarian stations, the modifications to which the single daily barometric oscillation with increasing altitude is subject. The analysis shows that the amplitudes first decrease with height, and then increase, from about the height above sea at which the times of the phases begin to run in an opposite way to those at the surface of the earth. The influence of the daily variation of temperature in the strata of air below the mountain summit, is thoroughly discussed on the basis of these results. Dr. Hann points out that it is one of the most interesting results of barometric observations on high mountain peaks, that they show us that daily temperature oscillations in free air are much smaller than those shown by thermometers at stations, even those on the peaks. Meteorological science is much indebted to Dr. Hann for this valuable and laborious investigation.

TWO ways of producing "artificial glaciers" are described by K. R. Koch in *Wiedmann's Annalen*. The yellow kinds of pitch resembling colophony, which can be commercially obtained, exhibit the plasticity with regard to pressure, and brittleness with regard to tension, that ice possesses, or at least the surface layers do after some exposure to the air. Herr Koch takes a square tray provided with a slanting gutter, down which the pitch is allowed slowly to descend. To prevent its rolling down, the gutter is first lined with a layer of very hot pitch. As the mass descends, fissures are produced in the surface, which show a great resemblance to those observed in ice, though not so deep as the latter. Cracks proceed from the edges towards the middle at an angle of forty-five degrees to the edges, and join the transverse fissures in the centre. Where the bed widens, longitudinal crevices are produced. The black fissures show well in the brown surface. Another method is to coat the pitch with a layer of some white paint, when the cracks appear black on white. It can thus be easily shown that particular forms of cracks always appear at particular parts of the bed. The motion, sometimes uniformly progressive, sometimes pausing, and sometimes directed upwards, can be well studied with a microscope.

THOSE who have had occasion to measure an electric current by the deposition of silver on a platinum bowl as kathode, have probably occasionally noticed the very regular manner in which the silver is deposited in radial lines. This appearance is particularly noticeable on the sides of the bowl, and when a somewhat strong solution of silver nitrate is employed. Herr U. Behn has conducted an elaborate series of experiments with a view to ascertaining the cause of this regular deposition, and has examined the effect on the deposit produced by the concentration of the solution, the current density, and the potential difference between the anode and kathode. He finds that in the electrolysis of silver nitrate, the effect is best obtained with a concentrated solution of the salt, and when the current density at the kathode is small. An increase in the temperature of the voltameter is found to facilitate the formation of the ridges, while, on the other hand, the value of the electromotive force employed seems to exert no influence.

The author has succeeded in obtaining the same effect with solutions of copper sulphate, and finds that the chief condition which must in this case be fulfilled is that the current density should be small. The concentration of the solution affects the deposit in the same manner as with silver nitrate, though to a smaller extent. Much smaller ridges were obtained with solutions of lead acetate and of zinc sulphate. The author considers that the ridges are in all cases caused by the effect of convection currents set up in the electrolyte owing to the changes in concentration which go on in the liquid during the passage of the current. The paper in which these results are given is published in *Wiedemann's Annalen* for January.

IN the January number of *Zeitschrift für praktische Geologie* a brief historical account may be read of the Geological Survey Departments of Bavaria and of Alsace-Lorraine. Bavaria was the first among German States to found a Government Geological Survey. That was more than forty years ago, and ever since its commencement it has been under the able guidance of Oberberg Direktor von Gumbel. To his tireless zeal is largely due the enormous amount of work accomplished by the Survey. The mountains on the borderland of Bohemia and the Austrian Tyrol have been mapped in detail, Franconia was completed in 1891, and there still remain Rhenish Bavaria, the Danube districts, and certain parts in the north-west of Bavaria. The Alsace-Lorraine Survey, instituted in 1873 under the management of Profs. Benecke and Rosenbusch, was handicapped at its commencement by the want of detailed topographical maps. Rapid strides are now being made, and a series of geological sheets of Northern Lorraine have been published since 1887. The long southern strip of Alsace is scarcely begun. National rivalry makes itself felt along the French frontier. The German geologists complain that it is made practically impossible for them to carry their work over the frontier, whereas the French geologists have had the advantage of free access into Alsatian territory.

MODERN geology entered on a new period of progress when it realised some of the results of horizontal rock movement. Heim, Lapworth, Bertrand, and others proved beyond dispute that rock masses could be displaced and carried many miles over the surfaces of underlying rock. A Swiss geologist has just proposed a movement of this kind, but on a gigantic scale, as an explanation of the Chablais mountains which extend on both sides of Lake Geneva. He imagines that the upper part of an immense fold of rock was carried from the districts south of Mont Blanc and Mont Rosa, to the northern slopes of the Alps, and that this movement was not limited to the Swiss areas, but could be traced eastwards at least into the Engadine. The Chablais mountains and fragmentary portions all along the northern edge of the Swiss and Bavarian highlands are thought to be the remaining traces of the carried rocks, and to be, in short, geologically misplaced mountains. Should this theory prove to be correct, it will be of the highest importance; at the same time, the evidence in its favour does not yet profess to be entirely conclusive. (*Arch. des Sc. Phys. et natur.*, December, 1893, Geneva, "Sur l'origine des Préalpes Romandes," by Hans Schardt.)

THE statistics of the cases treated for hydrophobia during the month of November at the Pasteur Institute in Paris appear in the December number of the *Annales de l'Institut Pasteur*. No less than 129 persons underwent this treatment, and of these ninety-four were bitten by undoubtedly rabid animals, the remainder having been attacked by animals suspected of suffering from rabies at the time, but in which the actual proof of this being the case, such as a veterinary examination and communication of the disease to other animals, was wanting. Of these persons 109 were bitten by dogs, seventeen by cats, one by a horse, one by a sheep, and one by a pig. In October 127,

in September 108, and in August 135 persons were treated for hydrophobia in Paris. The establishment of similar institutes in so many other parts of the world, naturally tends to reduce the number of foreigners attending the Pasteur Institute in Paris; last year's statistics, however, showed that England still furnished a considerable proportion of the strangers at the Institute, and this state of things is unfortunately likely to continue as long as we are obliged to depend upon other countries for the treatment of this terrible disease.

WE published a few years ago a review of an elaborate work on the chemical and bacteriological examination of potable waters by Salazar and Newman; these authors have recently communicated a paper on the ice consumed in Valparaiso to the "Actes de la Société Scientifique du Chili," 1893. The inconsistency of people taking elaborate precautions to ensure the purity of their drinking water, whilst ice is used without any consideration of its source, is pointed out. In one of the samples examined, and taken from some of the ice supplied to the city, as many as 15,300 micro-organisms were found in a cubic centimetre of melted ice. Following in the footsteps of other investigators, the authors insist upon all ice used for consumption being prepared from water rendered above suspicion by being either previously distilled or passed through Chamberland filters.

A CATALOGUE of meteorological, magnetic, and physical instruments has been received from E. A. Zschau, Hamburg.

THE December number of Dr. Braithwaite's "British Moss Flora" has been received. It deals with Bryaceæ and Bartramiaceæ.

WE have received several supplements to the Queensland Government Gazette, containing the statistics of meteorological observations made in Queensland during 1893.

THE January number of the *Essex Review* contains an obituary notice of the late Mr. E. Charlesworth, and an article on technical instruction in Essex, by Mr. J. H. Nicholas.

BY far the best description that we have seen of the Manchester Ship Canal, both as regards text and illustration, appears in *Engineering* for January 26. The work is traced from its beginning, eleven and a half years ago, and all the details of construction are dealt with in a very exhaustive manner.

WE have received from Messrs. Williams and Norgate a work entitled "Descriptive Biography Columns," by Mr. Nasarvanji Jivanji Readymoney. The work is designed to receive records of the events that make up one's life, and is therefore similar to Mr. Galton's life-history album, with the addition of a few novel features.

THE second edition of Clowes' and Coleman's "Quantitative Chemical Analysis" (J. and A. Churchill) has just appeared. The original edition was reviewed in these columns in April, 1892. Several important alterations and additions have since been made, thereby increasing the value of a book that has been found useful to both teachers and students.

*Bulletin* No. 41 of the Experimental Station of the Kansas State Agricultural College, Manhattan, is devoted to a report from the Botanical Department on the effect of fungicides on the germination of corn.

THE *Monatsschrift für Kakteenkunde*, a monthly journal devoted entirely to the cultivation of *Cacti* and other succulent plants, has now entered on the fourth year of its existence. It is edited by Prof. Schumann, of Berlin, and published by Neumann, at Neudamm, in Brandenburg.

WE have received the *Agricultural Gazette of New South Wales* for October, 1893, containing, among other papers, an elaborate one by Mr. N. A. Cobb, on "Plant Diseases and their Remedies." The present instalment is entirely devoted to the very numerous diseases which attack the sugar-cane; copious illustrations are given of its animal and vegetable parasites.

MR. W. TRELEASE reprints, from the fifth annual Report of the Missouri Botanical Garden, an elaborate illustrated paper on sugar maples. He recognises ten species of *Acer* natives of the United States, and classifies them under five groups—the bush maples, vine maples, sycamore maples, soft maples, and hard or sugar maples. The sugar maples are *Acer grandidentatum*, *saccharum*, and *Floridanum*. Linnæus's *Acer saccharinum* is not a sugar maple at all, but is the silver maple belonging to the group of soft maples.

A NEW method of preparing phosphorus is described by Messrs. Rossel and Frank in the current issue of the *Berichte*. By the use of aluminium as reducing agent it is shown that phosphorus may be directly obtained from any mineral phosphate, and the method lends itself admirably to lecture-table demonstration. When ordinary microcosmic salt, hydrogen ammonium sodium phosphate, is fused in a porcelain crucible until it is converted into sodium metaphosphate, and aluminium turnings are dropped into the liquid, the flame of burning phosphorus at once appears. If the experiment is conducted in a glass tube in a slow current of dry hydrogen the phosphorus distils into the cooler part and without the formation of any phosphoretted hydrogen. The residue consists of alumina, sodium aluminate, and a phosphide of aluminium of the composition  $Al_3P_5$ . This latter substance may be isolated as a grey crystalline powder by leading phosphorus vapour over aluminium heated in a combustion tube; it is unchanged by further heating, but is decomposed by water with formation of aluminium hydrate, phosphoric acid, and phosphoretted hydrogen. In the preparation of phosphorus by the method above described it is consequently impossible to obtain more than thirty per cent. of the phosphorus contained in the mineral phosphate employed. But it is found that the phosphide is totally decomposed by heating with silica, and hence if the mineral phosphate is previously mixed with some form of silica the whole of the phosphorus is liberated, and the reaction proceeds in a regular and readily controllable manner. Bone meal, powdered phosphorite or fossil phosphate, magnesium pyrophosphate, calcium metaphosphate, or any ordinary available phosphate, may be employed. Care must be taken, however, not to employ superphosphates containing admixed calcium sulphate, such as are commonly obtained for agricultural purposes by treatment with sulphuric acid without separation of the sulphate, for the sulphate is suddenly decomposed by the aluminium when a certain temperature is attained, with explosive force. Superphosphates obtained by treatment with hydrochloric instead of sulphuric acid may be employed with perfect safety, as chlorides are not explosively decomposed by aluminium. The new mode of preparing phosphorus may be conveniently illustrated upon the lecture-table by placing in a combustion tube a yard long, traversed by a slow current of hydrogen, a mixture of two and a half parts of aluminium, six parts of sodium metaphosphate, obtained by heating microcosmic salt, and two parts of finely divided prepared silica, and heating until the reaction commences. This is notified by a sudden brilliant incandescence, and phosphorus is observed to rapidly condense in globules in the cooler portion of the tube, at the end nearest the draught-hole into which the escaping hydrogen is led.

AN interesting paper upon the interaction between oxygen and phosphoretted hydrogen is contributed to the *Zeitschrift für Physikalische Chemie* by Dr. Van de Stadt. It is shown that the two gases instantly combine, with the appearance of flame, when they are allowed to mix under diminished pressure. The combination occurs under these circumstances in the proportions of two volumes of hydrogen phosphide to three volumes of oxygen, the product being phosphorous acid. When, however, the oxygen is admitted very slowly, or the two gases are allowed to mix by diffusion under a pressure not exceeding 50 mm. equal volumes appear to react with production of a greenish flame, liberation of hydrogen, and formation of a crystalline deposit on the walls of the vessel. The crystals melt at about  $80^\circ$ , and appear to consist of the little-known metaphosphorous acid  $HPO_2$ ; they are deliquescent, but after combination with sufficient water vapour to produce ordinary orthophosphorous acid the substance solidifies again. If the pressure is greater than 50 mm. both the meta and ortho acid are produced together with more or less free hydrogen. When the pressure is gradually reduced the gases combine at a certain low pressure with explosion. It is somewhat remarkable that the influence of moisture is directly opposite to that usually observed, for instead of facilitating the combination it greatly retards it.

NOTES from the Marine Biological Station, Plymouth.—Recent captures include two specimens of a small well-marked species of *Doris*, new to Britain, and probably to science. The tow-nets, on the other hand, have not yielded much of unusual interest lately, the chief contents being Copepods, *Sagitta*, Cirrihipede *Nauplii*, Polychæte larvæ, and Teleostean ova. The breeding season of a large number of both Fishes and Invertebrates has, however, recently commenced, including the Nemertine *Lineus obscurus*, the Polychæte *Phyllodoce*, the Mollusca *Purpura lapillus* and *Acanthodoris pilosa*, the Crustacea *Craggon vulgaris* and *Eurynome aspera*, and the Ascidian *Botryllus violaceus*. The Anthozoa *Aleyonium digitatum* and *Ceruus pedunculatus* are still breeding.

THE additions to the Zoological Society's Gardens during the past week include two Black-eared Marmosets (*Hapale penicillata*) from South-east Brazil, presented by Mrs. G. E. Russell; two Weka Rails (*Ocydromus australis*) from New Zealand, presented by the Hon. Lancelot Lowther; a Cross-bill (*Loxia curvirostra*) British, presented by Mr. W. S. Berridge; a King Snake (*Coluber getulus*) from Florida, presented by Mr. Lawson Reuss; a Rose-ringed Parrakeet (*Palcornis docilis*) from West Africa, presented by Mr. J. Hickman; a Ring-tailed Coati (*Nasua rufa*) from South America, deposited; two Abyssinian Guinea Fowls (*Numida pitlorhyncha*) from Somaliland, two Burrowing Owls (*Speotyto cucularia*) from America, eight Undulated Grass Parrakeets (*Melopsittacus undulatus*) from Australia, purchased.

#### OUR ASTRONOMICAL COLUMN.

JUPITER'S SATELLITES IN 1664.—In the New York *Nation*, Mr. D. C. Gilman calls attention to an interesting letter of John Winthrop, written in 1664 to Sir Robert Moray. The letter is printed in the *Proceedings* of the Massachusetts Historical Society, June, 1878, and the following is an extract from it:—

"Having looked upon Jupiter with a Telescope, upon the 6th of August last, I saw 5 (?) Satellytes very distinctly about that Planet: I observed it with the best curiosity I could, taking very distinct notice of the number of them, by several aspects with some convenient tyme of intermission; & though I was not without some consideration whether that fifth might not be some fixt star with which Jupiter might at that tyme be in neare conjunction, yet that consideration made me the more

carefully to take notice whether I could discern any such difference of one of them from the other four, that might by the more twinkling light of it or any other appearance give ground to believe that it might be a fixt star, but I could discern nothing of that nature: and I consider that the tube with which I looked upon them, though so good as to shew very clearly the Satellites, yet was but of 3 foote and halfe with a concave ey-glasse; and I question whether by a farre better tube a fixt star can be discerned so near the body of that planet when in the ever bright activity of its light, for, if so, why are there not often if not always seene with the best tubes the like or more."

The fifth body observed by Winthrop was probably a small star, but though it cannot definitely be said what the body was, every one will agree that it was not the fifth satellite discovered by Prof. Barnard. Even at the present time it is not uncommon for an astronomical tyro to believe he has seen the moons of Mars by means of an opera-glass, being deceived by the appearance of small stars in the vicinity of the planet, and there is little doubt that Winthrop was misled in a similar manner.

THE U.S. NAVAL OBSERVATORY.—The report of Captain F. V. McNair, superintendent of the U.S. Naval Observatory, for the year ending June 30, 1893, has just been issued. We extract from it a few points of interest. On May 15, 1893, the old Naval Observatory was formally abandoned as an observatory, and the new site on Georgetown Heights, Washington, officially occupied. Owing to this change, few observations of the heavenly bodies have been made since the last report. Prof. Eastman has determined the position of the new observatory with reference to the old one. Assuming the adopted latitude and longitude of the old observatory to be correct, the position of the new is lat.  $38^{\circ} 55' 14''$ .68, and long. 5h. 5m.  $15' 71s$ . west of Greenwich. Prof. Eastman has been relieved of the charge of the transit circle, and is now chief of the department of fundamental observations. The new office is one that many astronomers would consider of doubtful advantage, for we learn that the department consists of one computer to assist in compiling the results of twenty-three years' observations of stars with the transit circle. Prof. Harkness has been chiefly engaged in overlooking the remounting of the equatorials and the prime vertical transit instrument. Into the mountings of the 12 and 26-inch equatorials he has introduced a pair of dials for indicating the right ascension and declination of the point of the heavens to which the telescope is directed. The dials face the observer when his hands are upon the right ascension and declination quick motions, they are brightly illuminated, they give the same degree of accuracy as the old-fashioned coarse circles, and as the right-ascension dial is moved by clockwork it shows the apparent right ascension of the telescope, together with its hour angle, and the right ascension of the meridian. Having the right ascension and declination of any visible object, the observer can instantly bring it into the field of the finder by setting these coordinates upon the dials. All the movements of the instrument are controlled, and all the readings of the dials and circles are made, either from the floor of the dome or from the eye end of the main telescope, thus enabling an observer to work alone without the aid of an assistant. For greater convenience in observing the sun and moon, supplementary gearing has been introduced into the driving clock, by means of which the speed of the telescope can be instantly changed from sidereal to mean solar or mean lunar. Prof. Harkness' arrangement is extremely ingenious, and should be adopted in all observatories in which the aim is to minimise inconveniences. Prof. Frisby reports that, with the assistance of Prof. Brown, the catalogue of 17,000 stars observed by the late Captain Gilliss, at Santiago, has been completed, and is now ready for publication. These facts suffice to show that though the observatory was in an unsettled condition during the year covered by the report, a large amount of good work was accomplished.

THE SATELLITE OF NEPTUNE.—Prof. Struve recently communicated to the St. Petersburg Academy of Sciences a discussion of the observations of the satellite of Neptune made with the 30-inch refractor at Pulkova from 1885 to 1893. A comparison of the four orbits calculated for four different epochs has clearly established the existence of the progressive movement of the pole of the orbit suspected by Mr. Marth some years ago. An acceleration of the motion of the satellite has been detected, the cause of which is unknown. The value obtained for the mass of Neptune is  $1/19396$ , the sun's mass being unity.

## GEOGRAPHICAL NOTES.

PROF. MARCEL DUBOIS publishes in the last number of the *Annales de Géographie* an epitome of his address on the inauguration of the Chair of Colonial Geography in the *Faculté des Lettres* at Paris. He proposes to treat the subject of colonial geography on widely philosophical lines, and repudiates the suggestion that it is synonymous with the history of French colonisation or the topographical description of French colonies. M. Dubois is one of the leading exponents in France of the modern conception of geography as a science involving the application of the results of many sciences to the central problem of the relation of Man to the earth.

THE new number of *Petermanns Mitteilungen* contains the first instalment of a paper by Count Joachim Pfeil on South-west Africa, illustrated by an excellent map of the region bordering  $20^{\circ}$  E., showing the routes of all travellers who have crossed it, and a series of valuable sections from Count Pfeil's own determinations of altitude. The number also contains an account of the Adelsberg Grotto, by Herr Kraus, referring specially to the explorations of MM. Martel and Putick, mentioned in *NATURE*, vol. xlix. p. 256.

PRINCE CONSTANTINE WIAZEMSKI has completed a very extensive journey through Asia, of which he will soon give an account to the Paris Geographical Society. Leaving St. Petersburg in 1892, he travelled to China by Siberia, and continued thence though Tonkin to Annam, Cambodia, Cochin-China, Siam, the Laos country, Burma, Manipur, Kashmir, Tibet, Bokhara, and Persia, arriving at Tiflis in November last. In this great land journey he made extensive scientific collections, which were unfortunately nearly all lost on account of attacks by natives when passing through the Chin country.

## THE LARGE FIREBALL OF JANUARY 25.

A LARGE detonating fireball was observed over a large district at ten o'clock on the evening of Thursday, January 25. Mr. W. F. Denning has sent us the following detailed description of the phenomenon:—

"A slow-moving fireball of the most brilliant kind was seen at Bristol on January 25, at 10h. 1m. Clouds covered the sky at the time, but the planet Jupiter and a few of the brighter stars were dimly visible.

"A sudden and vivid illumination of the firmament caused me to look upwards, without, however, seeing anything. A second flash prompted me to turn round, when I immediately saw, in the north-north-east, the expiring splendours of a large double-headed fireball. No stars could be distinguished in the vicinity, but the point of disappearance was afterwards carefully determined as in azimuth  $206^{\circ}$  west of south, and altitude  $20^{\circ}$ . It was slightly descending, and the backward prolongation of its track indicates the radiant as near  $\alpha$  Cephei.

"The fireball appears to have been seen with startling effect at many places in Worcestershire. At Alvechurch, Redditch, a loud report similar to a clap of thunder was heard after the disruption of the meteor, and there was a perceptible oscillation, supposed to be due to a slight shock of earthquake. At Worcester, Droitwich, and other places in the locality, windows were violently rattled and houses shaken, so that people rushed out of doors in a terrified state.

"The meteor was well seen at Birmingham, and the detonation followed the explosion in three minutes, according to the testimony of two trustworthy observers.

"From a discussion of the various observations, the disappearance of the meteor is well indicated at a height of only sixteen miles above a point of the earth's surface, four miles north of Ashchurch, near Tewkesbury. Its direction was from north-north-west to south-south-east, and the earth point at Swindon, thirty-five miles from the place of disappearance. The descriptions are somewhat conflicting as to the early stages of the meteor's flight, but it probably passed over Chester at an elevation of fifty-eight miles. At the time of its disappearance near Ashchurch it was forty-seven miles from Bristol, and thirty-six from Birmingham."

Mr. Lloyd Bozward writes to us as follows:—"At about ten on Thursday night a meteor of enormous size passed over Worcester. The night here was densely overcast. For all that, the brilliance was so intense as to dim the light of the street lamps. Even when first manifest the radiance was exceedingly bright,



and as the phenomenon passed onwards the light grew in brightness until it equalled the lustre of the electric arc, and has been compared to the glow of a great electric search-light. The emitted light lasted at least 30 seconds. Apparently the path was from the north-west. Two minutes after disappearance three detonations were heard, the last being of exceptional violence, shaking buildings, and causing the earth to vibrate. Here at Henwick, the head of the meteor, though visible at other places, was invisible, but a magnificent long luminous trail was apparent. At Hallow, hence three miles north, and at Clifton-on-Teme, hence twelve miles north-west, the light was seen, and the effects of the terrific explosion were experienced. At the former place the crockery-ware was jarred off the shelves of cottages. A loud rumbling noise was also heard, some persons describing it as like the prolonged roar of distant thunder. At the Wych Malvern, slates were displaced from house-roofs. A gentleman who observed the meteor at Mold, North Wales, says that, if anything, it appeared to him to be larger than the moon. The colour 'was blue in the centre, and had yellow fire round the edges.' No explosion was heard there. The meteor, it is supposed, broke up near Clifton-on-Teme, but no trace of its débris has hitherto been found. At Droitwich, hence seven miles north-east, it was thought that the Evesham gas works, twelve miles away, had blown up. At Pershore the head of the meteor was seen, and its bursting, which it is said was accompanied by the flashing of a dull red light, was witnessed. At Malvern, eight miles westward, the terrific effects of the occurrence were apparent. Here there is no previous record of a meteor on so grand, prolonged, and terrific a scale."

Several letters describing the meteor have appeared in the *Times*. Mr. W. H. Lloyd observed the phenomenon from the top of the Cotswolds, about half a mile north of Minchin Hampton. He saw a ball of fire pass rapidly from north to south, and disappear in one or two seconds. About a minute or a minute and a half afterwards a series of explosions was heard. A detonating sound was also heard at Cheltenham, but at some other places no peculiar sound was noticed. A loud rumbling noise like an explosion was heard near Ross, Herefordshire, and ascribed to an earthquake shock. Mr. J. G. Wood remarks in yesterday's *Times* that there is possibly a connection between earthquakes and meteoric phenomena. He points out that the North Devon disturbance of January 23 (see p. 320) was followed by the meteor of January 25, and that both an earthquake and a bright light was observed at Ross, though the observer did not actually see a meteor. The light of the meteor is variously stated, but the majority of observers describe it as intensely bright and bluish, similar to the light of the electric arc. Mr. J. D. La Touche, writing from Stokesay Vicarage, Shropshire, says that the phenomenon continued for certainly more than half a minute; but at Brixworth, Northampton, the duration is said to have been about seven or eight seconds. All agree, however, that the meteor was of a brilliancy so great that the whole sky was illuminated, and Venus and Jupiter paled into insignificance before it.

ON A METEORITE FROM GILGOIN STATION.<sup>1</sup>

IT will be remembered that at the June (1889) meeting of the Society I exhibited a meteor weighing 67½ lbs. sent to me by Mr. J. F. Yeomons, of Gilgoin Station, situated forty miles towards east south-east from Brewarrina. (This meteorite is the left-hand one shown in the accompanying figure.) It had been long exposed to the weather, and the chemical action of air and rain had broken up the surface of it to such an extent that pieces fell off each time it was handled.

On February 8, 1893, Mr. Yeomons again wrote to me and said:—"We have in our possession an aerolite, found, a short

time since, about two miles south of the one sent you some time ago. I can have it sent to you by train from Byrock." Various delays occurred, and I did not get it until September 5. The meteor had been very carefully packed, and had not suffered much loss on the journey, although, like the previous one from this locality, it is much cracked, and many parts of the surface are ready to crumble away. All the parts together weigh 74½ lbs., and its specific gravity as a whole is 3.757. The No. 1 Gilgoin meteor weighs 67½ lbs. and its specific gravity is 3.857. They are so much alike that it strengthens the probability arising from external similarity and nearness of the localities in which they were found that they are parts of one much larger. It is but right, however, to add that if so, they must have travelled through the atmosphere together a sufficient distance to cause the usual melted surface, which, although in parts lost by subsequent slow effect of oxidation, is yet too extensive to admit the alternative that they divided as they fell.

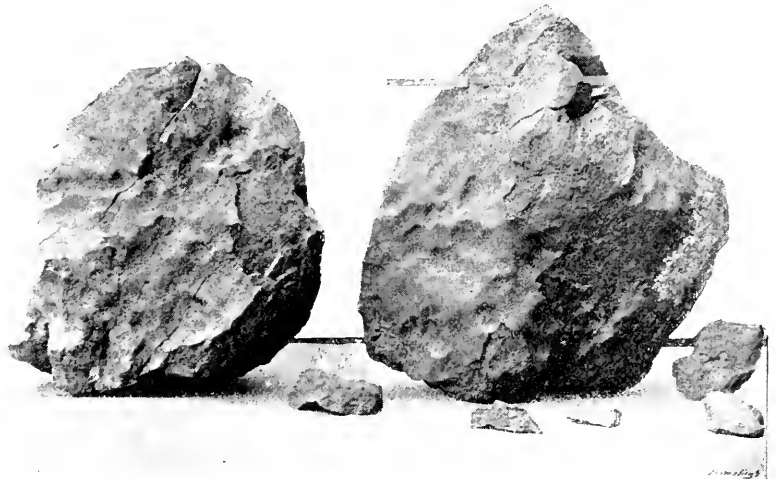

This recently-found No. 2 Gilgoin meteorite is, roughly, double convex, and measures 7 inches through the thickest part, and 14 × 15 inches diameter. The surface has been melted, but is not so smooth and glossy as others I have seen; when a part of it which has not been oxidised is broken, it is dark grey in colour, and shows a great abundance of fine bright, white metallic particles. The rule is laid in a space left by some pieces missing. The meteorite has not yet been analysed, but I hope Prof. Liversidge will undertake that work.

H. C. RUSSELL.

MODERN MATHEMATICAL THOUGHT.<sup>1</sup>

ONE who, like myself, is not a mathematician in the modern sense naturally feels that some apology is due for accepting the invitation with which this society has honoured me, to address it on a mathematical subject. Possibly an adequate apology may be found in the reflection that one who has not gone deeply into any of the contemporaneous problems of mathematics, but who, as a student, has had a sufficient fondness for the subject to keep himself informed of the general course of thought in it, may be able to take such a general review as is appropriate to the present occasion. I shall therefore ask your consideration of some comparisons between the mode of thinking on mathematical subjects at the present time, and those methods which have come down to us from the past, with a view of pointing out in what direction progress lies, and what is the significance of mathematical investigation at the present day.

Among the miscellaneous reading of my youth was a history of modern Europe, which concluded with a general survey and attempted forecast of progress in arts, science, and literature. So far as I can judge, this work was written about the time of

<sup>1</sup> Address delivered before the New York Mathematical Society at the annual meeting, December 23, 1893, by Prof. Simon Newcomb.

<sup>1</sup> Read at the Royal Society, Sydney, November 1, 1893.

Euler or Lagrange. On the subject of mathematics the writer's conclusion was that fruitful investigation seemed at an end, and that there was little prospect of brilliant discoveries in the future. To us, a century later, this judgment might seem to illustrate the danger of prophesying, and lead us to look upon the author as one who must have been too prone to hasty conclusions. I am not sure that careful analysis would not show the author's view to be less rash than it may now appear. May we not say that in the special direction and along the special lines which mathematical research was following a century ago no very brilliant discoveries have been made? Can we really say that Euler's field of work has been greatly widened since his time? Of the great problems which baffled the skill of the ancient geometers, including the quadrature of the circle, the duplication of the cube, and the trisection of the angle, we have not solved one. Our only advance in treating them has been to show that they are insoluble. To the problem of three bodies we have not added one of the integrals necessary to the complete solution. Our elementary integral calculus is two centuries old. For the general equation of the fifth degree we have only shown that no solution exists. We should, doubtless, solve many of the problems which the Bernoullis and their contemporaries amused themselves by putting to each other, rather better than they did; but, after all, could we get any solution which was beyond their powers? I speak with some diffidence on such a point as this; but it seems to me that progress has been made by going back to elementary principles, and starting out to survey the whole field of mathematical investigation from a higher plane than that on which our predecessors stood, rather than by continuing on their lines.

We may illustrate this passage to new modes of thought by comparing Euclid's doctrine of ratio and proportion with our own. No one questions the beauty or rigour of the process by which Euclid developed this doctrine in his fifth book, and applied it to the theory of numbers in his seventh book. But can we help pitying our forefathers who had to learn the complex propositions and ponderous demonstrations of the fifth book, all the processes and results of which we could now write on a single sheet of paper? As a mental discipline the study was excellent; but it seems hardly possible that one could have remembered the propositions or the methods of demonstrating them if he had no other knowledge of them than that derived from the work itself. When we carefully examine these propositions, we find that while Euclid recognised the fact that one of two ratios might be greater than, equal to, or less than another, yet he never regarded them as mere quantities which could be treated as such. From his standpoint a ratio was always a relation, and a relation cannot exist without two terms.

In pointing out this complexity of Euclid's doctrine, I must not be taken to endorse the very loose way in which the doctrine in question is usually treated in our modern textbooks. What we should aim at is to replace Euclid's methods by those which pertain to modern mathematics. At the present time we conceive that a relation between any two concepts of the same kind may always be reduced to a single term by substituting for it an operator whose function it is to change one of these concepts into the other. In the case of the relation between two lines, considered simply as one dimensional quantities, which relation is called a ratio, we regard the ratio as a numerical factor or multiple, which, operating on one line, changes it into the other. For example, that relation which Euclid would have expressed by saying that two lines were to each other as 5 to 2, or that twice one line was equal to five times the other, we should now express by saying that if we multiplied one of the lines by two and one half, we should produce the other. This might seem to be simple difference of words, but it is much more. It is a simplification of ideas; a substitution of one conception for two. Euclid needed two terms to express a relation; we need but one.

But this is not the only simplification. A peculiarity of our modern mathematics is that operators themselves are regarded as independent objects of reasoning; susceptible of becoming operands, without specification of their particular qualities as operators. Thus, instead of considering the ratio which I have just mentioned as an operation of multiplying a line by two and one half, we finally reduce it to the simple quantity two and one half, which we may conceive to remain inert until we bring it into activity as a multiplier. It thus assumes a concrete form,

capable of being carried about in thought, and operated upon as if it were a single thing.

This example may afford us a starting-point for a farther illustration of the way in which we have broadened the conceptions which lie at the basis of mathematical thought. Let us reflect upon the relation between a straight line going out from a certain point, and another line of equal length going out from the same point at right angles to the first. Had this relation been presented to Euclid as a subject for study, he would probably have replied that though much simpler than those he was studying, he could see nothing fruitful in it, and would have drawn no conclusions from it. But if we trace up the thought we shall find a wide field before us, embracing the first conception of groups, and with it an important part of our modern mathematics. In accordance with the principle already set forth, we replace the relation between these two lines by an operator which will change the first into the second. We define this operator by saying that its function is to turn a line through a right angle in a fixed plane containing the line. This definition permits of the operator in question being applied to any line in the plane. Then let us apply it twice in succession to the same line. The result will be a line pointing in the opposite direction from the original one. A third operation will bring it again to a right angle on the opposite side from the second position; and a fourth will restore the line to its original position, the result being to carry it through a complete circle. If we now consider the operations which would have been equivalent to these one, two, three, and four revolutions through a right angle as four separate operators, we see that their results will be either to leave the line in its original position, or to move it into one of three definite positions. If we then repeat one of these four operations as often as we please, or in any order we please, we shall only bring the line to one of the four positions in question. We thus have a group of the fourth order, possessing the property that the repetition of any two operations of the group is equivalent to some single operation of it.

I scarcely need call attention to the familiar homology between these operations and successive multiplications by the imaginary unit  $\sqrt{-1}$ . This last concept, considered as a multiplier, has the same properties as our rotating operator. Repeated twice, it changes the sign or direction of the quantity on which it operates; repeated four times, it restores it to its original value. Let us extend this idea a little. Instead of taking two lines at right angles to each other, let us consider two which form an angle of  $40^\circ$ . As already remarked, this relation is homologous with an operator which will turn a single line through that angle. If we continually repeat this operation, we shall bring the line into thirty-five different positions, the thirty-sixth position being identical with the original one. Thus we should have thirty-six positions in all, expressed by that number of lines radiating from a single centre, and making angles of  $10^\circ$  with each other. Now let us imagine thirty-six operators whose function it is to turn a line, no matter what, successively through an arc of  $10^\circ$ ,  $20^\circ$ ,  $30^\circ$ , &c. up to  $360^\circ$ , the last being equivalent to an operator which simply does nothing. These thirty-six operators will form a group which we know to be strictly homologous with multiplication by the thirty-six expressions

$$e^{i\phi}, e^{2i\phi}, e^{3i\phi}, \dots, e^{36i\phi} = e^0 = 1,$$

where  $\phi$  is the arc of  $10^\circ$  in circular measure.

So far we have only considered operations formed by the continual repetition of a single one; in the language of the subject, all our groups are constructed from powers of a single operator. Now let us extend our process by substituting a cube for our straight line. Through this cube we have an axis parallel to four of its plane sides. By rotating the cube through any multiples of  $90^\circ$  around this axis we effect an interchange of position between four of its sides. This process of interchanging is homologous with rotation through  $90^\circ$ , being in fact equivalent to it, and therefore it is also homologous with multiplication by the imaginary unit. But there is also another homology. Let us designate the four sides of the cube parallel to the axis of rotation as  $A, B, C, D$ . Then our group of rotations will be homologous with the powers of a cyclic substitution between the four letters  $A, B, C, D$ .

Let us next introduce a new operator, namely, rotation around an axis at right angles to the first one, but always

through an arc of  $90^\circ$ . This introduces a new element into the problem, and enables us to change the cube from any one position to any other position, that is, to effect any interchange among the sides which would be consistent with their remaining sides of the same cube. Here we have a series of rotations which, in the case of the cube, are homologous with certain linear transformations which have been developed by Klein in his very beautiful book on the Icosahedron.

But it is also obvious that in introducing these rotations we are practically operating with quaternions, the operator being a unit vector. Thus we have a homology between certain forms of quaternion multiplication and linear transformations involving the imaginary unit. Moreover, since these rotations are also homologous with substitutions, performed on six symbols representing the six sides of the cube, it follows that there is also a homology between certain groups of substitutions and certain linear transformations involving two quantities, a numerator and a denominator, and quaternion multiplication by unit vectors.

I have taken a cube as the simplest illustration. Evidently we can construct a great number of groups of substitutions of the same sort between the sides of any regular solid, as Klein has done in the work I have already cited. The relation between the linear substitutions thus found and the solution of corresponding algebraic equations forms one of the most beautiful branches of our modern mathematics.

We have in all these cases a very simple illustration of a law of thought, the application of which forms the basis of an important part of modern mathematical research. We may call it the law of homology. I am not sure of my ability to define it rigorously, but I think we may express it in some such form as this: If we have two sets of concepts, say A and B, such that to every concept of the one set shall correspond a concept of the other, and to every relation between any two of one set a corresponding relation between the corresponding two of the other, then all language, reasoning, and conclusions as to the one set may be applied to the other set. We may, of course, extend the law to a correspondence between things or concepts, and symbols, or other forms of language.

This law is, I think, more universal than might at first sight appear. Not only the progress, but the very existence of our race depends upon that coordination between our mental processes and the processes of the external universe, which has gradually been brought about by the attrition between man and nature through unnumbered generations. A man is perfect, powerful, and effective in proportion as his thoughts of nature coincide with the processes of nature herself; each process of nature having its image in his thought, and *vice versa*. Now, language consists in coordination between words and conceptions. Thus we pass from nature to what corresponds to it in thought, and from thought to what corresponds to it in language, and thus bring about a correspondence between language and nature.

Modern scientific research affords many examples of the application of this law, which would be very marvellous if they were not so familiar. We are so accustomed to the prediction of an eclipse that we see no philosophy in it. And yet might not a very intellectual being from another sphere see something wonderful in the fact that by a process of making symbols with pen and ink upon sheets of paper, and combining them according to certain simple rules, it is possible to predict with unerring certainty that the shadow of the moon, on a given day and at a given hour and minute, will pass over a certain place on the earth's surface? Surely the being might ask with surprise how such a result could be attained. Our reply would be simply this: There is a one-to-one correspondence between the symbols which the mathematician makes on his paper, and the laws of motion of the heavenly bodies. His symbols embody the methods of nature itself.

The introduction and application of homologies such as I have pointed out have, perhaps, their greatest value as thought-savers. In the field of mathematical thought they bear some resemblance to labour-saving machines in the field of economics. They enable the results of ratiocination to be reached without going through the process of reasoning in the particular case. Much that I have said illustrates this use of the method, but there is yet another case which has been so fruitful as to be worthy of special mention: I mean the general theory of functions of an imaginary variable. We may regard such functions as being in reality representative of a pair of functions

of a certain class involving a pair of real variables; but the difficulty of conceiving the various ways in which the two variables might be related, and the results of the changes which they might go through, in such a way as to clearly follow out all possible results, would have rendered their direct study impossible.

But when Gauss and Cauchy conceived the happy idea of representing two such variables, the real and the imaginary one, by the rectangular coordinates of a point in a plane, those relations which before taxed the powers of conception became comparatively simple. Considered as a magnitude, the complex variable, or the sum of a real quantity and a purely imaginary one, the latter being considered as one measured in imaginary units, was represented by the length and position of a straight line drawn from an origin of coordinates to the point whose coordinates were represented by the values of the variable. Such a line, when both length and direction are considered, is now familiarly known as a vector. The conception of the vector would, however, in many cases be laborious. But the vector is completely determined by its terminal point; to every vector corresponds one and only one terminal point, and to every terminal point one and only one vector. Hence we may make abstraction of the vector entirely, and in thought attend only to the terminal point. Since for every pair of values we assign to our original variables there is one point, and only one, we may in thought make abstraction of both of these variables, and of the vectors which they represent, and consider only the point whose coordinates they are. Thus the continuous variation of the two quantities, how complex soever it may be, is represented by a motion of the point. Now such a motion is very easy to conceive. We may consider it as performing a number of revolutions around some fixed position without the slightest difficulty, whereas to conceive the corresponding variations in the algebraic variables themselves would need considerable mental effort. Thus, and thus alone, has the beautiful theory, first largely developed by Cauchy, and afterward continued by Riemann, been brought to its present state of perfection.

Another example of the principle in question, where the two objections of reasoning are so nearly of a kind that no thought is saved, is afforded by the principle of duality in projective geometry. Here a one-to-one correspondence is established between the mutual relations of points and lines, with the result that in demonstrating any proposition relating to these concepts we at the same time demonstrate a correlative proposition formed from the original one by simply interchanging the words "point" and "line."

The subjects of which I have heretofore spoken belong conjointly to algebra and geometry. Indeed, one of the great results of bringing homologous interpretation into modern mathematics has been to unify the treatment of algebra and geometry, and almost fuse them into a single science. To a large class of theorems of algebra belong corresponding theorems of geometry, each of one class proving one of the other class. Thus the two sciences become mutually helpful. In geometry we have a visible representation of algebraic theorems; by algebraic operations we reach geometrical conclusions which it might be much more difficult to reach by direct reasoning. A remarkable example is afforded by the geometrical application of the theory of invariants. These are perhaps the last kind of algebraic conclusion which the student, when they are first presented to his attention, would conceive to have a geometrical application, yet a very little study suffices to establish a complete homology between them and the distribution of points upon a straight line.

This use of homologies does not mark the only line by which we have advanced beyond our predecessors. Progress has been possible only by emancipating ourselves from certain of the conceptions of ancient geometry which are still uppermost in all our elementary teaching. The illustration I have already given is here much to the point. The expression of a relation between two straight lines by the multiplier which would change one into the other is now familiar to every schoolboy, and the relation itself was familiar to Euclid. But the yet simpler relation of a line to another of equal length standing at right angles to it, and the corresponding operator which will change one into the other, was never thought of by Euclid, and is unfamiliar in our schools. Why is this? It seems to me that it grows out of the ancestral idea that mathematics concerns itself with measurement and that the object of measurement is to express all magnitudes in one-dimensional measure. So completely has

this idea directed language, that we still extend the use of the word "equal" to all cases of this particular kind of linear equality: we say that a circle is equal to the rectangle contained by its radius and half its circumference. We have therefore been obliged to invent the word "congruent" for absolute equality in all points, or to qualify the adjective "equal" by "identical," saying "identically equal." There is of course no objection to the comparison of magnitudes in this way by reference to one dimensional measures, or by presupposing that the change which one magnitude must undergo in order to be transformed into the other is to be expressed by a single parameter, but changes involving two or any number of parameters, are just as important as those involving one, and the attempt to express all metric relations by referring them to a single parameter has placed such restrictions on thought that it seems to me appropriate to apply the term emancipation to our act in freeing ourselves from them. With us mathematics is no longer the science of quantity. But even if we consider that the ultimate object of mathematics is relations between quantities, we have reaped a rich reward by the emancipation, for we are enabled by the use of our broader ideas to reach new conclusions as to metric relations.

The idea of groups of operations, as I have tried to develop it, has in recent years been so extended as to cover a large part of the fields of algebra and geometry. Among the leaders in this extension has been Sophus Lie. Considered from the algebraic point of view, his idea in its simplest form may be expressed thus: We have a certain quantity, say  $x$ . We have also an operation of any sort which we may perform upon this quantity. Let this operation depend on a certain quantity,  $a$ , which necessarily enters into it. As one of the simplest possible examples, we may consider the operation to be that of adding  $a$  to  $x$ . As the quantity  $a$  may take an infinity of values, it follows that there will be an infinity of operations all belonging to one class, which operations will be distinguished by the particular value of  $a$  in each case. We thus operate on  $x$  with one of these operators, and get a certain result, say  $x'$ . We operate on  $x'$  with a second operator, of the same class, and get a second result, say  $x''$ . If whatever operators we choose from the class, the result  $x''$  could have been obtained from the original quantity  $x$  by some operation of the class, then these operations are such that the product of any two is equivalent to the performance of some one of them. Thus, by repeating them for ever, we could get no results except such as could be obtained by some one operator. To illustrate by one simple example: if our operation consists in the addition of an arbitrary quantity to  $x$ , then we change  $x$  into  $x'$  by adding a certain quantity  $a$  and  $x'$  into  $x''$  by adding a second quantity  $b$ . The result of these two additions is the same as if we had added in the first place the quantity  $a + b$ . It need hardly be said that the multiplication by  $x$  of any quantity would be another example of the same kind. The performance of any number of successive multiplications on a quantity is always equal to a single multiplication by the product of all the factors of the separate multiplications.

These operations are not confined to single quantities. We may consider the operation to be performed upon a system of quantities, which are thus transformed into an equal number of different quantities, each of these new quantities corresponding to one of the first system. If a repetition of the operation upon the second system of quantities gives rise to a third system, which could have been formed from the first system by an operation of the same class, then all these possible operations form a group.

The idea of such systems of operations is by no means new. It has always been obvious, since the general theory of algebraic operations has been studied, that any combination of the operations of addition, multiplication, and division could always be reduced to a system in which there would be only a single operation of division necessary—just as in arithmetic a complex fraction, no matter what the order of complexity of its terms, can always be reduced to a single simple fraction, that is, to a ratio of two integers, but cannot, in general, be reduced to an integer. Abel made use of this theorem in his celebrated Memoir on the impossibility of solving the general equation of the fifth degree.

Another field of mathematical thought, quite distinct from that at which we have just glanced, may be called the fairyland of geometry. To make a mathematician, we must have a higher development of his special power than falls to the lot of other men. When he enters fairyland he must, to do

himself justice, take wings which will carry him far above the flights, and even above the sight, of ordinary mortals. To the most imaginative of the latter, a being enclosed in a sphere, the surface of which was absolutely impenetrable, would be so securely imprisoned that not even a spirit could escape except by being so ethereal that it could pass through the substance of the sphere. But the mathematical spirit, in four-dimensional space, could step out without even touching any part of the globe. Taking his stand at a short distance from the earth, he could with his telescope scan every particle of it, from centre to surface, without any necessity that the light should pass through any part of the substance of the earth. If a practised gymnast, he could turn a somersault and come down right side left, just as he looks to our eyes when seen by reflection in a mirror, and that without suffering any distortion or injury whatever. A straight line, or a line which to all our examination would appear straight, if followed far enough, might return into itself. Space itself may have a boundary, or, rather, there may be only a certain quantity of it; go on for ever, and we would find ourselves always coming back to the starting-point. All these results, too, are reached not merely by facetious forms, but by rigorous geometrical demonstration.

The considerations which lead to the study of these forms of space are so simple that they can be traced without difficulty. When the youth begins the study of plane geometry his attention is devoted entirely to figures lying in a plane. For him space has only two dimensions. To a given point on a straight line only one perpendicular can be drawn. By moving a line of any sort in the plane he can describe a surface, but a solid is wholly without his field. He cannot draw a line from the outside to the inside of a circle without intersecting it. On a given base only two triangles with given sides can be erected, one being on one side of the base, the other on the other. When he reaches solid geometry his conceptions are greatly extended. He can draw any number of perpendiculars to the same point of a straight line. If he has two straight lines perpendicular to each other, he can draw a third straight line which shall be perpendicular to both. A plane surface is not confined to its own plane, but can be moved up and down in such a way as to describe a solid. The characteristic of this motion is that it constantly carries every part of the plane to a position which no part occupied before.

Now, it is a fundamental principle of pure science that the liberty of making hypotheses is unlimited. It is not necessary that we shall prove the hypothesis to be a reality before we are allowed to make it. It is legitimate to anticipate all the possibilities. It is, therefore, a perfectly legitimate exercise of thought to imagine what would result if we should not stop at three dimensions in geometry, but construct one for space having four. As the boy, at a certain stage in his studies, passes from two to three dimensions, so may the mathematician pass from three to four dimensions with equal facility. He does indeed meet with the obstacle that he cannot draw figures in four dimensions, and his faculties are so limited that he cannot construct in his own mind an image of things as they would look in space of four dimensions. But this need not prevent his reasoning on the subject, and one of the most obvious conclusions he would reach is this: As in space of two dimensions one line can be drawn perpendicular to another at a given point, and by adding another dimension to space a third line can be drawn perpendicular to these two; so in a fourth dimension we can draw a line which shall be perpendicular to all three. True, we cannot imagine how the line would look, or where it would be placed, but this is merely because of the limitations of our faculties. As a surface describes a solid by continually leaving the space in which it lies at the moment, so a four-dimensional solid will be generated by a three-dimensional one by a continuous motion which shall constantly be directed outside of this three-dimensional space in which our universe appears to exist. As the man confined in a circle can evade it by stepping over it, so the mathematician, if placed inside a sphere in four-dimensional space, would simply step over it as easily as we should over a circle drawn on the floor. Add a fourth dimension to space, and there is room for an indefinite number of universes, all alongside of each other, as there is for an indefinite number of sheets of paper when we pile them upon each other.

From this point of view of physical science, the question whether the actuality of a fourth dimension can be considered admissible is a very interesting one. All we can say is that,

so far as observation goes, all legitimate conclusions seem to be against it. No induction of physical science is more universal or complete than that three conditions fix the position of a point. The phenomena of light shows that no vibrations go outside of three-dimensional space, even in the luminiferous ether. If there is another universe, or a great number of other universes, outside of our own, we can only say that we have no evidence of their exerting any action upon our own. True, those who are fond of explaining anomalous occurrences, by the action of beings that we otherwise know nothing about, have here a very easy field for their imagination. The question of the sufficiency of the laws of nature to account for all phenomena is, however, too wide a one to be discussed at present.

As illustrating the limitation of our faculties in this direction, it is remarkable that we are unable to conceive of a space of two dimensions otherwise than as contained in one of three. A mere plane, with nothing on each side of it, is to us inconceivable. We are thus compelled, so far as our conceptions go, to accept three dimensions and no more. We have in this a legitimate result of the universal experience through all generations being that of a triply extended space.

Intimately associated with this is the concept of what is sometimes called curved space. I confess that I do not like this expression, as I do not see how space itself can be regarded as curved. Geometry is not the science of space, but the science of figures in space, possessing the properties of extension and mobility which we find to be common to all material bodies. The question raised here is a very old one, and in a general way its history is familiar.

Mathematicians have often attempted to construct geometry without the use of what is commonly called the ninth axiom of Euclid, which seems to me best expressed by saying that in a plane only one line can be drawn which shall be parallel to another line in the plane in the sense of never meeting it in either direction. Yet every attempt to construct an elementary geometry without this axiom has been proved to involve a fallacy in some point of the reasoning. This consideration led Lobachewsky, and independently of him, I believe, Gauss, to inquire whether a geometry might not be constructed in which this axiom did not hold; in which, in fact, it was possible that if we had two parallel lines in a plane, one of them might turn through a very minute angle without thereby meeting the other line in either direction. The possibility of this was soon shown, and a system of geometry was thus constructed in which the sum of the angles of a plane triangle might be less than two right angles.

Afterward the opposite hypothesis was also introduced. It was found that, given two parallel lines in a plane, it might be supposed that they would ultimately meet in both directions. This hypothesis might even be made without there being more than one point of intersection, each straight line returning into itself. The geometry arising from these two hypotheses has been reduced to a rigorous system by Klein.

To guess the future of mathematical science would be a rash attempt. If made it might seem that, in view of what has been accomplished during our time, the safest course would be to predict great discoveries in this and all other branches of science. The question is sometimes asked whether a mathematical method may not yet be invented which shall be as great an advance on the infinitesimal calculus as the latter was on the methods of Euclid and Diophantus. So far as solving problems which now confront us is concerned, I am not sure that the safest course would not be to answer such questions in the negative. Is it not true in physics as in mathematics that great discoveries have been made on unexpected lines, and that the problems which perplexed our ancestors now baffle our own efforts? We must also remember that the discovery of what could not be done has been an important element in progress. We are met at every step by the iron law of the conservation of energy; in every direction we see the limits of the possible. The mathematics of the twenty-first century may be very different from our own; perhaps the schoolboy will begin algebra with the theory of substitution-groups, as he might now but for inherited habits. But we may well doubt whether our posterity will solve many problems which we cannot, or invent an algorithm more powerful than the calculus. The first principles of all our mathematical methods are as old as Euclid, and we cannot expect that the future will do more than apply them to new problems.

## UNIVERSITY AND EDUCATIONAL INTELLIGENCE.

OXFORD.—At a meeting of the Junior Scientific Club, held on Friday, January 26, Mr. Pycraft exhibited a restoration of the wing of archæopteryx: Mr. F. A. Hillard read a paper on carborundum, and other substances, prepared by means of the electric arc: and Mr. H. M. Vernon read a paper on the activity of the cardiac centre under varying conditions. It was agreed at the meeting that the annual Boyle lecture, which will be given this year by Prof. Macalister, should be held early in May, and that a conversazione should be given on another day in the summer term.

CAMBRIDGE.—Mr. J. W. Capstick, Fellow of Trinity, has been appointed an Assistant Demonstrator in Physics at the Cavendish Laboratory, in the room of Mr. Whetham, who has been elected to the Clerk Maxwell Scholarship.

A course of lectures with demonstrations in elementary physiology for students of agriculture will be given this term by Mr. Eichholz, Fellow of Emmanuel College, on Mondays and Saturdays, at nine.

Baron Anatole von Hügel, Curator of the Museum of Archæology and Ethnology, will this term give two courses of lectures on the collections in the Museum.

A syndicate, consisting of the Vice-Chancellor, the Master of Peterhouse, the Master of Christ's, Prof. Thomson, F.R.S., Prof. Liveing, F.R.S., Mr. Glazebrook, F.R.S., and Mr. Shaw, F.R.S., is about to be appointed to consider the best means of extending the Cavendish Laboratory. A site for the extension is reserved, but the standing difficulty of funds is likely to prove a serious one unless outside help can be obtained.

Dr. P. W. Latham has resigned the Downing Professorship of Medicine, which he has held since 1874. The appointment is made by a special board of electors. Mr. J. R. Green, of Trinity College, Professor of Botany to the Royal Pharmaceutical Society of Great Britain, has been approved by the General Board of Studies for the degree of Doctor of Science.

It is proposed to admit to the privileges of affiliated students, matriculated members of the University of Adelaide who have studied there for two years in arts, law, science, or medicine, and have passed certain specified examinations. Such affiliated students are exempted from the Previous Examination and from one year of residence for the B.A. degree.

## SCIENTIFIC SERIALS.

*American Meteorological Journal*, January.—History of the Weather Map, by M. W. Harrington. Simultaneous observations, which form the basis of weather charts, were made in Virginia from 1772 to 1777; about the same time Lavoisier proposed that such observations should be made in Europe, and referred to an earlier proposal by Borda. In 1842, Kreil, of Prague, proposed the use of an electromagnetic telegraph for the same purpose. The earliest proposal for a weather map was probably made by Brandes, in 1816, but his plan seems never to have been carried out, and it was not until 1856 that current charts of the weather were made by the Smithsonian Institution. In 1857, Le Verrier published an international bulletin, but his synoptic charts were not issued until 1863; and in this country Admiral FitzRoy commenced the publication of telegraphic weather reports in 1860; since this time such reports and charts became general.—The meteorological work of the Medical Department of the United States Army, by Major C. Smart. The earliest meteorological journal in the office of the Surgeon-General is from Cambridge, for July, 1816. The first results were published in the *Meteorological Register* for the years 1822-5.—The meteorological work of the Smithsonian Institution, by S. P. Langley. In December, 1847, Prof. J. Henry proposed a "system of extended meteorological observations for solving the problem of American storms;" and shortly afterwards the institution issued directions for meteorological observations; in 1849 elementary telegraphic weather reports were furnished to the institution daily.—Early individual observers in the United States, by A. J. Henry. A daily record of the weather was kept by the Rev. J. Campanius at Fort Christiania, near the present city of Wilmington, Delaware, during 1644-5, and at Boston, by the Hon. P. Dudley, in

1729-30. The instrumental period began with Dr. J. Lining's observations at Charleston, in 1738. The above, and articles on the storms of the Atlantic, and the creation of meteorological observatories upon islands, are abstracts of papers prepared for the Chicago Congress of Meteorology.—The recurrence of hurricanes in the solar magnetic 26.68 day period, by F. H. Bigelow. The author compares the curves of hurricane recurrences with those of the solar magnetic period. An inspection of the curves shows that they have closely synchronous maxima and minima. Mr. Bigelow concludes that the intensifications of the polar magnetic field have much to do with the generation of West Indian tropical storms, but he admits that many points of the subject are as yet only partially understood.

*Bulletins de la Société d'Anthropologie de Paris*, Tome iv. (4e Serie), December 15, 1893.—M. Ch. Letourneau describes a stone cross, found at Carnac, with inscriptions. The two arms of this cross are *patée*, like those of a Maltese cross, and the four faces of the quadrangular shaft are covered with inscriptions which resemble in their general character those megalithic inscriptions which are so numerous in the neighbourhood of Locmariaker. As these inscriptions must have been cut subsequently to the fashioning of the cross, we have a very different case to that in which a cross is found carved on a menhir. This cross, with two others of a similar character, are figured by Miln as tail-pieces in his work "Fouilles de Carnac" (Paris, 1877), and he considers them to mark the transition period between Paganism and Christianity. There can be no doubt, however, that the men who chiseled the great menhir of Locmariaker and carved the inscriptions of Gavr Inis were capable of cutting a cross out of stone if they were disposed to do so; afterwards these crosses might have been preserved by the Christians, and even, perhaps, restored by them.—Dr. Paul Raymond contributes a paper on the prehistoric period in the departments of Gard and Ardèche; and M. Désiré Charnay describes the remains of the cliff-dwellers exhibited at the World's Fair at Chicago.—The colour of the eyes has long been looked upon as one of the most important race signs, and Dr. Harreaux proposes a systematic method of describing the iris, which, so far as one can judge without the assistance of plates, will enable qualified observers to record and recognise very minute differences; the system, however, appears to be somewhat too complicated for general use and is surpassed in precision by the iridographic method of Bertillon.—Dr. Ledouble contributes a valuable paper on the anomalies of the great dorsal muscle.—M. A. Pokrovsky describes four crania found by Prof. Obolonsky in the grotto of Sundurli-Koba, near the village of Ouzoundja, in the Crimea. Three out of the four are considerably plagiocephalic, the plagiocephaly being left in two cases and right in the third; two of the crania are male, one is female, and the fourth is that of a child of about twelve years of age.—M. Adrien de Mortillet gives an account of the figures cut on the megalithic monuments near Paris; these are three in number, one in the valley of the Seine, at Aubergenville; and the two others in the valley of the Epte, at Dampsmesnil and at Boury. The dolmen at Aubergenville is known as the Trou-aux-Anglais, that at Dampsmesnil is called by the country people the Trou-aux-Loups, while the third is the Dolmen de la Bellehay.

*Bulletin of the New York Mathematical Society*, vol. iii. No. 3, December, 1893 (New York).—A doubly-infinite system of simple groups (pp. 73-78) is an abstract of a paper presented to the Congress of Mathematics at Chicago, by Prof. E. H. Moore. The paper is to be published in full in the Proceedings, and also in the *Mathematische Annalen*. Two notes follow, on monogenic functions of a single variable (pp. 78, 79), by Dr. Craig, and Lambert's non-Euclidean geometry (pp. 79, 80), by Prof. Halsted. This latter is very interesting, as it narrates the discovery of an old paper of Lambert's (*Zur Theorie der Parallellinien*, 1766) on what was long after named the non-Euclidean geometry. Pages 80-88 are taken up with remarks on the teaching of mathematics at Göttingen. There are the usual "notes" and "new publications" (pp. 88-94).

The number of the *Journal of Botany* for December, 1893, contains further Notes on the genus *Potamogeton*, by Mr. A. Fryer, with illustrations; Descriptions of three new African grasses, by Mr. A. B. Rendle; the completion of Mr. E. G. Baker's Synopsis of genera and species of *Malvæ*; and Mr.

Carruthers' Report of the Department of Botany in the British Museum for 1892.—The most important papers in the No. for January, 1894, are one on the Primary subdivisions in the genus *Silene*, by Mr. F. N. Williams; and the late Prof. Asa Gray's Last words on nomenclature.

## SOCIETIES AND ACADEMIES.

LONDON.

Entomological Society, January 17.—Sixty-first Annual Meeting.—Mr. Frederic Merrifield, Vice-President, in the chair.—An abstract of the treasurer's accounts, showing a balance in the Society's favour, having been read by Mr. J. Jenner Weir, one of the auditors, the secretary, Mr. H. Goss, read the report of the council. It was then announced that the following gentlemen had been elected as officers and council for 1894:—President, Mr. Henry J. Elwes; treasurer, Mr. Robert McLachlan, F.R.S.; secretaries, Mr. Herbert Goss and the Rev. Canon Fowler; librarian, Mr. George C. Champion; and as other members of the council, Mr. Walter F. H. Blandford, Mr. Charles J. Gahan, Mr. Frederic Merrifield, Prof. Edward B. Poulton, F.R.S., Colonel Charles Swinhoe, Mr. George H. Verrall, Mr. James J. Walker, R.N., and the Right Hon. Lord Walsingham, F.R.S. Mr. Merrifield then read the President's address, in which, after alluding to the principal events of the past year, and the prosperous condition of the Society, he referred to the additions which had been made in 1893 to the literature of entomology, calling attention to the "Butterflies of China and Japan," by Mr. J. H. Leech; the "Moths of India," by Mr. G. F. Hampson; "Butterflies of North America," by Mr. W. H. Edwards; "Lepidoptera Indica," by Dr. F. Moore; and the continuation of the "Biologia Centrali-Americana," by Messrs. F. D. Godman, F.R.S., and Osbert Salvin, F.R.S. He also commented on the recent publications of the Grand Duke Nicholas Mikhailovitch, M. Charles Oberthür, and Dr. Staudinger, on the continent. The President concluded by referring to the losses by death during the year of several Fellows of the Society and other entomologists, special mention being made of Prof. H. A. Hagen, the Rev. Leonard Blomefield, Mr. A. C. Horner, Prof. J. Wood-Mason, the Rev. Henry Burney, Mr. J. C. Bowring, the Rev. F. O. Morris, Mr. J. Batty, Mr. Francis P. Pascoc, Herr Eduard Honrath, and Dr. Adolph Speyer. A vote of thanks to the President was proposed by Colonel Swinhoe, seconded by Mr. Jenner Weir, and carried. Lord Walsingham proposed a vote of thanks to the officers of the Society; this was seconded by Mr. Waterhouse, and carried. Mr. Merrifield, Mr. McLachlan, and Mr. Goss replied, and the proceedings terminated.

Royal Microscopical Society, January 17.—Annual Meeting.—Mr. A. D. Michael, President, in the chair.—After the report of the council for the past year and the Treasurer's statement of accounts had been read and adopted, the President announced that the following were elected as officers and council for the ensuing year:—President: A. D. Michael; Vice-Presidents: Prof. L. S. Beale, F.R.S., Dr. R. Braithwaite, Frank Crisp, T. H. Powell; Treasurer: W. T. Suffolk; Secretaries: Prof. F. Jeffrey Bell, Rev. Dr. W. H. Dallinger, F.R.S.; Ordinary Members of Council: A. W. Bennett, Rev. E. Carr, E. Dadswell, C. H. Gill, Dr. R. G. Hebb, G. C. Karop, E. M. Nelson, Prof. Urban Pritchard, C. F. Rousselet, Prof. Charles Stewart, J. J. Vezey, and T. C. White.—The President then delivered the annual address. He took for his subject the growth and present state of our knowledge of the Acari. The name "Acarus" was probably first used by Aristotle; it means uncuttable. But Aristotle did not anticipate Cambridge rocking microtomes, and the President exhibited a set of over 120 serial sections cut from a far smaller Acarus than Aristotle could ever have seen. The President then described what an Acarus really is and in what respects it differs from other Arachnida, a distinction which is erroneously stated in almost all text-books of zoology. The classification of the group practically began with Linnæus; it was shown how difficult it is to identify a Linnean species, and the progress of classification was shortly traced from the single Linnean genus to the two hundred and twelve genera admitted by Trouessart, one of the latest writers on the subject. The President then referred to the fact that many of the predatory Acari had not

any special organs of vision, and yet that they were most active creatures, and would catch such agile insects as Thysanuridae without constructing any web or trap, and did not seem to suffer in the least from their eyeless condition; he had seen small and weak Acari quietly waiting until larger ones had finished feeding before they ventured to attack the leavings, although both were blind. The various forms of acarine parasitism and commensalism were then described, including one where a parasite lives in the fur of the rabbit, not feeding on the host, but on other parasites which really do so, and the number of these which it will destroy is amazing. The President then illustrated the principal families of Acari by selecting one or two instances of each, which were specially interesting either from their habits, their anatomy, or otherwise. The Sarcopoda, or bird parasites, were represented by a parasite of the cormorant, discovered by the President, in which the male has one leg much larger than the other, and the skeleton of the body is greatly modified to support it; but the enlarged leg and modified skeleton are on the right side of the body in some specimens, and on the left in others. The so-called cheese-mites were referred to in order to describe the hypopus-stage in the life-history of many of them; when the creature, which is originally soft and easily killed by heat or exposure, suddenly becomes hard and able to endure almost all vicissitudes, and also to live for a long period without eating; it is then provided with special organs for adhering to insects, and thus the species are widely distributed under circumstances where they would otherwise perish. The President then spoke of his recent researches into the association between many Acari (Gamasids) and certain ants in whose nests they live, and of a still stranger and hitherto unrecorded case, even more lately observed by him, in which a species of *Acarus* (*Edella*) lives habitually in a spider's web in harmony with the otherwise most ferocious occupant. The speaker then shortly described his recent discovery of the extraordinary way in which female Gamasids are fertilised, a spermatid capsule being conveyed to its destination by the mandibles of the male. Finally, the descent of the Acari was discussed. The discourse was illustrated by the lantern.

## EDINBURGH.

Royal Society, December 12, 1893.—The Rev. Prof. Duns in the chair.—Dr. George Berry read a note on the focus of concavo-convex lenses, the surfaces of which are of equal curvature. The effect of the thickness of the lens was specially considered.—Dr. W. Peddie read a paper on torsional oscillations of wires. The law of decay of oscillations when the set is large was investigated experimentally, and a very accurate empirical formula was given for the representation of the results. A theory of the phenomenon was then investigated, and was shown to lead to the empirical formula as an approximation when the loss of energy per oscillation was not too large a fraction of the total energy of oscillation. The theory was also shown to lead to a relation between torsion and set, which, on application to Wiedemann's results, was found to be in practically complete accordance with experiment. It was shown also to lead necessarily to Kelvin's well-known "law of compound-interest" for the decay of oscillations when these are very small.—Dr. C. G. Knott communicated a paper, by Mr. S. Kimura, on certain electrical properties of iron occluding gases. The gases used were carbonic acid, carbonic oxide, and hydrogen. The paper dealt with the changes of thermo-electric power and of resistance.—Dr. Knott also read a paper, by Mr S. Tolver Preston, on the ether—an idea of Sir John Herschel modernised.

January 15.—Prof. Sir Douglas Maclagan, President, in the chair.—After the reading of two obituary notices, Prof. Crum Brown communicated a paper by Prof. Alexander Smith, Wash College, Indiana, U.S.A., on two stereo-isomeric hydrazones of benzoin.—Dr. Knott communicated a paper, by Prof. Tait, on the compression of fluids. In this paper Amagat's recently published results are applied to test the truth of the empirical formula

$$\frac{v_0 - v}{v_0 p} = \frac{e}{\pi + p},$$

where  $\pi$  is the internal pressure and  $v_0(1 - e)$  is the ultimate volume under infinite pressure. Tests are made, at pressures of 1, 1501, and 3001 atmospheres, for the substances ether, ethylic alcohol, methylic alcohol, propylic alcohol, carbon bisulphide, iodide of ethyl, chloride of phosphorus, acetone, and water.

The quantity  $e$  is found to be nearly the same for all these substances, and indicates an ultimate reduction of volume of about 30 per cent. It increases as a rule with rise of temperature. In the case of water,  $\pi$  increases steadily with rise of temperature up to about 40° C. In all other substances  $\pi$  decreases steadily with rise of temperature. These facts correspond to the known changes of compressibility with temperature. An attempt is then made to see how far it may be possible to extend the formula to substances such as carbonic acid at ordinary temperatures, considerable pressure being required to keep the substance in the liquid state. Consistent values of  $e$  and  $\pi$  are obtained at temperatures and pressures both above and below the critical point. It is found that  $\pi$  is positive, at volumes a little above the critical volume, over a considerable range of temperature. Hence the Laplace effect predominates over the kinetic repulsion. In the other regions for which tests were made,  $\pi$  is negative. It vanishes, at a temperature a little over 50° C., throughout the observed range of volumes. This vanishing of  $\pi$  corresponds to the case of the ideally perfect gas.

## PARIS.

Academy of Sciences, January 22.—M. Lœwy in the chair.—Integration of the equation for sound in an indefinite fluid in one, two, or three dimensions, when resistances of various types introduce into this equation terms proportional respectively to the characteristic function of the movement or to its first derived partials, by M. J. Bousinesq. A solution of a problem in the propagation of sound-waves suggested by M. Poincaré in a recent communication.—On the calculation of coefficients of self-induction in a particular case, by M. A. Potier.—Experiments on the histological mechanism of the secretion of granular glands, by M. L. Ranvier. An account of methods employed in observing the cell-activities of the sub-maxillary gland of the rat.—A study of the fauna of the Gulf of Lyons, by M. H. de Lacaze-Duthiers.—Report on the meteorological observatory established by M. Vallot, near the summit of Mont Blanc, and on the first volume of the annals of the work of this observatory, by the commissioners, MM. Mascart and Bouquet de la Grye.—On the solar phenomena observed at the observatory of the Roman College, during the first two quarters of the year 1893. A letter by M. P. Tacchini, giving details concerning protuberances, faculae, spots, and eruptions observed. All the phenomena were more frequent in the southern zones, the maximum numbers also were found in these zones. In the first quarter, eruptions were not observed. The maxima of faculae and spots were found in the same zones ( $\pm 10^\circ$ ,  $\pm 20^\circ$ ), of protuberances in higher latitudes.—Note on equations and implicit functions, by M. A. Pellet.—On new experimental studies concerning the form, pressures, and temperatures of a jet of vapour, by M. H. Parenty. Diagrams are given showing the distribution of pressures in jets with apertures of different types.—Contribution to the study of the properties of the arc with alternating current, by M. G. Claude.—On the minimum electromotive force necessary for the electrolysis of dissolved alkaline salts, by M. C. Nourisson. From thermochemical data the E.M.F. necessary is for chlorides 2.02 volts, bromides 1.75, iodides 1.16, sulphates 2.15, nitrates 2.07, and chlorates 2.07 volts. The experimental results for the halogen salts of the alkalis and alkaline earths agree with these numbers, but for the corresponding sulphates, nitrates, and chlorates somewhat higher values are obtained. The minimum E.M.F. necessary for the electrolysis of a dissolved alkaline salt is constant for oxy-salts and is constant for the haloid salts of the same acid.—On an application of sodium silicate, by M. G. Geisenheimer. The application referred to is that of being used to soften waters for laundry purposes.—On some phosphochromates, by M. Maurice Blondel. The formation and properties are described of bodies having the formulae  $3K_2O \cdot P_2O_5 \cdot 8CrO_3$  and  $2K_2O \cdot H_2O \cdot P_2O_5 \cdot 4CrO_3$ , or  $2K_3PO_4 \cdot 8CrO_3$  and  $2K_2HPO_4 \cdot 4CrO_3$ .—Action of sulphuric acid on wood charcoal, by M. A. Verneuil. Some of the secondary products have been isolated and identified, notably the penta- and hexa-carboxylic acids,  $C_6H(CO_2H)_5$  and  $C_6H(CO_2H)_6$ .—Condensation of isovaleraldehyde with acetone, by MM. Ph. Barbier and L. Bouveault.—Studies on the chemical properties of the alcoholic extract of yeast; formation of carbonic acid and absorption of oxygen, by M. J. de Rey-Pailhade.—On the sea bottom of the region of Banyuls and Cape Creux, by M. G. Pruvot.—A certain symptom of death, indicated by the ophthal-

motonometer. Laws of ocular tension. A note by M. W. Nicati.—Some observations on snake poisons, by M. S. Jourdain. Remarks supplementary to M.M. Bertrand and Phisalix's recent paper.—On the ichthyological fauna of the fresh waters of Borneo, by M. Léon Vaillant.—A method of assuring and promoting the germination of vines, by M. Gustave Chauveaud.—On the structure of the French Alps, by M. Marcel Bertrand.—On the laws of the contortions of the shell of the earth, by M. Zürcher.—The temperature of the upper atmosphere, by M. Gustave Hermite. The author shows from the results of two balloon ascents in 1893 that the decrease of temperature with the height is much more rapid than is indicated by temperatures recorded at mountain observatories.

SYDNEY.

Royal Society of New South Wales, September 6, 1893.—H. C. Russell, F.R.S., Vice-President, in the chair.—The following papers were read by Prof. Liversidge, F.R.S.: (a) On the origin of moss gold; (b) on the condition of gold in quartz and calcite veins; (c) on the origin of gold nuggets; (d) on the crystallisation of gold in hexagonal forms; (e) gold moiré-métallique. Results of observations of Comet VI. (Brooks), 1892, at Windsor, New South Wales, by John Tebbutt.—Treatment of manufactured iron and steel for constructional purposes, by W. F. How.

October 4.—Prof. T. P. Anderson Stuart, President, in the chair.—On rock paintings by the Aborigines in caves on Bulgar Creek, near Singleton, by R. H. Mathews.—Notes on artesian water in Australia, by Prof. T. W. E. David.

November 1.—Prof. T. P. Anderson Stuart, President, in the chair.—Artesian bores on Bundabunda Station in Queensland, by Hon. W. H. Suttor.—On the probability of extraordinarily high spring tides about the December solstice of 1893, by John Tebbutt.—(a) On meteorite No. 2 from Gilgoon Station; (b) On different pictorial methods of showing rainfall, by H. C. Russell, F.R.S.—On the occurrence of a new mineral "Willyamite" from Broken Hill, by E. F. Pittman.

December 6.—Prof. T. P. Anderson Stuart, President, in the chair.—On the occurrence of Triassic plant remains in a shale bed near Manly, by B. Dunstan.—The orbit of the double star  $\delta$  5014, by R. P. Sellors.—Occurrence of "Evanosite" in Tasmania, by H. G. Smith.—On the separation of gold, silver, and iodine from sea-water by Muntz metal sheathing, by Prof. Liversidge, F.R.S.—Notes on the Cremorne bore, by Prof. T. W. E. David and E. F. Pittman.—The progress and position of irrigation in New South Wales, by H. G. McKinney.

NETHERLANDS.

Entomological Society, January 21.—P. C. T. Snellen, President, in the chair.—The President exhibited several specimens of *Vanessa cardui* from different regions, showing that it is a very common species, being distributed over nearly the whole world; he also showed specimens of *Papilio epius* and *Papilio antimachus*, both from Java.—Dr. J. Th. Oudemans announced that he was preparing a revision of Snellen van Vollenhoven's list of indigenous Tenthredinæ; he also stated that on the pupæ of Lepidoptera the sex can be recognised, and showed a remarkable nest of *Vespa media*.—Mr. A. B. ants read an interesting paper on the caterpillar of *Notolenta ziczac*.—Mr. P. J. M. Schuyt proposed the preparing of lists for exchange of indigenous Lepidoptera.—Mr. J. de Vries exhibited a variety of *Xanthia gilvago*, Dr. F. W. O. Kallenbach, a specimen of the rare *Cidaria unifasciata*, and Dr. A. J. van Rossum, a peculiar variety of *Deilephila euphorbie*.—Mr. J. R. H. Neervoort van de Poll exhibited a rare variety of *Ornithoptera priamus*, and a very fine and rich collection of the coleopterous genus *Haplosomyx*.—Dr. Ed. Everts called attention to a third supplement of his enumeration of indigenous Coleoptera, and showed several species not yet found in the Netherlands, but collected in Belgium in the neighbourhood of the limits.—Dr. F. A. Jentink asked if any of the members present had observed cats hunting after butterflies, a fact which he had found mentioned in a British periodical, and which he could confirm with his own experience. Dr. H. J. Veth said he had noticed a similar behaviour of cats against Tineidæ in a house where the latter were very abundant.—Dr. A. F. A. Leesberg called attention to *Melov autumnalis*, of which several specimens were captured at Mount St. Pieter, near Maastricht, though this species is extremely rare elsewhere.—Mr. W. G. Huet showed a peculiar nest of *Vespa vulgaris* and a web of

spider, on which hung a long thread with a small stone at its end.—Finally, Mr. F. M. van der Wulp exhibited several indigenous and exotic species of Hippobosca, Olfersia, and Ornithomyia, and described the principal characters to distinguish these genera and their species.

BOOKS, PAMPHLETS, and SERIALS RECEIVED.

BOOKS.—Alembic Club Reprints, No. 5.—Extracts from Micrographia; R. Hooke (Edinburgh, Clay).—Einführung in das Studium der Bakteriologie; Dr. Carl Günther (Leipzig, Thieme).—London Matriculation Directory, No. xv, January 1894 (University Correspondence C.lege).—Congrès International d'Archéologie et d'Anthropologie Préhistoriques, 11<sup>ème</sup> Session, à Moscou, Tome 2 (Moscou).—Science and Christian Tradition; T. H. Huxley (Macmillan).—Ein Geologischer Querschnitt durch die Ost-Alpen; A. Rothpletz (Stuttgart, Schw. Izerhart).—Lectures on Mathematics; F. Klein, reported by A. Ziwet (Macmillan).—Botanical Wall Diagrams (various) (S.P.C.K.).—Quantitative Chemical Analysis, Clowes and Coleman, 2nd Edition (Churchill).

PAMPHLETS.—Questions and Answers on Meteorology; R. H. Scott (Williams and Strahan).—Sulla Distribuzione Tipografica dei Terremoti; M. Baratta (Roma).—Carnosaurus Marchesetti, &c.; Dr. A. Kornhuber (Wien).—Ueber Partanosaurus Zitteli Skuphos und Microleptosaurus Schlosser nov. gen., nov. spec.; Dr. T. G. Skuphos (Wien). Die Mittelliasische Cephalopoden-Fauna des Hinter-Schafberges in Oberösterreich; G. Geyer (Wien).

SERIALS.—The British Moss-Flora, Part xv.; Dr. R. Braithwaite (the Author, Clapham Road).—Journal of the Chemical Society, Supplementary Number, December (Gurney and Jackson).—Ditto, January (Gurney and Jackson).—Nuovo Giornale Botanico Italiano, vol. xxv, No. 4 (Firenze).—Bulletino della Società Botanica Italiana, 1893, Nos 8, 9, 10 (Firenze).—The Essex Review, January (Chelmsford, Oarrant).—Annalen des K. K. Naturhistorischen Hofmuseums, Band viii, Nos. 2, 3, 4 (Wien).—Studies from the Yale Psychological Laboratory, 1892-93 (New Haven).—Jahrbuch der K. K. Geologischen Reichsanstalt, xliii, Band, 2 Heft (Wien).—The Geographical Journal, February (Stanford).

CONTENTS.

PAGE

|                                                                                              |     |
|----------------------------------------------------------------------------------------------|-----|
| Chinese Central Asia. By W. F. Kirby . . . . .                                               | 309 |
| Huxley's Collected Essays. By Prof. E. Ray Lankester, F.R.S. . . . .                         | 310 |
| The Psychology of To-day . . . . .                                                           | 311 |
| Railway Works. By N. J. Lockyer . . . . .                                                    | 312 |
| Essentials of Chemical Physiology . . . . .                                                  | 313 |
| Our Book Shelf:—                                                                             |     |
| Bent: "The Sacred City of the Ethiopians" . . . . .                                          | 314 |
| Modigliani: "Fra i Batacchi indipendenti" . . . . .                                          | 314 |
| Badenoch: "Romance of the Insect World" . . . . .                                            | 314 |
| Letters to the Editor:—                                                                      |     |
| The Postal Transmission of Natural History Specimens.—Philip P. Calvert . . . . .            | 314 |
| The Origin of Lake Basins.—John Aitken, F.R.S.; R. S. Tarr . . . . .                         | 315 |
| Glacial Erosion in Alaska.—Prof. G. Frederick Wright . . . . .                               | 316 |
| On the Equilibrium of Vapour Pressure inside Foam.—Prof. G. F. Fitzgerald, F.R.S. . . . .    | 316 |
| A Liquid Commutator for Sinusoidal Currents.—Prof. J. A. Ewing, F.R.S. . . . .               | 317 |
| A Curiosity in Eggs.—E. Brown . . . . .                                                      | 317 |
| Richard Spruce, Ph.D., F.R.G.S. By A. R. W. . . . .                                          | 317 |
| Precious Stones. (With Diagrams.) . . . . .                                                  | 319 |
| Notes . . . . .                                                                              | 320 |
| Our Astronomical Column.—                                                                    |     |
| Jupiter's Satellites in 1664 . . . . .                                                       | 323 |
| The U.S. Naval Observatory . . . . .                                                         | 324 |
| The Satellite of Neptune . . . . .                                                           | 324 |
| Geographical Notes . . . . .                                                                 | 324 |
| The Large Fireball of January 25 . . . . .                                                   | 324 |
| On a Meteorite from Gilgoon Station. (Illustrated.) By H. C. Russell, C.M.G., F.R.S. . . . . | 325 |
| Modern Mathematical Thought. By Prof. Simon Newcomb, F.R.S. . . . .                          | 325 |
| University and Educational Intelligence . . . . .                                            | 229 |
| Scientific Serials . . . . .                                                                 | 329 |
| Societies and Academies . . . . .                                                            | 330 |
| Books, Pamphlets, and Serials Received . . . . .                                             | 332 |



THURSDAY, FEBRUARY 8, 1894.

## A CRITIC CRITICISED.

*Darwinianism: Workmen and Work.* By James Hutchison Stirling, F.R.C.S., and LL.D. Edin. (Edinburgh: J. and J. Clark, 1894.)

DR. STIRLING begins his preface thus: "Perhaps it may be thought that, on the whole, I might very well have spared myself this small venture"; and such of his readers as know anything of Darwin's theories and works will most cordially agree with him. It has been the present writer's business to read most of the anti-Darwinian literature that has appeared in this country, and though much of it has exhibited extreme ignorance of the whole subject and a total inability to understand the theories and the arguments discussed, in both these respects the present volume fully equals the worst of its predecessors, while in the effort to belittle Darwin's intellect and to depreciate the value of his life's work it surpasses them all.

Considerably more than one-third of the volume is occupied with the lives of the three generations of Darwins, and though the animus is carefully veiled, there is an unmistakable attempt to show that, while there is much to admire in the moral and social aspects of the whole family, yet intellectually they have been greatly overpraised. In the very first chapter a number of opinions are quoted adverse to Dr. Erasmus Darwin; and after a chapter devoted to the glorification of Dr. Thomas Brown, the metaphysician, a third chapter is given up to his "Observations on Dr. Darwin's Zoonomia" and the correspondence between them, and we are led to understand that the young critic had by far the best of the argument, and that Dr. Darwin lost his temper.

The seventh to the twelfth chapters are devoted to Charles Darwin; and at the very commencement we find a passage that gives the keynote to the whole book. After saying that, of course, Mr. Charles Darwin will go down to posterity as one of the first of naturalists—an observer only to be classed with the Linnæuses and the Cuviers—we have this curious statement: "Mr. Francis Darwin—and in the circumstances it is not to disparage him to say so—will not, in all probability, precisely do that; but, with perhaps a more vigorous or more comprehensive general intellect, he is otherwise, we make bold to say, just about as good a man as his father was, than whom, for genuine worth, it would not be easy to find a better." What does this imply, if not that Darwin, though a preeminently good man, was, intellectually, not remarkable? And the whole of the succeeding chapters show that this is its meaning. Darwin's observing powers are dwelt on, and how much he thinks of technical *names* (p. 72). Then we are told that he was considered by all his masters and by his father to be below the common standard of intellect (p. 75), and this is repeated at p. 77, and again at p. 117. To enforce this, his own depreciatory phrases—that he learnt almost nothing at school and college, that he could never follow abstract trains of thought, that mathematics were repugnant to him, and that he was compelled to conclude that "his brain was never formed for much thinking"—are fully set

forth. At the same time, Dr. Stirling reiterates, that though quite ordinary intellectually, he was "a very good young man," always trying to improve himself (p. 77); that at Cambridge he was "the steady well regulated young man" (p. 84); that he was "the good young man" who, for self-improvement, has interest in, and would have a try at, everything that gives marks. He actually "paid some attention to metaphysical subjects" (p. 105); and again—"he was the exemplarily good young man that sought self-improvement in all that was ticketed in society as right." (p. 119.)

While thus, with subtle ingenuity, "damning with faint praise" the man whose life-work he is striving to depreciate, Dr. Stirling impresses upon us what, in his opinion, is the intellectual faculty to which Darwin owes his reputation. It is, the love of observing movement! Thus—"The stir of a beetle in the dust was the first stir that arrested the interest of a Darwin: the convulsion of a continent was possibly the last." (p. 114.) "It was *stir* that alone claimed his attention, *stir* that alone woke his single natural life." (p. 113.) "Observation is an affair of the eyes—shallow, so far, and on the surface; but ideas and their expression no less, spring rather from the depth—the cerebral depth—of the ears." (p. 114.) Here, by the profound philosophy of a Stirling we are informed that because Darwin *was* an observer and was *not* a musician, therefore he was shallow and of few ideas! And for several pages this notion is harped upon—*stir*, movement, watching birds, observing facts, his very soul was "captivated, fascinated, mesmerised, by the enchantment of physical movement," the *Journal* shows that he was "only using his eyes there in every paragraph and almost every line"—and thus the general reader, for whom this book is clearly intended, will gain the idea that there is something trivial and weak in minute observation, and that this was what specially characterised Darwin.

Further matter for depreciation is found in Darwin's remarks on some of the eminent men with whom he associated. He thought Carlyle narrow, because he was utterly unable to appreciate science, and this evidently condemns Darwin in Dr. Stirling's opinion, who calls Mill "his shallow contemporary," and describes the group of eminent men who were more or less intimate with him in these terms:—"The truth is that a feebler general public has seldom existed than what was atmosphere to Carlyle"—of which Mill and the two Darwins, Tyndall, Huxley, and other eminent men were an important part. And when Darwin says of him—"I never met a man with a mind so ill-adapted for scientific research"—Dr. Stirling remarks, with crushing sarcasm, "Scientific research meant for Mr. Darwin only the observation of movement, as in beetles, say; and there was no such accomplishment in Carlyle." Darwin also knew Buckle, and read his books with great delight, though not accepting all his theoretical views; but even this limited admiration is too much for Dr. Stirling, who thereon pours out his wrath for seven pages on what he terms "the commonest, vulgarest, shallowest free-thinkingism."

Having thus prepared his readers by this fancy picture of the extremely limited range of Darwin's intellect, Dr. Stirling proceeds to deal with the "Origin of Species"

as illustrated by the "Life and Letters." And the first point he brings forward is that Darwin was a compiler—a "not very sceptical" compiler, an "easy" compiler—and this idea is enforced throughout the first chapter of this second part of the work. Again and again this is recurred to, as the following passages show:—

"With all his experiences in pigeons, poultry, and see's, Mr. Darwin supported his results mainly on a compilation. Had the public but known that!" (p. 190). "That all that—of the *Descent of Man*, say—should be supported, not on thirty years' actual observation, experiment, and insight—personally—of the greatest naturalist in existence, but only on little more than so many years' clippings and cuttings from articles in periodicals and other such, as—about 'Hearne the Hunter!'" (p. 212). "Now that is the pity of it! The success of the book depended on the belief of the public that it was the product of work at first hand, and not of compilation at second—work at first hand and of the greatest naturalist in existence. . . . A compilation is always a dressing of facts for a purpose; and such a state of the case is simply glaring in every turn of the '*Origin*.'" (p. 179.)

It is then clear that Dr. Stirling wishes to impress upon the public that Darwin's chief work was mainly a compilation, badly put together—for he tells us it is "dull" and "as heavy as lead"—put together to support a foregone conclusion, without caution or judgment, and yet so as to deceive the ignorant public and make them believe it was original work! Surely here is a Daniel come to judgment—though rather late in the day. Presently we shall have to inquire whether he who delivers this severe judgment is a competent as well as a just judge.

The next point is to show how it was that this dull compilation created such an excitement in the literary and scientific world, and made so many converts. We are told this was all owing to Darwin's habit—partly unconscious, partly designed—of thinking and speaking so highly of the work of his chief scientific correspondents—Hooker, Lyell, and Huxley. "Lyell is the biggest fish; and it is the hooking of him that is wished, and watched, and waited for with the intensest interest." (p. 166.) And after giving nearly two pages of extracts from Darwin's letters, we have the remark—"I suppose no one in this world has been more liberally or more lavishly thanked, flattered, and bepraised than the recipients of the above." (p. 169.) Referring to the preliminary papers read before the Linnean Society, Dr. Stirling remarks:—

"The way being so conspicuously prepared for it, and its appearance ushered in and heralded by a trumpet-blowing so resonant and extraordinary, was it any wonder that the book itself was hailed with acclamation and received with even a rush of expectation? And we have now only to see how the proceedings of Mr. Huxley at the very first could but beat the excitement that, so to speak, already blazed into an absolute conflagration and a veritable fury." (p. 172.) "As we all know, all in England is done by parties, and everything that appears in England is of no use whatever until it is made an affair of party. It was not different with the origin of species." (p. 174.) "With all before it that has now been detailed what could the public be expected to think? The most powerful scientific trumpets that, in these islands, could be blown, were blown—before the book. The most powerful popular trumpets that, in these islands, could

be blown, were blown—after the book. . . . What could be expected for such a book, if not all but a universal rush to buy? . . . . And how did the public find the book? I do not suppose that any one will pretend that it is read now; and I do not suppose that any one will pretend that it was read *through* then—unless by those, the few friends of science and the author, whom, in both respects, of course, it immediately and specially concerned." (p. 176.)

Dr. Stirling should, however, have explained to his readers how it was that a book which hardly anybody read should have gone through six editions in twelve years, have been translated into every European language, and should still be constantly quoted and referred to as the most classical and authoritative work on the subjects of which it treats.

Half the volume having been thus occupied in the insinuation, and attempted proof, that Darwin was a mere compiler with little reasoning power, that there was nothing in his book that was not anticipated by his grandfather (pp. 43-49), and that the book itself owed its success to the carefully-prepared trumpet-blowing of a few influential friends, Dr. Stirling proceeds to demolish the whole theory in detail in order to justify the conclusion he has arrived at. And it is clear that the value to be attached to his judgment, in this matter, must depend upon whether he has taken the trouble, or has the capacity, to understand the theory, or has acquired an adequate knowledge of the facts on which the theory is founded. I propose therefore to show, by a rather full account of his work and by a sufficient number of extracts, the almost incredible state of ignorance and misapprehension everywhere displayed by it.

Chapter v. deals with the Struggle for Existence, devoting to it twelve pages, and maintaining throughout that, in the sense in which Darwin and his followers understand it, there is no such thing! If this can be proved Darwinians must indeed tremble. Let us then see how it is done. The tameness of animals in uninhabited islands is first referred to, with the remark: "It is impossible to think of struggle and strife in such circumstances." Dr. Andrew Smith and Mr. Selous are quoted to show the vast profusion of life in South Africa, carnivora and herbivora—"Plentiful lion was not incompatible with more plentiful antelope." Then the *passenger pigeon* of North America is referred to, as described in one of Cooper's novels; and the conclusion after two pages of such facts is—"With nature so prolific of life, what call is there for a struggle? what need?" Then we have several pages given to descriptions of how animals enjoy their lives. Mark Twain is quoted for playful schools of whales; Bret Harte for squirrels and jays; Jules Verne for antelopes, zebras, buffaloes, and monkeys; two articles in *Temple Bar* on birds and otters amusing themselves. Darwin himself testifies to "the positive pleasures of existence, to the actual joys of nature," and, "it is perfectly within the limits of truth to say that his entire *Journal* disproves the struggle!" And this conclusion is reiterated to the end of the chapter:—"There is little sign of a struggle for life in such cases. These animals have evidently no need to struggle: they seem indifferent about their food, and can remove themselves carelessly from any supplies of it."

(p. 214.) The *Journal* says so little of the struggle that Dr. Stirling believes the idea to have been only an after-thought, following the reading of Malthus, and he concludes the chapter with the opinion of Goethe, that, "in whatever situation of life we are placed, and wherever we fall, we never want actual food"—and he adds—"This means, that however galling the straits of life may be, there is no struggle such that, failing to triumph, we must perish in defeat."

The next chapter—on the Survival of the Fittest—is a short one; and it might well have been shorter, since it begins thus:—

"As regards our other consideration at present, it is pretty evident that if struggle there is none, survival, in that it simply means result of foregone contest, can be, and must be, so far, only a dead letter."

This, though forcible, is cautious, but the next paragraph sets the thing in a still clearer light.

"But, just squarely to say it, the proposition itself, survival of the fittest, is as things are, preposterousness proper. It is simply absurdity's self—the absolutely false."

And then follows, quite unnecessarily, a metaphysical and scriptural demonstration of the same thing, in which comets, tides, wind, the earthquake of Lisbon, the Black Hole of Calcutta, contingency, time, and physical necessity, with a host of other things, are all dragged in to enforce the argument. This abstract argument was, however, felt to need support by a concrete example, as follows:—

"Survival of the Fittest! Of two lions that fight, *must* the strongest win? How about a thorn, or a stone, or an unlucky miss, and an unfortunate grapple, and a fatal strain—to say nothing of infinite contingencies of rest and fatigue, of sleep, and food, and health, that precede?"

And after a few more such illustrations we have the conclusion, that—

"The proposition, as we have seen in fact, is wholly false as it stands."

And after some more vain attempts to arrive at any meaning in this "absurdity's self," the argument is clenched with what is evidently felt to be a *reductio ad absurdum*, and which is indeed a very gem of logic, as follows:—

"Is it possible in such a struggle—a struggle that just constitutes existence—is it possible in such a struggle for even a single competitor to survive him who is the fittest to survive? If individual with individual, species with species, genus with genus, must struggle, how is it that the infinitude of time has not already reduced all life to a single unit?" (p. 222.)

Every biologist, every reader of NATURE, will now, I am sure, see that I was justified in speaking of the almost incredible ignorance and misapprehension exhibited in this book; but we have yet to find still more glaring examples of it. Two chapters, entitled "Determination of what the Darwinian Theory Is" and "Design," may be passed over, and then follow six chapters of "Natural Selection Criticised," from which a few illustrations of the capacity of the critic must be given.

After Dr. Stirling's confident assertion that there is no struggle and no survival, and that the very idea of there being any such phenomena is "absurdity's self," we shall not be surprised to find that he prides himself on having cleared up a subject which Darwin left vague, indefinite, and obscure. He says:—

"It is only through long, patient looking that the particular moments in the theory have reached the clearness which we should be glad to think they will be found to possess in these pages." (p. 342.)

This is in the last chapter, when the author can look back with satisfaction on his completed work.

One of the difficulties he has cleared up is the meaning of the word origin, in "Origin of Species." He says there is never a moment's question of the *origin* of a single species:

"There is not even a hint before us of such a thing as *origin*. Change there is, not origin. We have a middle, elastic enough it may be, but we have no beginning, no origin, no first." (p. 250.)

And a little further on, having previously referred to small living armadillos and the gigantic extinct species, and having asserted that "It was the obvious resemblance common to both that irresistibly convinced Mr. Darwin of the indubitable descent of the one from the other"—a statement for which he gives us no authority—for the good reason that none can be given—he deals with the question in the following brilliant style:—

"Origin! We are referred from the Galapagos to the South American Continent, and there again the problem stares us in the face, only harder than ever. What is the origin of these South Americans? Again origin! What is the origin of these pigmies? and you refer us to giants! Good heavens! To be contented that the whole problem of the pigmies was solved in the giants, and never once to have asked what of these! Surely the giants at once suggest an infinitely more instant question as to origin than the pigmies. That pigmies, too, could come out of giants—such pigmies out of such giants! Was it *selection*, natural selection, condescended to such a feat as that? . . . Is that what is meant by 'the preservation of favoured races in the struggle for existence'—these pigmies? The nine-foot Glyptodon dies, the six-inch armadillo lives—is that the survival of the fittest?" (p. 251.)

This may be called argument by exclamation and interrogation founded on misconception, and it goes on with wearisome monotony page after page. And at the very end of the book he still stumbles over the same difficulty:

"This is strange, too—in the whole 'Origin of Species' there is not a single word of origin! The very species which is to originate never originates, but, on the contrary, is always to the fore."

And again:

"It was only the word *origin* did all this; and the word *origin*, strictly was a misnomer; misleading, not novelists alone, but the general public as such, into anticipations of a beginning and a first that was to be, as it were, a new creation of all things; whereas Mr. Darwin himself exclaims, 'It is mere rubbish thinking at present of the origin of life!' Had Mr. Darwin but used,

instead of the word origin, his own other word for the idea in his mind, 'modification' namely—had his title-page ran 'The Modification of Species by Means of Natural Selection,' I question whether Mr. Murray, with all his experience, would, for each of the thousand copies he did sell, actually have sold ten." (Last page.)

Poor novelists! Poor general public! For thirty-five years you have gone on reading and discussing this book, and helping to make it celebrated, and have only now found one candid and truthful friend to inform you that you have been flagitiously deceived by the title, without which you would never have read it, or made any fuss about it, or even have heard of it at all!

In order, perhaps, to enforce this conclusion—that it was the word origin that alone attracted readers, Dr. Stirling assures us that Lyell was too old a bird to be caught by such chaff. Huxley, he tells us, is in a state of doubt; Carpenter and Gray were only half-converted; Hooker is the only genuine convert; but—

"Lyell, from the moment he came properly to know the doctrine, was really, and in point of fact, that doctrine's absolute opponent."

It is to be supposed, of course, that Dr. Stirling believes this; but then what of his knowledge? In five long chapters of the last edition of the "Principles," Lyell expounds the whole theory in his own calm judicial style, and on every aspect of it pronounces in its favour.

The passages we have marked in this volume as examples of misconception, misstatement, or ignorance, are so numerous that it is difficult to know where to choose. Here for example is the way the author deals with natural selection, as being neither a law nor a discovery.

"But has there been a *discovery*? and actually of a *law*? We have seen an hypothesis—a gourd, as it were, that came up in a night to be a shadow over the land—but a discovery? Can what the Pampas suggested, or South America, or the Galapagos—can what the breeders or fanciers suggested, or what Malthus suggested, or what the split-up stock of horses suggested—can either or all of these suggestions be called a discovery? That the similarities in species (as in the beetles, say) should have struck him, and that he should have then asked, What, if naturally varying in time, and so naturally variously applied, they were all just naturally out of each other?—that is a mere supposition, it is no discovery. Even as a supposition, is it a credible one, unless we remove it, far out of sight, into the dark? Yes: variations, accidents, we know them well, we see them daily; but they come and go, they appear and disappear, they are born and they die out—they really do nothing; and as for forming new creatures, is not that an extraordinarily weighty complication to burden such simple, perishable, transitory accidents with?" (p. 284.)

Here we have an interrogative show of argument and of superior knowledge on a subject as to which it is quite clear that the writer knows nothing whatever, but hides his ignorance in vague involved words, from which it is impossible to extract any definite meaning. And when he attempts to deal with any definite facts, the ignorance becomes more glaring and the flood of wordy interrogations more ludicrous. One more quotation to show this, and we have done. He is attempting to deal with the theory of protective colouration, and after a couple

of pages of misconception and interrogation, he thus proceeds:—

"But, seriously, why are canaries yellow? Why are larks and starlings spotted? Why has the robin the red breast that gives him his name? Selection! There is actually no selection. Neither on the part of nature, nor on the part of sex itself, is there the slightest proof of the necessary limit of selection. For selection, in the very idea that constitutes it, means a limit. And limit there is none. Blacks, and whites, and blues, and reds, and greens, and yellows, are to be seen indiscriminately mingled, almost everywhere—blacks, and whites, and reds, and greens, &c., in almost every possible shading—nay, in almost every possible variegation, too! All that pretty anecdotal rationalising—story-telling—in regard to the leopard, too (the grandfather has it), is it not of the same kind? There are so many leopards in existence because their spots, confounded with the interstitial light and dark of the jungle, save them. But if that is so, why are there quite as many tigers, animals that are not spotted, but striped? Oh, the ghauts, the ghauts, you cry. Well, yes, the ghauts are defiles; but how is a stripe like a defile, or how does it come from a defile, or as being like a defile how does it save them? But admitting that, and saying that leopards are saved by spots, and tigers by stripes, what of the lions? They can be saved by neither—neither by spots nor by stripes, and they are equally numerous, or supposably equally numerous—and *supposably so* is the vernacular of the region—why is there no call for either spots or stripes in their case? Or, after all, just as it is, spotless, stripeless, is not the lion quite as likely to escape detection in the jungle as either of the others, let it be leopard, let it be tiger?"

How clever is the jingle of words and interrogatives, yet how crammed with blunders and how devoid of sense! The writer evidently thinks that Darwin, or some authoritative writer on Darwinism, has stated that the tigers' stripes imitate the defiles in which they live, which defiles are the "ghauts"! He also is of opinion that leopards, tigers, and lions, all live together in the same "jungles," all have the same habits, and therefore all require the same protective colouring. But they are not coloured alike; therefore their colouring is not protective! That is a sample of Dr. Stirling's knowledge and of Dr. Stirling's argument.

Readers of NATURE may think that too much space has been given to so contemptible and worthless a book; but it must be remembered that the author has a considerable reputation in philosophy and literature, has published over a dozen works of more or less importance, and was the first Gifford Lecturer at Edinburgh University in 1888-90. It is certain that many purely literary critics, as ignorant of biology as is the author, will declare the work to be an important adverse critique of Darwin and Darwinism. If it were the work of an unknown man, it would, so far as its matter is concerned, be beneath contempt. But when a writer of established reputation goes out of his way to discuss a subject of which he shows himself to be grossly ignorant, and puts forth all his literary skill to depreciate the mental power and the life-work of one of the greatest men of science of the century, it is necessary and right that, in the pages of one scientific journal at least, the ignorance, the fatuity, and the carping littleness of the whole performance should be fully and unflinchingly exposed.

ALFRED R. WALLACE.

DYNAMOS AND TRANSFORMERS.

*Dynamos, Alternators, and Transformers.* By Gisbert Kapp, M.Inst.C.E., M.Inst.E.E. (London: Biggs and Co.)

THE author of this work is well known as a successful designer of dynamos and transformers. In his preface he states his object to be "to place before the reader an exposition of the general principles underlying the construction of dynamo-electric apparatus, and to do this without the use of high mathematics and complicated methods of investigation." He further says, on p. 26: "In attempting to establish a working theory of dynamo-electric machinery, or rather in setting forth the rules and formulæ now used by the designers of such machines, we shall therefore not follow the lead of the pioneers in science so much as that of their more popular expounders, and that of practical experience. The treatment will thus necessarily lack that mathematical elegance of which the scholastic mind is so fond, but, on the other hand, it will be more easily grasped and adopted by the practical engineer who works as much by the aid of his mechanical instinct as by that of science."

This is the promise, and we may say at once that in our opinion there is plenty of room for mathematical elegance on the lines laid down. If the results of difficult investigations be assumed, and correct deductions be made and set forth in exact language and in appropriate notation, as required for the particular practical application, the exposition will be both elegant and scientific. Practical experience also is on the same footing as any experimental result in physics, and deductions made therefrom may be scientific in the highest degree. From the extracts above quoted, one would not expect to find one-third of the book occupied with a theoretical exposition of electro-magnetism on lines similar to those that may be found in a dozen or more existing works. But such is the case, and we regret to say that there is much in the exposition of the author that is open to severe criticism on the score of the inaccurate and frequently incorrect use of scientific and practical expressions, whose meanings are thoroughly well-established and generally understood. The word "energy" is employed in a sense with which, we imagine, theoretical and practical men will be alike unfamiliar. "Work" and "rate of doing work" are throughout the book employed as interchangeable expressions, the word "energy" having double duty thrust upon it. It is scarcely necessary to observe that "energy" is expressed in units of work, and that it is improper to use it in the sense of "rate of doing work" or "power." This is all the more extraordinary for the reason that the author defines "power" or "activity," and in one part of the book freely uses these terms to denote what he calls "energy" in another part.

More serious is the circumstance that the author thinks it proper to express "rate of doing work" in units of "work." On p. 42 we find the statement: "This is called the Watt, and is equivalent to 10,000,000 ergs." It is as if the distance between London and Brighton were described as being fifty miles per hour.

In the same context the C.G.S. unit of power is termed the erg-second. We have heard of the Watt-second, the

volt-ampère, the ampère-second, &c., but never before of the erg-second, which has no meaning whatever as a hyphenated expression built up in the manner customary with electricians.

On p. 141 electromotive force is under discussion by means of the well-known rail and slider; and on p. 142 occurs the following passage, which may be said to fairly beat the record:—

"It was shown in chapter iv. that the mechanical force, P, acting upon a conductor in a field of B lines per square centimetre is (C.G.S. measure)

$$P = l c B$$

where *l* is the length of conductor and *c* the current. If we move the slider with a velocity of *v* centimetres per second the energy required will be

$$Pv = l c B v \text{ ergs.}$$

The energy represented by the current is *ec*, if by *e* we denote the electromotive force expressed in a suitable measure. We have therefore the equation

$$ec = l c B v \quad (28)$$

or,

$$e = l B v$$

from which we find that the induced electromotive force is given by the product of length of conductor, strength of field and velocity, all in C.G.S. measure.

Formula (28) gives the energy in ergs.

To obtain it in Watts, we divide by 10,000,000, and have

$$\text{Watts} = l c B v 10^{-7}.$$

Herein we find almost every conceivable blunder. Power is termed "energy," and expressed in ergs; formula (28) is said to give the energy in ergs, whereas, of course, it gives the power in ergs per second; and to wind up the comedy of errors, an expression said to represent ergs is divided by the number 10<sup>7</sup>, and, magically, it appears as Watts.

Was confusion ever worse confounded?

The practical man—whose intellect the author considers robust enough for the expression, "line integral of magnetic force," and for the comprehension of the (freely employed) integral calculus—is very easily pleased if he finds this sort of information improving. Surely, above all things, he demands accurate statements, and resents having symbols thrown at his head in this contemptuous manner.

On p. 27 the north pole of a bar magnet is described as "the end which, if the bar were freely suspended would point to the geographical north."

Why the qualifying adjective "geographical"? If the author desired to evade a definition of the magnetic meridian, he surely might have preferred a "suppressio veri" to a "suggestio falsi."

Many examples might be given of the looseness of the language employed. We already possess a number of excellent books on electro-magnetism written by thoroughly practical men in precise and accurate language; and we must enter, for the reasons above given, a strong protest against the theoretical portion of this book.

It is a pleasure to turn to the really practical part of the work, where the reader will find valuable information concerning dynamo design. In the case of large machines, the author favours the multipolar type. He

gives a detailed comparison of two-pole and four-pole machines of a power of 25 kilo-watts, and shows, it seems conclusively, that the latter can be made lighter, and to run at a lower speed than the former. We find a distinction made between the "static" and "dynamic" electromotive force of a dynamo; the former is defined to be the E.M.F. "generated in the armature, and directly measurable on the brushes if the machine is working on open circuit." This is always shown on the characteristic (volt and ampère) of a dynamo of whatever nature, and as there is no discontinuity between it and "dynamic" E.M.F. it is difficult to see the necessity either for separate discussion or for special nomenclature. The alternators chosen as examples are representative of the different systems in vogue. We find those of Siemens, Ferranti, Gulcher, Mordey, Kingdon, and also that of the author designed for Messrs. Johnson and Phillips.

There is not much set down about alternating current transformers, but some good working diagrams are given. There is no information about multiphasers. We have noticed some typographical errors. A serious one occurs on p. 46.

P. A. M.

#### GOLF.

*Golf: a Royal and Ancient Game.* Edited by Robert Clark, F.R.S.E., F.S.A. Scot. (London: Macmillan and Co.)

PROF. TAIT has recently pointed out how many scientific problems are involved in the flight of a golf ball, and many men of science have learned to find in the game of golf a never-failing and unsurpassed means of recreation from their arduous labours. It is fitting, then, that Mr. Clark's new edition of a golf classic should be noticed in these pages.

A writer, who was a famous cricketer, and is apparently a new humorist, has lately, in the pages of a serious *Review*, started a controversy on the question, "Is Golf a first-rate game?" The question must be here dismissed with the remark that it is absolutely irrelevant. Unless there is no grain of earnestness in his reasoning, internal evidence, often misleading, shows that the writer referred to is in the twilight of knowledge of his subject, and the twilight of the gloaming, not of the dawn. Let him hope that he may pass through the darkness, and that it may be as the brief gloom of a St. Andrews' summer night. Mere first-class games, like cricket and kindred, are light o' loves, who leave you the moment that you have lost your youth and your pace. Golf is like a mother—kind to you once; that is, all her life.

In the year 1875, "*Golf: a Royal and Ancient Game*," was edited and privately printed for a small circle of subscribers. It has long been out of print, and a new and slightly enlarged edition has now been published for the benefit of the world at large. It is a delightful book, and the reading of it is a pleasure. In it is found in all its quaintness the dear old fast-dying dialect of the Lowlands of Scotland, and here and there bits of the delicate humour indigenous to the same region. The atmosphere of the book is as breezy as that of the links which now dot our East Coast from

John o' Groat's to the South Foreland. To class the book as a history is not quite accurate, for it is more a collection of the materials for history than history itself; but to any one interested in the subject, that is no drawback.

The introduction is excellent, and together with the old statutes bearing on the game, the extracts from burgh and parish records (much added to in the present edition), the extracts from private note-books and from old minutes, and the new notes, afford interesting glimpses of the social life of the kindly Scots of the olden time; of the difficulties of "the powers that were" in weaning the people from the game, in order to lead them to the archery butts and to the kirk; of the funeral ceremonies of a keen golfer, the father of the great Marquis of Montrose, lasting one month and nineteen days; of the consumption of wine during that period of mourning being reckoned in puncheons, and of the buckets of Easter ale being as numerous as the tears that fell; of Smollett's genial reflections upon seeing on Leith links a party of four playing Golf, the youngest of whom was turned of fourscore. Among those records are to be found also materials out of which a theory of the development of the Sabbatarianism peculiar to Scotland might be built, and of this something of interest might be said did space permit.

The gossip part of the book is too short. The story of John Paterson might be passed as a variant of the old tale of the king and the cobbler. It was at all events sufficiently interesting to inspire the celebrated Dr. Pitcairn to write for the mural tablet of John's new house—his reward from Royalty for his prowess at the Golf—four elegiac verses and a motto enigmatically telling to all time a tale and John Paterson's part therein. The verses and the motto may be worth quoting:—

Cum victor ludo scotis qui propius esset  
ter tres victores post redimitus avos  
patersonus humo tunc educebat in altum  
hanc quæ victores tot tulit una domum.  
I hate no persone.

The motto "I hate no persone" being an anagrammatical transposition of the letters in the words "John Paterson."

The verses in the book are not intended for criticism, but a "Ballade of Golf" and "A Voice from the Rhine" are welcome additions. The wood engravings and the plates appeal to the artist, and an addition to the number of the latter in place of the photographs that were, apart from their interest to contemporaries, out of all keeping with the pictorial part of the first edition, is a step in the right direction. The only serious objections that can be taken to the present edition, and that only in a spirit of gentle remonstrance, are pointed out in the prefatory note by the editor. Following the note in the order of its statements, it sets forth that since the publication of the first edition, Golf has advanced by leaps and bounds, that it is now as popular in England as it is in Scotland, that it has taken deep root in Ireland, yet in the body of the book not a sentence is devoted to Golf clubs furth of Scotland. No doubt this is partly explained by the fact that no existing club furth of Scotland except Blackheath is old enough to have a history. At the same time a few pages recording the facts of the introduction of Golf in recent years, not only to England

and Ireland, but also to America, India, Australia, Canada, and other parts of the world where Scotsmen have congregated, must have added to the value of the book. But, in this connection, the grave omission is that there is no reference to the history and records of the Blackheath Club, the oldest club in the United Kingdom. This is all the more remarkable, that a bright description of "Medal Day at Blackheath" has a place in the book.

The most serious complaint is left to the last, and that is that the editor should say in the note referred to that he has abandoned his intention of writing his own reminiscences. The reason assigned, that the books of his friends are a bar, will not bear examination. These books, clever and able as they are, were born of the high spirits of the hour, and were never thought of by their authors as anything but ephemeral. They served and are serving a good purpose; they amuse and instruct their generation, and it matters little that they have induced many to contort themselves into the oddest of attitudes. The editor and his friends might furnish an interesting chapter of the history of the game. They have seen the days, when the grand manner was not yet dead, when the style of the front rank Golfers was distinguished by something more than force and mammoth driving, when it was as graceful as that of the play of fence of a first-rate swordsman; the days when the social life of Golf was free from some of the irksome bonds which it now wears. How many now remember an incident that marked an epoch, the boys' tournament of the summer of 1860, organised at great expense of time and trouble by the late Sheriff Gordon! How few know anything of him! And yet he was as distinct a type of a Scotchman of a past generation as singing Jamie Balfour, whose effigy is one of the adornments of the book. It is to be hoped that the editor may reconsider his decision, and add a chapter on modern Golf, stopping short of the time when it became the fashion. As it stands, the book is the only book indispensable to the Golfer, and its wider circulation will no doubt lead many to the great house of Golf. There they will read, and feel the truth of, the legend inscribed in indelible letters upon the portals: *Inde Salus*.

Let the last words here on this subject be the words of an enthusiast:—

"Plaudere, non jubeo" (you may do that at cricket) "sed magna voce frementes.

Dicite: In aeternum floreat alma domus.  
Floreat."

W. RUTHERFORD.

#### OUR BOOK SHELF.

*Celestial Objects for Common Telescopes*. Vol. i. By the Rev. T. W. Webb. Fifth edition, revised and enlarged, by the Rev. T. E. Espin, M.A., F.R.A.S. (London: Longmans, Green & Co., 1893.)

SINCE the original edition of Webb's "Celestial Objects" was published in 1859, no book has appeared which has found greater favour in the eyes of amateur astronomers. Written by one who had seen the wonders and glories of the heavens, the work has always been recognised as sounding the genuine ring that results from rich experience; and by entrusting the editing of the fifth

edition to the Rev. T. E. Espin, the publishers have acted wisely, for he is an observer versed in both the old and the new astronomy.

The work has been divided into two volumes, the first of which is before us. This volume is concerned with the subjects of parts i. and ii. of the original work; the second, which will probably be published shortly, covers part iii. and is the book for the observatory. In some respects, this division of matter is an improvement, for descriptions of astronomical phenomena can very well be kept apart from lists of celestial sights. Mr. Espin is wholly responsible for the volume as yet unpublished, and as it has been entirely rewritten, we may confidently expect many important innovations. In the volume under review, very few alterations of the original text have been made. To bring the book up to date, workers in different branches of astronomy have contributed additional matter on the subjects in which they are specialists. One of the results arising from this division of labour is that the chapters are extremely unequal. The new matter is added in foot-notes, but we think the book would have gained in value if it had been incorporated in the text. Among these notes is one on celestial photography, and another on spectroscopy as applied to the telescope. In the latter we read that "Stellar spectra were divided by Secchi into five types," and closely following this remark is given a classification in which Type v. includes bright line stars and nebulae. But Secchi only distinguished four types of stellar spectra, and it was not until 1891 that Pickering proposed to add a fifth type to Secchi's classification. There is another matter that might be more clearly expressed. In the brief statement of the use of the objective-prism for obtaining photographs of the spectra of stars, it is not mentioned that the prism must be fixed over the object-glass with its edges east and west. If the prism is arranged with its edges north and south, no amount of regulation of the driving-clock will expand the linear star-image into a band upon the photographic plate. These omissions are, however, very slight, and Mr. Espin will doubtless remedy them at the first opportunity. They certainly do not less-en the welcome we extend to this new edition of an excellent book.

*Plane Trigonometry*. By S. L. Loney. (Cambridge: University Press, 1893.)

IN the 500 pages of which this volume consists, the author has placed before students of trigonometry an elementary text-book which only wants reading carefully to be thoroughly understood. One cannot do more than state in clear and plain language the various methods of expressing trigonometrical ratios, the applications of algebraic signs, ratios of multiple and sub-multiple angles, &c.; and this the author has done, interpolating neatly printed figures and concise explanations wherever they seem necessary for a clearer exposition. A great number of excellent examples is also given, the answers being collected at the end. No very marked deviations from the usual sequence of the subject-matter adopted in such text-books have been made, but it is noticeable that here and there are given at some length many pieces of book-work which are passed over in a few words in some books. The second of the two parts into which the book is divided deals more with the analytical side of trigonometry, that is, with exponential and logarithmic series, expansions of trigonometrical quantities, summations of series, &c. In this part the treatment of complex quantities has been so handled as to lead the student up to the methods of the more advanced treatises. The concluding two chapters deal briefly with errors of observations, some miscellaneous propositions, solution of a cubic equation, maximum and minimum values, &c. A very useful list of all the principal formulæ which the

student should commit to memory is separately printed, and precedes the first chapter. Beginners will find it better on their first reading to omit the articles specially marked for this end, and also to make selections from the examples. It would be hard to find a better introduction to plane trigonometry book.

### LETTERS TO THE EDITOR.

*The Editor does not hold himself responsible for opinions expressed by his correspondents. Neither can he undertake to return, or to correspond with the writers of, rejected manuscripts intended for this or any other part of NATURE. No notice is taken of anonymous communications.]*

#### Music, Rhythm, and Muscle.

IN your issue of January 18, you refer (on p. 271) to an article by Dr. Wilks in the *Medical Magazine* (which I have not seen), in which the learned author points out that music is not to be regarded in its origin as a purely spiritual faculty, but that it admits of a physiological explanation. This discussion is in itself a most interesting one. Dr. Wallace, in his well-known discussion of the relations of music to the other faculties of man, has raised this very question, or one closely allied to it. Wallaschek, as quoted by Dr. Wilks and yourself, asserts that "rhythm, or keeping time, lies at the very foundation of the musical sense." Rhythm again, he says, "can be referred to muscular contraction and relaxation," the "muscular sense being the measure of time," so that the muscular sense is intimately bound up with the idea of music. "Not in the different passions of the mind, but in muscular action, therefore, music appears to have had its origin."

My purpose in addressing you is to point out that these opinions receive a remarkable and very beautiful illustration in the history of Greek dance and rhythm, so far as these are known to us. We know but little of Greek music in the stricter sense of this word, and this perhaps for the very reason that music was not then separated from choral intonation and movement. The strophé and antistrophé of the Greek chorus, which terms we usually apply to the musical phrases sung during a movement, are primarily, of course, not these strains but the evolutions themselves, the dancing towards the one side of the orchestra or the other. Now we do know from the metrical analysis of Greek dramas and odes what these rhythms were, and we can thus probably infer the character of the music proper. By the study of Greek rhythms we shall thus find a method of tracing the genesis of music in its most elaborate modern forms from dancing and footing it in any kind of measure. Dr. Wilks well points out that muscular movement is essentially rhythmical: we may go farther and say that all movement, even the rush of falling water, is rhythmical.

The monotony of the recurrence of identical periods or colons would soon be felt, and we find accordingly that efforts are made by all early people to vary the measures. The use of two and four simple feet would soon pall, and was accordingly broken up in the Greek drama by threefold and more complex metres, as, for instance, by Pindar in his Epinikian odes. This "threefold form," says a recent writer, finds an almost exact counterpart in most of the figures of Bach's "Wohltemperiertes Klavier," and the "modern sonata has the same form on a very extended scale," the first part and its repetition corresponding with the strophé and antistrophé of the Greeks, and the second part with the epode. These curious parallels and essential similarities may be traced much farther and into elaborate detail, as is shown in part by the writer I have quoted, Mr. Abdy Williams, in the *Classical Review* for 1893 (p. 295). Mr. Williams's article, which well deserves a careful reading, is based upon the important discovery of a treatise on rhythm by Aristoxenus of Tarentum. Aristoxenus was a favourite pupil of Aristotle, and flourished about 300 B.C.; he wrote also a treatise on harmony, which less concerns us here, and he was "not only a musician, but a man of the widest culture and knowledge." Soon after the time of Aristoxenus the dependence of music on metre, which in its turn is a notation of choral movement and but a regulation of the rhythms of various muscular movement—the dependence, I say, of music on metre gave way to the ascendancy of accent. Accent, and not quantity began to

form the basis of the rhythm. Strict measure thus became less obviously the basis of music and poetical rhythm; but, says Mr. Williams, "upon the ruins of the ancient measured music arose a new and magnificent art, now known as 'Plain Song' or 'Gregorian Music,' the rhythmical construction of which is based on the natural laws of phrasing." (Compare strophé and antistrophé.)

With the disuse of plain song arose again the old metrical rhythms, but now so dissociated from choral evolutions that we have forgotten their muscular origin. The early modern composers recovered the elaborate rhythms once founded on choric phrases, but under the name of "form," and "by following the instincts of their genius, unconsciously brought about a renaissance of the natural rhythms and musical forms known to the ancient Greeks, developing them by the aid of modern resources, while adhering to certain definite principles which on examination are found to agree with those enunciated 2000 years ago by Aristoxenus of Tarentum." These, I need not repeat, were almost directly based not upon rhetorical, but upon muscular rhythms. The simpler and ruder the musical sense, the more brief and simply bipartite, or two-legged, must be the recurrent rhythms, as the popular tunes of our street organs and music halls tell us daily; the more relieved and elaborated rhythms of Bach and Beethoven need a more sustained attention and a more cultivated apprehension, while the rhythms of Wagner are so postponed in their resolutions, and so broken in their variety, that perhaps few even of good musicians can follow them with any consciousness of muscular measure, or even of "form." Therefore we call them "highly spiritualised," and forget whence they are originally derived.

Cambridge, January 28.

T. CLIFFORD ALBUTT.

P.S.—Since writing this letter, Prof. Roy has drawn my attention to the statement that if a pencil be taken in the right hand, a sheet of paper placed below it, and the hand thrown into a rapid automatic dotting action, as the paper is drawn forward the resulting row of dots will be found to be a uniform number per second—five or seven, I forget which—and thus for all persons alike there is the basis of rhythm.

#### The Cloudy Condensation of Steam.

THE publication in your pages<sup>1</sup> of Mr. Shelford Bidwell's lecture on "The Cloudy Condensation of Steam," at the Royal Institution in May last, calls for a few remarks from me. As the points I have to refer to are principally personal, I shall be as brief as possible.

In discussing the effects of electrification on the condensation of a steam jet, Mr. Bidwell, after pointing out that though it has been shown that small particles of matter are thrown off by the electrical discharge, says that—"Yet it is remarkable that Mr. Aitken . . . gives no countenance to the nucleus theory." He then informs his hearers that he imagines I have abandoned my conclusions regarding the action of dust. It is very difficult to understand Mr. Bidwell's objection to me not countenancing the nucleus theory to explain the phenomena, as in the very next paragraph he shows I was correct in not ascribing the change in the jet when under electrification to dust particles, and gives an experiment to prove it. His experiment is different from the one on which I founded my conclusion. In some experiments made when working at this subject there did not seem to be a possibility of the dust produced by the electrical discharge getting to the jet. Take, for example, the following experiment:—The steam jet was allowed to issue from the side of a polished metal ball of about 3 c.m. diameter. This arrangement was adopted to prevent any discharge of electricity from the nozzle. At one side of the jet was placed an electrified body at a distance of about 10 c.m.; and at about the same distance on the other side of the jet was placed a flame. As no air passed either from the flame or from the electrified body to the jet, it seemed impossible the effect could be due either to particles of metal from the conductor or to particles of dust from the flame. The conclusion, therefore, was that the effect on the jet could be produced by electricity without the aid of dust. It, however, seems highly probable that the dust produced by the discharge of electricity may have some effect in such experiments as those described by Prof. Barus, in which the air from the terminals from which the discharge is taking place is carried to the jet. Prof. J. J. Thomson

<sup>1</sup> NATURE, December 23, 1893.



has since shown<sup>1</sup> that the increased density of the jet on electrification is only partly due to the cause to which I attribute it, namely, the electrical repulsion preventing the coalescence of the drops, as he proves that the electrification of the jet overpowers the surface tension, and so promotes the formation of small drops, and in this way assists in increasing the density of the condensation.

Mr. Bidwell's misunderstanding of my position is greatly due to an impression he seems to have that I attribute all cloudy condensation to the presence of dust particles. Now, if he will turn to my first paper on this subject,<sup>2</sup> he will find that the effect of the vapours of hydrochloric, sulphuric, and nitric acids, active vapours, mentioned in his lecture, have all been referred to, and experimented with, as well as many other substances, so that I was well aware of these causes of condensation. Further, he will find in the paper referred to, as well as in another of a later date,<sup>3</sup> that it is possible to produce cloudy condensation without the presence either of dust or a vapour capable of forming a nucleus with water vapour, or even the abnormal condition due to electrification, all that is necessary being a sufficiently high degree of supersaturation.

Darroch, Falkirk.

JOHN AITKEN.

**The Os Pedis in Ungulates.**

PROF. EWART, in a recent paper,<sup>1</sup> describes the os pedis or "coffin bone" of the horse as consisting to a large extent of a bony cap developed from connective tissue around, and quite independent of the terminal phalanx. This throws an entirely new light on one of the most remarkable bones of the horse's skeleton, and is especially interesting to veterinarians. Having a foetal calf (about 6½ months) in my possession, I was led, on reading Ewart's paper, to examine the digits, and wish now, in a word, to state the result.

I found each digit provided with a bony cap similar to that figured by Ewart from his 35 c.m. horse embryo. On making a longitudinal vertical section of one of the digits, the investing cap could easily be distinguished from the phalanx proper; and, further, I noticed a large deposit of osseous matter in what may be termed the diaphysis (shaft) of the terminal phalanx, and an indication of a second ossific centre at its apex. This affords additional proof that the third phalanx in ungulates, as in man, consists partly of membrane bone and partly of cartilage bone, and that it in all probability develops from several centres.

I hope soon to publish a number of observations on the structure and development of the digits in ungulates.

A. E. METTAM.

Royal Veterinary College, Edinburgh.

**A Brilliant Meteor.**

A METEOR of extraordinary splendour was seen here this evening at 7.45. It appeared vertically under the Pole star, at an elevation of 40°, and, after pursuing a path that sloped down to the west at an angle of 30°, disappeared silently under Casiopeia.

The incandescent mass had an apparent volume equal to that of a good-sized orange. It gave out a bluish-white light that brilliantly lit up, for about four seconds, the grounds and buildings of the College.

The glowing mass was followed by a long, conical, crimson train ending in a wisp of condensed vapour resembling smoke.

The sky was clear, starlit, and moonless at the time.

M. F. O'REILLY.

The Training College, Waterford, January 31.

**THE VATICAN OBSERVATORY.**

THE report recently issued by the Vatican Observatory (*Pubblicazioni della Specola Vaticana*, Fasciculus iii.) is the best that has been prepared by Father Denza, and in abundance of matter and fineness of execution, it compares favourably with that of any observatory. The

<sup>1</sup> *Phil. Mag.*, October, 1893.  
<sup>2</sup> "Dust, Fogs, and Clouds." (*Trans. Roy. Soc. Edin.*, vol. xxx. part i.)  
<sup>3</sup> "On the Numbers of Dust Particles in the Atmosphere." (*Trans. Roy. Soc. Edin.* vol. xxxv. part i.)  
<sup>4</sup> "The Development of the Skeleton of the Limbs of the Horse." (*Journal of Anatomy and Physiology*, January, 1894.)

first report was published in 1891, but neither that nor the one of 1892 contains so much evidence of work done as the bulky tome last issued. The observatory, as it is at present constituted, only dates back to 1889; but previous to that, it passed through so many vicissitudes that a brief outline of its history may be of interest.

It is recorded that an observatory tower was erected by Pope Gregory XIII. in connection with the reform of the calendar, some time previous to 1582. The tower was intended for astronomical observation, and there is every reason to suppose it was the first celestial watch-tower built in Rome. The following translation of an extract from the *Nautica Mediterraena* of B. Crescenzi, published in Rome in 1607, clearly shows that the room at the top of the tower was used for astronomical purposes:—"When the sun arrives at the tropic of Cancer its rays enter a little hole which Ignatius Danti has had made for that purpose in the roof of the apartment which Pope Gregory XIII. had erected upon the Belvedere Gallery, and the rays only enter the hole once a year, when the sun is furthest from the equinox, after which he turns and goes back." Danti appears to have marked a meridian line upon a marble table in the tower, and meridian observations were made until about 1644, but the observatory was afterwards neglected, and remained so for about a century and a half. It was only towards the end of the last century that an attempt was made to renew the astronomical work. Cardinal Zelada had a large meridian circle constructed, and furnished the observatory with some good astronomical instruments, among which was a telescope by Dollond. As the observatory was not available for public instruction, it was decided to establish another at the Roman College, and the new observatory was erected in 1787, though observations had been carried on at the College long before.

In 1789 the Vatican Observatory commenced a new epoch in its history. Philip Gili began his directorship in that year, and, in addition to making astronomical observations, initiated researches in magnetism and meteorology, and other branches of terrestrial physics. The observatory kept well apace with the times until the death of Gili in 1821, but after that it became quite disorganised. All the instruments and records were dispersed, and the observatory itself was entirely deserted until about 1870, when it was transformed into a residence.

Before passing to the third epoch in the "eventful history" of the Vatican Observatory, a few remarks upon the Observatory of the Roman College may be of interest, especially as the relations between the two institutions are not generally well understood among astronomers. According to Father Cortie, who has kindly furnished most of the following information upon this matter, the Roman College Observatory dates back at least to 1572. It belonged to the Society of Jesus, and consisted in the beginning of a few rooms set aside for astronomical studies. Scheiner, of sun-spot fame, Clavius, the author of the Gregorian reform of the calendar and the observer of Tycho Brahe's Nova of 1572, de Gottingues, who observed Jupiter's spots and the comets of 1664, 1665, and 1668, Boscovich, and other renowned astronomers were connected with it. There still exists in the Kircher Museum of the College a meridian line traced by Boscovich, and the same astronomer drew up the plans for a new observatory, but they were never carried into effect, on account of the troubles in France and Spain, during which the Society of Jesus was suppressed. During the period of the suppression, the observatory was directed at first by J. Callandrelli, who in 1773 built a square tower at the eastern angle of the facade of the College, and placed in it a zenith-sector and a meridian circle, the gifts of Cardinal Zelada and Pope Pius VII.



FIG. 1.—Alto-Cumulus.



FIG. 2.—Stratus-Cumulus and Alto-Stratus.



FIG. 3.—Cumulus and Strato Cumulus.



FIG. 4.—Nimbus.

After the restoration of the Society, however, the Jesuits gained possession of this observatory in 1824, and placed it under the direction of Dumouchel. De Vico, whose cometary discoveries and observations of Venus are so well known, was the next director, but with the troubles of 1848 came the expulsion of the Society of Jesus from Rome. De Vico died in London. In 1849, however, Secchi, who made his first observation when an exile at Stonhurst, commenced to carry out the learned Boscovich's plans. The observatory was rebuilt, endowed, and instruments furnished at the expense of the Society of Jesus, and with the generous aid of Pope Pius IX. At the next expulsion of the Society, in 1870, Secchi remained at the observatory at the express wish of the Italian Government. At his death he bequeathed the property of the Society to Father Ferrari, but the Government appropriated the observatory and everything connected with it. Fortunately for astronomy, however, Signor Tacchini was appointed to the directorship of the observatory, and has well sustained its reputation. It may be added that the Observatory of the Capitol, in which Respighi did such good work, was founded by Leo XII., and attached to the University of Rome.

After the Vatican Exposition in 1888, in commemoration of the fiftieth anniversary of the priesthood of Pope Leo XIII., all the instruments and apparatus given by members of the Roman Catholic Church interested in celestial and terrestrial physics were brought together, and it occurred to the managers of the science sections of the Exposition that they would find a suitable home in the old Gregorian tower. The suggestion was warmly approved and carried into effect. Father Denza, a great friend of Secchi's, was appointed the director of the revived observatory, and he began his work in 1889 with a comprehensive programme, which he and his assistants Lais, Andreis, and Mannucci have well carried out. The investigations instituted relate to meteorology, terrestrial magnetism, geodynamics, and astronomy. The building is well situated for meteorological observations; it is equipped with instruments for the continuous record, as well as personal observation, of meteorological data. In terrestrial magnetism, also, instruments are provided for the determination of absolute values and the registration of variations of the usual elements. The chief astronomical engine of research included in the observatory's outfit is a photographic equatorial of the Henry pattern and mounting, for use in connection with the construction of the photographic star-chart which the Vatican Observatory is helping to bring to a successful termination.

Having now described the constitution of the observatory, it remains for us to state the nature of the work done, as evidenced by the reports. The first report contains a long article on the principles and progress of celestial photography, by Father Denza. Father Lais reports the details of stellar photography in connection with the chart, and the methods of obtaining photographic stellar spectra and solar pictures. He also summarises the observations made in Italy during the Perseid shower of August 1890, and during the Leonid shower of the same year.

Sig. Andreis describes the points to be investigated in the geodynamical work of the observatory, and there is a full account of the meteorological instruments and the observations made with them.

When the second report of the observatory was issued, it was seen that Father Denza and his assistants had carried on some useful observations during 1891. The geographical position of the observatory, eclipses of the sun and moon, the Perseid and Leonid meteor showers of the year, formed the subjects of important articles by the Director, while Father Lais and Sig. Mannucci described the work that had been done in celestial photography. Marvellous results were obtained with

the Henry equatorial from the very beginning, and no stronger witness of this is necessary than that afforded by the beautiful plates which embellish the second report. The picture of the Ring Nebula in Lyra is certainly one of the best yet obtained, and that of the star-cluster M 15 is equally good. Other bits of celestial scenery included in the same volume are the Pleiades and neighbourhood, and a cluster in Sagittarius, while individual occupants of the heavens are represented by three portraits of Jupiter and two views of the lunar surface.

We pass now to the report issued in the latter half of last year, and which in point of excellence and abundance of matter even surpasses the one before it. Two remarkably fine portraits are given in this volume, one of Pope Leo XIII., the other of the late Admiral Mouchez; and the astronomical views include the region of Nova Aurigæ, that of the Praesepe cluster, the Orion nebula, and four sun-pictures. But none of these photographs are so striking as the fourteen reproductions of cloud photographs obtained by Sig. Mannucci, and of which we are able to give four specimens. Meteorologists will remember that a set of eighty cloud photographs taken at the Vatican Observatory were shown at the Royal Meteorological Society's Exhibition in 1890. Sig. Mannucci's experience indicates that in cloud photography very short exposures do not give the best results. Plates of medium rapidity, having a thin film, seem to give the boldest contrast between the blue of the sky and the masses of diaphanous haze that are sometimes projected upon it. Such plates also show the greatest amount of detail in large masses of cloud.

Sig. Mannucci gives a brief account of systems of cloud classification in the volume to which reference has been made. He practically accepts the classification proposed by Abercromby and Hildebrandsson at the International Conference held in Munich in 1891, and set forth in the Cloud-Atlas of Hildebrandsson, Köppen, and Neumayer. The classification recognises ten different species arranged in five principal groups. The first group (A) comprises the highest clouds in our atmosphere; the second group (B) includes clouds at a medium height, and the third (C) low clouds. In the fourth (D) we have clouds in ascending currents, and finally, (E) contains the masses of vapour changing in form. In the first four groups the letter (*a*) is used to distinguish the forms of cloud usually accompanied by fine weather, and (*b*) for those characteristic of bad weather. The following is the grouping as given by Sig. Mannucci:—

#### GROUP A.

Clouds from medium altitudes up to an average of 9000 metres.

1. Cirrus (*a*)
2. Cirro-stratus (*b*)
3. Cirro-cumulus

#### GROUP B.

Clouds having altitudes from 3000 to 6000 metres.

4. Alto-cumulus (*a*)
5. Alto-stratus (*b*)

#### GROUP C.

Clouds the bases of which have altitudes from 1000 to 2000 metres.

6. Strato-cumulus (*a*)
7. Nimbus (*b*)

#### GROUP D.

Clouds on ascending columns of air, with bases about 1400 metres high, and summits from 3000 to 5000 metres.

8. Cumulus (*a*)
9. Cumulo-nimbus (*b*)

#### GROUP E.

Fogbanks up to about 1,500 metres.

10. Stratus

We cannot conclude this account without referring to the magnetic work done at the observatory. Father Denza contributes to the third report a long discussion of the magnetic declination and inclination at Rome, and, by a comparison of observations, finds the secular variations. In the latter half of the seventeenth century, the declination was about two and one-half degrees West, and increasing. In 1806, Gili obtained a value of  $17^{\circ} 17'$ , and in 1824 a maximum of  $18^{\circ}$  seems to have been reached. The declination then began to decrease, and its value at the end of 1891 was  $10^{\circ} 45' 35''$ . The first observation of the magnetic inclination at the Vatican was made in 1891. This element had been previously determined, however, in other parts of Italy by several observers. From 1859, when Secchi observed the inclination at the Roman College, up to the present time, the recorded values for various parts of Italy have been fairly numerous. Before 1859, however, very few observations were made. In 1640 an observer gave  $65^{\circ} 40'$  as the inclination at Rome, and Humboldt obtained a value of  $61^{\circ} 57'$  in 1806. Father Denza gives  $58^{\circ} 4' 6''$  as the inclination at the Vatican Observatory in 1891. A number of other matters are discussed in the volumes under notice, and many observations are included, upon which we have not been able to comment in this article. Enough has been said, however, to show that the observatory has furthered investigations in many branches of physical science, and, from the energetic character of the workers, we may confidently expect many more contributions to scientific knowledge.

R. A. GREGORY.

#### NOTES.

THE Bakerian lecture is to be delivered before the Royal Society by Prof. T. E. Thorpe, on the 22nd inst., the subject of the lecture being a research carried out by Mr. J. W. Rodger and himself on the relations between the viscosity (internal friction) of liquids and their chemical nature.

WE are requested to state that Mrs. Tyndall would be much indebted to any correspondents of the late Prof. Tyndall who have preserved his letters, if they would kindly lend them to her for use in the preparation of his biography. Any letters thus lent should be sent to her at Hind Head House, Haslemere, and would be returned safely to their owners.

A HYGIENIC laboratory has been established in the University of Bonn. The new institution will be under the direction of Prof. Finkler. According to the *British Medical Journal*, there is now no university in Prussia without a hygienic laboratory. From the same authority we learn that the Bengal branch of the Pasteur Institute was successfully inaugurated on January 30, in the presence of a large company.

THE Duke of York visited King's Lynn on Friday, and opened a new technical school built by the Corporation at a cost of £3,000.

THE order of S.S. Maurice and Lazarus has been conferred upon Sir Joseph Lister, M. Pasteur, and Prof. Virchow, by the King of Italy.

MR. HENRY O. FORBES has been selected by the Library Committee of the Liverpool Corporation for appointment as Director of the Liverpool Museums.

THE late Dr. J. K. Hasskarl, whose death we announced on January 25, has, says the *Chemist and Druggist*, bequeathed his library to the University of Strassburg, and his herbarium to the University of Leyden.

PROF. BILLROTH died at Abbazia, on February 6, at sixty-five years of age. He principally devoted his attention to military surgery, and published a number of valuable papers on that branch of his profession. It is said that during the last few

months of his life he was engaged in completing a work upon the physiology of music.

WE regret to announce the death of Mr. Peter Redpath, a generous benefactor to science in Canada. Mr. Redpath took an active interest in the McGill College and University, Montreal, and in 1880 built, at his sole expense, a museum in connection with the University. This building, known as the Peter Redpath Museum, is used for the exhibition and study of specimens in geology, mineralogy, palaeontology, zoology, botany, and archæology. In October last, a library, capable of holding 130,000 volumes, and added to the University buildings through the liberality of Mr. Redpath, was opened in the presence of a large and influential gathering. The sums spent in erecting the museum and library are said to amount to nearly £75,000. Mr. Redpath died at Chislehurst on February 1, in his seventy-third year.

PROF. EDMOND FRÉMY died on Saturday, at Paris. We are indebted to the *Times* for the chief points in the following sketch of his career. The son of a professor of chemistry at St. Cyr, he was born at Versailles on February 28, 1814, and after studying with his father, became a teacher at the École Polytechnique. In 1857 he was elected into the Paris Academy of Sciences as successor of Baron Thénard. The amount of Frémy's scientific work is enormous. His first publications date from 1835; they relate to the precious metals, and attracted the attention of the scientific world. His investigations on ozone (in conjunction with Becquerel), on the ammoniacal bases of chrome and cobalt, on fluor spar and the reproduction of minerals, will remain classical. In organic chemistry, also, he made numerous important researches, and as manager of the Saint Cobain Works he superintended the manufacture of soda and sulphuric acid, the tempering of glass and steel, the refining of castings, &c. Not long ago he published, jointly with one of his pupils, M. Verneuil, a work, which was the fruit of years of study, on the artificial production of rubies. He was the author, with Pelouze, of a treatise on chemistry in six volumes, and in 1881 began the publication of a chemical encyclopædia.

IN addition to the names we gave last week, the *Lancet* says that the following are some of the principal delegates who have been appointed to represent the various Governments at the International Sanitary Conference which opened in Paris yesterday. Great Britain: Mr. Constantine Phipps and Dr. Thorne Thorne, C.B., F.R.S. British India: Surgeon-General Cuninghame. France: M. Barrère, M. Hanotaux, Prof. Brouardel, Prof. Proust, and M. Monod. Germany: Herr von Schoen and Herr Mordtmann. Holland: Dr. Ruysch and M. de Stuers. Russia: M. Michel de Giers, together with technical delegates. Austria-Hungary: Count Kuefstein, Dr. Hagel, and Dr. Karliuski. Greece: M. Criésis and M. Vafiades. Italy: the Marquis de Malaspina and Dr. Pagliani. Portugal: M. Navarro. Sweden and Norway: M. Due. Turkey: Tuskan Bey, Nouri Pasha, Boukowski Pasha, and Dr. Haindy Bey. Persia: A delegate yet to be appointed by the Persian Ministry in Paris. Egypt: Achmet Pasha Choukry, M. Mievillie, and Sedky Pasha. The remaining countries—Belgium, Denmark, and Spain—have not yet announced their delegates.

THE Executive Committee of the City and Guilds of London Institute have changed the name of the Guilds Central Institution, in Exhibition Road, South Kensington, to the Guilds Central Technical College.

THE gold medal of the Royal Astronomical Society has been awarded to Mr. S. W. Burnham for his discoveries of binary stars and researches in connection with them. At the annual general meeting of the society, to be held to-morrow, the proposal will be made that henceforth the meetings be held at

4.30 p.m. instead of 8 p.m. At present the Royal Society is the only one that meets at 4.30 at Burlington House.

THE fourteenth general meeting of the Federated Institution of Mining Engineers will be held at Leeds on February 14, and a number of important papers will then be read. Arrangements have been made for visits to works, &c. on the following day.

As an introduction to the summer excursions of the London Geological Field Class, Prof. H. G. Seeley, F.R.S., will deliver a course of four lectures on "The Shaping of the Earth," at Wortley Hall, Seven Sisters Road, beginning on February 22.

WE learn from the *Kew Bulletin* that Mr. W. Lunt has been appointed botanical collector for Kew to Mr. Theodore Bent's expedition to the Hadramant Valley, in South Arabia. The flora is only conjecturally known, and no botanical collections appear ever to have been made in it. The expedition left London on November 24, and is expected to return about April.

THE number of the *Kew Bulletin* for December, 1893, contains an important correspondence between the Colonial Office and the Directors of the Royal Gardens, Kew, on the root-disease of the sugar-cane; and an interesting account, by two of the gardening staff at Kew, of the subtropical horticulture in various gardens in Cornwall.

THE *Botanical Gazette* says that Mr. O. F. Cook sailed on October 25 for Western Africa, to make further observations and collections of the plants of that region, especially of cryptogams. He will be gone a year or more. His former voyage resulted in securing a large amount of botanical material, and the present visit is expected to yield even greater results.

AT the monthly meeting of the Malacological Society of London on January 12, Mr. G. B. Sowerby described a new species of the genus *Verticordia*, to which he gave the name of *V. optima*. The shell, which far exceeds in size and beauty any hitherto known, was taken off Port Blair, at a depth of 188 fathoms. The description and figure will appear in the forthcoming number of the *Proceedings* of the Malacological Society of London.

THE vertical distribution of the British Lepidoptera forms the subject of an article by Mr. W. H. Bath in the January and February numbers of the *Entomologist*. Too little attention is usually given to this interesting branch of entomology, though as a matter of fact vertical distribution is as important as horizontal or geographical distribution, for, as Mr. Bath points out, it not only estimates the affinities existing between the lowland species occurring in this country, and their relations in more elevated areas in the South of Europe, but shows the relationships between our mountain forms and their representatives found at higher altitudes in Alpine regions, and lower in Arctic and sub-Arctic latitudes. And further, vertical distribution gives a better index as to the range of temperature and other climatic phenomena which each species can endure than mere geographical distribution is capable of doing in anything like the same area. Mr. Bath has prepared a list of vertical zones in the British Isles, taking as its basis the divisions defined by the Brothers Speyer in their work on the distribution of Swiss and German Lepidoptera. His proposed list contains five zones, viz. the South Coast zone, the Lower Hill zone, the Upper Hill zone, the Lower Alpine zone, and the Upper Alpine zone. The limitations of these zones are fully described, besides being presented in a tabular form, so that any entomologist who desires to take up this mountaineering branch of his science will find that Mr. Bath has considerably smoothed the way of observation.

THE *Geographical Journal* for February contains a note of a journey up the Cross River, made by Sir Claude Macdonald, the Commissioner for the Niger Coast Protectorate. Since 1842 no vessel larger than a canoe had gone up the river as far as the rapids, but the stern-wheeler *Beecroft*, navigated by Captain Dundas, met with no difficulty, and in her Sir Claude passed the rapids, and would have gone on to some high falls spoken of by natives, but the rainy season was almost over, and the river beginning to fall so rapidly that he had to return. The natives met with were friendly and anxious to have regular communication on the river.

WE have received a pamphlet from Mr. Robert Stein, setting forth his plan for the exploration of Ellesmere Land in a concise and practical form. His expedition is undertaken with the cordial approval of the National Geographic Society of Washington and of many of the leading British and American Arctic explorers. Mr. Stein retains full liberty for his conduct of the expedition, but is aided in organising it by an advisory committee consisting of Commodore G. W. Melville, Dr. T. C. Mendenhall, General Greely, and Mr. John Joy Edson, who acts as treasurer. The expedition is estimated to cost only 10,000 dollars, a large part of it being subscribed by the members already appointed, while the remainder was nearly made by private subscriptions. The proposed method of working bears every mark of having been carefully thought out. Twenty-two men at most will take part in it, and they will leave St. John's, Newfoundland, about May 1, 1894, in a whaler, which will land them at Cape Tennyson, in Ellesmere Land, or as near that point as possible. A house will be erected, provisioned for two years, and left in charge of four men. Eight men will follow the coast of Ellesmere Land westward, and establish an advanced depot about 100 miles from the base, and then make an attempt to reach Hayes Sound. A thorough search will be made eastward along the coast by a party of six for the missing Swedish naturalists Bjorling and Kalstennius. The whole party intended to spend the winter of 1894 at the base, where continuous meteorological observations will be carried on, and in the spring of 1895 they will endeavour to extend the exploration as far as Greely fjord, but will make their way by the end of September to Cape Warrender, on Lancaster Sound, where four men will be left at a depot in 1894 to await them. A whaler will meet them there by appointment, and bring the expedition back to Scotland or Newfoundland. Careful scientific observations will be made throughout, and collections in all departments of natural history are arranged for. Over sixty men had volunteered for the expedition up to January 9; of these, thirty were found to be suitable, but only three had been definitely engaged. The estimate of 10,000 dollars provides only for a party of ten; in order to establish the reserve station at Cape Warrender, and to search properly for the lost Swedes, a further sum must be raised. Should the first expedition prove successful, Mr. Stein's larger scheme of Arctic exploration will probably be proceeded with on his return.

IN the *Geological Magazine* for February, Miss M. M. Ogilvie continues her paper on "Coral in the 'Dolomites' of South Tyrol." The article is illustrated by a fine map and sections of the district discussed. Miss Ogilvie's conclusion with regard to coral formations in the dolomites strengthens "the position of those authorities who have contended that the immense thicknesses of 'Schlern Dolomite' rock were an ordinary marine deposit and not 'coral-reefs.'"

THE discovery of petroleum on the Mendip Hills has recently been announced. A well at Ashwick Court, two miles north of Shepton Mallet, has long been known to yield water slightly flavoured at times with petroleum. A considerable flow

of oil is said to have taken place in July, 1892, when the water-level was low, and this has continued at intervals, but in smaller quantities, since that date. Ashwick is shown on the Geological Survey map to stand at the northern edge of the carboniferous limestone: the beds have a high dip to the north, passing under the millstone grit and the coal-measures of the Radstock area. Indications of petroleum are also known in other wells and springs in the neighbourhood. The matter is now being investigated by Mr. Boverton Redwood and Mr. W. Topley, under whose directions further explorations will be made.

THE phosphatic marls of New Jersey have long been known; they have been worked for fertilisers since 1768. Mr. W. Bullock Clark has published a paper "On the Cretaceous and Tertiary Formations of New Jersey." (Ann. Rep. of the State Geologist, 1892.) The origin of a glauconitic greensand is fully discussed, and reference made to recent deep-sea research. Coloured reproductions are given of Murray and Renard's plates in the *Challenger* Expedition Report, exhibiting phases in the formation of glauconite. The greensands occur most commonly near the boundary lines between the shallow and deep-water zones, but not opposite the mouths of large rivers, nor where strong currents prevail. In making the detailed survey in New Jersey, a small boring apparatus has been used, which seems, from the description given, to be simpler and more portable than that employed on the Belgian and English surveys. It is made of half-inch gas-piping, in lengths of 10 feet. This gives good results to a depth of 30 feet.

MR. CLARK'S paper is further illustrated by prints from photographs. Some of those, e.g. "View among the Navesink Highlands," suggest nothing so much as an ultra-"impressionist" daub, all blur and no colour! The professional photographer complains of the hypercritical eye of his fair sex constituency; one could wish that nature had a word to say for herself. The photographic camera is fast coming to be considered part of the equipment of the geologist. If men, whose movements in the field are already well burdened by hammer, compass, knapsack, and specimens, are willing to add to those the inconvenience of a camera, there must be great advantage to be got from photography. But what advantage will be derived from an occasional lucky hit? It would be difficult to name the science now that does not utilise photography. Clearly the time has come when another "optional" may be added to the subjects of the complete curriculum. At any rate, science must recognise photography at its professional value, and must refuse bad photographs and worse prints.

FOR some time past the United States Hydrographic Office has been collecting information about the meteorology of the North Pacific Ocean, with the intention of utilising it for the benefit of seamen, and it has recently issued an advance Pilot Chart of that ocean for the month of January, 1894, on the same principle as the Pilot Chart for the North Atlantic Ocean, which has often been referred to in our columns. The hydrographer states that, if Congress grants the necessary funds, it is proposed to issue on the first day of each month a chart showing for the succeeding month, by deduction from accumulated observations, the winds and currents to be expected, the regions of prevailing fog and rain, the most advantageous routes to be followed by sail and by steam, &c. The amount of information available for the Pacific is greatly inferior to that for the Atlantic, but if the support and cooperation sought for are freely given by those interested in enhancing the safety of navigation, the undertaking will undoubtedly become a very valuable contribution to maritime meteorology.

M. H. PARENTY has been investigating the forms of steam jets from various orifices, and has published his results in the

last number of the *Comptes Rendus*. The diagrams accompanying the paper, in which regions of different pressures are shaded differently, exhibit some curious fluctuations, which may be described as a series of nodes and ventral segments proceeding outwards from the orifice. These fluctuations are due to the interference between the outgoing waves of steam pressure and those reflected back by the air. In the case of a convergent elliptical orifice of 13, three nodes were found with pressures of 115, 165 and 138 c.m. respectively, that at the orifice being 285 c.m. or 3.75 atmospheres. All the nodes occurred within 2 c.m. of the orifice. They were found by means of an air-manometer provided with very finely-drawn glass tubes. It appears that the position and value of the nodes or condensations depend upon the difference of pressure between the boiler and the atmosphere, and the form of the orifice. At very high pressures the jet assumes an approximately paraboloidal shape, such as would be assumed by a liquid jet falling upon a disc of the size of the orifice. A further conclusion reached by M. Parenty is that the highest attainable velocity of efflux is the limiting velocity of sound in the medium concerned.

THE curious polarisation phenomena obtained with very small electrodes in a sulphuric acid voltameter through which a strong current passes, accounts of which have appeared in *Wiedemann's Annalen* for the winter of 1892, suggested to Dr. L. Arons the question as to what would take place at a very thin and small metallic partition in a voltameter. Some preliminary observations made by Dr. Arons showed that when a piece of gold-leaf was pasted over a hole 15 mm. in diameter bored through a glass partition in a voltameter, there was no visible development of gas at the partition; while with platinum foil .02 mm. thick there was a profuse development of gas with the same current strength. A very thorough investigation of the polarisation phenomena upon thin metal partitions has been carried out by Mr. John Daniel, an account of which is published in the *Philosophical Magazine* for February. The author has examined partitions made of gold, platinum, silver, and aluminium, and finds that, in good conducting solutions of sulphuric acid, copper sulphate, and common salt, the critical thickness, below which there is no polarisation, is for gold between .00009 mm. and .0004 mm., while for plates more than .004 mm. thick the polarisation is as great as for very thick plates. The author finds that the polarisation of "thick" plates is about the same for all currents between 0.2 ampere and 0.01 ampere, provided time be allowed in each case for the current to become constant. With "thin" plates, however, the polarisation depends upon the current. By thick plates we mean those with a thickness greater than 0.004 mm., and by thin plates those having a thickness less than this quantity.

THE same number of the *Philosophical Magazine* contains a paper by Mr. W. H. Steele, on the thermoelectric diagram for some pure metals. From some thermoelectric observations he had made, the author was led to suspect that the lines given by Prof. Tait in his thermoelectric diagram were not quite accurate, and he has therefore undertaken the measurements necessary to construct a diagram, using metals in as great a state of purity as possible. The metals used are aluminium, tin, lead, zinc, thallium, silver, gold, copper, cadmium, and antimony. The electromotive force for a temperature difference of about 100° C. was in each case compared with that of a standard Clark cell made according to Lord Rayleigh's instructions.

THE distribution of zymotic disease by sewer air is a question still *sub judice*, and in order to throw, if possible, some additional light on the subject the London County Council asked Mr. Laws to make some investigations on the air in some of the London sewers. The report has recently been presented and published. The principal experiments were made in a sewer run-

ning under the Green Park, and constructed some 120 years ago, and presumably having had ample opportunity for getting thoroughly contaminated. The percentage of carbonic acid gas present was estimated, and especial attention was given to the microbial contents of sewer air. For the detection of the latter Prof. Percy Frankland's method (*Phil. Trans.* 1887) was employed, and it is to be regretted that as this process enables large volumes of air to be sifted for micro-organisms in a short time, Mr. Laws did not examine more than ten litres. The results recorded confirm those obtained by previous observers, *i.e.* that sewer air contains generally very few organisms, and, as a rule, less than the air outside. Dr. Petri's observations on sewer air are not mentioned, but they are worth quoting, for he examined 100 litres of air in a Berlin sewer, and found on one occasion no organisms at all; and in another experiment only one bacterium and three moulds. It would appear, therefore, that drain air as regards freedom from microbes is very frequently superior to that which we inhale in our houses, and compares especially favourably in this respect with the air in crowded reception-rooms. Mr. Laws, however, concludes his report by remarking that although the organisms in sewer air do not probably constitute any source of danger, the latter may contain some highly poisonous chemical substance which may produce a profound effect upon the general vitality. But everyone agrees that sewer air is not a desirable addition to the atmosphere either of our streets or houses.

THE *Midland Naturalist* has ceased publication, owing to lack of support, after sixteen years' existence.

AMONG the papers in the *Actes de la Société Scientifique du Chili*, vol. iii. 1893, is one on the Coleoptera of Chili, by M. P. Germain, and another containing a description of a new method of determining the orbits of planets and comets, by M. A. Obrecht.

THE *University Correspondence College Calendar* (1893-4) has just been published. It contains answers to the questions set at the Matriculation Examination of last month, and articles on the special subjects for June, 1894, and January and June, 1895.

MR. R. H. SCOTT, F.R.S., has prepared an abridgment of his "Elementary Meteorology," in the form of a little book containing five hundred questions and answers on meteorology. The book, which is published by Messrs. Williams and Strahan, will be found useful to teachers and others.

ANOTHER of the Alembic Club Reprints (No. 5) has been published by Mr. W. F. Clay, Edinburgh. The volume contains extracts from the *Micographia* of Hooke (1665), and a specially interesting paper in which his views on combustion are explained.

MESSRS. NALDER BROS. AND CO., Red Lion-street, Clerkenwell, have issued a price list of electrical testing, mathematical, optical, and other scientific instruments manufactured by them. The catalogue is very well illustrated, and each article named in it is given a telegraphic code word, so that in ordering any piece of apparatus it is simply necessary to transmit to the makers the code word allotted to it.

THREE representatives of the Lancashire County Council Technical Instruction Committee visited, last year, some of the chief continental schools which give technical instruction in horology, the silk industry, and mining. As a result of the inquiry a report has just been issued, in which the deputation recommends the establishment of schools in which all these subjects are thoroughly taught.

THE *Quarterly Journal of the Geological Society* (No. 197) contains, in addition to eight papers, eight plates illustrating

the work of Mr. Rutley on the "Sequence of Perlitic and Spherulitic Structure," of Mr. E. A. Walford on "Inferior Oolite Bryozoa from Shipton Gorge, Dorset," and "Cheilosomatous Bryozoa from the Middle Lias," and of Dr. J. W. Evans on the "Geology of Matto Grosso, Brazil."

AN entirely new edition (the seventeenth) of "Johnston's Elements of Agricultural Chemistry" has been published by Messrs. W. Blackwood and Sons. Prof. C. M. Aikman has revised the whole of this well-known text-book, rewritten large portions of it, and added new matter, so as to bring the work up to the present position of agricultural chemistry. The fact that the book has survived unto the seventeenth edition is sufficient evidence of its usefulness.

A SERIES of coloured botanical diagrams, suited for class teaching, has been published by the Society for Promoting Christian Knowledge. The plants selected are chiefly indigenous, and the leaf, blossom, parts of the blossom, husk, and seed of each are very clearly shown in a greatly enlarged form. The diagrams thus exhibit to students the characteristic parts of plants, and will doubtless facilitate the study of some common specimens.

"A TEXT-BOOK of Solid or Descriptive Geometry," by Mr. A. B. Dobbie (Blackie and Son), is a little book possessing many good points, and one upon which great pains have evidently been spent. There are about 350 diagrams in the book, all of which have been carefully designed by the author. The diagrams and explanatory text are both extremely clear, and the problems well arranged. Elementary courses in plane geometry and graphic arithmetic are included, and add to the value of a book which we confidently recommend to the notice of teachers.

THE first part of the volume of the Proceedings of the Congrès International de Zoologie, held at Moscow during August, 1892, was reviewed in NATURE of January 5, 1893. The second part has just been published, and is of equal excellence with the one that preceded it. The volume contains thirty memoirs, occupying 287 pages altogether, and a supplement of 83 pages is devoted to the second report of Prof. Blanchard on the nomenclature of organisms. Prof. Blanchard presented his first report upon this subject to the International Zoological Congress that met at Paris in 1889.

THE first edition of "Electricity in the Service of Man" (Cassell and Co.) was published in 1888. Two years later a second edition appeared, and the third is now before us. The work has been revised and enlarged by Dr. R. M. Walmsley, and it has certainly benefited by his changes. Some 120 pages of the second edition have been excised, and new matter covering more than 200 pages has been inserted. It would be tedious to enumerate the numerous additions that have been made, both in the theoretical and technical sections of the subject. Suffice it to say that Dr. Walmsley has brought the book well up to date, and has largely increased its value by a thorough revision.

THE *Irish Naturalist* for February contains a list of all the known additions to the flora of the north-east of Ireland (except Musci and Hepaticæ) since the publication in 1888 of Stewart and Corry's work upon that subject. The list also embodies additional localities for many of the rarer species. Dr. Scharff concludes a paper on the Irish wood-lice, in which he gives descriptions of all the British species. Miss S. M. Thompson sets up a plea for Irish glaciology, and the Rev. Hilderis Friend describes a new Irish earthworm.

AN admirable review of the rapid progress which has been made during the last few years in the new domain of stereochemistry, which deals with the spacial arrangement of the



atoms which compose a chemical molecule, is contributed to the *Chemiker Zeitung* by Prof. Victor Meyer. The literature of this most interesting branch of chemical study has so rapidly accumulated since the theory of Le Bel and Van't Hoff was promulgated in the year 1874, that a concise account of the important stages of progress which have led up to the present state of our knowledge is particularly welcome. The earlier portion of the memoir is devoted to the development of the idea of the asymmetric carbon atom, and the growth of the conviction that the occurrence of isomeric compounds represented by the same constitutional formula—which differ only in their action upon polarised light, and very slightly in other physical properties, such, for instance, as the three lactic acids—could only be accounted for by the different spacial arrangement of the atoms in the molecule. The fundamental assumptions of Van't Hoff are very clearly expressed, and the possibilities of isomerism by change in the relative positions of the various groups attached at the four corners of the hypothetical carbon tetrahedron are fully illustrated. A striking example is afforded in this connection by one of the results of the brilliant researches of Emil Fischer in the sugar group, whereby we are made acquainted with no less than thirteen distinct sugars, all of which are represented by the same constitutional formulæ  $\text{C}_6\text{H}_{12}\text{O}_6$ ,  $(\text{CHOH})_4$ ,  $\text{CH}_2\text{OH}$ . The second section is devoted to the stereo-isomerism of the derivatives of ethylene, so ably worked out by Wislicenus. The simple explanation of the remarkable and long-discussed case of the isomeric acids, maleic and fumaric, upon the lines of the new theory, is referred to, and a similar explanation extended to numerous other and more complicated of the derivatives of ethylene. The third section deals with the peculiar nature of the stereo-isomerism of closed-chain compounds, such as the polymerised tri-aldehydes. It is then shown in a further section that carbon is by no means peculiar in lending itself to stereo-isomerism, but that the pentavalent nitrogen atom is likewise capable of furnishing isomers which differ structurally merely in the relative positions occupied by the five attached atoms or groups. The stereo-isomerism of nitrogen compounds is shown, however, to be largely influenced by the weight and complexity of the five attached groups. The interesting discovery of a second di-oxim of benzil by Goldschmidt in Prof. Meyer's laboratory, gave a great impulse to the study of nitrogen compounds containing the group  $\text{C} = \text{N}$ , termed oxims, and the number of stereo-isomeric oxims which have subsequently been isolated bear remarkable testimony to the use of a theory in stimulating research.

THE additions to the Zoological Society's Gardens during the past week include two Swainson's Lorikeets (*Trichoglossus nova-hollandiæ*) from Australia, presented by Mr. John Biehl; a Chilean Conure (*Conurus smaragdinus*) from Chili, presented by Mrs. Gibney; two Eyed Lizards (*Lacerta ocellata*) twenty European Tree Frogs (*Hyla arborea*) South European, presented by Mr. T. Keen; a Madagascar Porphyrio (*Porphyrio madagascariensis*) from Madagascar, a Waxwing (*Ampelis garrulus*), two Long-tailed Tits (*Parus caudatus*) European, purchased; and a Hog Deer (*Cervus porcinus*) born in the Gardens

#### OUR ASTRONOMICAL COLUMN.

ECLIPSE METEOROLOGY.—A very extensive series of meteorological observations was made during the total eclipse of the sun on January 1, 1889, at Willows, California. It appears that the temperature fell  $6^\circ \text{F}$ . from the commencement of totality to ten minutes after, while the variation of the barometer was so nearly identical with the daily fluctuation that no effect could with certainty be ascribed to the eclipse. The influence on the wind, however, was very marked, its previous velocity of twelve miles per hour being reduced almost to that

of a calm. Observations with the solar radiation thermometer showed that some heat was received throughout totality. An attempt was also made to secure concerted observations of the so-called "shadow bands"—the long dark bands separated by white spaces which are seen in rapid motion on the ground and sides of buildings just before and after totality. The observations collected seem to give decisive evidence against the view that the bands are diffraction fringes in the shadow of the moon, the observed velocities being far less than that of the shadow; the fact that they were prominently seen at some stations, while at others they were hardly visible, indicates a local origin (*Ann. Harvard. Coll. Obs.* vol. xxix.).

In the same volume, Mr. Parkhurst gives an account of his photometric observations of some of the asteroids, and confirms the previous conclusion that there is a phase correction over and above that for the defect of illuminated surface, and that this correction is different for different asteroids; the idea that large errors may be introduced by rotation, however, is not confirmed. The same writer also gives the individual observations of a large number of variable stars, which furnish valuable data for the construction of light-curves.

A REMARKABLE COMETARY COLLISION.—Two striking photographs are reproduced in the February number of *Knowledge*, in illustration of an article, by Prof. E. E. Barnard, on the probable encounter of Brooks' Comet with a disturbing medium on October 21, 1893. The comet was discovered by Mr. Brooks, on October 16, but though it was kept under observation at the Lick Observatory, no phenomena of an extraordinary kind were observed until the 21st of that month. A photograph, then taken with a Willard photographic lens, presented a remarkable appearance, the tail appearing, to use Prof. Barnard's analogy, like a torch streaming in the wind. The reproductions of the photographs give the impression that the comet's tail swept into some dense medium, and was broken up by the encounter. Indeed, Prof. Barnard thinks it impossible to escape the conclusion that the tail did actually enter a disturbing medium which shattered it. This theory is supported by the photograph taken on October 22, where the tail is seen to hang in irregular cloudy masses, and a large fragment appears to be entirely separated from the main part. There is little doubt that the tail met a mass of meteoritic matter, and so had its symmetry destroyed; at any rate, this supposition must be accepted until a simpler and better one can supplant it. What we have to do, as Mr. Cowper Rayard remarks in an article on the irregularities of comets' tails, is diligently to collect facts. The multiplication of such photographs as those obtained of Brooks' Comet, and of Swift's Comet (1892), by Prof. Barnard, will certainly revolutionise current opinion as to the development, and the types, of comets' tails.

MIRA CETI.—According to the *Companion to the Observatory*, this famous variable star will reach a maximum about the 17th inst. At the time of writing (February 3), the star is of a reddish tinge, and faintly visible to the naked eye; but, unfortunately, it is too near the sun to permit of long-continued observations on the same evening. The magnitude at maximum is very inconstant, and varies between 1.7 and 5.0 (Gore). Spectroscopic observations of the star are of the highest importance, and it is to be hoped that a satisfactory record of its phases will be secured. The general spectrum is one of Group II., but near a former maximum, Pickering photographed a number of bright lines, chiefly of hydrogen. Among the points on which information is desirable are: (1) at what phase of the variation the bright lines of hydrogen make their appearance; (2) the fluctuations in the bright flutings of carbon observed by Mr. Lockyer at the maximum of 1888 (*NATURE*, vol. xxxviii. p. 621).

PROPER MOTIONS OF STARS.—The recently published volume (xxv.) of the *Annals of the Harvard College Observatory* contains values for the proper motions of a large number of stars in the zone  $50^\circ$ — $55^\circ$  north, the adopted values, however, being only at present regarded as provisional. The results are derived by Prof. Rogers from the comparison of his own positions for the stars in this zone, obtained with the meridian circle, with the positions given for corresponding stars by earlier catalogues. One section of the volume gives the values of  $a$  and  $\delta$ , referred to the system of the *Astronomische Gesellschaft*, for the stars included in the zone in question.

THE SYSTEM OF ALGOL.—An elaborate discussion of the inequalities in the period of Algol recently led Mr. Chandler to

conclude that there is a distant dark body around which the bright star and the dark companion producing eclipses revolve in a period of 130 years (*NATURE*, vol. xlv. p. 446). This conclusion has been greatly strengthened by recent investigation by Mr. Searle, of the relative places of Algol and comparison stars from observations made with the meridian circle at Harvard College (*Annals*, vol. xxix. 1893). The right ascension of the star appears to be increasing in general conformity with Chandler's prediction.

### THE INSTITUTION OF MECHANICAL ENGINEERS.

THE forty-seventh annual general meeting of the Institution of Mechanical Engineers was held on the evenings of Thursday and Friday of last week, in the theatre of the Institution of Civil Engineers. There were two papers down for reading, as follows:—

“Research Committee on Marine Engine Trials. Abstract of results and experiments on six steamers, and conclusions drawn therefrom in regard to the efficiency of marine engines and boilers,” by Prof. T. Hudson Beare.

“Description of the Grafton High Speed Steam Engine,” by Edward W. Anderson, of Erith.

The reading and discussion of Prof. Beare's paper, together with the introductory proceedings, occupied both evenings, so Mr. Anderson's paper had to be adjourned until next meeting.

Upon the members assembling on Thursday evening, the 1st inst., the President, Dr. William Anderson, took the chair. Mr. Bache, the secretary, then read the annual report of the council, by which it appeared that the Institution continues to flourish, the income and membership having increased during the past year. After the reading of the report Dr. Anderson vacated the chair, his term of office of two years having expired, and the new President, Prof. Alexander B. W. Kennedy, F.R.S., was duly installed. After the usual votes of thanks, and a few complimentary speeches, the reading of Prof. Beare's paper was proceeded with.

As our readers are aware, the Research Committee on marine engine trials of this Institution has been for some time past engaged in making trials with different steam vessels. The reports of the committee on these trials have already been referred to in our accounts of former meetings of the Institution at which they have been read. Six vessels have been experimented upon altogether since the committee was formed. These ships have consisted of channel passenger vessels and cargo boats, the committee not having had yet an opportunity of experimenting upon an important ship of the ocean liner type.

The labours of the committee have been brought to a conclusion, for the present at any rate; and the paper of Prof. Hudson Beare was intended to give a summary of the results, and afford a basis of discussion thereupon. We are at a loss how to condense within the compass of space at our disposal the mass of data dealt with by the author of the paper. Perhaps the most lasting impression on one's mind, after going through the subject, is that no general conclusions, that can be compactly expressed, are to be drawn from the trials. The conditions of work required from marine engines in ships of different classes are so various that what is paramount virtue in one case becomes an unnecessary refinement in another. Thus in the cargo boats the first consideration is economy in fuel, to which nearly every other feature in the machinery is usually sacrificed. In order to carry cargo at a rate sufficiently low to enable the shipowner to compete, the coal bill must be light, and therefore we find in these vessels boilers lightly worked and speeds low. On the other hand, vessels that have to convey passengers must be speedy, and general economy has to be sacrificed to this end, the model of the vessels themselves being formed with the same purpose in view. Perhaps we cannot do better than quote some of the elements of design of the machinery, and some of the results attained during the trials, in order to illustrate these leading facts. We will take two of the ships tried—the *Iona*, a large cargo boat, and the *Ville de Douvres*, a paddle boat carrying mails and passengers between Dover and Ostend. The *Iona* is 275 feet long, 37.3 feet wide, 27 feet  $\frac{7}{8}$  inches draught, and 4430 tons displacement. Her speed on trial was 8.6 knots. The *Ville de Douvres* is 271 feet long, 29 feet wide, 9 feet draught,

and 1090 tons displacement. On her trial she made 17.1 knots. It will be seen, therefore, that the cargo boat is considerably over four times the displacement, and travels at about one-half the speed of the mail boat. As both craft are approximately the same length, the additional size and weight-carrying capacity of the *Iona* is made up by her greater beam, and also by her fuller ends. The engines of the *Iona* are of the three-stage compound, popularly, but erroneously, known as triple expansion engines. As a matter of fact the *Iona's* engines are 19-expansion, the steam being expanded nineteen times in passing through the three cylinders. The *Ville de Douvres* has ordinary two-cylinder compound engines, in which the steam is expanded but 5.7 times. The horsepower required to drive the 4430 tons of the bluff-ended *Iona* through the water was but 645.4 indicated, whilst the *Ville de Douvres*, modelled for speed, required 2977 indicated horsepower to enable her to get her 17 knots. Supposing each unit of power to be obtained in both ships at an equal expenditure of fuel, the figures quoted will show the price that has to be paid for speed; but there is a further item to the debit side of the coal bill in the case of the fast ship. In order to get high speed it is very desirable, indeed necessary, that machinery should be light, and light machinery, other things being equal, means a low figure of merit in regard to fuel economy. The *Iona* works, as stated, with 19 expansions, her boiler pressure being 165 lbs. above atmosphere; whilst the *Ville de Douvres* has boilers pressed only to 105 lbs. The result of this greater expansion of steam on the part of the cargo boat's engines, and the easy way in which her boilers are worked, enables each unit of power to be obtained on a consumption of 1.46 lbs. of coal per hour; whilst the *Ville de Douvres* required 2.32 lbs. of coal for each indicated horse-power exerted for an hour.

It is easy to see from these figures, which are fairly representative, that economy and speed cannot go hand in hand: the owner must select whether he would rather travel cheaply (in fuel) or quickly.

Pursuing the investigation of this branch of the subject, we find that the total weight of the machinery of the *Iona* is 202 tons, which gives 3.1 units of power per ton weight of machinery; whilst the total weight of the machinery of the *Ville de Douvres* was 361 tons, equal to 8.2 units of power per ton weight of machinery. With regard to space occupied, the engines of the two ships are not comparable, being paddle and screw engines respectively: but in boilers we find that the net volume required for each indicated horse-power with the *Iona* was 4.15 cubic feet, and with the *Ville de Douvres* 2.09 cubic feet; thus showing that space as well as weight may be gained by the sacrifice of fuel economy. In the discussion which followed the reading of the paper, Mr. Jeremiah Head, of Middlesborough, gave some interesting figures in regard to those cargo steamers generally known as “ocean tramps.” He stated that the s.s. *Westoe*, a vessel of this class, had carried 3500 tons dead weight at a speed of 9 knots, the fuel burnt being at the rate of 64 oz. per ton per nautical mile, or about one five-hundredth of a penny. Another ship, the *Oscar II.*, of 4600 tons dead weight capacity, required a consumption of half an ounce of coal per ton per mile. Still another vessel steaming at 8.9 knots showed a similar fuel economy. The figures are striking, and easily remembered: half an ounce of coal for each ton carried one nautical mile.

The boilers of both the *Iona* and the *Ville de Douvres* are of a similar type, being the ordinary return tube marine boiler, but the proportions are somewhat different. Thus in the *Iona* the proportion of total heating surface to grate surface is 75.2 per cent; in the *Ville de Douvres* it is but 31.1 per cent. This large extension of the heating surface means both a heavier and more bulky boiler, as has been shown; but in the cargo boat this sacrifice of weight and space can be profitably made in order that the fullest amount of heat from the products of combustion may be absorbed by the water in the boiler. In the *Ville de Douvres* this heat is allowed to pass off by the chimney. If we turn to the record of funnel temperatures we find this fact borne out, the escaping gases in the *Iona* being 452° F. and in the *Ville de Douvres* 910° F., as far as could be ascertained. The coal consumed on a given area of grate in the two vessels does not vary greatly, it being 22.4 lbs. per hour in the *Iona*, and 31.3 lbs. per hour in the *Ville de Douvres*. The different proportions of grate to heating surface in the two ships will, however, be

remembered. If we turn to the coal burnt per hour per square foot of heating surface we find it but 0.298 lbs. in the *Iona*, and 1.01 lbs. in the *Ville de Douvres*. With regard to evaporation, each square foot of heating surface in the *Iona's* boilers turned 2.73 lbs. of water into steam per hour; in the *Ville de Douvres* the corresponding figure was 9.02. The feed-water evaporated per lb. of fuel was 9.15 lbs. in the *Iona*, and 8.97 lbs. in the *Ville de Douvres*. Taking carbon values—that is, excluding incombustible ash—and reducing the results to an equivalent of evaporation from and at 212°, we find the corresponding figures to be 10.42 lbs. for the *Iona* and 9.94 lbs. for the *Ville de Douvres*, a by no means bad result for the latter vessel's boilers, considering the demand made upon them in other respects.

Turning to the engines of these two ships, we find that the efficiency of the *Iona's* engines was 17.1 per cent., whilst the *Ville de Douvres's* engines had an efficiency of 11.7 per cent. The weight of steam used in the main engines of the former vessel was 13.35 lbs. per indicated horse-power per hour, whilst in the *Ville de Douvres* there were required 20.77 lbs. of steam to produce one unit of power.

The figures we have quoted will be sufficient to give an idea of the scope of the paper. We have not space to go into the discussion upon the various causes of the variations in results; for these we must refer our readers to the Proceedings of the Institution, where also will be found an account of the long and interesting discussion which followed the reading of the paper.

The summer meeting will be held this year in Manchester, at the beginning of August.

ON THE MOTION OF BUBBLES IN TUBES.

EVERY student of physics has observed the motion of bubbles in tubes. Which of them has not used a big bubble to show the little ones their duty in clearing out the air when filling a barometer tube? Who has not spent his time and patience in whisking a spirit thermometer to drive a bubble out of the column? Mr. Trouton has recently communicated to the Royal Society the result of some researches on this subject. He has studied the behaviour of big bubbles and of little ones, of bubbles in large and small tubes, of bubbles of air in a liquid, and of one liquid in another, of bubbles in heavy and in light liquids, of bubbles in liquids of various degrees of viscosity and with various degrees of surface tension at their surfaces. From this enumeration it is evident that the number of different magnitudes involved is very great, and at the start it seemed almost hopeless to disentangle the effects due to each. The first matter to observe was that, as in other cases of fluid motion, two cases must be distinguished. These are the cases of slow motion and of quick motion. When the motion is slow the viscosity of the liquid causes the flow to be very simple. It entirely stops all whirling and swirling, such as is seen in the water behind a boat. When the motion is quick, on the other hand, the flow is very complicated. Whirls and swirls are set up, and the resistance is increased, owing to the increased energy that has to be communicated to the whirling and swirling liquid for each centimetre that the bubble moves. The slow kind may be described as viscous flow, and the quick as turbulent flow. The most interesting point observed in connection with the turbulent flow was that it was sometimes possible to *increase* the rate of flow by *increasing* the viscosity. Increasing the viscosity of a liquid generally makes it flow more slowly, but in some critical cases the increase of viscosity may produce more effect in decreasing the turbulence than in increasing the viscous resistance, and the result is to, on the whole, reduce the combined resistance so that the bubble moves more rapidly in the liquid of greater viscosity. Another matter that was of interest was the question of the size of the bubbles, and how it affected their rate of motion. Very long bubbles moved all at nearly the same rate, but short bubbles had a great variety of rates. Very small bubbles ran along ever so fast, while ones only a little larger went very much more slowly. These latter blocked up the tube much in the same way that a crowd blocks its own egress through a doorway. However, bubbles a little larger seemed to have more sense, for they shape themselves into a sharpish head, with the result that they can make their way along the tube more rapidly than smaller ones. Those a little larger again take up a dumb-bell sort of shape, and block the tube, and go more slowly again, though not so slowly as the

smaller blocking bubbles. A little larger go somewhat more rapidly again, but as the bubbles are made longer the differences between the rates of the quick and slow sizes become rapidly less and less until pretty soon all go at the same rate, no matter how long they are. This alternation of speeds is evidently connected with the ripples that are formed at the head of the bubble as it passes through the liquid, much as a stick moving through water makes a series of ripples upon the surface. If the ripples are so long that the bubble has a pointed head it goes fast, if it has a blunt head it goes slowly. These ripples are in some cases very marked. Mr. Trouton found that when a bubble of oil was allowed to rise through water with which one fifty-thousandth part of caustic soda was mixed the ripples became quite a feature of the figure of the bubble. They at first extended as a series of rings round it, which, however, soon coalesced into a spiral wave, when the bubble rose rapidly through the liquid with a sort of corkscrew motion. If the tube were inclined the ripples were only formed on the lower surface of the bubble, the top surface floating up against the containing tube, and the ripples then looked like the feet of a caterpillar walking up the tube. This is not the only case in which surface tension motions simulate muscular actions, and it is an important question whether some of these actions are similarities or simularities.

The surface tension between the air and liquid if the bubble is an air bubble, and between the two liquids if the bubble is a liquid one, has a very important bearing on the rate of motion of the bubble, for it is owing to this surface tension that the bubble swells out and presses against the sides of the tube. In consequence of this, when the surface tension is large the bubble moves more slowly than with a small surface tension. It would take too long to explain all the considerations by which Mr. Trouton was led to conclude, by the dimensions involved, that the velocity could be expressed in a series of powers of  $S/g\delta D^2$  when S is the surface tension, g the acceleration of gravity,  $\delta$  the difference of density of the liquid and bubble, and D the diameter of the tube. This series is multiplied by  $\mu/g\delta D^2$  where  $\mu$  is the viscosity of the liquid. Two assumptions are made. First, that the viscosity of the material of which the bubble is made is negligible; and secondly, that the motion produced by the surface tension is negligible compared with the motion produced by gravity. The series he gets from his experiments represents the results as accurately as can be expected, considering that the bubbles varied in density from air to mercury, the viscosity of the liquid from 1 to 833, and the surface tensions from 2 to 370. The series Mr. Trouton gives for calculating the time, T, a bubble takes to move one centimetre is

$$T = \frac{A_1\mu}{g\delta D^2} + \frac{A_2\mu S}{g^2\delta^2 D^4} + \frac{A_3\mu S^2}{g^3\delta^3 D^6}$$

The values of the constants c can be determined by the values he gives from experiments on glycerine whose density was 1.25 and superficial tension 63 dynes per centimetre.

$$\frac{A_1\mu}{g} = 1.308, \quad \frac{A_2\mu}{g^2} = .02322$$

and

$$\frac{A_3\mu}{g^3} = .0009108.$$

The formula is unfortunately a very inconvenient one for using to calculate the quantity that enters into it, and which is the most difficult to determine, namely, the surface tension between the bubble and liquid. This method of determining surface tension is one of the very few by which it can be determined without knowing angles of contact, which are so very difficult to determine at all accurately. In this way Mr. Trouton has determined the initial surface tension to be 6.5 between a bubble of water and glycerine that was pretty rapidly dissolving it. The ripple method could hardly be applied to this case, and it is doubtful whether the jet method could be applied to the surface between two liquids.

In connection with the high power to which g is raised in the formula it is interesting to note how, by altering the acceleration on the liquid by impacts or by centrifugal force we can very much increase the rate at which a bubble passes along a tube. This seems to be part of the rationale of the methods by which a bubble in a spirit thermometer can be shaken or whirled up the column.

The whole subject is of considerable interest, and lends itself to experimental investigation with very simple apparatus. A

few glass tubes and the liquids to be experimented with are almost the only things required in addition to a plentiful supply of care in cleaning. An investigation of the problem from purely dynamical considerations might well tax the powers of an ambitious mathematician, and provide tripos problems for many years.

#### SCIENCE IN THE MAGAZINES.

THE *Fortnightly* again takes the first place, as regards scientific articles, in the magazines received by us. Mr. Herbert Spencer contributes to it a paper on the late Prof. Tyndall, Prof. Karl Pearson writes on "Science and Monte Carlo," and Mr. H. O. Forbes states the grounds of his belief in "Antarctica: a Vanished Austral Land." Mr. Spencer does not dwell upon the more conspicuous of Prof. Tyndall's intellectual traits, but upon a few characteristics concerning which little has been said. Chief among these powers of thought was "the scientific use of the imagination." Tyndall insisted upon the need for this. "There prevail, almost universally," Mr. Spencer points out, "very erroneous ideas concerning the nature of imagination. Superstitious people whose folk-lore is full of tales of fairies and the like, are said to be imaginative; while nobody ascribes imagination to the inventor of a new machine . . . strange as the assertion will seem to most, it is nevertheless true that the mathematician who discloses to us some previous unknown order of space-relations does so by a greater effort of imagination than is implied by any poetic creation." The faculty with which Tyndall was largely endowed was that of constructive imagination, and he used that talent in all his work. Among other points upon which Mr. Spencer dwells in the eulogy of his dead friend, are Tyndall's intellectual vivacity, and the Club described by Prof. Huxley. The influence that the Club eventually exercised in the scientific world is shown by the fact that it contained four presidents of the British Association, three presidents of the Royal Society, and presidents of the College of Surgeons, of the Mathematical Society, and of the Chemical Society. The number of members is now reduced to five, and the Club is practically dead. The object of Prof. Pearson's essay is to show that chance as it applies to the tossing of an unloaded coin has no application in Monte Carlo roulette. The discussion of records of the roulette-tables leads to the strange result that "the random spinning of a roulette manufactured and daily readjusted with extraordinary care is not obedient to the laws of chance." In the *Fortnightly* of May last, Mr. Forbes gave reasons for believing that "there must have existed in the Southern Seas an extensive continuous land similar to that in the Northern Hemisphere, on which the common ancestors of the forms unknown north of the equator, but confined to one or more of the southern extremities of the great continents, lived and multiplied, and whence they could di-perse in all directions." He then remarked that this lost continent "lies in part beneath the southern ice-cap, and it approached to, or included, the Antarctic Islands, as well as extended northward to unite with the southern extremities of South America, perhaps with Africa, and with the Mascarene, the Australian, and the New Zealand continental islands." Mr. Forbes now brings forward a mass of evidence in support of his view, dealing in detail with the distribution of different divisions of the animal kingdom.

The *Century* contains a biographical sketch of Mr. Nikola Tesla, by Mr. T. C. Martin, illustrated by an excellent portrait of that investigator. Mr. Tesla comes of an old Servian stock, and is but thirty-six years of age. His electrical work began in the Polytechnic School at Gratz, where he distinguished himself in experimentation. He afterwards became an assistant in the Government Telegraph Engineering Department at Budapest, from which he passed into an electric-lighting establishment in Paris. A little later he crossed the Atlantic, and entered one of Mr. Edison's workshops. When his term of apprenticeship there had ended, he struck out for himself, his investigations eventually leading him to the brilliant phenomena produced with currents of high potential and high frequency. "Recently," says Mr. Martin, "the high-frequency generators with which he had done so much of this advanced work have been laid aside in discontent for an o-cillator, which he thinks may not only replace the steam-engine with its ponderous fly-wheels and governors, but embodies the simplest possible form of efficient mechanical generator of electricity."

Orchid lovers—and who are not lovers of those marvellous plants?—will find pleasure in reading an article on "Orchids," contributed by Mr. W. A. Styles to *Scribner*. The article is embellished by M. Paul de Longpré, with fourteen illustrations of the beautiful and fantastic forms of orchid flowers. Mr. Styles gives an account of a collector, who, when offering his plants for sale, explained that they had a special value, inasmuch as he had taken pains to destroy all that remained in their native woods. "This ingenuous avowal," continues Mr. Styles, "suggests a new danger to the orchid supply. It has already been necessary to pass laws in Switzerland to protect the endelweiss from tourists; there are societies in many European countries to rescue rare and native plants from extinction by amateur botanists and others. In our own country a few extremely local ferns and wild flowers are already in danger of extermination, and in the case of certain species of orchids of a limited range, each one of which has a money value regulated by the scarcity of the plants, the greed of man furnishes a motive for the wholesale destruction of all which cannot be carried away. The beautiful *Disa grandiflora* has already become scarce on Table Mountain, and the authorities at the Cape of Good Hope have found it necessary to forbid collecting it in order to prevent its total destruction. Rajah Sir Charles Brooke, of Sarawak, in Borneo, has issued an order to forbid the collection of plants in the country under his control, and if restrictions like this come to be enforced throughout the tropical regions tributary to the British Empire, it will cause consternation among the importers, who are receiving more than half a million orchids every year." *Scribner* also contains a striking article by Mr. J. C. Harris, on the terrible storm that devastated the Sea Islands and the coast of the United States from Charleston to Savannah last August.

A long discussion of Sir Henry Howorth's "Glacial Nightmare" appears in the *Quarterly Review* (No. 355). In conclusion the reviewer remarks: "We venture to record the opinion that in his treatment of the rival claims of ice and of water, as to which was the chief factor in producing the great Drift at the close of the Pleistocene epoch, our author has succeeded in shifting the balance of probability, and transferring it to the action of the latter."

Among other contributions of scientific interest in the magazines received by us is an interview with Dr. A. R. Wallace, F.R.S., on "Heredity and Pre-natal Influence," published in the *Humanitarian*; an article in *Longman's*, in which Mr. J. G. McPherson brings together a number of elementary facts relating to "Colour," and a paper on "Vegetable Monsters," by Mr. Edward Step, in *Good Words*. Mr. Step describes the current fictions concerning the so-called Devil-tree, the Upas-tree, the manchineel (*Hippomane mancinella*), and the Scythian Lamb (*Agnus Scythicus*). We have received the *Contemporary*, but it does not contain any articles on scientific topics.

#### UNIVERSITY AND EDUCATIONAL INTELLIGENCE.

OXFORD.—The voting for the board of the Faculty of Natural Science last week resulted in the election of Messrs. J. E. Marsh, H. Balfour, A. G. Vernon Harcourt, W. Esson, G. C. Bourne, and R. E. Baynes. Mr. R. H. Bremridge has been elected to a Senior Demysip at Magdalen College. Mr. Bremridge obtained a first class in the Honour School of Natural Science (Physiology) last year. Mr. R. T. Günther has been chosen as science tutor at Magdalen College, to succeed Mr. E. Chapman, who is leaving Oxford at the end of the Summer Term.

Professor Ray Lankester is issuing a volume of studies made in the Linacre Department since his election to the Professorship. The volume, which bears on its cover a medalion with a likeness of Linacre, contains papers by Dr. W. B. Benham, and Messrs. Minchin, R. T. Günther, Goodrich, Pycraft, and others.

CAMBRIDGE.—The electors to the Downing Professorship of Medicine, vacant by Dr. Latham's resignation, will meet for the purpose of electing his successor on March 3. Candidates are to send twelve copies of their testimonials (if any) to the vice-chancellor (the Rev. A. Austen Leigh, Provost of King's) by Monday, February 26.

The Council of the Senate have published, in the *Uni-*

*iversity Reporter* for February 6, a very important proposal, which may lead to a considerable increase in the number of students resorting to Cambridge for advanced study or research. The Council recommends that statutory powers be obtained for the establishment of two new degrees, Bachelor of Science and Bachelor of Letters, to be conferred on graduates only, whether of Cambridge or of some recognised University, British or foreign. The conditions suggested are (1) matriculation, (2) residence for one academical year (three terms), (3) evidence of advanced study or research in Cambridge, (4) an original dissertation on some subject, literary or scientific, coming under the cognisance of one of the Special Boards of Studies. Hitherto only graduates of the Universities of Oxford and Dublin, who have fulfilled conditions as to residence equivalent to those in force at Cambridge, have been admissible to *ad eundem* degrees. The new proposal is much more liberal, and is calculated to attract some of those maturer students who now, after graduating in their own University, seek opportunities for higher work in the continental schools. As Cambridge graduates can qualify for the B.Sc. and B.Litt. degrees only if they have passed one of the higher Honours Examinations, and then only on submitting an approved original dissertation, it is plainly intended that these degrees shall imply a real distinction. It is interesting to note that literary or scientific research, and not the faculty of passing examinations, is a condition for the new "post-graduate" degree. At Oxford similar proposals are said to be afoot, and if the two older Universities carry through their scheme, a great step will have been taken towards making them once more the resort of scholars from all parts of the world.

The *Times* published on Tuesday a summary of the recommendations of the Gresham Commission on a Teaching University for London, embodying a scheme for its constitution, with visitor, chancellor, vice-chancellor, senate, academic council, convocation, and schools, and regulations as to examinations, faculties, boards of studies, and degrees.

SOCIETIES AND ACADEMIES.

LONDON.

Royal Society, December 14.—"Action of Light on Bacteria.—Bacterial Photographs of the Solar and Electric Spectra." By Prof. H. M. Ward, F.R.S.

A thin film of gelatine or agar, in which spores or bacteria are evenly distributed, is spread over the flat bottom of a shallow glass dish. The lid of the dish is a plate of ground-glass, in which one or more slots, about 1/2 inch wide and 2 3/4 inches long, are pierced. The spectrum is so arranged that the light-rays fall perpendicularly on the film carrying the spores &c., and can only reach the latter through the slots, all other parts of the plate being covered by tin foil and black paper.

When the film has been thus locally exposed for a certain number of hours to the spectral rays, the culture is put into the incubator. All those parts protected from the light entirely, behave as in any ordinary culture—the spores germinate out and develop colonies, and the previously transparent film (transparent because the spores are too minute to affect it) becomes opaque.

Under the slot, however, the spores were exposed to the various rays of the successive regions of the spectrum. On one part of the exposed area the infra-red rays fall; on another the red; on another the orange; and so on with the yellow, green, blue, violet and ultra-violet rays.

If any of these rays kill or injure the spores they fall on, obviously the latter will show the effect by not germinating at all in the incubator, after exposure, or by germinating more or less slowly and feebly in comparison with the uninjured spores.

Wherever the spores do not germinate at all, the gelatine remains transparent; where they only germinate and develop into slowly growing, feeble colonies, the transparency of the gelatine film is merely clouded more or less; whereas, where they germinate and develop as vigorously as on the unexposed parts of the film, the latter is rendered quite opaque.

Obviously these differences, or contrast effects, can be

photographed, and the following is a photograph of a plate treated as described.

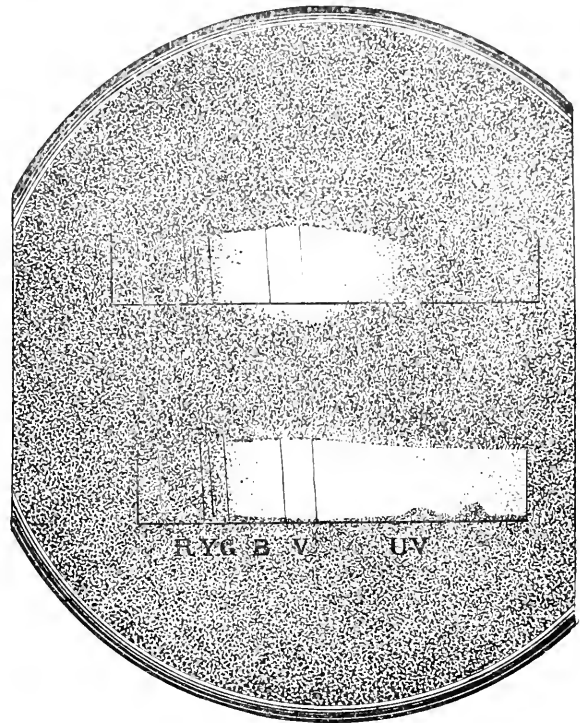

In all cases so far examined, both the solar and electric spectra show that no action whatever is perceptible in the infra-red, red, orange, or yellow region, while all are injured or destroyed in the blue and violet regions.

The exact point when the action begins and ends is not the same in all the experiments, though very nearly so, but it must be reserved for the detailed memoir to discuss the various cases.

Broadly speaking, the action begins at the blue end of the green, rises to a maximum as we pass to the violet end of the blue, and diminishes as we proceed in the violet to the ultra-violet regions.

Some especially interesting results were obtained with the electric spectrum. In the first place, the results with glass prisms, lenses, &c., were so feeble that it was necessary to employ quartz throughout.

Secondly, the bactericidal effect is found to extend far into the ultra-violet. The intervention of a thin piece of glass results in the cutting off of a large proportion of effective rays.

These results suggest evidently that the naked arc light may prove to be a very efficient disinfecting agent in hospital wards, railway carriages, or anywhere where the rays can be projected directly on to the organism.

January 25.—"The Effect produced upon Respiration by Faradic Excitation of the Cerebrum in the Monkey, Dog, Cat, and Rabbit." By W. G. Spencer.

The effect upon respiration of exciting the cerebrum in a non-anæsthetised animal is probably a complex one, yet, by careful regulation of the anæsthetic state, four constant effects can be obtained upon respiration by stimulation of the cortex, and these can be traced down each in a course of its own from the cortex to the medulla oblongata.

A. Diminution of Action.

I. *Slowing and Arrest of the Respiratory Rhythm.*—The cortical area where this result was obtained is situated just outside the olfactory tract in front of the point where the tract joins the temporosphenoidal lobe. On exposing successive and vertical sectional surfaces of the hemisphere the same result was obtained by exciting in the line of the strand of fibres known as the olfactory limb of the anterior commissure. After decussating at the

anterior commissure, the tract is continued backwards on either side of the infundibulum into the red nucleus below and external to the aqueduct at the plane of exit of the third nerve.

### B. Increased Action.

II. *Acceleration*.—Commencing from a point on the convex surface of the cortex within the "sensori-motor" area, the effect may be followed back just below the lenticular nucleus where it borders on the outer and ventral portion of the internal capsule; the strand runs at first external and then ventral to the motor portion of the internal capsule, and so reaches the tegmentum. The lines from the two sides meet in the interpeduncular grey matter at the level of and just behind the exit of the third nerve.

III. *Hyperinspiratory Clonus* ("snuffing movements").—This effect was obtained by excitation at the junction of the olfactory bulb and tract, and then carrying the stimulation backwards along the olfactory tract; the same result was found when the uncinate convolution of the temporo-sphenoidal lobe was irritated. Followed from the uncus this excitable region passed behind the optic tract to the crus, and then lay ventrally to the crista. The excitable tract on each side thus converged towards the middle line at the upper border of the pons.

IV. *Hyperinspiratory Tonus*.—This experimental result is of such frequency and constancy as to be clearly an important general phenomenon. It can be elicited in various ways: e.g. excitation of the descending motor tract in the corona radiata and internal capsule yielded this result; so did excitation of the fifth nerve and dura mater, as well as the sciatic nerve, both before and after complete removal of the cerebrum at the tentorium cerebelli.

"Experimental Researches into the Functions of the Cerebellum." By Dr. J. S. Risien Russell, Assistant Physician to the Metropolitan Hospital.

This paper is based on experiments performed on dogs and monkeys, the results of which lead the author to conclude that the cerebellum is an organ whose one lateral half does not in any great measure depend on the cooperation of the other half for the proper performance of its functions. The bulk of the impulses pass from one half of the organ to the cerebrum, or spinal cord, without passing to the other half. Three factors are responsible for the defective movements which result on ablation of different parts of the organ—incoordination, rigidity, and motor paresis. The last of these is probably directly due to the withdrawal of the cerebellar influence from the muscles, while the exalted excitability of the opposite cortex cerebri, which results after unilateral ablation of the cerebellum, is probably a provision for compensation in this and other connections. The alteration in the excitability of the cerebral cortex was the most striking result obtained, for both as tested by the induced current directly applied to the cortex, and from the characters of the curves obtained from muscles on the two sides of the body, during general convulsions evoked by absinthe, the opposite cortex showed a greater degree of excitability than did that on the same side, owing, it appears, to an increased state of excitability of the cortical cells of the opposite cerebral hemisphere, and a diminished state of excitability of those on the same side. Further, the curves obtained from limb muscles showed that there was a marked alteration in the second stage of the convulsive seizure, on the side of a unilateral ablation of the cerebellum, or on both sides after total ablation of the organ, for the tonus characteristic of this stage of similar convulsions evoked in dogs whose central nervous system was intact was either replaced by clonic spasms, or a large element of clonus was superimposed on the tonus.

There is evidence that the one half of the cerebellum controls the cells of the cortex of the opposite cerebral hemisphere, and those of the anterior horns of the spinal cord on the same side chiefly, and on the opposite side to a slight extent. It is further suggested that either the cerebral hemisphere whose excitability is increased inhibits the opposite hemisphere, or that, under normal conditions, one half of the cerebellum inhibits the other half, which inhibition being no longer operative, owing to ablation of half of the organ, allows the remaining half to exert an increased control on the opposite cortex cerebri, or on the spinal centres of the same side, or possibly in both directions; but which is the most probable explanation of the phenomena observed is at present left an open question.

The symptoms which characterise ablation of different parts of the cerebellum are detailed; and it is urged that instead of

looking on it as a distinct organ which has a special function, distinct from those subserved by other parts of the central nervous system, it would be more correct to look on it as a part of that system, having many functions in common with other parts of it, the chief difference between one part of this great system and another being the degree in which different functions are represented in any given part: e.g. with regard to motor power, the anterior extremity is maximally represented in the cerebrum and minimally in the cerebellum, whereas the trunk muscles are minimally represented in the cerebrum and maximally in the cerebellum. Arguments are adduced in favour of looking on the ocular deviations which result from ablation of parts of the cerebellum as paralytic rather than irritative phenomena, and two forms of nystagmus are recognised as consequent on cerebellar lesions, one which is spontaneous, and the other which is only evoked on voluntary movements of the globes, and the probable difference in their aetiology discussed. Finally, the phenomena characteristic of unilateral ablation of the cerebellum are contrasted with those the result of extirpation of the labyrinth, and it is shown that no single phenomenon is the same in the two.

"The Pathology of the (Edema which accompanies Passive Congestion." By Walter S. Lazarus-Barlow.

Physical Society, January 26.—Prof. A. W. Rücker, F.R.S., President, in the chair.—Mr. J. W. Kearton read a note on a new mode of making magic mirrors. The author's first idea was that the magic properties were due to differences in reflecting power, but experiments showed this to be improbable, and indicated that the patterns visible by reflected light were due to slight concavities in the surfaces. Several methods of producing such changes of curvature were tried, such as electro-depositing and electrical etching, the plates being subsequently polished to remove sharp edges. The method found most satisfactory was to draw the figures on polished brass covered with wax, and etch them by immersing in nitric acid, subsequently scouring with charcoal, Sheffield lime, and swansdown calico, until all direct traces of the figures disappeared. The scouring rounds off the edges and makes the depressions concave, the two eventually forming one concave sweep, which makes itself visible when light is reflected from it on a screen. To obtain satisfactory results with figures having broad and narrow lines, it was found necessary to paint over with hot wax the fine lines, and the outer edges of the broad ones after the first immersion; a second immersion etched the middle parts of the broad lines deeper. By repeating the process the broad lines were etched roughly concave in steps, and the scouring made their curvature continuous. Figures in relief, showing the pattern in shade on reflection, were obtained by painting the pattern on the plate in sealing-wax dissolved in naphtha, and etching away the uncovered portions by an immersion of one or two seconds. A number of mirrors with patterns in intaglio and relief were exhibited to the meeting. Prof. S. P. Thompson said the chief interest of Mr. Kearton's work was that he had succeeded in producing mirrors by a process which Prof. Ayrton had found unsuccessful. The spherical polisher used by Mr. Kearton might have something to do with the result obtained. Some of the mirrors had been gilt after polishing, and the reflected pattern improved thereby. Prof. Ayrton said he was greatly interested to see that mirrors could be produced by the chemical method. The polisher used by the Japanese was the flat end of a tight bundle of special straw cut crosswise. When the true explanation of the magic properties was found out, the chemical method was not pursued further. The Rev. F. J. Smith mentioned that he had produced magic properties on silvered glass by the inductoscript method. Although no markings could be seen directly, the pattern showed itself when light was reflected from the surface to a screen.—Mr. W. B. Croft read a paper on some observations in diffraction, and exhibited a large number of photographs of diffraction figures obtained under different conditions. The first series exhibited, related to diffraction from parallel light (diffraction of Fraunhofer and Scherdl), and were obtained by placing various combinations of thin circular lines of light on a dark glass plate before the object-glass of a telescope focused on a star. Spectral images of the star are formed by interference from the edges of the lines, thus giving diffraction patterns whose form depends on the shape of the aperture employed. The next series illustrated diffraction in shadow (Fresnel's diffraction), and were produced by condensing

light on a minute pinhole, and placing the object between the hole and a microscope eyepiece. Beyond the eyepiece the camera used for photographing the phenomena was placed. Permanent records of remarkably good diffraction figures were obtained in this way, both of the combinations of circles above mentioned and of various other objects and geometrical forms. After showing geometrically that diffraction bands from narrow obstacles and openings were wider than those from broader ones, the author explained the conditions necessary for making the bands visible, and pointed out the distinction between internal and external bands. Prominent amongst the photographs were several showing "Arago's white spot" at the middle of a shadow, and, in particular, this well-known phenomenon was shown as produced by so large an object as a threepenny-piece. Speaking of diffraction in a microscope, the author said little doubt need exist as to whether an image represented the real object or a diffraction modification thereof, for the latter were usually of a more misty and complicated character. Departing somewhat from the subject of diffraction, an excellent photograph of conically refracted pencils was shown, consisting of circular lines of light produced by passing light from pinholes through a crystal of arragonite. Dr. Johnstone Stoney thought the obtaining of permanent records of diffraction phenomena of great importance, and was particularly interested in the photograph showing conical refraction. Prof. S. P. Thompson said he had never seen diffraction effects exhibited to an audience so well before. He had noticed that in several of the photographs Arago's spot was unintentionally shown to perfection in the shadow of dust particles. The President greatly appreciated the fact that the conical refraction photograph had been exhibited for the first time before the Physical Society.—A note on a new photometric method and a photometer for same, was read by Mr. J. B. Spurge. The method consists in using two diffusing screens (illuminated respectively by the lights to be compared) as secondary sources, and adjusting to equality the luminosity of equidistant internal surfaces by varying the apertures through which the light passes from the screens to those surfaces. By reducing the sizes of the apertures the author has been enabled to compare lights of different colour, for when of sufficiently feeble intensity coloured lights are indistinguishable from white or grey. The photometer is made up of two tubes mounted at 45° to an axis, about which one of them is capable of rotating. When in the same horizontal plane, the axes of the tubes form the sides of an isosceles right-angled triangle, at the middle of whose hypothenuse the light to be tested is placed; this illuminates one of the screens, whilst the standard light shines on the other. These screens, used as secondary sources, are situated a short distance away from the outer ends of the tubes, whilst the inner surfaces of the near ends of the tubes are viewed by means of a mirror. By turning the movable tube about the inclined axis, and rotating the source about a vertical axis, the illuminating effect of the source in any direction can be tested. Capt. Abney said the law of inverse squares was not true for weak lights, for the proportions in which the light from sources of equal intensity had to be reduced to appear white or grey depended greatly on the colour; being much greater for violet than for red. Only for the yellow-green rays was the ordinary law of illumination true when the intensities were feeble. Mr. Blakesley, Prof. S. P. Thompson, and the President also took part in the discussion.

**Geological Society, January 24.**—W. H. Hudleston, F.R.S., President, in the chair.—The ossiferous fissures in the valley of the Shode, near Ightham, Kent, by W. J. Lewis Abbott. The fissures occur in a promontory of Kentish Rag between two tributaries of the Shode. There are four fissures in this promontory, striking at right angles to the valley. Details of the physiography of the area in which the fissures occur are given in the paper. Three of the fissures have obviously been in contact with the surface, and from these the bones appear to have been dissolved out. The fourth does not reach the top of the Rag, and further is sealed by an arragonite-lined chamber with stalactitic floor and ceiling. This fissure is from 2 to 6 feet wide and about 80 feet deep, and is filled with a heterogeneous collection such as constitutes the flotsam and jetsam of streams, along with materials derived from the rock in which the fissures occur. Several thousand bones were found, also twelve species of aquatic and land shells, an entomostracan, *Chara* and other vegetable remains have been procured. The author gave reasons for concluding that the fissures have never been reopened since they were first closed by the materials introduced into them by

the river, and that all the contained fossils belong to one and the same geological period. He pointed to the discovery of species not before found in Pleistocene beds as only a repetition of what has occurred in other sections he had worked, and remarked also that the increase of species was corroborative of a suggestion of Mr. C. Reid that the more we discover of the smaller creatures of this and the preceding age, the more they approximate to those of our own times. Even if we were to exclude from the lists all the species not previously found fossil elsewhere, we still have an extensive assemblage of the older Pleistocene forms, which must have lived during the filling of the fissures, and this therefore fixes the filling operation as having occurred in Pleistocene times.—The vertebrate fauna collected by Mr. Lewis Abbott from the fissure near Ightham, Kent, by E. T. Newton, F.R.S. The vertebrate remains collected by Mr. Lewis Abbott have been passed in review by Mr. Newton, and as far as possible specifically identified: they represent mammals, birds, reptiles, and amphibians; but no fishes have been found. In all, 48 different forms have been recognised; 3 or perhaps 4 are extinct; 11 are extinct in Britain, but are still living elsewhere; 21 are living in Britain, but are known to be Pleistocene or forest-bed forms; and 12 are species now living in Britain which have not hitherto been recognised in Pleistocene or older deposits. Among the more important species found in this fissure, but extinct in Britain, may be noticed, besides *Elephas primigenius*, *Rhinoceros antiquitatis*, and *Hyæna*, the *Ursus arctos*, *Canis lagopus*, *Myodes torquatus*, *Myodes lemmus*, *Microtus gregalis*, *M. ratticeps*, *Lagomys pusillus*, *Spermophilus*, and *Cervus tarandus*. The name of *Mustela robusta* was proposed for some limb-bones intermediate between the polecat and marten, and the remains of an extremely small weasel are noticed as a variety of *Mustela vulgaris*. Although the large number of living species gives a recent aspect to this series of remains, the evidence, it is believed, points rather to their being all of Pleistocene age, and most nearly allied to the fauna of British caves. In the course of some remarks upon the paper, Mr. Topley compared the fissures filled with loam and gravel, and containing mammalian bones and land-shells, of the Maidstone district with the interesting example described, and explained that those of the Maidstone Rag country were connected with overlying deposits of drift, the material now filling the fissures having been let down into the rock by solution of the limestone along joints and cracks. Sir Henry Howorth and Dr. Henry Hicks also spoke, and Mr. E. T. Newton briefly replied.

## PARIS.

**Academy of Sciences, January 29.**—M. Léwy in the chair.—An account of the work of A. Scacchi, by M. Des Cloizeaux.—Integration of the equation of sound for an indefinite fluid in one, two, or three dimensions, when there are different resistances to the movement; physical consequences of this integration, by M. J. Boussinesq.—On the propagation of an electric current in a particular case, by M. A. Potier.—Anomalies in the force of gravity observed on the North American Continent, by M. Defforges. The value of  $g$  for a number of stations between Washington and San Francisco is as follows:—Washington 980'167, Montreal 980'729, Chicago 980'345, Denver 979'684, Salt Lake City 979'816, Mt. Hamilton 979'683, and San Francisco 980'016. These values, reduced to sea-level and compared with the theoretical values calculated from Clairaut's law, show regular anomalies which are compared with anomalies exhibited by oceanic islands.—Theory of the elasticity of metals, by M. Felix Lucas.—On the new measurement of the area of France, by General Derrégaix. A planimeter measurement, calculated on the assumption that the figure of the earth is a true ellipsoid of revolution. Supplementary remarks were made by M. E. Levasseur.—On the rapid summation of certain slightly convergent series (alternate harmonic series), by M. A. Janet.—On a common property of three particular classes of rectilinear congruences, by M. Alphonse Demoulin.—Joule's and Mariotte's laws in connection with existing gases, by M. Jules Andrade. The author shows that these laws are true for real gases within about the same limits of accuracy.—An electric alarm thermometer for laboratory ovens, by M. Barillé. Connection of an electric circuit is made when the mercury in the thermometer reaches a determined point on the scale by means of a platinum wire which is attached to a small iron tube (sliding along a fixed wire), of which the position can be regulated by a

magnet attached to the supporting frame.—On synthesised borneols, by MM. G. Bouchardat and J. Lafont.—Thermal constants of some polyatomic bases, by MM. Albert Colson and Georges Darzens. For *ethylene-diamine* the observed values were:—Specific heat 0.84 between 12° and 45°; heat of solution +7.6 cal. for 1 mol. in 4 litres of water at 15°; heat of neutralisation +23.54 cal. (1 mol. normal salt in 5 litres of water); heat of solution of the normal chloride -7.55 cal. for 1 mol. in 4 litres of water. For quinine, observations gave:—Heat of solution for 1 mol. of  $Q.SO_4H_3.6H_2O$  dissolved in 12 litres of water containing 1 mol.  $H_2SO_4 = -6.7$  cal.; heat of neutralisation +15.5 cal. for freshly precipitated quinine.—On the adaptation of the alcoholic ferment to the conditions of living in media containing hydrofluoric acid, by M. E. Sorel. The lactic acid ferment is destroyed by the addition to the mash of a small quantity of hydrofluoric acid, and the yield of alcohol correspondingly increased. By cultivation in presence of increasing quantities of hydrofluoric acid the resisting properties of the alcoholic ferment may be considerably increased.—On the relation of the palisade tissue of leaves to transpiration, by M. Pierre Lesage. The palisade tissue appears to function as a means of protecting the leaves from excessive transpiration.—Main lines indicating directions of folds and contortions in the geology of France, by M. Marcel Bertrand.—On the composition of some calcareous marls, by M. H. le Chatelier.—On the forms of platinum in its bed rock, from the Ural district, by M. A. Inostranzeff.—On the age of the human skeleton discovered in the eruptive formation of Gravenoire (Puy-de-Dôme), by MM. Paul Girod and Paul Gautier.

BERLIN.

Physical Society, Dec. 15, 1893.—Prof. du Bois Reymond, President, in the chair.—Dr. A. du Bois Reymond spoke on Lilienthal's experiments on flying. As a starting-point he had chosen the study of the flight of birds, which may be divided into three distinct kinds—flapping, steering, and soaring. Of these the one demanding least expenditure of energy is soaring, and investigation showed that under certain conditions flight is possible if the wind possesses a vertical component. Experiments showed that surfaces can acquire a horizontal motion by the action of the wind only, when their curvature bears a certain relation to their superficies, and that this relation corresponds exactly to that which is observed in the wings of birds. Dr. Lilienthal's flying machine consists of a correctly curved surface whose area is 14 square metres, made by stretching linen over a light wooden frame, and having a weight of about 20 kilos. In its centre is an aperture for the experimenter's body, and the apparatus is held in position by the person's arms. On running rapidly down a gentle slope of a hill against the wind, the latter soon acquires a vertical component, which then carries the flying apparatus and propels it in a direction against the wind. The speaker had seen Dr. Lilienthal sail over a space of about 120 metres, at an altitude of some 30 metres, in a minute; with a favourable wind it was possible to cover some 200 to 500 metres, and Dr. du Bois Reymond had himself taken leaps through the air of 20 to 30 metres under similar conditions. He was of opinion that by practice far better results may be obtained as regards soaring, and that then, by combining steering with soaring, it will be possible to fly even when the wind is unfavourable. It appears that the three essentials for the solution of the problem of flight are (1) correct utilisation of the wind; (2) the correct shape of the supporting surfaces, and (3) correct handling of the apparatus.—Herr Haensch explained three different models of Nicol prisms, of which Glans' showed itself to be best as regards construction and efficiency.

January 5.—Prof. Kundt, President, in the chair.—Dr. Lummer gave a detailed account of the experiments he had made, before his journey to Chicago, on Siemen's and on Violle's unit of light. Both of these must be rejected as standard-units in cases where the platinum is melted in the blowpipe flame. Experiments made to establish the Violle unit by means of an electric current showed that in this case there were variations of from 10 to 12 per cent., which made it unsuitable as an absolute standard of light. Hefner's amylicetate lamp, which the speaker had been examining during the last four years, gives a unit which varies only by some 3 or 4 per cent. as long as the necessary conditions are strictly observed and allowance is made for varying meteorological conditions which affect the

lamp. It appears, therefore, that a really reliable unit of light has still to be found.

January 19.—Prof. Kundt, President, in the chair.—Prof. Hale, of Chicago, exhibited and explained his lantern-slides of solar photographs.—Prof. Neesen communicated on behalf of Herr van Aubel, of Brussels, the latter's method of silvering aluminium. It consists in cleaning the plate of aluminium with benzol, then dipping it into a solution of sulphate of copper until a thin film of copper is formed on its surface. At this stage a layer of silver is deposited electrolytically on the plate. Prof. Neesen had found that the layer of silver thus formed does not adhere very firmly to the aluminium.

BOOKS, PAMPHLETS, and SERIALS RECEIVED.

Books.—A Students' Text-Book of Botany: Dr. S. H. Vines, first half (Sonnenschein).—Johnston's Elements of Agricultural Chemistry, revised by C. M. Aikman, 17th edition (Blackwood).—Optical Experiments, revised and arranged after the directions of Dr. H. Zwick (Newmann).—The Inventions, Researches, and Writings of Nikola Tesla: T. C. Martin (New York, *Electrical Engineer Office*).—Electricity in the Service of Man: Dr. R. Wormell, revised and enlarged by Dr. R. M. Walmsley (Cassell).—A Text-book of Euclid's Elements: H. S. Hall and F. H. Stevens, Books 2 and 3 (Macmillan).—Pain, Pleasure, and Aesthetics: H. R. Marshall (Macmillan).—Primer of Philosophy: Dr. P. Carus (Chicago, Open Court Publishing Co.).—The Religion of Science: Dr. P. Carus, extra edition (Chicago, Open Court Publishing Co.).—Investigations on Microscopic Forms and on Protoplasm: Prof. O. Bütschli, translated by E. A. Minchin (Black).—Congrès International d'Anthropologie et d'Archéologie préhistorique et de Zoologie à Moscou, Matériaux, Deux Parties (Moscou). Two Great Scotsmen the Brothers William and John Hunter: Dr. G. R. Mather (Glasgow, J. Maclehose).

PAMPHLETS.—Report of J. P. Langley, Secretary of the Smithsonian Institution, for the year ending June 30, 1893 (Washington).—Seventh Annual Report of the Liverpool Marine Biological Committee, and their Biological Station at Port Erin: Prof. Herdman (Liverpool, Dobb).—Über ein Interferenzrefractometer: L. Mach (Wien).—Physical Constants of Thallium: W. H. Steele (Melbourne).—A New Thermoelectric Phenomenon: W. H. Steele (Melbourne).—On the Conductivity of a Solution of Copper Sulphate: W. H. Steele (Melbourne).—Sulle Perturbazioni Magnetiche dell' Agosto 1893, &c.: Dr. L. Palazzo (Roma).

SERIALS.—Bulletin de l'Académie Royale des Sciences de Belgique, 63<sup>e</sup> Année, No. 12 (Bruxelles).—Dictionary of Political Economy, sixth part (Macmillan).—Natural Science, February (Macmillan).—Botanical Gazette, January (Madison, Wis.).—Proceedings of the Society for Psychical Research, January (K. Paul).—L'Anthropologie, Tome iv, No. 5 (Paris, Masson).—Geological Magazine, February (K. Paul).—Quarterly Journal of the Geological Society, Vol. 1, part 1, No. 107 (Longman).—Bulletin of the New York Mathematical Society, January (New York, Macmillan).—American Naturalist, January (Philadelphia).

CONTENTS.

|                                                                    | PAGE |
|--------------------------------------------------------------------|------|
| A Critic Criticised. By Dr. Alfred R. Wallace, F.R.S. . . . .      | 333  |
| Dynamos and Transformers. By P. A. M. . . . .                      | 337  |
| Golf. By W. Rutherford . . . . .                                   | 338  |
| Our Book Shelf:—                                                   |      |
| Webb: "Celestial Objects for Common Telescopes" . . . . .          | 339  |
| Loney: "Plane Trigonometry" . . . . .                              | 339  |
| Letters to the Editor:—                                            |      |
| Music, Rhythm, and Muscle.—Prof. T. Clifford Allbutt, M.D. . . . . | 340  |
| The Cloudy Condensation of Steam.—John Aitken, F.R.S. . . . .      | 340  |
| The Os Pedis in Ungulates.—Prof. A. E. Mettam . . . . .            | 341  |
| A Brilliant Meteor.—Dr. M. F. O'Reilly . . . . .                   | 341  |
| The Vatican Observatory. (Illustrated.) By R. A. Gregory . . . . . | 341  |
| Notes . . . . .                                                    | 345  |
| Our Astronomical Column:—                                          |      |
| Eclipse Meteorology . . . . .                                      | 349  |
| A Remarkable Cometary Collision . . . . .                          | 349  |
| Mira Ceti . . . . .                                                | 349  |
| Proper Motions of Stars . . . . .                                  | 349  |
| The System of Algol . . . . .                                      | 349  |
| The Institution of Mechanical Engineers . . . . .                  | 350  |
| On the Motion of Bubbles in Tubes . . . . .                        | 351  |
| Science in the Magazines . . . . .                                 | 352  |
| University and Educational Intelligence . . . . .                  | 352  |
| Societies and Academies. (Illustrated.) . . . .                    | 353  |
| Books, Pamphlets, and Serials Received . . . . .                   | 356  |



THURSDAY, FEBRUARY 15, 1894.

*RECENT RESEARCHES IN ELECTRICITY AND MAGNETISM.*

*Notes on Recent Researches in Electricity and Magnetism*, intended as a sequel to Prof. Clerk Maxwell's Treatise on Electricity and Magnetism. By J. J. Thomson, M.A., F.R.S., &c., Professor of Experimental Physics in the University of Cambridge. (Oxford: at the Clarendon Press, 1893.)

THE supplementary volume to Maxwell's "Electricity" which it was announced the present occupant of Maxwell's chair in the University of Cambridge had in preparation, was looked forward to with keen interest by all electricians. It was sure, of course, to be a work of great scientific importance; but it was awaited with all the more impatience because certain promises and allusions in the new edition of Maxwell's treatise, lately published under Prof. Thomson's editorship, had led to pleasant anticipations that the supplement would be more or less of a commentary on the treatise, and would deal with some of the outstanding difficulties of Maxwell's electromagnetic theory. One promise in particular, made in the notes on the Electricity, we looked forward to seeing fulfilled in the supplementary volume, that of further discussion of the Maxwellian stress in the electromagnetic field. It is just here that the greatest difficulties of Maxwell's theory present themselves to some at least, and that a commentary such as the author could have written would have been particularly valuable.

Any little disappointment which may be felt at first as to the contents of the volume vanishes when their solid scientific value becomes apparent, and it is felt that perhaps the author has done the right thing after all by preferring to give a full account of the great work which has been done in recent years, in confirming and verifying Maxwell's theory, and in answering the questions it has suggested.

The book opens with an account of Prof. J. J. Thomson's method of regarding electric and magnetic phenomena as produced by the motion of Faraday tubes of electric force. This method is fully explained, and applied to the discussion of various physical phenomena, such as electrolysis, the action of a galvanic cell, and so forth. These show, perhaps, to the best advantage the power of the method, which certainly enables a mental image of what goes on in such cases to be more easily and clearly formed.

These tubes, according to Faraday's idea, start from positive and end on negative electricity, and the positive and negative electricities at the extremities of a tube, being merely the two aspects or surface manifestations of the state of strain existing in the medium within the tube, are complementary and equal.

According to Prof. Thomson's specification, a tube is either closed or terminated by atoms. When it has a length of the same order of magnitude as the distance between two atoms in a molecule, the atoms are in chemical combination; when the length is of a higher order of magnitude the atoms are chemically free.

These tubes move through the field when electrical changes take place, and by their motion produce magnetic force, which is proportional to the velocity of the tube moving at the point considered, and at right angles to the plane defined by the tube and the direction of motion. When a tube as a whole reaches a conductor, it shrinks to molecular dimensions.

To account for a steady magnetic field, which occurs without dielectric polarisation, and therefore apparently without the presence of tubes in the field at all, it is supposed that there are passing through a given small area just as many positive as there are of negative tubes, (that is, there is a distribution of oppositely directed tubes throughout the field, such that there is nowhere any preponderance of one kind over the other), but that these two sets of tubes are moving with equal velocities in opposite directions, so that the magnetic forces which they produce reinforce one another.

A quantity which the author calls the polarisation of the medium is defined, for any given direction at a given point, by the excess of the number per unit of area of positive over negative tubes passing through a small plane surface drawn through the point at right angles to the given direction. When the dielectric is not air, the unit area is supposed taken in a narrow crevasse cut in the medium with its walls at right angles to the given direction. Thus the dielectric polarisation is exactly analogous to the magnetic induction in the magnetic field as ordinarily defined.

The momentum of the tubes per unit volume of the field at any point is a directed quantity which is normal to the plane defined by the magnetic induction and the polarisation, and its components are proportional to the rates of transference of energy, according to Poynting's theory, in the directions of the axes across unit area held at right angles to each of them.

When the electric intensity of the field is due solely to the motion of the tubes, they move at right angles to their own directions with the velocity of light.

This theory gives a clear idea of why both polarisation and conduction currents and the motion of charged bodies produce magnetic effects. Everything is due to the motion of Faraday tubes, and in all three cases the Faraday tubes are moved through the field.

It is questionable whether this theory will ever successfully compete in electromagnetic discussions with the reciprocal method, that of the motion of tubes of magnetic force. Both were given by Faraday, who speaks most unmistakably in his "Experimental Researches," in the language of the modern theory of the induction of currents by the motion of tubes of magnetic induction across conductors situated in the field. It is well to have both, and their use will serve to emphasise what is of very great importance, the reciprocal character exhibited very strikingly in the modification of Maxwell's electromagnetic equations, given by Heaviside and Hertz, of the relations between the electric and the magnetic forces.

After these preliminary discussions comes an account of the phenomena accompanying the passage of electricity through gases. This reviews and coordinates to a considerable extent the experimental researches of Crookes, Spottiswoode and Moulton, Hittorf, and others in this

field. This part of the work has a value enhanced by the contributions made to our knowledge of this department of electrical science by the author himself, both as regards the actual experimental facts and their theoretical explanation. The action of a magnet upon discharges in tubes or bulbs without electrodes is peculiarly interesting. The discharge being oscillatory in such a case is separated into two distinct portions, consisting of the discharges in the two opposite directions. Thus a ring discharge in a horizontal plane has one part raised, the other lowered by the action of a horizontal magnetic field. Further, as has been observed by the author, the discharge is rendered more difficult when it has to pass across the lines of force of a magnetic field, while it is facilitated when it has to pass along the lines.

The explanation suggested by the author is ingenious. The gas breaks down along the line of maximum electromotive intensity, and a discharge occurs which gives a supply of dissociated molecules, which readily convey subsequent discharges. The magnetic field, when at right angles to the line of discharge, acting on the molecules taking part in the discharge, removes them from the line of maximum electromotive intensity, and thus the instability of electric strength which the discharge tends to set up is continually being annulled by the magnetic action.

In the other case it is suggested that if branching of the discharge from the main line takes place, the dissociated molecules there formed will be brought into the line by the magnetic action, and would thus increase the facility of the discharge, beyond that which would exist if there were no field.

This, as Prof. Fitzgerald has suggested, has an important bearing on the nature of the aurora, and probably explains the streamers which form so remarkable a feature of auroral displays. These may be simply more than averagely bright discharges along the electrically weaker lines of magnetic force in the rarefied air of the upper parts of the atmosphere.

A chapter is next devoted to Conjugate Functions in their applications to the solution of electrical problems. This method is very serviceable for the solution of problems of electrical flow in two dimensions, but it can hardly be applied in a systematic manner to the various problems which present themselves.

The theory of functions of a complex variable has been greatly advanced since Maxwell wrote, and there is certainly much, as has been pointed out, more especially by Klein, that has direct application to the solution of electrical problems. Prof. Thomson has therefore done well to include some of the general transformations of this theory, with their applications to such problems as the effect of the gap between the plate and guard-ring in Lord Kelvin's absolute electrometer or guard-ring condenser, different arrangements of piles of plates, and the like. This theory of the condenser he has himself made use of in his determination of  $v$ .

It may be objected that some of the problems solved by the indirect method employed in this chapter have no very distinct practical application; but there can be no question of the value of such a discussion. It places within the reach of students who are able to follow its processes

ready to hand by which problems quite unassailable by ordinary methods are discovered and solved; and who can tell when such problems may not become of great practical importance, in the present rapidly advancing state of the science?

We are taken next to the subject of electrical waves and oscillations, which in some form or other is the theme discussed in the remainder of the book. The problem of periodic disturbances is very fully treated in a large number of practically important cases. Throughout the analysis the method of representing a simply periodic function in the form  $Me^{(mz + pt)i}$  where  $i = \sqrt{-1}$  is adopted. This tends greatly to condensation, and the results are always interpretable at will by properly "realising" the solution.

First is taken the extremely important case of waves along a cylindrical wire surrounded by a coaxial coating of dielectric, outside which again is an infinitely extending cylindrical conductor; and this is treated with special fulness. The solutions are expressed in terms of Bessel's functions; and this part of the book ought to lead to a more general study of the properties of such functions, and their applications to physical problems. They had their origin in a physical problem, and their importance to physicists has gone on increasing with the development of physical mathematics which has been brought about by the problems disclosed by scientific progress in recent times.

The theoretical solution of the problem of waves along wires is mainly due to Lord Kelvin, Mr. Oliver Heaviside, and Prof. J. J. Thomson. The solution given long ago by Lord Kelvin of the more limited problem which was then the practical one, appears as a particular case of the general solutions which these physicists have since obtained. The conclusions they have reached are of the utmost interest in connection with telephony, and seem likely to point the way to a more extended use of telephonic communication than has hitherto seemed possible. Lord Kelvin's early solution, it is not too much to say, gave for the first time light on the vexed question of the conditions of success in signalling through submarine cables and, together with the marvellously delicate and simple instruments which he also invented, rendered signalling through such cables commercially possible. Even now the question of ocean telephony has come to the front, and if it succeeds (and who will venture to say its difficulties will not be overcome?) it will be in great measure a result of the patient researches of men like Lord Kelvin, O. Heaviside, and the author of the work before us.

The complex variable treatment is adhered to, and contributes greatly to brevity of expression. The treatment of the subject is very complete, and though it involves some rather complicated work seems very accurately printed. The author has apparently pressed forward from point to point, taking the path which presented itself at the time, and hence, to one coming after, it is possible to suggest some shortening and smoothing of the way. For example, the values of the electromotive and magnetic intensities are perhaps more compactly investigated by first specialising the fundamental equations for the case of symmetry round an axis, noting that the electromotive intensity reduces to two components,

one P along the axis, and the other R at right angles to the axis, in a plane through the axis and the point considered, while the magnetic force H, say, has a single component perpendicular to the plane. Thus two differential equations are got connecting P, R, and H, from which (P having first been found from the differential equation involving P alone) R and H are found at once in the forms  $M\partial P/\partial r$ ,  $N\partial P/\partial r$  where M and N are multipliers, and r is the radius drawn from the axis to the point considered.

It is to be noted also that the sign between the two groups of terms into which  $K_0(x)$  is divided in (2), p. 263, should be the same as that before  $\log x$  in the first group in brackets and that C should be taken with the same sign as  $\log x$ , and  $\log 2$  with the opposite sign. This involves a correction likewise in the table of approximate values of the functions given lower down on the same page. Again, the same constant C, which has the value

$$\text{Lt}_{n=\infty} \left( \sum_{n=1}^n \frac{1}{n} - \log n \right)$$

is called Gauss's constant at p. 263, while the quantity  $\gamma = e^{-1}$  is called Euler's constant at p. 430. The established usage seems to be to call C Euler's Constant from its discoverer, who gave its value (to sixteen places of decimals) in his *Institutiones Calculi Differentialis*.

The "throttling" of the current in wires subjected to rapidly alternating electromotive forces is fully considered for a cable with inner and outer coaxial conductors, and for two flat strips in parallel planes with a stratum of insulating material between them. In this connection the author first introduces Mr. Oliver Heaviside's word *impedance*. Writing E for the external electromotive force, I for the total current, and R and L for the effective resistance and self-inductance, we have (p. 272)

$$E = L \frac{\partial I}{\partial t} + RI.$$

R is called by Prof. Thomson the impedance. According to Heaviside's proposal it is  $\sqrt{R^2 + n^2 L^2}$  that should be called the impedance, where  $n = 2\pi/T$ , T being the period of the alternation.

The manner in which the damping out of the vibration is taken account of by the complex analysis is well worth remarking. The eating up of the energy and consequent tapering off of the amplitude according to an exponential function of the distance from the starting end by the impinging of the oscillations in the dielectric on the conductors bounding it, and the lowering of speed of propagation of phase in the dielectric below the natural speed, that of light, all come out in the most beautiful manner.

Mr. Heaviside's careful synthetical explanations of such phenomena are well worth reading in this connection.

The author next passes to his own most valuable investigations regarding the effect of subdivision of iron on the dissipation of energy in the iron of a transformer, to electrical oscillations on cylinders and on spheres, and other problems of the greatest interest to all students of the later developments of Maxwell's great theory carried out by Hertz, now, alas, to be continued entirely by other hands.

The concluding portion of the book consists of a most valuable account of the work of Hertz, and forms the most appropriate supplement to Maxwell's great work that could have been written. The idea of Faraday tubes is well applied to picture the action of a Hertzian resonator in its different positions relatively to the vibrator in the experiments on direct radiation, and those on waves along wires. Not only is Hertz's own work fully described and explained, but the vast amount of fine work that has been done at Dublin, Liverpool, and Cambridge, and on the continent, is discussed, and much of it submitted to careful mathematical analysis.

Space does not permit of even a summary of the topics here treated, and we can only say that the reader who wishes to know these things well, and who shrinks from the labour of digging them out of *Proceedings*, *Annalen*, and *Berichte*, here, there, and everywhere, ought to read Prof. Thomson's work. Such a work is worthy not only of the author, but of the researches of the master and his great disciple who have passed away. A. GRAY.

GREENHILL'S ELLIPTIC FUNCTIONS.

*The Applications of Elliptic Functions.* By Alfred George Greenhill, F.R.S., Professor of Mathematics in the Artillery College, Woolwich. (London: Macmillan and Co., 1892.)

IT would be difficult to exaggerate the part which the study of elliptic functions has played in the pure mathematics of the present century. And this was to be expected; for whether we regard natural science as the application of common sense to the material needs of life, or as the outcome of the need for expansion in the mental world, and whether we consider mathematics as that exact basis without which progress was not permanently possible, or esteem it to be those higher Alps—

Where we can ever climb, and ever  
To a finer air—

in either case we must see that a development of integral calculus—a development which was competent to fill so large a part of Legendre's life, which suggested such magnificent algebra as we find in Jacobi's *Fundamenta*, which promised, too, in Abel's hands such generalisations as are not even yet brought to perfection, such a theory, surely, was well worthy of persevering pursuit. And if we attribute the present extent of the theory of curves and of the theory of functions to the day when Riemann stood best man to the ideas of Cauchy and the suggestions of hydrodynamics, we must admit it was because his methods were employed upon the materials left by Abel that such results have come.

The importance of the present work lies in its recognition that the theory of elliptic functions arose as a development of integral calculus, and as such may be expected to supply a formulation of the solution of many problems of physics otherwise regarded as unfinished. Prof. Greenhill is well known to be a man who has not allowed his unwearied application to such problems to destroy his sympathy with pure mathematical speculation; on the contrary, he has sought, by every means in his power, to fill the difficult position of apostle to the Gentiles in this respect, by making as many of the results

of analysis as are susceptible of application to physics, easily intelligible to students of that subject. The present book, addressed, we are told, to the trained mathematical student, is stated to be primarily a collection of problems (mostly in dynamics and electric flow) whose solutions are expressible by elliptic functions; and it is intended that the properties of these functions should be suggested by, and developed simultaneously with, the problems in hand. Really, of course, it is much more. In fact, the student who works completely through the book will meet with a good many of the formulæ of common occurrence in the elementary part of the subject, and will, moreover, learn to manipulate them for himself; and whether he be interested most in the motion of tops, or the stability of ships, or the biquadratic form, he will probably be surprised at the amount of information condensed here.

The book opens with a consideration of the motion of the common pendulum. The fact that in this motion the angular displacement depends uniquely upon the time, suggests the inversion of the elliptic integral; the existence of a real period of the functions thus obtained, is suggested by the periodic motion of the pendulum. The functions are then immediately used to express the solution of Euler's equations for a body moving about a fixed point under no forces. Then follow seventy pages devoted to the expression of elliptic integrals in terms of the functions, in the course of which, beside a vast variety of examples collected from Legendre and elsewhere, are found a consideration of Watts' Governor, of the Elastica, of the Sumner lines on a Mercator chart, of the Catenoid, of quadrantal oscillations, and of other things—the notation being sometimes Jacobian and sometimes Weierstrassian. It is needless to say that here is a mine of wealth for the examiner. It is only in chapter iv., when we are a third of the way through the book, that the addition theorem of the functions becomes necessary. And while this is proved by a pendulum view of Jacobi's two-circle method, space is found for a thorough examination of Legendre's method and a detailed account of the porism of the in- and circum-scribed polygon for two circles, the diagrams being of the most painstaking character. Then follow sixty pages which will be perhaps the least interesting of the book—at least to the students for whom Prof. Greenhill writes—devoted to an algebraic exposition of the addition theorems for the three kinds of integrals. They contain an examination of the theorems of Fagnano and Graves for the ellipse and hyperbola. They are followed by an account of the tortuous elastica, succeeded by a resumption of the motion of a body about a fixed point under no forces, wherein the author introduces a very full account of the herpolhode. In the hundred pages remaining, the book may be said to be drawing to a conclusion, the double periodicity is considered, Cartesian ovals being introduced in connection with the expression of functions of a purely imaginary argument; a chapter is devoted to the factor expressions of the functions, here suggested by hydrodynamical considerations; and the last chapter is a summary of the earlier part of the theory of transformation, characterised, however, like the rest of the book, by the utmost particularity, numerical and otherwise.

This summary will show to some extent the scope of the work. It is essentially a student's book, written in a concise conversational style; but whether the student have more sympathy with physical or pure mathematics, he cannot fail to find much that is new to him, and be surprised at the detail with which it is given; and the air of practical reality which pervades every page, and the skill and originality with which the results are obtained, will atone for the tentative nature of many of the demonstrations.

It is, in fact, in this regard that the reader may be most unfair to the author. It is no part of his plan to develop any demonstration beyond the nearest point at which it suggests the formula required, or to use any more general method of enquiry than is absolutely necessary, or to regard the subject in any other way than as a collection of formulæ. To forget this is to wish for many things to be differently stated—is, indeed, to wish for a quite different book. A few instances will suffice. The author frequently makes the remark that the present state of the theory is due to Abel's brilliant idea in inverting the elliptic integral of the first kind. One fears that the reader may enquire whether the inverse function is a one-valued function of its argument for all the values of the latter, or may forget that the expansion of p. 202 is not valid for all values of the quantities involved. He may even wish to invert the integral of the second kind, notwithstanding that it is here expressed in terms of the integral of the first kind. Or, again, the statement on p. 266, that  $\phi$  and  $\psi$  "satisfy the conditions required of the potential and stream functions," may lead to misconception, for it is not sufficient that  $\phi$  be infinite at A and C; it must be infinite in the neighbourhood of A like a multiple of the logarithm of the distance from A. And in the same way, on p. 281, in attempting to realise how a "uniform streaming motion parallel to the vector  $ma$ " is consistent with the motion in the strips which is represented by the other factors, we are liable to desire a proof that functions whose equality is not identical, but, as here, the result of proceeding to a limit, necessarily represent the same fluid motion. The fact is that the two functions considered here are not equal for  $\sigma = \infty$ , where  $\sigma$  has a most essential singularity. Or, again, we may wish that the signs had received more attention; as, for instance, on p. 24, or throughout chapter ii., and in many other places. And this the more that Jacobi himself is known to have printed a mistaken sign (for  $cn(K + iK')$ ). And this wish is not allayed by the fact that in the reservation of these difficulties, made on page 45, poles and branch points are mentioned together, as if similar singularities. While, lastly, if we forget the object of the book, we shall most devoutly wish a better recognition of the fact that the Jacobian functions and the Weierstrassian functions are not the fundamental fact of the theory. Underlying both is the same algebraic irrationality, now expressed by a binodal quartic, and now by a cubic curve—from either of which both these functions and many others can be constructed, the distinguishing mark being only the number and position of the poles. One does wish indeed that Prof. Greenhill had found occasion to state somewhere that the algebraic method he adopts throughout, fascinating as it certainly is, is also, in the strict sense employed by him, of only antiquarian interest, in view of the de-

scriptive methods that are available. It is, moreover, essentially incompetent, and therefore unsatisfactory.

But if we pass over such considerations as these, fundamental as they are from some points of view, recognising that in practical life we often count it a saving of time to exhaust the logical consequences of a belief, before painfully verifying the grounds of that belief and recognising that in a new subject it is always the most elementary method that furnishes the easiest introduction, we shall find very much for which to value the book before us—beside the excellent diagrams, index, printing, &c.

*Note 1.*—The result of carrying out in detail the work mentioned at the end of § 194 seems worth introducing into a new edition. The result is partly given in *Math. Tripos*, Part II. 1892. It seems a pity, too, that the expressions for the Jacobian  $Z(u)$  in terms of the Weierstrassian  $\zeta(u)$  are not given.

*Note 2.*—The example 15, p. 351 (though taken from *Math. Tripos*, Part II.), is wrong. The result should be

$$3 \frac{a - mc}{1 + m^3} = \frac{1}{m} (x_1 + x_2 + x_3) = \frac{x_1 - x_2}{y_1 - y_2} (x_1 + x_2 + x_3)$$

where  $y = mx + c$  is the final position of the line.

*Note 3.*—The example 2 (i), p. 140, is misprinted.

H. F. BAKER.

#### THE DISPERSAL OF SHELLS.

*The Dispersal of Shells: an Inquiry into the Means of Dispersal possessed by Fresh-water and Land Mollusca.* By Harry Wallis Kew, F.Z.S. With a Preface by Alfred Russel Wallace, LL.D., F.R.S. With Illustrations. Pp. xi. 291. International Scientific Series, Vol. lxxv. 8vo. (London: Kegan Paul, Trench, Trübner and Co., 1893.)

IT is strange that we have had to wait so long for a manual on dispersal. Many books have been written on the geographical distribution of animals and plants; and islands and even continents have been raised or lowered to account for the strange anomalies. Yet comparatively little attention has been paid to a study that must be undertaken before we are qualified to express an opinion on geographical distribution. Darwin and Lyell, however, thoroughly recognised the importance of the subject, and the former made many experiments on the vitality of seeds under trying circumstances—such as being immersed in sea-water, or eaten by birds. Direct observation of the species in transit, under natural conditions, has been less attended to, except in the case of flying animals and of certain plants. The cause of this neglect is easy to understand: dispersal, in the groups that are not specially modified to assist the process, is mainly the result of the accumulation of rare accidents, such as would only occasionally be noticed by some naturalist engaged in quite different observations. It is useless to go into the field on purpose to watch the dispersal of snails; the entomologist, ornithologist, fisherman, or sportsman may once in a season obtain a direct observation, and it is to such observers that we must principally trust.

In certain respects the land and fresh-water mollusca are peculiarly valuable for the study of geographical distribution; they are essentially sedentary animals; some of them can float, but scarcely any except

*Dreissena* have an active free-swimming larval stage. Few of the species are specialised for dispersal; though we do not think that there is such a complete absence of specialisation as would at first appear. The study of the dispersal of the mollusca becomes, under these circumstances, of great importance to the naturalist; for if snails or their eggs can cross rivers and straits, it is probable that other sedentary groups can do so also.

The system on which Mr. Kew has worked is to collect all the facts relating to the dispersal of land and fresh-water mollusca, giving the authority for each statement. He has thus gathered into one small volume an enormous amount of information, much of which will be quite new to naturalists. Beginning with the fresh-water shells, he treats first of the anomalies in their local distribution, such as their occurrence in perfectly isolated ponds. Then follow chapters dealing with the means of dispersal; and it is surprising how varied these are. Not only are the animals transported down stream on various floating objects, but the author can quote an actual instance in which a number of fresh-water mollusca (*Anodon*) were carried by a whirlwind and fell with the rain. Another interesting case of transportation over dry land is that mentioned by Canon Tristram, who found the eggs of some mollusc, probably *Succinea* attached to the foot of a passing mallard shot by him in the Sahara, a hundred miles from water. A few instances are noted in which birds on the wing have been shot with bivalves adhering to their toes; but there seems to be no recorded case of the occurrence of molluscs or their eggs in the bits of water-weed that so often catch on the feet of aquatic birds. It is probable that this means of transport is common; but being less striking than the other modes, it has not yet been observed. Insects also lend their aid, and a water-beetle (*Dytiscus marginalis*) has twice been captured on the wing with *Sphaerium* attached to its legs; another specimen was caught with *Ancylus* attached to its wing-case. Various other aquatic insects have often been found with mollusca attached to them, though they were not actually caught on the wing.

As regards the land-shells, there is a singular dearth of direct evidence. Mr. Kew is able to mention various ways in which they may have been transported; but the only cases in which the process has actually been observed were some live *Helix caperata* found in a wood-pigeon three days after it had been shot, and an operculated land snail which had caught the foot of a bumble-bee, and was being dragged along. We cannot help thinking, however, that the dispersal of land-shells is a much rarer process than the carrying of fresh-water species. An isolated dew-pond after an existence of ten years will generally yield several species of fresh-water mollusca, and a mediæval fish-pond has quite a large fauna. A church or castle built of limestone, but surrounded by non-calcareous desert, is, for a large group of land snails, the equivalent of an isolated pond; but it is only on very old buildings that one finds colonies of the special limestone species. We have never come across an isolated colony of this sort on a building less than a hundred years old, and have never noticed more than two or three species on a single ruin under such circumstances.

The rest of Mr. Kew's book is devoted to the dispersal of shells by human agency, and to a discussion of the claims of certain species to be considered native in Britain. This part is very good, and, like the rest of the book, is commendably free from bias, though we do not always agree with the author's conclusions. Mr. Kew in a future edition should add a counterbalancing chapter on human agency as preventing the dispersal of snails. We cannot help thinking that the making of fences and the extermination of the larger mammals in Britain has largely stopped the transportation of land-shells. Any one who has noticed the masses of earth that adhere to the flanks of an ox that has slept in a damp meadow, must realise that in the days of the shaggy-haired mammoth, bison, Irish elk, and wolf, dispersal both of animals and plants may have been far more rapid than at present. Lyell has pointed out that seeds may often be carried long distances by a hunted animal, and the same reasoning applies to any small mollusca or their eggs that may be entangled in the long hair. Even the coarsely masticated grass in the paunch of a deer or bison torn to pieces by the wolves might contain living snails, for many of the dry-soil species habitually cling in great profusion to grass stems. Migrating animals, especially the bison, may have greatly assisted in the carrying of both land and fresh-water shells for long distances.

We must congratulate the author on the publication of this excellent manual. It will undoubtedly lead to the accumulation of numerous observations, and we hope soon to welcome a new edition, in which more of the suggested modes of dispersal may be confirmed by actually observed cases. We hope also that the publishers will see their way to the inclusion in the International Scientific Series of volumes on the dispersal of other groups, for the transportation of species from country to country is certainly a subject that should be fully dealt with in a series claiming to be international.

CLEMENT REID.

#### OUR BOOK SHELF.

*The Wilder Quarter-Century Book.* A Collection of Original Papers, dedicated to Prof. Burt Green Wilder at the close of his twenty-fifth year of service in Cornell University (1868-93), by some of his former Students. (Ithaca, N.Y., 1893.)

UNDER the above somewhat fanciful title we have a royal octavo volume of just 500 pages, and twenty-eight plates, which contains some fifteen papers written by former pupils of Dr. B. G. Wilder, Professor of Physiology, Vertebrate Zoology, and Neurology in Cornell University, and dedicated to him as a testimonial of the writers' appreciation of his unselfish devotion to the university, and in grateful remembrance of the inspiration of his teaching and example. Following the practice of some of the German universities, Cornell has been the first among those of the New World to present the teacher with the results of what he has taught; and the idea seems so commendable that a notice, rather than a criticism, of this volume seems all that is demanded at our hands. As a frontispiece to the volume there is a portrait of Dr. Wilder, engraved on wood, by John P. Davis, the secretary of the American Society of Wood Engravers, which is an excellent piece of artistic work. A mere enumeration of the contents of the volume must suffice: Dr. D. S. Jordan, on tempera-

ture and vertebræ, a study in evolution, being a discussion of the relations of the numbers of vertebræ among fishes to the temperature of the water and to the character of the struggle for existence; Susanna P. Gage, on the brain of *Diemyctylus viridescens*, from larval to adult life, and comparisons with the brains of *Amia* and of *Petromyzon*; Dr. G. S. Hopkins, on the lymphatics and enteric epithelium of *Amia calva*; S. H. Gage, on the lake and brook lampreys of New York, especially those of Cayuga and Seneca Lakes; L. O. Howard, on the correlation of structure and host relation among the Encyrtinæ; J. H. Comstock, evolution and taxonomy, an essay on the application of the theory of natural selection in the classification of animals and plants, illustrated by a study of the evolution of the wings of insects, and by a contribution to the classification of the Lepidoptera; Dr. E. R. Corson, on the vital equation of the coloured race, and its future in the United States; Dr. T. Smith, the fermentation tube, with special reference to anaerobiosis and gas fermentation production among bacteria; Dr. H. M. Biggs, a bacterial study of acute cerebral and cerebro-spinal lepto-meningitis; Dr. V. A. Moore, the character of the flagella on the *Bacillus cholerae suis* (Salmon and Smith), *B. Coli communis* (Escherich), and the *B. typhi abdominalis* (Eberth); Dr. W. C. Krauss, muscular atrophy considered as a symptom; P. A. Fish, on brain preservation, with a *résumé* of some old and new methods; W. R. Dudley, on the genus *Phyllospadix*; Dr. J. C. Branner, observations upon the erosion on the hydrographic basin of the Arkansas River above Little Rock.

*Machine Drawing.* By Thomas Jones, M.I.Mech.E., and T. Gilbert Jones, Wh.Sc. (Manchester: John Heywood, 1893.)

THIS book contains properly finished and complete drawings of machinery details taken from recent practice, the authors being of the opinion that the best way to encourage the student to make good drawings is to place good ones before him as copies. Exercises are given which require the student to test his power of making original drawings, by deducing from the complete views given, others which are not given.

One of the authors, being engineering master at the Central Higher Grade Board School, Manchester, has necessarily had much experience in teaching machine drawing, &c., and the present book was designed by him to take the place of the older specimens of drawings, with the intention of placing before the student actual mechanical drawings for copies. This is a step in the right direction, for the nearer mechanical drawing, as taught in the technical school, approaches the real thing in the engineer's office, the better it is for the students. Taken as a whole these drawings represent modern practice, and are good examples. A locomotive coupling-rod is represented on plate xxiv. fitted with a bush keyed in position and retained on the crank pin by a washer and nut of the same diameter as the external diameter of the bush. Bushes in time always get loose in the rod, and in this example there is nothing to prevent the rod coming off the bushes and causing an accident. The nut and washers are screwed on the pin only; these ought to be retained in position by a taper or split pin as well.

The authors give much sensible and good advice on the subject of drawing generally, which if carefully followed by the student will make the drawing a creditable one. The book contains forty plates and many perspective illustrations; it is nicely got up, and should prove of value in our technical schools and colleges.

*Hydrostatics and Pneumatics.* By R. H. Pinkerton, B.A. (London: Blackie & Son, Ltd., 1893.)

THE application and non-application of the integral calculus seems to be a bar which divides many text-books

into two main divisions. In the present work, although the notation of the integral calculus has not been used, yet the method of integration has been explained, and, in fact, applied to the solutions of some problems, such as those of finding moments of inertia, centres of pressure, &c. The treatment of the subject-matter on the whole has, however, been developed by very simple mathematical methods, and although the book is published in the "Advanced Series," it should not for that reason be reckoned as of too high a standard for elementary readers. Indeed the author has inserted several useful introductory chapters to prepare such readers as those who have only an elementary knowledge of the mechanics of solids; thus we are treated to chapters on units, principles of statics, uniform, circular, and harmonic motions. In these chapters, and also in the others dealing with the mechanics of fluids, the author seems to be especially clear in his explanations, and his remarks are in many cases accompanied with diagrams and illustrations, which are always of great help to the reader studying the subject for the first time.

In a work of this kind a student can best obtain a good grasp of the subject by supplementing his study of the text with the working out of numerous typical examples. Those here inserted should be specially useful in this direction, and in many cases they have been divided into two series, the second being of a more difficult type than the first; many of the examples are taken from such sources as the examination papers set at South Kensington, and those for the Civil Service and the Universities.

As a text-book for science schools, and suitable for those wishing to get a thorough insight into the subject, the book will be sure to find favour.

*How to Manage the Dynamo.* By S. R. Bottone. (London: Whittaker and Co.)

IN this book the author gives, in thirty-five short pages, a few practical directions for the installation and management of a dynamo. The instructions given are intended for the use of engineers who have no knowledge of electrical work, but are called upon to undertake the management of a dynamo. It is hardly possible in such circumstances to frame directions which can be intelligently carried out. The dynamo attendant, like every other person in charge of machinery, must really learn by an experience which no manual can replace. The instructions in the text are, however, plainly and simply stated, and deal with some of the more important points connected with the care of dynamos.

An appendix is devoted to the explanation of technical terms used in electricity, and makes up about twelve of the total forty-seven pages of the book. It can hardly be regarded as satisfactory, either in point of accuracy or extent. It is more of a series of detached explanatory statements than a "table of definitions," as the author calls it in the preface.

#### LETTERS TO THE EDITOR.

*The Editor does not hold himself responsible for opinions expressed by his correspondents. Neither can he undertake to return, or to correspond with the writers of, rejected manuscripts intended for this or any other part of NATURE. No notice is taken of anonymous communications.]*

#### The Cloudy Condensation of Steam.

(1) THE fault I have to find with Mr. Bidwell (*NATURE*, December 28, p. 212, 1893) and others who are aiming to revive the chemical hypothesis tentatively broached by the late R. von Helmholtz (*Wied. Ann.* xxxii. p. 1, 1887. *cf.* p. 7 *et seq.*), is that these gentlemen are abandoning a tried theory when its capabilities are far from exhausted. To begin at once with the most recent contribution to our knowledge of the subject, Mr. Bidwell's observation, let a series of excessively

small condensation nuclei be enclosed in a vessel without further interference. They were active before being put there; but after remaining imprisoned for a sufficient length of time, Mr. Bidwell finds them shorn of their power to produce condensation in supersaturated steam. Now, I ask, is it at all probable that these particles will remain distinct throughout the whole time of confinement? I think not. Take the familiar case of fine clay suspended in water. What goes on during subsidence is an agglomeration of particles. This process may be enormously accelerated by small additions of acid or almost any other foreign matter to the water. In ether the speed of agglomeration is so marked, that the (dry) mud which may be suspended in water for weeks, or even months, falls out of ether like so many grains of sand. Witness, furthermore, the case of any chemical precipitate. Those little solid corpuscles were originally all but molecular in size; yet they grew with such enormous rapidity to so enormous a bulk (relatively speaking), that the formed precipitate subsides quickly (in most cases) even in water. Think of those monstrous clots of fresh chloride of silver; think, too, that they were being built up of individual molecules in an instant and before one's very eyes. Then why should condensation nuclei be so good as to remain distinct indefinitely?

In brief, it is not probable that the condensation nuclei<sup>1</sup> if once produced can subsist in their original degree of comminution; for whatever the nature of the acting forces may be, this finely divided matter is in a highly potentialised state relatively to coarser matter, and there will be dissipation of energy by mere mechanical agglomeration even when chemical action is excluded.

(2) Let us look for further confirmation at the size which these active nuclei must necessarily have, remembering that the condensation in question, when properly viewed, always appears coloured.<sup>2</sup> Such condensation presupposes droplets nearly all of the same size; of a size, moreover, which we can reasonably conjecture to lie somewhere between '000,004 centimetre and '000,040 centimetre, depending on the colour selected. This implies that the nuclei which induce coloured condensation must all be of the same size (certainly an improbable condition), or that they must be small even when compared with the small droplets stated. If it were not so, large drops would condense on large nuclei, and small drops on small nuclei (keeping in mind that the whole process of condensation is virtually instantaneous), and there could be no prevailing dimension, and consequently no intense colour.

But it will be asked, will these excessively small particles meet the Kelvin conditions of condensation? Assuredly. One may estimate that pure, dust-free, unconfined steam at 100° would require a pressure of the order of ten or more atmospheres to condense it. Add to this dust particles less than '000,001 centimetre in diameter, and the pressure sinks to 15 centimetres of mercury; in case of particles '000,010 centimetre in diameter, to one or two centimetres of mercury; in other words, to pressure increments<sup>3</sup> certainly met with in steam jets. The fact that nuclei of a few hundred molecular diameters are needed is the very feature of these experiments, and explains why smoke and other coarse material is useless, and why the condensation-producing dust must be so highly specialised.

(3) Nuclei, it is true, are often equally active if derived from liquids, the mixture obtained by passing air over very strong sulphuric acid being a notable example. Let us remember, however, that these active liquid bodies (acids all of them, while ammonia is not active) may form sulphate of ammonia in contact with atmospheric air. But if this view of the case be unsatisfactory, is there anything in Lord Kelvin's well-known equation connecting vapour tension and curvature which asserts that the nuclei must be solid?

(4) I have equally great difficulties in submitting to the diverse electrical hypotheses put forth, and I cannot understand why so astute and sound-minded an investigator as Mr. Aitken should hazard his birthright for that mess of electrical pottage. It is certain that air passing across an active spark gap will produce condensation; but it is equally certain that no electric field will

<sup>1</sup> It must not be forgotten that the imprisoned nuclei are mixed with the nuclei normally present in air. Whether the mixture is pronounced active or not, depends on the sensitiveness of the test applied. Thus there is room for an error of judgment. I recur to this in § 6.

<sup>2</sup> I here include the opaque field mentioned in Mr. Aitken's and in my own articles, since it obeys clean cut colour laws.

<sup>3</sup> Pressures between 1 and 50 centimetres above the atmosphere were necessary in my work.

be wafted down a metallic tube three or more metres long by a draught of air—a crucial test which I believe to have been the first to make, though Mr. Bidwell does not affirm it. If charged particles, dissociated particles, and the like are sucked down there, I must insist that the said charged or dissociated particle—whatever befall it—is a particle still! If it is not small enough, it will fail to stimulate condensation in any case or theory. If it is small enough, it *must* produce nuclear condensation *per se*, no matter how the particle is otherwise conditioned.

Aside from this, the electrical theory becomes more seriously entangled by the fact that the jet itself is no mean generator of electricity. I made a few tests on this point in the line of Faraday's classical researches, and obtained marked charges from the jet, increasing with its intensity.

(5) I cannot claim much indulgence for my experiments in air filtration, though I went through them laboriously enough. But the work taught me, at least, the extreme elusiveness of such a thing as "dust-free" air. Naturally I am biased, therefore, in regard to arguments, in the present case, based on filtration. Suppose an oxyhydrogen flame burning in filtered air is an active dust producer. The question at once arises on what kind of hearth is the flame kindled: if it burns from a glass tube, then sodium is probably volatilised; if from a metallic tube, then the metal is similarly in danger; if from no base at all, then where is the flame? In what does the remarkable activity of flames really consist? Most reasonably, it seems to me, in this, that particles therein entrapped are (as a rule) at once volatilised, so that for each single particle we have now a whole cloud of active nuclei precisely the kind wanted in § 2; *i.e.* myriads of them, all in that extreme degree of tenuity which best promotes condensation. In my work, glowing smokeless charcoal often did better service than flames. Alkalies are here ready for volatilisation. In general, hot flames are more active than colder flames (Helmholtz, and they should be where disgregation is needed.

Finally, a word with regard to red-hot platinum. "Here," says Mr. Bidwell, "there can be no nuclei formed of products of combustion, for there is no combustion, simply ignition and incandescence." Is it possible that Mr. Bidwell is not aware that red-hot platinum is particularly remarkable for scattering small solid particles from its surface? If so, he has narrowly escaped being overwhelmed by the literature of the subject. Aside from this, what may be the nature of platinum dissociated at red heat?

(6) To conclude: I cannot discern that the proof of anything beyond condensation of supersaturated steam, induced by mere "meit" nuclei, has yet been given. Nothing is even said of atmospheric air, which indoors or out, stagnant or fresh, is always active; nor is it even hinted at that the effect of dust is merely an accentuation of the effect produced by such air; that dust-stimulated condensation differs merely in degree, by no means in kind, from jet condensation in air. Air nominally purified needs only a higher degree of supersaturation to evoke condensation running through the whole gamut of colours. There are no hard drawn lines. I wish there were. Indeed, I wish the proof in question could or had been adduced, for, together with my colleague Prof. F. H. Bigelow, I am well aware of the important meteorological consequences to which this result would lead. But before I can break away from the time-honoured point of view, so safely trusted by the Kelvin formula, the experimental evidences forthcoming must be as rigorously "dust-fall" as the clear conscience with which I am disposed to admit them.

CARL BARUS.

The Smithsonian Institution, Washington, D.C., U.S.A.

### The Origin of Lake Basins.

THE question of the origin of lake basins has again been raised, and, unfortunately, there is even now the same diametrical opposition between the views of the glacialists and their adversaries. Though the old lines of argumentation, perhaps, have not been followed out with sufficient perseverance, new starting-points certainly seem desirable. I should therefore like to challenge the criticism in your columns on a demonstration of the glacial origin of the greatest fjord basins in Norway.

On the western coast of Norway we have the well-known series of great fjords, generally of enormous depth, about 400 fathoms in Hardangerfjord, 600 in Sognefjord, and 300 in Nordfjord, to take only the greatest. The heads of the innermost

branches are nowhere at a greater distance than some twenty miles from the watershed of the country, and the necks between them nowhere as much as forty miles. When for some reason, change of climate or rise of land, the snow began to gather on the neighbouring plateau, the highest in Scandinavia, glaciers would creep down the steep slopes and valleys, and immediately get to the deep fjords. But here the glacier ends must needs be carried away or dissolved as fast as they came on. By the necessarily slow growth of the narrow névés, it is impossible that the glaciers could advance at once with so great dimensions that the fjords were not able to master them successively. Over the narrow necks between them an ice cap certainly might push farther out, but as there is less than twenty miles to draining outlets on either side, this cap could attain no considerable thickness, and bring no great ice flow westwards from the high land behind. On the lower foreland, near the coast-line, there is nowhere sufficient gathering basin for a great névé, and the small fjord branches could easily drain their eventual surplus. My opinion is, then, that no great inland ice could possibly advance farther west in Norway than to the close set row of fjord-heads.

It may be said that the whole country in the great Ice Age was so much elevated that the fjords were only dry valleys. But no amount of elevation could ever drain fjord troughs generally 300 to 600 fathoms deep, and only 100 to 150 wide at the brim. And an adequate differential lift of the inner side of the troughs would give the old palæozoic mountains in Norway the height of the youngest mountain ranges, and is on the face of it impossible. It may be further said that ice from the high land behind the watershed might have contributed to the supply, and that the glaciers then would be large enough. But even in this case they must needs commence as small ice tongues, which would be cut off successively; and the boulders show that no transport from any distance behind the watershed took place during the great Ice Age.

The idea I have put forward is capable of maintaining itself by its own power, but its position is greatly strengthened by direct facts. It can be demonstrated that a great inland ice *has* tried to advance from the high land westward beyond the fjord heads, and signally failed. This was the case in the last Ice Age, of which we can trace all the prominent signs. As the ice cap was not able to build itself up to any great dimensions near the western precipices to the fjords, its greatest height was piled up farther to the south-east, and the ice shed was drawn in the direction of the eastern margin, down the eastern valleys. From this time we find boulders transported up the eastern slope from a distance up to eighty miles from the watersheds, and these boulders can be followed in great heights in the western valleys only to the fjord-heads, when they suddenly drop down to the old sea beach. This shows, beyond all doubt, that the glaciers from the second inland ice which far away to the south-east laid up the upper till in Prussia, on the north-western side, only reached the fjord-bottoms, and were not able to fill the fjords. We have in this an empirical proof of my idea. An inland ice is really not able to advance beyond a close set row of deep depressions as the Norwegian fjords.

But yet we have unquestionable proof that the exterior part of the west coast was extremely glaciated. Just in the mouth of the great Sognefjord itself we have the Sulen Isles with rock scorings and eastern erratics (but none from behind the watershed) up to 1800 feet above sea level, 5400 feet above the fjord bottom. How can these boulders have been transported across this abyss when no inland ice could ever have advanced beyond the fjord head, and no local glaciers from the peninsula on either side could ever have crossed the deep channels, or piled itself up to sufficient height here only a few miles from the steep slope to the Atlantic Ocean basin? I cannot see any way to account for these facts other than by the supposition that the fjords or depressions of the same kind and depth did *not* exist when the first great inland ice was forming, but were quite completed when the second (and last) commenced. *Ergo*, the Norwegian fjords are of early glacial or interglacial origin.

At this point of my reasoning comes in the conclusive series of arguments which puts any other origin than glacial erosion quite out of question for this peculiar flat troughs in old solid azoic and palæozoic country. I wish to lay especial stress upon the fact that Norwegian geologists for many years have laid great weight upon the really marvellous circumstance of lake-distribution only in glaciated districts, as one of the best of the many indirect proofs of the glacial origin of rock basins. I should think,



however, that when the origin in glacial time of the grand Norwegian fjords is sufficiently proved, their origin by glacial forces will be more easily granted. The same may certainly be said of the far smaller lake basins in Norway, for which an analogous demonstration can be given. That the fjords now must really be of pleistocene origin is the point I wish to make in this letter. Only if anyone can, in a simple manner, explain how an inland ice could be able to pass the close set row of fjord heads, is it possible to dismiss my argument.

ANDR. M. HANSEN.

University Library, Kristiania, January 29.

A FEW words are due from me in reply to the kindly criticisms of my suggestion regarding the erosion of rock basins that have appeared in NATURE since its publication on November 9, 1893.

In the first place, I must apologise to Sir H. Howorth for having misunderstood his remarks on the plasticity of ice in his letter of July 13, a misunderstanding due, of course, to my not having had an opportunity of reading the chapter devoted to the subject in his book. Unfortunately the libraries of our small outlying stations in India do not as a rule provide us with works of scientific interest, and the conditions of life of most of us who take an interest in such subjects out here force us to content ourselves with the possession of very few books of the kind, and only those that are absolutely necessary for our work. Provided that it is admitted that the plasticity of glacier ice is sufficient to allow motion in the upper layers of a glacier, even when it rests on a nearly level surface, it does not matter, so far as my hypothesis is concerned, whether the bottom layers move or not, for a movement of the upper layers alone is required to enable the "moulins" to transfer their action from place to place, and in time to exert their force on every part of the rock surface beneath that portion of the glacier.

That the action of the "moulins" is not so restricted as would appear from Prof. Bonney's letter in NATURE of November 16, 1893, can, I think, hardly be doubted by any one who has traversed a Himalayan glacier of the kind I have described, on a hot summer's day. Hundreds of them may be seen in action in every direction, and, given sufficient time, their aggregate effect in wearing down the rock surface must be very large. I have noticed the dry shafts mentioned by Prof. Bonney in front of an active "moulin," but do not see why they should not be accounted for by the opening of a new crevasse, without having to suppose that the new crevasse was in the same position as the old one. The crevasses to which I refer are mostly very narrow, easily stepped across in many cases, and do not appear to extend far down into the glacier, so that they are probably due to some other cause than an unevenness of the rocky floor, which would cause them to form in succession at the same point, and their number would give the "moulins" plenty of opportunity to attack the whole surface in course of time. Besides, the wearing away of any inequality that did exist, would surely cause the crevasse to open at some other point, if it were due to that cause, and the "moulin" would thus be enabled to shift its point of attack. The very rarity, too, of such collections of "giant's kettles" as that at Lucerne would seem to show that it is seldom that the "moulins" keep working at one point for any length of time. I did not mean to suggest, of course, that any lake basin had been due to the action of one "moulin"; the hollow ultimately produced need not bear any relation in form to the individual "giant's kettles" that gave rise to it; indeed, there is no necessity that a real "giant's kettle" should be formed at any one point. Just as in the case of a drill moved over the surface of a piece of wood, the pattern ultimately produced need bear no relation to the form of the drill.

If we except the doubtful action of the ice itself, I do not know of any agent that will produce a rock-enclosed hollow in the course of a river channel, but falling water, aided by boulders and sediment. Such a hollow may be seen at the foot of any waterfall, even of moderate height.

In calling attention to the rarity of true rock basins in the Himalayas, an expression that Mr. Oldham takes exception to, I should have said lake basins, that is, lakes lying in true rock basins. As I pointed out, any hollows that may have been formed beneath a pre-existing glacier have been filled with debris, but it is very likely that such hollows do occur beneath the extensive flats found at the foot of the larger glaciers, as in

the case of the one shown in the view given in my paper. Of course, where such hollows occur in positions where it is impossible that glaciers ever existed, as in eastern Baluchistan, they must be accounted for in other ways. My suggestions were not intended to account for all rock basins, but merely to apply to those which occur in now or formerly highly glaciated regions, where it seems possible that there is an intimate connection between the excavation of the basins and the existence of glaciers. Sukkur, January 10. T. D. LATOUCHE.

A Plausible Paradox in Chances.

IT seems worth while to record the following pretty statistical paradox as a good example of the pitfalls into which persons are apt to fall, who attempt short cuts in the solution of problems of chance instead of adhering to the true and narrow road. It is true that the paradox would excite immediate suspicion in the mind of any one accustomed to such problems, but I doubt if there are many who, without recourse to paper and pen, could distinctly specify off-hand where the fallacy lies. It will be easy for the reader to make the experiment of his own competence to do so after reading to the end of the second of the two following paragraphs.

The question concerns the chance of three coins turning up alike, that is, all heads or else all tails. The straightforward solution is simple enough; namely, that there are 2 different and equally probable ways in which a single coin may turn up; there are 4 in which two coins may turn up, and 8 ways in which three coins may do so. Of these 8 ways, one is all-heads and another all-tails, therefore the chance of being all-alike is 2 to 8 or 1 to 4.

Against this conclusion I lately heard it urged, in perfect good faith, that as at least two of the coins must turn up alike, and as it is an even chance whether a third coin is heads or tails; therefore the chance of being all-alike is as 1 to 2, and not as 1 to 4. Where does the fallacy lie?

It lies in omitting one link in the chain of the argument as being unimportant, whereas it is vital. This omitted link is distinguished by brackets and is numbered (3) below. The reasoning then stands:—

- (1) At least two of the coins must turn up alike,
- (2) It is an even chance whether a third coin is heads or tails.

{(3) Therefore, it is an even chance whether the third coin is heads or tails. (Here is the error.)}

The true state of the case is seen by writing out the eight several events, as in the table below.

| The eight equally probable events.<br><i>h</i> = heads, <i>t</i> = tails. | The two letters that are alike in each case. | The third letter in each case. |
|---------------------------------------------------------------------------|----------------------------------------------|--------------------------------|
| <i>h h h</i>                                                              | <i>h h</i>                                   | <i>h</i>                       |
| <i>h h t</i>                                                              | <i>h h</i>                                   | <i>t</i>                       |
| <i>h t h</i>                                                              | <i>h h</i>                                   | <i>t</i>                       |
| <i>h t t</i>                                                              | <i>t t</i>                                   | <i>h</i>                       |
| <i>t h h</i>                                                              | <i>h h</i>                                   | <i>t</i>                       |
| <i>t h t</i>                                                              | <i>t t</i>                                   | <i>h</i>                       |
| <i>t t h</i>                                                              | <i>t t</i>                                   | <i>h</i>                       |
| <i>t t t</i>                                                              | <i>t t</i>                                   | <i>t</i>                       |

No. 2 in the argument is justified by the total number of the *h*'s in the third column being equal to that of the *t*'s, while No. 3 is obviously not justified. In the particular 8 events with which we are concerned, an *h h* is associated with a *t* three times as often as with an *h*, and a *t t* is associated with an *h* three times as often as with a *t*. Hence as the combination *h h h* is one-third as frequent as that of any 2 *h*'s and 1 *t*, and as *t t t* is one-third as frequent as any combination of 2 *t*'s and 1 *h*, and, lastly, as the two classes of combinations are equally frequent, it follows that the frequency of the all-alike cases is to that of the remainder as 1 to 3, or to that of the total cases as 1 to 4, which is the result first arrived at.

I amused myself with testing the theoretical conclusion by making 120 throws of dice, 3 dice in each throw; the odd

numbers counted as heads, the even numbers as tails. The 120 throws were divided into 3 groups of forty in each, and gave the results of all-alike 8, 12, 8, total 28; as against not all-alike 32, 28, 32, total 92. The most probable expectation having been 30 to 90.

FRANCIS GALTON.

#### Clerk Maxwell's Papers.

I DO not know whether the Clerk Maxwell Memorial Committee have ceased from their labours, but I cannot help thinking that more might be done towards rendering the work of Maxwell more readily accessible to students. The pair of ponderous volumes issued by the Committee are very well in their way, but they are certainly bulky, and the chronological order of papers, though eminently suited to their purpose, is not so suited to the practical needs of students.

For instance, the papers on the kinetic theory of gases seem to me far and away better than much that has been written since, and it would be very convenient to be able to procure them separately.

My suggestion is, then, that with the aid of a moderate subsidy a publisher be induced to issue Maxwell's papers on special subjects in cheap, handy, separate volumes, which might run somewhat as follows:—

- On Colour and Optics.
- On Graphical Statics.
- On the Kinetic Theory of Gases.
- On Dynamical Problems.
- On Electro-dynamics.
- Lectures and Addresses.
- Articles and Reviews.

Under one or other of these heads almost all the papers could be included; there would be no need to include anything that did not seem likely to be of frequent use. The series of small books would be a boon to students, and a knowledge of the work of their great author would be more widely spread.

OLIVER J. LODGE.

#### Abnormal Eggs.

THE occurrence entitled "A Curiosity in Eggs," related in NATURE for February 1, is by no means as unusual as your correspondent imagines. It occurs in domestic poultry from over-stimulation of the system by generous feeding. The explanation of the production of one egg within another is very simple. The ovum or yolk when mature is received into the upper part of the oviduct, a tube nearly two feet in length in the domestic fowl, and in its descent is clothed successively with the layers of albumen or white, the lining membrane of the shell, and finally, on arriving at the calcifying portion of the oviduct, is enveloped in the shell. In the ordinary course of events the mature egg is then expelled, but in the case of the production of a double-yolked egg, a reverse action of the oviduct occurs. In place of being expelled, the egg is carried back again to the upper portion of the oviduct, where it meets with another mature ovum, and the two descend together, both being surrounded with a second investing series of albumen, membrane, and shell.

Some of the occurrences connected with abnormal eggs are very remarkable. I had one forwarded to me during the last month, which was alleged to contain a marble. On examination I found that the supposed marble was a small abortive yolkless egg, which in colour and form, but certainly not in weight, closely resembled a common clay toy marble. It is not infrequent for persons to allege the occurrence of various foreign bodies in eggs. The most common substance said to be found in an egg is a horse-bean, which is closely simulated by a mass of hard coagulated blood which has escaped from the ovarium into the oviduct, and is included along with the yolk in the investing structures. I need not further allude to such circumstances as a horse-hair in an egg, or a small coin not unfrequently found at the breakfast-table, inasmuch as these are merely the result of practical joking, and require no further explanation. There is, however, one circumstance that may interest some of your physiological readers, and that is the extreme rarity of the hatching of any egg the shell of which is in the slightest degree malformed. In my own experience I have rarely, if ever, found an egg the shell of which was in the slightest degree unsymmetrical, that has been channeled at one end, or having an irregular zone around the middle, to produce a chicken. The occurrence of two ova in the same egg

is by no means uncommon. It results from excessive feeding, and rarely, if ever, occurs in a state of nature. I have known two perfect birds, both chicken and pigeon, produced from such an egg, but the more general result is that the two ova, being developed together, coalesce, possibly from want of room to develop in the confined space, and thus arises the presence of two-headed, or six or eight-limbed monsters, which are much more frequent in fowls than in any other animals whatever. I have from time to time forwarded specimens of these abnormalities to the museum of the College of Surgeons, where they may be seen by those who are interested in the subject.

W. B. TEGETMEIER.

North Finchley.

ON two occasions fully shelled eggs of about the size of those of the thrush have been found by myself within ordinary hen eggs, one of which is still in my possession. Several times I have hatched twin chickens from double-yolked eggs, and once a monstrosity having four legs.

Shirenewton Hall, Chepstow.

E. J. LOWE.

#### THE PLEIADES.

AMONG the many constellations and star clusters which attracted the attention of our early ancestors, few, indeed, were so constantly observed as that small bunch of twinkling brilliants known as the "Pleiades." From a very early date, when our forefathers were not so well acquainted with the divisions of the year as we are to-day, they needed some means by which they could tell when to sow their corn, and make arrangements for other agricultural pursuits which could only be done properly in their right seasons. That they could, at any rate, get a rough approximation of such divisions of the year by means of the positions of the heavenly bodies, they soon found out, and they were thus led to observe sometimes stars, sometimes groups of stars, near the rising or setting of the sun, and even certain stars, or groups of stars, at their times of rising and setting.

That they should have chosen that group of sparkling stars, the Pleiades, to serve their purpose, does not seem at all astonishing if one considers how easily they can be recognised in the sky, and also their important position in more remote times.

The different relative positions of the sun and the Pleiades had no doubt first attracted special attention to this group of stars, and we know how important a rôle they played in ancient times for calendar purposes?

Let us just consider the several positions of the Pleiades as a result of the earth's rotation and revolution round the sun. Commencing about the end of May, we find that the Pleiades are altogether invisible, as they rise and set together with the sun. As time goes on, they will appear above the horizon before the sun, the difference in the time of rising of these two objects gradually increasing. In August the Pleiades cross the meridian about the time the sun rises, and by the end of November they are visible throughout the whole night, their upper culmination taking place at the same time as the lower culmination of the sun. As November draws to a conclusion, they set earlier and earlier, and by the end of February are visible only for a short time, disappearing altogether for a time after the middle of May.

Owing, however, to a slight movement of the axis of the earth, which makes a revolution round the pole of the ecliptic once in about 25,800 years, the point of intersection of the ecliptic with the equator is not fixed but movable; thus we can understand that the positions of all heavenly bodies as regards their right ascensions and declinations suffer a continual but slow alteration.

This slow movement explains the reason why the Pleiades have not always been invisible at the end of the month of May, and we have only to form a simple

calculation to become acquainted with the fact that about 2000 years ago this period of invisibility occurred nearly a month earlier.

A very interesting point relating to the Pleiades is the great number of different names which have been applied to them, and also the curious myths which have arisen from time to time. A most interesting account of these has recently been published by M. Richard André,<sup>1</sup> who has brought together a mass of matter relating to both names and myths. First, with regard to the names which were used when referring to the cluster. The general words defined them as a heap, troop, host of dancers, sieve, &c.; sometimes the simple word "many" was adopted. One finds them spoken of as herds, or hosts of animals, birds, such as hen with chickens, parrots, doves, &c. The simplest expressions really used meant "mass," and an examination of the records confirms this view.

In observing the Pleiades anyone would remark how closely they are packed together. This closeness led early peoples, no doubt, to refer to them as a host or herd of animals, and hence the well-known name, "the hen with her chickens."

Among many foreign names for this, we have in German, *Der Glucke mit ihren Küchlein*; in Danish, *aftenhøne* (evening hens); in French, *la poussinière*; in Italian, *gallinette*, &c. Instead of a host of animals, we have a host of people referred to, such as, for instance, in the Solomon Islands, where they are called "togo ni samu," meaning a company of maidens. The North American Indians have also known them under the name of "dancers."

It may be thought that a natural name by which they would be known would give some idea of the number of stars in the group; this was often the case, only with different names, for a very good pair of eyes could distinguish seven stars, while generally only six were counted. The word for the Pleiades, for instance, in old high German was "thaz sibunstirri" (seven stars), while that of the South Americans, "cajupal," meant six stars. Again, in Cook's Islands the word "Tau-ono" (six) was used, while the Greeks had a special name for each of the seven stars.

Seeing that so much importance has been attached to the Pleiades by peoples of all countries, it is natural to find that the number of myths is by no means few; this is shown to be the case by examining the records of the ancient Greeks, the peoples from East Asia, South Sea Islands, America, &c.

To describe a few briefly, let us refer first to that which we owe to the Greeks. The Pleiades in this myth were the daughters of Atlas and Pleione, each one of which bore a separate name. The Hyades, for sorrow at the death of their sisters, or, as others say, at the destiny of their father, Atlas, killed themselves and became fixed as a constellation in the heavens. Another myth, by Pindar, describes them as the comrades of Artemis, who were turned into doves, and eventually into stars.

A myth of much interest is that of the Dyaks, and the Malays of Borneo. They say the Pleiades were six chickens followed by their mother, who remained always invisible. At one time there were seven chickens in all. One chicken paid a visit to the earth, and there received something to eat, at which the hen got so angry as to threaten to destroy both the chicken and the people on the earth. Fortunately the latter were saved by the constellation of Orion, leaving only six chickens in the brood. At that period of the year when the Pleiades are invisible, the Dyaks say that the hen broods her chickens, while at the time of visibility "the cuckoo calls."

The South Sea islanders have a myth which has some originality about it. It is to the effect that the Pleiades

were originally a single star, which shone with such a clear lustre as to incur the envy of the god Tane, who was in league with the stars Aldebaran and Sirius, and followed the Pleiades. Trying to save himself in a stream, the course of which Sirius had so diverted as to bring him close to Tane again, he was broken up into six bright stars by Tane himself, who hurled Aldebaran at him.

The blacks of Victoria, Australia, have a myth in which the Pleiades are considered a host of young wives who play with the young men. The myth of the Kamilaroi blacks is as follows: The Pleiades were once pretty maidens on the earth, who were followed by some young men called the Beriberi. To get away from the latter the girls climbed trees, and thence sprang into the heavens, where they were transformed into shining bodies; one maiden who remained behind was termed "gurri gurri," the shy one, and she is represented by the least bright star in the group. The Beriberi were eventually placed in the heavens, where they appear in the girtle and boomerang in the constellation of Orion.

These and many other myths, all of great interest, are mentioned by M. André. They inform us to a certain extent of the characters of the different nations. Much might be learnt also about the origin of the various tribes of people, by seeing if the different myths can be traced back to an initial one. Those of the North American tribes, for instance, seem to have a common origin. In some instances the Pleiades were undoubtedly looked upon as a god who, besides regulating the year and looking after the fruitfulness, was the ruler of all meteorological and astronomical appearances. Hesiod refers to the rising of the Pleiades as the time for harvest, while the period about which they disappeared for some time he termed ploughing time. Forty days and nights were they invisible, appearing again only as soon as the sickle was sharp. Another very well-known use made of the visibility and invisibility of the Pleiades was the regulation of the traffic of ships in Greece, hence probably the Greek word for to sail, *πλεειν*. The rising of this group of stars was the commencement, so to speak, of the shipping season, their disappearance denoting its conclusion. At Rome, also, the same practice was in vogue.

Enough has been said to attract the reader's attention to some of the numerous interesting references about this group of stars. The nineteenth century has already seen the end of many a myth which has been solidly upheld; but as science advances, facts take the place of myths, and although much of the romance may appear to be lost, one always looks back at them with delight. Few stars, perhaps, have been so shrouded in myth as the Pleiades, and the unravelment of these myths has been the source of pleasure to many.

#### NOTES.

A MEETING of the International Meteorological Committee has been arranged to take place at Upsala, commencing August 20. Since the meeting at Munich in 1891, four new members have been added to the committee—Mr. William Davis, Cordoba; Mr. John Eliot, Calcutta; Mr. R. L. J. Ellery, F.R.S., Melbourne; and Dr. A. Paulsen, Copenhagen. The last named has replaced Dr. Lang, Munich, who died last year.

THE arrangements for the sixth session of the International Geological Congress have now been made. The meeting will be held at Zurich, from August 29 to September 2. The president is Prof. E. Renevier; Prof. A. Heim is vice-president, and Prof. H. Golliez, of Lausanne, is secretary. The subscription is twenty-five francs, which should be sent to M. Casp. Escher-Hess, Bahnhofstrasse, Zurich. In addition to the

<sup>1</sup> See *Globus*, Bd. Lxiv. No. 22, "Die Plejaden im Mythos und in ihrer Beziehung zum Jahresbeginn und Landbau."

ordinary work of the congress, special meetings will be held for the discussion of questions relating to (a) general geology, tectonics, &c.; (b) stratigraphy and palæontology; (c) mineralogy and petrography. Numerous excursions have been planned; six, before the congress, to different parts of the Jura, and six, after the congress, to various districts of the Alps; three supplementary excursions are also proposed. Mr. W. Topley (28, Jermyn-street, London), who acted as general secretary to the London Congress in 1888, will be glad to receive subscriptions or to give information.

A MEETING to consider the question of raising a memorial to the late Prof. Arthur Milnes Marshall, F.R.S., was held at the Owens College on Friday last. Mr. Edward Dormer (deputy-treasurer of the College) presided, and there were present, amongst others, Principal Ward, Profs. Boyd Dawkins, Osborne Reynolds, Schuster, Weiss, Leech, Herdman, and Dixon, Dr. Hurst, Messrs. R. D. Darbishire, Forbes Carpenter, R. Assheton, F. W. Gamble, and W. E. Hoyle. The meeting was addressed by Principal Ward, Mr. Darbishire, and others, and it was decided to form a committee to formulate a scheme, and submit it to a future meeting. Although no definite decision as to the nature of the memorial was arrived at, the general sense of the meeting seemed to be in favour of a fund to maintain Prof. Marshall's library, which has been generously presented to the College by his family.

H.R.H. THE DUKE OF CAMBRIDGE has accepted the presidency of a committee which has been formed to present a testimonial to Dr. W. H. Dickinson on his retirement from the office of senior-physician to St. George's Hospital, of which his Royal Highness is a vice-president. Among the members of the committee are the Duke of Westminster, the Earl of Cork and Orrery, Mr. Shaw Stewart, and Colonel Haygarth, vice-presidents of the hospital; Mr. J. R. Mosse, treasurer; Sir Henry Acland, Admirals Sir George Willes and Sir W. Houston Stewart, Sir George Humphry, Sir Francis Laking, Surgeon-General Cornish, and a number of Dr. Dickinson's past and present colleagues, and pupils and former students of the St. George's Medical School.

THE death is announced of Brigadier-General J. Ammen, who for some years held the Chair of Mathematics in Bacon College, Georgetown, Kentucky, and that of Jefferson College, Mississippi.

THE Right Hon. Sir Harry Verney, whose death, at the age of ninety-two, occurred on Monday last, was the "father" of the Royal Agricultural Society of England—an institution which he assisted to establish in 1838.

LORD PLAYFAIR has selected "The Modern Needs of Scientific Teaching" as the title of his address to the students of the London Society for the Extension of University Teaching, at the Mansion House, on Saturday, March 10.

MR. HOLBROOK GASKELL having contributed £1000 to complete the endowment of the Chair of Botany at Liverpool University College, the college council have decided to confer the professorship upon Mr. R. J. Harvey Gibson, who has held the lectureship in botany during the last five years.

THE Council of the Royal Meteorological Society have arranged to hold an exhibition of instruments, photographs, and drawings relating to the representation and measurement of clouds, next April. The Exhibition Committee invite co-operation, as they are anxious to obtain as large a collection as possible of such exhibits. The committee will also be glad to show any new meteorological instruments or apparatus invented or first constructed since the exhibition of 1892, as well as photographs and drawings possessing meteorological interest.

AMONG the documents in the possession of the Anthropological Institute are a considerable number of MS. vocabularies, in many cases unique in their character. As it has never come within the scope of the Institute to devote a large portion of its *Journal* to the publication of such material, a fund is being raised by subscription, independently of the Institute, to deal with these documents. The subscription is one guinea, payable in alternate years, and the first vocabulary to be published will be one of the Ipuriná Language (Upper Purus River), South America, by the Rev. J. E. R. Polak.

WE learn from the *Kew Bulletin* for February that an excellent portrait of Prof. Oliver, F.R.S., the late keeper of the Herbarium and Library of the Royal Gardens, Kew, has been painted by Mr. J. Wilson Foster (who also painted the portrait of the present keeper, Mr. J. E. Baker, F.R.S., exhibited at the Royal Academy in 1893). Prof. Oliver's portrait was commissioned by a number of his scientific and other friends, who have presented it to the Herbarium of the Royal Gardens—the scene of his labours from 1858 to 1890.

AN appeal for assistance has been issued by the committee of the Bethnal Green Free Library, there being a deficit of £200 on the last financial year, while the outlay of the present one is calculated to reach £1,000. The work that this institution is doing is an excellent one, and the fact that no less than 50,000 persons attended the library and classes, &c. in connection with it, and 27,000 the Gilchrist Educational Trust Lectures, tells it is filling a real want. It will be a pity if such a good work should languish for want of funds, subscriptions towards which may be sent to Mr. G. F. Hilcken, the secretary and librarian, Bethnal Green Free Library, London, E.

THE *Academy* says that the Hon. Walter Rothschild proposes to publish a periodical in connexion with his Museum at Tring, under the title of *Novitates Zoologicae*. It will contain papers on mammals, birds, &c., and also discussions on general questions of zoological or palæontological interest. Descriptions of new species will be confined almost entirely to those of which the types belong to the Tring Museum; and the other articles will, for the most part, be founded on work carried on at that museum, or on specimens sent by Mr. Rothschild's collectors.

MR. LLOYD BOZWARD, writing to us from Worcester, says that on the 6th instant, shortly after noon, he saw a large meteor of great brightness near the zenith. At the time of the occurrence, the sun was brilliantly shining in a clear blue sky. A remarkable feature was the intensity of the light of the meteor. According to Mr. Bozward, this, if not exceeding the radiance of the sun, was certainly equal to it. The meteor was also seen at Birmingham, several observers comparing its light to that given by the electric arc, while others say that it was of a vivid green colour.

THE Royal Society of New South Wales offers its medal and £25 for the best communication (provided it be of sufficient merit) containing the results of original research or observation upon each of the following subjects, to be sent in not later than May 1, 1894:—On the timbers of New South Wales, with special reference to their fitness for use in construction, manufactures, and other similar purposes; on the raised sea-beaches and kitchen middens on the coast of New South Wales; on the aboriginal rock carvings and paintings in New South Wales. To be sent in not later than May 1, 1895:—On the silver ore deposits of New South Wales; on the physiological action of the poison of any Australian snake, spider, or tick; on the chemistry of the Australian gums and resins. To be sent in not later than May 1, 1896:—On the origin of multiple hydatids in man; on the occurrence of precious

stones in New South Wales, with a description of the deposits in which they are found; on the effect of the Australian climate on the physical development of the Australian-born population. The competition is in no way confined to members of the Society, nor to residents in Australia, but is open to all without any restriction whatever, excepting that a prize will not be awarded to a member of the Council for the time being; neither will an award be made for a mere compilation, however meritorious in its way. The communication, to be successful, must be either wholly or in part the result of original observation or research on the part of the contributor. The successful papers will be published in the Society's annual volume. Competitors are requested to write upon foolscap paper, on one side only. A motto must be used instead of the writer's name, and each paper must be accompanied by a sealed envelope bearing the motto outside, and containing the writer's name and address inside. All communications to be addressed to the honorary secretaries, Messrs. T. W. E. David and J. H. Maiden, at the Society's House, Sydney.

A VERY severe gale reached the coast of Ireland from the Atlantic on the evening of Sunday the 11th instant, the centre of which passed over Scotland; much snow fell there during the passage of the storm, and the barometer reading was as low as 28.2 inches. The force of the gusts reached 10 to 11 of the Beaufort wind-scale (0-12), and owing to the steepness of the barometric gradients the storm was felt over all parts of England, and caused much damage both at sea and on land. At Greenwich, which was about 300 miles from the centre of the disturbance, the anemometer registered a pressure of more than 35 lbs. on the square foot, being equal to an hourly velocity of about 85 miles. In connection with these values it may be interesting to state that in the gale of December 12 the wind at Greenwich attained a pressure of 37 lbs. on the square foot; but in the great storm of November last it did not there exceed 17 lbs. By Monday, the 12th instant, the centre had passed over the North Sea, and the barometer near Christiania had fallen below 28 inches, gales being experienced from the coast of Ireland to the Baltic. In the rear of the disturbance the temperature, which had been unusually high for the time of year, fell considerably, frost occurring in many parts of Great Britain on Monday night.

WITH reference to the above gale, Dr. Buchan writes that at Edinburgh a remarkable fall of the barometer commenced at 5 a.m. on Sunday last, and 2 a.m. on Monday the low reading of 28.319 inches at 32" and sea-level was registered. An unusually rapid rise then set in, and in the one hour from 4 to 5 a.m., pressure rose 0.307 inch, as recorded by Richard's barograph, controlled by readings with the mercurial barometer. The traced line of the barograph was clear and distinct, giving little if any indication of "pumping." Consequent on a change of wind from east-south-east to south-west, Richard's thermograph registered a rise of temperature from 37.5 to 48.0, or 10.5 in the seven minutes ending 1.10 p.m. on Sunday. The fluctuations of Richard's hygrograph early in the morning of Monday were equally striking.

AN exceptionally heavy storm was experienced in America from Sunday to Tuesday last. At Chicago the velocity of the wind was estimated at seventy-five miles an hour, and the streets were blocked with snow; while at New York the snow-fall is reported as the heaviest this season. The Atlantic coast was also swept by a fierce wind.

THE Meteorological Council have published, as an Appendix to the *Weekly Weather Report* for 1893, a summary of rainfall and mean temperature for twenty-eight years, 1866-1893. The values are given for each of twelve districts, together with the

means for the easterly, or principal wheat-producing districts, for the westerly, or principal grazing, &c., districts, and for the whole of the British Islands generally. These summaries have been published regularly since 1868, and, although chiefly intended for sanitary and agricultural purposes, they furnish a very easy and trustworthy means of comparing the climatological statistics of different periods or districts. A glance at the rainfall values for the year 1893 shows that they were below the average in every district except the north of Scotland, where the rainfall was as much as 13 inches above the normal amount, being higher than in any year since 1868, and chiefly owing to the areas of low barometric pressure taking a somewhat more northerly course than usual. The greatest deficiency—viz. 9.5 inches—was in the south-west of England, while the deficiency for the whole of the kingdom was 5.9 inches, which is greater than in any year since 1866, except the Jubilee year, 1887, when the deficiency was 9.2 inches. The temperature was above the mean in all districts; the excess over the whole kingdom was 1.4, and it was fairly equally distributed over all districts; the excess has not been equalled since 1868, when it was 2.0 above the normal value available at that date.

THE first sheet of the "Geologic Atlas of the United States" has recently been issued. It is called the "Hawley Sheet," and comprises the north-west part of Massachusetts, with the Green Mountain Region. The geology is by B. K. Emerson. The scale of the map is 1 : 62,500, or slightly more than one inch to one mile. The complete map of the United States on this scale will be 240 feet long and 180 feet high. Contours are drawn at twenty feet intervals, reckoned from mean sea-level. Three copies of the map are given:—(1) Topography, with streams in blue, contours in brown. The hundred-foot contours are deeply engraved, the intermediate lines being only faintly marked. This gives the appearance of hill-shading over the mountainous ground, but each contour can be traced with the aid of a pocket lens. (2) Areal geology, in which the formations are coloured over the brown, blue, and black of the topographical map. (3) Economic geology, which appears, so far as this sheet is concerned, to differ from the other geological map only in having the tints less pronounced, and in having a sign for mines and quarries. The fourth sheet is entitled "Structure Sections": here strips of the map are reproduced, but without contours, and sections along the edge of each strip are drawn on the natural scale. Three sheets of text are given, one, introductory, setting out the purpose and plan of the Atlas, the others descriptive of the geology of the "Hawley Sheet." All the rocks consist of crystalline schists of Cambrian and Silurian age, no igneous rocks which can be recognised as such occur. Probably the Silurian "Hawley schist" is largely composed of eruptive material, but the rock is so much altered that its original character cannot be made out. The drift deposits, which in the south-eastern part greatly obscure the geology, are described, but are not shown on the map.

THE proposals which have lately been made for the renewal of Antarctic research have been very widely echoed, and several geographical journals have given considerable space to the matter. Dr. Neumayer, the greatest continental authority on the subject, devotes the first place in the *Annalen der Hydrographie* to a review of the facts. He translates the abstract of Dr. Murray's paper, given in *NATURE* for November 30, 1893, and expresses hearty approval of the scheme of an Antarctic expedition there set forth. The *Scottish Geographical Magazine* for February contains a further account of last year's Dundee Antarctic expedition.

AUTHENTIC information as to the reported high latitude (84° N.) attained by the American whaler *Newport* is at last

available in the new number of the *Bulletin* of the American Geographical Society. A quotation from a letter written by Prof. George Davidson, of San Francisco, runs: "The captain has been in to see me, and has given me some graphic descriptions of his actual experience in those waters. . . . But he reached only 73°, and is dreadfully annoyed that the newspaper reporter made such an erroneous statement when he had the truth before him." It is unfortunate that the news agency which cabled the invention to this country did not consider it worth while to give notice of the correction, for the record of farthest north has been altered in some books of reference, and there is now no chance for the sober truth being accorded a tithe of the publicity given to the sensational report.

At the meeting of the Royal Geographical Society, on Monday evening, a paper on Johore was read by Mr. Harry Lake, who for three years has been engaged in exploring and surveying the interior of this little-known State. Johore occupies the southern extremity of the Malay peninsula, and the interior consists of low tropical jungle and swamp, diversified occasionally by undulating or mountainous country. The rainfall is excessive, but the great lake of Bera or Tasek, which was represented in former maps, turned out to be merely a vast swamp. The Blumut Mountains in the interior formed one of the most interesting features of the exploration, and the primitive people of the interior, the Jakuns, have been studied with some care. Under its present Sultan, Johore has made great strides in political and economic progress. The chief exports are gambier and pepper, which are cultivated by Chinese labour.

THE question whether "beats" due to the interference of two nearly equal sounds can originate in the brain instead of in the air outside, is discussed by Karl L. Schaefer in the *Zeitschrift für Psychologie und Physiologie der Sinnesorgane*. It is well known that two tuning-forks producing beats continue to produce them when one fork is held to the right, and the other to the left ear, in such a manner that the sound cannot reach the other ear through the air. Wundt himself, in his *Philosophische Studien*, declared the direct cerebral origin of beats to be possible, and connected it with the recently proved possibility of a direct stimulation of the auditory nerve-trunk. Herr Schaefer, on the other hand, does not think that such an origin of beats can be deduced from the experiment quoted. He looks upon conduction by the bones of the skull as the cause of the phenomenon observed. This is confirmed by the fact that even the faintest sounds are capable of propagation from one ear to the other by conduction through the bones. It is generally acknowledged that this is the explanation of beats produced by strong notes. Whether the same applies to faint notes can only be finally decided by determining, with more delicate instruments than any hitherto used, whether beats continue to be heard after conduction through the bones has ceased.

At a recent meeting of the Société Française de Physique, M. Hurmuzescu showed several instruments which he has employed in his experiments on static electricity, the insulating medium being a new material to which he has given the name dielectrine. This substance consists of a mixture of paraffin and sulphur, and is preferable to either of these insulators, as it is harder and has a higher melting-point than pure paraffin, and is less hygroscopic and brittle than sulphur. By means of a special method it is possible to obtain dielectrine in homogeneous masses which are very hard, and can be easily worked either in the lathe or with a file. One of the instruments shown was an electrophorus, the handle of the metallic plate and the disc which is electrified being composed of dielectrine. With this instrument sparks 2 c.m. long were obtained even when the air was moist, while

the charge was retained for a very long time. This new substance, which experiment has shown to be very unalterable, will be of great use as an insulator, particularly in damp situations.

HAVING carried on an elaborate series of experiments on the rotary dispersion of quartz in the infra-red part of the spectrum, M. G. Moreau is now investigating the magnetic rotary dispersion of carbon bisulphide for the same part of the spectrum. He has also measured the refractive index of carbon bisulphide for the infra-red rays, so that he may be able to compare his experimental values for the magnetic rotary dispersion with those obtained by the formula deduced by Maxwell's electro-magnetic theory. The magnetic field used in the experiments was produced by the large coil which Verdet used in his classic researches in this subject, its intensity being measured by the rotation produced in carbon bisulphide for sodium light. In the infra-red observations a thermopile and delicate galvanometer were employed. The author has succeeded in measuring the rotation for wave-lengths between 0.8 and 1.4  $\mu$ ; the absorption of the CS<sub>2</sub> preventing any measurements being made for greater wave-lengths. The paper in which the above results are given will be found in the *Annales de Chimie et de Physique* for February.

THE annual report of Prof. Alexander Agassiz, as director of the Museum of Comparative Zoology at Harvard College, for 1892-93 has just been received; from it, amid many other interesting details, we learn that Prof. A. Milne-Edwards has in hand a final memoir on the Crustacea of the *Blake*, that Prof. Ludwig's monograph on the holothurians of the *Blake* will soon be published, the last plate of the nineteen being in the hands of Werner and Winter. As to Prof. Agassiz's own work we read: "For nearly thirty years since the publication of the catalogue of North American acelephs I have every summer, and frequently during the winter months, also, paid a good deal of attention to the jelly-fishes of our coast. An immense amount of drawings and of notes have thus been accumulated," and we have the hope expressed that during the coming year he may be enabled to arrange this valuable material for publication. We would join our hopes to his, and sincerely trust that the fascinations of fresh voyages of discovery may be for a time resisted, in order that the scientific world may not lose the record of so much important work, a record which Prof. Agassiz alone can give. The various reports of the various assistants are interesting, and show the large resources of the museum, which, large though the building is which contains it, now urgently calls for more space.

THE February number of *Nature Notes*, with which is now incorporated *The Field Club*, contains a note by Mr. W. M. E. Flower, on a tortoise or "gopher" that he brought over from Florida, last July, in a case of palmettoes and other plants. When the cold weather set in, the gopher made a burrow, in which it has lived until now, but whether it will survive the winter remains to be seen. It will be just as well perhaps if the English climate proves to be unfavourable to the animal, for in Florida gophers do an immense amount of damage to plants and crops, and thousands of pounds have been spent in destroying the pest.

PROF. BYRON HALSTED describes in the *Bulletin* of the Torrey Botanical Club for December 1893, the Solandi process of sun-printing and its application to botanical technique. The process consists briefly in exposing the subject, necessarily somewhat translucent, to the sunlight in a printing-frame in common use by photographers, with a sheet of sensitised paper at the back of the subject, in the same manner as a print is taken from a negative of the ordinary sort. The sun-print thus obtained becomes, after it has been toned, the negative from

which the positive picture is printed. The negative is saturated with kerosene for the purpose of clarifying.

MR. G. NICHOLSON, the curator of the Royal Gardens, Kew, contributes to the February number of the *New Bulletin* a report on horticulture and arboriculture in the United States. It contains accounts, among others, of visits to the following gardens:—Holm Lea, near Brooklime, Mass., the residence of Prof. C. S. Sargent; the Arnold Arboretum, of Harvard University, at Jamaica Plain, Mass.; the Missouri Botanical Garden at St. Louis; the Horticultural Exhibition at Chicago; the Mount Hope Nurseries at Rochester, N.Y.; and Meehan's Nursery, Germantown, Philadelphia. The paper also contains notes on railway gardening, and on the native flora of the districts passed through.

AN interesting paper on the possible transmission of the tubercle bacillus by cigars, has appeared in the current number of the *Centralblatt für Bakteriologie*. Dr. Kerez, in the preface to his experiments, points out that ample opportunity is given for the infection of cigars with tuberculous material, as so many of the people employed in tobacco manufactories are known to suffer from consumption. The manner in which the cigars may become infected is apparent when it is remembered that by force of habit and convenience the tobacco-workers prefer to use their saliva for getting the leaves to adhere in cigar making, instead of the materials supplied to them for this purpose. In this way the tubercle bacillus is easily conveyed to the cigar. Dr. Kerez has, therefore, imitated in every detail on a small scale the manufacture of cigars, using saliva containing tubercle bacilli for the moistening of the leaves. After being dried and packed away in boxes, cigars preserved for different lengths of time were carefully unrolled, the leaves washed with water, and the infusion inoculated into guinea-pigs. In all cases where the infected cigars had only been kept for ten days, the animals treated with the tobacco infusion died of tuberculosis, but when the cigars were kept for longer periods the animals suffered no ill-effects, indicating that during this time the tubercle bacilli had either been destroyed or deprived of their virulent character. As long, therefore, remarks Dr. Kerez, as the cigars, presuming them to have been infected in the course of making, are kept for a sufficiently long time in the manufacturer's hands before distribution, this possibility of spreading consumption may be ignored.

A CATALOGUE (No. vi.) of works on geology offered for sale by Messrs. Dulau and Co. has just been issued.

A CHEAP edition of "The Religion of Science," by Dr Paul Carus, has been published by the Open Court Publishing, Company, Chicago.

MESSRS. HORNE AND THORNTON have published a new descriptive catalogue of astronomical telescopes and other optical instruments.

A SECOND edition has been published of the catalogue of the Camera Club Photographic Library, compiled by Messrs. L. Clark and W. Brooks.

MESSRS. BLACKIE AND SON have published a guide to the examinations in elementary agriculture of the Department of Science and Art, and answers to the questions set in the subject from 1884 to 1893.

"A SHORT HISTORY OF ASTRONOMY," compiled by Mr. George Knight, and published by Messrs. G. Philip and Son, is a little book of twenty-seven pages, in paper covers, containing a sketch of the growth of astronomy suitable to beginners, and likely to create a desire for fuller knowledge.

THE first edition of Mr. Bowen Cooke's work on "British Locomotives" being nearly exhausted, the publishers announce a

second and revised edition as almost ready for issue. The same publishers (Whittaker and Co.) announce a work on "Surveying and Surveying Instruments," by Mr. G. A. T. Middleton.

WE announced towards the end of last year that the *British Naturalist* would be discontinued after the December number. General regret having been expressed at the proposed discontinuance of that useful magazine, the opinions of some well-known naturalists were obtained, and with the result that arrangements were eventually made for carrying on the publication. The first number of the new series is before us, and its contents will be appreciated by the student of natural history and collector. Edited by Messrs. J. Smith and L. Greening, and with the assistance of the late editor, Mr. J. E. Robson, and others, the magazine should have a wide circulation among naturalists in all parts of the country.

MESSRS. MACMILLAN AND CO. will publish immediately a volume of "Essays in Historical Chemistry," by Prof. Thorpe, based on lectures and addresses delivered during the last twenty years. The list of subjects includes Boyle, Priestley, Scheele, Cavendish, Lavoisier, Faraday, Thomas Graham, Wöhler, Dumas, Kopp, and Mendeleef.

MR. HENRY LOUIS has prepared, and Messrs. Macmillan and Co. are about to publish, a "Handbook of Gold-Milling," in which the subject is treated for the first time in a form at once scientific and practical. It is hoped that the book may be found useful not only for the technical instruction of mill-men, but also for the guidance of managers and managing directors of gold-mines. The work begins with an account of the physical and chemical properties of gold, and also of mercury; stamp-mill construction is considered in detail, the mechanical principles underlying the design of each part being throughout elucidated. The theory and practice of concentration, as far as it refers to gold-milling, is next considered, together with the most approved modern method of treating the concentrates and other products of milling. Chapters are appended on the economic considerations involved and on the assaying of gold ores and products. The book is fully illustrated.

TWO new boron compounds, diphenyl boric acid and the corresponding chloride, have been obtained in the Rostock Laboratory by Prof. Michaelis, and an account of them, together with several other more complex aromatic derivatives of boron, is contributed to the latest issue of the *Berichte*. In the year 1879 Prof. Michaelis, in conjunction with Dr. Becker, succeeded in preparing phenyl boron chloride,  $C_6H_5BCl_2$ , the first boron compound containing a benzene radicle. This interesting substance, a liquid which boils at  $175^\circ$ , was obtained by heating together to about  $200^\circ$  in a sealed tube the corresponding quantities of boron chloride,  $BCl_3$ , and mercury diphenyl,  $Hg(C_6H_5)_2$ . Upon bringing it in contact with water a beautifully crystalline and powerfully antiseptic substance, phenyl boric acid  $C_6H_5B(OH)_2$ , was produced, which upon heating evolved water vapour, and yielded the anhydride  $C_6H_5BO$ . It is now shown that diphenyl boron chloride,  $(C_6H_5)_2BCl$ , is formed when the mono-phenyl compound is heated along with a further quantity of mercury diphenyl to  $300-320^\circ$  in a sealed tube. The product is a mixture of diphenyl boron chloride with mercury chloro-phenyl  $Hg(C_6H_5)Cl$ , from which latter compound the former may be separated by extraction with an organic solvent. Upon distillation of the extract a liquid is eventually isolated which boils at  $270^\circ$ , and which proves to be pure diphenyl boron chloride. It is a thick colourless liquid which fumes slightly in moist air. Upon heating with water it is decomposed with formation of a substance endowed with an exceedingly powerful and penetrating odour. This substance rapidly collects as an oil upon the surface of the water. After

purification by solution in ether and evaporation of the latter it takes the form of a colourless viscous substance, which soon solidifies to a mass of crystals, colourless at first but subsequently faintly yellow. The crystals melt at  $264^{\circ}$ , evolving the characteristic odour in a still more pungent form. Even the merest trace of the compound is at once rendered evident in a room by its unmistakable effect upon the olfactory nerves. A small quantity introduced into a non-luminous flame imparts a brilliant green colour to the latter. It appears to act as a truly acid substance, dissolving readily in alkalis; the salts produced, however, are not endowed with any great stability, for the acid can be extracted from the solutions by means of organic solvents.

In an appendix to Prof. Victor Meyer's memoir, referred to last week (p. 349), a recent extension of the subject of stereochemistry to purely inorganic elements is alluded to. Dr. Werner, in a treatise upon the nature of the isomerism of the numerous ammoniacal compounds of cobalt, platinum, and other metals, shows that the complex relations of these substances are capable of a surprisingly simple explanation upon the assumption of different arrangements of the various atoms and groups in space. The foundations of a stereochemistry of platinum are laid by assuming the atom of the metal to occupy the centre of a regular octahedron, to the six corners of which the various groups are attached. In this manner the existence of the two isomeric series of complex compounds of the composition  $Pt(NH_3)_2X_4$  is accounted for, the difference between them being brought about by a difference in the relative positions of the two  $NH_3$  groups. It would thus appear that the great concentration of research upon the organic compounds, which has been the salient feature of the chemical progress of the last twenty years, has had the fortunate effect of so enlightening us as to the internal structure of chemical molecules as typified in carbon compounds, that the remaining complex problems of inorganic chemistry may now be attacked with much greater likelihood of success.

NOTES from the Marine Biological Station, Plymouth.—During the past fortnight the floating fauna has assumed a considerably richer character, chiefly owing to the marked increase in the numbers of Decapod larvæ (esp. *Zoea*), and to the reappearance of Cœlenterates, which have been very scarce for the past two months. *Ephyra* of *Aurelia* have appeared, and are already fairly numerous; a few specimens of the Anthomedusa *Rathkea octoporum* have been observed, and a Leptomedusa, apparently *Phialidium variabile*, has been taken in fair quantity. Some Ctenophore larvæ have also been observed. Prosobranch and Opisthobranch veligers are plentiful, and a single specimen has been obtained of the pelagic postlarval stage of *Arenicola*, discovered at Plymouth last year. Other captures on the shore and with the dredge include *Æolis papillosa*, *Platydoris planata*, and large numbers of *Myzostomum* from *Antedon rosacea*. *Littorina littorea* is breeding.

THE additions to the Zoological Society's Gardens during the past week include two Bonnet Monkeys (*Macacus sinicus*, ♀ ♀) from India, presented respectively by Col. J. North, and Mrs. Hewitt; a Macaque Monkey (*Macacus cynomolgus*, ♀) from India, presented by Mr. F. Reynolds; a Pinche Monkey (*Midas adipus*) from New Granada, presented by Miss Farmer; a Banded Ichneumon (*Herpestes fasciatus*), two Vulturine Guinea Fowls (*Numida vulturina*), four Red-bellied Waxbills (*Estrela rubriventris*), two Madagascar Weaver Birds (*Fondia madagascariensis*), two Alario Sparrows (*Passer alario*) from East Africa, presented by Mr. Besant; a Red-eared Bulbul (*Pycnonotus jocosus*), a yellow-bellied Liothrix (*Liothrix luteus*), three Indian Silver-bills (*Munia malabarica*) from India, a Chestnut-breasted Finch (*Donacola castaneothorax*) from

Queensland, two Java Sparrows (*Padda oryzivora*) from Java, two Russ Weaver Birds (*Qulea russi*), a Crimson-crowned Weaver Bird (*Euplectes flammiceps*) from West Africa, two Saffron Finches (*Sycalis flavocolus*) from Brazil, presented by Mr. C. S. Simpson; a Chaffinch (*Fringilla cœlebs*), a Brambling (*Fringilla montifringilla*), a Greenfinch (*Ligurinus chloris*), a Linnet (*Linota cannabina*), three Lesser Redpolls (*Linota rufescens*) British, presented by Mr. L. V. Dance; a Moustache Monkey (*Cercopithecus cephus*, ♀) from West Africa, a Green-winged Trumpeter (*Psophia viridis*) from the Amazons, deposited.

#### OUR ASTRONOMICAL COLUMN.

A TEMPERED STEEL METEORITE.—Among the many objects collected by the Peary Expedition to Greenland in 1891 was a meteorite weighing about 267 pounds. It was found by Prof. A. Heilprin, near Godhaven, Disco Island, and sent to the Academy of Natural Sciences of Philadelphia, in the Proceedings of which (1893, p. 373) it is described by Mr. E. Goldsmith. When received at the Academy, the meteorite appeared to be solid and devoid of cracks or any signs of disintegration, but this condition soon changed, and the mass slowly cracked and began to fall to pieces. It is thought that this crumbling was due to oxidation resulting from the existence of a higher temperature and a greater quantity of ozone in the latitude of Philadelphia than in that of Greenland. Mr. Goldsmith has examined some of the pieces separated from the mass. The substance could easily be separated into hard, metallic and tough granules, and a powder capable of reduction to any degree of fineness. A determination of the separated quantities gave 73.8 per cent. as the proportion of the granules, and 26.2 per cent. as that of the powder. The specific gravity of the former proved to be 6.14, and of the latter 4.73. One of the pieces from the meteorite was reserved for grinding and etching, but it was found that the process involved considerable difficulty owing to the extreme hardness of the specimen. Indeed, the mass was so hard that it would scratch soft iron, making an impression visible to the eye and sensible to the touch. This and other tests seems to warrant Mr. Goldsmith calling the object a tempered steel meteorite. Possibly the meteorite fell into a pool of water or deposit of snow or ice, and was thus quickly cooled down from the heated condition obtained by rushing through the atmosphere.

Analyses show that there is a distinct difference between the granules and the separated dark powder. The former contains a sulphuret, probably troilite; the latter contains no sulphuret, but, instead, a sulphate. Iron, nickel, sulphur, traces of carbon, chlorine, phosphorus, and chromium were found; also a silicate in which lime and magnesia were recognised. Copper and cobalt were searched for, but in vain. According to Prof. A. E. Nordenskiöld and J. L. Smith, the Disco Island terrestrial iron contains copper, cobalt, phosphorus, and comparatively large quantities of carbon. As Mr. Goldsmith remarks, these differences are too great to be overlooked in comparing analytical work; they indicate that the mass found by Prof. Heilprin is not of terrestrial, but of celestial, origin.

ASTRONOMY IN POETRY.—Some litterateurs and ultra-sentimental poets affect to believe with Macaulay that the advance of science means the death of poetry. It was left to Lord Tennyson to show that scientific facts admit of the highest poetical expression. Another instance of the exactness of his references to astronomical matters is given in the February number of the *Observatory*. In "Maud" the beautiful lines occur—

"A time of year  
When the face of night is fair on the dewy downs,  
And the shining daffodil dies, and the Charioteer  
And stary Gemini hang like glorious crowns  
Over Orion's grave low down in the west."

A little further reference is made to the planet Mars, "As he glow'd like a ruddy shield on the Lion's breast." The whole passage refers to the Crimean War, which was from 1854 to 1856, and, from the first quotation, it is evident that Tennyson had in mind the months of April and May. It was interesting, therefore, to see whether Mars occupied in the fifties the position named by the poet. Upon looking up the matter it appears that the planet was in Leo in June 1852, November 1853,



April and May 1854, October 1855, and not at all in 1856. In 1852 Mars passed rapidly through the constellation, but in 1854 he was nearly a month in exactly the position—"on the Lion's breast"—described by Tennyson. From internal evidence alone, therefore, the time referred to in the poem can be fixed as the spring of 1854.

NOVA AURIGÆ.—In a brief note to *Astronomische Nachrichten*, No. 3209, Mr. Martin Brendel says that he has found Nova Aurigæ upon an auroral photograph taken by him at Greifswald, Norway, on January 5, 1892. It will be remembered that Dr. Anderson announced his discovery at the end of January 1892, and that Prof. Pickering afterwards found the object upon photographs taken in December of the previous year.

#### AGRICULTURAL EXPERIMENT STATIONS.

THE general British public regards with suspicion the granting of State aid for scientific experiments. But though the reluctance to give such assistance to pure science may be partly understood, it might reasonably be expected that the shop-keeping instinct would have led to the adequate endowment of an applied science like agriculture. An article by Mr. James Long, however, in the January number of the *Record of Technical and Secondary Education*, shows how unfavourably England compares with other countries as regards institutions in which the scientific principles of agriculture are taught. We have two or three excellent agricultural colleges carried on by private enterprise, but it is a question whether they supply the requirements of the practical farming class. Compare this with what has been done abroad. "Some thirty years ago," says Mr. Long, "the Government of the United States made grants of land to each State for the purpose of establishing colleges. At the time, the proportion handed over was 30,000 acres for each senator or representative in Congress to which the State was entitled according to the census of 1860. In addition to this grant, large and frequent money grants in connection with the agricultural sides of these colleges and to the experiment stations, which have also been established, have been made. Figures, which have been furnished to me by one of the officials of the U. S. Government, show that in some instances the value of the permanent endowment of each college exceeds £100,000, while the interest brings in amounts reaching, in some instances, to nearly £10,000 per annum. To this may be added the value of the buildings which have been erected from funds supplied by the Central and State Governments, which vary from £20,000 to £200,000, and these values are constantly increasing. The first systematic attempt to teach agricultural science in America was conducted at Yale, which, from time to time, was followed by Michigan, New York State, Kansas, and Massachusetts. There are now some fifty State agricultural colleges, conducted upon a recognised system by men of capacity, and generally equipped in a manner which leaves little or nothing to be desired."

The work of these colleges is not restricted to the instruction of students in the science and practice of agriculture, for to each college a State experiment station is generally attached. In England experimental work in agriculture has been left entirely to private enterprise. As Mr. Long remarks, were it not for Rothamsted our scientific work in agriculture would have been sorry indeed as compared with that accomplished by the people of other countries. In the United States there are more than fifty experiment stations maintained by grants from each State and the Central Government.

One of the stations visited by Mr. Long, that of Geneva, in New York State, has an income of £4000 a year, from which it pays in salaries £1650, and in wages £1200. There are six chemists on the establishment, in addition to the director, an assistant director, a horticulturist, a pomologist, a clerk, and a staff of workmen. No wonder that a large amount of valuable work has been performed at the station during the last eight years.

Canada possesses five experimental farms of considerable size. Roughly these farms cost £15,000 a year, or £3000 a year each, omitting salaries. Coming to this side of the Atlantic we find that France has three important agricultural colleges. To the chief of these, that in Gignon, near Paris, a large farm is

attached upon which experimental work is conducted. Italy possesses the experiment station at Lodi (Reale Stazione Sperimentale di Caseificio), where instruction is given in science and practice, and chemical investigations are conducted, the funds being provided by the Government and the Province and Commune jointly. Germany is full of agriculture experiment stations. The station at Kiel is supported by grants from the Central and Provincial Governments, and combines instruction with experimental work. In Denmark experimental work is carried on in the laboratory at Copenhagen, in experiment grounds, and at the Lyngby agricultural school and experiment farm, which is a good example of the Danish colleges. In Sweden and Norway Mr. Long visited the agricultural schools and stations at Ultuna and Alnarp. In addition to the usual farm, the former possesses an experiment station conducted somewhat on the Canadian lines. The best class of scientific investigations seems to be carried on at the chief station near Stockholm. Mr. Long also briefly refers to the systems of agricultural instruction adopted in Switzerland, Holland, and Belgium. His report shows clearly that Great Britain is behind other nations, both as regards State provision for instruction in agriculture and the establishment of experiment stations. It is quite time that the necessity for these stations was recognised by the Government.

#### THE SPENCER-WEISMANN CONTROVERSY.<sup>1</sup>

AS most readers of NATURE are aware, a very interesting controversy has arisen between Mr. Herbert Spencer and Prof. Weismann. The subject, although many minor issues appeared, is that apple of discord of modern biology, the existence of an inheritance of acquired characters, and in necessary association with that, the extent of the operation of natural selection. The two approach the questions in sharply-contrasted attitudes. Mr. Spencer looks at the problems of biology in their philosophical aspect as part of the large field of abstract thought which he himself has done so much to analyse, synthesise, and codify. Prof. Weismann, although best known by his theories, has been above all things a minute investigator of structural details. In the present controversy, Spencer maintains that the weight of evidence and argument in favour of the inheritance of acquired characters is so great that "unless there has been inheritance of acquired characters there has been no evolution." Weismann believes that there are insuperable difficulties in the way; that there is no evidence for such an inheritance: that natural selection is an all-sufficing cause.

Mr. Spencer's first argument is drawn from the gradations of tactual discriminativeness in the human skin. These gradations range from the ability of the tip of the tongue to recognise double contact in the points of a pair of compasses when their points are one-twenty-fourth of an inch apart, to the ability of the middle of the back which requires the points to be two and a half inches apart before double contact can be distinguished. It is a fair statement that these gradations are so distributed on the skin that those parts which are more used to the opportunity of discriminating are more capable of discrimination than parts with lesser opportunities. Spencer points out the difficulty or impossibility of believing that minute increases of tactile discrimination, as, for instance, distinguishing contact as double when the points are one-twenty-fourth inch apart instead of when they are one-twentieth inch apart, could not determine the existence of animals, and so could not have been selected. On the other hand, were the effects of use inherited, the gradations are explained. Against this, as against other individual cases, Weismann points out that there are not sufficient data; we know little or nothing of how variations occur, and what are the least variations that have value in selection. In the particular case of the tongue, one must remember that the tongue is one of the most highly specialised organs of the highest exist-

<sup>1</sup> "The Inadequacy of Natural Selection," by Herbert Spencer. *I. Contemporary Review*, February, 1893. II. id. March, 1893.

"Prof. Weismann's Theories," by Herbert Spencer. *Contemporary Review*, May, 1893.

"A Rejoinder to Prof. Weismann," by Herbert Spencer. *Contemporary Review*, December, 1893.

"Die Allmacht der Naturzüchtung. Eine Erwiderung an Herbert Spencer." Von August Weismann. Jena: Gus. av. Fischer, September, 1893. (Of this an English rendering appeared in the *Contemporary Review* for September and October, 1893.)

ing type of mammalia, and we know nothing of the myriad changes that have taken place during its evolution. Spencer urges that Weismann has made no reply to the difficulty of the distribution of tactile discriminativeness over the skin. But even were it an established fact that the effects of use are inherited, Mr. Spencer's suggestion would bring us no nearer an explanation, as it cannot be supposed that increased use would multiply the number of tactile end organs. If the origin of the end organs be left unaccounted for, and it be said that these changes in the brain that are the result of practice in discrimination are accumulated by inheritance, still the argument is not cogent. For a variation in the brain leading to the slightest increase of discrimination in interpreting the messages from the peripheral sense organs certainly have a value in selection.

In the matter of Panmixia, Mr. Herbert Spencer has misunderstood Weismann completely. Panmixia does *not* imply selection of smaller varieties, but the cessation of the elimination of smaller or more imperfect varieties. The discussion of the variation of cooperative parts leaves the issues open. In the case of the giraffe, Mr. Spencer thinks that the main points of its extraordinary structure must be due to natural selection. Nägeli some time ago selected the case of the giraffe as a special instance of the inadequacy of selection. But in the giraffe, and in many other cases, as in the horns of a stag, increase of an organ to be of any use must be accompanied by modifications of a multitude of cooperating parts. For such cases of co-adaptation, natural selection without the inherited results of increased use, Mr. Spencer believes inadequate. Weismann's chief reply is drawn from a study of neuter ants. In them there are many structures different from the corresponding structures in males and females, and of these some imply the harmonious modification of cooperating parts. Following those who have investigated ants most fully, Weismann believes that most of these modifications arose subsequently to the loss of reproductive power by workers and soldiers, and that, consequently, we have here an instance of modifications involving coadaptation where there is no possibility of the inheritance of acquired characters. Against this, Spencer has set forth "certain views concerning the origin and economy of social insects, which differ from those that are current." According to these views reproductive power was lost by neuters subsequently to the appearance in them of the new characters, and consequently upon his theory the inheritance of acquired characters is not excluded. Thus, on his view the issues are still open.

When Mr. Spencer brought forward a set of instances supporting the popular belief that offspring to a second sire occasionally show traces of the first sire, he was apparently unaware that Weismann had already discussed a number of such cases, grouping them under the name "telegony." In the famous case of Lord Morton's mare it appears that the only resemblance to the first sire was zebra-like stripes, and it has been known for very long that such stripes not infrequently appear. Settegast and Nathusius, two very great authorities on questions relating to the breeding of animals, deny that there is proof of the existence of telegony, and for the present at least it cannot be said that it forms an argument against Weismann's theories. Moreover, the suggestion made by Prof. Romanes, and accepted by Weismann, provides an intelligible explanation of the hypothetical facts. To anyone who has seen under the microscope the intricate method in which nuclear matter prepares for division, Spencer's suggestion that it passes from cell to cell, leaving the embryo and reaching the tissues of the mother, must seem absurd, and his comparison of the wanderings of microbes will not render his supposition more intelligible.

The discussions of the "immortality" of the Protozoa, and of the exact meaning of division of labour, are largely academic, and do not admit readily of being summarised. But it is clear that unless *generatio equevota* be admitted, many existing Protozoa have been reproducing by simple division since at least tertiary times, and that is a length of life certainly amounting to the concept of "immortality" as used by Weismann. And if there be a material basis of heredity at all (a view which is by no means peculiar to Weismann), the material basis whether it be called germ-plasm or not, and whether it be modified in each ontogeny or not, stretches from animal to animal since the beginning of things, and has a dower of life immensely greater than the dower of life of somatic protoplasm.

P. CHALMERS MITCHELL.

#### ANCIENT EGYPTIAN PIGMENTS.<sup>1</sup>

THE red pigment used by the Egyptians from the earliest times is a native oxide of iron, a hæmatite. Most of the large pieces found by Mr. Petrie are an oolitic hæmatite. One specimen, on analysis, gave 79.11 per cent. and another 81.34 per cent. of ferric oxide. The pieces to be used as pigments were no doubt carefully selected, and the samples that I have examined, mostly from Gurob and Kahun, are very good in colour. All the large pieces were of a singular shape, having one side smooth and curved; and in all cases this side was strongly grooved with striae, giving somewhat the appearance to the mass of its having been melted, and allowed to cool in a circular vessel. No doubt the explanation of this smooth-curved surface is, that these pieces had actually been in part used to furnish pigments, and having been rubbed with a little water in a large circular vessel, had been ground to this shape. By experiment it was found that these pieces of the native hæmatite yielded, without any further addition by way of medium, a paint which could readily be applied with a brush, as it possesses remarkable adhesive properties, and it resembles exactly, in every particular, the red used in the different kinds of Egyptian paintings. In addition to these samples of the pigments, all of which are native minerals and in their natural conditions, there are other reds, finer in colour and smoother in texture, evidently a superior pigment; these apparently have been made from carefully selected pieces of hæmatite, which have been ground and washed, and dried by exposure to the air. Some of these pieces are very fine in colour, and it would be difficult to match them with any native oxide of iron that is used as a pigment at the present day. There is every reason to believe that this is the earliest red pigment which was used, and it remains to this day the commonest and most important one; it is a body unattacked by acids, unchangeable by heat, and even moisture and sunlight are unable to alter its colour. At the present time many artificial products are used to take the place of this natural pigment.

*Yellow Pigments.*—These, again, are natural products, and by far the most common yellow used by the Egyptians is a native ochre. These ochres consist of about one-quarter of their weight of oxide of iron, from 7 to 10 per cent. of water, and the rest of their substance is clay. When moist they have a greasy feel, and work smoothly and well with the brush. There is no evidence of these bodies having changed colour, but undoubtedly they are chemically not nearly so stable as the red form of oxide of iron. Many of the pieces of this pigment, found at Gurob and at Tel-el-Amarna, are very fine in colour.

Some of the specimens of the very earliest colours of which the exact history is known, appear to be an artificial mixture of these two colours, the red and yellow, thus producing an orange colour. These samples were found on a tomb at Medum, which, according to Prof. Flinders Petrie, was built by Nefermat, a high official and remarkable man at the Court of Senefru. Senefru is known to have lived in the fourth dynasty, about 4000 B.C. and to have preceded Khufu, the Cheops of the Greeks, who was the great Pyramid builder. Now, on Nefermat's tomb the characters and figures are incised and filled in with coloured pastes, which I have been able to examine, and it is of interest to know that this use of colour was a special device of Nefermat, for on his tomb is stated that: "He made this to his gods in his unspoilable writing." In this unspoilable writing the figures are all carefully undercut, so that the coloured pastes, so long as they held together, should not be able to drop out. All the pastes used are dull in colour, consisting entirely of natural minerals. Hæmatite, ochre, malachite, carbon, and plaster of Paris appear to be the materials used. Chessylite, as a blue, probably was known even at that date, but the artificial blues seem hardly at this period to have come into use; certainly they are not found in the specimens of the Nefermat colours which I have examined. Another yellow pigment, far brighter in colour, was also often used. It is a sulphide of arsenic, orpiment; it is a bright and powerful yellow, again a body found in nature, but a much rarer body than ochre, and consequently, probably was only used for special purposes, when a brilliant yellow was required. As far as it is known at present, this pigment did not come into use until the eighteenth dynasty. Gold might even be placed among the yellow pigments, for it was largely used, and with wonder-

<sup>1</sup> A lecture delivered at the Royal Institution of Great Britain, on March 17, 1893, by Dr. William J. Russell, F.R.S.

fully good effect. Its great tenacity seems to have been fully recognised, for gold is found in very thin sheets, and laid on a yellow ground, exactly as is done at the present day.

These pigments are then simply natural minerals, no doubt carefully selected, and sometimes ground and washed previous to being used; but the blue colour which is so largely used by the Egyptians is an artificial pigment, and consequently has far more interest attached to it than those already mentioned. It is a body requiring considerable care and experience to make, and thus its manufacture enables us to some extent to judge of the knowledge and ability which its producers had of carrying on a chemical manufacture. No doubt the splendid blue of the mineral chessylite was first used, but certainly in the twelfth dynasty—that is, about 2500 B.C.—these artificial blues were used. They are all an imperfect glass, a frit, made by heating together silica, lime, alkali, and copper ore.<sup>1</sup> The number of failures which may have occurred, and how much material may have been spoilt, cannot be known, but all the blue frit which I have examined—and it is a considerable amount, some being raw material, lumps as they came from the furnace, and the rest ground pigment—all has been, though differing in grain and quality, well and perfectly made. Now this implies that the materials have been carefully selected, prepared, and mixed, and that definite quantities of each were taken, this necessitating the carefully measuring or weighing of each constituent. An early application of the fundamental law of chemistry, combination in definite proportion. The amount of copper ore added determined the colour; with 2 to 5 per cent. they obtained a light and delicate blue; with 25 to 30 per cent. a dark and rather purple blue; with still more the product would be black; if the alkali was too little in amount, a non-coherent sand resulted; if too much, a hard, stony mass is formed, quite unsuitable for a pigment. The difficulties, however, did not by any means end with the mixture of the materials. For the next process, the heating, is a delicate operation. Unfortunately up to the present time the exact form of furnace in which this operation was carried on is not known. The furnaces were probably, especially after use, very fragile structures, and have passed away. Considerable experience in imitating these frits even when using modern furnaces has taught me that the operation is really a very delicate one; the heat has to be carefully regulated and continued for a considerable length of time, a time varying with the nature of the frit being prepared; and, further, in the rough furnaces used it must have been specially difficult to have prevented unburnt gases from coming in contact with the material; but if they did, a blackening of the frit must have taken place. However, all these difficulties were avoided, and a frit was made which exactly answered all the necessary requirements. It had, for instance, the right degree of cohesion, for many of the large pieces which have been found have, like the hæmatite, a smooth, curved striated surface, and on rubbing in a curved vessel with water, easily grind to powder. The powder is naturally much less adhesive than the hæmatite powder, but on adding a little medium, it could at once be used, without other preparation, as a paint. Some of the pieces vary in colour in different parts. This may have arisen from imperfect mixing, or from some parts of the furnace being hotter than others. It hardly appears to be intentional, possibly some of the dark, purplish-coloured frits were produced by accident; large pieces of it have as yet, I believe, not been found. By means of comparatively small alterations these frits could be obtained of a green colour. One way was by introducing iron. If, for instance, the silica used was a reddish coloured sand, it gave a greenish tinge to the frit; and frit made with some of the ordinary yellowish desert sand was found to give a frit undistinguishable from the most common of the old Egyptian frits. Again, a rather strong green colour is obtained by stopping the heating process at an early stage, this green frit simply on heating for a longer time becoming blue. Another way in which even the strong-coloured blue frits have been converted into apparently green pigments is by their being coated over with a transparent but yellowish coloured varnish which has to

a remarkable extent retained its transparency, but no doubt become with age more yellow, and although strongly green now, may very likely originally have been nearly colourless, and consequently the frit was then seen in its original blue colour. Even as early as the twelfth dynasty the green frits used were dull in colour, and if by chance a brighter green was required, then they used the mineral malachite. No doubt by far the most brilliant blue used at any time was selected and powdered chessylite, and even down to the twenty-first dynasty they seem to have made use generally of somewhat brilliant coloured frits; but after that time more subdued colours appear to have been used, and even the scarabs were made of a much duller colour than formerly. All these blue frits form a perfectly unfadeable and unchangeable pigment. Neither the sun nor acids are able to destroy or alter their colour.

The only other pigment to which I can refer this evening is the pink colour, which, in different shades, was much used. This is again an artificial pigment, and belongs to an entirely different class from any of the foregoing ones, for it is one of vegetable origin. On simply heating it, fumes are given off and the colour is destroyed, but a large white residue remains; this is sulphate of lime. It may here be stated that the white pigments used sometimes were carbonate of lime, but more generally sulphate of lime in form of gypsum, alabaster, &c. This substance is often very white in colour, is very slightly soluble in water, and has a singular smoothness of texture, which makes it work well under the brush; and in addition to these qualities, it is a neutral and very stable compound, so is well fitted for the purpose to which it was applied. It was easily obtained, being found native in many parts of Egypt. It is also interesting to note that there is an efflorescence consisting of this substance which frequently occurs in Egypt, and is of a remarkably pure white colour; probably this was used as a superior white pigment. It was easy to prove then that the pink colour was gypsum stained with organic colouring matter, and to try and imitate the colour appeared to be the most likely way of identifying it. Naturally, madder, which it is known has from the earliest times been used as a dye, was the vegetable colouring substance first tried, and it answered perfectly, giving under very simple treatment the exact shade of colour to the sulphate of lime which the Egyptian pigment had. Essentially the same colouring matter may have been obtained from another source, viz. Munjeet. In the case of madder it is interesting to note that the colour is not manifest in the plant—the *Rubia tinctorum*—for it is obtained from the root, and is even not ready formed there. In the root it exists as a glucoside, and this has to be decomposed before the colour becomes manifest. In this root there exist several colouring matters, which are known as madder-red, madder-purple, madder-orange and madder yellow. On breaking up the roots and steeping them in water for some length of time, the colours come out, some sooner than others, so that the tints vary. Again, changes of colour are easily obtained by the addition of very small quantities of iron, lime, alumina, &c., so that in these different ways a considerable range of colours could be obtained, but a delicate pink colour was the one probably generally made. This colour is easily obtained by simply stirring up sulphate of lime in a tolerably strong solution of madder, and adding a little lime, taking care to keep the colouring matter in excess; the colouring matter adheres firmly to the lime salt, and this settles on to the bottom of the vessel; the liquid is then poured off and the solid matter, if necessary, dried, or mixed—probably with a little gum, and used at once without other preparation. That the colouring matter was really madder could also be tested by another method, viz. by means of spectrum analysis. Both the madder-red (alazarin) and the madder-purple (purpurin) give, when the light which they transmit is analysed by the prism, very characteristic absorption bands; the purpurin bands are the ones most easily seen, consequently it became a point of considerable interest to ascertain whether from a specimen of this pigment, some thousands of years old, these absorption bands could be obtained. A small sample of this pink pigment was taken from a cartouge which was exhibited, and by treating it with a solution of alum, the colour was thus transferred to the liquid, and by throwing the absorption spectrum which it gave on the screen, and comparing it with the spectrum from a madder solution, it was clearly seen to be identical.

Many specimens in imitation of different coloured frits, and a large copy of a cartouge coloured with pigments prepared by the lecturer, were exhibited.

<sup>1</sup> A sample of the pale-blue frit gave, on analysis, the following results:—

|                          |     |     |     |     |       |
|--------------------------|-----|-----|-----|-----|-------|
| Silica                   | ... | ... | ... | ... | 88.65 |
| Soda                     | ... | ... | ... | ... | 0.81  |
| Copper oxide             | ... | ... | ... | ... | 2.09  |
| Lime                     | ... | ... | ... | ... | 7.98  |
| Iron oxide, alumina, &c. | ... | ... | ... | ... | 0.57  |

100.00

UNIVERSITY AND EDUCATIONAL  
INTELLIGENCE.

OXFORD.—At a meeting of the Ashmolean Society, held on Monday last, Mr. V. H. Veley read a most interesting paper, entitled "A Criticism of the Electrolytic Theory of Chemical Change," which excited a warm discussion. At the same meeting Mr. J. E. Marsh read a paper on "Some New Derivatives of Camphene," which embodied some of the results of recent investigations made by him and Mr. J. A. Garner.

At a meeting of the Junior Scientific Club on Wednesday, 7th inst., Mr. H. Ballour exhibited primitive tobacco pipes and vessels of skin and sinew from India and South Africa. Papers were read on "Hertz's Researches on Electromagnetic Radiation" by Mr. E. F. Morris, of Balliol, and on "The Distribution of Extra-marine Mollusca," by Mr. E. W. W. Bowell, of Wadham.

In the list of newly-elected members of the Board of the Faculty of Natural Science given last week, the name of Mr. W. Esson was inadvertently given instead of that of Mr. H. T. Gerrans.

As a result of the memorial presented by the Demonstrators to the Hebdomadal Council last year, the following statute has been passed by Council, and will be promulgated in Convocation on March 20. If all that the Demonstrators demanded has not been conceded, the new statute has at least the merit of recognising their position and given them a definite university status.

"Whereas it is expedient to make regulations respecting (1) the appointment of Demonstrators and other Assistants in certain laboratories, and (2) their tenure of office, the University enacts as follows:—

After Stat. Tit. iv. Sect. 1, § 3 (page 32, ed. 1893) the following subsection shall be added:—

§ 4. Concerning Demonstrators and other Assistants in laboratories.

1. Every Demonstrator or other Assistant appointed by any of the Professors enumerated in the Schedule annexed to this Statute shall receive at the time of his appointment a written statement of the emolument and duration of his office.

2. In all cases in which a Demonstrator or other Assistant is so appointed for a longer period than two terms, Easter and Trinity terms being for this purpose computed as one term, the name of the person appointed and the terms of the appointment shall be submitted for approval to the Vice-Chancellor, who, if he gives his approval, shall notify the appointment in Convocation, and cause it to be published in the usual manner.

3. Any Demonstrator or other Assistant who has been dismissed from office by the Professor shall have the right of appealing against the dismissal to the Vice-Chancellor.

*Schedule.*

The Savilian Professor of Astronomy.  
The Professor of Experimental Philosophy.  
The Waynflete Professor of Chemistry.  
The Professor of Geology.  
The Linacre Professor of Comparative Anatomy.  
The Waynflete Professor of Physiology.  
The Sherardian Professor of Botany."

CAMBRIDGE.—Mr. T. H. Riches has been appointed to the occupation of the University's table at the Naples Zoological Station for the next five months.

The General Board of Studies recommend that Dr. Ruhemann's Lectureship in Organic Chemistry should be continued for five years from Michaelmas next. Dr. Ruhemann's teaching appears to have been very popular; during last term he had 123 students under instruction. His work, though it is under University auspices, is conducted for the present in the laboratory of Gonville and Caius College.

The Agricultural Examinations Syndicate have issued, through their Secretary, Mr. Francis Darwin, Deputy-professor of Botany, a scheme of the Examination in Agriculture to be held next summer. The examination will extend from July 2 to July 8, and will include papers and practical work in Chemistry, Botany, Physiology, Entomology, Geology, Engineering, and Book-keeping (constituting Part I.), and Practical Agriculture and Surveying (constituting Part II.). The fee for admission will be one guinea for Part I., and two guineas for Part II. The names of candidates are to be sent to the Registry by

June 13, 1894. Schedules of the subjects over which the examination will extend are published in the *University Reporter* for February 13. Candidates who pass both parts will receive a diploma testifying to their competent knowledge of the science and practice of agriculture.

SCIENTIFIC SERIALS.

*Wiedemann's Annalen der Physik und Chemie*, No. 1.—Radiation of gases, by F. Paschen. The experiments were conducted upon gaseous carbonic acid and steam. By using mirrors instead of lenses, and a prism of fluor spar, purer spectra and more decided maxima were obtained than those found by Angstrom. The absorption spectra of CO<sub>2</sub> at ordinary temperatures, and of steam at 100°, correspond in general to the emission spectra at higher temperatures, except that at higher temperatures the maxima are displaced towards the less refrangible end. This displacement was found, however, to be reversed for at least one of the steam maxima. The principal maximum of CO<sub>2</sub> was at  $\lambda$  4630. The other, at 2710, nearly coincided with that of steam, at 2660. The other maxima due to steam were found at 8060 and 7160. All these maxima were very decided. A layer of CO<sub>2</sub> 7 c.m. thick showed almost complete absorption at the darkest bands. These bands did not, as sometimes supposed, broaden with increasing thicknesses of layers. A layer of air 83 c.m. thick showed them clearly. One principal band due to steam was found represented in the absorption spectrum of water, but those of water were as a rule displaced towards the red end. No absorption by oxygen and nitrogen could be discovered under similar conditions.—On the artificial colouring of crystals and amorphous bodies, by O. Lehmann. The recently discovered phenomenon of "liquid crystals," *i.e.* dissolved crystals retaining their doubly-refracting properties in the state of solution, has confirmed the author's belief that the properties of crystals depend more upon those of their molecules than upon the aggregation of the latter. Hence it is probable that substances which are not isomorphous may, after all, be capable of crystallising together. This has been actually observed in the case of sal-ammoniac and copper chloride, and subsequently in a large number of substances, such as meconic, hippuric, and succinic acids when brought into contact with bodies like Hofmann's violet, phenyl blue, or methyl orange.—On galvanic deposits arranged in streaks, by U. Behn. The streaky deposit found in silver voltameters and similar apparatus owes its arrangement to currents within the liquid due to variations of density during electrolysis, as was proved by varying the position of the voltmeter. In the case of silver nitrate, the streaks are most highly developed when the solution is dense and the current feeble. The amount of E.M.F. is without influence.—The polarisation of solid deposits between electrolytes, by P. Springmann. The counter E.M.F. generated by a current flowing through two electrolytes was determined, in cases where the two liquids gave a solid deposit upon the membrane (parchment or gypsum) separating them. With a current of 21.4 milliamperes, solutions of lead nitrate and copper sulphate gave a polarisation of 1.964 volts after five, and 2.02 volts after ten minutes.

*Bulletin de l'Académie Royale de Belgique*, No. 12.—Essay on the variations of latitude, by F. Folie. This is an attempt to explain the observed variations of latitude by a superposition of initial nutation and an annual displacement of the earth's pole of inertia due to inequalities in the distribution of snow in the various north circumpolar regions. Supposing that the snow falling in America between the meridians of 235° and 285° E. of Gr. is counterbalanced by that falling in Europe and Siberia from 55° to 105°, the chief unbalanced tracts would be those between 105° and 135° in Siberia, and 15° and 55° in Europe. These masses would have their centres of gravity at about 120° and 35° respectively, giving a resultant centre of gravity at 77°. Assuming that the thickness of snow accumulated from autumn till midwinter is equivalent to 0.3 m. of water, and that the solid crust extends down to the extent of one-tenth of the earth's radius, a rough calculation gives 0.06° as the angle by which the pole of inertia would be displaced towards North America during the period considered, afterwards returning by the same amount between midwinter and midsummer. The combination of this annual period with that of initial nutation, of 427 days, would give an apparent period of 396 days, agreeing closely with that of 398 days found by Chandler.—

Remarkable meteors in the night from November 6 to 7, 1893, by the same author. Several striking meteors were observed in various quarters during that night, in the constellations of Pegasus, Ursa Major, and Ursa Minor. The report of the explosion of the last was plainly audible.—On some new processes for the detection of vegetable and mineral oils, by W. de la Royère. An alkaline solution of rosaniline may be used for determining minute quantities of fatty oils mixed with mineral oils. Half a gramme of fuchsine is dissolved in half a litre of boiled distilled water. A 30 per cent. solution of caustic soda is added drop by drop until complete discolouration is just obtained. The mixture is then made up to one litre with distilled water, and kept in a well-stoppered bottle. A few drops of this are added to a small quantity of the oil in a porcelain dish, and stirred. The animal and vegetable oils quickly assume a pink colour, and mixtures of these with mineral oils are coloured red with an intensity proportional to the quantity of animal or vegetable oil present. Other coal-tar products, such as picric acid, purpurine, rosolic acid and eosine, show a similar behaviour.

*Internationales Archiv für Ethnographie*, Bl. vi., Heft vi.—This is the last number of the first series of this valuable journal, which has been so excellently published by Heer Trap. The first article, by Schmeltz, on a Dyak and two Japanese swords, is lavishly illustrated by three coloured plates. Baron van Hoëvell describes and figures the flattening of the skull and chest in Buool (north coast of Celebes). The chest flattening-board is always employed on the boys, but not always the head-board; both are always inflicted on the girls, the object being solely for beauty, and to improve the marriage value of the latter. It is not for the purpose of making them clever and active, for the people themselves say "Reason is the gift of God." Schmeltz adds an appendix, in which he gives the geographical distribution of the custom of skull deformation.

SOCIETIES AND ACADEMIES.

LONDON.

Royal Society, February 1.—"An Instrument for Grinding Section-plates and Prisms of Crystal of Artificial Preparations accurately in the desired directions." By A. E. Tutton.

By means of this instrument a truly plane surface may be ground and polished in any desired direction in a crystal accurately to within ten minutes of arc, in a fraction of the time required for the hand grinding of an approximately true surface, and without danger of fracturing the crystal. It consists essentially of four parts. (1) A rotating horizontal divided circle, within the vertical axis of which two other axes are capable of vertical motion; the innermost carries at its lower extremity the crystal and its means of adjustment, and the other is connected with a counterpoising apparatus by which the pressure with which the crystal bears upon the grinding disc can be modified according to its relative softness and friability. (2) A series of graduated circular adjusting movements by which the desired direction (plane) in the crystal can be brought exactly parallel to the grinding surface. (3) A horizontal collimator and telescope for goniometrically observing the crystal. (4) A rotating table carrying a detachable grinding disc of ground glass, and underneath it a polishing disc of much more finely ground glass. A special crystal holder is also provided, which enables a second surface to be ground truly parallel to the first. Prisms may be ground with the same facility as section-plates.

"An Instrument of Precision for producing Monochromatic Light of any desired Wave-length, and its Use in the Investigation of the Optical Properties of Crystals." By A. E. Tutton.

This instrument enables the whole field of an optical instrument to be evenly and brightly illuminated with spectrum monochromatic light of any desired wave-length. It has been devised especially for use in connection with the axial angle polariscopical goniometers, spectrometers, stauoscopes, microscopes, and other instruments employed in the investigation of the optical properties of crystals, but is capable of much more extensive application. It was suggested by the apparatus described by Abney (*Phil. Mag.* 1885, vol. xx. p. 172), but differs from that arrangement in most of its details, and particularly in the employment of a fixed instead of a movable exit slit; of a rotatory instead of a fixed dispersing apparatus, which is capable of accurate graduation for the passage of rays of definite wave-lengths through the exit slit; and in the manner of utilising the

issuing line of monochromatic light, which, instead of being directed upon an opaque white screen, is diffused so as to be evenly distributed over the field of an observing instrument when that instrument is placed directly in its path.

The instrument resembles a compact spectro-cope in appearance. The two optical tubes are exactly similar. Each carries a slit, the jaws of which are made to move equally on each side of the line of contact, and a lens combination of two inches aperture, in order to pass a large amount of light. A single prism of heavy flint glass is employed, of large size and of the highest dispersion compatible with freedom from colour; it is carried upon a rotating divided circle. Either optical tube may be used as collimator. The other may be converted into a telescope for the purpose of graduating the instrument by attaching an eyepiece in front of the slit; the knife edges of the latter, which are clearly focussed by the eyepiece, serve as parallel cross-wires between which solar or metallic lines may be adjusted by rotation of the prism. The readings of the circle for such positions are recorded in a table supplemented by a curve. Upon removal of the eyepiece and illumination of the receiving slit by any sufficiently powerful source of light, monochromatic light of any desired wave-length may at once be produced by setting the circle to the reading recorded for that wave-length. The issuing line of coloured light is widened just sufficiently to fill the whole field of the observing instrument by attaching a screen of very finely ground glass, carried in a short tube sliding along a bar, about one inch in front of the exit slit. Upon bringing the optic axial angle goniometer, carrying an adjusted section plate, close up so that the end of the polarising tube almost touches the ground glass, the interference figure is observed sharply defined upon a homogeneously coloured and illuminated background. The arrangement is particularly valuable for the study of cases of crossed axial plane dispersion. It is equally adapted for use in the determination of indices of refraction by the methods of refraction or total-reflection, and also in the determination of extinction angles by means of the stauro-cope.

Chemical Society, January 18.—Dr. Armstrong, President, in the chair.—The following papers were read:—The molecular formulae of some liquids as determined by their molecular surface energy, by Miss E. Aston and W. Ramsay. The molecular weights of phenol and bromine in the liquid state are somewhat greater than in the gaseous state: liquid nitric acid has approximately the molecular formula  $H_2N_2O_6$ . The molecule of liquid sulphuric acid below  $132^\circ$  has the composition  $32H_2SO_4$ ; liquid phosphorus has the normal molecular composition  $P_4$ . Chloropicrin has the composition  $CCl_2(NO_2)_2$ .—Contributions to our knowledge of the aconite alkaloids. VIII. On picroconitine, by W. R. Dunstan and E. F. Harrison. The "picroaconitine," obtained by Groves from the roots of *Aconitum Napellus* is merely impure isoconitine.—Contributions to our knowledge of the aconite alkaloids. IX. The action of heat on aconitine, by W. R. Dunstan and F. H. Carr. On heating aconitine it breaks up into acetic acid and pyraconitine,  $C_{31}H_{41}NO_{19}$ ; the latter base on hydrolysis yields benzoic acid and pyraconitine  $C_{21}H_{37}NO_9$ .—Contributions to our knowledge of the aconite alkaloids. X. Further observations on the conversion of aconitine into isoconitine, by W. R. Dunstan and F. H. Carr.—Interaction of benzylamine and ethylic chloracetate, by A. T. Mason and G. R. Winder. The first product of the action of benzylamine on ethylic chloracetate is benzylamidoacetic acid; the latter readily condenses, yielding dibenzyl- $\alpha$ - $\gamma$  diacipiperazine.—Condensation products from benzylamine and several benzenoid aldehydes, by A. T. Mason and G. R. Winder.—Constitution of rubiadin, by E. Schunck and L. Marchlewski. The authors assign the following constitution formula to rubiadin:—

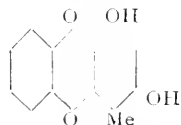

—The monalkyl ethers of alizarin, by E. Schunck and L. Marchlewski.—Ruberhythric acid, by E. Schunck and L. Marchlewski.—The colouring matter of the Indian dye-stuff "Tesu," by J. J. Hummel and W. Cavallo. The dye-stuff "Tesu" consists of the dried flowers of *Butea frondosa*; the latter contain a glucoside which on hydrolysis yields a compound of the formula  $C_{15}H_{14}O_5$ .

Linnean Society, February 1.—Prof. Stewart, President, in the chair.—The President exhibited a remarkable specimen of a South African butterfly, *Tetracolis halyattes*, from Natal, in which the wings on one side were those of a male, and on the other those of a female, and made some remarks on hermaphroditism in the Lepidoptera.—On behalf of Mr. William Borrer, of Cowfold, Sussex, there was exhibited a skull of the pine marten, *Martes sibirica*, Nilsson, from a specimen killed near Crawley (*Zool.* 1891, p. 458), an examination of which confirmed the view of the late E. R. Alston (*P.Z.S.* 1879, p. 466), that so far as could be ascertained this is the only species of marten found in the British Islands.—On behalf of Mr. W. B. Tegetmeier, there was exhibited a drawing of a snow leopard taken for the first time from life, namely, from the animal now living in the Zoological Society's Gardens, Regent's Park. The long, thick, and soft fur, suggestive of a cold habitat, and the unusual size of the wide spreading feet, well suited for travelling over an expanse of yielding snow, were noteworthy features.—Mr. Malcolm Laurie read a paper on the morphology of the *Pedipalpi*. He considered the first two ventral sclerites of the abdomen to be appendages, and not sternites. The first of these—the genital operculum—covers the ventral surface of two segments, the genital aperture and the first pair of lung books lying beneath it. The first pair of lung books, he thought, probably represent the remains of the appendage of the second segment. The arrangement of this region resembles that in *Eurypteridae* and in the spiders (e.g. *Liphistius*), while differing markedly from that in scorpions. The posterior end of the intestine is dilated into a large stercoral pouch which is part of the mid-gut, the malpighian tubes arising from its posterior end. The cephalothoracic portion of the mid-gut differs in structure from the abdominal portion, and in addition to lateral diverticula has two median ventral diverticula. The conal gland opens at the base of the third pair of appendages, and a sensory organ of unknown function occurs on each side of the last segment. A discussion followed, in which Mr. R. I. Pocock, Mr. H. M. Bernard, and the President took part, and Mr. Laurie replied.—A paper was then communicated, by Mr. W. West, on the fresh water algae of the West Indies, in which several new species were described and illustrated. Mr. G. Murray, in commenting on this paper, testified to the extreme care and accuracy with which the species had been worked out.

Zoological Society, February 6.—Sir W. H. Flower, K.C.B., F.R.S., President, in the chair.—The secretary read a report on the additions that had been made to the Society's menagerie during the month of January, 1894.—Mr. Sclater exhibited a fine mounted specimen of the Riverhog of Madagascar from the Tring Museum, lent for exhibition by the Hon. W. Rothschild, and pointed out that three distinct species of this well-marked genus of *Suidæ* were now known to occur in the Ethiopian region. A communication from Mr. Last gave an account of the habits of this animal, as observed in Madagascar.—Mr. Sclater also exhibited a stuffed specimen of the Whitebilled Great Northern Diver (*Colymbus adamsi*) from Norway, which had been lent to him by Prof. R. Collett, and made remarks on the distribution of the species, and on its interest as occasionally occurring on the British coast.—Prof. Howes read a paper on synostosis and curvature of the spine in fishes, with especial reference to the Common Sole.—Mr. F. E. Beddard, F.R.S., gave an account of the development of the Tadpole of an African Frog (*Xenopus laevis*), as observed in specimens of this Batrachian hatched and reared in the Society's Gardens.—Mr. Chas. W. Andrews gave an account of some remains of the extinct gigantic bird (*Æpyornis*) which had been recently received at the British Museum from several localities in Madagascar. These were referred to three species—*Æ. muelleri*, *Æ. medius*, and *Æ. titan*, the last being of larger size than even *Æ. maximus*. Another set of remains showed differences which might eventually prove to be of generic importance, and were perhaps referable to the newly established genus *Muellerornis*.—Mr. M. Barkley read some notes on the Antelopes of the Pungue Valley, East Africa, as observed by him during a recent hunting expedition in that district.—The Marquis of Hamilton made some observations on the Antelopes met with by him during a recent excursion from the Pungue along the coast northwards towards the Zambesi.—Mr. O. Thomas read the description of a new species of Bat of the genus *Stenoderma* from Montserrat, West Indies, proposed to be called *S. montserratense*. This Bat was stated to be very injurious to the cacao plantations in that island.

NO. 1268, VOL. 49.]

Entomological Society, February 7.—Mr. Henry John Elwes, President, in the chair.—The President announced that he had nominated the Right Hon. Lord Walsingham, F.R.S., Prof. Edward B. Poulton, F.R.S., and Colonel Charles Swinhoe, vice-presidents of the society for the session 1894-95.—Mr. Jenner Weir exhibited, on behalf of Mr. J. M. Adye, a specimen of *Plusia moneta*, Fabr., which had been captured at Christchurch, Hants, and remarked that this species, which had been found in this country for the first time so recently as June, 1890, was apparently becoming a permanent resident here, as it had been since taken in several of the southern counties. He also remarked that *Aconitum napellus*, on which the larva fed, though rare in England as a wild plant, was very common in gardens. Mr. Jenner Weir also exhibited a nearly black specimen of *Venilia macularia*, L., the yellow markings being reduced to a few small dots.—Mr. Hamilton Druce exhibited a female specimen of *Hypochrysoys scintillans*, lately received by him from Mioko, New Ireland. He said that only the male of this species had been as yet described.—Mr. F. Enock exhibited, and made remarks on, a nest of the British Trap-door Spider, *Alypus picus*, recently found near Hastings by Mrs. Enock.—Mr. W. F. H. Blandford stated that he had recently obtained an additional species of *Scolyto-platypus* from Japan, which, though closely allied to the species he had formerly described, showed a very distinct modification of the male proteronum.—Mr. M. Jacoby exhibited and remarked on a specimen of *Leptispa pygmaea*, Baly, which was doing much injury to sugarcane in the Bombay Presidency. Mr. G. C. Champion stated that he had found an allied species on bamboo.—Dr. F. A. Dixey read a paper (which was illustrated by the oxyhydrogen lantern) entitled "On the Phylogeny of the *Pierina* as illustrated by their wing-markings and geographical distribution." A long discussion ensued, in which the President, Mr. Osbert Salvin, F.R.S., Mr. Jacoby, Colonel Swinhoe, Mr. Jenner Weir, Mr. Hampson, and Mr. Kenrick took part.—Dr. T. A. Chapman read a paper entitled "Some notes on those species of Micro-Lepidoptera whose larvae are external feeders, and chiefly on the early stages of *Eriocrophaia calthella*." Mr. Hampson and the President made some remarks on the subject of the paper.—Mr. Hamilton H. Druce read a paper entitled "Description of the female of *Hypochrysoys scintillans*, Butl."—The Rev. Dr. Walker communicated a paper by Mr. R. H. F. Rippon, entitled "Description of a variety of *Ornithoptera (Priamoptera) urvilliana*."

#### CAMBRIDGE.

Philosophical Society, January 29.—Prof. T. McKenny Hughes, President, in the chair. The following communications were made:—Electricity of drops, by Prof. J. J. Thomson. The experiments and observations of Lenard were first referred to. No electrification is detected in a free falling drop, but if drops after falling be arrested by coming in collision with a plate or wire, the droplets generated in the splash are found to be electrified. Prof. Thomson, has studied the conditions more closely. The electrification on a free falling drop is masked by the opposite electrification of the air surrounding it, till by some sudden blow the drop is broken up. Special observations show that the blow does not generate the electricity, but merely separates already existing opposite electrifications. The effects produced by various liquids have been studied, and it appears that there is an obvious connection between the nature (reducing or oxidizing) of the liquid used and the kind or amount of electrification detected. A very small amount of impurity in water is enough to produce a marked change in the electrification observed. The most remarkable case is that of phenol; this substance is only moderately soluble in water, but if only 2cc. of water saturated with phenol is added to 100 cc. of pure water, the increase in electrification is obvious; and when 2.5 cc. of solution are added to 100 cc. of water, the effect on the electrometer is nearly seven times that due to pure water. The sign and magnitude of the electrification depend on the nature of the gas through which the drops fall before breaking up, hydrogen producing effects opposite to those produced by air. No electrification can be detected when drops of water fall through pure water-vapour, but the smallest addition of air brings about electrification.—Mr. Griffiths described an easy method of making absolutely air-tight joints between glass and metal tubes, by means of an alloy which has a low melting-point. The use of this alloy was suggested by Mr. F. Thomas. An illustration was given of the ease and

certainty of the method.—A compensating open-scale barometer was then exhibited and described by Mr. Griffiths. The principle of this instrument is the same as that of Prof. Callendar's long distance air thermometer. An air bulb is placed within a second bulb, and the annular space between them is filled with sulphuric acid. The air and the  $H_2SO_4$  have a common surface in a tube connecting the two bulbs, the  $H_2SO_4$  also communicates with the air by means of a vertical tube partially filled with acid. The masses of air and sulphuric acid are so adjusted that when the temperature of the instrument is raised, the increase in pressure due to the increased length of the sulphuric acid column in the vertical tube exactly counterbalances the increase in pressure of the contained air, and thus the position of the common surface is unchanged by alterations in temperature, although at once affected by alterations in the external pressure. The resulting scale is about six times as open as the scale of a mercury barometer, and the readings give the pressure expressed in terms of the length of a column of mercury at  $0^\circ C.$  in latitude  $45^\circ$ , without any preliminary calculations.—On the condition of the interior of the earth, by Rev. O. Fisher. The author has lately calculated the tidal deformation of a liquid earth owing to the attraction of the moon, assuming Laplace's law of density; the moon's potential is substituted for that of the centrifugal force in the usual calculation of the earth's figure by means of Laplace's functions; and the result obtained is a deformation of 3.45 feet, or 6.90 feet from highest to lowest. This value is nearly four times as great as a value used in an earlier paper "On the hypothesis of a liquid condition of the earth's interior, &c." read in May, 1892. The calculation of the new value leads the author to consider that the first three pages of the earlier paper lose their force, though the remaining portions stand unaffected. The author points out that the existence of ocean tides is not a conclusive argument in favour of rigidity, inasmuch as on the hypothesis of liquidity mountains must have "roots," sinking deep into the heavier liquid, the result being a deflection of the tidal wave in the substratum, whence would arise irregularities analogous with "establishment of ports."—On a combination of prisms for a stellar spectroscope, by Mr. H. F. Newall. An isosceles and nearly equiangular prism is polished on three faces, and light from a collimator after falling on the base and emerging from one side falls normally on the hypotenusal face of a right-angled prism, and after two reflections within the prism is made to fall upon the third face of the first prism and to emerge from its base. The spectroscope has therefore a dispersion equal to that of two prisms, and is arranged so that the light reflected from the base at primary incidence passes into the same telescope as is used to view the spectrum, and gives rise to a simple image of the slit, which can be used as a luminous pointer. For astronomical purposes it is convenient; for, when the slit is widened, an image of the star can be seen, and the star may be identified amongst its neighbours. The brightness of the pointer is proportioned to the spectrum to be observed. No double adjustment is necessary in directing the telescope.

## DUBLIN.

Royal Dublin Society, December 20, 1893.—Prof. D. J. Cunningham, F.R.S., in the chair.—Dr. G. Johnstone Stoney read a paper upon vision, with special reference to vision with compound eyes. The most interesting points brought out by this investigation are the two following:—(1) The amount of detail that is visible by human beings is limited by the spacing of the cones in the macula lutea of the human eye, by the limited size of the pupil, and by spherical and chromatic defects in the eye regarded as an optical instrument. In persons with the best vision, these three limiting causes concur in fixing about one minute of arc as the smallest angular interval to be subtended by two objects at the eye, in order that they may be visible as two. With an insect's compound eye a corresponding limit is placed by the spacing of the lenses over its cornea, and by the small aperture of each lens. Judging from these, we learn that predatory insects, such as dragonflies, which have the largest number of lenses, see so much less perfectly than we do that the angular interval at which two objects must stand to be seen as two, is nearly a degree; while in moths, butterflies, bees, ordinary flies, &c. which have not this great number of facets, the angular interval that is requisite rises to be two degrees or more: so that such insects do not see details upon their own antennae, close to them as they are, so distinctly as we can see them from the great distance from which we are obliged to view them. Moreover, when

the number of facets has to be increased, as it is in predatory insects, in order to improve their vision, it is necessary at the same time that the aperture of each lens should not be unduly diminished. This accounts for why the compound eyes of such insects are of excessive size when compared with their other features. (2) Again, our eyes see distinctly only a small central patch of the field of vision, but can be directed towards various objects in succession by rotating the eye in its orbit, and can be accommodated to the distance of each. There is no such motion of rotation possible to insects, but in compensation they seem to be able to see distinctly throughout the whole of the field of vision, and to have the remarkable power of being able simultaneously to adjust the different parts of their compound eye to see distinctly at different distances, so that, for instance, a wasp hovering over a breakfast-table can accommodate his eyes to see with as much distinctness as the insect can see, the several objects on the table, though they may be at very different distances from him.—Dr. J. Joly, F.R.S., read a paper on the effect of temperature upon the sensitiveness of the photographic dry plate, of which the following is a brief abstract: The visible spectrum photographed upon plates one-half of which were maintained at a low temperature (about  $-30^\circ C.$ ) and the other half kept warm, showed that the loss of sensitiveness is in the case of isochromatic plates confined almost entirely to the yellow-green and green-blue. In fact the sensitiveness ordinarily conferred by the action of the dye is annulled save for some survival of the very strong band in the green, which is continued, much weakened, from the warm half across the cold half, and without shift. It appears from this that the use of orthochromatic plates in cold climates out of doors offers little or no advantage over ordinary gelatinobromide plates. The spectrum taken upon a cold region on the ordinary gelatinobromide plate shows a very slight weakening throughout, but most markedly in the rays of lowest refrangibility. The feeble action of the dye at low temperatures seems to confirm Abney's view that the action of the dye is mainly of a chemical nature.—At the meeting held January 17, Prof. J. Mallet Purser in the chair, the following communications were presented:—Dr. J. Joly, F.R.S., demonstrated some simple methods in teaching elementary physics. By the use of a floating piston (a contrivance enabling a wide column of mercury to be supported without friction or risk of falling out in a tube), the author uses as a "Boyle's tube" a uniform straight tube about 1 metre long, closed at one end. The tube is placed vertical with the closed end downwards, a certain volume of air  $v_1$  (defined by linear measurement upon the tube) is enclosed by a short column of mercury; the length of this added to the height of the barometer affords  $P_1$ . The air is now further loaded with mercury; and  $v_2$  and  $P_2$  measured as before. The operations are evident at a glance, and very accurate results may be obtained. To show the rate of thermal expansion of air and to convey the meaning of absolute zero, by gas thermometer, the end of the tube—all as above—is placed in melting ice, and mercury added till the air occupies 273 mm. of the tube. It is then dipped into a flask of boiling water having a long neck. The column of air now increases to 373 mm. when the usual inferences may be drawn.—Prof. D. J. Cunningham then gave a magic-lantern demonstration of the development of the convolutions and fissures of the human brain.

## PARIS.

Academy of Sciences, February 5.—M. Loewy in the chair.—On the propagation of sound against various resistances in a fluid, by M. J. Boussinesq. An analytical determination of the problem discussed in several recent communications.—On the propagation of electromagnetic waves, by M. Mascart. The mean speed of propagation is given as 302,850 km. rejecting the more doubtful results. No regular variation with the length of the waves is apparent.—On the theory of the satellites of Jupiter, by M. J. J. Landerer.—On the temperature of the higher regions of the atmosphere, by M. Alfred Angot. A reply to a recent criticism by M. G. Hermite.—On the thermal value of the replacement of phenolic hydrogen in orcin, by M. de Forcrand. The heat of solution for 1 mol. of anhydrous orcin in 2 litres of water at  $10^\circ C.$  is  $-2.64$  Cal. The mean value for replacement of one atom of hydrogen by one atom of sodium is  $+39.68$  Cal., a number very near those given by other phenols.—On campholene, by M. Guerbet. The author obtains a 73 per cent. yield by distilling  $C_{10}H_{16}O$  in presence of a trace of phosphoric anhydride. Campholene yields a hydrocarbon

C<sub>10</sub>H<sub>16</sub> by reduction with H<sub>2</sub> at 230°. It boils at 132°-134° and has the sp. gr. 0.783 at 0°. It is saturated and very inert; it yields trinitropseudocumene with difficulty when treated with fuming nitrosulphuric acid. It is identical with the hexahydro-pseudocumene obtained from Baku petroleum.—Attenuation of viper poison by heat and vaccination of the guinea-pig against this poison, by MM. C. Phisalix and G. Bertrand. The authors conclude that the toxic substances present in the poison of the viper include (1) a diastatic substance—echidnose; (2) a nerve poison—echidnotoxine. These are considerably modified if not destroyed by a temperature of 75°, and the product acquires vaccinating properties.—On the utilisation of ligneous products for the feeding of cattle, by M. Emile Mer.—Physiological observations on the kidney of the snail (*Helix pomatia*, L.), by M. Paul Girod. The snail possesses, in its urinary vesiculae, a special alkaline gland which transforms the uric acid excreted by the kidney into sodium urate.—On the salivary glands of Hymenoptera, by M. Bordas.—On an aquatic stridulating Hemipteron, *Sigara minutissima*, L., by M. Ch. Bruyant.—On the relation between marine encroachments and the movements of the earth-crust, by M. A. de Grossouvre. The movements occurring in Europe during the secondary era are traced.—On the chances of obtaining artesian waters along the Wady Ighargar and the Wady Mya, by M. Georges Rolland.—On a possible relation between the frequency of storms and the position of the moon. A letter from M. A. Barrey pointing out the relation between the age of the moon and the frequency of storms in France, in which the possibility of a connection between the perturbations of the earth's path due to the moon and the frequency of storms is shown.

BERLIN.

Physiological Society, January 12.—Prof. du Bois Reymond, President, in the chair.—Dr. D. Hausemann, on the various forms of mitotic nuclear divisions, which he divided into two groups, pathological and physiological. The first kind he further divided into three classes, according to the behaviour of the chromosomata, viz. hyperchromatic, normochromatic, and hypochromatic, of which examples are found in carcinomata and sarcomata. He had also observed differences of the chromosomata in physiological cell division, according to the tissue from which they were taken.—Prof. Munk spoke on the tactile areas of the cerebral cortex, which he had found in the well-known motor areas, whereas other observers had located them either in the hippocampal convolution (Ferrier) or the gyrus fornicatus (Horsley and Schäfer), or in the parietal regions (many clinicians). The hippocampal convolution had been soon given up as the seat of the tactile areas for the skin. The speaker had shown that it is impossible to operate on the gyrus fornicatus, owing to its position, without injury to the motor regions, and since the localisation of the tactile areas for the skin in the motor regions of the brain can only be determined by extirpation of the latter, he regarded the experiments of Horsley and Schäfer as inconclusive. With regard to the parietal lobes, experiments on monkeys and dogs showed that its removal did not upset their tactile sensibility. It is important in these observations to discriminate sharply between touch, perception of contact, pressure, &c. and the general sense of pain. The perception of the cuticular sense is connected with the motor regions, and is permanently lost when these are destroyed, whereas, on the other hand, general sensibility can be done away with by many different injuries to the brain, but reappears after a short time. The temperature sense of the skin belongs to the sense organ, and is permanently destroyed by removal of the motor areas.

AMSTERDAM.

Royal Academy of Sciences, January 27.—Prof. van de Sande Bakhuyzen in the chair.—Messrs. Hoogewerff and van Dorp gave the results of their investigations on some derivatives of camphoric acid. They succeeded in isolating two camphoric acids, which are formed according to the equations:

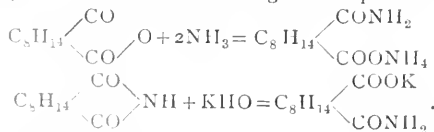

These substances are both derivatives of the same camphoric acid. The formation of these camphoric acids was ex-

plained by the authors in the following way. Camphoric acid being dissymmetrical, the atom of oxygen, linking together the two groups of carbonyl in the camphoric anhydride, and also the group NH, linking together the two groups of carbonyl in the imide, will not be attracted with equal force by the two carbonyls. The carbonyl exerting the smallest attraction towards the O in the anhydride, will also exert the smallest attraction towards the NH in the imide. In the reactions, represented by the above equations, the rings in the anhydride and imide will therefore be opened in corresponding places, whereby two camphoric acids must be formed.—Mr. Franchimont communicated a paper in his name and that of Mr. H. van Erp. The authors have compared the zinc and copper salts of the dinitromethyllic acid of Frankland with the corresponding salts of the methylnitramine, because it seems that many chemists think the two bodies were identical. Treated with diluted sulphuric acid and ether, the methylnitramine salts yield the methylnitramine with the known properties; the salts of the dinitromethyllic acid yield in the same manner an acid body, which melts  $\pm 20^\circ$  higher than the methylnitramine, and differs in form and solubility. The authors intend to investigate the chemical structure of the dinitromethyllic acid.

BOOKS AND PAMPHLETS RECEIVED.

BOOKS.—The Mean Density of the Earth: Prof. J. H. Poynting (Griffin).—Economic Geology of the United States: R. S. Tarr (Macmillan).—Materials for the Study of Variation: W. Bateson (Macmillan).—The Theory of Heat: T. Preston (Macmillan).—Annuaire de l'Observatoire Royale de Belgique, 1894: F. Folie (Druxelles).—Faraday as a Discoverer: J. Lindall, 5th edition (Longmans).—Statistique de la Production des Gites Metallifères: L. de Launay (Paris, Gauthier-Villars).—Construction du Navire: A. Croneau (Paris, Gauthier-Villars).—Tree Pruning: A. des Cars, translated by Prof. C. S. Sargent (Rider).—Practical Forestry: A. D. Webster (Rider).—Tobias Mayer's Sternverzeichniss (Leipzig, Engelmann).—Wood Working Positions, sheets 1 to 12 (large and small sizes): (Chapman and Hall).—Annuaire pour l'an 1894 publié par le Bureau des Longitudes (Paris, Gauthier-Villars).—Ostwald's Klassiker der Exakten Wissenschaften, Nrs. 43 and 45 (Leipzig, Engelmann).—Gestaltung und Vererbung: Dr. W. Haacke (Leipzig, Weigel).—Beni-Hasan: P. E. Newberry, part 2 (K. Paul).—Norwegian North Atlantic Expedition, 1876-8, xxii., Zoology, Ophuroidea: J. A. Grieg (Low).  
PAMPHLETS.—Scarlatina and Scarlatinal Sore Throat: Dr. A. K. Chalmers (Glasgow).—Researches on Matrices and Quaternions: Dr. Th. B. van Wetum (Leyden, Brill).—A Short History of Astronomy: G. Knight (Phillip).

CONTENTS.

PAGE

|                                                                            |     |
|----------------------------------------------------------------------------|-----|
| Recent Researches in Electricity and Magnetism. By Prof. A. Gray . . . . . | 357 |
| Greenhill's Elliptic Functions. By H. F. Baker . . . . .                   | 359 |
| The Dispersal of Shells. By Clement Reid . . . . .                         | 361 |
| Our Book Shelf:—                                                           |     |
| " The Wilder Quarter-Century Book " . . . . .                              | 362 |
| Jones: " Machine Drawing " . . . . .                                       | 362 |
| Pinkerton: " Hydrostatics and Pneumatics " . . . . .                       | 362 |
| Bottone: " How to Manage the Dynamo " . . . . .                            | 363 |
| Letters to the Editor:—                                                    |     |
| The Cloudy Condensation of Steam.—Dr. Carl Barus . . . . .                 | 363 |
| The Origin of Lake Basins.—Dr. A. M. Hansen; T. D. LaTouche . . . . .      | 364 |
| A Plausible Paradox in Chances.—Francis Galton, F.R.S. . . . .             | 365 |
| Clerk Maxwell's Papers.—Prof. Oliver J. Lodge, F.R.S. . . . .              | 366 |
| Abnormal Eggs.—W. B. Tegetmeier; E. J. Lowe, F.R.S. . . . .                | 366 |
| The Pleiades . . . . .                                                     | 366 |
| Notes . . . . .                                                            | 367 |
| Our Astronomical Column:—                                                  |     |
| A Tempered Steel Meteorite . . . . .                                       | 372 |
| Astronomy in Poetry . . . . .                                              | 372 |
| Nova Aurigæ . . . . .                                                      | 373 |
| Agricultural Experiment Stations . . . . .                                 | 373 |
| The Spencer-Weismann Controversy. By P. Chalmers Mitchell . . . . .        | 373 |
| Ancient Egyptian Pigments. By Dr. W. J. Russell, F.R.S. . . . .            | 374 |
| University and Educational Intelligence . . . . .                          | 376 |
| Scientific Serials . . . . .                                               | 376 |
| Societies and Academies . . . . .                                          | 377 |
| Books and Pamphlets Received . . . . .                                     | 380 |



THURSDAY, FEBRUARY 22, 1894.

## BOLTZMANN ON MAXWELL.

*Lectures on Maxwell's Theory of Electricity and Light.*

Part ii. By Dr. Ludwig Boltzmann. 8vo. pp. 166. (Leipzig: Barth, 1893.)

THIS second part of Dr. Boltzmann's account of Maxwell's electromagnetic theory is written from a somewhat different point of view from the first part. The first part presents the theory from the mathematical point of view of a dynamical system whose generalised coordinates are known. This one presents the theory from the physical point of view of a continuous medium whose intimate structure is indeed not fully understood, but whose changes of structure can be fully represented by certain vectors. Although Maxwell has presented the subject from both points of view, the one which really determines the form of his work, and that appears to have led him in his investigations, is the physical view of this second part. A purely analytical view is hardly ever as suggestive as a physical and geometrical one. This latter one suggests extensions, suggests advances in a way that purely analytical investigations seldom do. Compare, for instance, Ampère's investigation of the action of elements of currents on one another with Faraday's treatment of the same subject. The latter has suggested the whole of the recent advances, the working of the ether, the identity of light and electromagnetic waves. The former was magnificent, brilliant no doubt, but it was cold and dead.

In the preface to this second part, Dr. Boltzmann explains the absence of diagrams, marginal notes, &c. which appeared in the former part. He says a friend conveyed to him the valuable criticism that "Your book is dear." He has consequently left out the embellishments that Englishmen love, as being too expensive for the poor German student, and has only left the motto, which costs nothing, to wit:—

"War es ein Gott, der diese Zeichen schrieb  
Die mit geheimnissvoll verborg'nem Trieb  
Die Kräfte der Natur um mich enthüllen  
Und mir das Herz mit stiller Freude füllen."

And even this he has not taken from that classic lore that Englishmen delight in, but from a German poet.

Although he regrets the dark and inconsequent character of much of Maxwell's work, he congratulates scientific men that this has left them the more to do. For himself, he only claims to be an exponent of Maxwell's views, and hopes that he may succeed in helping students to understand them.

Electromagnetic equations lend themselves to a great variety of interpretations by analogy with displacements of a medium. They are a system of vectors related to one another by a very simple method of derivation each from the last, by the process of what Dr. Boltzmann says the English call "curling." Starting with the vector potential, the magnetic force is its curl, and the curl of the magnetic vector is the time rate of variation of the electric vector. Any one of this system of vectors may be likened to the displacement or velocity of an incompressible medium, and hence we have one system in

which the vector potential is so likened, one in which the electric displacement is so likened, and one in which the magnetic displacement is so likened. These latter two analogies have been the favourite ones. Maxwell frequently speaks in terms of the system in which the electric vector is likened to a displacement of an incompressible medium, and the likening of the magnetic vector to a flow is quite common. In these systems electric energy is generally considered as potential, and magnetic energy as kinetic. Dr. Boltzmann, however, likens the vector potential, which he calls the tonus, and which Mr. Oliver Heaviside relegates to the realms of merely convenient suppositions, to a displacement of the medium; and in accordance with this analogy the magnetic energy becomes potential, and the electric vector, which is proportional to the rate of variation of the vector potential, being thus a velocity, requires the assumption that electric energy is kinetic. An obvious difficulty arises here from the necessity of making an electric current an acceleration which cannot of course be constant for ever. In this connection it may be worth while observing that the possible existence of one closed surface inside another with static lines of the electric vector between them makes it necessary to assume either (1) that the vector potential represents a twist round its line, and not a displacement along it; or (2) that it is a displacement up some lines and down others; or (3) that there are sources and sinks of the ether where there is electrification, because without sources and sinks we cannot have a continuous flow going on out from a closed inner surface to a closed outer one. If the tonic vector be a twist, the magnetic vector will be of the nature of a  $\Delta^2$ , and it would be this structure which should be elastically resisted, and not a twist, as Dr. Boltzmann's and Mr. Larmor's assumptions give. This would return somewhat to Mr. Glazebrook's proposal of years ago. Of course, a complex change of structure, such as a combination of 1 and 2, or any other change, such as crystallisation in a hemihedral crystal, would be a possible solution. In a hemihedral crystalline form, because its two ends must differ in sign. Gravity is probably due to a change of structure produced by the presence of matter, which is analogous to a non-hemihedral crystallisation because it is always attractive; there seems no reason to suppose that any bodies exist possessing negative gravitation, the supposed levity of the old philosophers.

To the vector potential, Boltzmann gives Faraday's name of electrotonic state at the point, or, shortly, the tonus of the element of volume. The rate of change of this tonus is the electric vector  $E$ , and the kinetic energy due to it is the electric energy per unit vol.

$$T = K/8 \pi \cdot E^2$$

This tonic strain is accompanied in general by a tonic stress depending on the curl of the tonic vector which is the magnetic vector,  $H = \text{curl } E$ , and a corresponding potential energy

$$V = \frac{\nu}{2} H^2.$$

All this is most interesting in connection with Mr. Larmor's recent papers. He uses Maxwell's analysis in which the magnetic energy is kinetic, and consequently assumes the magnetic vector to be a flow, which he has

pointed out can exist as an irrotational one without reaction in MacCullagh's medium. This same observation of course applies to Dr. Boltzmann's analysis, the difference being that vortex rings would be rings of magnetic current instead of electric current, and atoms would act like electric diads instead of elementary magnets. The existence of unclosed lines of electric vector, however, seems to make this simple interpretation of Dr. Boltzmann's analysis impossible, and as we cannot in general substitute whirl for flow in fluid motion, the vortex ring analysis could not be applied if Dr. Boltzmann's electric vector were interpreted as a whirl; and hence Mr. Larmor's investigation seems confined to the interpretation he has given.

Having assumed that the medium is such as to react elastically against curl of the tonus ( $\tau$ ), and his fundamental equations thus being—

$$(1), E = \dot{\tau}; (3), T = K/8 \pi \cdot E^2 \\ (2), H = \text{curl } \tau; (4), V = \nu/2 \cdot H^2$$

he proceeds to deduce the equation corresponding to (2), namely, (5)  $K\dot{E} = \text{curl } H$  by applying Hamilton's principle to  $T - V$  in a way which is well known. He now remarks that in accordance with his dynamical principles  $K\dot{E}$  is rate of change of momentum, and he adds to curl  $H$  any external impressed forces, which he divides into two classes: (1) those due to reversible causes, such as electromotive of contact, chemical action, &c. ( $F$ ); and (2) those due to irreversible causes, such as ohmic resistance, &c., which are proportional to the electric vector, and thus obtains this equation in the form

$$KE = \text{curl } H - 4\pi C (E + F)$$

It would thus seem as if the electric conduction current were a different thing from a changing electric displacement, though both depending on curl  $H$ . This arises from the difficulty noticed above, and seems to require careful consideration. By judicious theories as to the function of the matter in stopping the continual acceleration without uncurling the  $H$ , the difficulty can be surmounted. In order to get over all the difficulties of discontinuities at the surfaces of bodies, Dr. Boltzmann assumes that the properties of the ether vary rapidly but continuously in passing across a surface, so that he can assume that these equations apply everywhere.

Depending on his dynamical basis, Dr. Boltzmann has obtained the following dimensions for electromagnetic quantities, which, of course, differ entirely from both the electric and magnetic systems of units—

$$[E] = [LT^{-1}], [K] = [ML^{-3}] \\ [H] = [ML^{-1}T^{-2}] * [\mu] = [M^{-1}LT^{-2}]$$

After a short discussion as to the possibility of founding the science upon a purely analytical basis, by assuming equations and showing that they lead to true results, which is the basis of Hertz's method, and a short criticism of this method as applied by Hertz, Dr. Boltzmann proceeds to show how the old equations of action at a distance and von Helmholtz's work are connected with Maxwell's view of the subject. His treatment of superficial effects by means of a rapid variation of structure of the ether at the surface of solids, seems essentially the

same as Mr. O. Heaviside has advocated in opposition to von Helmholtz's double electric layers. All this analytical method is, of course, necessary and interesting in what may be called a transition work, one that concerns those who have been brought up under one school of thought and are entering another; a sort of epistle to the Hebrews, a college between youth and manhood. It concerns the past rather than the future, towards which we should press, forgetting those things that are behind.

Although Dr. Boltzmann has left out all embellishments, he has had pity on his readers. There are necessarily included in a transition work of this kind innumerable formulæ, of which 168 are frequently referred to, and these he has collected into two folding sheets, each of five folds, at the end of his work. This is most considerate. Books dealing with many formulæ might well follow suit, although it certainly is a little terrifying to have 168 formulæ presented as the outcome of the book in a way that necessarily attracts the attention of anyone who thinks of reading it. Those who are frightened by this should, however, recollect that the whole subject of electromagnetism depends on only four very simple equations. Dr. Boltzmann would have much simplified his work if he had adopted any vector symbolism.

It is to be hoped that this part of Dr. Boltzmann's work, as well as the former part, will soon be translated, and so made easily accessible to English students. The work of a great master, the product of a great mind, helps all men who can understand it.

#### THE STORY OF THE SUN.

*The Story of the Sun.* By Sir Robert Ball, LL.D. (London: Cassell and Co., 1893.)

THERE is no more interesting chapter in science than that which deals with our great central luminary. Its story has been gradually gaining in interest since the first application of the telescope to its study by Galileo, and since the advent of the spectroscope our knowledge of solar phenomena has advanced by leaps and bounds. At the present time the scrutiny of the sun is more minute and continuous than ever, and the constant acquisition of fresh information sufficiently explains the need for additional works on the subject, or for new editions of old ones.

The author of the book before us does not approach the subject as a practical investigator in this branch of astronomy, and his efforts are therefore chiefly intended for the delectation of that class of readers for which he chiefly caters. The first thing that strikes one on glancing through the pages of the book is the great variety of the matter which it contains, and one begins to wonder if he has mistaken the title of the volume. It is not too much to say that nearly every department of astronomical inquiry is touched upon more or less; from the determination of the polar flattening of the earth to the photography of minor planets and the appearances of nebulae. Though the author never seems at a loss to give reasons for the introduction of matter apparently not at first sight connected with the subject in hand, his reasons frequently appear to be nothing more than excuses for filling so many pages. For example, we fail to see the necessity

\* This is misprinted in the text, but right in the table of formulæ at the end of the book.

of devoting a whole chapter to the members of the solar system, or a large part of a chapter and a full-page plate to eclipses of the moon; again, the discussion of the Glacial Period surely belongs more to the story of our own planet than to that of the sun, and might very well have been omitted.

This method of treatment is the more objectionable as it has evidently involved the omission of reference to many observations of great interest, and must inevitably tend to give the impression that our knowledge is very much less than it is in reality. At the same time it does an injustice alike to the reader, and to the army of workers who devote their energies to the pursuit of this branch of knowledge.

Again, the story of the sun would certainly lose none of its charm by historical treatment, but we look in vain for even the barest mention of the names of Ångström, Thalén, Faye, Cornu, Perry, Balfour Stewart, and a host of other workers who have taken so great a part in solar inquiries.

So far as it goes, however, the story of the sun is told in that fascinating way which has deservedly brought the author fame, and our greatest cause of complaint is that it does not go far enough. The first five chapters, occupying nearly one-third of the book, deal with the solar system, the sun's distance, and the sun's mass. In these well-worn subjects there is nothing new to tell and little scope for novelty, but occasionally we come across some of the bright illustrations at which the author is so expert; as, for instance, the endeavour to impress the reader with the magnitude of the velocity of light.

In chapter vi. a fair account is given of the total amount and spectroscopic analysis of the "light of the sun." A coloured plate of the solar spectrum is of unusual excellence, but many of the finer details of Mr. Higgs's photographic spectrum are lost in the reproductions, and scarcely do justice to the originals.

After a chapter on the causes of eclipses, we come to one on sun-spots, and here we first find evidence of the incompleteness to which reference has been made. The appearances presented by spots are fully described and illustrated by a most liberal allowance of diagrams, but no mention is made of "veiled spots." The rate of solar rotation is discussed in considerable detail, but if the spectroscopic results are to be mentioned at all, Dunér's observations might have found a place alongside those of Mr. Crew. The author seems to favour the idea that the varying rotation of the photosphere in different latitudes is produced by the friction of concentric shells of the matter of which it is formed; other views, not less probable, are utterly ignored; as, for instance, one which follows from the theory that spots are formed by down-rushes of cool vapours—an explanation which Sir Robert Ball has adopted as the most probable. The reader is also left in blissful ignorance of the fact that astronomers have taken the trouble to make a minute study of the spectra of sun-spots, although this work has been going on continuously for the last fifteen years, chiefly at Kensington and Stonyhurst. Of the existence of the Committee on Solar Physics, and of the continuous photographic record of the spots which it has organised, the author seems to have no knowledge. Even the importance of the eleven-yearly period does not appear

to be clearly grasped, and only the very briefest references are made to this fundamental solar unit.

The chapter on solar prominences contains most of the ordinary information on the subject, and has the merit of including some of the most recent observations by Trouvelot and Fenyi. In addition, Prof. Hale's remarkable work in photographing these objects is considered in some detail. Very little attempt is made, however, to distinguish between quiet and eruptive prominences.

The solar corona is dismissed in very few words, and the illustrations have not been well chosen. In giving a somewhat detailed account of the American expedition to French Guiana to observe the eclipse of December 1889, it would have been gracious to record the fact that it was during an expedition to this place at the same time that the late Father Perry met with his fate. The author's estimate of our spectroscopic knowledge of the corona is very low, and it is disposed of in twenty lines; but this meagre description is due to the fact that the most recent observations referred to are those made by Janssen in 1871!

It has been well remarked that "hypothesis is the soul of investigation," but our author makes no attempt to give a full or complete account of any theory; apparently on the ground that we are still so "very ignorant concerning the actual physical nature of the great luminary." The principal point of theory touched upon is that which concerns the materials of which the photosphere is composed, the ordinary view that it consists of glowing clouds being accepted. Working on the lines of a suggestion made by Dr. Johnstone Stoney in 1867, the author argues in favour of the view that to carbon "belongs the distinction of being the main source whence sunlight is dispensed." (p. 289.) This certainly seems as probable as the generally accepted idea that the photosphere consists of liquid metals, but it does not give us any further insight into the causes of the various phenomena which are observed. The study of the circulation of the sun's atmosphere will no doubt eventually furnish the key to most of the problems of solar physics; but here our author leaves us, with nothing more than an unexplained diagram illustrating a theory of the solar currents.

Of the chapter dealing with solar and magnetic phenomena, we have only to note that the author repeats the mistake with reference to the Carrington-Hodgson outburst—a subject which has already been discussed in these columns. He makes a suggestion, however, which may be well worth consideration, namely, that the solar and magnetic disturbances may not stand in the relation of cause and effect at all, but are each of them "manifestations of some other influence of electromagnetic waves on a vast scale sweeping through our system, and influencing the magnetic phenomena in the various bodies of which our system is composed." (p. 234.)

We see the author at his best in the next three chapters, discussing step by step the probable cause of the maintenance of solar radiation. The somewhat difficult subject of molecular physics no longer remains obscure under the influence of his luminous exposition, and their application to the sun will be clear to any intelligent reader. This part of the subject is only marred by the

false analogy with Nova Aurigæ, which is pointed out as suggesting a possible original source of the sun's heat. We should have imagined that phenomena which last only for a few weeks, must be vastly different from those which continue for millions of years.

From one point of view the discourse on "the sun as a star" is excellent. It is certainly interesting to know that the sun is only one of many millions of stars, that it does not travel so quickly in space as 1830 Groombridge; or again, that it is a certain number of times less massive than Arcturus; but not less interesting is the study of its physical relation to the other stars—what stars it may have resembled in the past, and what it will probably resemble in the future. On this latter question much light has been thrown by recent work on stellar and nebular spectra, with which we cannot but suppose the author to be familiar. The whole of this great problem, however, is discussed in little more than a page of text and a page of *drawings* of stellar spectra, on various scales, to which no direct reference is made. The fact that carbon plays such a prominent part in the absorption spectra of one group of stars is not mentioned, and the author seems to have utterly failed to see the significance of it in relation to the presence of carbon in the sun, of which he makes so much in another chapter. From the evolutionary point of view this is obviously a fact of the first importance, indicating that as the sun goes on cooling the carbon absorption will increase until finally its spectrum will resemble that of such stars as 152 Schjellerup. The presence of a plate illustrating various nebulæ led us to suppose that we should be treated to the story of the sun's probable growth from the nebulous stage, but we were disappointed to find that they were only intended to indicate that our sun is but one of a myriad host of stars!

Sir Robert Ball's views of the cause of the Ice Age, which have already been discussed in NATURE, are very clearly set forth, and he maintains that "it is impossible to doubt the truth of the main factors in the astronomical theory of the cause of Ice Ages" (p. 319).

The final chapter, on "the movements of the solar system," is an excellent exposition of the method by which the direction of the sun's motion in space is ascertained.

We may perhaps repeat that the story of the sun is told admirably so far as it is told at all, but we regret to find that so many solar inquiries of the greatest interest have not had the great benefit of description by the author's graphic pen.

We have nothing but praise for the excellence of the majority of the plates and diagrams, and the printing is also bold and clear.

A. FOWLER.

#### THE LEPIDOPTERA OF THE ATLANTIC ISLANDS.

*The Butterflies and Moths of Teneriffe.* By A. E. Holt White. Edited by Rashleigh Holt White, Vice-President of the Selborne Society. Illustrated from the Author's Drawings. (London: L. Reeve and Co., 1894.)

THE coleopterous fauna of the Atlantic Islands has been well worked by the late Mr. Wollaston, but as regards the *Lepidoptera*, the only obtainable information

has been either from large books (which rarely supply complete or detailed information) or detached papers, some of them very valuable, but not always easily accessible.

Consequently, when Mrs. Holt White, the wife of one of the descendants of a brother of Gilbert White, spent the winter of 1892-93 in Teneriffe for the benefit of her health, and occupied herself with the collecting and rearing of butterflies and moths, she could find no available information on the subject, and bravely resolved to do her best to supply the want. The result is the little book before us, which, though making no pretensions to be otherwise than popular, will yet be most useful to scientific entomologists, by supplying them with detailed descriptions and fairly good figures (though the first plate of the four strikes us as being somewhat coarsely coloured) of nearly all the larger *Lepidoptera* of a very interesting, though very limited fauna. One moth is described as new, and others are now figured for the first time.

A striking feature of the Atlantic Islands is the extreme poverty of their lepidopterous fauna. Our British *Lepidoptera* are considered few; but we can at least point to upwards of 2000 species; and even Iceland, though possessing no indigenous butterflies, boasts of nearly as many moths as Madeira or Teneriffe. Several causes combine to produce the scarcity of *Lepidoptera* in the Atlantic Islands. They are islands, far from the mainland, and on the extreme limits of the faunas to which they respectively belong. The native flora has in some places almost disappeared, and with it, of course, the insects dependent on it. How far the present insects of the islands are endemic, it is difficult to say. Some are certainly peculiar to the islands; the bulk of the species of the northern islands are European, or representative of European species; one or two are American, but whether introduced, or whether remnants of an outlying American fauna, it is at present impossible to say; and stranger still, one or two are East Indian in their affinities, and are not species likely to have been introduced by accident. The best representatives of the last two classes are *Pyrameis huntera* and *P. callirhoë*.

The six principal groups of Atlantic islands from north to south are the following: the Azores, Madeiras, Canaries, Cape Verdes, Ascension, and St. Helena. Of the *Lepidoptera* of the Cape Verdes and Ascension very little is recorded, and we need say no more of them in this place.

The Azores lie further to the north and west than any of the other groups. Mr. Godman's "Natural History of the Azores" (1880) is our latest authority on the *Lepidoptera*. He enumerates nine butterflies and twenty-eight moths, all British, except the North American *Danaï archippus*, and the South European *Hypena obsitalis*. It is worthy of remark that the typical *Pieris brassicae* occurs in the Azores, instead of the allied *P. Wollastoni*, which occurs both in the Madeiras and Canaries, or *cheiranthi*, which is confined to the Canaries. *P. Wollastoni*, we may here note, much resembles the North Indian *P. nipalensis*.

In the *Transactions* of the Entomological Society for 1891, Mr. Bethune-Baker published "Notes on the *Lepidoptera* collected in Madeira by the late T. Vernon

Wollaston," with one plate, enumerating eleven butterflies and fifty-six moths. The *Micro-lepidoptera*, not here included, and which have partially been worked out by Messrs. Wollaston and Stainton, were reserved for a future paper. In addition to *Pieris Wollastoni*, already mentioned, the remarkable form *maderensis* of *Gonepteryx cleopatra* (intermediate between the type and the Canarian *G. cleobule*), and the dark forms of *Satyrus semele* and *Polymmatas phlaeas* are remarkable; but much more so is the occurrence of a *Deilephila* apparently identical with the Indian *D. lathyris*.

Previous to Mrs. Holt White's book, the principal sources of our information regarding the Canaries were Webb and Berthelot's "Histoire Naturelle des Iles Canariennes," in which twenty butterflies and thirty-three moths were enumerated, and a paper by Alpheraky in the fifth volume of Romanoff's "Mémoires sur les Lépidoptères," noticing fifty-seven species, of which seventeen were butterflies, several of which are figured. We may mention that the white form of *Danaïs chrysippus*, found in Teneriffe, more resembles the Indian var. *alcippoides* than the common African var. *alcippus*. An interesting species figured by Mrs. Holt White is *Euchloë charltonia*, a species previously known from North Africa and Western Asia (not North and West Africa); and among the moths we notice a figure of *Rhyperioides rufescens*, described, but not figured, by Brullé, in Webb and Berthelot's work, and several other species peculiar to the islands. Mrs. Holt White describes twenty-nine butterflies and thirty-five moths, and adds a list of twenty-seven others, chiefly *Micro-lepidoptera*, which she considered too small or obscure to be included in a popular work. However, if a new edition of her useful little book should be required, we hope she will complete it at least as regards the *Macro-lepidoptera*, and that she may also be induced to extend it to include the *Macro-lepidoptera* of Madeira.

We may add that Dr. H. Rebel has lately published a paper on the *Micro-Lepidoptera* of the Canaries, in which sixty-three species are enumerated (*Annalen d. k. k. Naturhist. Hofmuseums*, vii.; Vienna, 1893), with one plate.

The last list of the *Lepidoptera* of St. Helena was published by Mrs. T. Vernon Wollaston in *Ann. and Mag. Nat. Hist.*, ser. v. vol. iii. (1879). A large proportion of the species are endemic; the others are chiefly wide-ranging African species, several of which are common to the Northern Atlantic Islands, and even to Europe.

W. F. KIRBY.

#### THE ACTIVE PRINCIPLES OF PLANTS.

*Dictionary of the Active Principles of Plants.* By C. E. Sohn. (London: Baillière, Tindall and Cox, 1894.)

PROBABLY no section of organic chemistry has been more prolific of results, or has added more to the literature of recent years, than that which has dealt with the vegetable kingdom. So many investigators have been occupied with the so-called active principles of plants, that the task of keeping up acquaintance with current researches is a very laborious one, and there is little cause for surprise if much work in this field is in danger of being overlooked or undervalued. On this account the publication of a work which undertakes to gather

together so many scattered papers, and to summarise in a convenient form their most important matter, is likely to be hailed with gratitude by many workers both in organic chemistry and in vegetable physiology. The author has wisely limited himself to some definite sections of the work, and the present volume deals especially with the alkaloids, the glucosides, and the bitter principles. In dealing with the literature of these, he has first set forth the members of these groups which have been chemically examined, taking them in the order of the botanical name of the plant which yields them. In the case of each he gives an account of its botanical source, the workers who have investigated it, and the chief chemical and physical peculiarities it presents. Where, as in so many cases, one plant yields more than one of such principles, all that have been prepared from it are described successively. A summary of the more striking features of each, put in tabular form to admit of ready reference and comparison, forms the second part of the work, while a rearrangement of them, grouped according to their behaviour with various chemical reagents, constitutes Part iii. An idea of the completeness and care with which the book has been compiled may be obtained from the fact that nearly 600 of these vegetable bodies have been described, while the references to contemporary literature embrace the work of the first half of 1893.

The author deals with the various bodies described chiefly, if not entirely, from the point of view of the chemist or the analyst. The therapeutical action of the drugs is but slightly touched upon, though the chief physiological actions of each have been briefly stated in many cases. Their importance to the plants in which they occur is apparently beyond the limits that the author has set himself.

As a work of reference the new dictionary will be much appreciated. It would have been more convenient for use if each page in Part i. had been headed by the name of the plant which is being treated. This has been done in Part ii., where it seems scarcely so necessary.

It is hardly to be expected in a work of this character that the proofs should pass without some slight inaccuracy. A list of errata would no doubt rectify the statement that the name of the darnel grass is *Lolium telumentum*, as stated on p. 62.

The botanist will regret that the author did not include in the scope of the work the vegetable enzymes or ferments which play such an important part in vegetable physiology. They are not very numerous, and would well have repaid inclusion. The only exception made is Papani, to which a few lines on p. 76 are allotted.

#### OUR BOOK SHELF.

*Forschungsberichte aus der Biologischen Station zu Plön.* By Dr. O. Zacharias. Theil 2, pp. 1 152. Two plates and a map. (Berlin: R. Friedländer and Sohn, 1894.)

THE second annual report from this station contains the additions made during last year to a knowledge of the fauna, flora, and physical conditions of the Plöner See, prefaced by a geological and hydrographical paper by Dr. Ule. Lists of the Diatoms are furnished by Count Castracane and Prof. Brun. A case of "the breaking of the meres," caused by great swarms of *Rivularia (Gloio*

*tricha echinulata*, is recorded, and the species is described in detail. Amongst the additions to the fauna, a fresh-water Nemertine (*Tetrastemma lacustre*) and a northern leech (*Placobdella raboti*, recorded by Prof. Blanchard), several Protozoa and Rotifers are noteworthy. It is, however, to the Plankton that the Director has devoted special attention since the founding of the station in 1891, and accordingly the influence of temperature on the constituents, their unequal distribution through the lake, and their appearance, maximum abundance, and gradual disappearance are carefully noted, together with the bearing of these facts on the present position of the Plankton question.

The occurrence of certain Protozoa (*Carchesium polyfinum* and *Epistylis lacustris*) freely floating in the Pioner See during June and July in great numbers, and under conditions that do not warrant the supposition that they had been torn away from their supports, is recorded by Dr. Zacharias, who suggests that this may be a periodic change from the fixed to the free-floating habit, and that, further, the pelagic species of *Dinobryon* and *Floscularia* may have a similar origin. The researches conducted at Plön are, however, not the first to direct attention to this point, as Dr. Zacharias asserts (p. 123). Lang ("Ueber den Einfluss der festsitzenden Lebensweise," p. 152: Jena, 1888) has already made the same suggestion, based on the presence of *Zoothamnium* noticed by himself, and more frequently by Brandt and others in plankton collected at Naples.

Another interesting point about which we at present know very little, is the changes of form assumed by the same species at different times of the year. In reference to this matter, Dr. Zacharias describes the seasonal changes in three species of *Hyalodaphnia*, *Bipalpus vesiculosus* (a rotifer), and *Ceratiium hirundinella*.

The enlarged size of this report gives evidence of the increasing interest in fresh-water biology, also shown by the fact that a new station is in process of erection on the border of the Müggel See, near Berlin. Two plates, illustrating the new species obtained, and a map of the neighbourhood of Plön, are given with this part.

F. W. G.

*Biology as it is applied against Dogma and Freewill, and for Weismannism.* By H. Croft Hiller. Second edition. (London: Williams and Norgate, 1893.)

ON a first glance through this unusual book, there rises in one's mind the delightful remark that the mother of David Hume is reputed to have made to him—"Man, Davie, you'd believe anything if it's no in the Bible." For Mr. Croft Hiller accepts in the most trusting spirit the newest conclusions and theories of modern biology, and thrusts them with a fierceness that makes the index as combative as the text, against freewill and dogma—by dogma apparently meaning ecclesiastical Christianity. But it is only fair to say that although his acceptance of scientific authorities is from the point of view of science absolutely uncritical, he states the views he has selected with an acumen that his discursive and flamboyant style cannot disguise completely. A considerable part of the book is given to accounts of controversies in which the author has been engaged, and hell-fire, plenary inspiration, and the immorality of the clergy reappear like King Charles' head. He endeavours to show that recent investigations have established the dependence of man's physical qualities on physical structure, and he accepts Weismann's view that acquired characters are not inherited. From these premises he draws sociological conclusions that made a writer in the *National Reformer* (to the pages of which Mr. Hiller was an esteemed contributor) accuse him of Toryism. But his conclusions do not always justify such a use of that appellation. They are such as the following:—That however society may attempt to equalise men, nature will

insist on producing great inequalities. That education, as its effects are not transmitted, will not directly ameliorate society by raising the general standard. That criminals are no more worthy of punishment than geniuses of reward. That while for the benefit of individuals training of individual qualities is necessary, for the benefit of the race selection of the naturally better endowed is necessary. That the mainspring of all action is selfishness, but in practice the selfishness of the individual is restrained by the selfishness of the community.

P. C. M.

*Heat: an Elementary Text-Book, Theoretical and Practical, for Colleges and Schools.* By R. T. Glazebrook, M.A., F.R.S. (Cambridge: University Press, 1894.)

A FEW months ago it was announced that the Cambridge University Press intended to publish a series of science manuals, and since that time we have looked forward with pleasurable anticipation to the appearance of the works in the series. But expectations are rarely realised. The book before us is the first of the volumes devoted to physical science, and we are not strikingly impressed with it. Some books favourably force themselves upon one's notice by their originality of treatment or lucidity of expression, but Mr. Glazebrook's volume possesses neither of these characteristics to a noticeable degree. This is said at the risk of being considered hypercritical; but there are so very many ordinary books in existence, that we almost expect a new work to be different from its predecessors in order to justify its publication at all. However, though the book before us is not the best elementary class-book on heat, it is very good. The author has not confined himself to the experimental or to the theoretical side of his subject, but has happily combined the two, so that the book suits both the lecture-room and the physical laboratory. Another commendable feature is the statements of "sources of error" after the descriptions of some of the experiments. The illustrations are line-drawings, and though somewhat coarse, they possess the merit of being clear, and that is, perhaps, the chief desideratum of a book designed for use in our schools and colleges. These institutions will certainly benefit by adopting the book for their students.

*Electrical Experiments.* By G. E. Bonney. (London: Whittaker and Co.)

"THIS book," the author states, "is written in response to suggestions received from correspondents," and is intended to show how "induction coils and other electrical apparatus" may be used for instructive amusement.

In the two hundred and fifty pages to which the book extends, the writer describes in some detail a number of well known electrical experiments. The experiments described appear to be well chosen, and the instructions given for performing them are fairly accurate, but the theoretical explanations are, in most cases, entirely wrong. The claims of the book to scientific accuracy may be judged of from the following typical extracts, which convey the full meaning of the context. On p. 68 it is stated that "an electric current passing through a wire conductor develops therein a magnetic condition which exerts an influence on the air surrounding the wire, converting it into a magnetic shell," and on p. 203 we find the statement that "the quantity of electricity passing through a resistance of one ohm in one second will liberate 000158 grain of hydrogen." Inaccuracies of this kind are far too serious to pass unnoticed, even in a book intended to provide instructive amusement, and we cannot recommend the seeker after electrical knowledge to trust to the guidance of a work in which they occur. From the publisher's point of view, however, the book is well got up, and will no doubt answer the purpose for which it was written and published.

LETTERS TO THE EDITOR.

[The Editor does not hold himself responsible for opinions expressed by his correspondents. Neither can he undertake to return, or to correspond with the writers of, rejected manuscripts intended for this or any other part of NATURE. No notice is taken of anonymous communications.]

On M. Mercadier's Test of the Relative Validity of the Electrostatic and Electromagnetic Systems of Dimensions.

A SERIES of papers, by M. Mercadier, on the dimensions of physical quantities, has recently been appearing in the *Comptes Rendus*. They are summarised and extended in the *Journal de Physique* (July, 1893, p. 289).

In a note (p. 296) the author states that—"En 1883 nous avons montré, M. Vaschy et moi, séparément d'abord, puis en collaboration, que les deux systèmes [of the dimensions of electrical and magnetic quantities] imaginés par Maxwell étaient contradictoires et que l'un d'eux était inadmissible. Depuis, en particulier MM. Hertz en 1885 (*Wied. Ann.* t. xxiv. 1885) et Rücker (*Phil. Mag.* 5<sup>e</sup> série, t. xxviii, 1889) sans mentionner notre travail, sont arrivés aux mêmes conclusions."

In general it is, I think, wisest to leave such claims to priority alone, but as M. Mercadier's paper has appeared in two important French journals, I should like to make a few remarks on the history of the dimensional formulæ of electrostatic and electromagnetic quantities, which I do the more readily because I have no claims to priority to establish on my own behalf.

Maxwell's theory leads to the conclusion that between electrical, magnetic, and ordinary dynamical quantities there exist relations which are one less in number than the electrical and magnetic unknowns. Hence the dimensions of all the latter can be expressed in terms of length, mass, time, and of the unknown dimensions of any one of them. Maxwell gave two examples of such expressions in which electrical quantity and strength of magnetic pole are the unknowns selected (vol. ii. first ed. p. 241). It is absurd to suppose that he did not know that similar tables could be drawn up in terms of specific inductive capacity (K) and magnetic permeability ( $\mu$ ).

After discussing the general problem, Maxwell expressed the opinion that the "only systems of any scientific value are the electrostatic and electromagnetic systems" (*loc. cit.* p. 241), and proceeded to explain how they are obtained. Unfortunately, in order to emphasise the fact that the fundamental assumption in the electrostatic system is that the specific inductive capacity of the standard medium (air) is taken as unity, he used a notation in which K is represented as without dimensions instead as of unknown dimensions.

It must also, I think, be admitted that this notation conducted to the use of phrases which might very easily mislead. Thus (*loc. cit.* pp. 368-9) he concludes that a quantity  $n$ , which he defines as "the number of electrostatic units in one electromagnetic unit," "is a velocity." Had the symbols K and  $\mu$  been retained, his argument would have led to the conclusion that  $n$  [ $\mu^{-\frac{1}{2}} K^{-\frac{1}{2}}$ ] is a velocity. The matter is not of the first importance, but a notation which requires the statement that the ratio of two like things "is a velocity," makes the subject unnecessarily difficult.

Any doubt to which such expressions might have given rise has, however, been completely set at rest since 1882.

A discussion, initiated by Prof. Clausius, then took place in the *Philosophical Magazine* (5th series, vols. xiii. and xiv.), in which Profs. Everett, J. J. Thomson, Lodge, and Larmor took part. It is only necessary for my present purpose to cite the fact that Prof. Lodge explicitly stated that "the number of fundamental relations must be limited by the number of fundamental experiments, viz. three—Coulomb, Coulomb, and Oersted; and the shortest way of writing the independent relations is this:—

$$[\mu e^2] \equiv [K m^2] = [ML]$$

and

$$[\mu K v^2] \equiv 1.$$

The electrostatic convention makes  $[K] = 1$ ; the electromagnetic convention makes  $[\mu] = 1$ ."

This paper was published in September 1882.

In January 1883 a paper by MM. Mercadier and Vaschy appeared in the *Comptes Rendus*. No reference was made by them to the discussion between English and German physicists,

but up to a certain point they adopted precisely the same line of argument as that with which we were familiar in England.

Taking the formulæ

$$f = k \frac{q q'}{r^2}$$

and

$$f \propto k \frac{ii' ds ds'}{r^2}$$

they had no difficulty in showing that

$$\left[ \frac{k}{k'} \right] = \left[ \frac{L^2}{T^2} \right]$$

It was well known in 1883 that Maxwell's theory requires only two constants, K and  $\mu$ , to define the constitution of the medium, and that

$$[k] = \left[ \frac{1}{K} \right], [k'] = [\mu]$$

(Maxwell, vol. ii. p. 289, equation 24).

Hence from this point of view the equation

$$\left[ \frac{k}{k'} \right] = \left[ \frac{L^2}{T^2} \right]$$

is the same as

$$[\mu K v^2] = 1.$$

Up to this point, therefore, there was nothing in the paper of MM. Mercadier and Vaschy which could not be directly deduced by Maxwell's theory from the explicit statements of Lodge.

After this they proceeded to develop the subject further in an argument which may be summarised as follows:—

The constant  $k$  is inversely proportional to the specific inductive capacity.

Specific inductive capacity is proportional to the square of the index of refraction.

The index of refraction is inversely proportional to the velocity of light in the medium.

Hence  $k = \alpha V^2$ , " $\alpha$  est un constant *numerique*" (the italics are in the original).

Hence, since

$$\left[ \frac{k}{k'} \right] = [V^2] \text{ and } [k] = [V^2],$$

$k'$  is a number "et l'emploi du système électromagnétique d'unités électriques se trouverait justifié *théoriquement*."

The fallacy in this is obvious even if the experimental justification of the step  $k' \propto (\text{refractive index})^2$  be admitted.

Because  $k \propto V^2$  it does not follow that  $[k] = [V^2]$  unless we are sure that all the physical conditions have been included in the equation. Yet Maxwell had given the strongest reason to believe that the magnetic permeability was also involved. He had distinctly pointed out that K would only vary as the square of the refractive index if  $\mu$  were constant (vol. ii. p. 388). In other words, M. Mercadier, arguing from experiments on materials whose magnetic permeabilities differ but little from that of air, treats  $[k] = [V^2]$  or  $[K] = [V^2]$  as an independent equation. He thus assumes that  $k'$  or  $\mu$  is of no dimensions, and then proves the truth of the electromagnetic system which is avowedly based on that assumption. It would be difficult to find a more complete instance of arguing in a circle.

The point, however, is elaborated by experiment and further argument in another paper (*C. R.* t. xcvi. 1883, p. 250).

The conclusion that  $k'$  is a constant is supported by the fact that an induced current is *ceteris paribus* the same, whether the currents are or are not surrounded by non-magnetic materials such as alcohol and benzene.

Again the statement is made—ten years after the publication of Maxwell's book—"D'après les idées universellement admises, les coefficients des formules de magnétisme et d'électromagnétisme seront analogues à  $k'$  par conséquent ils devraient être comme lui indépendants des milieux" (p. 252).

The fact is that, according to Maxwell's theory, one of these coefficients is independent of the medium, while the other two vary, the one inversely as the other, when the medium is changed.

Quite apart then from the question as to whether these factors represented pure numbers or concrete quantities, it was at that date almost universally believed that the values of two of them

depended on the medium. Of course the same view is even more universally held to-day.

All this might, however, have been passed over as an "indiscrétion de jeunesse" if M. Mercadier had not in June last made the extraordinary claim to have proved on such a basis of argument and experiment that the electromagnetic system of units has a theoretical justification which the electrostatic system lacks.

In this recent paper the notation is changed, and  $k'$  is used for  $1/\mu$ . Here again the invariability of this quantity in non-magnetic materials is used as an argument to prove that it does not depend on the nature of the medium.

For the rest M. Mercadier develops certain mixed systems of dimensions, which I need not discuss.

In answer to his complaint that I omitted to notice his memoir in a paper which I wrote on the same subject in 1889, I wish to point out that I did not then enter upon the bibliography of the subject. I regarded myself as dealing with a theory well understood by experts, and as advocating a change in notation chiefly for the benefit of less advanced teachers and students. The considerations advanced were direct deductions from Maxwell's theory. That theory was more generally understood in 1889 than when the discussion in the *Philosophical Magazine* took place in 1882, and since the latter date the practice of retaining  $K$  and  $\mu$  in dimensional formulæ is spreading.

As far, however, as M. Mercadier's papers of 1883 were correct, the ideas they embodied had been explicitly stated in the *Philosophical Magazine* some months before. As far as they went beyond that point, by the attempt to discriminate between the theoretical validity of the electrostatic and electromagnetic systems, the arguments adduced were quite unsound.

ARTHUR W. RÜCKER.

Royal College of Science, South Kensington,  
February 5.

### The Cloudy Condensation of Steam.

MR. AITKEN'S letter (p. 340) shows that he has curiously misunderstood me. I never entertained the smallest "objection to" his "not countenancing the nucleus theory to explain" the action of electricity upon the steam jet. On the contrary I was rejoiced to find that so able and distinguished a physicist appeared to hold the same opinion on this point as myself. In labouring to abbreviate I must have become very obscure. Perhaps my meaning may be made clearer by an amplified and annotated paraphrase of the words in question (see *ante* p. 213).

After trying to show that dense condensation takes place only when there is an actual discharge of electricity, which, however, need not necessarily electrify the jet, I go on: "The inference clearly is that in some way or other the action is brought about by the air in which electrical discharge has taken place, and not directly by the electricity itself. Since so much has been said in the earlier part of the lecture about the influence of dust in promoting condensation the [erroneous] idea has, no doubt, occurred to many of you that in the present case also the air owes its condensing power to the fact that it has become charged with dust. [The great majority of the many scientifically educated people to whom I have at different times shown the experiment at once made this suggestion.] Minute particles are indeed torn off the electrodes by the discharge and [you may think] form nuclei upon which the steam condenses. This [mistaken] hypothesis seems at first sight to be favoured by the experiments of Liveing and Dewar, and by the well-known fact that burning touchpaper induces condensation; it also has the support of Prof. Barus, who appears inclined to think that such condensation is *in all cases* due to the action of small particles of matter. On the other hand, it is noteworthy that Mr. Aitken, who knows more about the condensing property of dust than any man living, gives no countenance to the nucleus theory as explaining the action of electrical discharge upon the steam jet. The possibility of such an explanation must necessarily have presented itself to the mind of one so familiar with the subject, and since he does not make the slightest allusion to it, I imagine that his experiments have led him to the conclusion that it is untenable. This affords me great satisfaction, inasmuch as my own experiments have led me to the same conclusion—not only as regards the action upon the

steam jet of electrical discharge, but also of burning matter." [I did not intend to imply, though the words of the abstract apart from the context unfortunately seem to bear that meaning, that Mr. Aitken thought the action of *burning matter* was not due to nuclei, but that I myself thought it was not.] Then follows an account of experiments tending to show that the air does not derive its power of condensing the steam jet from dust but from dissociated atoms.

The above will, I hope, convince Mr. Aitken that, except perhaps as regards one slipshod sentence, which I regret having overlooked when correcting the proof, he has no cause to feel aggrieved. I am confident that my hearers never for a moment understood me to say that he had abandoned one iota of his conclusions regarding the action of dust, but merely that he did not consider the dust-nucleus theory applicable to the case of the electrified steam jet.

I believe that I am well acquainted with all Mr. Aitken's papers on the subject of condensation, but I do not remember the experiment with the polished ball referred to in his letter. Perhaps it is an unpublished one. The experiments which he mentions in his final paragraph, relating to the condensation caused by certain acids, were made upon water-laden air contained in closed vessels, and not upon the steam jet. The conditions in the two cases are very different, so much so that, for example, hydrochloric acid, which in the steam jet is the most active source of dense condensation that I have met with, was found by Mr. Aitken (he will pardon me for reminding him) to form no foggy condensation at all in a receiver of moist filtered air; while ordinary dusty air, which exerts such a powerful action in the closed vessel, fails to produce any sensible effect when introduced into the open steam jet.

SHELFORD BIDWELL.

Southfields, Wandsworth, February 11.

### On the Cardinal Points of the Tusayan Villagers.

IN the second volume of the *Journal of American Ethnology and Archaeology* I have pointed out, for the first time, that the four cardinal points among the Tusayan villagers are not the same as those of the astronomers, or that their north is approximately north-west. I also gave, in the same article, tables with the amount of the angular variations, showing that the sacred rooms, or kivas, where the mysteries of their ceremonial worship are performed, are oriented, roughly speaking, in accordance with their conception of the positions of north, west, south and east. It was shown that the amount of angular variation was constant, and later, in a description of the ruins of A-na-to-bi, the same orientation was made known.

In an article published in the December number of the *Journal of American Folk Lore*, it was stated by me that the cardinal points among these aborigines are determined by the solstitial risings and settings of the sun.

The publication of Prof. J. Norman Lockyer's work on "The Dawn of Astronomy," in which the orientation of certain of the sun-temples in the Nile valley and elsewhere in the old world is referred to solstitial points in the horizon, gives a new interest to these observations among the aboriginal house-builders and their descendants in America.

Since the publication (1892) of my observations on the orientation of Tusayan (Moki) kivas and its relationship to solstitial points of sunrise and sunset, I have examined the scanty data which we have regarding the orientation of temples in Central American ruins, and have unearthed significant facts bearing on this question, as well as that of the kinship of the Pueblo people and those who once inhabited the "cities" of Mexico, including Yucatan. Evidences of relationship between the aboriginal house-builders of Arizona and New Mexico, and those of Nahuatl and Maya stocks have elsewhere been presented. It seems to me that the above observations made in 1891, quite independently of the discoveries of Lockyer on the orientation of temples in the old world, in the light of his discussion, open a field of research in the archaeology of the house-builders of Central America which is sure to lead to interesting discoveries.

Boston, Mass., U.S.A.

J. WALTER FEWKES.

### The Scandinavian Ice-sheet.

MANY geologists affirm that the Scandinavian ice-sheet became confluent with that of Scotland, and reached the East



Anglian coasts. Perhaps some of your readers could inform me whether the following difficulty, which has occurred to me, has been already raised, or has received a satisfactory answer. A submarine channel, some 400 fathoms deep, sweeps round the southern coast of Norway from the Cattegat to about the 62nd parallel of latitude, whence it gradually opens out into the deeper water further north. If the 100 fathom line of soundings were to become the coast margin of north-western Europe, this channel would form a fjord, considerably broader than the straits of Dover, and for the most part 1800 feet deep. A further general upheaval, amounting in all to some 2500 feet, would convert this fjord into a wide valley, sloping gently towards the north, which was bounded on one side by the Scandinavian mountains (then commonly rising to a height of about 5000 to 9000 feet); on the other by a nearly level plateau (with a yet slighter slope, but in the main northward), elevated generally some 2000 feet above the bed of the valley. In such cases, if any trust can be placed on the evidence afforded by Greenland at the present day, the drainage of Scandinavia would obey the law of gravitation, even when in the form of ice, and would be diverted down the fjord or valley towards the northern Atlantic.

T. G. BONNEY.

### The Nomenclature of Radiant Energy.

REFERRING to Prof. Simon Newcomb's letter in your issue of November 30 last (p. 100), suggesting a nomenclature for radiant energy—if no one else has already pointed it out, I would suggest that the word *irradiate* might be used in place of *illuminate*. It would be just as expressive, and would have the advantage of consistency; and its use would leave the word "illuminate" to its proper sphere.

A. N. PEARSON.

Melbourne, January 9.

### THE FOUNDATIONS OF DYNAMICS.

IT is rather curious that at the present time, when applied dynamics embraces so wide a range, so much attention should be directed to its foundations. One would have thought that the basis of a department of science which is used and used successfully in the investigation of the motion of vortex rings in a fluid, and the propagation of waves of electromagnetic disturbance, had been fully understood, and that no doubt of the firmness of the logical structure on which so huge a weight is laid, was entertained by those who are most active in turning it to practical account. If, as some appear to believe, our dynamical methods are founded on a vicious circle, how is it that the same men have been so successful in applying them to the elucidation of physical phenomena? Surely the repeated attempt to do this ought only to have led, if not to confusion of contradictory results, to continual failure to obtain any explanation at all.

On the other hand the extended use of dynamics has led scientific men themselves to a more general familiarity with dynamical processes. The study of dynamics is now a recognised part of scientific education, and the exigencies of teaching the subject have rendered necessary a much more complete examination of its fundamental assumptions than was usual before, when a few gifted mathematicians, by the force of their own genius, were led, almost "by a way they knew not," to the glorious results of physical astronomy. Again the recognition, more or less clear, that the old action-at-a-distance theories are really mathematical shortcuts, each gathering up into a single formula the result of the physical actions on molar matter of a medium in which it is immersed, has directed attention to the ether, and raised many questions of extreme interest as to the localisation of energy, and the conditions of its transference from place to place. Though a whole race of subtleties has with the new views sprung into being to mock our attempts to find firm footing, we are forced to the conviction that in this action of a medium lies the best means of scientific progress at the present time. As a consequence we are led to the re-

consideration of the theory of energy, and therefore also of the conceptions of force, &c., and discussions as to the foundations of dynamics have been revived and carried on with a keener interest.

No one has worked with more zeal at the task of restating the doctrine of energy on anti-action-at-a-distance principles than Dr. Oliver Lodge, and it happens that recently his views have again been brought to the front by an address on the Fundamental Hypotheses of Dynamics delivered in 1892 by Prof. J. G. MacGregor before the Royal Society of Canada, and an article by the same author in the *Philosophical Magazine* for February 1893. An instructive paper has been presented by Dr. Lodge to the Physical Society, in which he has re-stated and defended his position. The discussion which took place on that paper, and the divergence of opinion then manifested, showed how wide is the interest in this subject, and how far it is still from being completely settled.<sup>1</sup>

The chief points in Dr. Lodge's papers are his insistence upon contact action as the cause of all action between bodies, and his re-statement of the principle of the conservation of energy. Only incidentally and as a preliminary, in his last paper at least, are the laws of motion touched upon. On the other hand, the chief burden of Dr. MacGregor's address is the laws of motion, and an attempt so to formulate them so as to give a logical basis for the science of dynamics in its application to physics. In his *Phil. Mag.* paper, however, he deals with Dr. Lodge's views with respect to energy.

I do not propose to restate the positions of the parties to the present controversy, but to endeavour to say how the question appears to an outsider who has felt keenly the difficulty of teaching the elementary principles of dynamics without introducing confusion by unnecessarily obtruding the fundamental *cruxes* of the subject; or, on the other hand, slurring over matters of really vital importance.

In the first place, it seems to me that there is in general no sufficiently clear recognition of the fact that abstract dynamics is really abstract, and depends upon certain ideal conceptions just as much as does geometry, and that its application to practical problems must be made on certain assumptions, axiomatic in the proper sense or not, which must be justified by the results of experience. Abstract dynamics is a purely ideal science, geometric in a somewhat extended sense, caused by the introduction of certain notions not ordinarily employed in purely geometrical processes. So long as we confine ourselves to the ideal as we do in geometry, there are about it only difficulties of the same kind as we have in geometrical conceptions, and these I do not here propose to discuss. It is only when we apply the science to the interpretation of nature that we meet with the difficulties that every one must admit do exist, and which there is no blinking if we want to be straightforward, as to absolute direction, uniform motion, &c.

In this application we take some standard for the measurement of time. In this we are guided by the idea derived from the first law of motion, that any body in relative motion, which there is reason to conclude is not changed by the action of other bodies, may be taken as timekeeper. In practice we have recourse to a joint result of this idea and the equality of action and reaction, and take as our standard the rotation of the earth on its axis. [Of course this standard may not agree with some other and preferable standard means of time reckoning, but this will not affect the argument.]

In abstract dynamics we can and do imagine a system of axes of reference of some kind or other, but quite ideal so far, and agree upon or assume the existence of some mode of measuring intervals of time. We then consider the velocities and accelerations of different particles rela-

<sup>1</sup> A rejoinder to this paper appeared in the September number of the *Philosophical Magazine*.

tively to those axes. We suppose different particles to have any accelerations relative to those axes which may be assigned, or which are deducible from data given, and so from the configuration at any given epoch that at any other, that is, to speak shortly, the motion, can be found. If the particles do not change their configuration relatively to one another a limitation is imposed on the motion, the particles constitute a rigid body. Thus we may consider any conceivable cases, and the science which deals with them is one of pure kinematics.

Now we may suppose our reference system, which we may call A, to have a motion relatively to some other reference system B, and the motion of the particles considered if referred to that other system will be compounded, for any instant, of the motion which the particles would have with respect to B, if they were rigidly connected with A, in the positions they have at that instant, and of the motions which the particles then have with respect to A. There is no difficulty, if the motion of A with respect to B is specified, in determining the former part of the motion of each particle. It will vary, of course, with the changing positions of the particles in consequence of their motions with respect to A.

Similarly we can push the reference still further back, and so from reference system to reference system whenever we find it desirable to do so. Of course we should never by any such process as this reach axes absolutely fixed; but it is the process by which we introduce corrections suggested by experience, as explained below.

It is, then, a result of observation that we can stop at some reference system, it may be the first A, which is suggested to us by the circumstances of the case. To a certain extent we can consider the effect of referring our chosen reference system to other reference systems naturally suggested, and be sure that the additional motions necessary for the parts of our system are negligible.

In practice we generally make the supposition that we may refer to a naturally suggested system of reference and find in what manner the results deduced require correction. For example, we refer the motion of a projectile to axes fixed in the earth, say one vertically upwards, and two others, one north the other west, and consider the motion. We find that the results only approximately coincide with experience, and we have to correct them on account of the earth's rotation. It may be that there are other corrections which on account of their smallness relatively to unavoidable errors of observation we can take no account of.

So far we have made no mention of mass or inertia. This idea is derived from experience of physical phenomena.

If we wish to apply our ideal science to the investigation of physical relations from experimental or observational data, we can only do so on certain assumptions tacitly or explicitly made, and these are to be regarded as postulates to be justified by the consistency and accuracy of our results when tested in their turn by observation. The term axiom, it may be remarked, seems inapplicable to many of these unproved assumptions, inasmuch as though they are simple concise statements, neither their truth nor their falsehood commends itself at once to the mind.

Now, with reference to our naturally chosen system of axes, we find that different bodies have, in the same circumstances, different accelerations, and hence we get the idea of the masses of bodies. In estimating similarity of circumstances we assume the constancy of the physical properties of materials, such as constancy of the quantity of matter in a body, the elastic properties of a spring, and the like. Thus, if we take a given spiral spring and apply it repeatedly to the same body with the same stretch, we find the same acceleration given to the body each time. Of course this result might be pro-

duced by a *pari passu* variation of the mass of the body, and the properties of the spring, but since we find the results consistent with those obtained with different masses and springs, the possibility of such variations need not be discussed. To this ideal method of comparing masses, the ordinary method by weighing is shown to be equivalent by Galileo's experiment with the falling bodies, Newton's pendulum experiment, &c.

Thus applying *similar circumstances* (which we may typify by a spring with a given stretch) to different bodies, we find their accelerations different, and we are led to a comparison of their masses, and thence to a prediction of the accelerations which in different circumstances will be produced in the same mass or in different masses, that is to the comparison of rates of change of momentum or of force. For example, suppose a spring with a given stretch in it to be applied for a second to each of a number of masses, and let the accelerations produced be  $a_1, a_2, a_3, \&c.$  Then if we take quantities inversely proportional to  $a_1, a_2, a_3, \&c.$ , say  $\mu a_1, \mu a_2, \mu a_3, \&c.$ , and multiply each of these by the accelerations produced, we obtain, of course, the same product  $\mu$  in each case, and we take this as a measure of the stress in the spring regarded as the producer of motion in bodies. In the ordinary system of measuring forces we take  $\mu$  as  $ma$ , where  $m$  is the mass of the body reckoned in terms of a chosen unit of mass. This gives the dynamical method of comparing the masses of bodies. The masses of the bodies here considered are  $\mu a_1, \mu/a_2, \&c.$

On the other hand, when we have to compare the motion-producing powers of springs having different stretches, that is, the forces they exert, we may use the same system of bodies if we please (or any system of which the masses have been compared as just described), and suppose that accelerations  $a'_1, a'_2, a'_3, \&c.$  are produced by different springs applied to the bodies. Thus applying the method of reckoning explained above, we are led to measure the forces exerted by the springs by the products  $\mu a'_1, \mu a'_2, \&c.$

Thus from the point of view here adopted, Newton's second law sets up this mode of comparing masses and forces, and thereby furnishes a perfectly simple and consistent method of writing in a form ready for solution the equations of motion of a body relatively to any system of axes which we know from experience we may regard as at rest.

Here I wish to remark that when we write such equations as

$$m\ddot{x} = X, \quad m\ddot{y} = Y, \quad m\ddot{z} = Z,$$

the quantities on the right, commonly called the applied forces on the particle of mass  $m$ , are, it seems to me, merely put provisionally for values of the quantities on the left, which from the given circumstances of the motion, that is from the relations and data given, we may be able to calculate, or to supply from the results of experiment or observation. There is not any necessity for considering them as the *causes* or the measures of the causes of the accelerations  $\ddot{x}, \ddot{y}, \ddot{z}$ , of the particle.

The idea of force as cause of acceleration is useful as enabling us to speak and write with brevity about dynamical problems, and so to arrive quickly at the necessary equations. For example, take the problem of the motion of a particle of mass  $m$  hung by a massless spiral spring which the weight of the particle stretches by a length  $s$ . Then we know (1) that the stretch of the spring if not counteracted by the weight  $mg$  of the particle would cause the particle to receive an upward acceleration  $g$ , and since experiment shows that different weights stretch the spring by amounts proportional to them, we infer (2) that when the spring is stretched by an amount  $s + x$ , the elastic reaction would produce an acceleration  $g(s + x)/s$ . Hence an upward acceleration of amount

$gx/s$  will be produced, and if  $x$  represent downward acceleration, we get the equation of motion :—

$$m\ddot{x} = - mg - \frac{x}{s}$$

which is ready for solution, and gives the well-known result.

We greatly abbreviate the above statements by saying that the upward "force" exerted by the spring in the first case is  $mg$ , and in the second, from the experimental result,  $mg(s+x)/s$ . This gives at once  $-mgx/s$  as the downward force on the particle, which being substituted for  $X$  in the formal equation of motion,  $m\ddot{x} = X$ , puts the latter into a form adapted for solution.

Thus, though we may use, and do use constantly, the language of cause and effect in this connection, it ought to be remembered that when matters have been reduced to the solution of a dynamical problem, we have a purely mathematical process to carry out, by which we render explicit only that which is already implicitly involved in our equations.

This does not exclude or do away with the consideration of stresses as physical realities, it only states what I believe is substantially involved in the application of dynamics to physical problems. The objectivity, in the metaphysical sense, of force does not concern us, and discussions regarding it are, so far at least as physical results are concerned, not likely to be profitable.

I have heard it said by more than one very competent judge, that there is a certain vicious circle at the foundation of dynamics which there is no avoiding. We define force by mass, and mass by force. Thus it is sometimes said in effect, "Equal forces are those which produce equal accelerations in equal masses—equal masses those in which equal accelerations are produced by equal forces." But, as shown above, if we can assume constancy of mass of a body, and of the physical properties—say of a spiral spring—there is no difficulty in getting out of this circle of definition. These are assumptions we are entitled to make as the result of experience.

It is to be observed that since the measure of force in Newton's second law, namely,  $m\ddot{x}$ , is relative, the forces considered must be also relative. This is noticed by Prof. MacGregor in his address (p. 4), but he states that as our idea of force is derived from sensation, force in this sense is not relative. "According to this conception a body either is, or is not, acted upon by force." It is possible that I have failed to follow Dr. MacGregor here, but it seems to me that he has confounded *real* with *absolute*. Our muscular sense certainly tells us that a force, that is a stress as distinguished from a mass-acceleration, exists, but in no case can it inform us as to what in any absolute sense are the forces acting on the body considered. The force we feel "does not depend upon our point of view," but the force we regard as acting on the body certainly does. An acceleration which we observe is also a perfectly real thing in itself, but the acceleration of the particle is altogether dependent for its value on the point of view from which we regard it.

The ordinary misunderstanding that continually crops up with respect to the equality of action and reaction is feelingly alluded to by Dr. Lodge in his paper, and perhaps as a sympathiser I may be pardoned for devoting a paragraph or two to its consideration. A recent discussion of precisely the same thing in another journal has made it clear that the difficulty felt by the beginner in this matter is not clearly appreciated by many who endeavour to remove it. Because action and reaction are equal and opposite in the case (to take Newton's illustration) of a horse pulling a stone, the student (and the would-be critic of dynamical processes!) imagines

that neither the horse nor the stone can get into motion. Now the confusion arises from regarding the action which is a forward force on the stone as being cancelled by the (if for a moment we neglect the mass of the rope or chain between the two bodies) equal and opposite force which acts, and this is what is overlooked, *not upon the stone, but upon the horse*, and therefore cannot affect the motion of the stone.

There may be other forces acting on the stone, and others again acting on the horse, and the motion of each body is changed *by the forces acting on that body, and those forces alone*. Thus there are two groups of forces, one group acting on the stone, and the other on the horse, and all that is asserted in the law of equality of action and reaction, as applied in this illustration, is that that particular force of the first group, which is the force exerted on the stone by the horse, is equal to that force of the second group which is the force exerted on the horse by the stone.

Action and reaction, however, are, I believe, most properly regarded as applied at the same place, though not to the same thing. Across any cross-section of the rope in Newton's illustration a stress acts, one aspect of which is a forward force on the part of the cord immediately behind the cross-section, the other a backward force on the part of the cord just in front of the cross-section. An excellent example is the action and reaction between two links of a chain, which are exerted across the surface of contact between the links, the action being a force on one link, the reaction a force on the other link. Here, as in all other cases, the action and reaction do not cancel one another, simply because they are applied to what are here regarded as entirely different things. [Of course, if we are considering the motion which a system consisting of different parts may have *as a whole*, the actions and reactions between these parts do cancel one another.]

I agree with Dr. Lodge in believing that in a certain sense we have nothing but contact action, that is, that all radiation phenomena are propagated by contact between portions of matter (not necessarily ultimately discrete portions) filling space. Thus at every place where such propagation is going on, and consequently changes of the motions of bodies are taking place, stresses are set up, and just where we have one aspect of a stress we have its other aspect.

This view, if it is adopted, certainly seems to lead to the conclusion that a process of transformation accompanies transference of energy; but it is not, so far as I can see, inconsistent with, and does not render in any way untenable, the doctrine of conservation of energy as ordinarily stated.

The doctrine that all energy is kinetic in reality, and that transformation consists in a passage of the energy from being kinetic energy of the bodies whose velocities can be observed and measured to being kinetic energy of those parts of the system regarding which we cannot have such knowledge, or *vice versa*, when it is more familiar, and more clearly understood in the light of further scientific progress, may possibly help to clear away some of the many difficulties which crowd round this subject.

This article is long enough, and we must defer to some other opportunity any further consideration of Dr. Lodge's theory of the transference of energy. But both he and Dr. MacGregor have done good service in discussing from their several points of view this very difficult but apparently for many minds exceedingly fascinating subject. Nothing but good can come of "a revision of the standards" in dynamics, provided it has no destructive object in view, but only the improvement and, if necessary, correction of the methods of presenting and teaching the science.

A. GRAY.

AN INCIDENT IN THE CHOLERA EPIDEMIC  
AT ALTONA.

THE third contribution by Dr. Koch last year to the subject of cholera appears in the *Zeitschrift für Hygiene*, vol. xv. part 1. It covers no less than seventy-six pages, and is entitled "Die Cholera in Deutschland während des Winters 1892 bis 1893." As the title implies, it is an elaborate essay giving a most lucid and remarkably interesting exposition of the rise and course pursued by the several epidemics of cholera which visited Hamburg, Altona, and Nietleben near Halle, respectively. Several figures serve to illustrate the descriptions of sites, buildings, &c., referred to in the text.

From a bacteriological point of view, perhaps the most interesting part of the paper is that which relates to the disease in Altona, and in which an account is given of the successful elucidation of a remarkable outburst of cholera which occurred in a restricted area of that town, and which in many respects recalls the incidents of the now classical cholera explosion which took place in 1854 in connection with the Broad-street pump in London.

In a district of Altona, rejoicing in the suggestive name of "der lange Jammer," and inhabited by about 270 persons, cholera made its appearance on January 21, 1893, and in a week nine cases had occurred, of which seven ended fatally. Strange to say, in the neighbourhood and, indeed, for some distance around this centre, no other cases of cholera were recorded at all, thus pointing very clearly to some local cause as responsible for the outbreak. A searching investigation was at once instituted, resulting in the discovery that the infected houses were not connected with the Altona water-supply, but dependent for their water upon a well in their midst. The ordinary town water-supply was in fact regarded as an article of luxury and an extravagance which the humble inhabitants of "der lange Jammer" were too poor to indulge in. In May, 1892, a systematic investigation had, it appears, been made of all the wells in Altona, and ninety-two out of 366 had been condemned as unfit for use. This particular well was, however, amongst those which had been passed, as its construction appeared to be satisfactory, and its surroundings sufficiently protected to remove all fear of contamination. During the severe frost, however, there can be no doubt that surface water, unable to get away by the usual channels, gained access to the well, for when the courts of the surrounding houses were washed down with strong carbolic it was noticed that the well-water acquired a smell of this material. Thus the possibility of its contamination with choleraic matters was established, and on January 26 the well was closed. After this date only four more cases of cholera occurred, the last one recorded being on February 1, and all of these might have been contracted prior to the closing of the well, and are therefore still attributable to the use of this water.

The bacteriological examination of the water was taken in hand on January 31, and on this day large numbers of cholera bacilli were revealed by the usual special methods employed. A sample of the water collected on January 31 was preserved for further investigation, and was kept in a room having a temperature of 3-5° C.: in this sample cholera bacilli were found on the 2nd, 3rd, and 17th February respectively, showing that under the particular circumstances the bacilli were able to maintain their vitality for eighteen days in the water; on the other hand, in samples of water collected later directly from the well itself no cholera bacteria could be detected. It is to be presumed, therefore, that as no further cases of cholera occurred in the adjacent houses after February 1, no fresh bacilli found their way into the well, and those cholera bacilli which were proved to be present on January 31, must

have either become altogether extinct or have been so much reduced in number as to defy detection.

The incident is instructive, if only in demonstrating the folly of presuming that a well with flagrantly unsanitary environment may be regarded as safe for drinking purposes, just because its past history happens to be untarnished by any observed connection with an outbreak of zymotic disease. But another point which I consider is very clearly brought out by the case in question, is the uncertainty which attaches to the actual discovery of the cholera or, indeed, of other pathogenic bacteria in water, even under such peculiarly favourable conditions as were present in the case of the Altona well. Had the examination of this water been delayed only for a few days, the search for cholera bacilli would have been absolutely fruitless, and the direct bacteriological evidence entirely wanting. Chance, in this particular instance, decided otherwise, and a very satisfactory confirmation of a most probable hypothesis was obtained.

Nevertheless, it is very apparent that however important bacteriological evidence may be in determining the hygienic value of water purification processes, and as I have so often pointed out, it is in this matter the only competent referee; on the other hand, in the matter of the actual detection of disease organisms in any given water, its usefulness is of a much more restricted character.

There is undoubtedly a tendency at the present time to regard the detection of pathogenic bacteria as the most important object of bacteriological water examination. It is, however, surely a matter of far greater moment to anticipate and be forearmed against evil by ascertaining whether the principal conditions, such as purity of source, efficiency of subsidence, filtration, &c. attaching to a given water-supply are such as to reduce to a minimum the danger of its disseminating zymotic disease, than to wait for the actual discovery of pathogenic bacteria, and only then to be led to see the necessity of, as it were, locking the stable-door after the horse has been stolen!

The failure to discover the typhoid bacillus in the Worthing water-supply is another instance in point, and in the majority of cases the task of tracing the connection between an outbreak of disease and an infected water-supply must obviously still be performed without the direct support of the bacteriological detection of the zymotic poison.

PERCY FRANKLAND.

NOTES.

THE foundation of the Bakerian Lecture, to be delivered to-day at the Royal Society by Prof. Thorpe, F.R.S., and Mr. J. W. Rodger, although not so ancient as that of the Croonian, is yet of respectable antiquity. Established during the presidency of Sir John Pringle, the predecessor of Sir Joseph Banks, it has its origin in the bequest, in 1774, by Henry Baker, antiquary, naturalist, and Fellow of the Society, of the sum of one hundred pounds, the interest of which is directed to be applied for an oration, or discourse, to be spoken or read yearly by a Fellow on some subject in natural history or experimental philosophy. The forfeiture of the bequest is contingent on the lecture failing to be delivered in any one year. The founder of this lecture was himself a man of considerable parts, and, besides being the author of numerous memoirs in the *Philosophical Transactions* published two treatises on the microscope, and some poetical works. He was elected into the Royal Society in 1740, and in 1744 was awarded the Copley medal. He married the youngest daughter of Daniel De Foe. The first lecture under the bequest was given in 1775 by Mr. Peter Woulfe, the subject being "Experiments made in order to ascertain the nature of some

mineral substances, and in particular to see how far the acids of sea-salt and of vitriol contribute to mineralise metallic and other substances."

IT is now arranged that the Croonian Lecture of the Royal Society will be delivered by Prof. Ramon y Cajal, on Thursday, March 8; not March 1, as announced in our issue of December 21.

WE understand that the U.S. Bureau of Weights and Measures has recently decided to use the metre and kilogram as fundamental standards, and, from the fifth day of next April, to consider the yard and pound as derivatives from the metrical standards. This decision practically means the adoption of the metrical system by the United States.

IT has been decided to hold the autumn meeting of the Iron and Steel Institute at Brussels, from September 2 to 7.

M. L. GUIGNARD has been elected president of the Botanical Society of France for the present year.

M. AIMÉ GIRARD has been elected a member of the Rural Economy section of the Paris Academy of Sciences, in succession to the late M. Chambrelent.

M. ALBOFF, who has been collecting for the past six months in the Caucasian Alps, for the Boissier Herbarium, has returned with large collections.

A BOTANICAL garden has been established in the mountains near Grenoble, at an altitude of 1875 m., under the direction of Prof. P. Lachmann.

DR. E. BARONI, of Florence, is preparing a monograph of the genus *Atriplex*, and would be obliged by specimens or memoirs from any botanists who have worked at the genus.

THE *Journal of St. Petersburg* states that the Russian Technical Society has decided on the organisation at St. Petersburg of an exhibition of gold ores and of precious metals and stones.

THE Council of the Sanitary Institute have accepted an invitation, received from the Lord Mayor and citizens of Liverpool, to hold their next congress and exhibition in that city in the autumn of this year.

MR. WILLIAM GARTON, of Woolston, Southampton, has presented a sum of five hundred pounds to the Council of the Hartley Institution towards the cost of the new engineering laboratory, which is about to be added to that institution.

THE fine engineering laboratory belonging to the Purdue University, Lafayette, Indiana, and which has cost some £35,000 to build and equip, has been completely destroyed by fire. The building was only completed on January 19 last, and was burnt four days afterwards.

WE learn from the *North British Agriculturist* that the Lancashire County Council have decided to take over a farm at Penwortham, at an annual rental of £400, on a lease terminable at five, ten, or fifteen years, for the purposes of agricultural experiment and instruction.

SIR H. TRUEMAN WOOD has been elected president of the Photographic Society of Great Britain.

THE 1894 Camera Club Photographic Conference will be held in the theatre of the Society of Arts, on Monday and Tuesday, April 23 and 24, under the presidency of Capt. W. de W. Abney. The members' annual exhibition of photographs will be commenced at the club on the first day of the conference.

ACCORDING to the *British Medical Journal*, the Hungarian Government has established a bacteriological institute at Buda-Pesth for the purpose of giving facilities for the study of infectious diseases from the scientific point of view; for the employment of bacteriological methods for the combating of such diseases; for general bacteriological researches; and for supplying information on bacteriological questions to public authorities and private inquirers.

AN interesting experiment, that of the cultivation of tea, is shortly to be tried in Russia (says the *Board of Trade Journal*). The Czar, under the guidance of experts, has given his consent to a proposal for the cultivation of this plant in the western limits of the Caucasus, where the temperature is much the same as that under which the plant grows in China.

THE death is announced of Prof. E. Weyr, at the age of forty-six. He was known especially for his contributions to modern geometry.

THE *Athenæum* announces the death of Prof. J. von Dümichen, the Egyptologist, at Strasburg, on February 7. He was born in 1833 at Weissholz, in Silesia, and pursued his Egyptological studies under Lepsius and Brugsch. In 1862 he made his first journey into Egypt, Nubia, and the Soudan, returning in 1865. At the foundation of the German University in Alsace, Dümichen was nominated to the chair of Egyptology. In 1875-76 he spent a great time in Egypt in order to complete the researches begun during his earlier journeys. He was the author of numerous works on the geography, inscriptions, architecture, and history of ancient Egypt.

THE anniversary meeting of the Geological Society was held at Burlington House, on Friday, February 16, when the medals and funds were awarded as follows:—The Wollaston Medal to Geheimrath Professor K. A. von Zittel; the Murchison Medal to Mr. W. T. Aveline; the Lyell Medal to Prof. J. Milne, F.R.S.; the balance of the proceeds of the Wollaston Fund to Mr. A. Strahan; that of the Murchison Fund to Mr. G. Barrow; that of the Lyell Fund to Mr. W. Hill; and a portion of the proceeds of the Barlow-Jameson Fund to Mr. C. Davison. The following is a list of the officers and council elected at the meeting for the ensuing year:—President: H. Woodward, F.R.S. Vice-Presidents: Prof. A. H. Green, F.R.S., Dr. G. J. Hinde, Prof. J. W. Judd, F.R.S., R. Lydekker. Secretaries: J. E. Marr, F.R.S., J. J. H. Teall, F.R.S. Foreign Secretary: J. W. Hulke, F.R.S. Treasurer: Prof. T. Wiltshire. Council: H. Bauerman, Dr. W. T. Blanford, F.R.S., Sir John Evans, F.R.S., Prof. A. H. Green, F.R.S., Dr. J. W. Gregory, Alfred Harker, Dr. G. J. Hinde, T. V. Holmes, W. H. Hudleston, F.R.S., J. W. Hulke, F.R.S., Prof. J. W. Judd, F.R.S., Prof. C. Lapworth, F.R.S., R. Lydekker, Lieut.-General C. A. McMahon, J. E. Marr, F.R.S., H. W. Monckton, Clement Reid, F. Rutley, J. J. H. Teall, F.R.S., Prof. T. Wiltshire, Rev. H. H. Winwood, Dr. H. Woodward, F.R.S., H. B. Woodward.

ON Saturday, February 24, at four o'clock, a meeting will be held in Queen Elizabeth's Lodge, Chingford, Epping Forest, in support of a proposed Epping Forest free local museum. For many years the idea of a museum to illustrate the natural history, history, archæology, &c. of the forest has been in the minds of residents of the district, and the Queen Elizabeth's Lodge seems to be admirably suited to contain a collection of the kind indicated. The Council of the Essex Field Club have expressed their willingness to undertake the gathering together of specimens, and the curatorship and scientific superintendence of the collections, as a branch of their central museum at Chelmsford. The specimens and exhibits which it is proposed to place in the museum would include

such as the following:—(a) Specimens of the natural history and geology of the forest district—the quadrupeds, birds, fishes, reptiles, insects, trees, wild flowers, fungi, fossils, &c. (b) Instructive preparations to illustrate the variety of form colour, structure, habits, transformations, and development, &c., of the above, with examples of galls and other plant disease and injuries. (c) The antiquities of the forest districts; illustrations of the camps, and other earthworks; prehistoric implements and other remains, &c. (d) Plans, maps, photographs, pictures, models, &c. relating to the district; illustrations of the history of the forest, and its scenic beauties; the architectural and archaeological features of the district, &c. (e) A small collection of books—guides, histories, manuals of natural history, &c.—useful to those wishing to learn something about the district before taking rambles therein. A local museum of the kind proposed would be a source of interest and utility to all lovers of nature, and might be made of considerable educational value.

IN the early part of this week a very severe frost set in over the midland, eastern, and southern parts of England, accompanied by piercing easterly winds; the night minima in the shade fell to  $16^{\circ}$  at Loughborough, and to about  $25^{\circ}$  at Shields; while in London the temperature on the grass was as low as  $14^{\circ}$ , and fog occurred over the inland parts of England. These conditions were due to an area of high atmospheric pressure which lay over Denmark, the Netherlands, and south of Scandinavia, where the barometer readings were as high as  $30.6$  inches, with lower readings further south. But our extreme north and west coasts were under the influence of low pressure areas, and a south-westerly gale was blowing at Stornoway on Monday evening; consequently the temperature in these parts was higher.

IN Dr. Wild's *Annalen des Physikalischen Central Observatoriums* for 1892, just received, it is recorded that at Werschojansk, Lat.  $67^{\circ} 34' N.$ , Long.  $133^{\circ} 51' E.$ , the temperature fell in February to  $-69.8$  C. or  $-94.6$  F. This is absolutely the lowest temperature of the air hitherto observed anywhere on the surface of the earth.

IN *Ciel et Terre* of the 1st inst. M. A. Lancaster contributes an interesting paper "On the commencement and end of winter," as determined by the first and last occurrence of snow and frost at Brussels. He gives tables showing these dates for sixty-one years, from 1832-3 to 1893-4 (the data for the first and last of these years being incomplete). On an average, the first frost occurs about November 10, and the first snow about five days later, while the first frost of much intensity (below  $20^{\circ} F.$ ) occurs about six weeks afterwards. At times these phenomena occur much earlier or later; the first frost occurred in 1864-5 and in 1881-2 on October 5, while in 1877-8 no frost occurred until December 10. The last frost occurs, on an average, about April 4; in 1885-6 there was a frost as late as May 1, while in 1835-6 the thermometer did not fall below  $32^{\circ}$  after February 24. The fall of snow is much more irregular; it fell seventeen times in May, and once in June (in the year 1866). A paper of a similar nature was published for Sweden in 1880, by M. Hildebrandsson.

THE practice of spraying fruits with certain mineral compounds, such as salts of copper and arsenic, to destroy insects and fungi, has called out discussion in regard to the ripened fruit after such spraying, and its fitness for food. The first condition for intelligent discussion of any subject is to know the facts in the case, so experiments have been made on the matter at the State Agriculture College, Michigan, and *Bulletin* No. 101 contains the results. In these experiments, extending over two years, the minerals used in spraying the fruits were found in appreciable quantities in every instance, though the amount was small in all

cases except when the spraying had been purposely excessive. The question naturally arises whether the sprayed salts merely adhere to the surface or penetrate the substance of the fruit. Experiments made to test this showed that while most of the copper salts, in the case of a solution containing copper sulphate, adhered to the surface of pears sprayed with the solution, a portion found its way into the body of the fruit. Dr R. C. Kedzie, who has made the analyses, remarks that the use of poisons in horticulture is largely in excess of the amount required for a fungicide. One-half or even one-third of the amount usually employed would probably give as good results. To be on the safe side, no fruits should be sprayed with solutions of mineral salts during the period of ripening, for though the amount found in a single pound of fruit may be very small, repeated doses of the poison might produce slow poisoning.

THE new theory of light-sensation devised by Christine L. Franklin, and intended to avoid the difficulties involved in the acceptance of the two chief theories in the field at present, known as Helmholtz's and Hering's theory respectively, is expounded in the last two numbers of *Mind*. While the Young-Helmholtz theory supposes that the judgment picks out of a mixture of colours all the even red-green-blue sensations, and deceives itself into thinking them to be a new sensation called white, the new theory assumes an independent retinal process as ground for the latter sensation, therein agreeing with Hering's theory. But while Hering supposes that some parts of the spectrum produce construction, and others destruction of the tissue of the retina, Miss Franklin considers that the sensations of the black-grey-white series must be regarded as the fundamental ones, and attributed to the dissociation of certain molecules, which she provisionally calls the grey molecules. The atoms thus dissociated have different periods of vibration, and in the more highly developed visual organs—those capable of colour-sensations—these colour-atoms differ in behaviour according to the wave-length of the light beating upon them. Thus some atoms would only be torn off by red light, and would give rise to the sensation of red. The prevalence of such colour molecules would coincide with the predominance of the structures known as cones in the fovea of the retina, while the "rods" are endowed chiefly with grey molecules. This is simply translating into the language of the theory the well-known fact that the colour sense is chiefly confined to the centre of vision, as anybody may prove by looking at a coloured object through the corner of the eye. This distribution, says Miss Franklin, offers a perfect analogy with that of the organs of hearing. In the ear we have a very simple apparatus for hearing noise only, and also a highly differentiated structure for the discrimination of notes of various pitches.

IN 1881 M. Blondlot gave the results of some experiments he had made on the velocity of propagation of Hertzian waves. The velocity was determined by calculating the period of the electrical vibrations from the dimensions of the resonator, and measuring experimentally the wave-length. The results obtained, while they indicated that the velocity is always approximately that of the propagation of light, showed that as the wave-length increased the velocity diminished. In a note, communicated at a recent meeting of the Académie des Sciences (Paris) (*Comptes Rendus*, No. 6, 1894), M. Mascart has shown that a more accurate calculation of the frequency gives a remarkable agreement between the different experiments. In this note the author gives the formula for the self-induction of a rectangle of wire, and applies it to the reduction of M. Blondlot's observations. He finds that the values obtained for the velocity of propagation show no systematic variation with the wave-length within the limits of observation, that is, between wave-lengths of 9 and 35 metres. The mean of all the experiments gives the value 303,200 kilometres per second

as the velocity, while, if the results obtained with one of the resonators which M. Blondlot thinks are less trustworthy are omitted, the mean becomes 302,850 kilometres per second, the maximum variation obtained from this mean amounting to 2.5 per cent. The author also points out that it is interesting to note that the mean value of the velocity of propagation of electro-magnetic waves obtained is about one per cent. higher than the velocity of light. The difference he considers to be due to the fact that the calculated value of the self-induction is too small, for the radius of the wire is an important factor, which may be estimated too large, either owing to errors in measurement or to the fact that the current in the wire is not exclusively confined to the external surface of the wire (as the formula employed supposes), but penetrates some distance into the wire. The employment of wires of larger section, he thinks, might perhaps lead to a better result.

WITH reference to some recent experiments on the railway between Beuzeville and Havre, the *Electrician* says:—"When, about three years ago, a scheme was announced for building a locomotive on which a high-speed engine was to drive a three-phase alternator, which was in turn to drive motors, it met with a little ridicule, and the two sets of tests which have been recently made on the Chemin de Fer l'Ouest at Havre have raised a smile, but only where the reasons of this roundabout system have not been understood. The two chief difficulties in obtaining higher speeds than from 70 to 80 miles an hour with ordinary express locomotives are want of balance and want of space. The impossibility of avoiding the superfluous vertical action of balance weights on an ordinary single-wheel locomotive is alone sufficient to reduce adhesion, and to allow slip at speeds a little over 80 miles an hour. All these difficulties are reduced, if not avoided, in the Heilmann locomotive, though not without the introduction of others, and it remains to be seen how the balance of advantage works out."

MR. H. WORK DODD has investigated the question as to a relationship between epilepsy and errors of refraction in the eye, and the current number of *Brain* (part lxiv.) contains his results. He has examined the eyes of one hundred cases of true epilepsy, and compared the refractions with those of apparently normal eyes. It appears that of simple hypermetropia there were twenty-eight cases per cent. less in the epileptic than in the apparently normal class. Of astigmatism of all kinds, there were twenty-six cases per cent. more in the epileptic division than in the normal one. These and other differences lead Mr. Dodd to conclude that, given a certain condition of instability of the nervous system: (1) errors of refraction may excite epilepsy; (2) the correction of the errors of refraction will, in combination with other treatment, in many cases cure or relieve the epileptic condition; and (3) that in some cases, when the refraction error has been corrected, the epilepsy will continue, generally in a modified form, in consequence of other irritation, even though the error of refraction may have been the exciting cause of the fits in the first instance. Mr. Dodd is strongly of opinion that in every case of epilepsy—in addition to general treatment and the investigation of other organs—the eyes should be carefully examined under a mydriatic with a view of correcting any error of refraction that may exist by the use of proper spectacles.

THE bacterial contents of ice from various sources has been very exhaustively investigated, but only a few experiments have been made on the vitality of particular micro-organisms in artificially frozen ice produced by means of freezing mixtures. Prudden exposed various bacteria to 24° of cold, and amongst these the typhoid bacillus was found still present in large numbers after 103 days of continuous exposure to this low temperature; if, however, the freezing was interrupted during

the twenty-four hours by three separate thawings, they were entirely destroyed at the end of three days. Prudden also showed very clearly that the resistance of an organism depends upon its initial vitality, for whereas the *staphylococcus pyogenes aureus* taken from a fresh agar cultivation was present in very large numbers at the end of sixty-six days, if an old and half dried-up agar culture was used for the original infection, none were found after seven days. Renk (*Fortschritte der Med.* No 10, 1893) has quite recently examined the behaviour of the cholera organism in ice artificially prepared from sterilised river Saale water, and finds that five days uninterrupted exposure to a temperature of from - 0.5 to - 7° C. is sufficient to entirely destroy these bacilli; but contrary to Prudden's experience, he found that if the freezing was interrupted, which took place when the vessels containing the organisms were removed for examination, a longer time (6-7 days) was necessary for their annihilation. When unsterilised Saale water was used, the cholera organisms disappeared at the end of three days, and the ordinary water bacteria present were reduced in 24 hours from 1,483,000 to 62,445 per c.c. whilst after three days only 4480 were found. Prudden's experiments with the typhoid bacillus, together with those on the cholera organism, indicate how important it is that ice for consumption should only be prepared from sterilised water, or from water the source of which is altogether beyond suspicion of contamination.

THE Société d'Encouragement pour l'Industrie Nationale has issued its *Annuaire* for 1894.

WITH the present year the bi-monthly cryptogamic journal, *Heftwigia*, published at Dresden, and edited by Prof. G. Hieronymus, commences the publication of a periodical synopsis of cryptogamic literature.

WE have received a copy of "Bourne's Handy Assurance Directory" for 1894. The work appears for the first time under the imprimatur of Mr. William Schooling, who will doubtless sustain the reputation for accuracy earned for it by the late editor, Mr. William Bourne.

DR. M. BARATTA has prepared a series of maps showing the topographical distribution of earthquakes in Italy for each year from 1887 to 1891. The maps, which originally appeared in the *Annali dell'Ufficio Centrale di Meteorologia e Geodinamica*, should be of great interest to seismologists.

THE second volume of Sir David Salomons' "Electric Light Installations," dealing with apparatus, engines, motors, governors, switches, meters, &c. will be shortly issued in Messrs. Whittakers' "Specialists' Series." The third and concluding volume is now in the press, and will deal with the application of electricity.

MR. W. THYNNE LYNN'S "Celestial Motions" (Edward Stanford) has reached the eighth edition. The first edition of this useful little book was published ten years ago. Another little treatise by the same author, "Remarkable Comets," has just passed into a second edition. Both books have been revised and brought up to date.

AN important report on the Ainu of Yezo, Japan, prepared for the U.S. National Museum, by Mr. Romyh Hitchcock, has been received. It is profusely illustrated from photographs taken by the author, and contains a mass of detail concerning the remnant of a once numerous people in Yezo and on the islands Kumashiri and Zeterof.

MESSRS. BLISS, SANDS, AND FOSTER announce that they have made arrangements with the editor of "A Son of the Marshes," and with Prof. Boulger, for the joint production of

twelve monthly volumes to be entitled "The Country, Month by Month." Mr. Lockwood Kipling has supplied a design for the cover. The first number will appear on March 1, and will be descriptive of that month.

A NEW work is announced by Mr. Leland, bearing upon his favourite subject—practical education. The manual deals with elementary metal work, including bent iron, repoussé, cut metal, and easy silver work. It is written primarily for manual training classes in elementary and preparatory schools, but will probably be found interesting to any one who has a mechanical bent. Mr. Karl Krall has revised the work while passing through the press. The publishers are Messrs. Whittaker and Co.

THE first part of the new journal, *Novitates Zoologicae* has been issued. It is a large 8vo, with 266 pages and four coloured plates, while six others are deferred, to appear in part ii. An excellent memoir, by Dr. Forsyth Major, on the small lemurs of Madagascar (*Microcebus*, &c.), commences the work; then follow articles by Mr. Rothschild (on a new pigeon, and on some new sphinx-moths), and by his two assistants, Dr. E. Hartert and Dr. K. Jordan, on various birds and insects. The organ of the Tring Museum has made a good start, and promises to be of great interest to zoologists.

LOVERS of nature will be glad to know that the supposed dissolution of our old contemporary, *Science Gossip*, after nearly thirty years' prosperity, proves to be only a case of suspended animation, and that its familiar face will again be seen in public after the 25th inst. In future *Science Gossip* will be under the editorship of Mr. John T. Carrington and Mr. Edward Step. The character of the paper as a medium between amateur naturalists, and for the recording of observations, will be fully maintained; at the same time, it is intended to give it a higher educational value by enlisting the aid of the leading men in every department of natural science. Messrs. Simpkin, Marshall, and Co. will in future be the publishers.

IN our issue of November 9, 1893, we gave a description of some Hindoo dwarfs photographed by Colonel A. T. Fraser. Dr. A. E. Grant afterwards suggested that the dwarfs were afflicted with the disease known as pseudo-hypertrophic paralysis. Colonel A. T. Fraser writes to us, however, as follows:—"On observing Dr. A. E. Grant's letter in NATURE for January 4, I lost no time in sending him a copy of the dwarfs' photograph, to which his reply states—'It is evident they are true dwarfs, and not subjects of the disease I alluded to. Their heads and trunks appear to be of normal size, whilst their limbs are stunted and deformed.'"

UNDER the title, "Climates of the United States," Dr. Charles Denison has prepared a revised edition, in a condensed form, of his annual and seasonal climatic charts of the United States. The book is published by the W. T. Keener Co., Chicago. It consists of twelve charts and eleven tables representing the climatic statistics of different sections of the United States. The annual rainfall and temperature are shown on one chart, the former by means of broken lines, and the latter by the usual isothermals. A chart is devoted to the illustration of annual cloudiness, and one to regional elevations. Upon the four charts exhibiting the isothermal lines for the four seasons of the year, a number of arrows of three different kinds are drawn, showing not only the directions of the prevailing winds, but also the directions of winds likely to be followed by rain or snow, and the directions of those that usually herald fine weather. The average atmosphere humidities during different seasons of the year are clearly shown in eight degrees of colour. Altogether the book presents in a handy form a mass of climatological information.

THE late Prof. Hertz could have no more permanent monument than that afforded by his work on the propagation of electric energy through space, reviewed in these columns on October 5, 1893. An English edition of the collected papers contained in that volume has recently been published by Messrs. Macmillan and Co., under the title "Electric Waves." Prof. D. E. Jones is the translator, and he had the advantage of Dr. Hertz's supervision and advice while the book was passing through the press. In a preface, Lord Kelvin briefly describes the development of the idea as to action at a distance, and concludes by pointing out that "absolutely nothing has hitherto been done for gravity either by experiment or observation towards deciding between Newton and Bernoulli, as to the question of its propagation through a medium, and up to the present time we have no light, even so much as to point a way for investigation in that direction." Lord Kelvin also calls attention to the experimental work on electromagnetic waves done previous to the publication of Hertz's researches, but which do not detract in the least from their merit. The English reading public will doubtless fully appreciate Prof. Jones' translation of one of the most important works of this century.

THE polymeric modifications of acetic aldehyde form the subject of an interesting and important communication by Messrs. Orndorff and White to the January issue of the *American Chemical Journal*. These remarkable substances, paraldehyde and metaldehyde, have furnished the theme of many investigations, but their nature and their relation to common aldehyde has not hitherto been definitely established. In the older treatises upon organic chemistry, no less than five different polymeric forms of aldehyde are mentioned, but the researches of Kekulé and Zincke resulted in the existence of only two being established, the liquid paraldehyde and the solid metaldehyde. It was shown that carefully purified aldehyde suffers no change on heating or cooling, or on being kept for a length of time, and that polymerisation is always connected with the presence of certain substances, such as hydrochloric and sulphuric acids or carbonyl chloride. In most cases both forms are simultaneously produced, a low temperature, particularly below 0°, favouring the formation of metaldehyde, and a higher temperature being more favourable to the production of paraldehyde. The vapour density of paraldehyde was further shown to correspond to the triple formula  $(C_2H_4O)_3$ , and it was assumed that three molecules of ordinary aldehyde unite to form the closed chain compound, paraldehyde. The constitution thus arrived at for the liquid polymer of aldehyde has since received remarkable confirmation from the spectrometric work of Brühl, who found that the molecular refraction of paraldehyde corresponded to that calculated upon the assumption of the triple formula. Metaldehyde only differs from paraldehyde in its physical properties; chemically, the two compounds behave precisely alike. The vapour density of metaldehyde cannot be directly determined owing to its partial dissociation into ordinary aldehyde when heated, hence its formula has not hitherto been definitely known. Hanriot and Economides succeeded, however, in determining its density by introducing a correction for the amount of ordinary aldehyde produced, and their results indicated that the formula of this solid polymer was the same as that of the liquid paraldehyde. Orndorff and White have here taken up the subject, and show that determinations of molecular weight by Raoult's method, using phenol and thymol as solvents, point irresistibly to the same conclusion, the molecular weight found being always in the neighbourhood of 132, corresponding to three times 44, the molecular weight of aldehyde. They have also repeated and extended the vapour density determinations of the former observers, and have definitely settled the fact that paraldehyde and metaldehyde are isomers, both possessing the molecular composition



( $C_2H_4O_3$ ). They further show that metaldehyde is by no means so stable as has been supposed; it decomposes completely in a few days' time, the products of decomposition being paraldehyde and a new polymer, tetraldehyde ( $C_8H_{16}O_4$ ). The latter substance, whose composition has been definitely established by vapour density and cryoscopic determinations, is a solid of similar appearance and properties to metaldehyde. It is finally shown that paraldehyde and metaldehyde are in all probability stereo-isomers, like maleic and fumaric acids, the more stable paraldehyde corresponding to the fumaroid or so-called "cis-trans" form, and the less stable metaldehyde to the maleinoid or "cis" form.

THE additions to the Zoological Society's Gardens during the past week include a Macaque Monkey (*Macacus cynomolgus*, ♂) from India, presented by Mr. James Carter; two Vulpine Phalangiers (*Phalangista vulpina*, ♂ ♀) from Australia, presented respectively by Mrs. Percy Morton and Mr. W. Hughes; two Garden Dormice (*Myoxus quercinus*) European, presented by Dr. R. B. Sharpe; a Goshawk (*Astur palumbarius*) European, presented by Mr. Duncan Parker; a Jackdaw (*Corvus monedula*) British, presented by Mrs. Dixon Brown; two Striped Hyænas (*Hyæna striata*) from North Africa, a Mitred Guinea Fowl (*Numida mitrata*) from Madagascar, deposited.

#### OUR ASTRONOMICAL COLUMN.

SUN-SPOTS AND MAGNETIC DISTURBANCES.—The *Memoirs* of the Società degli Spettroscopisti Italiani (vol. xxii, p. 189) contains a paper by Dr. L. Palazzo on the magnetic disturbances of August 1893, considered in relation to the extent of solar spots. When the very large spot, or rather group of spots, was passing the central meridian on August 6 and 7 of last year, the bifilar magnetometer of the Roman College Observatory was considerably disturbed. On August 18, that is, when the spots were again near the plane of the central meridian, but on the other side of the sun, all three magnetic elements suffered a disturbance. Another magnetic storm was recorded at the Marine Observatory of Pola on August 12 and 13. Dr. Palazzo has collected all the facts connected with these three disturbances, and discusses them with the idea of determining the relation, if any, between them and sun-spots. From the paper it appears that the magnetic perturbation of August 6 commenced at 4.7 hours, when the double spot was about  $15^{\circ}4'$  from the central meridian. The middle point of the pair passed the central meridian at 8.5 hours on the following day. It would be interesting to know whether the sun was under observation at any place east of Rome at a time corresponding to that given for the commencement of the brusque magnetic disturbance described by Dr. Palazzo, and if so, whether any strange phenomenon was observed. The disturbances of August 12 preceded by about twelve hours the transit of the largest spot visible upon the sun at the time. On August 18, however, no spot could be seen near the central meridian when the magnetic needles were recording a perturbation, while neither when the double-spot again appeared on the sun's limb, nor when it passed the central meridian on September 2, did the magnetic needles flutter. We have, therefore, spots without disturbances, and disturbances without spots, thus indicating that there is no connection between the phenomena. Prof. Ricco's discussion of the relation between solar spots and disturbances of terrestrial magnetism (*Mem. degli Spettrosc.*, vol. xxi, p. 153, 1892) led him to believe that magnetic disturbances occur, on the average, about 45.4 hours after the transit of spots over the central meridian of the sun. M. Marchand (*Comptes Rendus*, 1887, p. 133) showed that such disturbances occurred when groups of spots or faculæ were near the centre of the sun's disc, and Dr. Veeder has given evidence to prove that the appearance of spots on the sun's eastern edge is the signal for magnetic fluctuations. Dr. Palazzo, however, believes that the position with respect to the earth of the solar region disturbed is really unimportant.

STONYHURST COLLEGE OBSERVATORY.—Father Sidgreaves' report on the meteorological, magnetic, and solar observations

made at Stonyhurst College Observatory during 1893 has been issued. We extract from it the chief points of astronomical interest.

The ordinary work of the solar chromosphere was practically suspended during the year on account of the anticipated dismounting of the telescope for the erection of the Father Perry Memorial. But the sun-spot drawings have been continued, and were carried on with the six inch objective which was mounted on the equatorial during the absence of parts of the eight-inch telescope. The new objective, with its mountings, was erected on November 6. It has a clear aperture of 14.5 inches, and was worked by Sir Howard Grubb, of Dublin. It is valued at £650, and constitutes the substantial tribute to the memory of the late Father Perry, raised by the generosity of his many friends.

The large grating spectrograph has been employed upon the solar spots and faculæ with the result that 175 photographs were obtained of spot-spectra in the green-yellow region, and ninety-two plates of faculæ-reversals of the H and K lines.

The night-work with the equatorial has been confined to stellar photographic spectra. In May, it was decided to make use of every opportunity upon the variable star  $\beta$  Lyræ; and as the exposures upon this were necessarily long, and there were many failures, other stars were let alone. Out of the whole number of exposures forty-five plates of  $\beta$  Lyræ proved to be available for careful measurements, and the results are published in the December number of the Monthly Notices of the Royal Astronomical Society.

THE "ANNUAIRE" OF THE BUREAU DES LONGITUDES.—A copy of the *Annuaire* of the Bureau des Longitudes, for the present year, has been received. Every year sees an increase in the quantity of matter compressed into that veritable *rade mecum*. To the present volume has been added notes by Prof. Cornu on the physical aspect of the sun, solar spectroscopy, and the spectra of comets and nebulæ. The descriptive note on stellar spectra, began in the 1893 issue, is completed, and an account is given of recent observations of  $\beta$  Lyræ, and the spectrum of Nova Aurigæ. The articles include one by Prof. Poincaré, on light and electricity, according to Maxwell and Hertz; another, on the origin and use of the compass, by Contre-Amiral Fleuriais; and a third, in which Dr. Janssen describes four days of observation on the summit of Mont Blanc. Altogether, the 1894 *Annuaire* adds to the reputation gained by its predecessors; it is a volume which no astronomer can afford to be without, and which every student of physical science will find useful.

THE SPECTRUM OF NOVA NORMÆ.—A telegram received at Kiel on February 15 announces that Nova Normæ was observed by Prof. Campbell at the Lick Observatory on February 13, and found to have fallen to magnitude 9.5 (*Astr. Nachr.* 3211). The spectrum was seen to consist of four bright lines of the same relative intensity and position as those shown by Nova Aurigæ in August, 1892 (see NATURE, vol. xlvi, p. 524). Like this new star, therefore, Nova Normæ has descended to the condition of a planetary nebula.

#### THE SMITHSONIAN INSTITUTION REPORT.

THE report of Prof. S. P. Langley, Secretary of the Smithsonian Institution, for the year ending June 30, 1893, has just been published. Its contents refer, not only to the Smithsonian Institution, but also to the work of the U.S. National Museum, the Bureau of Ethnology, the Bureau of International Exchange, the Zoological Park, and the Astro-Physical Observatory. To do justice to the many and various operations of all these sections is impossible within the limits of space at our disposal, but some idea of the work may be obtained from the following abstract:—

##### Research.

It appears to be an essential portion of the original scheme of the government of the Smithsonian Institution that the secretary should be expected to advance knowledge, in letters, or in science, by personal research. Prof. Langley has continued the traditions of the Institution and the usage of former secretaries by contributing to the objects stated, as far as his increasing administrative duties would permit. During 1893 he continued the researches, of which a portion was published in 1891, in a

treatise entitled "Experiments in Aerodynamics." Interesting results have since been reached, which appear to be of wide utilitarian importance, but though Prof. Langley hopes soon to be able to make some communication of them to the public, they are not yet complete. In this same connection, in pursuit of an investigation begun some years ago, he has made experiments upon the variations continually going on in the atmosphere, in what is regarded for ordinary meteorological purposes as a steady wind. Specially light anemometers have been constructed and mounted upon the north tower of the Smithsonian building, and connected with a suitable recording apparatus. The complete results, which promise conclusions of practical importance, are being collated and will be published at a later date. (See NATURE, January 18.)

The extensive investigations carried on in astro-physics are referred to in the adjoining column.

As in previous years, aid to a limited extent has been given to original investigators who are not immediately connected with the Institution. Prof. E. W. Morley has continued his determinations of the density of oxygen and hydrogen, for which special apparatus has been provided by the Institution.

A paper by Prof. A. A. Michelson, upon the "Application of interference methods to spectroscopic measurements," with a view to increased precision in measuring specific wave-lengths of light, has been published in connection with his work upon a universal standard of length. Mr. F. L. O. Wadsworth was detached from the observatory staff, and sent (at the expense of the Smithsonian fund) to the Bureau Internationale des Poids et Mesures, near Paris, to assist Prof. Michelson during a stay of six weeks in preparation of this standard.

#### *The Hodgkins Fund.*

Numerous applications, which are referred to the advisory committee for consideration, have already been made for grants from the Hodgkins Fund to aid original investigations upon the nature of atmospheric air and its properties. Two have been approved, a grant of 500 dollars having been made to Dr. O. Lummer and Dr. E. Pringsheim, members of the Physical Institute of the Berlin University, for researches on the determination of an exact measure of the cooling of gases while expanding, with a view to revising the value of that most important constant which is technically termed the "gamma" function. Mrs. Lummer and Pringsheim were recommended for this work by Dr. H. von Helmholtz, of Berlin.

A second grant of 1000 dollars has been made to Dr. J. S. Billings, U.S.A., Army Medical Museum, Washington, and to Dr. Weir Mitchell, of Philadelphia, for an investigation into the nature of the peculiar substances of organic origin contained in the air expired by human beings, with a specific reference to the practical application of the results obtained to the problem of ventilation for inhabited rooms.

#### *The Naples Table.*

In the spring of last year, a petition, signed by nearly two hundred biologists, who represented some eighty universities and scientific institutions, was presented to Prof. Langley, asking that a table be maintained by the Smithsonian Institution at the Naples Zoological Station, for the benefit of American investigators. This step was favourably decided upon, and in April last an advisory committee was appointed, at Prof. Langley's request, in order to obtain opinions as to the best administration of the table. The four members of this committee are:—Major John S. Billings, U.S.A., nominated by Prof. O. C. Marsh, President of the National Academy of Sciences; Dr. E. B. Wilson, Professor of Zoology, Columbia University, nominated by Prof. Chittenden, President of the Society of American Naturalists; Dr. C. W. Stiles, Zoologist, Bureau of Animal Industry, U.S. Department of Agriculture, nominated by Prof. C. O. Whimian, President of the American Morphological Society; Dr. John A. Ryder, Professor of Embryology, University of Pennsylvania, nominated by Prof. Allen, President of the Association of American Anatomists. Dr. J. S. Billings, U.S.A., has been designated chairman, and Dr. C. W. Stiles secretary of the committee.

Satisfactory conditions as to the occupancy of the table have been arranged with Dr. Dohrn, the director of the station at Naples, and a contract has been signed and completed.

Numerous applications for the occupancy of the table have been received, but at the close of the fiscal year sufficient consideration had not been given them to render it possible to make any definite assignment.

#### *The Astro-Physical Observatory.*

Prof. Langley has continued his important investigations with the bolometer. The instrument, as now constructed, is a minute strip of metal barely  $\frac{1}{1000}$  of an inch wide, and less than  $\frac{1}{10000}$  of an inch thick. Through this frail thread of metal a current of electricity is continually kept flowing. When the spectrum, visible or invisible, is thrown upon it, the thread is warmed and the current decreased by an amount corresponding to the intensity of the effect received, while novel instruments specially mounted and constructed are in electric connection with the thread, and now automatically record every minute change in this current.

With late improvements these instruments are so delicate that a change of temperature of one-millionth of a degree is readily detected and even measured, and it is easy to see that as a consequence of this delicacy the greatest care must be taken in their use. Thus the laboratory must be almost completely darkened, and closed tightly, so as to exclude all draughts and to keep it at as nearly a uniform temperature as possible, while for other reasons it must be kept under constant hygrometric conditions.

In spite of numerous difficulties, most of which are due to the very temporary and inefficient nature of the small wooden building in which the work is carried on, and its proximity to the traffic-laden streets, the expectations of last year have been largely realised, and a detailed publication of the work, accompanied by charts showing several hundred new and before unknown lines, will shortly be issued.

The result of the year's work has been the discovery and approximate determination of position of about 150 or 200 new lines in the hitherto unexplored region of the solar spectrum. Important as these results are, they are but the beginning of what Prof. Langley hopes will be accomplished.

In addition to the bolometric work proper, experiments on three special methods of investigation of the infra-red spectrum have formed a considerable portion of the year's work:—(1) Preliminary experiments on the measurement of wave-lengths in the invisible spectrum by interference methods. (2) Experiments on photographing the invisible spectrum by the aid of phosphorescent films. (3) Preliminary experiments on bolometric investigation of the infra-red normal spectrum. What might almost be said to have been the chief work of the observatory for the year, has been the improvement of the apparatus and instrumental conditions of working.

#### *Lunar Photography.*

Prof. Langley has been interested for a considerable time in the possibility of preparing a chart of the moon by photography, which would enable geologists and selenographers to study its surface in their cabinets with all the details before them which astronomers have at command in the use of the most powerful telescopes. Such a plan would have seemed chimerical a few years ago, and it is still surrounded with difficulties, but it is probable that within a comparatively few years it may be successfully carried out. No definite scale has been adopted, but it is desirable that the disc thus presented should approximate in size one two-millionth of the lunar diameter; but while photographs have been made on this scale, none of them show detail which may not be given on a smaller one.

The work has been favoured with the co-operation and interest of the directors of the Harvard College Observatory, of the Lick Observatory, and others, who in response to a letter addressed to them on February 10, 1893, have furnished many valuable suggestions.

The preparation of a series of enlargements of lunar photographs taken at the Kenwood and Lick Observatories, has been undertaken at the Astro-Physical Observatory. Some attempts at solar photography have been made at this observatory, but the atmospheric conditions prove to be very unfavourable to any satisfactory work in this direction.

#### *The National Museum.*

The National Museum suffers from the want of funds for the improvement of the collections by purchase. It is pointed out that in respect of this provision, the museum stands at the foot of all American museums, being surpassed even by every municipal museum of note in the United States. The disadvantage in which it stands (Prof. Langley remarks), when compared with what are now its competitors in the national

collections of the leading countries of Europe, has grown painfully obvious. Important collections made in America of the objects illustrating the vanishing life of its own native races of men and animals—collections which can never be made again, and never be replaced—are being permanently withdrawn to enrich the museums of Europe. This has already gone so far that it is necessary in order to study the past life of the Mississippi Valley to come to England, while for that of southern Alaska Americans must go to Berlin, and for the Californian coast they have to go to Paris, and so on. It is already then, in European capitals more than in those of the United States, that the most important characteristics of the American races have to be studied, and at the present rate, within a few more years, when the American collector has nothing more left to gather and to sell abroad, it will be in Europe, and not in America, that the student of past American history must seek for nearly everything that most fully illustrates the ancient life and peoples of the American continent.

#### *The Bureau of Ethnology.*

As during previous years, the work of the Bureau of Ethnology has been conducted with special reference to the American Indians in their primitive condition, with a view of securing the largest possible amount of information, both in the form of records for print and in the form of material objects for preservation and future study in the National Museum.

One of the most interesting questions ever raised concerning the early peoples of America relates to the artificial mounds scattered abundantly over the Mississippi Valley, and with less abundance over most of the United States. Many investigators have given attention to these works of a vanished race; and it came to be a general opinion that the builders of the mounds were a distinct people antedating the native races found in possession of the land on the advent of the Europeans. Within the last five years extended surveys of the mound territory have been made by collaborators of the Bureau under immediate instructions from the director and by Dr. Cyrus Thomas. An elaborate report on this subject has been prepared during the year, and is now in press. It is the united opinion of the officers of the Bureau that this document contains the solution to the mystery of the mounds; very greatly to the surprise of the investigators who began the work, they have been led to believe that the mounds and the art products contained therein are in no wise distinct from the works of the modern Indians, and that the distribution of tribes can now be studied from the mounds themselves as well as from other aboriginal records.

Many other important investigations have been carried on, one of the chief being the means of interchanging ideas among the American Indians, including gesture, speech, and picture writing, as well as spoken language. The primitive modes of expression by means of gestures or pantomime, and by means of glyphs or pictures, are held by students as of special interest in that they represent the beginnings of language.

#### *Smithsonian International Exchange Service.*

As an illustration of the extent of this special part of the Institution's activities, it may be stated that it has now about 24,000 active correspondents, of whom 14,000 are in Europe, 200 in Africa, 500 in Australia, and about 9000 in the various countries of the Western Hemisphere. In the course of this work, the Institution has gathered at Washington an immense collection of books, found nowhere else to so great an extent, bearing chiefly upon discovery and invention, which, with others, now occupy nearly 300,000 titles. Over 100 tons of books passed through the exchange office during the fiscal year 1892-93, and while the service is used almost exclusively for the transmission of printed matter of a scientific nature, natural history specimens having no commercial value are occasionally transmitted under special permission, when they cannot be conveniently forwarded by the ordinary means of conveyance.

The National Zoological Park appears to be in a satisfactory condition, and fulfils the chief purpose for which it was made, viz. to keep from extinction species of American animals, several of which are now upon the point of vanishing from the face of the earth, and would vanish for ever if something were not done to preserve them.

In conclusion we must say that the report covers so many branches of science, and so much has been done to advance each of them, that in the above abstract it has only been possible

to mention a few of the investigations. Sufficient has been said, however, to show that considerable contributions to knowledge have been made.

#### *THE GREENLAND EXPEDITION OF THE BERLIN GEOGRAPHICAL SOCIETY.*

PARTICULAR interest is felt by the Geographical Society of Berlin in the results of an expedition to the north of Greenland, which they fitted out some two years ago. At the sitting of the Society held on November 4, 1893, Dr. Erich von Drygalski and Dr. E. Vanhöffen communicated papers on the work of the expedition, Dr. Drygalski giving a general account of their life in Greenland.

On June 27, 1892, they reached Umanak, a Danish colony on the shores of North Greenland, and selected as their base of operations a position some distance inland at the head of the Umanak Fjord. They placed their house in the hollow of a great ice-cirque. East and west were the ice-streams of the Great and Lesser Karajak, behind them stretched the bare expanse of the ice-sheet of the interior, in front lay the open water of the narrow fiord. Dr. Stade had charge of the meteorological station; Dr. Drygalski and Dr. Vanhöffen made journeys into the interior and along coastal regions of glacier and moraine.

At first, when they ascended the Karajak, none of the Greenlanders were willing to accompany them, as they are full of superstitions about the ice-wastes of the interior. Three ultimately consented, and overcame their fears so far as to enter with spirit into the difficulties of the tour. Bamboo canes were fixed as marks in the ice, and the "interference area" studied where the upper ice of the Karajak streams meets the inland ice. In the winter months, Dr. Drygalski, with two trusty Greenlanders, explored the Great Karajak glacier. He took measurements on the relative rate of movement in the smoother and more cleft parts of the glacier. He tells how, as the big blocks of ice tumbled down, fine ice-dust was raised, which hung like a transparent veil around the ice-pillars and hummocks, sometimes catching the sun-rays and glaucing with colour effects. Ice-grottoes were found, the remnants of old water-channel in those the temperature was wonderfully high, and the ice-water quite moist.

From February until June, Dr. Drygalski and Dr. Vanhöffen were engaged in a long sleigh journey to the most northerly part of the Upernivik colony, in Lat. N. 73°. At this latitude the outer margin of the great ice mantle of the interior extended to the sea level. Another tour which they attempted in June had to be given up on account of the warm Föhn wind. Before their final departure from Karajak, they ascended the ice once more to take observations on the bamboo marks previously set. Dr. Drygalski attributes the movement of the ice-streams to their content of water, and says there would be no motion whatever unless the melting temperature were reached. Farther, the increase of temperature in summer, due to the downward passage of heated surface-water, is much greater than the decrease of temperature in winter. The warming effect of the water is at its maximum in the deepest layers of ice, where also the movement is most marked. Microscopic examination of the ice also proved that it was thoroughly penetrated with water. It will be some time before the expedition can publish their results in detail. Dr. Vanhöffen's work was mainly biological.

#### *THE SUN-SPOT PERIOD AND THE WEST INDIAN RAIN-FALL.*

THE irregularities of the rainfall from year to year are so large that apparently there is no connection whatever between the sun-spot period and the Jamaica or any other rainfall; but if we smooth down these irregularities by taking the mean for three years as the rainfall for the middle of those years—that is to say if we take the mean of the rainfall during 1866, 1867, and 1868 as applying to the middle of 1867, the mean of the rainfall during 1867, 1868, and 1869 as applying to the middle of 1868, and so on—we shall then get a series which rises to a maximum about the time of a solar minimum, and which falls to a minimum about the time of a solar maximum.

It is now about a year ago since this connection was found between the sun-spot period and the Jamaica rainfall, and my article on the subject appeared in the *Journal* of the Jamaica Institute, No. 5.

The Barbados, Antigua, and Trinidad rainfalls have been subjected to the same treatment with the same results; but it will be noticed in the following table that the smoothed Jamaica rainfall rises and falls with much greater regularity than the smoothed rainfall in Barbados, Antigua, and Trinidad; the irregularity in the last island is due to the circumstance that we are dealing with the rainfall at one station only, namely the Botanic Gardens, instead of the rainfall deduced from many stations, as in the other islands.

ON PREPARING THE WAY FOR TECHNICAL INSTRUCTION.

SIR PHILIP MAGNUS discoursed on methods of technical instruction on February 14, at the College of Preceptors. In the course of his address he pointed out that our intermediate schools were generally described as in a state of chaos, and it could scarcely be expected that so nebulous a system would be largely influenced by the definite movement in

| Year (middle of). | Sun-spot period. | JAMAICA.               |                      | BARBADOS.              |                      | ANTIGUA.               |                      | TRINIDAD.            |                      |
|-------------------|------------------|------------------------|----------------------|------------------------|----------------------|------------------------|----------------------|----------------------|----------------------|
|                   |                  | Rainfall, 90 stations. | Average for 3 years. | Rainfall, 90 stations. | Average for 3 years. | Rainfall, 47 stations. | Average for 3 years. | Rainfall, 1 station. | Average for 3 years. |
|                   |                  | in.                    | in.                  | in.                    | in.                  | in.                    | in.                  | in.                  | in.                  |
| 1843              | Min.             |                        |                      | 45'31                  | —                    |                        |                      |                      |                      |
| 44                |                  |                        |                      | 74'45                  | 54'56                |                        |                      |                      |                      |
| 45                |                  |                        |                      | 43'91                  | 61'39                |                        |                      |                      |                      |
| 46                |                  |                        |                      | 65'82                  | 52'61                | Min.                   |                      |                      |                      |
| 47                |                  |                        |                      | 48'10                  | 59'23                |                        |                      |                      |                      |
| 48                | Max.             |                        |                      | 63'77                  | 54'88                |                        |                      |                      |                      |
| 49                |                  |                        |                      | 52'77                  | 61'47                |                        |                      |                      |                      |
| 50                |                  |                        |                      | 67'88                  | 60'02                |                        |                      |                      |                      |
| 51                |                  |                        |                      | 59'40                  | 62'02                |                        |                      |                      |                      |
| 52                |                  |                        |                      | 58'77                  | 62'34                |                        |                      |                      |                      |
| 53                |                  |                        |                      | 68'84                  | 59'50                |                        |                      |                      |                      |
| 54                |                  |                        |                      | 50'88                  | 65'68                | Max.                   |                      |                      |                      |
| 55                |                  |                        |                      | 77'31                  | 58'89                |                        |                      |                      |                      |
| 56                | Min.             |                        |                      | 48'49                  | 62'23                |                        |                      |                      |                      |
| 57                |                  |                        |                      | 60'90                  | 51'54                |                        |                      |                      |                      |
| 58                |                  |                        |                      | 45'22                  | 53'45                | Min.                   |                      |                      |                      |
| 59                |                  |                        |                      | 54'22                  | 52'45                |                        |                      |                      |                      |
| 60                | Max.             |                        |                      | 57'91                  | 61'98                |                        |                      |                      |                      |
| 61                |                  |                        |                      | 73'82                  | 63'97                |                        |                      |                      |                      |
| 62                |                  |                        |                      | 59'27                  | 58'49                |                        |                      | 63'15                | —                    |
| 63                |                  |                        |                      | 42'38                  | 53'61                |                        |                      | 66'80                | 64'28                |
| 64                |                  |                        |                      | 59'19                  | 56'74                |                        |                      | 62'90                | 71'66                |
| 65                |                  |                        |                      | 68'64                  | 62'50                |                        |                      | 85'28                | 72'01                |
| 66                |                  |                        |                      | 59'68                  | 66'08                | Max.                   |                      | 67'86                | 73'23                |
| 67                | Min.             | 53'65                  | —                    | 69'93                  | 58'07                |                        |                      | 66'56                | 63'54                |
| 68                |                  | 64'47                  | 61'95                | 44'60                  | 54'35                |                        |                      | 56'21                | 58'74                |
| 69                |                  | 67'74                  | 62'53                | 48'52                  | 51'10                |                        |                      | 53'46                | 59'67                |
| 70                | Max.             | 55'37                  | 70'85                | 60'17                  | 50'05                |                        |                      | 69'35                | 66'13                |
| 71                |                  | 89'43                  | 64'96                | 41'46                  | 50'06                |                        |                      | 75'58                | 64'96                |
| 72                |                  | 50'09                  | 61'57                | 48'55                  | 47'23                | Min.                   |                      | 49'95                | 56'52                |
| 73                |                  | 45'18                  | 52'78                | 51'69                  | 53'15                |                        |                      | 44'02                | 56'75                |
| 74                |                  | 63'06                  | 59'06                | 59'22                  | 57'54                |                        |                      | 76'28                | 60'40                |
| 75                |                  | 68'94                  | 61'47                | 61'71                  | 57'89                | 31'16                  | —                    | 60'90                | 73'04                |
| 76                |                  | 52'42                  | 64'24                | 52'73                  | 62'85                | 28'78                  | 33'97                | 81'95                | 71'65                |
| 77                |                  | 71'35                  | 64'06                | 74'10                  | 66'64                | 41'98                  | 39'94                | 72'10                | 71'43                |
| 78                |                  | 68'40                  | 72'06                | 73'10                  | 73'83                | 49'05                  | 46'05                | 61'24                | 66'26                |
| 79                | Min.             | 76'42                  | 77'89                | 74'30                  | 72'79                | 47'11                  | 52'55                | 65'43                | 69'67                |
| 80                |                  | 88'84                  | 73'57                | 70'98                  | 71'91                | 61'50                  | 52'77                | 82'34                | 71'16?               |
| 81                |                  | 55'44                  | 70'96                | 70'45                  | 63'83                | 49'69                  | 54'98                | 65'72                | 67'02                |
| 82                |                  | 68'60                  | 60'64                | 50'06                  | 61'21                | 53'75                  | 45'49                | 52'99                | 63'07                |
| 83                |                  | 57'87                  | 61'91                | 63'12                  | 57'04                | 33'04                  | 47'43                | 70'50                | 60'12                |
| 84                | Max.             | 59'26                  | 58'01                | 57'95                  | 55'05                | 55'51                  | 44'13                | 56'88                | 56'87                |
| 85                |                  | 56'90                  | 58'67                | 44'08                  | 61'61                | 43'98                  | 47'63                | 43'22                | 62'31                |
| 86                |                  | 59'86                  | 69'12                | 82'81                  | 65'30                | 43'39                  | 45'05                | 86'82                | 64'71                |
| 87                |                  | 90'61                  | 73'71                | 69'01                  | 73'64                | 47'78                  | 44'95                | 64'09                | 72'12                |
| 88                |                  | 70'66                  | 77'79                | 69'09                  | 71'67                | 43'68                  | 45'23                | 65'44                | 67'77                |
| 89                | Min.             | 72'11                  | 72'31                | 76'92                  | 66'18                | 44'23                  | 53'83                | 73'79                | 74'04?               |
| 90                |                  | 74'15                  | 70'23                | 52'53                  | 65'25                | 73'59                  | 50'27                | 82'90                | 70'14                |
| 91                |                  | 64'42                  | 74'42                | 66'30                  | —                    | 33'00                  | 52'20                | 53'74                | 75'93?               |
| 91                |                  | 84'70                  | 74'03                | —                      | —                    | 50'01                  | 40'51                | 91'14                | —                    |
| 1892              |                  | 72'98                  | —                    | —                      | —                    | 38'53                  | —                    | —                    | —                    |

The Barbados rainfall was discussed by Sir Rawson W. Rawson in 1873,<sup>1</sup> and indeed it neither was, nor yet is easy to make out the connection between the years 1843 and 1863; but since 1863 it is all plain sailing, especially when aided by Jamaica on one side and Antigua on the other.

I have written to Mr. Hart, the superintendent of the Botanic Gardens, Trinidad, asking him to assist me in getting the Trinidad rainfall into better form.

MAXWELL HALL.

<sup>1</sup> NATURE, vol. viii. pp. 245, 247; vol. x. p. 263; and vol. xi. p. 327.

favour of technical education. As a fact, they had been much less affected than the institutions above and below them, and probably in consequence of the recognised absence of organisation. It might be that the Royal Commission about to be appointed would introduce order into this chaos, and that when each school knew exactly its position in the school hierarchy—its relation to the schools above and below it, and the special and particular purpose it was required to serve—our intermediate schools, both first and second grade, would become more efficient than they now were in preparing the way for that

technical education which, in every branch of professional and commercial life, was being recognised as indispensable.

In the New Education, the most important subject of instruction was science. It was the development of science, and its application to the varied work of life, that had changed to a great extent, and would change still more in the near future, the entire character of our school teaching. In an address given in 1876, Sir Philip remarking upon the inadequate attention given to the teaching of science in our endowed schools. Out of one hundred and twenty-eight schools which furnished replies to the Commissioners at that time, there were only sixty-three schools in which any kind of science was taught, and of these only thirty devoted any regular time to scientific study. Since then a great change had taken place; but the change was more marked in the elementary than in the secondary schools. And the right of science to be included in the school curriculum had only recently been generally recognised.

The advance was very satisfactory; but the important question was whether, with the increase in the number of schools in which science was taught, there had been any corresponding improvement in the *method* of science teaching?

The progress in this direction had not been as marked as one might have wished. The correct methods of science teaching were only very gradually being understood. It was largely owing to the usefulness of the information which the study of science involved, that the value of the study as a means of education had been lost sight of. It should be remembered that "acquisition of every kind has two values—value as *knowledge* and value as *discipline*"; and, in early education, the latter was by far the more important. With the first feeling of intoxication which the breathing of the atmosphere of science excited, there was a strong reaction against the teaching of subjects apparently useless, as mere instruments for mental gymnastics. There was a loud cry for useful information; and the scientific lecture, with its platform experiments, served both to awaken the interest of the pupil and to afford such information. But, gradually, better views prevailed, and it was recognised, although very slowly, that information was not the first object of science teaching, and that, valuable as was the information which science conveyed, such information was of little use unless the process of informing served to train and discipline and educate the faculties. Accuracy in thought and expression, the power of arranging and co-ordinating facts, and of acquiring, retaining, and reproducing in logical order, new ideas, and the habit of deliberation in arriving at conclusions, were educational ends of far more real value than any amount of mere knowledge which the student of science might gain. The recognition of this educational truth had rudely shaken methods of teaching, and even of examining in scientific subjects.

Herbert Spencer, in his well-known essays on Education, had said:—"It would be utterly contrary to the beautiful economy of nature if one kind of culture were needed for the gaining of information, and another kind were needed for mental gymnastics. Everywhere throughout creation we find faculties developed through the performance of those functions which it is their office to perform; not through the performance of artificial exercises devised to fit them for those functions. . . . The education of most value for guidance must at the same time be the education of most value for discipline." The method of teaching science must therefore be carefully considered, so that the training of the faculties might be steadily kept in view as the aim and object of the instruction, rather than the mere acquisition of knowledge. This change of method involved the substitution, from the very commencement, of practical work on the part of the pupil for the ordinary lecture or lesson.

At the outset, the practical exercises should be of the very simplest kind. The pupil must take nothing for granted. It was clear, therefore, that he must commence with simple exercises in measurement. In physics they were always dealing with quantities, and could not understand what is meant by a quantity except by measuring it. The first measurements to be made were those of length. In making such measurement, certain standards had to be considered, and different systems (the English and the metric systems) should be compared. These comparisons involved easy exercises in arithmetic, which might be practised in connection with such concrete examples. Various objects should be actually measured, and the length calculated by multiplication or division of other measurements. But the pupil should be made thoroughly familiar with his standard of measurement before passing away from this exercise. This should be followed by measurement of areas, the consideration

of which was fruitful in useful exercises. In country schools the actual measurement of the areas of fields, by simple methods of surveying, might be usefully attempted; in town schools there was generally a playground which would afford opportunities for similar exercises. Then the methods and results of all such measurements should be carefully and neatly transferred to paper, and the pupil should be thus incidentally exercised in elementary drawing. The measurement of volume would follow, with more varied and more difficult problems.

Immediately connected with the measurement of volume was that of mass. There, of course, a difficulty arose, owing to the close connection between *mass* and *weight*, and the difficulty of distinguishing between them. But the explanation of this difficulty might be postponed, and the pupil could be allowed to use ordinary weights as measures of mass. At this stage he was introduced to a balance, and, with a view of inducing habits of accuracy, he should at once use a fairly good balance. The exercises were very numerous which the pupil could practise with a good pair of scales. From this point the order of any elementary series of lessons could be varied at the discretion of the teacher. The balance suggested experiments, to be done by the pupil, on the use of the lever, whence the principle of the lever could be obtained. From the common balance to the Roman balance, and to other modes of weighing, the steps were very gradual. The relative volumes of bodies of the same material could then be ascertained by the balance, and former exercises in measurement be verified and repeated. The pupil should not only do the actual work himself, but should write out clearly a description of what he had done, thus learning to connect action, thought, and words. From these exercises the pupil might pass to the consideration of the difference in homogeneous bodies of the same volume and of different weight, and so on, by very easy stages, to methods of ascertaining relative weights of different substances. Exercises in finding specific gravities of solids, powders, and liquids, gave opportunity for very valuable instruction, and prepared the way for the use of instruments of precision, and for knowledge of interesting properties of different kinds of bodies. The value of these lessons consisted in the accuracy of measurement, and in the clearness and correctness of the written record, as regards the statement of facts, the sequence of reasoning, the numerical calculations, and the use of words and phrases.

It was, of course, essential that these written exercises should be carefully corrected, as are exercises in Latin or Greek composition. The aim of the instructor, in compiling such an introductory course as that suggested, should be to include those subjects, an acquaintance with which was required to enter upon the systematic study of any one branch of science, and which were practically common to all branches. The character of an introductory course might be influenced by the consideration of the special science which, in any particular school or district, would be likely to be studied, or indeed by the special taste of the instructor. A knowledge of the use of simple measuring instruments, including the thermometer, the barometer, the hygrometer, having been acquired, the pupil might pass by carefully suggested experiments to the determination of simple physical laws, and to the discovery of the composition of common substances, such as air, water, salt, lime, &c.; and it was needless to say that such exercises would open up wide views of the elementary facts and laws of different branches of science, and would prepare the way for the specialised teaching which more properly belongs to technical education.

#### UNIVERSITY AND EDUCATIONAL INTELLIGENCE.

OXFORD.—Prof. August Weismann will deliver the Romanes Lecture in the Sheldonian Theatre, on Wednesday, May 2.

Prof. H. H. Turner has selected "The International Photographic Chart of the Heavens" for the subject of his inaugural lecture as Savilian professor of astronomy, to be delivered to-morrow.

CAMBRIDGE.—The Vice-Chancellor has appointed Mr. J. W. Clark, Registrar and formerly Superintendent of the Museum of Zoology, to the office of Reader on Sir Robert Rede's foundation for the present year, in succession to Prof. Foster.

The Special Board for Medicine report that in consequence of the great increase in the number of candidates for the M.B. degree (in 1893 there were 224 to be examined), it is necessary to increase the staff of Examiners to four in Medicine and four in Surgery.

THE Somerset County Education Committee announce that three Senior County Scholarships will be offered for competition in June 1894. They will be tenable for two years in the scientific or technical department of a university college, the Royal College of Science, South Kensington, or some other college or institution approved by the County Education Committee. The annual value of each scholarship will be from £50 to £60, according to the place of instruction chosen, and, subject to the maximum limit, will be fixed at a sum sufficient to cover the cost of instruction, together with £30 per annum toward's the scholar's maintenance. The competition will be open to any boy whose parents or guardians are *bona fide* residents in the administrative county of Somerset, and who has regularly attended any secondary school (public or private) within the county for two school years preceding August 1, 1894, provided that every candidate is over 15 and under 17 years of age on July 1, 1894, and that his parents are in receipt of an income of not more than £400 a year from all sources. Six intermediate County Scholarships will also be offered for competition in June 1894. They are of the annual value of £30, and will be tenable for two years at some public secondary school approved for the purpose by the County Committee.

### SCIENTIFIC SERIALS.

*American Journal of Science*, February.—On the chemical composition of staurolite, and the regular arrangement of its carbonaceous inclusions, by S. L. Penfield and J. H. Pratt. A careful analysis of several specimens gave the formula  $\text{HAL}_6\text{FeSi}_2\text{O}_{13}$ , which may be written as a basic ortho-silicate. The aluminium is partly replaced by ferric iron, and the ferrous iron by magnesium and manganese. Basal sections of the rhombic prism show the carbonaceous inclusions to be disposed in the form of a rhombus parallel to the outline, with the corners joined together. This figure develops into a simple cross towards the centre, whereas towards the ends the rhombus widens out until it coincides with the outline. This proves that the inclusions are arranged in the surface of a double pyramid with its apex in the centre, and also in planes joining the edges of this pyramid with those of the prism.—Additional species of pleistocene fossils from Winthrop, Mass., by R. E. Dodge. Three more species of preglacial shells have been found in the drumlin in Boston Harbour, known as Winthrop Great Head. They are *Lunaticus Greenlandica*, Stimpson, *Saptharca transversa*, Adams, and *Buccinum undatum*, Linné. These fossils give additional evidence of the higher temperature of Massachusetts Bay in pre-glacial as compared with the present time.—On the basalts of Kula, by H. S. Washington. These basalts occur near Kula, about 125 km. east by north of Smyrna, where they form cones and streams of a fresh and unaltered appearance. The lavas are to be classed as hornblende-plagioclase basalts, distinguished by the constant presence and great relative quantity of the hornblende, its peculiar magmatic alteration, the small quantity of both plagioclase and olivine, and the large amount of glass basis. The name *Kulaita* is proposed for them.—The fishing banks between Cape Cod and Newfoundland, by Warren Upham. If a portion of the continental border from Cape Cod to the Grand Bank south east of Newfoundland could be uplifted, we should behold nearly as much diversity of valleys, ridges, hills, plateaus, and all the forms of subaerial land erosion, as is exhibited by any portions of the adjacent New England states and eastern provinces of Canada. The submerged channels of our let from the Gulfs of Maine and St. Lawrence, and the less profound valleys that divide the fishing banks from each other, prove that this region during a comparatively late geological time was a land area, its maximum elevation being at least 2000 feet higher than now.

*Bulletin of the New York Mathematical Society*, vol. iii. No. 4, January.—“Modern Mathematical Thought,” the presidential address, delivered by Prof. Newcomb, before the New York Mathematical Society (pp. 95-107), has been printed in our columns (see NATURE, vol. xlx. pp. 325-329). “Recent Researches in Electricity and Magnetism” (pp. 107-111) is a review, by G. O. Squier, of Prof. J. J. Thomson's “Notes.” The reviewer feels assured that this “supplementary” volume will take its proper place beside Maxwell's great treatise in the library of every true student of electrical science. “Notes” and “new publications” occupy pp. 112-118.

### SOCIETIES AND ACADEMIES.

LONDON.

**Physical Society**, February 9.—Annual general meeting. Prof. A. W. Ricker, F.R.S., President, in the chair.—The annual report of the Council was read by the President. Dr. Atkinson read the Treasurer's Report, and also an obituary notice of the late Prof. Tyndall. The adoption of the Reports was moved by the President, and carried *nem. con.* Dr. Chichester Bell and Mr. Griffiths were appointed scrutators, and subsequently declared the following gentlemen duly elected to form the new Council:—President, Prof. A. W. Ricker, F.R.S. Vice-Presidents: Walter Baily, Major-General E. R. Festung, F.R.S., Prof. J. Perry, F.R.S., Prof. S. P. Thompson, F.R.S. Secretaries: H. M. Elder, 50 City Road, E.C., and T. H. Blakesley, 3 Elliot Hill, Lewisham, S.E. Treasurer: Dr. E. Atkinson, Porteshery Hill, Camberley, Surrey. Demonstrator: C. Vernon Boys, F.R.S., Physical Laboratory, South Kensington. Other members of Council: Shelford Bidwell, F.R.S., W. E. Sumpner, Prof. G. Fuller, J. Swinburne, G. Johnstone Stoney, F.R.S., R. E. Baynes, Prof. G. M. Minchin, L. Fletcher, F.R.S., Prof. O. Henrici, F.R.S., Prof. S. Young, F.R.S. Prof. Reinold proposed a hearty vote of thanks to the Lords of Committee of Council on Education, for the use of the rooms and apparatus in the Royal College of Science. This was seconded by Prof. J. V. Jones, and carried unanimously. Votes of thanks were similarly accorded to the auditors, Mr. A. P. Trotter and Mr. R. Inwards, on the motion of Mr. Watson, seconded by Prof. Fuller; and to the officers of the Society, on the motion of Dr. Barton, seconded by Mr. Trotter. At an ordinary science meeting then held, Mr. Owen Glynn Jones read a paper on the viscosity of liquids, and exhibited the apparatus used in his experiments. The method employed consists in measuring the speed at which a small sphere travels through the liquid under the action of gravity. As Prof. Stokes had shown, the velocity of a sphere falling in an infinite liquid becomes constant, this velocity being given by the equation

$$V = \frac{2}{9} \frac{g a^2 (\sigma - \rho)}{\mu}$$

where  $a$  is the radius of the sphere,  $\sigma$  its density,  $\rho$  the density of the liquid, and  $\mu$  its viscosity. If sliding friction exists between the sphere and liquid, the equation becomes

$$V = \frac{2}{9} \frac{g a^2 (\sigma - \rho) \beta a + 3\mu}{\mu \beta a + 2\mu}$$

where  $\beta$  is the coefficient of friction. In making the experiments, small spheres (usually of mercury) were allowed to fall through a burette containing the liquid, and the time taken to travel the distance between two marks about 50 c.m. apart noted. The radii of the spheres being small, it was considered better to deduce this from the mass. Direct determination of such small masses being difficult, a larger mass ( $M$ ) was taken, weighed, and divided in 10, say, ten or twelve parts, and the speed of falling of each part observed in a liquid of constant viscosity. The velocity  $V$ , with which a sphere containing the whole mass would have fallen, was deduced from the equation

$$V^2 = \Sigma v^2.$$

Similarly, the mass of any part which falls with a velocity  $v$  is given by

$$m = \left( \frac{v}{V} \right)^2 \cdot M.$$

In this way the author had been able to determine the mass of a sphere weighing only about 0.003 grammes to four significant figures. Referring to experiments made with a view to ascertaining whether sliding friction existed, the author said the divergence from the simpler formula did not exceed experimental errors. In determining viscosity, changes of temperature were found to be of great importance, especially in the case of glycerine, whose viscosity varies as much as 10 per cent. for 1°C. Small differences of temperature between different parts of the liquid are, however, not very serious, provided the mean temperature be known, for the mean speed observed is shown to be that corresponding to the mean temperature. To determine viscosity accurately at a given temperature, very delicate thermometers must be employed. Mos

of the liquids experimented on were bad conductors of heat, and hence required considerable time for the temperature to become uniform. Differences in temperature could readily be detected by observing if the speed of descent of a small sphere varied at different parts of its path. The author suggested that this fact might be used to determine the thermal conductivity of liquids heated at the top by Forbes' method. The falling sphere would form a thermometer of almost infinitesimal thermal capacity. For most oils, spheres of water coloured with eosin could be employed to determine the viscosity. A water-drop of 1 mm. radius was found to fall one inch per hour in castor oil at 8° C. To determine the variation of viscosity with temperature a special apparatus was used, with which observations could be made in rapid succession by simply inverting the tube containing the liquid and the falling sphere. In Mr. Trouton's viscosity experiments, which were somewhat analogous to those described, surface tension complicated the results considerably; the author's aim had been to eliminate such disturbing influences. Prof. Everett, in a written communication, suggested that the motion of the liquid spheres be checked by using beads of quartz or glass. Lord Rayleigh pointed out, in a letter, that the formula employed related to a solid sphere, and thought it not legitimate to use it for liquid spheres, for the tangential forces at the surface would set the interior liquid in relative motion, and modify the resistance experienced. He also thought the existence of a finite coefficient of sliding friction between two fluids an impossibility. Mr. Watson said temperatures might be kept constant for days together by Ramsay and Young's vapour jacket. Dr. Sumpner thought the surface tension of such small spheres of mercury was so very large that they would act practically like solids. The want of solidity might be of importance when the two liquids were very nearly alike in density and other properties. Mr. Blakesley said that at high velocities the falling sphere might get a palpitating motion, in addition to the gradual descent, and this might introduce errors. Prof. Perry considered that the experiments on the velocity of a small sphere, and those of the two parts in which it was divided, which showed that  $V^2 = v_1^2 + v_2^2$  proved the simple formula used to be correct. Mr. Boys inquired if any tests had been made on the constancy of dimensions of the spheres used. He would expect that in the case of water and oil, for example, that mutual contamination would take place. Speaking of the indirect method of determining the masses of small spheres, he thought direct weighings might be made, for, as the President and Prof. Poynting had shown, the balance might be immensely improved. Prof. S. P. Thompson suggested that small globules of aluminium or slag might be used. Dr. C. V. Burton thought Lord Rayleigh's criticism important, and that large corrections might be necessary. He failed to see how the large surface tension mentioned by Dr. Sumpner could prevent internal circulation. Mr. Trotter said Lord Rayleigh's point might be tested by using a sphere of oiled wax. Mr. Boys mentioned that Lord Rayleigh had shown in the case of soap rings that variation of surface tension due to stretching or compression produced stability. The same phenomena would probably retard internal circulation. The President said there was little doubt that internal circulation, as mentioned by Lord Rayleigh, would modify the velocity. In his reply, Mr. Jones said he could not imagine how in pure liquids internal motion in the falling spheres could be set up. In answer to Mr. Boys, he had found slight changes in the masses of the water spheres after being used many times, but this was a question of days. During an ordinary series of observation the dissipation was too small to be observed. After the meeting had been adjourned, Mr. Boys and Dr. Burton considered the question of internal circulation, and the latter pointed out that with perfectly liquid spheres there would be infinite slip, and the coefficient of sliding friction  $\beta$  would be zero. The velocity of descent would therefore be  $\frac{2}{3}$  times that given by the first equation.

Geological Society, February 7.—W. H. Hudleston, F.R.S., President, in the chair.—Mr. C. J. Alford, in explanation of specimens of auriferous rocks from Mashonaland exhibited by him, stated that several of them were vein-quartz occurring as segregations in the slates, generally forming veins between the cleavage-planes. Another specimen was a mass of chromate of lead, with pyromorphite and other lead minerals, occurring in masses in decomposed and dislocated talcose slate

in the Penhalonga Mine near Umtali, and probably resulting from the alteration of masses of galena by weathering, as a broken vein of galena was found in close proximity. This crocoisite was supposed to be a somewhat rare mineral, but he had found it and also the native red oxide, minium, in several places in South Africa. The most interesting specimen, was, however, a mass of diorite showing visible gold throughout the rock, an assay of which gave upwards of 130 ounces of gold per ton. From information obtained from the prospector who made the discovery, he gathered that the deposit was a dyke of diorite running for a considerable distance, about 8 feet in width, flanked on one side by granite and on the other by slates. There were extensive ancient workings extending to a depth of about 60 feet, and the prospecting shafts had not gone much below that depth, so not much information was obtainable at present. The diorite showed a development of epidote, but little or no quartz; and the gold appeared to enter in an extraordinary manner into all of the composing minerals. Mr. Alford hoped, after his next visit to Mashonaland, to be in a position to lay before the Society more definite information regarding these interesting rocks.—The following communications were read:—On some cases of the conversion of compact greenstones into schists, by Prof. T. G. Bonney, F.R.S. By the path leading from the Bernina Hospice to the Grüm Alp (Engadine) some masses of compact green schist are seen, intercalated in a rather crushed gneiss. They prove to be intrusive dykes modified by pressure. Microscopic examination of specimens from these revealed no trace of any definite structure indicating an igneous rock; a slice, cut from one of the masses within an inch or so of a junction, showed it to be a foliated mass of minute chlorite or hydrous biotite, with granules of epidote (or possibly some sphene) and of a water-clear mineral, perhaps a secondary feldspar. An actual junction showed a less distinct foliation and some approach to a streaky structure. A slide from the middle of another dyke (about 18 inches thick) exhibited a more coarsely foliated structure and minerals generally similar to the last, except that it may contain a little actinolite and granules of hematite (?), and the clear mineral, in some cases, seemed to be quartz. The structure and most of the minerals appeared to be secondary. Chemical analysis showed the rock to have been an andesite. A specimen from a third dyke was generally similar, but was rather less distinctly foliated. A somewhat similar, but rather larger intrusive mass by the side of the Lago Bianco showed more actinolite and signs of primary feldspar, with other minerals. Here the rock retained some likeness to a diabase. The resemblance of certain of these rocks to somewhat altered sediments is remarkable. The author considered the bearing of this evidence upon other and larger masses of "green schist" which occur in the Alps, and expressed the opinion that their present mineral structure may be the result of great pressure acting on more or less basic igneous rocks.—The Waldensian gneisses and their place in the Cottian sequence, by Dr. J. Walter Gregory. The lower part of the sequence of the Cottian Alps has been universally divided into three series, of which the lowest has been regarded as a fundamental (basal) Laurentian gneiss. It was the object of the present paper to show that this rock is really intrusive in character and Upper Tertiary in age. The writer endeavoured to prove this by the following line of argument:—(1) The gneiss consists of only isolated outcrops instead of a continuous band, and these occur at different positions and not always at the base of the schist series; (2) the gneiss is intrusive, because (a) it includes fragments of the overlying series instead of *vice versa*, (b) it sends off dykes of aplite into the surrounding schists, (c) it metamorphoses the rocks with which it is in contact, and (d) the schists are contorted near the junction; (3) the gneisses were further shown to be later than the igneous rocks intrusive into the "pietre verdi" series, as these never traverse the gneiss. No positive opinion as to the age of the overlying schists was expressed, though it was pointed out that the recent discovery of radiolarian muds in the series may necessitate their inclusion in the Upper Palaeozoic. The freshness of the gneisses, the fact that these have not been affected by the early Tertiary earth-movements, and the absence of authentic specimens of the gneiss in the Cretaceous, Eocene, and Miocene conglomerates, renders their late Tertiary age highly probable. The nature of the contact-metamorphism and the origin of the gneissic structure were discussed, and a classification offered of the earth-movements in the Cottian Alps. A discussion followed, in which the President, Prof. Judd, Mr. Barrow, Prof. Bonney, Mr. A. M.

Davies, Mr. Vaughan Jennings, and Dr. G. J. Hinde took part. The author briefly replied.

PARIS.

**Academy of Sciences.** February 12.—M. Lœwy in the chair.—On a theorem connecting the theory of synchronisation with the theory of resonances, by M. A. Cornu. A demonstration is given leading to the theorem: "A very-small periodic force, varying with the time according to any law capable of development by Fourier's series, is equivalent in its action on a vibrating system, damping slowly and of almost the same period, to the simple pendular force represented by the terms of the first order of the series." The general character of synchronisation is pointed out, and the necessity of considering it where resonance is an important property is insisted on.—New experiments on the production of artificial diamonds, by M. Henri Moissan.—On interior pressure in gases, by M. E. H. Amagat. The author defines interior pressure as  $\pi = \left( T \frac{dP}{dt} - P \right)$  and traces its value for carbon dioxide, ethylene, oxygen, nitrogen, air, and hydrogen. With the more perfect gases,  $\pi$  as the volume decreases first increases to a maximum, and then decreases; the maximum for hydrogen is reached at a comparatively low pressure, and  $\pi$  for this gas continues decreasing through zero to a negative value. With ethylene and carbon dioxide the maximum has not been reached.—On the time of departure for the Iceland fishery, by M. Jean Sicard.—Note on the solar observations made at the Lyons Observatory (Brunner equatorial) during the second quarter of 1893, by M. J. Guillaume.—On rectilinear congruences and on Ribancour's problem, by M. E. Cosserat.—On a characteristic property of the linear element of spiral surfaces, by M. Alphonse Demoulin.—On some points in the theory of functions, by M. Emile Borel.—On a theorem concerning harmonic functions of several real variables, by M. G. D. d'Arone.—Researches on the mode of combustion of ballistitic explosives, by M. Paul Vieille. The author has studied the character of explosions under pressure, and will publish the results in a coming paper.—On the conductivity of discontinuous conducting substances, by M. Edouard Branly. Two hypotheses appear to explain the experimental results:—(1) The insulator interposed between the conducting particles becomes a conductor by the passage of a current of high potential, and the observed phenomena characterise the conductivity of the insulating substance. (2) It may be regarded as demonstrated that it is not necessary for the particles of a conductor to be in contact to allow the passage of even a feeble electric current; the distance for which the conductivity persists depends on the energy of the anterior electrical effects. In this case, the insulator serves chiefly to maintain a certain interval between the particles.—On the fusibility of isomorphous saline mixtures, by M. H. Le Chatelier. Tables and curves are given showing the temperatures of crystallisation of varying mixtures of pairs of isomorphous salts, —  $K_2CO_3$ ;  $Na_2CO_3$ , —  $Na_2SO_4$ ;  $K_2SO_4$ , —  $K_2CrO_4$ ;  $K_2SO_4$ , —  $Na_2SO_4$ ;  $Na_2CO_3$ , —  $K_2CO_3$ ;  $K_2SO_4$ , —  $NaCl$ ;  $KCl$ , —  $KI$ ;  $KCl$ .—On the assimilation of gaseous atmospheric nitrogen by microbes, by M. S. Winogradsky.—On the antitoxic property of the blood of animals vaccinated against viper poison, by MM. C. Philaix and G. Bertrand. If viper poison be mixed with certain proportions of the defibrinated blood of an inoculated animal it fails to poison on injection.—Researches on the anatomy, and development of the female genital apparatus in lepidopterous insects, by M. A. Peytoureau.—Observations on hypermetamorphosis or hypnodia among the cantharidæ. The stage called pseudo-chrysalis, considered as a phenomenon of encystment, by M. J. Künckel d'Herculis.—Salivary glands of hymenoptera of the family of the Crabronidæ, by M. Boras.—On some parasites of the Lepidodendra of Culm, by M. B. Renault.—Observations on the character of the relationship between platinum and its mother-rock, by M. Stanislas Meunier. The author points out the agreement between the views of M. Inostranzeff (C. R. January 29) and his own previously published observations. The metallic platinum must have been deposited in the interstices of peridotite masses by the interaction of hydrogen and platonic chloride vapours at a red heat, much below the temperature of fusion of the rock.—On a bed of apophyllite in the environs of Collo (Algeria), by M. L. Gentil.—Eruption of the volcano Calbuco, by M. A. F. Nogués.—Remarks on the earthquakes in the island of Zante during 1893, by M. A. Issel.

BOOKS, PAMPHLETS, and SERIALS RECEIVED.

**BOOKS.**—The Student's Introductory Handbook of Systematic Botany: J. W. Oliver (Blackie).—A School Course in Heat: 5th edition: W. Larden (S. Low).—Remarkable Comets, 2nd edition: W. T. Lynn (Stanford).—Celestial Motions, 8th edition: W. T. Lynn (Stanford).—The Voices of the Stars: J. E. Walker (Stock). The Universal Electrical Directory, 1894 (Alabaster).—Barnes's Handy Assurance Directory, 1894: W. Schooling (London).—Social Evolution: B. Kidd (Macmillan).—Manures and the Principles of Manuring: C. M. Aikman (Blackwood).—Société d'Encouragement pour l'Industrie Nationale Annuaire pour l'Année 1894 (Paris).—A Memorial Work, chiefly on Botany and Zoology, in Commemoration of the Ninetieth Anniversary of Keisuke Ito, 2 vols.: T. Ito (Nagoya, Japan).  
**PAMPHLETS.**—Imitation: a Chapter in the Natural History of Conscience: Prof. J. M. Baldwin.—Stonyhurst College Observatory. Results of Meteorological and Magnetical Observations, 1893 (Cithæros).—Erinnerung an Eilhard Mitscherlich, 1794-1861 (Berlin).—Guide to the Examinations in Elementary Agriculture and Answers to Questions, Elementary Stage, 1884-93 (Blackie).—The Internal Work of the Wind: S. P. Langley (Washington).—Revision of the Japanese Species of Pedicularis, L.: T. Ito (Nagoya, Japan).—Note on the Burmanniaceæ of Japan: T. Ito (Nagoya, Japan).—The Development of the Skeleton of the Limbs of the Horse: Prof. J. C. Ewart.  
**SERIALS.**—Journal of the Chemical Society, February (Gurney and Jackson).—Mémorial and Proceedings of the Manchester Literary and Philosophical Society, 1893-4. Vol. xviii. No. 1 (Manchester).—Botanische Jahrbücher für Systematik, Pflanzengeschichte und Pflanzengeographie, Achtehster Band, 1 and 2 Heft (Williams and Norgate). Brain, part 6 (Macmillan).—Engineering Magazine, February (New York).—Medical Magazine, February (Southwood).—Verhandlungen der Gesellschaft für Erdkunde zu Berlin, Band xx. No. 10 (Berlin).—American Journal of Mathematics, Vol. xvii. No. 1 (Baltimore).—Proceedings of the Royal Society of Edinburgh, Session 1892-3. Vol. xx. pp. 97-160 (Edinburgh).—Transactions of the Royal Society of Edinburgh, Vol. xxxvii. parts 1 and 2 (Edinburgh).—Himmel und Erde, February (Berlin).—Buletino della Società Geografica Italiana, Serie 3, Vol. 6, fasc. 10 and 11 (Roma).—Indian Museum Notes, Vol. vii. No. 7 (Calcutta).—Journal of the Asiatic Society of Bengal, Vol. lvi. part 2. No. 3 (Calcutta).—Journal of the Anthropological Institute, February (K. Paul).—Harvard University Bulletin, January.—American Meteorological Journal, February (Ginn).

CONTENTS.

PAGE

|                                                                                                                                                        |     |
|--------------------------------------------------------------------------------------------------------------------------------------------------------|-----|
| Boltzmann on Maxwell . . . . .                                                                                                                         | 381 |
| The Story of the Sun. By A. Fowler . . . . .                                                                                                           | 382 |
| The Lepidoptera of the Atlantic Islands. By W. F. Kirby . . . . .                                                                                      | 384 |
| The Active Principles of Plants . . . . .                                                                                                              | 385 |
| Our Book Shelf —                                                                                                                                       |     |
| Zacharias: "Forschungsberichte aus der Biologischen Station zu Prön."—F. W. G. . . . .                                                                 | 385 |
| Hitler: "Biology as it is applied against Dogma and Freewill, and for Weismannism."—P. C. M. . . . .                                                   | 386 |
| Glazebrook: "Heat: an Elementary Text-Book, Theoretical and Practical, for Colleges and Schools" . . . . .                                             | 386 |
| Bonney: "Electrical Experiments" . . . . .                                                                                                             | 386 |
| Letters to the Editor:                                                                                                                                 |     |
| On M. Mercadier's Test of the Relative Validity of the Electrostatic and Electromagnetic Systems of Dimensions.—Prof. Arthur W. Rücker, F.R.S. . . . . | 387 |
| The Cloudy Condensation of Steam.—Shelford Bidwell, F.R.S. . . . .                                                                                     | 388 |
| On the Cardinal Points of the Tusayan Villagers.—J. Walter Fewkes . . . . .                                                                            | 388 |
| The Scandinavian Ice-sheet.—Prof. T. G. Bonney, F.R.S. . . . .                                                                                         | 388 |
| The Nomenclature of Radiant Energy.—Prof. A. N. Pearson . . . . .                                                                                      | 389 |
| The Foundations of Dynamics. By Prof. A. Gray . . . . .                                                                                                | 389 |
| An Incident in the Cholera Epidemic at Altona. By Prof. Percy Frankland, F.R.S. . . . .                                                                | 392 |
| Notes . . . . .                                                                                                                                        | 392 |
| Our Astronomical Column:—                                                                                                                              |     |
| Sun-spots and Magnetic Disturbances . . . . .                                                                                                          | 397 |
| Stonyhurst College Observatory . . . . .                                                                                                               | 397 |
| The "Annuaire" of the Bureau des Longitudes . . . . .                                                                                                  | 397 |
| The Spectrum of Nova Normæ . . . . .                                                                                                                   | 397 |
| The Smithsonian Institution Report . . . . .                                                                                                           | 397 |
| The Greenland Expedition of the Berlin Geographical Society . . . . .                                                                                  | 399 |
| The Sun-spot Period and the West Indian Rain-fall. By Maxwell Hall . . . . .                                                                           | 399 |
| On Preparing the Way for Technical Instruction. By Sir Philip Magnus . . . . .                                                                         | 400 |
| University and Educational Intelligence . . . . .                                                                                                      | 401 |
| Scientific Serials . . . . .                                                                                                                           | 402 |
| Societies and Academies . . . . .                                                                                                                      | 402 |
| Books, Pamphlets, and Serials Received . . . . .                                                                                                       | 402 |



THURSDAY, MARCH 1, 1894.

THE REPORT OF THE GRESHAM UNIVERSITY COMMISSION.

THE "Report of the Commissioners appointed to consider the Draft Charter for the proposed Gresham University in London, together with Dissident and other Notes," is a document of sixty-three pages full of important matter from beginning to end. It bears evidence of very careful thought, and is worth attentive study.

The Commissioners accept at once two principles, both of which were included in, and one of which was peculiar to, the scheme of the Association for promoting a Professorial University in London.<sup>1</sup> They lay it down that there should be one University only in the metropolis, and that the changes which they recommend should be effected not by Charter, but by legislative authority, and by the appointment of a Statutory Commission. They thus adopt the only satisfactory theoretical solution of the problem, and the only possible way of putting theory into practice. Every one is tired of the game in which the shuttlecock is tossed backwards and forwards from the University to the Colleges, from the Senate to Convocation. London and learning cannot wait indefinitely. The time has come when Parliament must arbitrate between conflicting views and interests.

The Commissioners also decide that the same University is capable of carrying on simultaneously systems of internal and external examinations, though Prof. Sidgwick has thought it right to express his disapproval of this conclusion.

They further propose that the scope of the University shall be enlarged in respect both of the subject-matter and the method of its teaching, so as to include six Faculties, viz. Arts, Science, Medicine, Law, Theology, and Music.

The first two of these are, of course, fundamental, and we hope that even if difficulties should arise with regard to the others, the foundation of a Teaching University in London, with the Faculties of Arts and Science only, will not thereby be prevented. If the existing University and the institutions of University rank which are chiefly interested in Arts and Science can be united, a most important result will have been achieved. The law of gravitation will in time do the rest.

We shall, therefore, confine ourselves chiefly to the proposals of the Commissioners with respect to Arts and Science, but a mere recapitulation of their recommendations would be of little interest unless the points of agreement with or divergence from previous schemes were indicated.

We propose, then, in the first instance to institute a comparison between the scheme of the Commissioners and three of the more important proposals which have been made in the course of the long discussion as to the best constitution for a Teaching University in one of the metropolis. The abortive Gresham Scheme may at once be put on one side. Its authors aimed at founding a

second University in London. Everyone now agrees that there should be one only. The schemes which we select for our purpose are (1) the so-called Revised Scheme, which was approved by the Senate but rejected by the Convocation of the University of London; (2) the scheme approved in 1893 by Convocation; and (3) the Association Scheme.

The "Revised Scheme" and that of Convocation differ from the others in that their authors contemplate the possibility of the University having direct relations with educational institutions outside the metropolitan area. As it is probable that the teaching operations of the new University will be confined to London, we shall pass over this point without further reference.

The Association and Convocation agree in fashioning the University out of materials which closely correspond to the "Chancellor, Masters, and Scholars" of our older seats of learning. On the other hand, the Revised Scheme and that of the Commissioners make a beginning with such bodies as the Senate, Convocation, &c. The matter is not of fundamental importance, but it is necessary to refer to it as the phrase "*the University shall consist of*" is applied in different ways.

Putting this difference aside, the government of the University is distributed among various bodies named as follows:—

| Revised Scheme       | Convocation      | Association   | Commissioners    |
|----------------------|------------------|---------------|------------------|
| Senate               | Senate           | Court         | Senate           |
| Convocation          | Convocation      | Convocation   | Convocation      |
| Constituent Colleges | Professoriate    | Professoriate | Academic Council |
| Faculties            | Faculties        |               | Faculties        |
| Board of Studies     | Board of Studies |               | Board of Studies |

In what follows we shall use the word Senate to designate the Supreme Governing Body of the University. Its constitution under the different schemes is as follows:—

| Nominated or Elected by                  | Revised Scheme | Convocation | Association | Commissioners |
|------------------------------------------|----------------|-------------|-------------|---------------|
| Crown . . .                              | 10             | 8           | 15          | 3             |
| Ministers . . .                          | —              | —           | —           | 5             |
| Convocation . . .                        | 10             | 12          | 3           | 9             |
| Institutions representing:               |                |             |             |               |
| (a) Medicine . . .                       | 4              | 2           | —           | 5             |
| (B) Law . . .                            | 2              | 2           | —           | 6             |
| (γ) Applied Science . . .                | —              | —           | —           | 4             |
| (δ) Pure Science . . .                   | —              | —           | —           | 2             |
| (ε) Education . . .                      | 10             | 2           | —           | 5             |
| Corporation, County Council, &c. . .     | —              | 4           | 4           | 4             |
| Teachers in University or Colleges . . . | 16             | 10          | 25          | 22            |
| Nominated by Senate itself . . .         | —              | —           | 4           | —             |
| Total . . .                              | 52             | 40          | 51          | 65            |

It will be observed that while but slightly reducing the absolute number of members claimed by Convocation

<sup>1</sup> This will be hereafter referred to as the Association Scheme.

and the Association for the interests with which they are specially connected, the relative importance of the representation of the graduates and the Professors has been reduced by the Commissioners.

The reduction has been about in the proportion of one-third to one-seventh in the case of Convocation, and one-half to one-third in the case of the Teachers.

We are inclined to think that Convocation is still over-represented, and should have been glad to see the principle admitted that half the entire Senate should consist of Teachers in the University. As far as these numbers are concerned, however, we accept the decision of the Commissioners as that of a body of men who have weighed most carefully the evidence submitted to them, and have evidently tried to do impartial justice.

A mere numerical comparison, such as the foregoing, does not, however, show all the points of difference between the schemes. The most fundamental divergence is in the proposed relations between the University and the chief Educational Institutions which already exist in London.

The Revised Scheme contemplated the establishment of Constituent Colleges, that is, institutions which the University recognised as giving teaching of University rank in some or all branches of learning. The Teachers in the Constituent Colleges who were thus recognised by the University were grouped into Faculties, to which bodies certain powers and privileges were given.

Over and above this the Senate was to have the power of entering into arrangements with any Constituent College by which it approved certain courses of study given in the College, accepted certificates of attendance at such courses, recognised special examinations conducted in the College by a College Professor and an *adjoint* Examiner appointed by the Senate, and gave Degrees to candidates who attended the specified courses and passed the special examinations. A Standing Committee of the Senate was to co-operate with the Constituent Colleges in the organisation and improvement of University Teaching in and for London, "including the establishment of Professorships." Inasmuch, however, as the Faculties were to consist of Teachers of the Constituent Colleges only, and no provision was made for the admission to them of University Professors who were not connected with a Constituent College, it would appear that the University itself was not to be a Teaching Body.

As far as the Colleges are concerned, this was in effect the plan which has worked successfully in the Victoria University. The Colleges were to be independent, to appoint their own Professors, to find their own funds. If they succeeded they were to be recognised, and to share in the government of the University. Success would depend in part on the number of their students. Hence they were to be rivals, but the University would neither help nor hinder them. Equal privileges could be won by all. They would be impartially withdrawn from those who failed. The idea of recognising special examinations to suit special needs was an advance, and a very important advance, on the scheme of the Victoria University. A fundamental difference between the two Universities would, however, have been that, whereas the Victoria University can only give Degrees to candidates who have

passed through a College of the University, the University of London would have been able to give Degrees to all-comers, as well as to make special arrangements for students in Constituent Colleges.

The scheme of Convocation went a step further. It contemplated the possession by the University of independent laboratories, and therefore of a teaching staff of its own. It also proposed that Professorial Chairs in other Institutions should be endowed by the University on condition "that the appointment to such Chairs whenever a vacancy occurs should pass to the University." It was not stated whether the Professor so appointed should be subject to the University only, or whether he should be under the partial or exclusive control of the Governing Body of the College in which he worked. The Professorial Scheme was very similar. Every Professor of the University was to be appointed and paid by the University, and a Statutory Commission was to make arrangements with existing Institutions for complete or partial incorporation.

The Commissioners propose that certain Institutions, or departments in Institutions, shall be recognised as Schools of the University. The teachers in these Schools must be individually approved to secure a University *status*. The principle laid down by the Professorial Association, that Teaching Institutions as such are not to be represented on the Senate, is accepted, and thus the Constitution of the University is not in theory federal. On the other hand, places on the Senate are allotted to University College, King's College, the Royal College of Science, and the City and Guilds of London Institute, "regarded as important and wealthy public Corporations, or Societies, having and exercising wide educational aims and powers in connection with University education in London." The distinction is rather a fine one, but we gather that in the Commissioners' opinion King's College ought to have two representatives on the Governing Body, even if some theological difficulty led to its refusing to accept the position of a School of the University. The Commissioners decline to accept the idea either of immediate or of ultimate absorption of Educational Institutions as the basis of the University. But even if this is so, we think that they have gone too far in allotting a definite number of representatives to certain Teaching Institutions which happen at the moment to be the most important in London. The very existence of the Royal College of Science depends on the will of a Minister. We suppose that the City and Guilds Institute would collapse if the subventions it receives from the City Companies were withdrawn. The Commissioners themselves would surely be unwilling to throw any obstacles in the way of the complete absorption of University College by the University if in twenty years time it should itself desire it. Yet as matters stand any such change would involve a change in the Charter. It would surely be better to allot six representatives to the Governing Bodies of important Educational Institutions to be distributed in the first instance as the Commissioners propose, with the condition that the Senate may from time to time revise the list, subject to an appeal to the Privy Council. This at all events would secure greater flexibility. It is also possible that the Senate might

delegate the government of institutions founded by the University to committees like the Kew Committee of the Royal Society, and, subject always to the approval of the Privy Council, there seems no reason why, if the number of independent Teaching Colleges were diminished, the places of their representatives should not be occupied by experts chosen from among the members of such Committees.

Among the Institutions which the Commissioners think should be at once admitted in whole or in part as Schools of the University, those which would be chiefly concerned with the Faculties of Arts and Science are the following :

University College.

King's College.

The Royal College of Science.

The City and Guilds of London Institute.

Bedford College.

And six Theological Colleges.

The University is to be able to appoint Professors and to found Teaching Institutions of its own, and it is also to have the power "to allocate funds for the enlargement and assistance of the teaching staff of recognised institutions, the extension of their buildings, the improvement of their equipment for teaching and research, and the endowment of University Professors, Readers, Lecturers, Demonstrators, or assistants, or for other purposes in connection with such institutions." It is to be "understood that in these cases the University will impose such terms and conditions as will secure to it a reasonable and proper amount of control over the educational resources thus provided, and will have the power of determining the duties of the University Chairs which it establishes or subsidises in any institution, and of regulating the fees payable for attendance on the lectures." "But," the Commissioners continue, "we do not think it necessary to lay down any rules which would fetter the discretion of the University in this matter. We take it for granted that it will be the endeavour of the University and of the institutions to organise a homogeneous system of University education, to utilise, to combine, and to economise existing resources to their fullest extent, and to supplement them in such a mode as will best serve the progress of knowledge."

In spite of this optimistic view of the future, it may be feared that the financial relations between the Colleges and the University will be difficult to adjust. Indeed, there are several points on which the Government will have to decide before putting the scheme into operation.

The University will have to be endowed by State or Municipal funds, if it is to be able either to subsidise or to add to the number of Colleges. If no such funds are provided, the state of things contemplated in the Revised Scheme will, in effect, be realised. The Colleges will be peculiarly independent of the University, and since the University is to have no power of control except in return for subsidies, it will only be able to influence the "Schools" indirectly by visitation and by prescribing courses of study for the Degrees.

The Commissioners, however, evidently contemplate the large endowment of the University by the State. In this case it may have a more important part to play; but unless the control it claims in return for subsidies is

sufficiently great to act as a deterrent, there will certainly be an undignified scramble for funds among the Colleges. It will be a miserable ending to the long controversy if the University is to be merely the guardian of a Government Grant fund, doling out one paltry sum here to build a second-rate laboratory, and forthwith bound to match it by another grant there, just to show that, like Justice, it is blind.

If the University establishes on a German scale a laboratory of its own, chiefly intended for post-graduate study, there will be an outcry against divorcing teaching from research. If it selects one existing Institution as that with which the laboratory is to be connected, it will be held to be neutralising the public-spirited efforts of the promoters of the others. If it tries to level up all round, it will achieve nothing really great. We do not say that such results must necessarily follow from the realisation of the scheme of the Commissioners, but the Commissioners themselves appear to have thought that the only way out of the difficulty was to appeal to the good feeling and good sense of all concerned. It is evident that the future of the University largely depends upon whether their appeal is successful, and upon the action of the Statutory Commissioners when appointed.

It might be possible to establish "spheres of influence" in the territory of Knowledge as well as in the Dark Continent. But whatever device be adopted, it cannot be made too clear that the Commissioners leave to the Statutory Commission and to the University itself the solution of the most difficult problems connected with its establishment. The character of the University will largely depend upon its relations with the Colleges, and their relations have yet to be defined.

We do not point to this "lacuna" in a spirit of adverse criticism. As nothing is known about the funds and resources the University will possess, it would probably have been useless for the Commissioners to have made detailed suggestions. But it is all-important that those who have most knowledge and experience in educational matters should agree upon some scheme more subtle than the suggestion that Colleges, like savages, should adhere to the good old rule—

"That he should take who has the power,  
And he should keep who can."

The relations of the Colleges and of the Teachers to the University are so intertwined that it is difficult to separate them. In what has been said, however, stress has chiefly been laid upon the former. We now turn to the position of the Teachers in the University.

The Association Scheme insisted that every Professor of the University should be "appointed and paid by the University." The Commissioners state that this "restricts within a narrower area than any other scheme which has been proposed to us the class of teachers who are permitted to share in the Government of the University." It is doubtful whether this was the intention of those who framed the Association Scheme. They undoubtedly desired that the University should be a Teaching University, and not merely a body with funds to be exploited by Teaching Colleges. Their proposal, therefore, was that all Professors teaching in the name and on behalf of the University should be directly responsible to it, and should therefore be paid by the

University, whether the ultimate sources of their emoluments were provided by it or by a College. The regulation was probably intended to indicate a *status*, and not to restrict the number of those who attained it, and we hope it will be incorporated in the final scheme. But if this is so, it must be admitted that the Association's proposal is open to the second criticism which the Commissioners pass upon it. It created, they say, a single and undivided assembly of Teachers, on which, though in subordination to the Court, it conferred not only deliberative and consultative, but executive powers in matters which must necessarily involve much detailed and constant supervision.

In opposition to this the Commissioners group the Teachers into Faculties, and allow them to elect a very important body to be called the Academic Council. It is to consist, in addition to the Vice-Chancellor, of fifteen members, chosen as follows: Arts 4, Science 4, Medicine 3, Law 2, Theology 1, Music 1. The term of service is to be four years. Six to be a quorum. To this body will be entrusted the duty of regulating, subject to the Ordinances of the University, the teaching, examinations, and discipline of the University, and of determining what Teachers in any school of the University shall be recognised as University Teachers, and to what Faculties they shall be assigned.

In addition to these executive functions, it will be its duty to advise the Senate upon the affairs of the University, and particularly upon the assignment of funds for the erection or extension of buildings and the provision of teaching or equipment in connection with admitted Institutions or otherwise, and upon a number of similar points.

It is evident that by the establishment of this Council the Commissioners are prepared to give power to the Teachers of the University with no ungrudging hand. They assume that seats on the Academic Council will be held only by men of unquestioned reputation and experience, whose views will command the respect of the Senate. The Council is given very wide executive powers and the right to advise on matters of the utmost delicacy and importance. The only difficulty that we see is the possible intervention of College jealousy. It will be all-important that the men who are chosen shall be not only eminent in their own lines of work, but fair-minded and possessed of administrative powers. If once the easy expedient of taking turns is adopted, or if Professors working in University institutions are boycotted in favour of those connected with Colleges, or *vice versa*, the Academic Council will be a failure. These considerations will probably suffice to prevent such evils arising; and if so, we think it possible that the Academic Council of the future University of London may develop into a body of the utmost importance, and that its views may acquire an authority which would never be attained by the decisions of a large assembly, many of the members of which would necessarily be comparatively unknown men. It will thus be seen that the Teachers of the University are to share in its government in two different ways. First, they are in their Faculties to elect one-third of the members of the Supreme Body or Senate; secondly, they are to elect fifteen of their number to form an Academic Council with wide execu-

tive and advisory powers. It only remains to add that machinery is also provided by which this Council is to be kept in touch with the main body of the Teachers. For this purpose Boards of Studies are to be appointed, the number and composition of which are to be determined by the Academic Council, with the proviso that not less than three-fourths of any Board are to be elected by the Faculty to which it belongs, and the remainder (if any) appointed by the Academic Council. These Boards are to have advisory powers, and it is laid down that no rule should be made with regard to or change effected in the curricula unless it has either been recommended by the Board or Boards of Studies of the Faculty concerned, or has been submitted to them by the Academic Council for consideration. It is also provided that in dealing with the courses of study to be pursued at any Institution it is reasonable that the Academic Council should first consult the authorities of the Institution. In neither case, however, is the Academic Council bound to conform itself to the view expressed by the bodies which it consults.

Such then, in general outline, is the scheme for the government of the new University proposed by the Commissioners.

It is in many respects bold and drastic. The existing Senate of the University of London is swept away. Thus, and in our opinion very rightly, it is made clear that the carrying into effect of the scheme of the Commissioners would be an absolutely new departure. It would be preceded by the complete dissolution of the Governing Body of the present University, no single member of which might find a place in the new order of things.

The Association, or some members of it, no doubt desired that a similar act of renunciation should precede the admission of a College to the University. Had this desire been fulfilled the whole problem would have been simplified, and the chances of success enormously increased. It is still possible for the Government to set the example in the case of the Royal College of Science. University and King's Colleges are, however, the results of private effort. It would have been sheer confiscation to compel their Governing Bodies to resign their functions, though we believe that if they had sufficient confidence in the scheme proposed by the Commissioners to do so, their last service to learning and to education would surpass all the good work they have done in the past. Assuming, however, that they continue to exist as independent organisations, the most that can reasonably be urged is that the scheme shall throw no impediment in the way of absorption if all concerned should ultimately desire it. The Commissioners have evidently been anxious to leave the University as free as possible to develop in this as in any other direction. In one point only—and in that probably from inadvertence—have they imposed an unnecessary restriction. Representation on the Senate should not be allotted to particular Colleges, but to a class of Institutions, the list of which is capable of being revised with the approval of the Privy Council without a change in the Charter.

On the other hand, it must be admitted that the Commissioners, like the advocates of the Association Scheme,

leave so much to be settled by the Statutory Commission that the ultimate character of the University is still very doubtful. Though non-federal in theory, it may be practically federal in fact, and it behoves those who are interested in the matter to do all in their power to protect it from the grave dangers which will beset the earliest stages of its career. The position assigned to Teachers, though not exactly that claimed by the Association, is so strong and so dignified that on this point we hope there will be no further controversy.

To sum up. Putting aside the relations of the University to Theology, Medicine, Law, and Music, the scheme of the Commissioners is the Revised Scheme, improved and modified so as to be much more closely in accord with the ideas of the Association. The question as to whether the University is, as far as Arts and Science are concerned, practically a federation of Colleges, is left to a Statutory Commission to decide. The main danger with which the University is threatened is jealousy between semi-independent Colleges. The only safeguard against this which the Commissioners suggest is that they take it for granted that everybody concerned will do his best "for the progress of knowledge." To which we heartily say "Amen."

#### STEREOCHEMISTRY.

*Handbuch der Stereochemie.* Unter Mitwirkung von Dr. Paul Walden herausgegeben von Dr. C. A. Bischoff. I. Band. (Frankfurt: H. Bechhold, 1893.)

STEREOCHEMISTRY grows apace. The birth of this youngest scion of the chemical family, which occurred about twenty years ago, when Van't Hoff and Le Bel published almost simultaneously their now famous memoirs, was not greeted with universal acclamation. The event excited at the time but little interest among English chemists, and when the young science was introduced, through F. Hermann's *Lagerung der Atome im Raume*, to the acquaintance of our German colleagues, it was regarded not without suspicion in some quarters. There was one chemist of high rank who denounced the *Chimie dans l'Espace* as "fanciful nonsense," as the outcome of "a miserable speculative philosophy, whose treatment of scientific subjects is not many degrees removed from a belief in witches and spirit-rapping." Stereochemistry, however, soon found a congenial home in the German laboratories, and flourished marvellously. About four years ago the young stripling was duly christened by Victor Meyer on the occasion of an address to the German Chemical Society, and thus received formal recognition as a legitimate member of the chemical family. Since then three general treatises have been called for in order to chronicle the progress of this latest development of chemical science—the "Chemistry in Space" of Van't Hoff, translated into English and re-edited by J. E. Marsh; Meyerhoffer's "Stereochemie," a later translation into German of the same work with much additional matter, and the admirable "Grundriss der Stereochemie," by A. Hantzsch. Following quickly in the wake of these, we have, in the "Handbuch der Stereochemie," a much more elaborate and complete treatise, chiefly from the pen of Dr. C. A.

Bischoff, whose well-known indefatigable labours in the new field of research eminently qualify him for the serious task he has undertaken.

As explained in the publishers' announcement, stereochemistry has extended with such rapidity in recent years, and the numerous theoretical and experimental researches in this department are dispersed throughout so many different periodicals and pamphlets, that it is not easy for anyone who has not closely followed the subject from the outset, to obtain a general view of the development and present stand-point of the science. The object of the work before us is to remove this difficulty, and to attract more adherents to the new study. The book is further intended to exhibit the present position of all the problems which have been touched by stereochemistry, and to furnish a brief record of all the compounds which have any relation to optical and geometrical isomerism, so that it may serve as a convenient and reliable work of reference to the investigator.

The first volume of the treatise, extending to about 450 closely printed pages, comprises a general part, entitled "Die historische Entwicklung der Principien der Stereochemie," and the first subdivision of a special part, dealing with the relations of stereochemical theory to the phenomena of optical activity in organic compounds. The second volume, which is to appear shortly, will contain the remaining two subdivisions of the special part, which are to treat respectively of geometrical isomerism, and of the influence of intra-molecular space relations on chemical reactions.

The book has two distinct aims, which it is not easy to combine. As a work of reference the "Handbuch," we believe, fulfils all its claims, and will supply a much-felt want. The matter throughout is well up to date, the references to literature are copious, and the systematic account of all the known optically active organic compounds, which occupies more than half the volume, is the only complete collection of the kind we have at the present time. The organic chemist will understand the force of the commendation when we describe the book, from this point of view, as a *stereochemical Beilstein*, which will be indispensable in every laboratory where stereochemical research is being conducted. With respect, however, to the other purpose of the book, that of presenting a general picture of the development and present position of the science, the result is less satisfactory. The general part, which, judging from its title, was written with this end more particularly in view, is somewhat disappointing. The history of stereochemistry is an extremely fascinating subject; it contains all the elements of a good sensational scientific story, mysterious facts, wild speculations, ingenious hypotheses, beautifully verified predictions; but the subject as here presented is, to our mind, rather dry. The title of the chapter indicates that the development of the principles of stereochemistry is to be brought prominently into view; but we shall be surprised if the student, unless he is already pretty familiar with the literature of the subject, does not rise from its perusal, so bewildered in a maze of subtle speculation and conflicting hypothesis, as to conclude that stereochemistry has really no principles to develop. The introduction into a work of this kind of the speculation and hypothesis, to which stereochemical

discovery has given such a wonderful impulse, is of course not only justifiable, but highly necessary at the present stage. It is not to this, nor to the matter of the book generally, which indeed is admirably selected, that we venture to take objection, but rather to the method of treatment. The method adopted in the general part is not calculated in our opinion to present a history of the development of the subject in a striking and lucid manner. The chapter really consists of a series of abstracts of memoirs, ranging over the whole field of stereochemistry, placed in chronological order of publication, to which the author seldom adds expository or critical remarks. The paucity of experimental facts in illustration of the theories described, adds still further to the unattractiveness of the picture. The author, it is true, expressly states in the preface that details have been intentionally omitted, but the unavoidable result is that the abstracts are in many cases so bald as to be shorn of much of their interest, and the often repeated reference to the special part for application of the theories described becomes tantalising. Stereochemistry has already in the short period of its existence pushed its way in so many different directions, that to present an effective picture of its growth, it would be necessary to trace its development along a number of more or less independent lines. The opening chapter of the special part, we ought to state, supplies this want to a great extent with respect to optical isomerism, and similar sketches will, no doubt, be given in the other subdivisions.

The idea that the relative position of atoms in space within the molecule, must be an important factor in determining the properties of compounds, was, no doubt, present to the minds of many of the founders of the atomic theory, and it is interesting to learn from a correspondent in these columns (vol. xlix. p. 173) that Wollaston had a very clear conception of this fact. The history of stereochemistry, however, begins with Pasteur, and we are glad to see that the importance of his experimental discoveries and far-seeing predictions receive ample recognition. A portrait of the veteran chemist is placed opposite the title-page, with that of his younger colleagues, Van't Hoff and Le Bel.

As is generally known, these two distinguished chemists arrived at their fruitful theory of the asymmetric carbon atom by two entirely different paths, and their positions with respect to it are by no means identical; indeed, Le Bel has entered a protest on several occasions against his views being confounded with those of Van't Hoff. The disadvantage of the chronological method, to which we have alluded, is very apparent here, for to form any adequate idea of Le Bel's present stand-point, the reader has to hunt up the summaries of various papers which are scattered throughout the general and special parts. The views held by Le Bel are particularly interesting, as they lead him to sundry fundamental conclusions, which must seem very heretical to those who have adopted the doctrine of Van't Hoff without qualification into their chemical creed. Thus he has recently concluded that even a molecule of the type  $CR_4$  does not necessarily possess a configuration which can be symbolised by a regular tetrahedron, and that the usually accepted argument for the symmetrical distribution of the four hydrogen atoms in the molecule of marsh gas, based on the exist-

ence of only one monoderivative, is unsound. The experimental ground of his conclusion is the more interesting, as it furnishes one of the few instances in which the obvious property of the crystalline form of a compound has been used for the purpose of determining its molecular configuration. He finds in fact, contrary to Wislicenus' prediction with respect to compounds of the type indicated, that carbon tetrabromide does not crystallise in the regular system. Again, Le Bel's views do not exclude the possibility of optical isomerism in unsaturated bodies, and he finds indeed that solutions of citraconic acid become strongly active when mould is grown in them; should this discovery prove to be due to the production of an active isomeride of this acid, the discovery would revolutionise an important branch of stereochemical theory. Such considerations remind us that the prevailing stereochemical theories, fruitful as they have been, are nevertheless only a first approximation to the truth, and will have to undergo important modifications with the progress of discovery.

The reader of Dr. Bischoff's book will find abundant food for reflection in the numerous monographs, of which very good abstracts are given. Many of them, dealing with such fundamental subjects as the nature of chemical affinity, valency, the significance of double and treble linkage, the influence of the form and motion of atoms on chemical action, are highly interesting and suggestive; some of these papers will be already familiar to the readers of the *Berichte* and *Annalen*, but others which have been published in separate form are not readily accessible to the English chemist. The perusal of the opening chapter will convince the reader that stereochemical conceptions are already initiating a searching revision of the very foundations of the chemical edifice, and that they are destined in the near future to play an important, perhaps a predominant, part in the progress of chemical theory.

We may add that the book is abundantly illustrated with geometrical figures, and that a detailed index is promised with the second volume.

We have observed the following misprints: "symmetrischen" instead of "unsymmetrischen" in the last paragraph, p. 24; "+" instead of "×," p. 97; "Nachwirkung" instead of "Nahewirkung," p. 121.

T. P.

#### MARINE BOILERS.

*Marine Boiler Management and Construction.* By C. E. Stromeyer. (London: Longmans, 1893.)

THE difficulties attending the economic management of marine boilers have engaged the serious attention of engineers for many years, and Mr. Stromeyer's book will be welcomed as by far the most valuable addition which has been recently made to the subject.

The author treats in detail the generally accepted plans for the construction and methods of management of marine steam generators, and discusses, more or less fully, the causes of corrosion and other sources of wear and tear in boilers. Fuels and the conditions of heat transmission through plates are treated at length, whilst in the latter portion of the book, strength of materials

and details of boiler construction and design are discussed.

It is a matter for regret that from so good a book a certain number of errors could not have been eliminated. Thus, in speaking of the pitting of boiler plates below the surface of the water, the author states that in contact with the heated portion of the plate, the water gives up its dissolved air in contact with the surface of the metal, and that the bubbles there remain until large enough to rise, and he considers that during this period of rest the "nascent" oxygen which they contain will attack the iron. The idea that oxygen driven out of solution by the action of heat possesses the powers attributed to the nascent condition, will come as a surprise to his chemical readers. And again, on p. 61 it is stated that in the lungs the process of slow combustion is continually proceeding. In an age of specialism it is unlikely, and perhaps undesirable, that an author should speak with equal authority as engineer and physiologist. Reference to any modern text-book of physiology would have made clear the fact that diverse as may be the opinions as to the actual field of oxidation, the author appears solitary in selecting the lungs as the sphere of action.

The collection of formulæ put forward by various authorities for calculation of the calorific value of fuel from its chemical composition is very complete, but the author might have insisted more strongly than he has upon the errors inseparable from any such calculated heat values, which are due to our present ignorance of the molecular groupings in coal, and the thermal changes attending its formation.

An amazing confusion of idea is exhibited in the statement made on p. 69, "that gun-cotton ignites so readily that it could not be used for ammunition until it was discovered that the admixture of camphor or nitroglycerine raised this temperature." In the table of temperatures of ignition, on the same page, the ignition point of coal is given at 600° F.; this, on the evidence of recent experiments, is too low.

In the valuable chapter on heat transmission, no mention is made of one of the chief sources of loss in the passage of heat from the furnace to the water, namely, that the burning furnace gases are extinguished by contact with the comparatively cold surface of the plates, with the result that the flame never comes in contact with the metal, a layer of unburnt gas of very low conductivity existing between flame and plate; and this not only impedes the passage of heat to the water, but the gas creeping along the surface of the metal often escapes combustion, both in the furnace, combustion chambers, and tubes.

Coming to the engineering portion of the book, there is much which will excite comment from practical men. In the basic Bessemer steel process using phosphoric pig-iron, the purity of the blown metal is usually judged by the bath sample "fracture," which is quite as easy to gauge as a sample from the open-hearth working, and the procedure given in paragraph 6, p. 101, is at variance with every-day practice. Again, in describing the acid Siemens-Martin process, on p. 103, the author speaks of adding 25 per cent. scrap-iron, the ordinary practice being to charge steel scrap with the pig-iron before melt-

ing. In fact, scrap-iron could not be used in any quantity in this process, on account of the phosphorus and sulphur often contained in it; and it is the custom in most works to pick out all the iron found amongst the steel scrap for use in the Siemens-Martin furnace.

On p. 107 there is an excellent paragraph on cold bending, which contains valuable suggestions; but the remark that the bending of samples after annealing is valueless, may be objected to. The obvious reason of doing so is to bring the sample to the same condition as the finished article, and it is a common practice to specify that flange plates, or plates which have to be worked in any way, shall be annealed as a final process to bring them to a uniform condition; they may have been rolled at various temperatures, in which case the tensile and elongation tests would vary considerably. Nor will Mr. Stromeier's remarks upon drift tests meet with the general approbation of railway engineers. Surely, also, the first paragraph on p. 122, when considered in conjunction with the remarks on annealing made on p. 107, are of a contradictory nature?

The opinions expressed in the first paragraph of p. 156 are not justified by results of recent experiments, and the percentage of failures on the weld is not nearly so high as one would be led to expect from the experimental figures given on p. 157.

The tools described as being in use in boiler shops, on p. 182, are of an old-fashioned type, for special machines with three or more spindles capable of drilling up to 120 tube holes per day of nine hours, without any preparation of the plates, such as punching or drilling small holes, have been in use in most shops for a considerable period. The statement made on p. 237, that fitting a sufficient number of stay tubes will overcome the trouble consequent upon forced draught, is open to criticism, as it is not borne out by facts, and has indeed been the cause of considerable trouble in boilers.

It would have been better on the whole, considering the large number of books which now exist on design, to have curtailed the space devoted to this branch of the subject, which, although no doubt useful to the young draughtsman, might with advantage have been omitted from Mr. Stromeier's book.

These are minor and technical criticisms of an excellent work, exhibiting signs of much industry in compilation. The author is to be especially commended for his habit of reference on all occasions to the source of information.

#### OUR BOOK SHELF.

*Chapters on Electricity.* By Samuel Sheldon, Ph.D. (New York: Charles Collins, and the Baker and Taylor Co.)

IN the preface the author states that "these chapters on electricity, prepared for and included in the fourth revised edition of Olmsted's 'College Philosophy,' are here offered in a separate volume." The chapters deal in much the usual way with the stock work commonly found in elementary text-books on magnetism and electricity. The writing, however, appears to have been carefully done; the general style is clear and concise, but a little more explanation would, in many cases, have added to the clearness and, in a few cases, to the accuracy of the work.

In connection with Coulomb's law, the statement that  $F = Q/r^2$  (Art. 581) is "strictly true only when the two bodies are in a vacuum," requires a little more elucidation than the author gives. Similarly the explanation of polarisation, the definition of specific resistance (in terms of the metre and square millimetre), the statement of Ohm's law, and the laws of thermo-electric phenomena require more detailed and accurate treatment.

The paragraphs on recent work, such as Hertz's experiments, theories of magnetism and electrolysis, and modern theories of the ether, are far too meagre to be of any service; they give no information even to the student who is able to read between the lines.

Apart from these points, the book appears to present a fairly reliable exposition of the elements of the subject, which may justify its issue as a separate volume.

*Meteorology.* By H. N. Dickson, F.R.S.E. (London: Methuen and Co., 1893.)

In this little book the author has attempted to lay down "a certain amount of 'permanent way' specially adapted to practical purposes, but at the same time leading to the more theoretical grounds of modern research." The fundamental facts and principles stated in the earlier chapters furnish the inquirer with much of the necessary stock-in-trade of information culled from other branches of science; as, for example, the behaviour of gases under varying conditions of temperature and pressure. Cyclones and anticyclones receive somewhat detailed consideration, but the account is very intelligible, and the mathematical expressions are of the simplest character. The present position of meteorology in regard to weather-forecasting is very clearly and impartially stated. In the chapter on instruments the author leaves a little to be desired in the shape of illustrations and descriptions, especially as he aims at producing a practical treatise. An excellent account of cloud classification is given. The relation of meteorology to agriculture is a subject of great practical importance, and this is carefully discussed in the final chapter.

The author has availed himself of all the most recent sources of information, both British and foreign, and the references to original papers form a valuable feature of the book. To all who desire to carry their meteorological observations beyond the mere hobby stage, we heartily commend this little book.

#### LETTERS TO THE EDITOR.

[The Editor does not hold himself responsible for opinions expressed by his correspondents. Neither can he undertake to return, or to correspond with the writers of, rejected manuscripts intended for this or any other part of NATURE. No notice is taken of anonymous communications.]

##### Great Auk's Egg.

IMAGINATION has long had a large share in the accounts given of the Gare-fowl or Great Auk, notwithstanding the efforts of those who have tried to set forth nothing but the truth on the subject, yet I do not call to mind meeting with so "many inventions" regarding it as have appeared in the newspapers within the last week, on the occasion of the recent sale of a specimen of the egg of that bird. I should occupy too much space were I to dwell upon them; but I would ask for the admission of a few lines in which to state what is known exactly of the origin of that specimen, which I well remember in the collection of the late Mr. Yarrell. He told me, as he told others of his friends, that he bought it in Paris; and, to the best of my belief, not many years after the peace of 1815. In a little curiosity-shop of mean appearance, he saw a number of eggs hanging on a string; he recognised one of them as an egg of *Alca impennis*, and asking their price was told that they were one franc apiece, except the large one, which from its size was worth two francs. He paid the money and walked away with the egg in his hat. That is the whole story on which so im-

posing an edifice has been built, and the only "variant" of it deserving of consideration is to the effect that the price of the big egg was five instead of two francs. I may add that this simple story was published by the late owner of the egg, the Baron Louis d'Hamonville, in the *Bulletin* of the French Zoological Society for 1891 (tome xvi. p. 34).

ALFRED NEWTON.

Magdalene College, Cambridge, February 24.

##### Frost-Cracks and "Fossils."

SEVERAL letters appeared in NATURE last winter describing some of the more interesting plant-like forms due to frost acting on various surfaces, and both Prof. Meldola and myself drew attention to the possible deceptions which might arise from a preservation of such patterns as fossils. I yesterday met with a striking case illustrating this. It was at Cullercoats, on the Northumberland coast. There had been a slight frost the night before, and the surface of a talus of semi-liquid mud at the foot of a low cliff of boulder clay (actually on the line of the great Fault known as the "Ninety-Fathom Dyke") was found to be indented with cracks about  $\frac{1}{4}$  to  $\frac{1}{2}$  an inch deep and  $\frac{1}{4}$  of an inch in breadth. These cracks were disposed in beautifully branched patterns bearing a surprising resemblance, in outline, to some of the more subdivided sea-weed fronds. A sandy beach lay close by, and a high wind was blowing the sand on to the mud. It was obvious that the sand would soon fill in the frost-cracks under these conditions. The cracks would thus be preserved, and if at any future time the mud surface be again exposed it will be found covered with sand (or, after induration of the mud and pressure of overlying material, sandstone) casts of what it would be very difficult to believe were not vegetable organisms in an unusually perfect state of preservation.

Newcastle-on-Tyne, February 25.

G. A. LEBOUR.

##### The Origin of Lake Basins.

I WISH to draw the attention of your correspondents, Messrs. Aitken and Tarr, to p. 94 of the *Geological Magazine*, vol. iv. 1876, in regard to the manner in which, in all probability, the greater number of the lakes in British North America were formed. There are, however, doubtless many other causes by which lake basins have been formed. The object of my notice was simply to point out that the ice need not be supposed to have exerted any extraordinary or abnormal influence in scooping out rock basins which have subsequently become lakes.

Ottawa, February 16.

ALFRED R. C. SELWYN.

##### Note on the Habits of a Jamaican Spider.

OBSERVING in your issue of January 11, p. 253, an interesting note on the *Nephila madagascariensis*, I am prompted to send you some unpublished observations on the Jamaican species, *N. clavipes*. They are from the MSS. of the late Mr. William Jones (concerning whom see *Journ. Inst. Jamaica*, 1893, p. 301), and date from over fifty years ago. The record begins: "*Aranea clavipes*, or the great yellowish wood-spider. I fancy Sir Hans Sloane must have been misinformed when he states that this spider's web will not only stop small birds but even pigeons. I will venture to assert that its strength would not even endure the struggling of the smallest humming-bird." But below is another entry: "Dec. 25, 1839. I wronged the accuracy of Sir H. Sloane's statement; a little boy returning from an errand brought me a little black and yellow bird that he found entangled in a web of *A. clavipes*." After this he adds a more general statement concerning the spider: "St. Thos. ye East, on bushes and outhouses,—I found in the old cooper's shop at Slamans Valley Est. in Portland, many hundreds of these, some of a monstrous size. These spiders weave an almost large (*sic*) spiral web, yellow and strong, like silk, glutinous or viscid, and well adapted for arresting the flight of large insects. I have frequently seen some of their lines two or three yards long. Butterflies appear their favourite food. They form an oblong oval cocoon of a white substance like soft chamois leather, outside composed of little round-shaped compartments; the cocoon is covered over with a mesh of strong yellow thread or silk." Finally he gives a technical description of the spider, which need not be quoted. The spider's size is said to be 1 to  $1\frac{1}{2}$  inches in length, with the fore-legs  $2\frac{1}{2}$  inches long, the second pair 2 inches, the third pair 1 inch, and the fourth pair 2 inches.



Thus it appears that *N. clavipes* is not altogether unworthy of comparison with the great Madagascar species in regard to its web. It is one of the very commonest spiders of Jamaica, as I have myself observed, and has a wide distribution in the neotropical region.  
T. D. A. COCKERELL.  
Las Cruces, New Mexico, U.S.A., February 8.

The Cloudy Condensation of Steam.

WITH reference to Prof. Barus's letter (p. 363), I have never suggested that condensation nuclei in smoke, &c. would "remain distinct indefinitely," but that, if there were no chemical action, they would hardly disappear in the course of a few seconds.

There is no mention in my lecture of "dissociated particles," or of the dissociation of platinum at red heat. What I said was that electrical discharges and incandescent substances probably caused dissociation of oxygen and nitrogen in the surrounding air (*ante*, p. 214).  
SHELFORD BIDWELL.  
February 22.

Astronomy in Poetry.

WITH reference to the note in the Astronomical Column of NATURE, No. 1226 (p. 372), it is worth remark that the nebular theory of the universe is briefly and accurately set forth by Tennyson thus—

"This world was once a fluid haze of light,  
Till toward the centre set the starry tides  
And eddied into suns, that whirling cast  
The Planets."  
[*The Princess.*]

A little knowledge of astronomy would have led Coleridge's Ancient Mariner to know that he could never have seen

"The horned moon, with one bright star within the nether tip."

Tennyson is always accurate in his descriptions of natural phenomena.  
EDWARD GEOGHEGAN.  
Bardsea, February 19.

A Plausible Paradox in Chances.

WITH reference to the paradox in chances mentioned by Mr. Francis Galton in NATURE of February 15 last, I think the following remarks will show very simply where the fallacy lies.

If I assert that at least two out of three coins must turn up alike, I am saying what is evidently true; but if I go on to say that it is an even chance whether a third coin is head or tail, I am assuming that only two coins have been tossed, and that the fate of the third is still uncertain; but this is directly counter to my first assertion, which requires the tossing of three coins.

If this method of reasoning is to be used at all, I must say first that the chance of two coins turning up alike on being tossed is  $\frac{1}{2}$ , and then that the chance of a third coin being the same as the other two is also  $\frac{1}{2}$ , and that therefore the required chance of all three being alike is  $\frac{1}{2} \times \frac{1}{2}$  or  $\frac{1}{4}$ .

LEWIS R. SHORTER.

THE PLANET VENUS.

FROM time immemorial the planet Venus has attracted the attention of mankind. Before the days when the "optic tube" began to be turned towards her disc, Venus, we might say, was still in myth, and she was hailed as Hesperus and Phosphorus, according as she was an evening or a morning star, the fact that the same object was in question being then unknown.

Shining as she does at times with a brilliancy surpassing any other body except the moon, it is only natural that she should have been so often sung about by poets in all lands, liking her unto

"the fair star  
That gems the glittering coronet of morn."

And she is highly honoured by Homer, in that she is the only planet to which he refers:

Ἑσπερος ὅς κ' ἀλλοίστως ἐν οὐρανῷ ἵσταται ἀστῆρ.  
Hesperus quæ pulcherrima in cælo posita est stella.

NO. 1270, VOL. 49]

To Galileo belongs the honour of first having viewed the planet through a telescope, but it is curious to remark the lapse of time that he allowed to pass before he made his first observation. The discovery that Venus exhibited phases did not take place until the end of September 1610, though Galileo first observed the satellites of Jupiter on January 7 of that year.

That Galileo should veil this important discovery of the phases of Venus under a Latin anagram,<sup>1</sup> does seem at first rather strange, but when one considers the vast importance of the discovery in that it supplied a simple proof of the planet's revolution round the sun, one can understand that he would first desire to be quite certain of his facts before giving the key to the anagram.

An historical fact of interest with reference to Father Castelli may be mentioned here. In Venturi's collection there is a letter from Father Castelli to the celebrated Florentian astronomer, dated November 5, 1610, in which he asks Galileo whether Venus and Mars show phases. Galileo evidently did not wish to give a direct answer, so evaded the question by saying that, although he was engaged in various investigations, he was better in bed than out in the open air in consequence of great infirmity. It was not until December 30, 1610, that he informed Castelli of his recognition of the cusps.

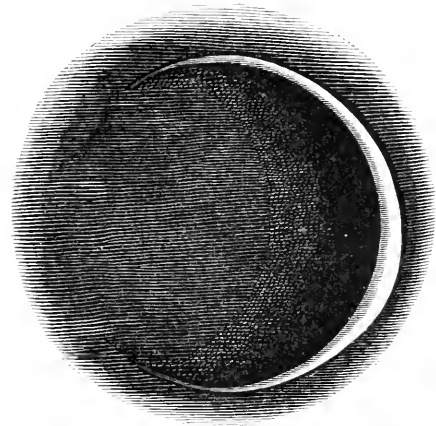

FIG. 1.—February 26, 1873 (Trouvelot).

With an ever-increasing number of telescopes at the disposal of astronomers, it is not astonishing that facts concerning surface markings, form, period of rotation, &c. should be rapidly forthcoming, and the sum total of what we now know about the planet has been gained at the expense of much labour and patience at the eye-piece end of the telescope.

During the past three months Venus has been a striking object in the south-western and western region of the sky, being in a position more than usually favourable for observation. Towards the end of November last her great southern declination began to decrease, while the planet became brighter and brighter, passing her greatest elongation east on December 6. On January 11 she attained her maximum brilliancy, the crescent form gradually increasing until on February 15, that is, at inferior conjunction, it was totally invisible. Gradually the crescent will become visible again, but in the inverse order, and we shall have another maximum on March 22, superior conjunction occurring on November 30. Thus we know that Venus is now lost in the sun's rays, and is, in consequence, invisible to us as an evening star for some time to come. The accompanying illustration (Fig. 1) gives a drawing of the planet as recorded by

<sup>1</sup> "Hæc immatura a me jam frustra leguntur," or with the letters properly arranged—"Cynthiae figuræ æmulatu Mater Amorum."

Trouvelot in 1878, at a time when only a very fine crescent was visible. (The bulging at the south-south-east portion of the crescent was observed, and is not a defect in the drawing.)

Of all the planets, Venus approaches us the nearest, her minimum distance amounting sometimes to approximately five million miles, that is, about five times nearer than when she is furthest from us. Unfortunately, at these times her illuminated disc is turned away from us, and all we can do is to direct our attention to the small crescent that remains before inferior conjunction is reached. This accounts for the uncertain knowledge that we possess with regard both to surface markings and the period of rotation. The latter question is still a moot point among astronomers, and it is interesting to note the historical sequence in which these investigations have been made. The first spots on the planet's disc were noted by Dominique Cassini in October and June of the years 1666 and 1667 respectively, and from them he deduced a period of 23h. 21m. Bianchini, about 60 years afterwards (1726-27), came to quite a different result, substituting 24 days 8 hours for that obtained above. Jacques Cassini, discussing his father's observations and those made by Bianchini, concluded that a period of 23h. 20m. satisfied both the old and new observations, but that Bianchini's value would not agree

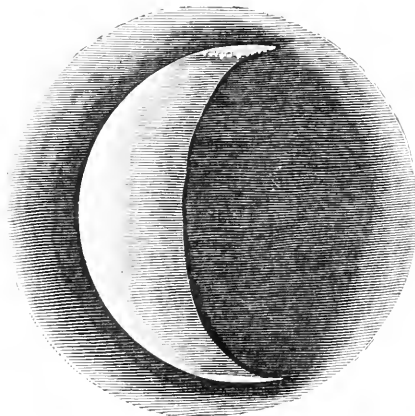

FIG. 2.—Details of snow-caps January 19, 1878 (Trouvelot).

with that of his father. This value seems for some time to have been accepted, and Schroeter's (1798-1799) and De Vico's (1840-42) observations practically confirmed it. Fig. 2 gives a view of the planet as seen on January 19, 1878, and shows the details in the polar spots sometimes available for "period of rotation" determinations.

Thus matters stood till that keen-eyed observer Schiaparelli took the field. After a most careful study, extending over many years, in which some single observations were made extending over eight consecutive hours, he was led to make the statement that the rotation of the planet is exceedingly slow, and probably takes place in a period of 224 days 7 hours, the duration of the revolution of Venus about the sun. At Nice, M. Perottin has come to a similar view, expressing his opinion in the following words: "Ne diffère pas de la durée de la révolution sidérale soit 225 jours environ, de plus de 30 jours." These two observers, especially the former, thus upset our whole belief in a short duration of the period, but we are still again brought to consider the question from observations emanating from another source. We refer to those made by Prof. Trouvelot (see NATURE, vol. xlv. p. 470), whose opinion is of great weight. The importance of his work lies in the fact that it was carried on at the same time as that of Schiaparelli "souvent dans la même journée, sous un ciel également propice et

précisément sur la même point de la planète." The value ultimately deduced was 23h. 49m. 28s., which again brings us back to a short period. In referring to Schiaparelli's observations he says: "La cause probable de l'erreur de M. Schiaparelli semble résulter de ce fait que les taches *h* et *k*, qui ont servi de base à ses conclusions, faisaient partie de la tache polaire méridionale qui, étant située centralement sur l'axe de rotation de la planète, semble rester stationnaire, comme cela se voit sur la

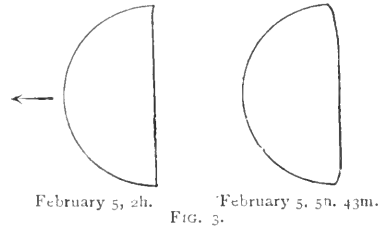

FIG. 3.

tache polaire de Mars, quand elle se trouve réduite à de faibles dimensions." He also refers to the general features visible on the planet's surface as indications of a rapid rotation, especially that of the rapid deformations of the terminator and hours.

Thus we are left with the choice of two periods, one long and consisting of 224 days, the other short, of 24 hours nearly. We leave our readers to adopt that which they think best, the balance of favour falling, in our opinion, slightly towards the 24-hour side of the scale. But just as Schiaparelli's observation of the doubling of the canals of Mars was finally observed and universally accepted, so perhaps time may prove his case as regards this period of rotation.

Some of the most recent work on the planet Venus relates to the measurement of her diameter. Among a few of the reduced measures the following may be given:—Hartwig, with the Breslau heliometer, from forty-three observations obtained a diameter of  $17''\cdot67$ . The same observer, from a reduction of the Oxford observations, and also from Kaiser's observations with Airy's double-image micrometer, obtained  $17''\cdot582$  and  $17''\cdot409$  from

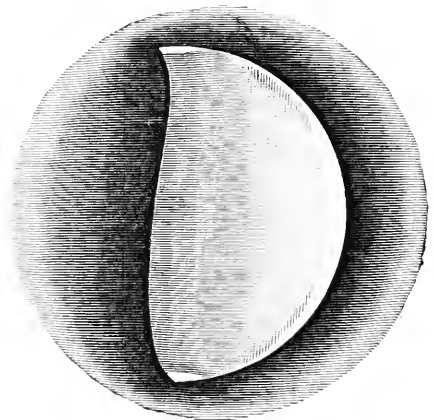

FIG. 4.—Showing irregularity of terminator November 23, 1877 (Trouvelot).

thirty-three and thirty-four observations respectively. Auwers from the transit of Venus measures deduced the value  $16''\cdot801$ , while Ambronn<sup>1</sup>, from thirty-four observations, measured the diameter as  $17''\cdot711$ .

Among other interesting points to which we might refer, are the planet's visibility in full daylight, the snow-caps, the secondary light, the planet's form, &c. Each of

<sup>1</sup> See *Astr. Nachr.* No. 3204, p. 190.

these have raised a host of questions at various times, which even yet are not fully answered. The question as to the form of the planet itself is also one full of interest, and observers, from Beer and Mädler down to Trouvelot, have made numerous drawings of the different appearances. Observations have shown that the surface, or whatever it is that we look at, is by no means level, but extremely uneven or irregular. Such irregularities can be best detected naturally at the terminator and limb. Fig. 1 indicates a bulging at the limb, while Fig. 3 shows a similar phenomenon at the terminator at two different times—February 5, 2h. and 5h. 43m. (Perhaps this is one of the best proofs of a "short duration" period for rotation).

Fig. 4, which we also owe to Prof. Trouvelot, shows a more decided case of irregularity, and on perhaps a much larger scale.

Much remains, however, to be done before we are on anything like a footing with this planet as we are with Mars. With this latter we can observe directly the land and water markings, time to a second the period of rotation, observe local storms, and many other details; but with the former the case is different. Here the planet is for the most part lost in the rays of the sun, or at other times not very easy for observation.

That Venus has an atmosphere is a fact which has long been known, and that this is denser than the earth's envelope is also very probable. The part this atmosphere plays in the determination of the period of rotation seems to be of great importance, and it is rather a question of whether we have been observing real rigid markings on the planet itself, or only what has been described as "a shell of clouds, the appearances interpreted to signify the existence of lofty mountains, snow-caps, vast chasms, and crater-like depressions, are really nothing but the varying features of cloud scenery."

Whichever the case may be, future observation has still to show; but it seems that with the rapid advance now taking place in large instrument-making, such a question as this could be settled, given a few fine evenings or mornings near a favourable time of observation, a clear and still air, and a large aperture. Such occasions, perhaps, may be rare, but the point at issue is important, and should be settled as soon as possible.

W. J. L.

#### NOTES.

ALL the arrangements have now been made for the eleventh International Medical Congress, shortly to be held in Rome. The inauguration of the congress will take place on March 29, in the presence of the King of Italy. On the following day will commence the work of the scientific sections, which will be continued till April 5.

A CONGRESS of chemistry and pharmacy will be held in Naples at the beginning of next September. The congress will be divided into two sections—the one scientific, the other professional.

M. EUGÈNE CATALAN, a member of the Sciences Mathématiques section of the Paris Academy of Sciences, died at Liège on February 14.

ON March 18, Prof. J. Bertrand, the popular perpetual Secretary of the Paris Academy of Sciences, will have spent fifty years in expounding science. In order to celebrate this jubilee in a fitting manner, a committee has been formed, consisting chiefly of his old students at the École Polytechnique, the Sorbonne, the Collège de France, and the University, and a circular has been issued asking for subscriptions towards a commemorative medal which it is proposed to have struck for the occasion.

The committee appeal not only to the eminent professor's old pupils, but also to his colleagues and friends who desire to do him honour. Among the members of the committee are Profs. Cornu, Marcel Deprez, Jordan, Maurice Lévy, Mascart, Mercadier, Picard, Poincaré, and M. Tisserand, the Director of the Paris Observatory. Subscriptions may be sent to any of these names, or to M. le Trésorier, de l'École Polytechnique, 21 Rue Descartes, Paris.

AN offer made by Miss Marian Brockhurst, to build a museum in the public park of Macclesfield, and endow it with £100 a year, has been accepted by the park committee.

AMONG the bequests of the late Mr. Thomas Avery, of Birmingham, is the sum of £2000 to the Midland Institute, and £1000 to Mansfield College, Oxford.

THE Malte-Brungold medal of the Paris Geographical Society is to be awarded to M. A. Delebecque, for his researches on the French lakes, of most of which he has constructed detailed bathymetrical maps.

WE learn from the *Chemist and Druggist* that the centenary of the birth of Friedlieb Ferdinand Runge, whose name is connected with the discovery of aniline, carbolic acid, and the paraffines of coal-tar, was celebrated at Oranienburg, near Berlin, on February 6, by the unveiling of a memorial tablet in the wall of the present Royal Seminary, which occupies the place where Runge's laboratory formerly stood.

THE Council of the Society of Arts attended at Marlborough House on Friday, when the Prince of Wales, President of the Society, presented to Sir John Bennet Lawes the Albert medal, and a like medal to Sir J. Henry Gilbert, awarded to them in 1893 "for their joint services to scientific agriculture, and notably for the researches which, throughout a period of fifty years, have been carried on by them at the Experimental Farm, Rothamsted."

WE learn that the collection of fossil plants, got together by Mr. James M'Murtrie, of Radstock, has passed away from the county where it was chiefly collected to the Natural History Museum at South Kensington, where it has found a permanent home. The Somerset coal measures generally, and especially the Radstock seams, have long been known for the richness and variety of their fossil flora, which is found in a state of preservation probably not equalled in any other coal-field in the country, and a residence of more than thirty years amidst such surroundings, with the aid of many willing assistants, had enabled Mr. M'Murtrie to accumulate one of the finest private collections in the country. The collection, consisting of more than 300 specimens, includes every variety of plant life of the Carboniferous age, from the smallest variety of fern to the largest tree ferns.

A FINE egg of the gare-fowl or Great Auk was put up for auction by Mr. Stevens, on Thursday, and, after a keen competition, was purchased by Sir Vaucey H. Crewe for 300 guineas. The egg originally belonged to the late Mr. William Yarrell, and the facts relating to its purchase are stated by Prof. Newton in another column. In 1856 the late Mr. Frederick Bond purchased the specimen for twenty guineas. It remained in this gentleman's possession until 1875, when it was sold to Baron Louis d'Hamonville. Of the sixty-eight true specimens of the Great Auk's eggs known to be in existence, Great Britain is said to possess forty-eight; France, ten; Germany, three; Holland, two; Denmark, Portugal, and Switzerland, one each; and the United States, two.

THE origin of gold nuggets is a question about which much controversy has arisen. Dr. A. R. Selwyn long ago suggested that the nuggets grow in alluvial deposits by the deposition of

gold upon their surface. His theory has been supported by other geologists and chemists. Prof. A. Liversidge has recently made a large number of experiments bearing upon this question, and his conclusion is that although large nuggets may be artificially produced, those found in alluvial deposits have been derived from gold-bearing rocks and reefs, and have obtained their rounded and mammillated surface by attrition; also, any small addition of gold which they may have received from meteoric water has been quite immaterial. (Roy. Soc. N.S. Wales, September 6, 1893.)

WE have received the annual report of the Geological Survey of Canada for 1890-91 (vol. v. new series). The volume consists of 1566 pages, bound in two parts, and containing thirteen separate reports, with maps and illustrations descriptive of the geology, mineralogy, and natural history of the various sections of the Dominion to which they relate. The region surveyed is so large, and the matters described are so numerous, that a bare mention of the results would take up many columns of this paper. One of the points of interest that attracted our attention while glancing through the pages of the report, relates to the discovery of a considerable deposit of infusorial earth on the right bank of the Bras, just at its junction with the Montmorency River. The deposit is about fifteen feet thick, and occurs in sand containing boulders, about forty feet above the river, and is overlaid by fifty feet of the same material. In colour the earth is partly yellowish and partly lead-grey, these tints being sometimes arranged in different layers, and sometimes irregularly intermixed in spots and patches. Another deposit of the same kind has been found on the east side of the north branch of the Ste. Anne River. This deposit is said to extend over an area of half an acre in the river valley, and in places is more than four feet in thickness. Dr. A. R. C. Selwyn, the Director of the Survey, has the thanks of all students of geology for the mass of material he has brought together in the report, and for the manner in which it is arranged and indexed.

ANOTHER Arctic expedition is announced by Reuter's agency as being prepared in the United States by a journalist named Wollman. The proposed route is by Spitzbergen, whence "a dash is to be made for the pole," and America regained by November of the current year. In this connection it is interesting to note that an expedition under the Norwegian Ekroll was stated in the newspapers to have started in June, 1893, from the north of Spitzbergen, but from private information we understand that this expedition never set out. The experiment of an Arctic journey from this side would be well worth making, if the expedition were properly equipped and adequately organised.

THE recent planimetric measurement of France by the Geographical Department of the Army, gives as the total area 536,891 square kilometres, or 206,381 square miles, which is 2000 square miles more than was formerly accepted as the area of the country. The problem of the exact area of a country is one of the most difficult in geography, involving as it does a survey of high accuracy and very laborious computation from large scale maps. The datum is of extreme importance, as it enters into all questions of quantitative distribution; in the case in point, it reduces the average density of population in France at the census of 1891 from 187.8 to 185.8 per square mile.

AT the last meeting of the Royal Geographical Society, a paper by Mr. Warrington Smyth, on the Upper Mekong, was read in his absence. The journey which was described was carried out for the Siamese Government, with the primary object of investigating a reported deposit of rubies and sapphires

opposite Chiang-kong. Mr. Smyth left Bangkok in December, 1892, ascended the Menam for some distance, and crossed the mountainous country inhabited by the kindly and hospitable Laos eastward to the Mekong, which was reached near Chiang-kong. Across the river a series of low hills of crystalline rock gave origin to the gem-bearing gravels carried down by the streams which flowed from them to the main river. These gravels were being actively worked by the Burmese, who tried to keep the place of occurrence of the gems secret. The survey finished, Mr. Smyth's party came down the Mekong, five days' journey amidst beautiful scenery, to Luang Prabang, a large un-walled town of teak houses and numerous picturesque, often ruinous, monasteries. A French store established there seemed to do little business, the people preferring their home-woven cottons to the product of European looms.

WE have received an excerpt paper from the *Beobachtungen der Meteorologischen Stationen im Königreich Bayern* for 1893, containing an account of two balloon ascents, made at nighttime, under the auspices of the Munich Balloon Society. The ascents were made for the purpose of investigating the conditions of the atmosphere at a time when the disturbances arising from heated ground were not effective, and the observations have been discussed by Profs. L. Sohncke and Finsterwalder, who also took part in one of the ascents. The instruments recorded automatically, electric light being employed both for attending to them and for obtaining photographic traces from some of the apparatus. The first ascent was made at 1 a.m. on July 2, 1893, from Munich, there being a barometric maximum at the time, and the second ascent was made on the 8th of the same month, under similar conditions. We can only refer here to one or two of the results of the first ascent. The most important feature in this case was the observation of a maximum temperature at a height of about 1000 feet above the ground. At a height of 400 feet the temperature was 63°.5, or 5°.4 higher than at the place of starting. In a stratum of another 450 feet there was only an unimportant rise of temperature, after which a rapid fall occurred, so that at a height of a little over 1000 feet the maximum temperature of 65°.8 was recorded, being 7°.7 higher than at the place of starting. From this point the temperature steadily decreased, and at 2900 feet it had fallen to 56°.3. The relative humidity first decreased regularly with height from 85 to 49 per cent., and then from 1400 feet to the highest point attained (2900 feet), it steadily rose to 72 per cent.

A VALUABLE contribution to the study of thunderstorms, by R. De C. Ward, appears in vol. xxxi. part ii. of the *Annals of the Harvard College Observatory*, which has just been published. Full details are given of all the storms observed in New England during the years 1886 and 1887. June, July, and August were the months in which thunder was most frequently heard, and July had the greatest number of distinct thunderstorms. The hours of greatest frequency were 5 to 7 p.m. On about 40 per cent. of the days when thunder was reported there were storms with progressive movement, the average rate in both years being about 35 miles per hour, while the maximum and minimum velocities were 50 and 14 miles per hour respectively. The results of 1886 tend to show that the dependence of thunderstorms on the larger atmospheric disturbances or cyclonic storms is not so striking as many observations have shown it to be for Europe. While in 1886 over 60 per cent. of the thunderstorms occurred in the southern or south-western quadrant of cyclones central north of New England, in 1887 the majority of the storms occurred in the south-eastern quadrant under anti-cyclonic conditions. A meteorological summary for New England in 1891, by J. Warren Smith, of the U.S. Weather Bureau, appears in the same volume.

THE last number of the *Memoirs and Proceedings of the Manchester Literary and Philosophical Society* (vol. viii. No. 1)

contains a paper by Dr. G. H. Bailey, on some aspects of town air as contrasted with that of the country. He proves that as a means of discriminating between polluted and unpolluted air, and as a means of forming some estimate of the extent of pollution, the determination of the sulphurous compounds and of organic matter are much to be preferred to that usually adopted, viz. an estimation of the carbonic acid. It is also urged that however minute the quantities of polluting matter may be, they are sufficient to bring about serious disorganisation in plant life and in human beings. Dr. Bailey has prepared a number of tables showing considerable variations in the quantity of sulphur compounds present in different localities in Manchester and London on clear days and on slightly or densely foggy days. A remarkable result derived from one of the tables is that during the dense fogs of December, 1892, in Manchester and London, there was a much larger proportion of sulphur compounds present in the London than in the Manchester air, notwithstanding the fact that the coal consumed in Manchester is generally understood to be much more sulphurous than that burnt in London.

AN ingenious method of photographing the spectrum of lightning is proposed in the current number of *Wiedemann's Annalen* by G. Meyer. The difficulty of directing the slit of the spectroscopie upon the flash is got over by substituting a diffraction grating for the prism. A grating ruled on glass is placed in front of the object-glass of the apparatus, the object-glass being focussed for infinite distances. Under these circumstances several images of the flash are obtained, a central image produced by the undiffracted rays, and images of the first and higher orders belonging to the diffraction spectra. The number of images of each order corresponds to the number of lines in the spectrum of the lightning. The arrangement was tested during a night thunderstorm. Two plates were exposed in a camera with a landscape lens of 10 cm. focal length, provided with a grating with 40 lines to the mm. One of the plates showed two flashes with their diffraction images of the first order, but representing one line only. The other showed a number of flashes, and one very strong one, passing apparently between two chimney-pots, with its diffraction images well marked. A calculation of the wave-length of the light producing these images gave  $382 \mu$ . The measurement was not sufficiently accurate to warrant an identification of this line with a known wave-length, but it is certain that a radiation of about this wave-length must be added to the lines determined by Schuster and Vogel. It is probable that with better apparatus the method may be made to considerably increase our knowledge of the ultra-violet spectrum of lightning.

THE current number of the *Electrician* contains an abstract of a paper, by J. Sahulka, on the measurement of the capacity of condensers under alternating currents. The author has found that condensers with a solid dielectric have a smaller capacity when used with alternating currents than is given by measurement by direct current methods. He considers that the reason for this phenomenon lies in the condition of the dielectric; for even if it has a very high electrical resistance it absorbs energy in the process of charging, which energy is partly returned to the circuit in the discharge, and partly converted into heat. Thus, if a measurement of charge or discharge is made, the galvanometer deflection is too high, for it is a measure not only of the quantity of electricity passing on to or out of the coatings, but also of that taken up or returned by the dielectric. Now it is well known that the dielectric takes an appreciable time to take up this quantity of electricity, and since in alternate-current working charge and discharge occur successively with great rapidity, it follows that the dielectric has not time at every charge to take up as much electrical energy as it would if it

were charged by an electromotive force applied for a much longer time. It is thus necessary to define what is meant by the capacity of a condenser where alternating currents are concerned, and the author proposes the following definition:—"The capacity of a condenser on an alternating current circuit is equal to the reciprocal of the product of  $2\pi n$  and its inductive resistance, the latter being equal to the quotient of the potential difference at the condenser terminals caused by the charge, divided by the strength of the current flowing into it." The author mentions an experiment on a condenser with paraffined paper as dielectric, having a capacity of about one microfarad when measured on direct currents, which was found on an average of several experiments with alternating currents to have a capacity about 14 per cent. lower. Steinmetz's law, according to which condensers having solid dielectrics should absorb, under alternating currents, an amount of energy proportional to the square of the potential difference, was found by the author to be very approximately true.

WE have received a copy of the seventh annual report of the Liverpool Marine Biology Committee and their Biological Station at Port Erin (Isle of Man), by Prof. W. A. Herdman, F.R.S. The report shows that progress has been made in the scientific exploration of the Irish Sea during 1893, and a number of important investigations have been carried out by the sixty naturalists who worked at the station. The protective colouration of *Vibrios varians* was under observation during last summer. The manner in which individuals of this small prawn resemble the green, red, or brown seaweeds with which they are associated, on even sandy and gravel bottoms, was discussed in the report for 1892, and the question was raised as to whether, or to what extent, the adult animal could change its colour. Prof. Herdman says that a number of specimens, of various colours, were kept under observation in the laboratory during the year, in jars with various colours of seaweed and of background, and in very different amounts of light. The results of these experiments show clearly that the adult animal can change its colouring very thoroughly, although not in a very short space of time. The change in colour is due to changes in size and arrangement of the pigment granules of the chromatophores. It is remarked that an interesting point to determine is whether in this case, as in some others of similar colour changes, the modification of the chromatophores is due to nerve action and is dependent upon sight, or is the result of the direct action of light upon the integument.

A FURTHER contribution to our knowledge concerning the action of sunshine on microbes is to be found in a recent number of the *Comptes Rendus* (vol. cxviii. p. 151). MM. d'Arsonval and Charrin find that if the *b. pyocyaneus* (an organism frequently found in the pus from wounds) is exposed to sunshine in culture liquid (presumably broth) for from three to six hours, it is deprived of its pigment-producing power; if, however, it is only subjected to the influence of the red rays in the spectrum, it exhibits subsequently the typical fluorescent green colour on cultivation in agar-agar at  $37^{\circ}$  C. Moreover, if the amount of sunshine it receives is extended, no growths at all subsequently make their appearance, showing that it has been destroyed; whilst it can tolerate a similar exposure to the red rays without exhibiting any signs of discomfort. This loss of pigment-producing power may also, these investigators state, be brought about by subjection to very low temperatures; thus at between  $-40^{\circ}$  and  $-60^{\circ}$  C. this bacillus loses its characteristic rod-like shape, frequently becoming ovoid; it multiplies very slowly, and exhibits only creamy white growths on agar-agar.

WE have received a volume containing statistics of the colony of Tasmania for the year 1892, compiled in the office of the Government Statistician from official records.

THE February *Journal* of the Royal Microscopical Society contains the address on "The Progress and Present State of our Knowledge of the Acari," delivered by the president, Mr. A. D. Mitchell, on January 17 of this year.

THE number just issued of the *Journal* of the Institution of Electrical Engineers contains Prof. G. Forbes's paper upon "The Electrical Transmission of Power from Niagara Falls," and the valuable discussion which it raised.

MESSRS. WITHERBY AND CO. will issue next month a volume of essays on zoological and geological subjects by Mr. Richard Lydekker. The volume is to be entitled "Life and Rock," and will be fully illustrated.

A FIFTH edition of Mr. W. Larden's "School Course in Heat" has been published by Messrs. Sampson Low, Marston, and Co. The book has been enlarged, and in places rewritten, and has gained in value by the refining process to which it has been subjected.

A FIFTH edition of the late Prof. Tyndall's biographical sketch of Faraday has been published by Messrs. Longmans, Green, and Co. The preface of this new edition possesses a melancholy interest, for, in a brief note appended to it, Mrs. Tyndall says it was only written a few days before her husband's death.

JUDGING from the twenty-fourth annual report just received, the Wellington College Natural Science Society is in a very satisfactory condition. The report contains abstracts of the papers read before the Society during the year, the results of meteorological readings, observations of plants and insects, and a statement of entomological occurrences and peculiarities. The Society is certainly a creditable part of the College to which it belongs.

THE 1894 *Annuaire* of the Municipal Observatory of Montsouris contains, in addition to the usual meteorological, physical, and chemical tables, an article by M. Albert Lévy on the chemical analysis of air and water, and a memoir by Dr. P. Miquel on the organic matter in air and water. The latter paper deals with the microscopic analysis of the air of Montsouris and that of the centre of Paris, the microscopic analysis of water, and statistics as to ammoniacal ferments in the air and water of different places.

THE Universal Electrical Directory (J. A. Berly's) for 1894 has been published by Messrs. H. Alabaster, Gatehouse, and Co. It contains the names of the members of the electrical and kindred fraternities throughout the world. For simplicity and facility of reference the work is divided into four groups, dealing respectively with British, Continental, American, and Colonial names, and these parts are again subdivided into alphabetical and classified sections. Several thousands of new names have been incorporated in the present issue, and 104 pages have been added, making a total of 888 pages.

IN March of last year we noticed the first report of the proceedings of the International Congress of Prehistoric Archaeology and Anthropology held at Moscow in 1892. The second volume has now reached us. The memoirs included in it are arranged into three classes, referring respectively to prehistoric archaeology, anthropology, and prehistoric ethnology. In addition to these memoirs, many of which are of great importance, the present volume contains the *Procès-verbaux* of the meetings. Another volume that has also been recently published contains descriptions of the places and institutions visited during the Congress, and reports on some of the questions discussed.

IT is announced that a new monthly review of current scientific investigation—*Science Progress*—will make its *début* to-day. The new journal will be published by the Scientific Press, and will be edited by Prof. J. Bretland Farmer, with the assistance of an editorial committee, consisting of Prof. H. E. Armstrong, F.R.S.; Prof. C. S. Sherrington, F.R.S.; Prof. J. W. Judd, F.R.S.; Prof. R. T. Weldon, F.R.S.; Prof. G. B. Howes, and Prof. H. Marshall Ward, F.R.S. The editors propose to include in *Science Progress* notices and reviews of all the effective work that is being accomplished in the various branches of science, and the articles will aim at providing a critical exposition of current work in the departments to which they refer. In this way it is hoped that the journal will be of use, not only in recording what has actually been done, but also as indicating the direction and general tendency of research.

THE first number of the new series of *Science Gossip* contains, among other articles, one by the editor, on science at the free libraries. A recent tour through the metropolitan libraries, and those in some of the larger midland counties' towns, has shown Mr. Carrington that in many cases the income of the library goes in the purchase of fiction or general expenses, and the librarian depends upon donations for the science section of his catalogue, and must accept whatever comes to hand. To remedy this, it is suggested that some authoritative body, such as the Education Department of the Imperial Government, or failing that, the Library Association, should invite the councils of various learned societies, like the Royal, Linnean, Zoological, Geological, Geographical, Astronomical, Botanical, Chemical, Anthropological and Meteorological, to draw up a list of works dealing with their special subjects, so as to get a list of good textbooks and authorities. This list might be revised from time to time, as changes became necessary through the progress of research.

THE atomic weight of palladium has been subjected to revision by Prof. Keiser and Miss Breed. A previous investigation of the value to be ascribed to this metal was carried out by Prof. Keiser in 1839, the salt palladium diammonium chloride,  $\text{Pd}(\text{NH}_3\text{Cl})_2$ , which was considered for many reasons to be particularly suitable, being employed. The number derived from nineteen determinations was 106.27. Since that time three other determinations of the atomic weight of palladium have been carried out, by Bayley and Lamb, and by Keller and Smith in 1892, and by Joly and Leidié in 1893, the results of which are most discordant, differing by as much as a unit and a half. Dr. Keiser has therefore returned to the work, and has succeeded in discovering a compound of palladium which can be vapourised, and therefore subjected to fractional distillation, a method which Stas considered as the only one by which substances may be obtained in the highest state of purity. The compound in question is the dichloride  $\text{PdCl}_2$ , which can be distilled at a low red heat in a current of chlorine. The pure chloride thus obtained was converted into palladammonium chloride, and the latter compound analysed by reduction to metallic palladium in a current of pure hydrogen. The results of all the analyses afford as the final mean value for the atomic weight the number 106.25, which agrees remarkably closely with that previously obtained by Dr. Keiser. The most divergent of all the individual values are only 0.07 apart, so that it would appear that the atomic weight of palladium is now definitely determined.

A FURTHER communication upon the subject of the artificial preparation of the diamond is contributed to the *Comptes Rendus* by M. Moissan. It was shown in an earlier memoir that when carbon is dissolved in various fused metals at the temperature of the electric furnace and at the ordinary pressure,

it invariably crystallises out upon cooling in the form of graphite of density about 2; but that when the operation is performed under increased pressure the density and hardness of the carbon which eventually separates are augmented, and black diamonds are produced in considerable quantity. A modification of the original form of these pressure experiments is now described, which results in the production of small but perfectly transparent and colourless diamonds similar to those found naturally. The former experiments were made with iron and silver as solvents for the carbon, the mixture of metal and excess of charcoal being heated in the arc of the electric furnace under pressure until most of the charcoal was dissolved in the white-hot metal, after which the hot crucible was thrown into a tank of water to effect sudden cooling. Bismuth has since been tried as a solvent but is not found suitable, as a violent explosion is caused when the fused mass is projected into water, probably owing to the sudden decomposition of a carbide of bismuth. Iron is therefore used, and the cooling is effected by pouring the contents of the crucible into a bath of just melted lead. The solution of carbon in molten iron, being lighter than liquid lead, rises to the surface in spherical globules; the smaller spheres solidify before reaching the surface of the lead, but the larger ones are still liquid and are still so hot that they cause the lead at the surface to burn in contact with the air, incandescent particles of metal and oxide being projected out, and torrents of fumes of litharge produced. Upon removing the globules floating at the surface of the lead, dissolving their leaden coating in nitric acid, and subsequently removing the iron by suitable solvents, as previously described by M. Moissan, the transparent diamonds are readily isolated. They frequently exhibit well-defined crystal faces, which are usually curved and striated and etched with cubical markings exactly like those of natural diamonds. They possess the same wonderful limpidity, high refractive power, hardness, and density (3.5) as native diamonds, and exhibit many of the properties, such as anomalous polarisation and occasional spontaneous disruption, owing to their state of strain resulting from their formation under high pressure, which are characteristic of some Cape diamonds. The hemihedral forms of the cubic system appear to predominate in the crystals examined. They scratch rubies, and resist the action of a mixture of potassium chlorate and fuming nitric acid, but burn in oxygen at a temperature of about 900° with formation of pure carbon dioxide.

NOTES from the Marine Biological Station, Plymouth.—During the past fortnight the alga *Halosphaera viridis* has frequently been present in the tow-nettings. The proportion of Mollusc, Polychæte, and Cirrhipede larvæ to the rest of the floating fauna has become still greater. The medusa *Phialidium variable* is obtainable in about the same numbers as previously, and a few *Obelia* medusæ have made their first appearance for the year; but, strange to say, *Rathkea octopunctata* has not been observed, and even the ephyræ of *Aurelia*, although numerous in the open Channel, have been scarce within the Sound. No Echinoderm larvæ have been yet observed. The Hydroids *Tubularia indivisa*, *Eudendrium ramosum*, and *Sertularia argentea*, and the Molluscs *Nassa reticulata*, *Lamellaria perspicua* and *Lamellidoris pusilla* are now breeding.

THE additions to the Zoological Society's Gardens during the past week include two Mozambique Monkeys (*Cercopithecus pygerythrus*, ♂♂) from East Africa, presented by Lt.-Gen. Owen L. C. Williams; a Hooded Crow (*Corvus cornix*) from Norway, presented by Mrs. Wroughton; a Puff Adder (*Vipera arictaus*), a Hoary Snake (*Coronella cana*) from South Africa, presented by Mr. B. Matcham; a Hairy Porcupine (*Sphingurus villosus*) from Brazil, deposited.

NO. 1270, VOL. 49]

#### OUR ASTRONOMICAL COLUMN.

A LARGE SUN SPOT.—During the foggy days of last week, when the brightness of the sun was not too great to permit direct observation, a sun-spot, which was very plainly visible to the naked eye, attracted general attention. It was first seen in the south-east quadrant on February 19, and will probably pass off the visible disc about March 2. It has been somewhat remarkable for its relatively large penumbra and the scattered character of the umbra; a very distinct nucleus was also observed. In the course of an interview, Mr. Maunder stated that the spot was at a maximum on February 20, when it was about 48,000 by 46,000 miles, and the area 1870 millions of square miles. It was therefore much smaller than the great spot of February 1892. Though the magnetic disturbances have not been so great as in the case of the 1892 spot, a marked effect on the Greenwich recording magnets was noticed at 3.15 p.m. on February 20, the disturbance lasting about twenty-seven hours. After an interval of about twenty-four hours, another and more intense storm commenced, and reached a maximum at 3 p.m. on February 23. In the case of the spot of February 1892, the violent magnetic storms occurred after the spot had passed the central meridian; but in the present instance, the disturbances seem to have preceded the central transit of the spot.

ANDERSON'S VARIABLE IN ANDROMEDA.—Prof. E. C. Pickering announces in *Astronomische Nachrichten* (No. 3213) that an examination by Mrs. M. Fleming of photographs taken at the Harvard College Observatory confirms the variability of the star in the constellation Andromeda (R.A. oh. 14m. 48s. Decl. +26° 10'3) observed by Dr. Anderson (*NATURE*, Nov. 30, 1893). The observations, and those quoted by Dr. Anderson, as having been made at Bonn and Cambridge, indicate that the period of the variable is 281 days, and that the next maximum will occur on March 30. A determination of the form of the light curve led to the interesting result that during the three months following a maximum, the diminution in light is at the uniform rate of one magnitude in twenty-five days; for the three months preceding the maximum the increase is also uniform, and at the rate of one magnitude in twenty-six days. Prof. Pickering points out that this great uniformity in the variation in light of the star appears less extraordinary if a similar uniformity in the diminution of the light of Nova Aurigæ is considered. From March 7 to March 31, 1892, the light of this star diminished from magnitude 6.3 to 13.3 with almost perfect regularity at the rate of three-tenths of a magnitude per day.

Following Prof. Pickering's note is one in which Dr. E. Hartwig gives observations to show that the next maximum of the variable under consideration will occur on March 10, and that the period of variability is 74.4 days.

A BRIGHT METEOR.—Mr. Andrew Greig writes to us as follows:—"A very bright meteor was seen at Dundee at 7h. 18½m. p.m. on Wednesday, February 21. It was little to the east of south, and midway between Sirius and Orion's belt. It was falling in a westerly direction, or parallel to a line joining the stars Betelgeux and Rigel. It was visible for about three seconds. There was a slight haze above both southern and northern horizons at the time, but Vega could easily be seen low down in the north. The portion of the sky around Jupiter and the Pleiades was quite clear. 'Streamers' were observed in the north for about three minutes afterwards."

This meteor was also seen in North Lincolnshire. To an observer in that district it appeared in the north-west by northern part of the sky, and fell in a westerly direction. Among other places in which the object was observed are Colwyn Bay, Whitby, Howden, and Sandal; but no details as to the path it traversed, or the times of observation, have reached us from these places. An explosion was heard at Colwyn Bay, but no sound is mentioned by other observers.

#### THE BAKERIAN LECTURE.

AN investigation on the internal friction of liquids, carried out by Prof. T. E. Thorpe, F.R.S., and Mr. J. W. Rodger, formed the subject of the Bakerian Lecture delivered at the Royal Society on February 22. The following is an abstract of the communication:—

The purpose of this paper is to throw light upon the relations between the viscosity of homogeneous liquids and their chemical nature.

The first of the three parts into which the paper is divided contains a summary of the attempts which have been made, more particularly by Poiseuille, Graham, Rellstab, Guerout, Pribram and Handl, and Gartenmeister, to elucidate this question. Although it is evident from the investigations of these physicists that relationships of the kind under consideration do exist, it must be admitted that they are as yet not very precisely defined mainly for the reason that the conditions by which truly comparable results can alone be obtained have received but scant consideration.

For example, it seems futile to expect that any definite stoichiometric relations would become evident by comparing observations taken at one and the same temperature. Practically, nothing is known of a quantitative character concerning the influence of temperature on viscosity.

From the time which a liquid takes to flow through a capillary tube under certain conditions, which are set out at length in the paper, a measure of the viscosity of the liquid can be obtained.

An apparatus was, therefore, designed on this principle which admitted of the determination in absolute measure of the viscosity, and for a temperature range extending from 0° up to the ordinary boiling point of the liquid examined.

Full details of the conditions determining the dimensions of the apparatus and of the modes of estimating these dimensions, together with the methods of conducting the observations, are given in the paper, and the corrections to be applied to the direct results are discussed.

The question of the mathematical expression of the relation of viscosity of liquids to temperature is considered, and reasons are given for preferring the formula of Slotte—

$$\eta = c/(1 + bt)^n$$

$\eta$  is here the coefficient of viscosity in dynes per square centimetre, and  $c$ ,  $b$ , and  $n$  are constants varying with the liquid.

With a view of testing the conclusions set out at length in the historical section of the paper, and, in particular, of tracing the influence of homology, substitution, isomerism, and, generally speaking, of changes in the composition and constitution of chemical compounds upon viscosity, a scheme of work was arranged which involved the determination, in absolute measure, of the viscosity of some seventy liquids, at all temperatures between 0° (except where the liquid solidified at that temperature) and their respective boiling points.

Part ii. of the memoir is concerned with the origin and modes of establishing the purity of the several liquids; it contains the details of the measurements of the viscosity coefficients, together with the data required to express the relation of viscosity coefficients to temperature by means of Slotte's formula, and tables are given showing the agreement between the observed and calculated values.

In Part iii. the results are discussed. In the outset the factors upon which the magnitude of the viscosity probably depends are dealt with. The influence of possible molecular aggregations, as indicated by observations of vapour densities, boiling points, and critical densities, and, more especially, by measurements of surface energy, made by Eötvös in 1886, and more recently by Ramsay and Shields, are taken note of.

The deductions which may be made by considering the graphical representation of the results, showing the variations of viscosity coefficients with temperature, are then set forth.

For liquids which probably contain simple molecules, or for which there is little evidence of association of molecules at any temperature, the following conclusions may be drawn:—

(1) In homologous series the coefficient of viscosity is greater, the greater the molecular weight.

(2) An iso-compound has always a smaller viscosity coefficient than the corresponding normal compound.

(3) An allyl compound has, in general, a coefficient which is greater than that of the corresponding isopropyl compound, but less than that of the normal propyl compound.

(4) Substitution of halogen for hydrogen raises the viscosity coefficient by an amount which is greater, the greater the atomic weight of the halogen; successive substitutions of hydrogen by chlorine in the same molecule bring about different increments in the viscosity coefficients.

(5) In some cases, as in those of the dichlorethanes, substitution exerts a marked influence on the viscosity, and in the case of the dibromides and benzene, it may be so large that the compound of higher molecular weight has the smaller viscosity.

(6) Certain liquids, which probably contain molecular com-

plexes, do not obey these rules. Formic and acetic acids are exceptions to Rule 1. The alcohols at some temperatures, but not at all, are exceptions to Rule 2; at no temperatures do they conform to Rule 3.

(7) Liquids containing molecular complexes have, in general, large values of  $d\eta/dt$ .

(8) In both classes of liquids the behaviour of the initial members of homologous series, such as formic acid and benzene, is in some cases exceptional when compared with that of higher homologues.

As regards the influence of temperature on viscosity, it is found that the best results given by Slotte's formula are in cases where the slope of the curve varies but little with the temperature. From the mode in which the values of the constants  $n$  and  $b$  are derived, it cannot be expected that their magnitudes will be related in any simple manner to chemical nature. With the exception of certain liquids, such as water and the alcohols, which are characterised by large temperature coefficients, and in which there is reason to expect the existence of molecular aggregates, the formula

$$\eta = c/(1 + \beta t + \gamma t^2),$$

obtained from Slotte's expression by neglecting terms in the denominator involving higher powers of  $t$  than  $t^2$ , gives a close agreement with the observed results, and in this formula the magnitude of  $\beta$  and  $\gamma$  are definitely related to the chemical nature of the substances.

In order to obtain quantitative relationships between viscosity and chemical nature, and to compare one group of substances with another, it is necessary to fix upon particular temperatures at which the liquids may be taken as being in comparable conditions as regards viscosity, and to compare the values of the viscosities at those temperatures.

The first comparable temperature which suggested itself was the boiling point.

A second comparable temperature was obtained by calculating values of corresponding temperatures by the method of van der Waals with such data as could be obtained.

The third basis of comparison consisted in using temperatures of equal slope, *i.e.* temperatures at which the rate of change of the viscosity coefficient is the same for all liquids.

At each of the different conditions of comparisons, the experimental results have been expressed according to the same system, in order to show at a glance relationships between the magnitudes of the viscosity constants and the chemical nature of the substances. The liquids are arranged so that chemically related substances are grouped together. Tables are constructed which give the values of the three different magnitudes derivable from measurements of the viscosity of the substances.

(1) Values of viscosity coefficients ( $\eta$ ).

(2) Values of  $\eta \times$  molecular area, *i.e.* molecular viscosity.

(3) Values of  $\eta \times$  molecular volume, *i.e.* molecular viscosity work.

The coefficient  $\eta$  is the force in dynes which has to be exerted per unit-area of a liquid surface in order to maintain its velocity relative to that of another parallel surface at unit distance equal to unity. It seemed, however, that relations between viscosity and chemical nature would best be brought to light if, instead of adopting merely unit-areas, areas were selected upon which there might be assumed to be the same number of molecules. The *molecular viscosity* is proportional to the force exerted on a liquid molecule in order to maintain its velocity equal to unity under the unit conditions above defined. With the units chosen it is the force in dynes exerted on the molecular area in square centimetres under unit conditions. The *molecular viscosity work* may be regarded as proportional to the work spent in moving a molecule through the average distance between two adjacent molecules under unit conditions. In ordinary units it is the work in ergs required to move a surface equal to the molecular area in square centimetres through the molecular length in centimetres.

In the case of the comparison of the viscosity coefficients at the boiling point, it is found:

(1) As an homologous series is ascended, in a few cases the viscosity coefficient remains practically the same, but in the greater number of series the coefficients diminish. In one series the coefficients increase; in the case of the alcohols the coefficients vary irregularly with ascent of the series.

(2) Of corresponding compounds, the one having the highest molecular weight has in general the highest coefficient (the



aliphatic acids, and to a much greater extent the alcohols, do not conform with this rule).

(3) Normal propyl compounds have, as a rule, slightly higher values than allyl compounds; in the case of the alcohols, propyl compounds have much the higher value.

(4) The effect of molecular weight in some cases may be more than counterbalanced by that of constitution, or of complexity.

(5) The lowest members of homologous series frequently exhibit deviations from the regularity shown by higher members.

(6) An iso-compound has in general a larger coefficient than a normal compound, and the differences reach their maximum in the case of the alcohols.

(7) In the case of other metameric substances, branching in the atomic chain and the symmetry of the molecule influence the magnitudes of the coefficients; the ortho-position, in the case of aromatic compounds, appears to have a more marked effect on the coefficient than either the meta- or para-position. Acetone and ether have coefficients that are less than half the values given by the isomeric alcohols.

(8) One of the most striking points thus brought to light is the peculiar behaviour of the alcohols, and to some extent of the acids, as contrasted with that of other liquids.

Comparisons of molecular viscosity at the boiling point show—

(1) That, with the exception of the alcohols, dibromides, and the lowest members of homologous series, an increment of  $\text{CH}_2$  in chemical composition corresponds with an increase in molecular viscosity.

(2) With the above exceptions, it is also apparent that the corresponding compound having the highest molecular weight has the highest molecular viscosity: the difference in molecular viscosity between the corresponding members of two correlated series is fairly constant.

(3) The relationships shown in the other tables are substantially of the same nature as those given by the viscosity coefficients.

The comparisons which give the largest deviation from regularity contain those substances which, as already shown, exhibit a peculiar behaviour, namely, the alcohols, acids, propylene dibromide, ethylene dichloride, &c.

In order to indicate how molecular viscosity at the boiling point is quantitatively connected with chemical nature, attempts were made to calculate the probable partial effects of the atoms on the molecular viscosity. Values were also assigned to the effects of the iso-grouping of atoms, the double linkage of carbon atoms, and the ring grouping.

Tables are given which show the concordance between the observed molecular viscosity and those calculated by means of these constants. In the case of forty-five liquids the difference between the observed and calculated values rarely exceeds 5 per cent. In the case of the isomeric ketones and aromatic hydrocarbons, the differences are in part due to constitutive influences, which cannot at present be allowed for in obtaining the calculated values.

In a second table are given those substances for which the differences exceed this 5 per cent. limit. These may be roughly classed as unsaturated hydrocarbons, polyhalogen compounds, formic and acetic acids, benzene, water, and the alcohols.

Similar fundamental constants for molecular viscosity work at the boiling point have also been deduced, and tables are also given showing the comparison between the observed and calculated numbers, the substances being classified into two groups, as in the case of molecular viscosity, according as the differences are less or greater than about 5 per cent.

On taking a general survey of the comparisons at the boiling point, it is evident that for the majority of the substances examined—the paraffins and their monohalogen derivatives, the sulphides, the ketones, the oxides, and most of the acids and the aromatic hydrocarbons—molecular viscosity and molecular viscosity work may be quantitatively connected with chemical nature. The remaining substances—unsaturated hydrocarbons, di- and poly-halogen compounds, formic acid, benzene, water, and the alcohols—present marked exceptions to the foregoing regularities.

As regards the comparison of the viscosity magnitudes at the corresponding temperature, it is found that, although the critical data are too unsatisfactory to warrant us in laying any particular stress on the relationships obtained under this condition of comparison, these relationships are similar to, even if less definite

than, those obtained at the boiling point. For a property like viscosity, which alters so rapidly with temperature, a corresponding temperature is no better as a condition of comparison than the boiling point.

The third series of comparisons was made at temperatures at which  $d\eta/dt$  is the same for the different liquids. Or, graphically, the temperatures may be defined as those corresponding with points on the viscosity curves at which tangents are equally inclined to the axes of coordinates. The temperatures are therefore those at which temperature is exercising the same effect on viscosity, and for shortness may be termed *temperatures of equal slope*. The temperatures were obtained by means of Slotte's formula.

It was apparent from the shape of the curves that all the liquids could not be compared at any one value of the slope, because the effect of temperature on the slope varied so much from substance to substance. In some cases—the whole of the alcohols for example—the slope at the boiling point was considerably greater than that at  $0^\circ$  in the case of some of the less viscous liquids. A slope was, therefore, selected at which as many liquids as possible could be compared. Another slope was then obtained at which the outstanding liquids could be compared with as many as possible of the liquids used at the original value of the slope. The relationships between the magnitudes of the viscosities of these liquids which could be compared at the two slopes were then found to be the *same at either slope*, so that general conclusions regarding the behaviour of all the liquids could be deduced. These are as follows:—

(1) Temperatures of equal slope tend to reveal much more definite relationships between the values of viscosity coefficients and the chemical nature of substances than are obtained at the boiling point.

(2) In all homologous series, with the exception of those of the alcohols, acids, and dichlorides, the effect of  $\text{CH}_2$  on the value of the coefficient is positive, and tends to diminish as the series is ascended.

(3) Of corresponding compounds the one of highest molecular weight has the highest coefficient.

(4) Normal propyl compounds have slightly larger coefficients than the corresponding allyl compounds.

(5) An iso-compound has invariably a larger coefficient than a normal compound.

(6) In the case of other isomers the orientation of the molecule and branching of the atomic chain influence the magnitudes of the coefficients. Similar effects of constitution are also exhibited on comparing saturated and unsaturated hydrocarbons, and the variable effects produced by successive substitution of halogen for hydrogen.

(7) The alcohols, and to some extent the acids, still give results which are peculiar when compared with other substances.

As regards molecular viscosity at equal slope the following conclusions may be drawn:—

(1) For the great majority of the substances molecular viscosity at equal slope can be calculated from fundamental constants which express not only the partial effects of the atoms existing in the molecule, but also those due to different atomic arrangements.

The large effects which can be attributed to the ring-grouping of atoms, to the iso-linkage, to double-linkage, and to changes in the condition of oxygen in its compounds, as well as the smaller effects due to the accumulation of atoms of halogen in a molecule, render evident the quantitative influence of constitution.

(2) Of the remaining substances the chlormethanes, terrachlorethylene, ethylidene chloride and carbon bisulphide give deviations from the calculated values on account of constitutive influences not allowed for in obtaining the fundamental constants.

(3) The alcohols and water exhibit no agreement with the calculated values. The mode in which deviations vary indicates, in the case of the alcohols, that the disturbing factor is related to their chemical nature.

The results obtained from the consideration of molecular viscosity work at equal slope, are of precisely the same nature as those discussed under molecular viscosity.

The substances which give deviations from the calculated values fall into two classes. In the first the deviations are to be attributed to chemical constitution, inasmuch as similar disturbing effects may be detected in the magnitudes of other

physical properties which afford no evidence of being influenced by molecular complexity.

In the second are substances like the acids, water, and the alcohols, for which the disturbing factor is, no doubt, molecular complexity.

The question of the generality of the results obtained is next discussed. It is evident:

(1) That over such temperature ranges as the observations extend the results obtained at a particular value of the slope may be regarded as general for all liquids, with the exception of the alcohols, for which the relationships vary slightly as the slope alters. A general expression connecting the viscosity coefficient with the slope is given.

(2) It is further indicated, from comparisons made by the use of slopes which varied from liquid to liquid, and which were chosen according to definite systems, that in the present state of the question equal slope is the most suitable condition at which to compare the viscosities of different liquids.

With respect to the relationships existing between the magnitudes of the comparable temperatures of equal slope, it appears:—

(1) That these vary in a regular way with the chemical nature of the substances, except in the case of liquids like benzene and propylene dibromide, giving viscosity curves which are abnormal when compared with those of their homologues.

(2) The temperature relationships may also be regarded as general and thus independent of the value of the slope, except in the case of the alcohols, which, in this respect, as in that of viscosity at equal slope, are anomalous.

The rest of the memoir is concerned with the discussion of certain general conclusions regarding physicochemical comparisons; and it finally deals with other possible methods of obtaining and comparing viscosity magnitudes.

#### THE DYNAMICS OF THE ATMOSPHERE.

UNDER this title a series of articles appeared in the *Meteorologische Zeitschrift* for May, August, and September, 1893, from the pen of Prof. M. Möller, of Brunswick, which treat of many of the important processes that are at work in our atmosphere.

The principal feature in these discussions is that the author treats the various phenomena as the result of complicated processes, and inquires into their character separately, prior to attempting to draw conclusions from them, so that some relations are presented in a new form.

With regard to the part which aqueous vapour plays in the atmosphere, it is usually stated that the heat set free in condensation during the formation of clouds greatly favours the origin of ascending air-currents, but Möller takes another view of the matter. Two columns of air have usually been compared with each other, having at their base similar initial temperature, but in which the decrease of temperature with height proceeds in a different manner, as one column is supposed to contain dry air, that is very cold at the upper end, and the other moist air warmed by condensation. But the author considers that this difference of temperature does not actually occur in this manner, and that all theories based upon this assumption must lead to erroneous results. He states that as the air of the upper strata has risen up previously, it has consequently gone through the process of warming by condensation, so that the increase of heat caused by condensation cannot produce by itself a higher temperature in the ascending current than that possessed by the surrounding air, hence the cause of the upward impulse, which has been attributed to the aqueous vapour of the air, disappears. If it is wished to produce a circulation of the air in two vertical tubes in communication at both ends, the air in the bottom part of the one tube must be warmed, while that in the upper part of the other tube is cooled; but if the source of heat is applied at the top, a condition of stable equilibrium and rest takes place. In the same way the condensation of the aqueous vapour causes a warming of the upper strata of air, the effect of which is generally to produce a condition of stable equilibrium, contrary to the theory which assumes that the condensation of the vapour favours the ascending current, and consequently gives rise to depressions. The author attributes the chief cause of the origin of cyclones to horizontal differences of temperature in the earth's atmosphere, to the

steep gradients of the upper strata caused by them, and the consequent strong movements of the air in those regions. He agrees in the main with the views of Ferrel, but attributes greater importance to the effect of friction against the rough surface of the earth. The air which rises at the equator, and moves in the upper regions towards the pole, takes, according to the law of the pre-emption of the moments of rotation, a west to east velocity, whose right-handed deflective force in the northern hemisphere is opposed to the poleward motive effect of the upper gradient.

According to Prof. Möller, this right-handed force over the dry zone, in the belts of high pressure, on both sides of the tropics, and in higher latitudes, becomes so great that a condition of equilibrium of the forces is produced in the direction of the meridians. Apart from local disturbances, the upper wind here follows the parallels of latitude, unless owing to friction, or the mixing of the upper and lower strata, a diminution of the upper current occurs, whereby the meridional deflecting force of the upper gradients gains the mastery over the decreased right-handed deflective force arising from the centrifugal effect. Only then, and in proportion as this diminution of the upper current occurs, does the upper current follow the meridional upper gradient. In this case a part of the energy gained in the upper currents of the atmosphere is transferred to the lower strata, so that there the velocities which are directed from west to east increase. The atmosphere, therefore, in the temperate and polar zones is like a calorific machine, which first produces by meridional gradients of temperature the upper gradients of pressure, and consequently an air current from west to east at a great height, whose transference to the lower strata of air depends upon opportunities of friction or mixture of masses of air. The meridional advance of air in the upper air-current is checked by the centrifugal force; for the advance to the pole increases the velocity of the west wind, and thus the centrifugal right-handed deflective force whose effect stops the meridional advance of air to the pole. Möller states that this important relation of interchange was not clearly expressed in Ferrel's theory. He first assumes that a circulation between the hot and cold zones takes place unhindered, and, provided the circulation takes place, he makes the high velocities to exist in the upper current. Ferrel also computes the great forces which would be necessary in order to produce those high velocities, and he admits that these really do not exist. He speaks of this theory as only approximately correct, whereas the computed forces and great meridional differences of pressure fail in nature, and the high westerly wind-velocities, such as his theory requires, do not exist.

Prof. Möller concludes (1) that the regular and undisturbed circulation of the atmosphere between the hot and cold zones is not accomplished in the manner hitherto supposed, and as has been presumed in Ferrel's calculations, and states that if Ferrel's theory is to become of practical use, it will be necessary to study more exactly the relations between the friction of air on the surface of the earth, and especially the friction or the mixture of air between upper and lower strata. (2) If friction of air against the earth's surface is great, the velocity of the winds is less; but if friction, or mixture of air, between upper and lower strata is great, then the lower winds blow more violently. (3) In higher latitudes no storm can be caused by horizontal meridional gradients of temperature without mixture or friction between the upper and lower strata.

#### UNIVERSITY AND EDUCATIONAL INTELLIGENCE.

OXFORD.—The Savilian Professor of Astronomy, Mr. H. H. Turner, gave his inaugural address on Friday last, in the new schools, before the Vice-Chancellor and a large audience. The Professor illustrated his subject, "The International Photographic Chart of the Heavens," by numerous lantern-slides, and referred particularly to the large share in the work allotted to the Oxford Observatory, and to the progress which had already been made.

Prof. Sylvanus P. Thompson gave a lecture before the Ashmolean Society on Monday last, on the subject of "Magic Mirrors." The lecture was illustrated by numerous specimens and experiments, and was much appreciated by a large audience.

An election to the Siphthorian Professorship of Rural Economy is announced to take place in Easter Term, 1894.

Candidates are to send in their applications to the Registrar of the University on or before April 21. The tenure of the Professorship is limited to three years, at the expiration of which the Professor may be re-elected for a further period of three years, but no one may hold the Professorship for more than six years consecutively.

The committee on Degrees for Research have presented a long report to the Hebdomadal Council, which has been approved by that body. The report contains recommendations that will beneficially affect the study of Science in the University. It is proposed that degrees of M.Sc. and M.Litt. shall be established which shall be open (a) to members of the University of Oxford who have taken the B.A. degree, and (b) to students, not being graduates of Oxford, who can give satisfactory proof of general education and fitness to enter upon a special course of study. Three years' residence will be required from the second class of students, or two years from those who have studied for at least two years in a university or local college approved by Convocation, or in an affiliated college. No candidate is to be admitted who is under the age of twenty-one, and every candidate not being a member of the University shall be required to matriculate, and to pursue his studies during his term of residence under the supervision of a committee appointed by a special Delegacy to be established for the purpose. In supplicating for the Degree, every candidate must produce a certificate from the Delegacy stating the line of study or research which he has pursued, accompanied by a report, drawn up by the candidate, of the work he has done.

CAMBRIDGE.—Honorary Degrees are to be conferred on the Earl of Kintore, Governor of South Australia, whose adventurous journey across that continent will be remembered, and on Prof. Ramón y Cajal, of Madrid, the Croonian lecturer of this year.

Lord Rayleigh has been appointed an Elector to the Professorships of Chemistry and of Mechanism, Sir R. Ball to the Plumian Professorship, Sir G. Humphry to that of Anatomy, Sir G. G. Stokes to the Jacksonian and the Cavendish Professorships, Dr. D. McAlister to the Downing Chair of Medicine, Dr. Hugo Müller to the Chair of Mineralogy, Prof. Chiene to the Professorship of Surgery, and Sir James Paget to that of Pathology.

Dr. Shore has been appointed an Examiner in Physiology in place of Dr. A. S. Lea, who is unable to examine owing to ill-health.

ON February 24, the Prince of Wales formally opened the new Polytechnic in Battersea, which has been erected at a cost of nearly £60,000. The institute forms the third of a trio of polytechnics in South London, the others being situated in the Borough-road and at New-cross, respectively. The latter institute, for which the Goldsmiths' Company provided the entire funds, namely £70,000, and an endowment of £5,000 a year, has now been open for some time, and has proved a signal success. The Borough-road institute cost about £50,000, and has been open for about a year.

DR JOHN T. HEWITT, Assistant-Demonstrator at the Cambridge University Chemical Laboratory, has been appointed by the Governors of the People's Palace to the vacant Professorship of Chemistry. Dr. Hewitt was a student of the Royal College of Science from 1884 to 1887. In 1886 he obtained a foundation scholarship at St. John's College, Cambridge, and was awarded a first class in chemistry in both parts of the Natural Science tripos. He afterwards studied in Heidelberg, and took the degree of Ph.D. in that University in 1892, having previously obtained a Hutchinson research studentship. Dr. Hewitt is a Doctor of Science of the University of London, where he obtained the exhibition and scholarship for chemistry. He has also successfully carried out some important chemical researches.

#### SCIENTIFIC SERIALS.

The *Quarterly Journal of Microscopical Science* for January, 1894, contains observations on the development of the head in *Gobius capite*, by H. B. Pollard. (Plates 21 and 22.) The stages of development of the brain, mouth, and mesodermal structures are described. The work was carried out during the occupation of the Oxford table at the Naples Zoological Station.—On the head kidney of *Myxine glutinosa*, by J. W. Kirkaldy. (Plate 23.) It would seem that the pronephros in *Myxine* may

be regarded as a stage in the phylogenetic reduction of this organ—a reduction which continues in the Pisces until the tubular structure entirely disappears, and, further, that it represents in *Myxine* the mesoblastic part of the supra-renal bodies.—Report on a collection of *Amphioxus* made by Prof. A. C. Haddon in Torres Straits, 1888-89, by Arthur Willey. All the specimens belonged to the same species, *Epiplatys subellus*, Peters. One of the most remarkable features in its internal organisation is the fact that the gonads occur as a unilateral series of pouches confined to the right side of the body; in connection with this fact the author adds, that often in the Mediterranean form the gonadic pouches of the right side preponderate greatly over those of the left side in number.—On the orientation of the frog's egg, by Dr. T. H. Morgan and Umé Tsuda. (Plates 24 and 25.)—On the fossil Mammalia from the Stonesfield Slate, by E. S. Goodrich. (Plate 26.) In this excellent account of these very interesting fossils, we have detailed descriptions and figures of *Amphitherium Procosti*, Blainv., *A. Oweni*, Osborn, *Phasciotherium Buchanani*, Broderip, and *Amphilestes Broderipi*, Owen. The only specimen of *Stereognathus colticus*, Charlesworth, was in too fragmentary a state to be re-described. In a foot-note Prof. E. Ray Lankester gives some graphic reminiscences of another Stonesfield fossil, probably belonging to another species of *Stereognathus* which was once in his possession.—On a Polyoid with branchiæ (*Eupolyodontes Cornishii*), by Florence Buchanan. (Plate 27.) This species was found off the mouth of the river Congo by Mr. Cornish, of the cable ship *Mirror*; a list of the species belonging to the sub-family Acetoidæ is given, and the new species with *Polyodontes gule*, Grube, are placed in the new genus *Eupolyodontes*.—On some Bipinnariæ from the English Channel, by Walter Garstang. (Plate 28.)—On *Octineon Lindahli* (W. B. Carpenter), an undescribed Anthozoon of novel structure, by Dr. G. Herbert Fowler. (Plates 29 and 30.) This remarkable form was dredged in 1870 during the *Porcupine* expedition off the south coast of Spain, not far from Cape St. Vincent, in 364 fathoms of water. It was to have been described by Dr. W. B. Carpenter, who died before doing so; the specimens were then entrusted to Prof. Moseley, who was unable to finish the work before his death; now we have the memoir completed by Dr. Fowler. In a dead condition the animal presents the form of a thin sandy disc, not exceeding 0.4 of an inch in diameter. "In *Octineon* we have an Actinarian with the characteristic habit of a Zoanthid, with the twelve mesenteries of a Hexactinian, and the eight muscles of an Edwardsid," and the evidence seems in favour of the view that it is the type of a new and highly specialised family, descended from true Hexactinian ancestors.

*American Meteorological Journal*, February.—Recent foreign studies of thunderstorms: IV. Italy, by R. De C. Ward. Systematic study of thunderstorms in Italy was begun in 1877; in 1880 the Central Meteorological Office took up the work, and the results have been regularly published in its *Annals* by Dr. C. Ferrari. The majority of storms come from north-west and west, those from the western quadrant have the greatest velocity, and those which occur in summer have a greater velocity than those in spring or autumn. The chief causes of their development are high temperatures, high vapour pressure, and calm atmosphere. Ferrari's investigation of thunderstorm phenomena is the most complete of any yet published.—Certain climatic features of Maryland, by W. B. Clark. The records of temperature and rainfall, published by the State Weather Service, show an intimate connection between the climate and the topography of the State. The mean annual temperature of the extreme western portion is 50°, while along the eastern border it rises to 58°, and the variations of the seasons are still more pronounced. The rainfall also shows perceptible differences; in the west the average is 38.5 inches, and in other parts nearly 44 inches.—Ten miles above the earth, by H. A. Hazen. This paper contains an account of the ascent of a balloon sent up by M. G. Hermite in Paris, on March 21, 1893. The highest point reached is computed to be 52,500 feet, and, according to the law of the diminution in temperature, the lowest temperature was probably not far from -104° F., but the trace was lost, owing to the freezing of the ink in the thermograph pen. The other articles are: Measurement of the seasons, by H. Gawthrop (a method is proposed by which, using the daily means as the unit, the progress of a season may be determined and graphically illustrated), and the climate of Louisiana, by R. E. Kerkham, compiled from the State Weather Service records of the past six years.

*Meteorologische Zeitschrift*, December 1893.—Comparison of mercurial barometers with boiling-point thermometers, by Colonel H. Hartl. The author has made several comparisons with the above-mentioned instruments since 1876, and finds that properly constructed and verified thermometers form very good substitutes for barometers, and are capable of giving very accurate determinations of air pressure, especially where it is a question of differences of pressure, rather than of absolute values. They are very useful as a check on the aneroid, and the author considers them indispensable for travellers who wish to determine heights of mountains.—On the determination of differences of temperature and humidity between forest and field, by Dr. J. Schubert. A series of observations was made at Eberswald during 1892 with carefully exposed instruments, the result being that the author considers that much of the difference hitherto found to exist may be due to imperfect exposure of the instruments, and to the times at which the observations were taken. He advocates further observations, with the use of the aspirating hygrometer, by which a free circulation of the air about the bulbs is ensured.

In the number of the *Botanical Gazette* for December 1893, Mr. H. L. Russell completes his interesting account of the bacterial flora of the Atlantic Ocean in the vicinity of Woods Holl, Mass. He finds that bacteria exist in the mud of the ocean-bottom in large numbers, and that they multiply there freely, although they are not so numerous as in fresh water. The geographical distribution of the species is often extensive, and their vertical range exceeds that of the majority of the higher forms of life. The following new species are described:—*Bacillus limicola*, *B. pelagicus*, *B. litoreus*, and *B. maritimus*. Mr. M. A. Carleton describes a series of experiments on the germination of the spores of Uredineæ, especially in reference to the effects on the process of different chemicals. In the number for January 1894, Prof. Conway Macmillan proposes the terms archenema, protonema, and metanema, for the gametophytic structures below the ferns. Mr. A. Schneider describes the symbiosis of algae and bacteria in the tubercles on the roots of *Cycas revoluta*. The bacteria belong to the genus *Rhizobium*. Although the roots are abundantly covered with many different kinds of algae, the only species found in the cells of the tubercles was a *Nostoc*, probably *N. commune*. This abounds in the palisade-cells, where the *Nostoc*-colonies appear to take the place, and to serve the function of chloroplasts.

In the *Journal of Botany* for February, Mr. Jesse Reeves describes the development of the stem and leaves of *Physiotium giganteum*, which differ from other alogenous *Fungermanniæ* in the remarkable peculiarity of having a 2-sided instead of a 3-sided apical cell.—The Rev. W. Moyle Rogers adds yet three more new species (?) to the already long list of British *Rubi*, viz. *R. mollissimus*, *R. Powellii*, *R. britannicus*.

With the number for January 1894, the *Nuovo Giornale Botanico Italiano* commences its new series as the organ of the Italian Botanical Society, under the editorship of Prof. Arcangelì. The first number consists exclusively of papers on Italian botany.

## SOCIETIES AND ACADEMIES.

### LONDON.

Royal Society, February 1.—“The Action of Heat upon Ethylene.” By Vivian B. Lewes. From the work of the earlier observers, the text-books have accepted the equation

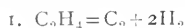

as representing the decomposition which takes place when ethylene is subjected to a very high temperature, whilst, on the evidence of the work done by Marchand, and Buff and Hoffman, they represent the change taking place at a lower temperature by the equation

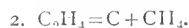

Berthelot, however, has come to the conclusion that two molecules of ethylene split up at a moderate temperature into acetylene and ethane.

The author has made an investigation upon the action which takes place at definite temperatures upon the ethylene, the products of decomposition being as quickly as possible removed from the heated zone.

The gas being passed through 140 mm. of heated tube, no change takes place until a temperature of 800° C. is reached, when traces of acetylene are observed; between 800° and 900° C. the acetylene increases in quantity, and large quantities of methane are generated, accompanied by liquid products. This action increases until just below 1200° C. when hydrogen begins to appear amongst the products of decomposition, whilst the moment the liberation of hydrogen commences, carbon also is deposited; and the formation of oil decreases until close upon 1500° C. when the decomposition of the ethylene is practically complete, and the products of decomposition are mainly hydrogen with some undecomposed methane, and a copious deposit of carbon.

When the products of decomposition of the ethylene are heated together for some time, ethane also is produced, but splits up at 900° C. into ethylene and hydrogen.



Analyses of the products of decomposition show that the primary action of heat upon ethylene may be represented by the equation



whilst the final decomposition is as represented by previous observers,

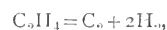

and that between these two extremes there occur a large number of interactions due to the polymerisation of the acetylene formed from the ethylene, and also at higher temperatures from the methane, according to the equation



February 1.—“On Hollow Pyramidal Ice Crystals.” By Dr. Karl Grossmann and Joseph Lomas.

February 8.—“Researches on the Germination of the Pollen Grain and the Nutrition of the Pollen Tube.” By Prof. J. Reynolds Green.

The whole of the researches described in the paper may be summarised as under:—

(1) Diastase and invertase are both present in pollen grains and can be extracted from them by the same treatment as has been found effectual in the cases of seeds and foliage leaves. The relative quantities vary a good deal; while some pollens contain both, others possess only one, which may be either of the two.

(2) At the onset of germination the amount of both diastase and invertase is usually considerably increased. In one species examined this increase was preceded by a primary diminution. When the pollen grain has lost the power of germinating, the quantity of diastase has considerably decreased.

(3) The pollen tube is nourished during its growth by plastic reserve material derived from two sources, the store of material in the grain itself, and a further store deposited in the style.

(4) The reserve store of the pollen grain consists of different materials in different species: starch, dextrin, cane sugar, maltose, and glucose being the forms in which it is found.

(5) The store in the style consists usually of the same carbohydrates, with the exception of dextrin.

(6) The style itself contains enzymes to assist in preparing the reserve materials for absorption by the pollen tube, while the latter excretes the same ferments during its progress down the conducting tissue.

(7) The absorption of food material appears to be one cause of the increase of enzyme found to occur during the germination.

(8) This absorption of food material is usually so active that the reserve store of the pollen grain is often largely increased by a temporary deposition, either in the grain or its tube, of some of the absorbed sugar in the form of starch.

(9) There is a certain amount of evidence pointing to the existence of zymogens in some pollens, particularly such as germinate in a faintly acid medium.

February 15.—“On the Straining of the Earth resulting from Secular Cooling.” By Charles Davison.

In this paper the problem as to the total volume of the earth's crust folded and crushed above the surface of zero strain is considered on the supposition that the coefficient of dilatation is not constant, but increases with the temperature. By this means it

has been found that, after 100 million years, the depth of the surface of zero strain is 7.79 miles, the total volume of crust-folding about 6,145,000 cubic miles, and the mean thickness of the layer formed by spreading it over the whole earth 164.7 feet. This result is much larger than that obtained when the coefficient of dilatation is taken as constant.

If the conductivity increases with the temperature, or if the material which composes the earth's interior be such that the conductivity and coefficient of dilatation are greater in it than in the surface rocks, or if initially the temperature increased with the depth, these figures must be still further increased. It follows, therefore, that calculations as to the alleged insufficiency of the contraction theory to produce mountain ranges are at present inadmissible.

"Chemical Analysis of the Meteoric Stone found at Makariwa, near Invercargill, New Zealand, in the year 1886." By L. Fletcher, F.R.S.

The results of a microscopic examination of this meteorite by Prof. Ulrich have already been published. Mr. Fletcher has now completed the chemical analysis of the stone, and in this paper gives a detailed account of the method and his observations, for the convenience of future analysts of such bodies.

The interest of the investigation is not in the mineralogical results, but in the study of a composite method applicable to the most complicated meteoritic chemical analysis, namely, that of a partially-rusted meteoric stone.

**Chemical Society, February 1.**—Dr. Armstrong, President, in the chair.—The following papers were read:—Note on the liberation of chlorine during the heating of a mixture of potassium chlorate and manganic peroxide, by H. McLeod. Brunck has recently stated that oxygen prepared by heating a mixture of potassium chlorate and manganese dioxide, contains ozone but not chlorine. The author now shows that the reverse of this is true, the gas containing chlorine but not ozone.—The examination of some recent freezing-point determinations, by S. U. Pickering. The differences between the results of the freezing-point determinations made by the author and H. Jones are apparently due to inaccurate calibration of the thermometer employed by the latter.—Salts of dehydracetic acid, by J. N. Collie and H. R. Le Sueur. The salts of dehydracetic acid have the general composition  $C_5H_7O_3M$ ; on heating at  $145^\circ$  they lose water, and the residual salts then have the composition  $C_8H_7O_4M$ . This water may be water of crystallisation; the question as to whether dehydracetic acid is a lactone or not, is hence still unanswered.—A new method of producing carbon tetrabromide, by J. N. Collie. A very large number of organic compounds yield carbon tetrabromide when heated with a strong solution of sodium hypobromite.—Metallic derivatives of acetylene. Mercuric acetylide, by M. Travers and R. T. Plimpton. Mercuric acetylide is a white explosive powder, and probably has the composition  $3C_2H_2Hg_2O_2$ .—Synthesis of indene, hydrindene, and some of their derivatives, by W. H. Perkin, junr., and E. Révay. On heating barium hydrindenecarboxylate, indene, and not hydrindene, is obtained; the indene, however, seems to be isomeric with ordinary indene.

**Mathematical Society, February 8.**—Mr. A. B. Kempe, F.R.S., President, in the chair.—At the request of Lord Kelvin, P.R.S., Mr. J. J. Walker, F.R.S., exhibited and described Lord Kelvin's models of his "Tetraikadecahedron." Votes of thanks were passed to Lord Kelvin and to Mr. Walker. A conversation ensued, in which Messrs. S. Roberts, F.R.S., Forsyth, F.R.S., MacMahon, F.R.S., Elliott, F.R.S., Colonel Cunningham, R.E., and the President took part.—Abstracts were communicated of the following papers:—On a class of groups defined by congruences, by Prof. W. Burnside, F.R.S., and some properties of the uniodal quartic and quintic having a triple point, by Mr. W. R. W. Roberts. Most of the properties of the curves, discussed by Mr. Roberts, are derived by the aid of Abelian integrals.

**Linnean Society, February 15.**—Prof. Stewart, President, in the chair.—Mr. W. B. Hemsley exhibited some germinating seeds of *Lemma* and some flowering plants of *Lemma gibba*, upon which, in his absence, some remarks were made by Mr. C. H. Wright. From the observations made it was suggested that, although *Lemma minor* and *L. gibba* are usually regarded as distinct, they are respectively the male and female plant of one species. On behalf of the Director of the Royal Gardens, Kew, Mr. C. H. Wright

exhibited and made some remarks upon a collection of native plants from the neighbourhood of Cape Town, which had been presented to the Herbarium by Miss Yorke, and which was remarkable for the skilful way in which the natural colours of the flowers had been preserved.—On behalf of the Rev. J. G. Tuck, of Tostock Rectory, Bury St. Edmunds, there was exhibited a hybrid between the common house sparrow and the tree sparrow (*Passer montanus*), which had been taken near Bury on January 13 last. Only one instance of a similar wild hybrid was known to have been previously captured, although two or three instances were on record of the two species interbreeding in aviaries.—Mr. J. C. Willis gave an abstract of a paper on the "Natural History of the Flower" (part ii.), in which he dealt with the mode of fertilisation in *Brodiaea ixioides*, S. Watson, *Stanhopea tigrina*, Bateman, *Pimelia decussata*, R. Br. var. *diosmeifolia*, *Cotyledon umbilicus*, L., *Hydrolea spinosa*, L., and *Ziziphora capitata*, and made some remarks on cleistogamy in *Salvia Verbenaca*, L. A discussion followed, in which Dr. D. H. Scott, Prof. Reynolds Green, and Mr. A. B. Rendle took part.—The Secretary read a paper by Miss D. F. Pertz, on hygroscopic movements connected with seed-dispersal, in which the author partially reviewed the literature of the subject, and detailed the method of observation adopted by previous workers and by herself.

**Zoological Society, February 20.**—Prof. G. B. Howes in the chair.—A report was read, drawn up by Mr. A. Thomson, on the insects bred in the Insect-house during the season of 1893. Examples of seventeen species of Bombyces, twenty of Diurnal Lepidoptera, and twenty-four of Nocturnal Lepidoptera had been exhibited during the past season, of which many had not been shown in former years. Amongst these were specimens of the fine insect *Actias mimosa*, from south-east Africa, hatched from cocoons presented by the Rev. H. A. Junod.—Mr. Oldfield Thomas called attention to the skin of a Giraffe from Somaliland, sent for exhibition by Mr. Rowland Ward, and pointed out its differences from the South African Giraffe.—A communication was read from Dr. R. W. Shufeldt, giving particulars of the methods used in preparing specimens of certain Invertebrates for public exhibition employed in the U.S. National Museum.—Mr. Sowerby read a communication forwarded to him by Dr. O. F. von Moellendorff, giving an account of a collection of Land-Shells from the Samui Islands, Gulf of Siam. These Land-Shells were referred to thirty-three species, of which many were described as new to science.—A communication from Dr. D. Sharp, F.R.S., contained a list of Hemiptera Heteroptera of the families *Anthicoride* and *Ceratocombide*, collected by Mr. H. H. Smith in the island of St. Vincent, with descriptions of new genera and species, prepared by Prof. P. R. Uhler, upon specimens submitted to him by the West Indian Committee.—Mr. O. Thomas read the third of his contributions towards our knowledge of the mammals of Nyasaland, based, as the two former, on specimens forwarded to the British Museum by Mr. H. H. Johnston, C.B., H.B.M. Commissioner in British Central Africa. The present paper contained remarks on thirty-five mammals, of which two were described as new, and were named respectively *Lepus whyleri* and *Procapra johnstoni*.—A communication from Dr. R. W. Shufeldt gave an account of the conclusions to which he had arrived respecting the affinities of the birds of the order Steganopodes.

**Royal Meteorological Society, February 21.**—Mr. R. Inwards, President, in the chair.—The following papers were read:—Temperature, rainfall, and sunshine at Las Palmas, Grand Canary, by Dr. J. Cleasby Taylor. The author gave the results of his observations during the five years 1889–93. The island of Grand Canary occupies a position midway between the African continent and the most western of the Canary group. The mountain peaks rise to a little over 6000 feet, and are about twenty miles from the coast. The chief town and port of the island, Las Palmas, is consequently free from the influence of the mountains. The diurnal range of temperature fluctuates considerably with the variations in wind and sunshine. With a southerly wind (which usually dies down at sunset) the range is increased, but the greater part of the increase is due to a higher day temperature. With northerly winds persisting after sunset, the range may be very slight, particularly if the day has been cloudy. The sea temperature is dependent on causes outside the limits of the archipelago; local presence or absence of sunshine does not cause any difference. A boisterous northerly wind, with a high sea, may cause the temperature to fall quicker

than usual, or, if the temperature is rising, to check the rise; but any sudden variation is very rare. The rainfall is not great, though it is spread over a large number of days, the average yearly amount being 8.90 inches. The greater part of the rain falls during October to January, while the period from June to September is practically rainless.—Report on the phenological observations for 1893, by Mr. E. Mawley. This was a discussion of the observations made on the flowering of plants, appearance of insects, and the song and nesting of birds. The year 1893 was in complete contrast to its predecessor, being very forward throughout the United Kingdom. The February and March plants were later than usual in blossoming, especially in the colder parts of our Islands, but after this the dates were everywhere in advance of the average, and during the height of the flowering season the departures from the mean were often considerable.—Comparative observations with two thermometer screens at Ilfracombe, by Mr. W. Marriott. Some exception having been taken to the thermometer screen which has been in use at Ilfracombe for a number of years past, a Stevenson screen was placed at a distance of 60 feet from the old screen in October, 1892, since which date simultaneous observations in the two screens have been made daily at 9 a.m. The results of this comparison show that the temperature deduced from the two sets of observations agrees very closely, the old screen being only 0.3 higher than the Stevenson.

## CAMBRIDGE.

Philosophical Society.—February 12.—Prof. Hughes, President, in the chair.—On a suggested case of mimicry in the mollusca, by Mr. A. H. Cooke. The species concerned were *Strombus mauritianus*, L., and *S. luhuanus*, L., the shells of which differed from those of all other *Strombus* in their close resemblance to the shell of *Conus*, a genus with which they are known to live: *Strombus* being a frugivorous animal with small and weak teeth, and *Conus* on the other hand being carnivorous, with very large and barbed teeth, provided with a poison bag and duct. It was suggested that this resemblance must tend greatly to the advantage of the *Strombus*, since the dangerous properties of *Conus* would tend to prevent its being touched by predatory fishes.—On the evidence as to the extent of earth movements and its bearing upon the question of the cause of glacial conditions, by the President. Prof. Hughes referred to the former paper in which he discussed the first part of the question, viz. the evidence of glacial conditions offered by scratched stones and smoothed and striated rock surfaces. He then stated the second part of the question in the same form as that in which the astronomical theory of the cause of recurrent glacial conditions is usually put forward. He contended that there is abundant evidence of contemporary earth movements of such a kind and magnitude as would, if their possible effects were not destroyed or modified by other causes, produce greater vicissitudes of temperature than any that are required to explain the most extreme glacial conditions observed in past time. An examination of the succession of events as recorded in the crust of the earth shows that these greater movements of elevation and depression have been secularly recurrent, and an inquiry into the geographical distribution of the formations which are held to contain evidence of glacial action leads to the conclusion that they are arranged round basins, and further that around the rim of these basins we have the clearest proofs from independent evidence of marginal movements of great intensity. The average fall of temperature as we ascend is observed to be about 1° F. for every 300 feet. Therefore the reduction of temperature due to such elevations as would result from known upheavals is quite sufficient to explain the occurrence of glaciation anywhere. A consideration of the geographical causes of glacial conditions explains why the effect has not always followed when the upheaval is known to have been great enough to have produced it: seeing that it is along the axes and areas of greatest movement that the greatest denudation takes place and the actual elevation represents only the excess of uplift over denudation.—On the fertilisation of some species of *Medicago* in England, by J. H. Burkill. The floral mechanism of four species of *Medicago* (*gativa*, L., *falcata*, L., *silvestris*, Fries, and *lupulina*, L.), was discussed, and lists of insect-visitors given. The processes which unite the alae and carina hold the staminal tube in position in the unexploded flower, while the basal processes of the alae serve as triggers whereby an insect may explode it. The stigma is rendered fertile by rubbing as in *Lotus*, but in *M. lupulina* in older unexploded flowers becomes receptive and

self-fertilised. Flies form a larger percentage of the insect-visitors in England than in Germany.—Contributions to the geology of the Gosau beds of the Austrian Salzkammergut, by H. Kynaston.

## EDINBURGH.

Royal Society, February 5.—Prof. Copeland, Astronomer Royal for Scotland, in the chair.—Dr. John Murray gave an address on the floor of the ocean at great depths. He discussed the character of the deposits and the organisms found at the sea-bottom by the *Challenger* expedition. Exclusive of the *protozoa*, certain species were found in Antarctic waters which corresponded to species found in Arctic waters, while no such species were found in intervening tracts. This may be supposed to have been due to the production of the same species, from different origins, under the same conditions; but it is more in accordance with modern ideas to suppose that they had a common origin. Dr. Murray suggested that the common origin was referable to a period when the whole ocean had a fairly uniform high temperature of perhaps 70° or 80°. Under this condition there might have been a universal fauna. As the polar regions became colder, similar portions of the fauna became adapted to the like conditions of the northern and southern tracts; while the portion which was forced to retreat from the colder regions was now represented by the fauna of the coral reefs and tropical waters.

February 19.—Sir Douglas MacLagan, President, in the chair.—Mr. John Aitken read the third part of a paper on the number of dust-particles in the atmosphere of certain places in Great Britain and on the continent. Observations had been taken at Hyères, Cannes, and Mentone. There the air was never found to be very pure, the lowest number of dust-particles recorded being 600 per cubic centimetre. At the Italian lakes the conditions were found to be somewhat similar. When the wind blew up the slopes from the valleys, the number of dust-particles was greater than when it blew across the mountain tops. On the Righi it was also found that the air from the mountain was purer than the air from the plains. The haze increased with the number of particles. A connection was also observed between the amount of dust and the appearance of the sunset. When there was much dust, the light was warm and soft; when there was little, the lighting on the landscape was cold, clear, and sharp. A careful series of observations had also been taken at Kingairloch, which, along with others, had been used in the determination of constants in equations connecting the haze with number of dust particles, &c.—A paper, by Mr. George Romanes, containing a suggestion as to the probable nature of electrification, was communicated.

## PARIS.

Academy of Sciences, February 19.—M. Lœwy in the chair.—On linear equations of the second order containing an arbitrary parameter, by M. Emile Picard.—On certain developments in series, required in the theory of the propagation of heat, by M. H. Poincaré.—Typhoid fever in Paris, for the period 1884–1893; its autumn and winter increase. An abstract of a memoir, by M. de Pietra Santa, giving his conclusions concerning the general decrease of this disease and the causes of this decrease.—Observations of the new planet AV (Courty, 1894, February 11), made at the Paris Observatory, by M. G. Bigourdan.—Observations of the planet 1894, AV, made by the great equatorial of the Bordeaux Observatory, by MM. L. Picart and F. Courty.—Results of the solar observations made at the Royal Observatory of the Roman College during the fourth quarter of 1893, by M. P. Tacchini.—On the tetrahedra conjugate with respect to a quadric, and of which the edges are tangents to another quadric, by M. H. Vogt.—On a case of degeneration of a general projective system, by M. F. Engel.—On the movement of two points joined by a spring, by M. L. Lecornu.—On a system of two pendulums joined by an elastic thread, by M. Lucien de la Rive.—A new simplified method for the calculation of rapidly alternating currents, by M. A. Blondel.—The symmetrical aplanatic objective, by M. Ch. V. Zenger. The author has constructed systems of lenses imitating as far as possible the conditions obtaining in the human eye. He gives the necessary mathematical investigation. Two lenses, a plano-convex lens of phosphate crown glass, and a plano-concave of borate crown glass of less refracting and greater dispersive power, are combined to produce a system for which it is claimed, that (1) the achromatism is exact for the entire length of the spectrum;

(2) astigmatism is corrected very thoroughly; (3) spherical aberration, with a convenient aperture ( $\frac{1}{F} = \frac{1}{20}$  to  $\frac{1}{30}$ ), is reduced to the minimum value of a second of arc; (4) the curvature of the field is absolutely corrected.—On the temperature of the higher regions of the atmosphere, by MM. Gustave Hermite and Georges Besançon. A reply to a criticism of a recent communication.—On the minimum electromotive force necessary for electrolysis to take place, by M. Max Le Blanc. The author claims priority over M. Nourrisson, and quotes some of his results from the *Zeitschrift physik. Chem.* 1891, p. 299.—Observations on the preceding note: the limits of electrolysis, by M. Berthelot. A memoir by the author published in 1882 ("Sur les limites de l'électrolyse," *Ann. Chim. Phys.* [5], 27, p. 88) carries the whole subject further than the papers by MM. Le Blanc and Nourrisson.—On the fusibility of isomorphous mixtures of some double carbonates, by M. H. Le Chatelier. A study of mixtures of sodium and potassium carbonates with calcium, strontium, and barium carbonates in such proportions that the alkaline carbonate and the alkaline-earthly carbonate are in equivalent quantities. Lithium carbonate behaves similarly to the alkaline-earthly carbonates.—On the allotropic transformation of iron under the influence of heat, by M. Georges Charpy. Conclusions are drawn from the experimental evidence quoted, indicating that the transformation is more rapid at more raised temperatures, but appreciable time is required, and hence duration of heating as well as temperature should be regarded in metallurgical operations.—Constitution of orcin, by M. de Forcrand. A thermal study; the results indicate that the phenolic hydroxyl groups occupy the meta position with regard to each other; the first has a slightly higher, the second the same thermal value as ordinary phenol.—On the ethylphenols, by MM. A. Béhal and E. Choay.—On the multirotation of sugars, by M. P. Th. Muller. The reaction producing the multirotation of sugars is of the first order; it proceeds in accordance with the law of the active masses. A constant at any given temperature measures the progress of the reaction. The speed of transformation is markedly greater for the pentoses than for the other sugars.—On the reciprocal affinities of the Myxosporidiae, by M. P. Thélohan.—Researches on the structure of Mucorini, by MM. P. A. Dangeard and Maurice Léger.—On the rôle of *Plantago alpina* in mountain pastures, by M. E. Guinier.

## BERLIN.

Physiological Society, January 26.—Prof. du Bois Reymond, President, in the chair.—Dr. Dembo, of St. Petersburg, spoke on the physiological value of the various modes of slaughtering animals, and came to the conclusion that the most humane method consists in cutting the large blood-vessels of the neck. When this is done, unconsciousness sets in within a few seconds of the operation, while the movements made are merely symptoms of the cerebral anæmia. Further, the flesh of animals bled to death keeps best.—Dr. von Noorden gave an account of part of the experiments he has carried on in conjunction with Prof. Zuntz, on the action of quinine on the metabolism of man. With a constant diet extending over a long period, and after nitrogenous equilibrium was established, daily increasing doses of quinine were administered, with the result that during the time it was given, and for a day afterwards, the output of nitrogen was markedly lessened, but later on rose again to its initial value. Phosphorus showed the same falling off as did the nitrogen, whereas uric acid was only lessened in the period subsequent to the administration of quinine. Under the action of the drug the leucocytes diminished in number, but increased again later on. Careful investigation of the respiratory interchange showed a very slight but distinctly increased consumption of oxygen, probably to be explained entirely by the considerably increased ventilation of the lungs while the drug was being taken; this fell again subsequently to its normal magnitude. Dr. Ullmann, owing to the lateness of the hour, was only able to state his view that the red blood-corpuscles of man are spherical; he will give the basis for this view at a subsequent meeting.

February 9.—Prof. du Bois Reymond, President, in the chair.—Prof. Zuntz had made experiments with a Pettekofer respiration apparatus at Göttingen, on the respiration by the skin and intestine of the horse. He first of all found that the total output of carbon dioxide in twenty-four hours was 4200 grm. Excluding that from the lungs, the remainder due to

the skin and intestine amounted together to 145 grm., and an additional 22 grm., from volatile hydrocarbons. The latter can only be methane, and hence come from the intestine. Now since the gases of the intestine have a constant composition as regards methane, carbon dioxide and hydrogen, it became at once possible to calculate how much carbon dioxide comes from the skin, and how much from the intestine.

Physical Society, February 2.—Prof. Kundt, President, in the chair.—Prof. Goldstein spoke on the cathodic light, distinguishing the five following kinds of radiant rays:—(1) The yellow rays of the first zone, which are very strongly developed at the hinder side of the kathode, when there are holes in the latter. These rays are propagated in straight lines, are not affected by magnets, and exhibit no phosphorescence. (2) The rays of the second zone, which extend a long way into the space occupied by the cathodic light, may be concentrated by a bent kathode, are propagated in straight lines, are bent out of their course by a magnet, and are phosphorescent when they strike the inner wall of the tube. (3) The rays of the third zone, which are propagated uniformly in all directions, can turn a corner and throw no shadows. (4) A fourth kind of rays which produce inverted images of the electrode, and are arrested by screens. (5) A fifth kind is ordinarily invisible, but gives rise to bright stars where the rays fall on the wall of the tube. All the above five kinds of rays occur mixed in the light of the kathode, and intersect each other. In the "secondary negative light," which is developed when the tube in which the discharge takes place has constrictions on it, and which is seen at the end of the constriction turned towards the anode, Prof. Goldstein had observed two distinct kinds of cathodic light. Further, since the secondary negative light can pass over into the anodic light, the latter must also consist of cathodic rays. When a metallic plate with holes in it is placed in the middle of a vacuum tube, at whose ends the electrodes are inserted, he observed that artificial cathodic rays are produced on that side of the plate which is turned towards the anode. The above phenomena had been observed in air, nitrogen, oxygen, hydrogen, carbon dioxide, and mercury vapour, and were demonstrated at the end of the meeting.

Meteorological Society, February 13.—Prof. Hellmann, President, in the chair.—Prof. von Bezold spoke on the various modes of discriminating between clouds, as, for instance, by reference to their dimensional appearance, their form, structure, and height, and then proceeded to go very fully into their discrimination as based upon their mode of formation. Clouds are formed either as the result of cooling (resulting from either radiation or contact), or by mixing, or by adiabatic expansion (more strictly speaking, expansion with insufficient heat supply). Condensations resulting from cooling give rise to earth clouds and the various mist clouds which more rarely occur at higher levels. Stratus clouds result from mixing, as also do the overhanging caps of fohn clouds on mountain tops, the cloud-streamers of cumulus clouds, and more especially the cloud-waves at the junction between two winds which are passing each over the other. Adiabatic expansion gives rise to cumulus clouds. The speaker illustrated his remarks by a series of cloud-photographs and sketches.

## DIARY OF SOCIETIES.

## LONDON.

## THURSDAY, MARCH 1.

ROYAL SOCIETY, at 4.30.—Preliminary Note on Bi-lateral Degeneration in the Spinal Cord of Monkeys (*Macacus sinicus*) following Uni-lateral Lesion of the Cortex Cerebri: Dr. E. L. Mellis.—On the Effect of Magnetisation upon the Dimensions of Wires and Rings of Annealed Iron: S. Bidwell, F.R.S.—On the Relations of the Secular Variation of the Magnetic Declination and Inclination at London, Cape of Good Hope, St. Helena, and Ascension Island, as exhibited on the Magnetarium: H. Wilde, F.R.S.—Terrestrial Refraction in the Western Himalayan Mountains: General Walker, F.R.S.—Researches on the Structure, Organisation, and Classification of the Fossil Reptilia—Part IX., Section 1, On the *Thero-suchia*; Section 2, The Reputed Mammals from the Karroo Formation of Cape Colony; Section 3, On *Diademodon*; Section 5, On the Skeleton in New Cynodontia from the Karroo Rocks: Prof. Seeley, F.R.S.—On a Spherical Vortex: Prof. M. J. M. Hill.—On Correlation of certain External Parts of *Palaemon serratus*: H. Thompson.

LINNEAN SOCIETY, at 8.—Algebraical Notes from Cumbria.—On the Origin of the Filamentous *Thalassus* of *Damonia filiformis*: George Drebnar.—Entomozoa and the Surface Film of Water: D. J. Scurfield.

ROYAL INSTITUTION, at 3.—The Vendânta Philosophy: Prof. Max Müller.  
 CHEMICAL SOCIETY, at 8.—Aërial Oxidation of Terpenes and Essential Oils: C. T. Kingzett.  
 CAMERA CLUB, at 8.—Light Waves in a Shadow; W. B. Crofts.  
 SOCIETY OF ANTIQUARIES, at 8.30.

## FRIDAY, MARCH 2.

ROYAL INSTITUTION, at 9.—The Theory of the Cochlea and Inner Ear: Prof. J. G. McKendrick.  
 SANITARY INSTITUTE, at 8.—Scavenging Disposal of House Refuse: C. Mason.  
 INSTITUTION OF CIVIL ENGINEERS, at 7.30 (Students' Meeting).—Efficiency and Economy of Elevators: Herbert W. Umney.  
 GEOLOGISTS' ASSOCIATION (University College), at 8.—The Hythe Beds of the Lower Greensand, in the Liphook and Hind Head District: Bin-stead Fowler.—Tertiary Man: J. B. M. Findlay.

## SATURDAY, MARCH 3.

ROYAL INSTITUTION, at 3.—Light, with special reference to the Optical Discoveries of Newton: The Right Hon. Lord Rayleigh, F.R.S.

## SUNDAY, MARCH 4.

SUNDAY LECTURE SOCIETY, at 4.—Glimpses of the Life, Lore, and Legend of Old Japan (with Oxy-hydrogen Lantern Illustrations): R. W. Atkinson.

## MONDAY, MARCH 5.

SOCIETY OF CHEMICAL INDUSTRY (Chemical Society's Rooms, Burlington House), at 8.—The Zyuean Metallurgy: Admiral J. H. Selwyn.—The Commercial Production of Chlorine by the Ammonia Soda Process: F. Bale.—Notes on Lithographic Varnish: F. H. Leeds.  
 VICTORIA INSTITUTE (3 Adelphi Terrace, Strand), at 8.—The Origin of the Australian Race: Dr. John Fraser, F.R.S.

## TUESDAY, MARCH 6.

ROYAL INSTITUTION, at 3.—Locomotion and Fixation in Plants and Animals: Prof. C. Stewart.  
 SOCIETY OF ARTS, at 8.—Travels in the Basin of the Zambesi: M. Fox.  
 ZOOLOGICAL SOCIETY, at 8.30.—On the Factors that appear to have influenced Zoological Distribution in East Africa (to be illustrated with Lantern Slides): Dr. J. W. Gregory.—On the Habits of the Flying Squirrels (Anomalurus) of the Gold Coast: W. H. Adams.—On Two Cases of Colour-variation in Flat-fishes illustrating Principles of Symmetry: W. Bateson.  
 SANITARY INSTITUTE, at 8.—Diseases of Animals in Relation to Food Supply: Prof. A. W. Blyth.  
 INSTITUTION OF CIVIL ENGINEERS, at 8.—Papers to be further discussed: The Liverpool Overhead Railway: J. H. Greathead and Francis Fox.—Electrical Equipment of the Liverpool Overhead Railway: Thomas Parker.  
 ROYAL VICTORIA HALL, at 8.—Lakes: W. W. Watts.

## WEDNESDAY, MARCH 7.

SOCIETY OF ARTS, at 8.—Refrigerating Apparatus: Prof. Carl Linde.  
 GEOLOGICAL SOCIETY, at 8.—The Systematic Position of the Trilobites: H. M. Bernard.—Landscape Marble: Beeby Thompson.—On the Discovery of Molluscs in the Upper Keuper at Shrewley in Warwickshire: Rev. P. B. Brodie.

## THURSDAY, MARCH 8.

ROYAL SOCIETY, at 4.30.—Croonian Lecture: The Minute Structure of the Nervous System: Prof. S. Ramón y Cajal, of Madrid.  
 ROYAL INSTITUTION, at 3.—The Vendânta Philosophy: Prof. Max Müller.  
 INSTITUTION OF ELECTRICAL ENGINEERS (25 Great George Street, Westminster, S.W.), at 8.—A Note on Parallel Working through Long Lines: W. M. Mordey.  
 CAMERA CLUB, at 8.—Composite Heliography by Three-colour Printing: F. E. Ives.  
 MATHEMATICAL SOCIETY, at 8.—Groups of Points on Curves: F. S. Macaulay. On the Buckling and Wrinkling of Plating supported on a Framework under the influence of Oblique Stresses, and on a Simple Contrivance for Compounding Elliptic Motions: G. H. Bryan.—On the Motion of Two Pairs of Cylindrical Vortices which have a Common Plane of Symmetry: A. E. H. Love.  
 SOCIETY OF ANTIQUARIES, at 8.30.

## FRIDAY, MARCH 9.

ROYAL INSTITUTION, at 9.—The Making of a Modern Fleet: Dr. W. H. White.  
 PHYSICAL SOCIETY, at 5.—Calculating Machines, and especially a New Harmonic Analyser: Prof. O. Henriot, F.R.S.  
 SANITARY INSTITUTE, at 8.—Infectious Diseases and Methods of Disinfection: Dr. W. H. Hamer.  
 ROYAL ASTRONOMICAL SOCIETY, at 8.  
 MALACOLOGICAL SOCIETY, at 8.

## SATURDAY, MARCH 10.

ROYAL INSTITUTION, at 3.—Light, with special reference to the Optical Discoveries of Newton: The Right Hon. Lord Rayleigh, F.R.S.

NO. 1270, VOL. 49]

## BOOKS, PAMPHLETS, and SERIALS RECEIVED.

BOOKS.—Modern Plane Geometry: G. Richardson and A. S. Ramsey (Macmillan).—Essays in Historical Chemistry: Prof. T. E. Thorpe (Macmillan).—Comité International des Poids et Mesures, Scizème Rapport (Paris, Gauthier-Villars).—Travaux et Mémoires du Bureau International des Poids et Mesures, Tome viii. (Paris, Gauthier-Villars).—Annuaire de l'Observatoire Municipal de Montsouris pour l'Année 1894 (Paris, Gauthier-Villars).—Light, an Elementary Text-Book, Theoretical and Practical: R. T. Glazebrook (Cambridge University Press).—The Flowering Plants of Western India: Rev. A. K. Nairne (W. H. Allen).—Object Lessons in Botany from Forest, Field, and Garden: E. Snelgrove (Jarrold).—The Alchemical Essence and the Chemical Element: M. M. P. Muir (Longmans).—Statistics of the Colony of Tasmania (Tasmania).—Hume, with Helps to the Study of Berkeley: T. H. Huxley (Macmillan).  
 PAMPHLETS.—Report of Observations of Injurious Insects and Common Farm Pests during the Year 1893, &c.: E. A. Ormerod (Simpkin).—Die Lehre von der Wellenberühigung: Dr. M. M. Richter (Berlin, Oppenheim).—Twenty-fourth Annual Report of the Wellington College Natural History Society, 1893 (Wellington College).—On the Definitions of the Trigonometric Functions: Prof. A. Macfarlane (Boston).  
 SERIALS.—American Journal of Science, February (New Haven).—Journal of the Franklin Institute, February (Philadelphia).—Zoologische Abhandlungen—Berichte der Naturforschenden Gesellschaft zu Freiburg i. B. viii. (Williams and Norgate).—Astronomy and Astro-Physics, February (Wesley).—Royal Natural History, Vol. i. Part 4 (Warne).—Proceedings of the Royal Society of Victoria, Vol. vi. new series (Williams and Norgate).—Journal of the Royal Horticultural Society, January (117 Victoria Street).—Journal of the Polynesian Society, Vol. ii. No. 4 (Petherick).—Journal of the Institution of Electrical Engineers, No. 108, vol. xxii. (Spon).—Kryptogamen-Flora von Schlesien, 3 Band, 2 Hälfte, 2 Lief (Williams and Norgate).—Journal of the Institute of Jamaica, December (Kingston).—Meteorological Record, vol. xiii. No. 50 (Stanford).—Quarterly Journal of the Royal Meteorological Society, January (Stanford).—L'Anthropologie, tome iv. No. 6 (Paris, Masson).—Zeitschrift für Physikalische Chemie, xiii. Band, 2 Heft (Leipzig, Engelmann).—The Humanitarian, March (Sonnenschein).—Journal of the Royal Microscopical Society, February (Williams and Norgate).—Bulletin de l'Académie Royale des Sciences de Belgique, tome 27, No. 1 (Bruxelles).—Journal de Physique, February (Paris).—Bulletin of the American Museum of Natural History, vol. v. 1893 (New York).—National Academy of Sciences, Vol. vi.: Eighth Memoir: Further Studies on the Brain of *Limulus polyphemus*, with Notes on its Embryology: A. S. Packard.—Records of the Geological Survey of India, vol. xxvi. Part 4 (K. Paul).

## CONTENTS.

PAGE

|                                                                                 |     |
|---------------------------------------------------------------------------------|-----|
| The Report of the Gresham University Commission                                 | 405 |
| Stereochemistry. By T. P. . . . .                                               | 409 |
| Marine Boilers . . . . .                                                        | 410 |
| Our Book Shelf:—                                                                |     |
| Sheldon: "Chapters on Electricity" . . . . .                                    | 411 |
| Dickson: "Meteorology" . . . . .                                                | 412 |
| Letters to the Editor:—                                                         |     |
| Great Auk's Egg.—Prof. Alfred Newton, F.R.S.                                    | 412 |
| Frost-Cracks and "Fossils."—Prof. G. A. Lebour                                  | 412 |
| The Origin of Lake Basins.—Alfred R. C. Selwyn, F.R.S. . . . .                  | 412 |
| Note on the Habits of a Jamaican Spider.—Prof. T. D. A. Cockrell . . . . .      | 412 |
| The Cloudy Condensation of Steam.—Shelford Bidwell, F.R.S. . . . .              | 413 |
| Astronomy in Poetry.—Rev. Edward Geoghegan                                      | 413 |
| A Plausible Paradox in Chances.—Lewis R. Shorter                                | 413 |
| The Planet Venus. ( <i>Illustrated.</i> ) By W. J. L. . . . .                   | 413 |
| Notes . . . . .                                                                 | 415 |
| Our Astronomical Column:—                                                       |     |
| A Large Sun-spot . . . . .                                                      | 419 |
| Anderson's Variable in Andromeda . . . . .                                      | 419 |
| A Bright Meteor . . . . .                                                       | 419 |
| The Bakerian Lecture. By Prof. T. E. Thorpe, F.R.S., and J. W. Rodger . . . . . | 419 |
| The Dynamics of the Atmosphere . . . . .                                        | 422 |
| University and Educational Intelligence . . . . .                               | 422 |
| Scientific Serials . . . . .                                                    | 423 |
| Societies and Academies . . . . .                                               | 424 |
| Diary of Societies . . . . .                                                    | 427 |
| Books, Pamphlets, and Serials Received . . . . .                                | 428 |



THURSDAY, MARCH 8, 1894.

ELECTROMAGNETISM AND DYNAMO CONSTRUCTION.

*A Text-Book on Electromagnetism and the Construction of Dynamos.* By Dugald C. Jackson, B.S., C.E., Professor of Electrical Engineering in the University of Wisconsin, &c. Vol. I. (New York and London: Macmillan and Co., 1893.)

IN this work an excellent attempt is made to present the elements of a very important subject in small compass and in a clear and readable form, without any sacrifice of accuracy. The present volume is only the first instalment of the complete treatise promised by the author, but it contains in nine chapters, covering some 280 pages, a fairly comprehensive survey of the elements of electromagnetism, the magnetic properties of iron, magnetic circuits and characteristic curves of dynamos, a discussion of efficiencies, and the action of multipolar dynamos.

The primary definitions and statements regarding units, which are always a good test of the competency of at least the theoretical treatment in a book like the present, are generally clear and accurate. The author begins by discussing lines of force, and on p. 2 gives the needful caution that such lines "have no material existence, but are merely hypothetical." It might have been added here, perhaps, that this notion of lines of force is a concept corresponding to a state of the field produced by the presence of the magnetic distribution, that is to say that there is some kind of "displacement or motion of the medium" perfectly real though not material, the direction and amount of which is typified by the grouping of the lines of force.

On the same page it is stated that "when the lines of force in a magnetic field are parallel and of equal number per square centimetre a magnet pole will experience the same force at all points of the field, and the field is said to be uniform." This is, of course, quite correct; but it ought to be noticed that if the lines of force are parallel throughout any finite portion of the field, they must be of equal number per square centimetre, and *vice versa*.

The usual definitions of **B** and **H** are given on p. 5, and we do not criticise in any adverse sense the author's procedure in so doing. But we cannot help thinking that it is much more conducive to clearness to give to each medium, whatever it is, a magnetic inductivity, and to consider this as a physical quantity depending on the medium. Thus, denoting the inductivity by  $\mu$ , we should have the relation  $\mathbf{B} = \mu \mathbf{H}$ . Then if the inductivity of a standard medium be  $\mu_0$  we should have, for the same **H**,  $\mathbf{B}_0 = \mu_0 \mathbf{H}$ . The ratio  $\mathbf{B} \mathbf{B}_0$  or  $\mu/\mu_0$  is then properly the permeability of the former medium, and might be denoted by  $\varpi$ . This, it seems to us, would be much more in accordance with Lord Kelvin's original presentation of the matter. The permeability  $\varpi$  would be in all circumstances a mere ratio, and therefore of zero dimensions; while the confusion caused by at one time regarding  $\mu$  as

a mere number, and at another as a quantity having certain dimensions (for example, the dimensions of the reciprocal of the square of a velocity), would be entirely avoided. This procedure was recommended some time ago by Heaviside, and there can be no question of the desirability of its adoption. Instead of the equation

$$\mu = 1 + 4\pi\kappa$$

we should have

$$\mu = \mu_0 (1 + 4\pi\kappa)$$

where  $\kappa$  is the magnetic susceptibility, also a pure number. If, as Heaviside strongly advocates, "rational" units be adopted, the  $4\pi$  must be omitted in these formulæ.

The ordinary mode of dealing with the subject begins by making **B** a quantity of the same dimensions as **H**, and later when the energy of the electromagnetic field is discussed the definition of **B** is virtually altered, so that  $\mathbf{BH}/8\pi$  becomes the energy per unit volume of the medium, and **B** has *not* the same dimensions as **H**. This change may be explained, but it constitutes a sore difficulty to the student.

In the present case, however, the matter is not so important, as for the dynamo application it is sufficient to regard the relation as that which holds when  $\mu_0$  is put equal to 1. There is, however, essentially the same kind of difference between  $\mu$  and  $\varpi$  that there is between density and specific gravity. The former depends on the units adopted, the latter does not.

A very good account is given in chapter iii. of the magnetic properties of iron. The more important recent researches on this subject are summarised, and the results illustrated by curves. The author seems, however, to have missed, or at any rate has not brought out, the point of Dr. Hopkinson's divided bar method, which was to test the total magnetic induction in the bar after certain specified series of changes of magnetic force had been applied. This object would not be attained by having the bar undivided and the coil fixed, and simply reversing the magnetising current, as Mr. Jackson suggests.

The description in this connection of a ballistic galvanometer as "a galvanometer with a rather heavy needle, and therefore a considerable time of vibration," has the merit of brevity, but is curiously inaccurate. It is no doubt an off-hand careless statement which has escaped correction in proof, but it may mislead a reader into supposing that weight of needle was in itself an advantage in such an instrument.

Hysteresis is adequately discussed in this chapter, and Steinmetz's formula for the energy dissipated in a cycle as depending on the quality of the iron and the number of cycles per minute is exemplified by numerical values found by experiment for different kinds of iron. Here we notice the phrases "watts of energy," "energy in watts," improperly used for "joules of energy," "energy in joules."

With regard to the discussion of energy-losses by hysteresis, it is worth remarking that no assertion can be made as to the disposal of the energy given to the medium (or taken from it) in an unclosed cycle. The ordinary diagram and mode of discussing it easily shows that at certain parts of the cycle more energy is given to

the medium, at others less, than is accounted for by the increase in electrokinetic energy, and that similarly when energy is being returned from the medium more or less is received than disappears from the electrokinetic energy of the field. It seems not impossible that these energy differences may be related to the cyclic changes of dimensions of a specimen of iron, which it has been shown recently by Mr. Nagaoka (*Phil. Mag.* Jan. 1894) accompany the cycles of magnetisation.

In chapter iv. we have a business-like discussion of what the author calls the establishment of electric pressures, in which the building up of a nearly uniform current by the commutation of successive sinusoidal currents in the different sections of the armature is described in the usual manner, but clearly and without undue elaboration. The winding of Gramme and Siemens armatures is dealt with in the same chapter, which ends with some numerical calculations of armature constants, and the heating caused by the Joulean dissipation of energy in the coils.

Hopkinson's method of studying dynamo construction by means of the idea of the magnetic circuit, in conjunction with his brilliant invention of dynamo characteristic curves, and the valuable practical results which he and others have obtained by this mode of investigation, have gone far to clear up the whole subject of the designing of steady-current machines. Prof. Jackson has done well to devote a considerable amount of space to this part of the subject; in fact, taking in the topics of regulation and connecting dynamos, it occupies no less than half the present volume. Opinions will no doubt differ as to the practical value of a good deal in this chapter, but the selection made seems satisfactorily dealt with.

Short chapters on efficiencies and multipolar dynamos conclude the volume. A second is promised on alternating current and arc lighting machinery.

As it is the object of the author only to present fundamental principles, and he very rightly holds that the electrical student should study typical dynamos mainly in the workshop or generating station, he has not burdened his pages with cuts of actual machines of different kinds. There the student who has had a sound course of instruction such as this book represents, based upon previous knowledge of certain cognate subjects, and satisfactory divergences into others, will be able to read to advantage what is essential of the more elaborate works of reference on dynamo machinery.

A small incidental advantage is the absence of those embarrassing folding plates, which cannot be avoided in works of the latter kind, and which, instead of being printed on cloth-backed sheets, arranged to fold always at the same place, are made of the most exasperatingly brittle and frail material.

The book is excellently printed in good, bold type, and reflects credit on the Norwood Press, Boston. There is less than we have seen in some other cases of that disagreeable glare of regularly reflected light from the hot-pressed paper, which renders many American books, notwithstanding their often excellent typography, so difficult to read with comfort.

A. GRAY.

#### INTERNAL COMBUSTION MOTORS.

*A Text-Book on Gas, Oil, and Air Engines.* By Bryan Donkin, Jun., M.Inst.C.E. (London: Charles Griffin and Co., Ltd., 1894.)

AS the results of recent researches on internal combustion motors are usually only to be found in the proceedings of our technical societies and institutions, we greet the present volume with pleasure. The gas engine in its present form has attained a lasting success, and this is due principally to the labours of Messrs. Crossley Bros., of Manchester, a history of that firm being really a record of the advance of the gas engine from its early stages to its present high state of development. The manifold advantages of a gas engine over a steam engine are evident, particularly when the power is required intermittently; moreover, for electric lighting, this type of motor is invaluable for small powers, being started at a few minutes' notice. For larger powers where town gas would be expensive, the addition of a Dawson gas plant renders it far more economical in fuel consumption than any steam engine, and with proper supervision the cost of repairs can be maintained at a low figure. Once started, a gas engine can be allowed to run for several hours unattended, thus reducing the cost of skilled attention to a minimum.

Experiments are now in progress with the object of reducing the consumption of gas in the Crossley Otto engine, and the following results show the progress made in this direction. A 14-h.p. nominal engine has recently been tested, and gave a brake horse-power of 39.91, and used 16.487 cubic of gas per b.h.p. per hour. These results are far in advance of the older engines, and show there are still means of improving what is already a wonderfully economical motor.

Mr. Donkin's work is divided into three parts, treating respectively of gas, air, and oil engines. Part i., on gas engines, is divided into two sections, the first dealing with the early history of these motors, and the second with modern gas engines. The subject of gas engines occupies more than half the book, and has been treated in a careful and very complete manner; most known engines are described and illustrated, and indicator diagrams are shown in many cases, thus rendering the descriptions very complete. Although the Atkinson engine has not come in for very general use, it is an excellent example of a type giving an impulse every revolution, using one cylinder, whereas the Crossley engine gives an impulse every two revolutions. Another engine of a similar type is that designed by Prof. Rowden, and although it is not described in this work, or elsewhere, yet the consumption of gas is very low per brake horse-power, and owing to the complete expansion of the heated gases the water jacket round the cylinder is not so necessary.

Part ii. of the volume under review deals with petroleum engines, a class of motor now rapidly coming to the front, and used in places where gas is not available. If Messrs. Crossley Bros. can claim the honour of having made the gas engine a practical working success, Messrs. Priestman can claim the same honourable position as regards the oil engine. Like all new machines it is more or less complicated, and recent engines made by other firms

are decidedly more simple. Here again we find Messrs. Crossley Bros. to the fore with an engine designed on the lines of their Otto gas engine, and certainly working economically and without trouble.

Part iii. deals with air engines, a subject which has occupied the minds of engineers for many years, and one which appears to baffle their best designs and schemes. These motors deal with low working pressures, and are necessarily bulky for their power. In the Ericsson engine, for instance, the pressure was only 3 lbs. per square inch.

The author says in the preface that, "in both oil and gas engines, about 40 per cent. of all the heat received now goes off in the exhaust gases, and about 35 per cent. in the jacket water." This is nothing new, and the remedy lies in the better expansion of the heated gases. This with the Crossley engine is difficult, but with Prof. Rowden's engine very complete expansion is obtained, and consequently a low pressure at exhaust and a far cooler cylinder. Of course this end is obtained by sacrificing simplicity of design and working parts; at the same time it is questionable whether it would not be worth while experimenting in this direction, considering the great saving to be obtained by more complete expansion. The question of compounding gas engines has not been overlooked, more than one having been constructed; but difficulties have arisen in connection with the valves, and these have only partly been overcome. The difficulty of making a valve to continually pass hot gases is enormous. Yet this is evidently the direction in which economy is to be found, and its solution is merely a question of time.

Another point of importance in the economy of the gas engine is the question of accuracy of manufacture; a badly made gas engine is sure to be a constant trouble, and as many now on the market are bad copies of the Crossley engine without its accuracy and finish, one is not surprised to occasionally hear of failures of this class of motor.

This volume contains a very complete and accurate record of all that has hitherto been done in the design of internal combustion motors. The information has been well brought together, and the illustrations are exceptionally good. The author is to be congratulated on the completion of an excellent book on a subject very little understood by general engineers. N. J. LOCKYER.

#### PHYSIOLOGY FOR SCIENCE SCHOOLS.

*Human Physiology.* By John Thornton, M.A. (London: Longmans, Green and Co., 1894.)

THE book before us belongs to a class which requires some apology for its existence. This particular work has been prepared for lay students intending to present themselves for the second or advanced stage of the Science and Art Department. It aims at being something more than a mere cram book, and in justification of this aim it professes "to furnish precise and accurate information on such parts of histology and anatomy as are required, as well as to give a reasoned account of the physiological processes of the human body." For all this, however, the book belongs to a class

to which exception may justly be taken. The writer appears to have depended almost entirely upon the existence of descriptive physiological works for his material. The result is that the book represents simply a compilation of physiological facts, and in no sense can it be described as a guide to physiological practice. The South Kensington examinations, both elementary and advanced, attempt, as far as their opportunities permit, to test the practical acquaintance of a candidate with the subject in which he presents himself for examination. This is very frequently found to be non-existent, and most usually the reason of this is that the teacher himself is not in a position to act as an instructor in the practical work of a subject he professes to teach. There exists a large number of books which give the minimum of the required amount of physiological fact necessary to impart to his pupils, and upon these alone he usually depends. This class of books gives the teacher no information as to the best way to demonstrate practically the facts he teaches, for the reason generally that the writers themselves are unacquainted with the methods. These books are the class which we would wish to see abolished from our elementary science schools; they are necessarily unreliable, and they always tempt the teacher who uses them to depend upon a wholly artificial knowledge of little practical value whatever. What advantage is it to a student to know that if fibrin be "placed in gastric juice and the mixture kept at a temperature of about 40° C. . . . in about an hour the fibrin will be in great part dissolved"? By itself this is simply a naked fact (though stated in the way the writer puts it, it can hardly be called a fact). The whole process could be shown the student in the most simple way on the lecture table, and unless he actually sees the change produced by the gastric juice, he can, as a rule, have but an imperfect idea of what really occurs.

All these books that aim at being guides to elementary science teaching should have so much simple instruction as to the methods to be adopted to actually show the different processes described, as can be done, having regard to the opportunities of an elementary science school. In physiology a very considerable knowledge can be imparted simply by demonstration, and to ignore this and depend simply upon oral description is to teach physiology in a way that, we are glad to say, is rapidly becoming obsolete. If this volume were supplemented with practical demonstration, it might serve a useful purpose. But the divorce from practical acquaintance with the subject is frequently emphasised. In referring to coagulation, the writer says that "by adding to plasma about 14 per cent. of a saturated solution of sodium chloride a white flaky sticky precipitate of fibrinogen is thrown down." The author intends to be precise, but there is a considerable difference between the statement above and the actual fact, viz. that solid sodium chloride should be added so that it becomes dissolved to the extent of 14 per cent. Later, in treating of the absorption of food, the author commits himself to the following statement: "We know of a physical process called *filtration*, by which is meant the passage of fluids through the pores of a membrane under pressure. Substances that may be obtained in the form of crystals, or

crystalloids, as they are termed, filter easily when in solution. Glue-like substances, or colloids, as they are termed, filter with difficulty." Statements like these are calculated to mislead a student as to the differences between simple filtration and dialysis.

On the whole the book gives a large amount of information in a very small compass, and this is, speaking generally, accurate. One of the best features is the wealth of illustration, selected from well-known textbooks, which it possesses. J. S. EDKINS.

#### OUR BOOK SHELF.

*Light: an Elementary Text-book, Theoretical and Practical, for Colleges and Schools.* By R. T. Glazebrook, M.A., F.R.S. (Cambridge: University Press, 1894.)

The best foundation upon which a student of science can build is elementary physics, for the necessity of accurate observation and correct reasoning is impressed upon him from the very beginning. Mere book-work has no value in training the mind in this direction: lectures illustrated with experiments may lead to the desired end if the teacher take care that the inferences to be drawn from the experimentation are quite clear; but best of all methods, by far, is to let the student perform the experiments himself, to mark the result, and then reason out the explanation. The advantages to be derived from such practical work are incalculable, yet the small number of physical laboratories in our schools and colleges at the present time shows that its importance has not been fully recognised. There are, however, signs of improvement. Judging from the increasing number of books dealing more or less with practical physics, interest in that subject is developing. Mr. Glazebrook's two volumes, that on "Heat," recently noticed in these columns, and the one now before us, help to extend the practical method of teaching. Believing with most scientific educationalists that courses of practical instruction are necessary to the proper understanding of fundamental principles, Mr. Glazebrook gives, in the volume under review, clear descriptions of experiments, the explanations of the theory underlying the work, and the deductions to be made from the results. The theoretical portion of the book could very well form the subject of short lectures preceding the laboratory work, in which the principles expounded at such times could be experimentally tested. The book abounds with diagrams of the kind that appertain to treatises on light. To the artistic mind these figures lack beauty, but they possess the qualification of clearness; and that is sufficient to commend them to the student of optics. Teachers who require a book on light, suitable for the class-room and the laboratory, would do well to adopt Mr. Glazebrook's work.

*Beni Hasan.* Part ii. By P. E. Newberry. With appendix, plans, and measurements of the Tombs, by G. W. Fraser. (London: Kegan Paul, 1893.)

SOME two or three months ago we called the attention of readers of NATURE to the first part of Mr. Newberry's work on the rock-hewn XIIth dynasty tombs at Beni Hasan in Upper Egypt, and we have now the pleasure to record the appearance of the second and concluding portion of this valuable book. We have already described the general scope of the publication, and the plan upon which it has been carried out, and it therefore only remains for us to state the contents of the part before us. Employing the same method of arrangement, Mr. Newberry describes tombs Nos. 15-39, and he gives lists of all the members of the households of the Egyptian

noblemen who were buried at Beni Hasan; the general remarks which he makes upon them are interesting and to the point. Too much praise cannot be given to the thirty-seven plates which illustrate the text, for they give the reader an accurate idea of the general appearance of the scenes painted upon the walls of the tombs. Mr. G. W. Fraser's "Report" (pp. 71-85) is also a very useful addition to the book, and the copies of Greek and Coptic *graffiti* on pp. 65-68 will be welcome for several reasons. We are glad to see that the system of transliteration of Egyptian texts has been much modified, especially as the non-expert will now be able to gain some idea of its meaning and use. It is a great pity, however, that the system as represented in Dr. Birch's "Egyptian Texts" was not wholly adopted.

#### LETTERS TO THE EDITOR.

[The Editor does not hold himself responsible for opinions expressed by his correspondents. Neither can he undertake to return, or to correspond with the writers of, rejected manuscripts intended for this or any other part of NATURE. No notice is taken of anonymous communications.]

##### Great Auk's Egg.

IN your last issue (p. 412), I observe a letter from Prof. Newton, in which he gives his version of the history of the egg of this extinct bird, which was recently sold by auction for £315. There is no doubt that the egg was brought to this country by Yarrell, who purchased it in France some time before 1838, in which year it was figured by Hewitson in his well-known work on birds' eggs. But the question is, whereabouts in France did he find it? Prof. Newton, who well remembers it in the collection of Yarrell, says: "He told me, as he told others of his friends, that he bought it in Paris, in a little curiosity shop of mean appearance," and that he paid two francs for it. He adds that the only "variant" of this story deserving of consideration, is to the effect that the price was five instead of two francs. If this were the only "variant," it would not be worth further discussion. But there is a very different story told of it in Mr. Symington Grieve's important work on "The Great Auk, its history, archaeology, and remains," published in 1885. At p. 105 of this volume, Mr. Grieve writes of this very egg:—

"The following curious story, which is well-known to ornithologists, is so remarkable that we repeat it, and give a copy of Mr. R. Champley's original note, dated June 1, 1860: Mr. Bond [who became the purchaser of the egg in question upon Yarrell's death] says to R. C.—Yarrell told him that, walking near a village near *Boulogne*, he met a fishwoman having some guillemot's eggs. He asked her if she had any more; she said she had at her house. He went, when he saw hanging over the chimney-piece four wild swans' [eggs], with a great auk's [egg] hanging in the centre. She asked two francs each for them. He bought the auk's, and two swans'. She said her husband brought it from the fisheries. The great auk's egg sold at Stevens's sale to Mr. Gardner for £21, [and was] sold again by him to Mr. Bond for £26. Copied by R. Champley at Mr. Bond's, by whom the history was told."

Here then we have an important "variant" of Prof. Newton's version; and as it was taken down in writing in 1860, within four years of Yarrell's death, from the lips of the late Mr. Bond, who had it from Yarrell himself, it seems to me that it ought not to be passed over in silence. At any rate, it affords some justification to the writers referred to by Prof. Newton (see the *Times* of February 23), who, commenting upon the recent remarkable sale, have naturally repeated the only history they could find of this egg, namely, that published in the latest book on the subject.

J. E. HARTING.

##### On M. Mercadier's Test of the Relative Validity of the Electrostatic and Electromagnetic Systems of Dimensions.

IN connection with the clear exposition of the true dimensions of electrical units given by Prof. Rücker in NATURE of the 22nd ult. it is well to bear in mind that Maxwell *long before the publi-*

cation of his book, namely, in the first report to the British Association on electrical standards (see report of the Newcastle meeting of the Association in 1863, p. 160) called attention, in a "Note on the Table of Dimensions," to the provisional character of the electrostatic and electromagnetic series recommended by the committee, and since widely adopted.

He there points out that "if we take into account the coefficient of magnetic induction of the medium in which we work," this quantity,  $\mu$ , will enter into the dimensional equations; and he gives an illustration of this under a particular hypothesis. The whole note is worthy of very careful attention.

This pregnant note, so far as my memory serves me, was omitted from the reprint, by Prof. Fleeming Jenkin, of the British Association reports on electrical standards, and may now be easily overlooked. It seems, therefore, well to call attention to it.

G. JOHNSTONE STONEY.

8 Upper Hornsey Rise, N., February 26.

### Experiments in Elementary Physics.

I NOTICE on p. 379 a description of a new form of Boyle's tube used by Dr. J. Joly. The following, which I have now used for about six or seven years, I have found very convenient for school use, where it is a disadvantage to have much pouring to or fro of mercury.

A piece of Sprengel tube about 1 m. long is fastened along a metre scale, one end having been previously closed. The metre scale is then mounted so as to be capable of rotating about a horizontal axis, and a thread of mercury about 30 cm. long is introduced into the tube so as to leave an air space 20 to 30 cm. long at the closed end. The volume of air is read off along the scale, and the pressure varied by rotating the tube about its axis, and measuring the vertical height of the mercury column. By this means pressures greater or less than one atmosphere can be easily obtained, and the product v.p. shown to be constant with considerable accuracy if ordinary precautions are taken.

To show that when the volume is constant the pressure of a gas varies with the absolute temperature, I use a vertical tube about 40 cms. long, surrounded in the upper part by a water jacket. The upper end is closed, and the lower connected by stout rubber tubing to a long tube fixed to a wooden arm—the end of this arm nearest to the vertical tube being hinged to the base board. The two tubes are filled with mercury, so that it rises to a certain mark on the vertical tube, and nearly fills the long tube when the surfaces are about the same level. The air in the vertical tube is heated by passing steam into the water in the jacket, and when the desired temperature is reached, the wooden arm with its tube is raised till the air resumes its former volume. The pressure is then the height of barometer + diff. in height of the two mercury surfaces.

A method of illustrating magnetic lines of force, which I have found useful, is to thrust a magnetised knitting-needle through a cork so that it can float vertically in a large vessel of water. If now a magnet is supported just above the water surface, the needle moves along a line of force. The lines due to two or more magnets may easily be traced out on this plan.

Blairlodge School, Stirlingshire.

W. RHEAM.

### Spectacles for Double Vision.

MANY years ago, on recovering consciousness twelve hours after a railway accident in which my jaw was broken, I saw everything double in this position:—

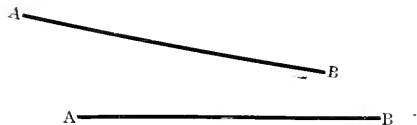

The image seen by one eye was lifted above that seen by the other to the extent of about one-eighth the distance of the object, and was shifted a little to one side, while the two images were inclined to each other at an angle of about twelve degrees. This double vision still continues. It produced little inconvenience until I had to use spectacles for reading and writing; but the forcible bringing of the two images together then injured one eye

so much that it soon became of little use. I found that to use one eye alone was equally bad; a white fog seemed to rise before the one not in use, and it speedily became almost blind. A five weeks' sea voyage, where I had nothing to read, improved the weak eye wonderfully. After consulting some of the best oculists and opticians, I got a pair of spectacles made with prismatic lenses, which brought the centres of the two images together, but left them still inclined at the same angle. Rotating these lenses simply shifts the images parallel to themselves. After two years' use the spectacles had produced a beneficial effect; but the improvement stopped half-way—like the half-remedy.

Fortunately, I met Mr. C. Vernon Boys, F.R.S., of South Kensington, explained my difficulty, and he at once pointed out the remedy, as follows:—A pair of right-angled prisms are placed in the form of a rhombus, and a small distance apart. When one is turned relatively to the other about the common visual axis, the image is turned through double the angle. When one is turned relatively to the other about a direction perpendicular to that axis in a horizontal plane, if the greater face of the prism is horizontal the image is raised or lowered. If the two prisms are turned together about the common visual axis, the image is shifted to the right or left. The images seen by the two eyes can thus be made to coincide exactly in every respect.

I have had a pair of prisms mounted in this fashion on common spectacles in front of the stronger eye. The prisms have facets only seven-sixteenths of an inch square; they are very light, and although small, yet give a sufficient field of view. There being now absolutely no strain on the weak eye in reading or writing, I have no doubt an improvement will soon set in.

I think this information should be disseminated among oculists and opticians, as the contrivance might be useful to others similarly afflicted.

T. I. DEWAR.

### Recent Local Rising of Land in the North-west of Europe.

DURING January of 1894 the local papers of Sweden, Norway, and Finland reported the occurrence of underground shocks or tremblings of the ground, accompanied with noises. The zone seems to be east and west on about 60° of latitude, from about Drammen in Norway across Sweden to Hangö on the southern part of Finland.

In Norway shocks were felt at the beginning of this year in several places. On the night of January 2, tremblings of the ground were felt at Navnaa, in Grue (lat. 60° 28'), and at several places in Solør, throughout the whole night and also on the following night. Loose things in the houses were much shaken, and an examination of the earth surface showed cracks about 2 cm. wide in several places.

On the night of January 3, three strong shocks were felt at Lower Eker in Mjödalen (lat. 59° 38'). The last one shook the houses and all loose things.

In Sweden, on the night of January 3, a shock and underground noise was heard at Hedemora (lat. 60° 20'), and lasted two seconds. A shock was also felt at Mora in Dalarne (lat. 61°), and a crack in the ground, 2 cm. wide and one kilometre long, was found to have resulted from it. On January 24 a shock was felt in Dalarne at Stora Tuna (lat. 60° 27'). It lasted only two seconds. The same trembling was also felt at Uddnäs (about thirty English miles to the west from Tuna).

An underground noise, not very strong, was heard at Finstorp (lat. 58° 40'). It lasted one and a half minutes.

A strong underground shock was felt on February 1 at Wilhelmberg in Asker (lat. 59° 35'). It appeared to pass from north-west to south-east, and gave rise to a sound like thunder in the Iron mine department, and was felt at a distance of two miles from this place.

In the town of Ekenäs (lat. 60°), in the south-west corner of Finland, underground shocks were felt on the evening of January 2, and repeated until 2 o'clock in the morning. The shock was felt strongest in an open field to the west of the town, where three cracks in the ground were visible; one of these rents had a length of 240 feet, and crossing this was another running west, and of 400 feet length. Some people believed that the ground was raised. The following day two more shocks were felt, but they were not so strong as the preceding ones.

Stockholm, February 18.

C. A. LINDVALL.

Apogamy in *Pteris serrulata* (L. fil.) var. *cristata*.

CASES of apogamy are so rare and so intrinsically interesting, that it may be worth the while to record at once the following fact:—

About a fortnight ago, while preparing prothallia for imbedding in paraffin, my attention was called by a student to a specimen obtained from a pot containing a fine plant of *Pteris serrulata cristata*.

The prothallium was of somewhat unusual form, perfectly destitute of archegonia and antheridia, but yet had midway between base and apex a peculiar protuberance. This I suspected to be a young sporophyte apogamously developed.

The prothallium was imbedded in the usual way, and yesterday it was cut into a series of sections. These demonstrate conclusively, I think, that the prothallium was apogamous, for while there is no trace of an archegonium, I find, in the first place, a row of *scalariform tracheides*, and in the second place—except over a limited area, where I believe the apex of the root has been separated off by the appearance of a conical split—there is *no sharp distinction between the cells of the sporophyte and gametophyte*.

It should be added that my examination of the sections was necessarily a hurried one, and that at present it is impossible to be certain that the prothallium was developed from a spore of *P. serrulata cristata*. The ferns of the garden and house where the prothallium grew, however, included no known apogamous forms.

It is not unlikely that I may be unable to follow the matter further, and this must be my excuse for making public, without further investigation, this interesting fact. A. H. TROW.

University College of South Wales and  
Monmouthshire, February 27.

Fireballs.

THE large meteor of February 21 last, mentioned in NATURE of March 1 (p. 419), was also observed by me at Bristol. The time was noted at 7h. 18m., and the meteor was estimated as bright as Jupiter, but its light was much dimmed by the fog, low on the northern horizon, where it appeared. Its direction of flight was not well determined, the path being short and rapidly traversed in a place barren of visible stars, but it was roughly recorded as from  $252^{\circ} + 53^{\circ}$  to  $253^{\circ} + 49^{\circ}$ . Comparing it with the description by Mr. Greig at Dundee, and with notes from North Lincolnshire and other places, it seems the meteor disappeared at a height of about thirty miles over Bolton, Lancashire; but the place and height of its first appearance are not satisfactorily indicated. The probable radiant is in Ursæ Major. A good observation from Ireland, or the north-west part of England, would be very useful in assigning the precise path.

A fine example of a fireball, visible in sunshine, was afforded by the meteor of February 8, oh. 28m. p.m., which appears to have been very widely observed in this country. Its real path was from a point above the Irish Sea, west of Southport, where its approximate elevation was seventy-five or eighty miles, and from thence it passed rapidly over Lancashire into Yorkshire, finally disappearing near Leeds at a height of twenty miles, or possibly less. Its radiant point was in Hercules, and the direction of its motion from west by south to east by north. This daylight fireball may have had its origin in the same system as that which supplied the brilliant fireball seen in the evening twilight of February 7, 1863, the radiant of which was about  $270^{\circ} + 35^{\circ}$ .

Bristol, March 4.

W. F. DENNING.

Astronomy in Poetry.

*À propos* of the subject of "Astronomy in Poetry," permit me to quote one verse from "The Faerie Queene" of Spenser:—

Yet all these were, when no man did them know,  
Yet have from wisest ages hidden bene;  
And later times things more unknowne shall show,  
Why then should witless man so much misweene,  
That nothing is but that which he hath seene?  
What if within the Mooones fayre shining spheare,  
What if in every other starre unseene  
Of other worlds he happily should heare,  
He wonder would much more: yet such to some appeare.

I have followed the spelling and the punctuation of the text of the "Globe" edition (1879).

Kendal, Westmorland.

G. W. MURDOCH.

NO. 1271, VOL. 49]

RECENT PUBLICATIONS OF THE AMERICAN  
GEOLOGICAL SURVEY.

TO initiate and to be left behind—that seems to be the fate of England in the latter half of the nineteenth century. In science, at any rate, it is too often so. A sight of the volumes—fourteen in number, the earliest dated in 1891—with which our table is loaded, a glance at those which are already ranged upon our shelves, indicate that this is emphatically true of the work of the Geological Survey. We mean no reproach to British men of science or to the British surveyors. The State despises the one and starves the other; and the "people love to have it so"; for what care they for learning or research, unless it will obviously put money into the pocket? But this is a large question, and our space will not suffice even for an adequate notice of the volumes before us. These consist of one bound octavo volume on the mineral resources of the United States (the eighth of a series), nine paper-covered numbers of the *Bulletin*, slightly larger in size, ranging from thirty to five hundred and fifty pages; two volumes, still larger, of the Annual Report (eleventh), and yet two volumes of Monographs of quarto size.

Passing by the first as of commercial rather than of scientific interest, we come to the *Bulletin*. Four of the numbers, smaller than the others, though they make up to full 220 pages, have little in common. No. 90 is a report of work done in the Division of Chemistry and Physics, mainly during the years 1890-91. It contains several studies and analyses of special minerals, including a research on certain micas, vermiculites and chlorites, and a note on the colloidal sulphides of gold, in which it is suggested that the separation of free gold in the upper strata of the earth's crust may have been effected by the action of sulphuretted hydrogen on chloride of gold, at no very great depth, though at one less than that at which pyrites is formed. The report concludes with a number of analyses of miscellaneous rock specimens. No. 91 is a "Record of North American Geology for 1890," a very useful bibliography of papers, &c., classified not only under names of authors, but also under subjects. No. 93 is a pamphlet by Mr. S. H. Scudder, on "Some insects of special interest, chiefly from Colorado," and No. 94, which is about the same length, is by Mr. E. S. Holden, on "Earthquakes in California in 1890 and 1891."

The larger volumes of the *Bulletin* are all "Correlation Papers," or memoirs written on some one geological period, by a specially qualified author, "for the purpose of summarising existing knowledge with reference to the geologic formations of North America, and especially of the United States; of discussing the correlation of formations found in different parts of the country with one another and with formations in other countries; and of discussing the principles of geological correlation in the light of American phenomena." Of these four memoirs the largest (No. 86), written by Prof. C. R. van Hise, deals with the "Archæan and Algonkian" systems.

By these names the author designates the vast mass of rocks which lies beneath the *Olenellus* zone of the Cambrian system. In dealing with the subject he has adopted the following method:—Each chapter treats of some important district. It gives full abstracts of the more important papers bearing on the geology of that district, which is followed by a bibliographical list, and concluded by a summary of the results. More than four hundred pages are thus occupied, and the work is ended by a long chapter (about eighty pages) on "general successions and discussion of principles."

The author employs the term Algonkian for "the pre-Olenellus clastics and their equivalent crystallines," and Archæan for the completely crystalline rocks below

them. The latter system, accordingly, "has no limit downward. It is the oldest system, and surely includes, if such rocks exist, all of the original crust of the earth." The upward limit also is not easily defined, but "it is frequently easy in the field to say, with a great degree of probability, what rocks are Archæan and what post-Archæan." Thus the former system includes the original Huronian of Logan, which the author inclines to think separable into two divisions, the lower of which comes nearer than the upper to assuming a crystalline character. It also covers the Animikie and the Keweenaw of Irving; in short, a vast group of rocks which are generally clastic in origin, and seldom more than sub-crystalline in character, in certain of which undoubted traces of life—though very rarely—have been found. The origin of the Archæan system is considered to be a problem yet unsolved. Its rocks are highly crystalline, and if any have been formerly sediments all traces of a clastic origin have been completely lost. It certainly constitutes a complex, probably to no small part of igneous origin, and the author evidently inclines to the view "that this earliest crystalline complex was produced under conditions differing from those of the rocks of any subsequent period." He would employ the term Laurentian in a more restricted sense than that in which it was used by Logan for the gneissoid part of the Archæan, while he dismisses most of the six pre-Cambrian rock systems of the late Sterry Hunt and his school as hypothetical existences to which the atmosphere of the laboratory was more congenial than the air of the field.

In a subject so difficult as these pre-Cambrian rocks, where so many things are yet unsettled, Prof. van Hise cannot expect to satisfy all readers. Speaking for ourselves, we think he is disposed to attribute too much potency to dynamic metamorphism—an agency which is being rather "boomed" at the present time—and to admit on too slight evidence that in "Silurian, Devonian, and even later times, completely crystalline schists have been produced over large areas"; for in the past this assertion has been so often made, and so often proved to be erroneous, that on the principle, "once bit twice shy," we are disposed to be a little sceptical. But whether we accept or whether we demur to the author's conclusion, we gladly welcome his volume as a contribution to the history of the pre-Cambrian rocks which will be invaluable to students, and is full of sagacious criticism and suggestive remarks.

The next Correlation Paper (No. 85), written by Mr. I. C. Russell, deals with the Newark system, which occupies a series of rather elongated outcrops in the Eastern States, and runs along the shore of the Bay of Fundy. The fragmental rocks of this system, which includes the well-known New Red Sandstone of Connecticut, vary from coarse to fine; a few thin seams of coal and limestone are also present. Dykes and sheets of basalt, &c. occur in almost every area. The system is limited by an unconformity, both above and below, and is not easily correlated precisely with those of Europe, but the reptiles, amphibia, and crustacea correspond generally with those of the Keuper, the fishes with the Mesozoic rather than with the Palæozoic, and the plants with the Upper Trias or Rhætic, so that it evidently represents an early portion of Mesozoic time.

A third Correlation Paper (No. 82), by Mr. C. A. White, deals with the Cretaceous. This system occupies in the interior a very wide zone (the southern half being the less uniform in outline) which extends roughly from latitude 28° to 60°. Further north are some outlying patches; near the Pacific coast is a long string of the same, and in the Southern States east of the Mississippi a crescentic area. The rocks, especially in the Interior Basin, have been affected in many places by great displacements both during and after Cretaceous times, but though over a

large part of this region they have been elevated from about one to five thousand feet above the sea, they generally lie almost horizontally; these displacements are more frequent in the Lower than in the Upper Cretaceous. Also much volcanic material was extruded during this period as well as after its close. In the Interior Basin marine deposits alternate with freshwater, but the latter predominate, showing that the land was more often above than below sea level.

The Eocene forms the subject of another Correlation Paper (*Bulletin* No. 83), by Dr. W. B. Clark. The rocks of this period occur in the same regions as the Cretaceous, but occupy much less extensive areas in the western half of the continent, while they are more largely developed in the south-east, extending from the Mexican frontier to New Jersey State. The last, as is well known, are marine, and comparable with the deposits on the other side of the Atlantic, but the correlation of the various groups of the Interior Basin, including the transitional Laramie deposits, is very difficult, probably because the flora and fauna of these inland waters, as they were changing from brackish to fresh, present so few points of comparison with other regions. Still, Dr. Clark's clear summary of the main results of investigation, and of the succession of the strata, will be very helpful to the student.

The last *Bulletin* before us (No. 84), by Messrs. W. H. Dall and G. D. Harris, describes the Neocene. This term is supposed to include the Tertiaries other than Eocene. We have not troubled to inquire to whom belongs the honour of its paternity. If it does not mean New-new, then words respectively more applicable to persons and things are combined. Perhaps the one half was intended to apply to the animals, the other to the rocks; or perhaps—what is more usual with geologists—nobody troubled himself to think whether the term was sense or nonsense. The memoir, however, is full of valuable and interesting information, for it deals with the final shaping of the American continent and the development of its fauna; but with this bare mention we must be satisfied.

Of the two volumes of Monographs, one (No. xvii.) has a melancholy interest, for it is the last work of "the Nestor of American palæobotanists," Leo Lesquereux, left barely complete at his death. The memoir on the "Flora of the Dakota Group" has been edited by Prof. F. H. Knowlton. The Dakota group appears to correspond more closely with the Cenomanian of Europe; thus its plants have an exceptional interest, since they "pertain to an epoch in which, by the appearance of the dicotyledons, the character of the flora of the globe has been modified as by a new creation. The cause or reason of this marked change remains still unexplained." The flora described by Prof. Lesquereux consists of 460 species, of which 429 are dicotyledons. Sixty-six plates illustrate their remains, and the volume concludes with an analysis of the results of the investigation, which is of interest to more than palæobotanists. We must, however, restrict ourselves to stating Prof. Lesquereux's conclusion: that the flora of North America is not the result of migration in past geological times, but an indigenous one. All the plants of the American Cenomanian (except those of *Ficus* and the *Cycads*) might still find a congenial climate in the United States between latitudes 30° and 40°—that is to say, in localities at most a very few degrees (perhaps five) further to the south. Since the Cenomanian epoch the land surface between the Rocky Mountains and the Alleghanias has suffered no physical change of importance, for the general absence of drift deposits from these vast plains indicates that they were not greatly affected even by the glacial epoch. "The result has been a prolonged uniformity of climate and, of course, the preservation of the original types of the flora, subjected to some modification of their original

characters, without destroying them or forcing their removal by the introduction of strange or exotic forms."

The second volume of the Monographs (No. xviii.) describes the Gastropoda and Cephalopoda of the New Jersey Marls and accompanying beds; the Lamellibranchiata and Brachiopoda having been already the subject of a memoir (No. ix.). These deposits are generally glauconitic; the fossils are casts, often ill-preserved, so that the determination of them has been not seldom attended by great difficulties; they bear a superficial resemblance to those from the Cambridge Greensand of England, and the rock contains a certain proportion of phosphate of lime, though these casts do not appear to be, strictly speaking, phosphatised. The Marls, as is well known, are mostly Cretaceous in age, no part representing the Neocomian, but the uppermost beds are referred to the Eocene. Beneath the last are indications of a very slight break: so that systems which in our own country and the adjacent parts of Europe are separated by a wide gap, in this region are practically continuous. The beds—which may possibly be Neocomian—beneath the Marls, called the Raritan clays, are brackish or even fresh water in origin; the Marls themselves are marine, but shallow water deposits. The Cretaceous members contain the usual cephalopods, which come chiefly from the lower Marls, as indeed do most of the other fossils. Among these are seven species of Ammonites, four of Scaphites, and three of Baculites; Turritiles, Heteroceras, Ptychoceras, and Belemnites are each represented by one species. None, however, appear to be individually common, and most are rare. The Eocene contains one Nautilus and one Aturia. The Gastropoda are fairly numerous, 136 in the Cretaceous and 52 in the Eocene. As the former volume showed, the Lamellibranchiata are more strongly represented in the Cretaceous than in the Eocene, and in the former deposit dominate over the Gastropoda; the Brachiopoda are in neither numerous. The illustrations in this volume exceed fifty plates.

The eleventh annual report is in two parts. The first, after the usual official matter, contains two lengthy memoirs; the first, almost a volume in itself, by Mr. W. J. McGee, entitled the "Pleistocene History of North-Eastern Iowa," the second, by Mr. A. J. Phinney, on the "Natural Gas Field of Indiana," with an introduction by the former author. In the "Pleistocene History" Mr. McGee gives a very full and interesting account of the drifts of a large area of Iowa, with maps illustrative of the conclusions which he considers them to justify. The region appears to have been twice invaded by ice, the earlier glaciation being "the longer and the more energetic." Glacial striæ, however, are very rarely found, in consequence, probably, of the incoherence of the rock masses to this region. As memorials of these invasions of the ice-sheet, an upper and lower till can generally be distinguished; and the latter sometimes shows crumplings, interpreted as memorials of the pressure of the second ice-sheet; between these tills a kind of "forest-bed" is frequently to be found. By each advance of the ice-sheet, rivers were dammed and great lakes formed on its margin, in the waters of which materials were deposited from the ice and from other sources, much of this being a stiff clay, locally named "gumbo." During the first invasion the land sank; perhaps sufficiently to allow of an invasion of the sea. A similar but less extensive subsidence took place in consequence of the second invasion. These depressions aided in the formation of the lakes. A summary this, necessarily very imperfect, but it may suffice to indicate the general conclusions at which the author has arrived.

The second memoir contains a vast amount of information concerning the natural gas and oil wells of Indiana, and is prefaced by a general sketch of the distribution of bituminous deposits. The commercially valuable bitu-

mens occur (not in America only) in the Lower Silurian rocks, and continue to comparatively recent times, but the most important are found in the Silurian and Devonian systems, and in the Tertiary series. In the first the products are chiefly gas; in the second both are found, petroleum probably predominating; while in the third nearly all the known forms occur.

The second part of the report deals exclusively with irrigation. Maps and details of the arid region of the United States are given, from which it appears that this extends from their northern frontier to the 32nd parallel of latitude, and from the eastern slopes of the Sierra Nevada approximately to the 100th parallel of longitude, thus including the great Inland Basin and the Rocky Mountains. On the ranges, however, there is a considerable amount of precipitation. As stated by Major Powell, in evidence before a Committee of Congress, the rainfall on the mountains may vary from 25 to 60 inches per annum, while in the valleys below it is generally less than 15, and sometimes even as small as 3 inches.

These publications, as this imperfect sketch may indicate, are full of varied and valuable information, and are richly illustrated with maps, plates, and woodcuts. If we might venture on a general criticism, it would be that the authors not seldom exhibit a tendency to "spread themselves" too much, to be over-diffuse in style, and to enter upon general disquisitions, which, however interesting, are a little out of place in official publications. Space also seems occasionally to be wasted in giving information which would be more appropriate in a text-book of geology. As the volumes are primarily designed for the people of the United States, the authors may be presumed to know best the desires of their own public, but this redundancy is sometimes a little wearisome to outsiders. Possibly the recent reduction of the vote for the support of the Survey, which we trust will not be permanent, may be intended as an expression of this feeling. Very probably some economies might be effected, but it will be an ill day for this branch of science if the work of the Geological Survey of the United States is seriously cramped.

T. G. BONNEY.

#### MEASUREMENTS OF LOW VAPOUR PRESSURES.

THE two well-known methods of measuring vapour pressures are the statical and the dynamical. In the former the pressure exerted by a vapour is measured when the substance is kept at a given temperature, while in the latter the temperature is ascertained at which the liquid boils when under a given pressure. The present volume is mainly concerned with the description of, and the results obtained by, a dynamical method of estimating very low pressures for mixed as well as for pure substances; the pressure range extending, in general, from about zero to a maximum which is below 70 mm.

Before proceeding to the description of this method, the author seeks to clear away certain discrepancies which have been recorded regarding the results of vapour pressure observations as given by the statical and dynamical methods. Dynamical observations on the fatty acids, published by himself in 1885, differed considerably at low pressures from those obtained by Landolt in 1868 from statical measurements. From the fact that the differences varied regularly with the chemical nature of the acids, it appeared possible that at very low pressures the two methods led to different results. A historical summary of work on this subject is

1 "Studien über Dampfspannungsmessungen." In Gemeinschaft mit Paul Schröter und andern Mitarbeitern von Georg W. A. Kahlbaum. asel: Benno Schwabe, 1893.)



given, which serves to show that whereas Dalton and Magnus definitely asserted that such a difference existed, Regnault, on the other hand, although he held it to be theoretically possible, found that it could not be detected in the case of pure substances. Regnault's observations, however, were not made at very low pressures, and his observations on water seemed to indicate that in this region a difference really existed. To test this point, the author carries out dynamical observations on water and mercury at pressures below 60 mm., and ascertains that they are in perfect accord with published statical observations. He next repeats Landolt's statical observations on the fatty acids, taking elaborate precautions to introduce dry and air-free substances into the barometer tube, and obtains results agreeing with those given in 1885 by the dynamical method. Landolt's results are thus held to be inaccurate, the presence of moisture in the liquids used being regarded as the disturbing factor. This assumption is shown by Konowalow's observations to explain why the differences varied, as already indicated, with the chemical nature of the acids.

It is therefore concluded that statical and dynamical methods give the same results even at the lowest pressures. This could hardly be otherwise, however, from the fact that in the dynamical method employed a current of air bubbles is allowed to pass continually through the liquid, ample free surface being thus allowed for evaporation.

As the dynamical method is the more easily carried out, and as the results obtained by it are affected to a much less extent by traces of moisture, &c., than those given by the statical method, it is adopted for the examination of pure and mixed substances. The apparatus here employed consists of a Beckmann's boiling-point flask which is connected up with a large air reservoir fitted with a manometer. The reservoir may be exhausted either by a water pump or by an automatic mercury pump. The liquid is made to boil in the flask, which, as usual, contains glass beads, and a current of air-bubbles is allowed to pass through the liquid. The thermometer is immersed in the liquid, preliminary observations with a pure substance having shown that the same results were thus obtained as when the thermometer was suspended in the vapour. On account of the high efficiency of the mercury pump, observations could be taken when the liquid was boiling into almost a perfect vacuum.

The substances operated upon are the first ten normal fatty acids, the first three iso-acids and monochloroacetic acid, together with mixtures of the acids themselves, and of formic acid and acetic acid, with varying amounts of water. Excellent drawings of the apparatus used, including the various pumps employed, mercury joints, &c., and curves representing the results obtained, in which 1 c.m. corresponds with 1 mm. and 1° are supplied separately along with the volume. The graphical representation of the results, and indeed the whole contents of the book, indicate that the research has been carried out with the greatest care.

As the numbers obtained are to be discussed and compared with those of other observers in a second volume, which has not yet appeared, it is perhaps out of place to say much by way of criticism at this stage. It is to be hoped, however, that in vol. ii. Ramsay and Young's work will be more fully considered, for in the present volume, especially when dealing with the identity of the values given by statical and dynamical methods, it receives anything but its fair share of recognition.

J. W. RODGER.

#### NOTES.

AT the coming meeting of the British Association, which will be held at Oxford, under the Presidency of Lord Salisbury, Prof. A. W. Rücker will preside in Section A (Mathematics

and Physics); Prof. H. B. Dixon in Section B (Chemistry); Mr. L. Fletcher in Section C (Geology); Prof. Bayley Balfour in Section D (Biology); Captain Wharton in Section E (Geography); Prof. Bastable in Section F (Economic Science and Statistics); Prof. Kennedy in Section G (Mechanical Science); Sir W. H. Flower in Section H (Anthropology); and Prof. Schäfer in the new Section I (Physiology). The evening discourses will be delivered by Prof. J. Shield Nicholson and Mr. W. H. White. Sir Douglas Galton will be proposed as President for the meeting in 1895, at Ipswich.

PROF. BURDON SANDERSON, F.R.S., and Mr. T. Pridgin Teale, F.R.S., have been selected by the University Board of the Faculty of Medicine to represent the University of Oxford at the International Medical Congress to be opened at Rome on March 29.

THE annual Congress of the British Institute of Public Health will be held in London, from July 26 to 31, 1894, under the presidency of Dr. W. R. Smith. It will be arranged in five sections: Preventive Medicine, Chemistry and Climatology, Engineering and Building Construction, Municipal and Parliamentary, and Naval and Military Hygiene.

AN imperial *iradé* has been issued, a Turkish paper says, ordering the establishment in the chief town of each province of an antirabific laboratory similar to the one which has been working for some time in the capital. These Pasteur institutes will be established first of all in the chief towns of the most distant provinces of the empire, such as Yemen, Bagdad, Damascus, Erzeroum, and Monastir.

MR. KARL PEARSON has resigned his appointment as Gresham Lecturer on Geometry.

SEVERE earthquake shocks were felt in Odessa and other parts of Southern Russia on Friday and Sunday last.

DR. ELBS, Professor of Physical Chemistry in Freiburg University, has been appointed Professor in Giessen University.

MR. PETER JAMIESON has resigned his position on the scientific staff of the Fishery Board for Scotland.

THE death is announced of Emeritus Professor Swan, who held the Chair of Natural Philosophy in St. Andrews' University for twenty years.

M. EUGÈNE CATALAN, whose death we announced last week, was inadvertently stated to be connected with the Paris instead of the Brussels Academy of Sciences. Though born in Bruges eighty years ago, he was educated in Paris, and accepted French naturalisation. He entered the Polytechnic School in 1834, and was afterwards admitted into the civil engineering service, but gave up his post in order to devote himself to the teaching of mathematics, in which vocation he was very successful. He obtained a Professor's Chair at Charlemagne, and, at a later period, one at St. Louis College, and was also a *répétiteur* in the Polytechnic School. When the revolution of 1848 broke out, he ranked with the Republican party. After the *coup d'état*, however, he refused to take the oath of office, and returned to his native country, resuming his Belgian citizenship, and accepting a professorship in the School of Mines at Liège. He was the author of a large number of books on mathematics, and published many interesting theorems, principally relating to geometry and the theory of numbers.

THE Allahabad *Pioneer* says that the prize given by Sir Charles Elliott for scientific research in India has been awarded to Babu Chandra Kanta Basu, Madripur. His essay deals with the phenomenon known as the Barisal Guns.

WE learn from the *British Medical Journal* that a prize of 10,000 roubles (£1000) is offered by Count Orloff-Davidoff for the discovery of a remedy "perfectly certain to cure or to protect horned beasts against cattle plague." The efficacy of the remedy is to be proved by the same standard as those known to science as protective against small-pox, anthrax, swine fever, &c. The award of the prize is in the hands of the Curator of the Imperial Institute of Experimental Medicine of St. Petersburg acting on the advice of a committee of experts selected for the purpose. The competition is open to the whole world with the exception of active members of the above-named institute. The description of the proposed remedy must be clear and complete; it must be sent in, under the ordinary conditions as to concealment of the identity on the part of the author, on or before January 1, 1897. The award of the prize will be made on January 1, 1899. If no remedy satisfies the committee, a further competition will take place, and the award made on January 1, 1902.

MR. F. G. JACKSON, whose scheme of Arctic exploration from Franz Josef Land as a base has been frequently referred to in NATURE, announces definitely that he will set out on his expedition this summer, the whole cost of equipment being borne by Mr. Alfred C. W. Harmsworth, of St. Peter's, Kent.

THE Canadian Geological Survey, not content with mapping the peopled and fertile regions of the Dominion, have for several years been actively engaged in exploring the vast tracts of utterly unknown lands in the far north. Mr. J. B. Tyrrell, who has had much experience in pioneer work, started from Lake Athabasca in June 1893, with his brother Mr. J. W. Tyrrell, to cross the Barren Lands in canoes on the unmapped rivers. From Black Lake a portage was made to the head of a river, the Doobaunt, sketched in, from native report presumably, on Stieler's Atlas, but shown in practically the same position as the Messrs. Tyrrell found it to occupy. Descending this river and its chain of connected lakes for over 800 miles, they reached the head of Chesterfield Inlet on Hudson Bay in the beginning of September, and after completing the survey of that region, made a perilous canoe voyage in the open sea to Fort Churchill, whence the journey was pursued on foot, Winnipeg being reached, after many hardships and much suffering, early in 1894. Mr. A. P. Low, of the same Survey, carried out an important piece of exploration last summer, passing through the centre of the Labrador peninsula from the south to Ungava Bay on Hudson Strait, in the course of which he crossed 750 miles of country hitherto quite unknown. Mr. R. G. McConnell was also engaged in explorations on the upper valley of the Peace River, in the Rocky Mountain region.

SOME time ago, in the Gurhwal district in India, an immense slip from a precipitous mountain blocked the valley of the Behai-Ganga River. The dam is some nine hundred feet high, and is already consolidated in its lower portions. The water confined within it has now reached a height of 450 feet, and is fast increasing. It is feared that the winter rains will cause a sudden overflow of the water, and bring an overwhelming disaster to the villages in the valley beneath. Nothing can be done to avert the disaster. Lieutenant Crookshank, R.E., is stationed near to watch the progress of events, and give timely warning.

OUR contemporary and namesake, *Die Natur*, has an article by Dr. Karl Müller on Prof. Philippi's paper, to which we recently called attention, on the analogies between the floras of Chili and Europe. He regards them as furnishing a striking example of the general law that similar conditions will produce,

on the most widely separated portions of the surface of the earth, the same type, whether of animal or vegetable life, but in different forms.

WE learn from the *Circular* of the Johns Hopkins University (Baltimore), that Captain John Donnell Smith has signified his intention of presenting to the University his valuable botanical library and herbarium, as soon as a suitable building shall be offered for their reception, and provision made for their maintenance in connection with a department for instruction and original work in botany. They are already open to the students in botany at the University. The herbarium is one of the largest and best selected private herbaria in existence, and is especially rich in the flora of Guatemala and other parts of Central America, where Captain Donnell Smith has made large collections himself, including a great number of new species and some new genera. This indefatigable collector has again started on another visit to Central America.

DURING the afternoon of February 23, a remarkable oscillation of the barometer took place in the northern parts of these islands, accompanied by a south-westerly gale of great force and suddenness. At 8 a.m. the reading published by the Meteorological Office for Stornoway was 29.39 inches, being a fall of 0.7 inch since the previous day, and at 6 p.m. the reading was 28.58 inches. But from a tracing of a self-recording aneroid, kindly sent to us by Mr. R. H. Scott, F.R.S., it appears that the minimum occurred there about 4 p.m., and was about 0.3 inch lower than the 6 p.m. reading. The fall during the eight hours preceding the minimum had been 0.9 inch, and between 2 and 4 p.m. the barometer fell at the rate of nearly 0.2 an hour, while the rise during the next two hours (as shown above) was nearly as rapid. This remarkable oscillation was fully borne out by the changes at other stations, where they were probably smaller in extent. By 8 a.m. on the 24th the centre of the disturbance had travelled in a north-easterly direction to the coast of Norway.

AT the Society of Arts, on the 28th ult. Mr. G. J. Symons read an interesting paper on "Rainfall records in the British Isles." About forty years ago, Mr. B. Denton read before that society a paper pointing out the advantage of daily rainfall values, and giving the means for about 100 stations, and in 1860 Mr. Symons printed in the *Builder* a summary for the year 1859; subsequently he obtained some small grants from the British Association, which enabled him to continue his useful work with great success. In the year 1860 the total number of stations from which he received records was only 168, but in the year 1892 the number had increased to 2850. Ireland has not a fair share of stations, although a large number of rain-gauges have been gratuitously distributed; the returns only amount to 192. The question of the size of the gauge was discussed, from those of 1 inch to those of 6 feet in diameter, and the practical result is that the rainfall collected does not differ as much as 5 per cent. in any case, and for the smaller gauges it agrees within less than 2 per cent., so that it becomes merely a question of the most convenient size for use. As regards the influence of elevation on the amount of rain collected, the decrease is owing chiefly to the velocity of the wind being greater at a height. The first observations of this kind were made by Dr. Heberden on the top of Westminster Abbey more than a hundred years ago. Prof. Hellmann has also shown that if a gauge on a roof can be screened from the wind, the rainfall will not differ materially from the amount measured on the ground. Among the various diagrams exhibited was one representing the relative rainfall of about 160 successive years. From 1730 to 1750 the rainfall was considerably deficient, and there was no period of more than five consecutive wet years down to very recent times, but from 1875-83 there were nine consecutive wet years. Attention was drawn to the peculiar fact that

since the year 1812 every year ending with 4 had less than the average rainfall, excepting that every twelfth year reckoning from 1860 has had more than the average rain. According to this, the present year should be a dry one. Another diagram represented a notable instance of a torrential rain which occurred in the metropolis on June 23, 1878. It is an unusual thing in London for an inch of rain to fall in twenty-four hours, but in this case  $3\frac{1}{4}$  inches fell in an hour and a half.

THE U.S. *Monthly Weather Review* for November contains some remarks by the editor on a series of measurements of the growth of trees, made by Mr. J. Keuchler, of Gillespie County, Texas, about two hundred miles north-west from the Gulf Coast at Indianola. Mr. Keuchler seems to have adopted the idea that a tree bears the history of its climatic surroundings written in itself, and that its annual rings of growth vary in size mainly with the supply of water to the roots, so that broad rings indicate wet years, and thin rings that can scarcely be distinguished with the naked eye denote dry years. After carefully selecting trees for his measurements, he felled three oaks, two of which were over 130 years old. He cut a perpendicular section from each trunk near the thick end, planed its surface very smooth, and then varnished it over, which made the annual ring distinctly visible. From each section a table was prepared of the relative order and position of the annual rings; upon comparing these three tables they were found to correspond exactly, thus indicating that moisture is the principal cause of the difference in the breadth of the rings. Taking the width of the respective rings as a criterion of moisture, the record of 134 years shows 6 years extremely dry; 8 very dry; 19 dry; 17 average; 18 wet; 60 very wet; 6 extremely wet. The editor of the *Review* points out that the large number of very wet years is not at all in accord with the rainfall records during the years 1840 to 1890, and, in fact, no region on the globe is known where the distribution of the rainfall is similar to that given by these records. It is evident, therefore, that the breadth of the annual rings of growth adopted by Mr. Keuchler as corresponding to dry and average and wet seasons needs considerable modification. The width of the annual rings depend, at least in part, upon the evaporation, the sunshine, the temperature, and the distribution of rain in frequent showers or in frequent heavy floods. It is the combination of several favourable meteorological circumstances that must have produced the large number of broad rings which Mr. Keuchler has attributed to 60 very wet years and 6 other extremely wet years. In fact, the editor continues, it is best not to attempt to establish any fine details as to the climate from such a record of tree growth, but to be content with the general statement that there were 14 years during which the climate was unfavourable for the increase of woody fibre, 54 years during which there was an average favourability, and 66 years that produced large growth owing to very favourable conditions. All that can safely be concluded is that during 134 years there were 66 in which the rainfall was well conserved for the use of the tree.

A PAPER, by Dr. G. Agamennone, on the velocity of propagation of the principal earthquakes felt at Zante during 1893, was communicated to the Reale Accademia dei Lincei in December last. The method adopted for the calculation of the velocity was that used by Newcomb and Dutton in the case of the Charlestown earthquake of August 31, 1886. (*Amer. Jour. Sci.* vol. xxxv. 1888, p. 1.) For the earthquake of January 31, 1893, a velocity of 4.040 kilometres per second was obtained, with a probable error of 1.120. The earthquake of February 1, 1893, appeared to have travelled with an average velocity of  $3.280 \pm 0.700$  kilometres per second, and that of March 20 was propagated at the rate of  $2.330 \pm 0.330$  kilometres. In these three cases, Strasburg, at a distance of 1600 kilometres, was the most

remote station from Zante at which records of the wave were obtained. The disastrous shock of April 17, 1893, was recorded at Zante at 6h. 30m. 20s., Rome mean time, and it reached Potsdam, 1730 kilometres distant, at 6h. 41m. 40s. From these times, and those obtained at eight intervening stations, a velocity of  $2.340 \pm 0.300$  kilometres was calculated. The rate of progression of the wave felt on August 4 was  $2.120 \pm 0.27$  kilometres per second. Taking all five earthquakes, and including only the observations of the times of maximum phase, a mean velocity of  $2.43 \pm 0.07$  kilometres was obtained. The mean velocity derived from a discussion of the commencement of the disturbances on the seismograph records was 3.085 kilometres; but whether the difference is due to the higher velocity of the first earth tremors, or merely results from the inability of some of the seismographs to record very small movements, seems to be doubtful. The point is an important one, however, and one to which attention should be directed.

SINCE the experiments of Profs. Reinold and Rücker on the thinnest liquid films, the peculiar behaviour of the black areas in soap films has become well known. Herr F. Kohrausch, in *Wiedemann's Annalen*, describes a method of producing glass films of equally slight thickness, which share the remarkable stability of black liquid films. These are obtained by blowing out one of the duplex capillaries used by the author for mounting electrodes. These blow one into spheres with a partition across the centre, which may be reduced to extreme thinness. Those which exhibit Newton's colours of the first and higher orders break very soon, but those which are reduced far enough to appear black are sufficiently stable to keep indefinitely. Any moisture must be pumped out of the sphere, and the openings sealed up. The black areas are almost indistinguishable from holes in the plate, but show slight reflection at large angles of incidence. A peculiar phenomenon connected with these spheres is the note they give out during cooling. This note often lasts half a minute, and is analogous to that of a Trevelyan instrument with the exception that air is substituted for lead.

THE results of the investigations that reached a successful termination during the first year of the existence of the Yale Psychological Laboratory, New Haven, Conn., have just been published under the editorship of Dr. E. W. Scripture. One of the most important of the papers in the volume bears the title "Investigations on Reaction-Time and Attention," and is by Dr. C. B. Bliss. The general results of the experiments are summed up as follows: (1) The experiments did not indicate any difference in reaction-time produced by changing the colour of the light present in the field of vision. (2) No difference was detected between the times of reactions in the dark and those made while looking at a stationary incandescent light of six-candle power. (3) When this light was in motion the reaction-time was lengthened. (4) No difference was detected between the times of reactions in silence and those made while listening to the steady sound of a tuning-fork making 250 vibrations per second. (5) When the intermittent sound of a metronome was substituted for that of the fork, the reaction-time was lengthened. (6) The reaction-time to a sound heard in both ears is shorter than when the sound is heard only in one ear, even after making allowance for the difference in intensity.

THE ninth annual report of the operations of the U.S. Bureau of Ethnology during the fiscal year 1887-88 has recently been issued. Bound up with the report are two papers, in one of which Mr. John Murdoch describes the ethnological results of the International Polar Expedition to Point Barrow, Alaska; while the other, by Captain J. G. Bourke, contains a mass of information concerning the medicine-men of the Apache Indians. Mr. Murdoch's paper is a simple and exhaustive account of the

Esquimo of Alaska, containing all that is noteworthy about that body of people. Captain Bourke thinks that the title of "shaman" might be substituted with advantage for that of "medicine-man;" for this awkward compound, invented by early explorers in North America, must always mislead by conveying some implication of therapeutics. It is pointed out that medicine-men are but the priests of a form of belief and practice called shamanism, known in many parts of the world as a phase in religious evolution. Hoddentín, the pollen of the tule, is supposed by Apaches to possess mystic properties, and bags made with it are worn as amulets and used as charms. Captain Bourke points out the similarity between the use of the tule pollen and that of the kanque or sacred corn meal of the Zuñi, and dwells upon many analogues to their practices found in both hemispheres. The izzé-kloth is the magic cord of the Apache, and Captain Bourke gives a very complete description of it. He associates these cords with the quipus of the Peruvians and the wampum of the north-eastern tribes of America, and discovers analogies among nearly all the races of the earth, paying special attention to the rosaries and belt cords of the Roman Catholic Church. Major Powell remarks that though some people will hesitate to adopt all Captain Bourke's deductions, everyone will agree with his conclusions as to the necessity of breaking up, by the exhibition of true science, the sorcery and jugglery practices which both retard the civilisation of the tribes, and shorten and destroy the lives of many individuals among them.

A *Jahrbuch* has been published containing the results of observations made at Magdeburg Meteorological Observatory during 1892, under the direction of A. W. Grützmacher.

A "BULLETIN DES PUBLICATIONS NOUVELLES," just issued by MM. Gauthier-Villars et Fils, contains descriptions of all the works published by them during the latter half of last year.

THE results of botanical studies carried on at the University of Minnesota are to be reported in a serial, which will be published under the title "Minnesota Botanical Studies," edited by Prof. Conway M'Millan.

MR. JOHN ELLIOT, Meteorological Reporter to the Government of India, has issued the Monthly Weather Report, summarising the chief features of the weather in India during the month of September 1893.

MESSRS. W. WESLEY AND SON have issued a new "Natural History and Scientific Book Circular," No. 121, containing the titles of the works on natural history, scientific expeditions and voyages, anthropology, and ethnology, that they have for sale.

THE description and discussion of the meteorological observations made in Belgium during last year, contributed by M. A. Lancaster to the 1894 *Annuaire* of the Royal Observatory, of Belgium, has been published separately by F. Hayez, Brussels.

A TREATISE entitled "Researches on Matrices and Quaternions," by Dr. T. B. van Wettum, has been published by E. J. Brill, Leyden. The memoir is divided into four parts, dealing respectively with the matrix of the second order, some properties of versor-arcs, the matrix as a unit-quotient of vectors, and the solution of a linear vector-equation.

MESSRS. G. BELL AND SONS have just published the first part of an "Analytical Geometry for Beginners," by the Rev. T. G. Vyvyan. The book deals with the straight line and circle in a simple manner, and should be of use as an introduction to more advanced works on analytical geometry. The explanations are full, and the examples are numerous and properly graded.

NO. 1271, VOL. 49]

MR. C. M. IRVINE, writing from Fence, Lesmahagon, calls attention to the excessive rainfall measured at that place during last month. With a gauge four feet above the ground, the total fall measured was 8'96 inches, and for this year 12'69 inches. The measurements for the same months, during a period of seven years (1887-1893) gave an average of 4'468 inches, and for the month of February 2'020 inches.

AN uncommon work in Japanese binding, printed on Japanese paper, and set up in Japanese characters, has been received. The author is Mr. Tokutaro Ito, and the work contains a number of papers, chiefly on botany and zoology, brought together and published in commemoration of the ninetieth birthday of his grandfather, Keisuke Ito. Among other subjects, the essays deal with the *Burmanniaceæ* of Japan, *Oxyria digynia*, Hill, found in Japan, and the revision of Japanese Pedicularis.

MESSRS. JARROLD AND SONS have just published a new and interesting work entitled "Object Lessons in Botany from Forest, Field, and Garden," by Mr. E. Snelgrove. Botany rightly taught is the most pleasurable of sciences; and the guiding principle adopted by the author in the preparation of his book, namely, that of using common objects for illustration of unknown characters and functions, not only arouses interest, but must impart a large amount of sound instruction. The book will be useful to teachers in elementary schools, and should be a means of opening pleasant paths to their young students.

TWO new volumes have recently been added to the Aide-Mémoire Series edited by M. Léauté, and obtainable from MM. Gauthier-Villars, or G. Masson, Paris. In one of the books, entitled "Gîtes Métallifères," by Prof. L. de Launay, the author deals chiefly with statistics relating to the production and use of metals, taking the metals one by one, and giving the annual consumption of each, and the sources of the ores. Mining engineers and metallurgists will find the book useful. The second work referred to above—"Construction des Navire," by Prof. A. Croneau—contains a good course on the principles of ship construction.

THE *Annuaire de l'Observatoire Royal de Belgique* has arrived at its sixty-first year of issue. M. Folie contributes to the present volume an essay on variations of latitude; three articles on the determination of the constants of mutation and aberration; and one in which the question as to the direct or the retrograde movement of the instantaneous pole is discussed. M. Niesten writes on variations of latitude, and the Perseid meteors of 1893. M. Vincent gives instructions for the observation of periodic natural phenomena, and M. Lancaster describes the weather in Belgium during last year. The *Annuaire* contains the usual record of astronomical discoveries, meteorological observations, and statistical tables.

DR. A. DODEL'S "Biologischer Atlas der Botanik" (*Iris* series), published by C. Schmidt, Zurich, contains as excellent a set of coloured botanical diagrams as it is possible to desire for teaching purposes. The collection comprises seven large wall maps, upon which sixty-seven figures of parts of *Iris sibirica* are depicted. The figures illustrate the root, stem, leaves, flowers, and fruit of the plant in an admirable manner, the magnification being stated in each case, and in accuracy of delineation and beauty of reproduction they could hardly be excelled. The whole of the illustrations are from original drawings contained in an unpublished monograph by Dr. Dodel.

A BULKY volume just issued, vol. viii. of the "Travaux et Mémoires du Bureau International des Poids et Mesures,"

has for its contents the first part of a memoir by Dr. Max Thiesen, entitled "Kilogrammes Prototypes." The paper contains the results of comparisons of the weights of forty-two standard kilograms, designated *Prototypes nationaux*, made by Dr. Thiesen between 1886 and 1888. Of the 251 comparisons made, 230 were executed according to the scheme adopted by the International Committee of Weights and Measures in 1886; the remaining 20 had for their object the determination of the influence of transport on the prototypes. The plan of observation and all the elements used in the reduction of the observations are included in the present paper; but the details of the investigation, and the discussion of the results, are reserved for a future volume.

THE astronomical observations made by Tobias Mayer, at Göttingen, from 1756 to 1761, were published in 1826 by the Commissioners of Longitude. Five years later, Baily's memoir on Mayer's catalogue appeared, together with a comparison of the places of most of the stars with those given by Bradley. The celebrated "Sternvergeichniss" has again been discussed, this time by Dr. A. Auwers, with the assistance of other astronomers, and the results are given in a volume published by Engelmann, of Leipzig. The catalogue thus produced contains the places of 1027 stars computed for the epoch 1755.0. The volume also includes a discussion of Mayer's positions with those given by Bradley and others for the same epoch, a good series of proper motions being obtained by the comparison.

In these democratic days, very few journals affect to ignore the requirements of that undefinable quantity—the general public. This is what *Science Progress* does, however, in its first number, a copy of which has been sent to us. All the articles in this new publication are what our friends across the Channel term *articles de poids*—solid dissertations on the present state of knowledge of various subjects. Prof. Fitzgerald contributes a suggestive article on physical science and its connections, and Mr. J. W. Rodger describes the new theory of solutions founded by van't Hoff. Insular floras are passed in review by Mr. W. B. Hemsley, and the importance of the study of fossil plants is made out by Mr. A. C. Seward. The origin and nature of certain bacterial poisons forms the subject of an article by Dr. G. A. Buckmaster; the present outlook of vertebrate morphology is discussed by Prof. G. B. Howes, and a summary of the most important papers recently published in chemical physiology, or physiological chemistry, is given by Prof. W. D. Halliburton. Such are the subjects dealt with in the new magazine. References lie on the pages as thickly as leaves in Vallambrosa, and show the immense amount of work that has been done. The new venture appears to stand in the same relation to the majority of scientific journals as the heavy monthlies do to weekly newspapers. We hope that it will meet with a large measure of success.

In a recent number of *Electricité* (Paris), M. G. Claude gives an account of some experiments he has made on the electric arc in an alternating circuit. The phenomena produced by the disruptive discharge, in spite of the numerous experiments made with a view to elucidate them, are still far from completely elucidated. Thus, for example, it is well known what lengthy discussions have taken place over the question whether the electric arc, either with a continuous or alternating current, is the seat of a back electromotive force, or whether it behaves simply as an ordinary metallic resistance; yet it would be hardly true to say that this point has been definitely settled. In one of his experiments M. Claude joins two points, between which there is an alternating difference of potential of 2400 volts (frequency about 80 per second), by about 12 incandescent lamps (16 candle-power, 100 volt), a condenser of 0.1 microfarad capacity, and a make and break key all placed in series. When the key is closed, the circuit is traversed by the charge

and discharge currents of the condenser, the magnitude of which can easily be calculated, and which suffices to make the filaments of the incandescent lamps just glow. If now the key is opened so that there exists a small spark gap in the circuit (about 1 mm.), an arc will be struck at this point. Now this arc is certainly an additional resistance in the circuit, small it may be, since it is formed between metal points, but which certainly cannot be less than that which existed when the metal points were in contact. It is now found that the lamps show an increased brilliancy, and this brilliancy increases as the arc is made longer. This increase is such that, for the longest arc obtainable (a little over 1 mm.), the difference in potential between the terminals of each lamp rises from 30 volts to 90 volts, while the difference of potential between the terminals of the key is found to be about 1200 volts. The author gives the following explanation of this experiment:—The arc is a discontinuous phenomenon, and requires a certain minimum value to start, and thus, while the E.M.F. is below this value, no current passes, and the condenser remains uncharged. When the limiting E.M.F. is reached, the arc is struck, and the condenser is charged suddenly at a high potential. This charging of the condenser is limited to a fraction of the complete period, so that the charge current lasts a shorter time, and is of greater intensity than when no arc exists in the circuit. The absorption of energy in the lamps being proportional to the square of the current is increased, for the mean square of the current in the circuit is increased when the arc is present. The material forming the points between which the arc is struck, exerts an important influence on the facility with which the arc is maintained when the difference of potential diminishes, so that, although a much longer arc can be obtained by using carbon terminals, the above effect is not nearly so well marked as with terminals of iron or copper. It is of course necessary to have a condenser placed in the circuit to obtain the increased brilliancy of the lamps, for otherwise during the time the spark is unable to pass no current passes, while when the current does pass it has the same value it would have at the same part of the cycle if the spark gap were closed. On performing the experiment, M. Claude finds that when there is no condenser in circuit the luminosity of the lamps is slightly reduced when the arc is formed.

MR. A. GIBB MAITLAND, of the Queensland Geological Survey, points out that the sentences after that beginning "For a general colony map," in *NATURE*, vol. xlix. p. 109 (November 30, 1893), refer to the work being carried out by the staff on the Charters Towers Gold-field, and not to the whole colony.

THE additions to the Zoological Society's Gardens during the past week include an Indian Kite (*Milvus govinda*) from India, a Common Kestrel (*Tinnunculus alandarius*), a Golden Eagle (*Aquila chrysaetos*), a Barn Owl (*Strix flammea*), a Tawny Owl (*Syrnium aluco*) British, a Great Eagle Owl (*Bubo maximus*) European, a Spotted Eagle Owl (*Bubo maculosa*) from South Africa, presented by the Crystal Palace Company; two Levaillant's Francolins (*Francolinus levaillantii*), two Barn Owls (*Strix flammea*) from Port Elizabeth, South Africa, presented by Mr. B. Matcham; a Bar-tailed Godwit (*Limosa lapponica*), a Grey Plover (*Squatarola helvetica*), a Dunlin (*Tringa alpina*) British, two Ceylonese Hanging Parrakeets (*Loriculus asiaticus*) from Ceylon, purchased; and Eland (*Oreas canna*, ♀) born in the Gardens.

#### OUR ASTRONOMICAL COLUMN.

THE AURORA OF FEBRUARY 28.—A fine auroral display was observed in various parts of England on the evening of Wednesday, February 28. Several letters describing the phenomenon have been received, and the following from Mr. C. Thwaites gives a clear account of the general appearance at Norwich:—

"At a few minutes past seven o'clock a bright cone of light was seen springing up from the horizon at about east by north, this was followed by detached cloud-like streamers, which gradually joined into one vast, wide arch of brilliant light, extending, for a short time, completely across the heavens, slightly to the south of the zenith, to the south-west by south horizon. Other luminous patches also appeared on either side of this arch, one covered the space around Jupiter, others the constellations of Orion, Ursa Major, and Leo. Sometimes the rays or streamers gradually brightened, at other times they suddenly flashed into brightness; the effect of this pulsating light was very beautiful. The light was white, fading away at the edges of the rays, and was very similar to a strong, distant light seen through a haze or fog, which diffused the light, and softened its outlines. At half-past eight o'clock the rays had disappeared, and were followed by an arch of glowing light, which was centred at about the north-north-west, rising about fifty degrees towards the zenith."

Mr. Fowler, and other observers at the Astrophysical Laboratory, South Kensington, noticed a number of peculiarly bright clouds, flashing out chiefly in the west and south-west, between 7 and 8 p.m. He says: "From 8 p.m. to a little after 9 the phenomena observed were confined to the north, and took the form of a fine display of the aurora borealis. Streamers were comparatively rare, but at half-past eight there was a brilliant arc, reaching some ten degrees above the horizon at the highest point, which was in or very near to the magnetic meridian. Spectroscopic observations of the luminous clouds showed that the light consisted mainly of that which is characteristic of the aurora, being almost perfectly monochromatic and near wave-length 557. No clouds were seen when the aurora was brightest. During the maximum display of the aurora the characteristic bright line of the spectrum was seen in nearly every part of the sky, even where there was no visible haze or cloud." At the time of observation Mr. Fowler thought that the clouds did not owe their brightness simply to reflected aurora light, but as the observations towards the north were vitiated by the glare of the light of the Imperial Institute, he thinks that he may have been misled.

Rear-Admiral J. P. Maclaur observed the aurora at Cranleigh, Surrey. The following is an extract from his description of the appearance presented:—"After sunset two white luminous clouds, like bright fog clouds, became apparent in a west north-west direction, and as darkness came on the northern horizon was lighted with a pale green light. At 8h. 45m. there was a rose-tinted patch like a cloud near the tail of the Great Bear, at the same time the low arch of light to the northward was bordered with a very faint rose tinge. At 9h. the light gradually faded away."

MIRA CETI.—Observations of this variable star have shown that it has continued to brighten since the predicted date of maximum (February 17). At the present time (March 4) it is a trifle brighter than  $\delta$  Ceti, a star of magnitude 4.2, and is quite a conspicuous naked-eye star for a little while after darkness sets in. There are no indications that it has even yet reached the maximum. On some previous occasions it has reached the second magnitude. The predicted date of maximum was no doubt calculated on the basis of the period of 333 days, deduced by Argelander, but it is well known that the period, like the maximum brightness, is not always the same. There is evidence of a regular irregularity to the extent of twenty-five days. The present apparition is anything but favourable, owing to the proximity of the star to the sun.

According to the meteoritic hypothesis, the general light changes in such a variable as Mira are produced by the revolution of a subsidiary swarm of meteorites round a larger central one, the maximum luminosity occurring at periastron, when the collisions are most numerous. A perfectly constant period, however, can only occur in the case where the central swarm has a regular figure and density. In swarms such as we see in the spiral nebulae, taking rotation into account, it is evident that the secondary swarm might reach periastron under very different conditions in successive revolutions, and the maximum luminosity might either precede or follow the periastron passage.

HALLEY'S COMET.—Prof. Glasenapp announces that the computing bureau established by the Russian Astronomical Society has undertaken the calculation of the true path of Halley's Comet with a view to predicting the exact date of the next return. He hopes that astronomers acquainted with unpublished observations of the comet will communicate the information to the Society.

### IODINE AS A BASE FORMING ELEMENT.

AN important memoir is contributed to the current issue of the *Berichte* of the German Chemical Society, by Prof. Victor Meyer and Dr. Hartmann. A new substance of a somewhat surprising nature, the first member in all probability of an extensive series, has been prepared by them in the Heidelberg laboratory. We have been so impressed with the strongly-marked negative or acid-forming character usually exhibited by the halogen elements, that it is more or less astonishing to learn that a compound has been obtained containing iodine as the central, predominating, or grouping element, which not only contains that element acting in a tri-valent capacity exactly like nitrogen in ammonia, but which is a powerful *base*, combining with acids to form well-defined salts with elimination of water precisely as when a caustic alkali is neutralised by an acid. This remarkable new iodine compound is derived from an

as yet unisolated base  $\text{I} \begin{array}{l} \text{H} \\ \diagup \\ \text{H} \\ \diagdown \\ \text{OH} \end{array}$ , similarly constituted to hydroxyl-

amine  $\text{N} \begin{array}{l} \text{H} \\ \diagup \\ \text{H} \\ \diagdown \\ \text{OH} \end{array}$ . The substance itself is represented by the

formula  $\text{I} \begin{array}{l} \text{C}_6\text{H}_5 \\ \diagup \\ \text{C}_6\text{H}_5 \\ \diagdown \\ \text{OH} \end{array}$ , and just before transmitting the manuscript for

publication, the information was appended that the pure diphenyl derivative  $\text{I} \begin{array}{l} \text{C}_6\text{H}_5 \\ \diagup \\ \text{C}_6\text{H}_5 \\ \diagdown \\ \text{OH} \end{array}$  had likewise been isolated, but further particulars of it were reserved for a subsequent communication.

Prof. Meyer was led to suspect the possibility of the existence of such a compound from the fact that the oxy-iodine derivative of benzoic acid, the so-called iodoso-benzoic acid,

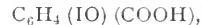

exhibits a very much feeble acid character than ordinary iodoso-benzoic acid,  $\text{C}_6\text{H}_4\text{I} \cdot \text{COOH}$ , and partakes indeed more of the character of a phenol, indicating that the group  $\text{I} : \text{O}$  is endowed with basic instead of acid properties. This supposition, moreover, is confirmed by the remarkable observation of Willgerodt, who has shown that the analogous derivative of the hydrocarbon benzene itself, iodoso-benzene  $\text{C}_6\text{H}_5 \cdot \text{IO}$ , forms a series of well-defined salts with acids. Hence it would appear that the as yet unisolated compound  $\text{H} \cdot \text{I} : \text{O}$  cannot be called hypo-iodous acid, for it is apparently a basic substance, and not an acid at all. An attempt was therefore made to saponify iodosobenzene by boiling it with dilute sulphuric acid, in order to convert it, if possible, into phenol and the sulphate of the supposed base. Dilute sulphuric acid readily dissolves iodosobenzene with formation of a sulphate, as shown by Willgerodt, but on mere boiling it still exhibits the reactions of iodosobenzene. Upon evaporation of the solution, and warming for several hours over the water-bath, however, it loses its capability of liberating iodine from potassium iodide, and a sulphate of a basic substance is indeed found to have been produced. As a method of preparation, however, the following is a much more convenient process:—

The iodosobenzene is placed directly in the calculated quantity of strongly cooled concentrated sulphuric acid. The solution becomes coloured brown, and contains no trace of the original iodosobenzene, as evidenced by its inability to liberate iodine; it consists almost entirely of the sulphate of the new base. The liquid is diluted by adding pieces of ice to prevent loss by rise of temperature, and the solution is most advantageously used to prepare the insoluble halogen salts, which much resemble those of silver, lead, and thallium, by adding a solution of potassium or sodium chloride, bromide, or iodide.

The free base is best obtained from the precipitated iodide by agitation with moist silver oxide. It may also be obtained directly from the sulphate by addition of baryta water; the solution thus obtained, however, is much more dilute. The aqueous solution of the base reacts very strongly alkaline. It cannot be readily obtained in the anhydrous condition, as it concentrates to a thick gum. Analyses of the iodide indicate that the empirical formula of the salt is  $\text{C}_6\text{H}_5\text{I}_3$ . Upon dry distillation the iodide decomposes completely to mono- and di-iodobenzene; hence its molecular formula must be three times the empirical, or  $\text{C}_{12}\text{H}_9\text{I}_3$ .

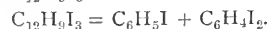

The formula of the base itself must consequently be

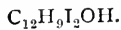

The reaction for its formation from iodosobenzene may be most simply stated thus:—

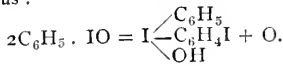

It may also be expressed so as to account for the action of the sulphuric acid as follows, starting with the sulphate of iodosobenzene:—

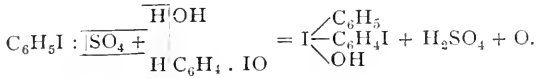

The chloride,  $C_{12}H_9I_2Cl$ , is a white curdy precipitate much resembling silver chloride. It crystallises from warm acetic acid, but the crystals are most readily obtained by mixing the aqueous solution of the free base with cold acetyl chloride, and boiling the resulting precipitate in the liquid for a short time; the clear solution deposits white rosettes of needles on cooling. The crystals melt at  $200^\circ-201^\circ$ , decomposing into chlorbenzenes like the iodide.

The bromide,  $C_{12}H_9I_2Br$ , is a pale yellow precipitate similar to silver bromide; it melts at  $167^\circ-168^\circ$  with similar decomposition. The melting point of the iodide is  $144^\circ$ .

The nitrate was obtained from the sulphuric acid solution by the addition of nitric acid, in the form of a white semi-solid precipitate, which changes into a mass of crystals upon agitation with ether. It dissolves in hot water.

The sulphate is readily soluble in water, as is evident from the mode of preparation; it dries to a solid, which has not yet been crystallised.

Concerning the second member of the series,  $I \begin{array}{l} \leftarrow C_6H_5 \\ \leftarrow C_6H_5 \\ \leftarrow OH \end{array}$ , it is

stated that it has been obtained from its iodide by the action of moist silver oxide, and that it is likewise a strongly alkaline substance readily soluble in water. The iodide, a polymer of iodobenzene, passes completely into the latter substance upon dry distillation.

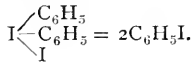

Further details of these interesting compounds, which must of necessity considerably modify our conception of the nature of iodine, are promised for the next number of the *Berichte*.

A. E. TUTTON.

PRINCE HENRY THE NAVIGATOR.

THE Royal Geographical Society held a special meeting on March 5, to celebrate the five-hundredth anniversary of the birth of Prince Henry the Navigator, the real initiator of modern maritime exploration. H.R.H. the Duke of York and the Portuguese Minister were present amongst the large audience, and appropriate addresses, illustrated by reproductions of early charts and historical portraits, were given by Mr. Clements R. Markham, F.R.S., President of the Society, Sir George Taubman-Goldie, Captain Wharton, F.R.S., Hydrographer, Mr. Beazley, Mr. H. Yule Oldham, Lecturer on Geography at Cambridge, and the Portuguese Minister. The anniversary was celebrated on a large scale with considerable pomp at Oporto, the ceremonies occupying three days.

If the formal celebration of the lives of the initiators of great movements in history and in science is a privilege of which their successors do well to avail themselves, the ceremonies observed at Oporto and in London, on March 4 and 5, were grateful acts. Prince Henry, distinguished from all his namesakes by his inseparable surname "the Navigator," was born on March 4, 1394, the son of King John I. of Portugal, and of Philippa, daughter of the Duke of Lancaster. From his early years he showed himself exceptionally studious, and when taking part in the siege of Ceuta, in 1415, he undoubtedly learned much of the interior trade of Africa, which supplemented the knowledge derived from the Arab geographers. But it is probable that the main incentive in his life-long effort to promote naviga-

tion and maritime discovery was the prospect of achieving the sea-route to India, and of making his country the first mercantile power in Europe. At the age of twenty-four he had definitely made up his mind on the subject of his life-work, and chose as his residence Sagres, at the extreme south-western corner of the Iberian peninsula facing the unknown ocean. The Prince made himself a master of the mathematics and astronomy of the day, and strove to induce mariners to follow his example and make use of the astrolabe in navigation. Observations at sea with an instrument so crude were necessarily very unsatisfactory, and, like their predecessors, the sailors of that day kept prudently within sight of land. Aided by the funds of the Order of Christ, Prince Henry fitted out expedition after expedition to trace out the African coast to the southward past Cape Nun. Inducements to trade were held out to adventurous merchant seamen of all nations, but these were insufficient as long as the explorers ventured no further than Cape Bojador. In 1434 Gil Eannes rounded that Cape, but the barren coast of the Sahara still met his eyes. In 1443 Antonio Gonsalvez crossed the Tropic of Cancer, reached and passed Cape Blanco, and brought home gold and slaves. From this time advance was more rapid, the inducements of commerce brought more volunteers to the work, and in three years the fertile coasts beyond Cape Verde were reached, and before the death of the Prince, in 1460, his efforts were rewarded by the rolling back of the cloud of absolute ignorance from over 1500 miles of hitherto unknown coast. The enterprise thus inaugurated went on with increasing success until Diaz rounded the Cape of Good Hope in 1486, and Vasco da Gama fulfilled the life's ambition of Prince Henry by reaching India in 1497, and raising Portugal to the height of its short-lived fame.

Prince Henry emphatically lived for his work, pursuing it without intermission in spite of the vast weight of prejudice and indifference against which he had to fight, and the result of that work is his best monument. He, if any one man, was the first to stir into strength the movement toward maritime exploration, which not only revealed the true form and extent of the most ancient continent, but in direct succession led to the discovery by Cabral of the new world, a discovery in no way brought about by the earlier voyages of Columbus, although these in a sense were the outcome of the same original impulse. It is through Ca da Mosto, a Venetian sailor engaged in African discovery for the Prince, that the best account of him as a man, and of his methods as a patron of exploration, are handed down. In his words—"He was the noblest Prince of his age, a man whose smallest virtue would suffice to immortalise him."

SCIENCE IN THE MAGAZINES.

SCIENCE makes a good show in the March magazines. Sir Robert Ball, F.R.S., contributes to the *Fortnightly* an article on "The Significance of Carbon in the Universe." The object of the article is to call attention to an investigation carried out by Dr. G. Johnstone Stoney, F.R.S., nearly thirty years ago, but the significance of which has not been widely recognised. From the tenor of the article we presume that the author refers to Dr. Stoney's paper "On the Physical Constitution of the Sun and Stars," read before the Royal Society in 1867. The paper is well known to workers in astronomical physics, though Sir Robert laments that some eminent physicists whom he questioned were unaware of its existence. Dr. Stoney gave evidence to show that the photospheric clouds on the sun were composed of carbon. In his words—"We have strong reasons for suspecting that the luminous clouds consist, like nearly all the sources of artificial light, of minutely divided carbon; and that the clouds themselves lie at a very short distance above the situation in which the heat is so fierce that carbon, in spite of its want of volatility, and of the enormous pressure to which it is there subjected, boils." (*Roy. Soc. Proc.* vol. xvii. p. 29, 1867-S.) Sir Robert Ball has taken the result contained in this conclusion, and expanded it into a lucid article containing much that is interesting. Dr. J. W. Gregory describes his adventurous journey to Mount Kenya. It is impossible not to admire the indomitable spirit he displayed throughout the whole expedition. He went to Africa to obtain information upon certain points, and though he found himself stranded at Mombasa before anything had been done, he got together a party of forty Zanzibaris, marched into the interior, accomplished his task, and returned to the

coast in safety. Dr. Gregory's objects in visiting Kenya were: (1) To collect the flora and fauna of the different zones; (2) to see if an Alpine flora occurred similar to that of corresponding altitudes in Kilima Njaro; (3) to examine the geological structure of the mountain with a view to the determination of its position in the African mountain system; (4) to see if there were any true glaciers upon it; (5) especially to determine whether these had at any time a greater extension than at present. All these points were satisfactorily settled, and the information obtained during the exploitation of the region traversed is of prime scientific importance. An interesting question as to the origin of the Rift Valley is raised, of which the following is a description: "From Lebanon, almost to the Cape, there runs a long, deep, and comparatively narrow valley occupied by the sea, by salt steppes that represent former lakes, and by a series of over twenty lakes, of which only one has an outlet to the sea. This is a condition of things absolutely unlike anything else on the surface of the earth. . . . But if the Rift Valley is unique as far as the earth is concerned, there are structures elsewhere which may be compared with it. It has long been known that there are on the moon, in addition to the well-known ring systems—generally spoken of as volcanoes—a series of long, straight clefts or furrows, known as 'rills.' The great East African depression would present to an inhabitant in the moon much the same aspect as the lunar rills do to us. Not the least interesting of the problems raised by this Rift Valley, is the possibility that it may explain the nature of these lunar clefts which have so long been a puzzle to astronomers."

Under the title "Scientific Problems of the Future," Lieut.-Colonel Elsdale considers, in the *Contemporary*, four leading problems, some, if not all, of which seem practically certain of solution in the next generation, if not in our own. The conquest of the air is the first of these problems, and the conclusion is arrived at that if the rate of progress of the last thirteen or fourteen years is kept up for a similar period in the future, aerial navigation will be an accomplished fact. The second of the problems is the diminution of the large percentage of the total resistance to a vessel's motion through the water due to surface or skin friction. "This friction," says the author, "is the leading and essential cause of the great waste of power in the propulsion of all vessels of man's design, whether partly or wholly submerged, when compared with the natural propulsion of fish or marine animals, such as whales, under corresponding circumstances and conditions. Hence the question of the possible reduction of this friction is one of vast and supreme importance to the marine engineer." Two other questions to which answers may be expected in the future are—"How can we best, by some simple and practical process, reduce coal to a condition in which it will, when brought into conjunction with the inexhaustible reservoir of oxygen in the atmosphere, give us the necessary elements for the production of an electric battery?" and "how to reduce the vegetable foods which at present are only adapted to animals like the cow, the sheep, or the horse, to a condition suited to the human digestion and to the human palate?" "Shakespeare's Natural History—a new light on Titus Andronicus," is the subject of an article by Mr. Phil Robinson. Shakespeare's authorship of this play has been disputed by many eminent critics. Mr. Robinson shows, however, that the natural history references in the play are almost identical with those of all the other plays attributed to Shakespeare. It has been objected that though the panther is referred to three times in "Titus Andronicus," it is not mentioned in any other of Shakespeare's plays. The reply to this brings out the following bit of information:—"If anyone will glance over the bard's flora, he will find that Shakespeare uses a great number of common plants only once—for instance, the holly, poppy, clover, brambles, lavender, and harebell, &c., and most remarkable of all, perhaps (and in a hunter, such as Shakespeare undeniably was), fern. . . . Among other trees he only mentions the ash once (and then as the shaft of a Volscian spear!), the birch once, as furnishing 'threatening twigs,' the lime-tree once. Among others, he never mentions at all the walnut-tree, the larch, the fir, the chestnut, the alder, the poplar, or the beech."

A well-illustrated and simple account of earthquakes and the methods of measuring them is contributed by Dr. E. S. Holden to the *Century*. The Lick Observatory is furnished with a complete set of Prof. Ewing's seismometers, and Dr. Holden describes them, while their arrangement and use are shown by means of several woodcuts. After stating the Rossi-Forel

scale of earthquake intensity, a means is indicated of making the scale even more useful than it is. From earthquake records, it has been found possible to assign a mechanical value to each of the ten numbers of the scale. Taking an acceleration of one millimetre per second as a unit, Dr. Holden has calculated that I. on the Rossi-Forel scale corresponds to  $\frac{1}{300}$  of the acceleration due to gravity, or 20 units; II. corresponds to  $\frac{1}{250}$  of gravity, or 40 units; III. corresponds to 60 units; IV. to 80 units; V. to 110 units; VI. to 150 units; VII. to 300 units; VIII. to 500 units; and IX. to 1200 units. All the shocks felt in San Francisco in the years from 1800 to 1888 have been evaluated in this way. There were 417 shocks in all, and the sum total of their accelerations was 33,360 units of intensity. "The average intensity of the 417 shocks of these 80 years results as IV., and this is  $\frac{1}{125}$  part of gravity. The total intensity for the whole period is  $\frac{3}{4}$  times the acceleration of gravity; that is, if all the earthquake force which has been expended in San Francisco during these 80 years were concentrated so as to act at a single instant, it would be capable of producing an acceleration almost  $3\frac{1}{2}$  times that of gravity."

*Harper's Magazine* contains an excellent article entitled "The Welcomes of the Flowers," in which Mr. W. Hamilton Gibson traces the development of knowledge as to flower-fertilisation from the time of Nehemias Grew to Darwin, and exemplifies the method of cross fertilisation by a number of well-chosen examples. The article is embellished with twenty-two remarkably fine illustrations. The Bessemer process of steel-making, and the plant used in the steel works of the United States, forms the second of a series of articles on "Great American Industries," edited by Mr. R. R. Bowker. Dr. T. M. Prudden writes on "Tuberculosis and its Prevention."

Mr. Frank Beddard, F.R.S., contributes to *Blackwood* a popular description of the characters and habits of some remarkable earth-worms, under the title "The Newest about Earth-worms." *Chambers's Journal* contains several chatty articles. In one of these, entitled "A Vegetable with a Pedigree," mention of the asparagus is traced back to about 425 B.C. Other articles deal with Italian granite, great cork forests, and Brazilian snakes. A facetious review of the "History of Four-footed Beasts and Serpents," by the Rev. Edward Topsel, an Elizabethan zoologist, appears in *Cornhill*. That distinguished author wrote of birds, beasts, and fishes which have never come within the ken of latter-day naturalists. Dr. T. Lauder Brunton, F.R.S., is the author of a short paper on "The Progress of Pharmacy" in the *Humanitarian*, and Sir Douglas Galton dwells on the necessity of observing "abnormal children" in elementary schools, in order to establish a sound basis for the proper conduct and development of our educational system. *Good Words* contains an illustrated article on "Celestial Photography," in which Mr. R. A. Gregory describes, among other celestial sights—

"Regions of lucid matter, taking form,  
Brushes of fire, hazy gleams.  
Clusters and beds of worlds, and bee-like swarms  
Of suns, and starry streams."

Mr. Douglas Archibald describes "Clouds and Cloudscapes" in the *English Illustrated Magazine*, his article being accompanied by illustrations of the typical forms of clouds. *Scribner's* and *Longman's Magazines* have been received in addition to those already noted. The former contains a fine engraving of Signor Tito Lessi's painting, "Milton visiting Galileo," and a description of "Subtropical Florida," by Mr. C. R. Dodge; and students of anthropology will find interest in an account of "Savage Spiritualism," contributed to the latter.

#### THE CAMBRIDGE DIPLOMA IN AGRICULTURE.

THE question of agricultural education at Cambridge—which the latest development is the establishment of a Diploma in Agriculture—is comparatively recent. The movement began some three years ago (in July, 1890) with a letter addressed by the President of the Board of Agriculture to the Duke of Devonshire in his capacity of Chancellor of the University. This led to the appointment of a University syndicate (*i.e.* committee), who framed a carefully weighed scheme of agricultural education and examination, the funds for which were to be supplied partly by the University and partly by the Cam-



bridgeshire County Council. The scheme was thrown out—on financial grounds—by the Senate, and here it seemed likely that agricultural education would come to a standstill, had it not been for the action of the County Councils of the Eastern Counties,<sup>1</sup> who, with the help of certain University professors, organised the Cambridge and Counties Agricultural Education Committee, an arrangement by which the counties supply the funds, while the University members supply the teaching. Under this scheme agricultural students are now receiving at Cambridge instruction in a number of subjects bearing directly on agriculture. The students are not necessarily members of the University, nor is agriculture a recognised department of University study; but it has now been practically sanctioned by the appointment of a University syndicate, whose duty it is to superintend the examinations on which the new diploma is to be granted. This procedure has a precedent in the successfully established diploma in State Medicine, and cannot fail to exert—both as a check and a stimulus—a wholesome effect on the unofficial agricultural department.

The first examination will be held in July. It consists of two parts: Part i. embraces botany, chemistry, physiology, entomology, geology, engineering, and book-keeping, in so far as each subject bears on agriculture. Part ii. comprises practical agriculture and surveying. The examinations are open to all who present themselves, and who pay the moderate fee demanded. Intending candidates may, it seems, obtain information from Prof. Liveing (who has taken the chief share in the work from the University side of the question) or from Mr. Francis Darwin.

### ON HOMOGENEOUS DIVISION OF SPACE.

§1. THE homogeneous division of any volume of space means the dividing of it into equal and similar parts, or cells, as I shall call them, all sameways oriented. If we take any point in the interior of one cell or on its boundary, and corresponding points of all the other cells, these points form a homogeneous assemblage of single points, according to Bravais' admirable and important definition.<sup>2</sup> The general problem of the homogeneous partition of space may be stated thus:—Given a homogeneous assemblage of single points, it is required to find every possible form of cell enclosing each of them subject to the condition that it is of the same shape and sameways oriented for all. An interesting application of this problem is to find for a crystal (that is to say, a homogeneous assemblage of groups of chemical atoms) a homogeneous arrangement of partitional interfaces such that each cell contains all the atoms of one molecule. Unless we knew the exact geometrical configuration of the constituent parts of the group of atoms in the crystal, or crystalline molecule as we shall call it, we could not describe the partitional interfaces between one molecule and its neighbour.

Knowing as we do know for many crystals the exact geometrical character of the Bravais assemblage of corresponding points of its molecules, we could not be sure that any solution of the partitional problem we might choose to take would give a cell containing only the constituent parts of one molecule. For instance, in the case of quartz, of which the crystalline molecule is probably  $3(\text{SiO}_2)$ , a form of cell chosen at random might be such that it would enclose the silicon of one molecule with only some part of the oxygen belonging to it, and some of the oxygen belonging to a neighbouring molecule, leaving out some of its own oxygen, which would be enclosed in the cell of either that neighbour or of another neighbour or other neighbours.

§2. This will be better understood if we consider another illustration—a homogeneous assemblage of equal and similar trees planted close together in any regular geometrical order on a plane field either inclined or horizontal, so close together that roots of different trees interpenetrate in the ground, and branches and leaves in the air. To be perfectly homogeneous

every root, every twig, and every leaf of any one tree must have equal and similar counterparts in every other tree. So far everything is natural, except, of course, the absolute homogeneity that our problem assumes; but now, to make a homogeneous assemblage of molecules in space, we must suppose plane above plane each homogeneously planted with trees at equal successive intervals of height. The interval between two planes may be so large as to allow a clear space above the highest plane of leaves of one plantation and below the lowest plane of the ends of roots in the plantation above. We shall not, however, limit ourselves to this case, and we shall suppose generally that leaves of one plantation intermingle with roots of the plantation above, always, however, subject to the condition of perfect homogeneity. Here, then, we have a truly wonderful problem of geometry—to enclose ideally each tree within a closed surface containing every twig, leaf, and rootlet belonging to it, and nothing belonging to any other tree, and to shape this surface so that it will coincide all round with portions of similar surfaces around neighbouring trees. Wonderful as it is, this is a perfectly easy problem if the trees are given, and if they fulfil the condition of being perfectly homogeneous.

In fact we may begin with the actual bounding surface of leaves, bark, and roots of each tree. Wherever there is a contact, whether with leaves, bark, or roots of neighbouring trees, the areas of contact form part of the required cell-surface. To complete the cell-surface we have only to swell out<sup>1</sup> from the untouched portions of surface of each tree homogeneously until the swelling portions of surface meet in the interstitial air spaces (for simplicity we are supposing the earth removed, and roots, as well as leaves and twigs, to be perfectly rigid). The wonderful cell-surface which we thus find is essentially a case of the tetrakaidekahedron cell, which I shall now describe for any possible homogeneous assemblage of points or molecules.

§3. We shall find that the form of cell essentially consists of fourteen walls, plane or not plane, generally not plane, of which eight are hexagonal and six quadrilateral; and with thirty-six edges, generally curves, of meeting between the walls; and twenty-four corners where three walls meet. A cell answering this description must of course be called a tetrakaidekahedron, unless we prefer to call it a fourteen-walled cell. Each wall is an interface between one cell and one of fourteen neighbours. Each of the thirty-six edges is a line common to three neighbours. Each of the twenty-four corners is a point common to four neighbours. The old-known parallelepipedal partitioning is merely a very special case in which there are four neighbours along every edge, and eight neighbours having a point in common at every corner. We shall see how to pass (§4) continuously from or to this singular case, to or from a tetrakaidekahedron differing infinitesimally from it; and, still continuously, to or from any or every possible tetrakaidekahedronal partitioning.

§4. To change from a parallelepipedal to a tetrakaidekahedronal cell, for one and the same homogeneous distribution of points, proceed thus:—Choose any one of the four body-diagonals of a parallelepiped and divide the parallelepiped into six tetrahedrons by three planes each through this diagonal, and one of the three pairs of parallel edges which intersect it in its two ends. Give now any purely translational motion to each of these six tetrahedrons. We have now the  $4 \times 6$  corners of these tetrahedrons at twenty-four distinct points. These are the corners of a tetrakaidekahedron, such as that described generally in §3. The two sets of six corners, which before the movement coincided in the two ends of the chosen diagonal, are now the corners of one pair of the hexagonal faces of the tetrakaidekahedron. When we look at the other twelve corners we see them as corners of other six hexagons, and of six parallelograms, grouped together as described in §15 below. The movements of the six tetrahedrons may be such that the groups of six corners and of four corners are in fourteen planes as we shall see in §14; but if they are made at random, none of the groups will be in a single plane. The fourteen faces, plane or not plane, of the tetrakaidekahedron are obtained by drawing arbitrarily any set of surfaces to constitute four of the hexagons and three of the quadrilaterals, with arbitrary curves for the edges between hexagon and hexagon and between hexagons and quadrilaterals, and then by drawing parallel equal and similar counterparts to these surfaces in the remaining four hexagonal

<sup>1</sup> The scheme is now carried on by funds supplied by the County Councils of Cambridgeshire, the Isle of Ely, Essex, Norfolk, Northants, Leicestershire, Hunts, East and West Suffolk, and by a grant from the Board of Agriculture.

<sup>2</sup> A paper read before the Royal Society on January 18, by Lord Kelvin, P.R.S.

<sup>3</sup> *Journal de l'École Polytechnique*, tome xix. cahier 33, pp. 1-128 (Paris, 1850), quoted and used in my "Mathematical and Physical Papers," vol. iii. art. 97, p. 400.

<sup>1</sup> Compare "Mathematical and Physical Papers," vol. iii. art. 97, §5.

and three quadrilateral spaces in the manner more particularly explained in § 6 below. It is clear, or at all events I shall endeavour to make it clear by fuller explanations and illustrations below, that the figure thus constituted fulfils our definition (§ 1) of the most general form of cell fitted to the particular homogeneous assemblage of points corresponding to the parallelepiped with which we have commenced. This will be more easily understood in general, if we first consider the particular case of *parallelepipedal* partitioning, and of the deviations which, without altering its corners, we may arbitrarily make from a plane-faced parallelepiped, or which we may be compelled by the particular figure of the molecule to make.

§ 5. Consider, for example, one of the trees of § 2, or if you please a solid of less complex shape, which for brevity we shall

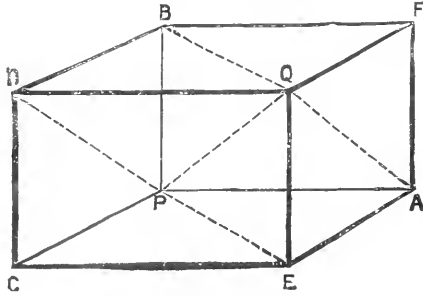

(FIG. 7, of § 9.)

call *s*, being one of a homogeneous assemblage. Let *P* be a point in unoccupied space (air, we shall call it for brevity), which, for simplicity we may suppose to be somewhere in the immediate neighbourhood of *s*, although it might really be anywhere far off among distant solids of the assemblage. Let *PA*, *PB*, *PC* be lines parallel to any three Bravais rows not in one plane, and let *A*, *B*, *C* be the nearest points corresponding to *P* in these lines. Complete a parallelepiped on the lines *PA*, *PB*, *PC*, and let *QD*, *QE*, *QF* be the edges parallel to them through the opposite corner *Q*. Because of the homogeneousness of the assemblage, and because *A*, *B*, *C*, *D*, *E*, *F*, *Q* are points corresponding to *P* which is in air, each of those seven points is also in air. Draw any line through air from *P* to *A* and draw the lines of corresponding points from *B* to *F*, *D* to *Q*, and *C* to *E*. Do the same relatively to *PB*, *AF*, *EQ*, *CD*; and again the same relatively to *PC*, *AE*, *FQ*, *BD*. These twelve lines are all in air, and they are the edges of our curved-faced parallelepiped. To describe its faces take points infinitely near to one another along the line *PC* (straight or curved as may be): and take the corresponding points in *BD*. Join these pairs of corresponding points by lines in air infinitely near to one another in succession. These lines give us the face *PBDC*. Corresponding points in *AE*, *FQ*, and corresponding lines between them give us the parallel face *AFQE*. Similarly we find the other two pairs of the parallel faces of the parallelepiped. If the solids touch one another anywhere, either at points or throughout finite areas, we are to reckon the interface between them as air in respect to our present rules.

§ 6. We have thus found the most general possible parallelepipedal partitioning for any given homogeneous assemblage of solids. Precisely similar rules give the corresponding result for any possible partitioning if we first choose the twenty-four corners of the tetrakaidekahedron by finding six tetrahedrons and giving them arbitrary translatory motions according to the rule of § 4. To make this clear it is only necessary to remark that the four corners of each tetrahedron are essentially corresponding points, and that if one of them is

in air all of them are in air, whatever translatory motion we give to the tetrahedron.

§ 7. The transition from the parallelepiped to the tetrakaidekahedron described in § 4 will be now readily understood if we pause to consider the vastly simpler two-dimensional case of transition from a parallelogram to a hexagon. This is illustrated in Figs. 1 and 2; with heavy lines in each case for the sides of the hexagon, and light lines for the six of its diagonals which are sides of constructional triangles. The four diagrams show different relative positions in one plane of two equal homochirally similar triangles *ABC*, *A'B'C'*; oppositely oriented (that is to say, with corresponding lines *AB*, *A'B'* parallel but in inverted directions). The hexagon *AC'BA'CB'*, obtained by joining *A* with *B'* and *C'*, *B* with *C'* and *A'*, and *C* with *A'* and *B'*, is clearly in each case a proper cell-figure for dividing plane space homogeneously according to the Bravais distribution of points defined by either triangle, or by putting the triangles together in any one of the three proper ways to make a parallelogram of them. The corresponding operation for three-dimensional space is described in § 4: and the proof which is obvious in two-dimensional space is clearly valid for space of three dimensions, and therefore the many words which would be required to give it formal demonstration are superfluous.

§ 8. The principle according to which we take arbitrary curved surfaces with arbitrary curved edges of intersection, for seven of the faces of our partitioned tetrakaidekahedron, and the other seven correspondingly parallel to them, is illustrated in Figs. 3, 4, 5, and 6, where the corresponding thing is done for a partitioned hexagon suited to the homogeneous division of a plane. In these diagrams the hexagon is for simplicity taken equilateral and equiangular. In drawing Fig. 3, three pieces of paper were cut, to the shapes *kl*, *mn*, *uv*. The piece *kl* was first placed in the position shown relatively to *AC'*, and a portion of the area of one cell to be given to a neighbour across the frontier *C'A* on one side was marked off. It was then placed

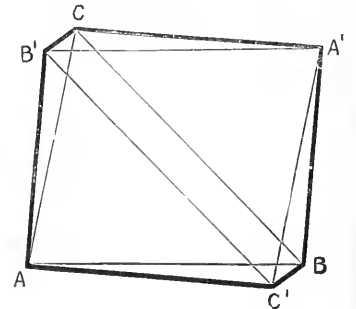
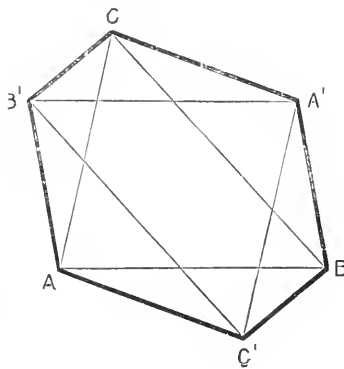

FIG. 1.

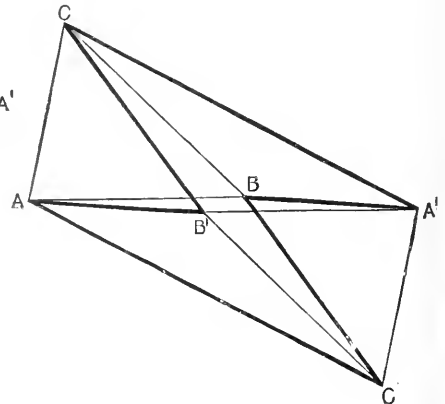
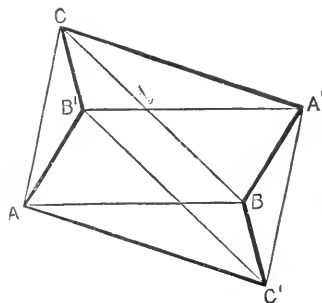

FIG. 2.

in the position shown relatively to *A'C* and the equivalent portion to be taken from a neighbour on the other side was marked. Corresponding give-and-take delimitations were

marked on the frontiers C'B and B'C, according to the form *mn*; and on the frontiers BA', AB', according to the form *uv*. Fig. 4 was drawn on the same plan but with one pair of frontiers left as straight lines, and the two other pairs drawn by aid of two paper templets.

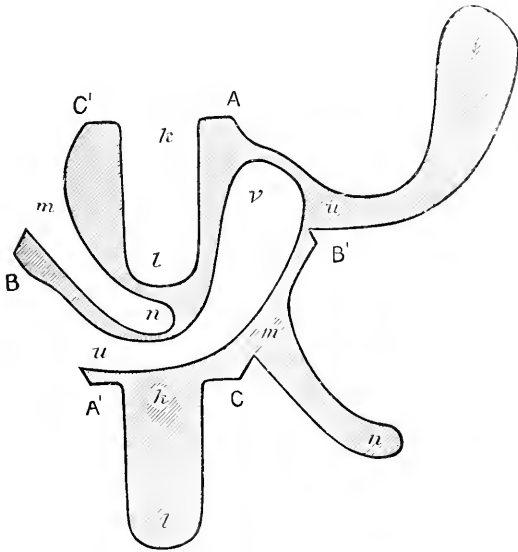

FIG. 3.

easy, but not worth the trouble, to cut out a large number of pieces of brass of the shapes shown in these diagrams and to show them fitted together like the pieces of a dissected map. Figs. 5 and 6 are drawn on the same principle; Fig. 6 showing,

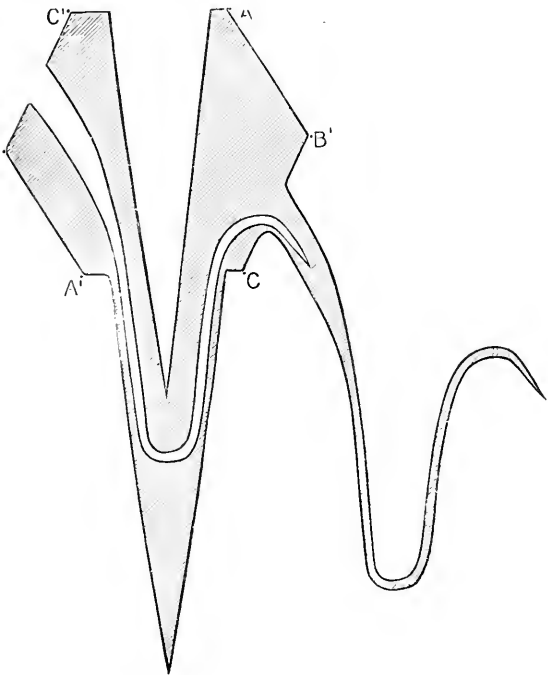

FIG. 4.

on a reduced scale, the result of putting pieces together precisely equal and similar to that shown in Fig. 5. In these diagrams, unlike the cases represented in Figs. 3 and 4, the primitive hexagon is, as shown clearly in Fig. 5, divided into isolated parts. But if we are dealing with homogeneous division

of solid space, the separating channels shown in Fig. 5 might be sections, by the plane of the drawing, of perforations through

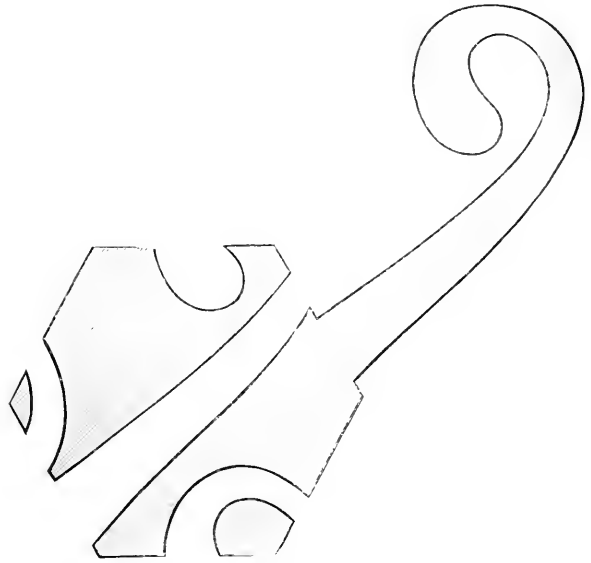

FIG. 5.

the matter of one cell produced by the penetration of matter, rootlets for example, from neighbouring cells.

§ 9. Corresponding to the three ways by which two triangles can be put together to make a parallelogram, there are seven,

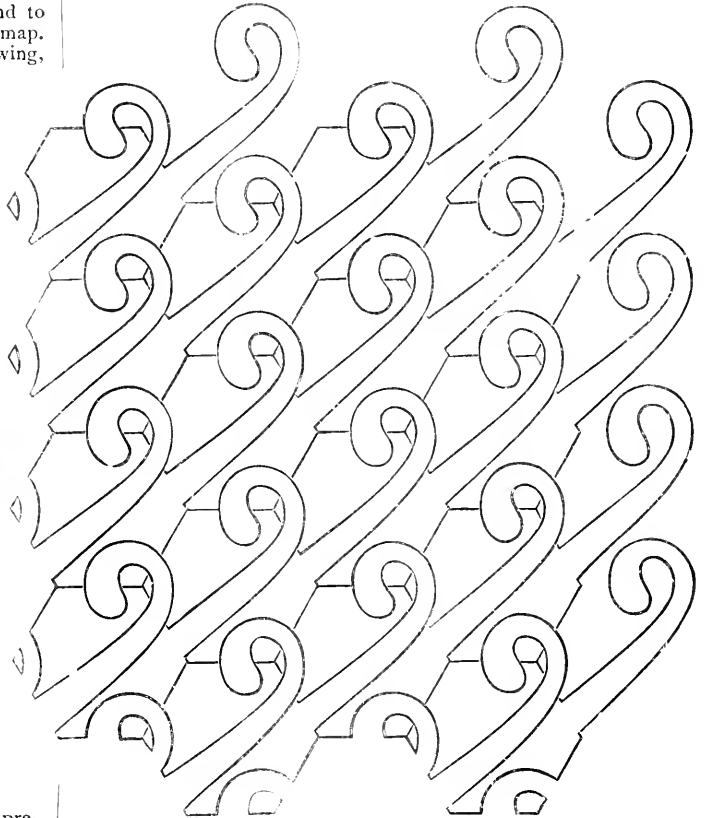

FIG. 6.

and only seven, ways in which the six tetrahedrons of § 4 can be put together to make a parallelepiped, in positions parallel to

those which they had in the original parallelepiped. To see this, remark first that among the thirty-six edges of the six tetrahedrons seven different lengths are found which are respectively equal to the three lengths of edges (three quartets of equal parallels); the three lengths of face-diagonals having ends in P or Q (three pairs of equal parallels); and the length of the chosen body-diagonal PQ. (Any one of these seven is, of course, determinable from the other six if given.)

In the diagram, Fig. 7, full lines show the edges of the primitive parallelepiped, and dotted lines show the body-diagonal PQ and two pairs of the face-diagonals, the other pair of face-diagonals (PF, QC), not being marked on the diagram to avoid confusion. Thus, the diagram shows, in the parallelograms QDPA and QEPE, two of the three cutting planes by which it is divided into six tetrahedrons, and it so shows also two of the six tetrahedrons, QDDB and QPEA. The lengths QP, QD, QE, QF are found in the edges of every one of the six tetrahedrons, the two other edges of each being of two of the three lengths QA, QB,

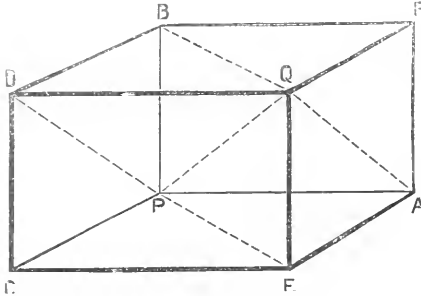

Fig. 7.

QC. The six tetrahedrons may be taken in order of three pairs having edges of lengths respectively equal to QB and QC, QC and QA, QA and QB. It is the third of these pairs that is shown in Fig. 7. Remark now that the sum of the six angles of the six tetrahedrons at the edge equal to any one of the lengths QP, QD, QE, QF is four right angles. Remark also that the sum of the four angles at the edge of length QA in the two pairs of tetrahedrons in which the length QA is found is four right angles, and the same with reference to QB and QC. Remark lastly that the two tetrahedrons of each pair are equal and dichirally<sup>1</sup> similar, or enantiomorphs as such figures have been called by German writers.

(To be continued.)

### UNIVERSITY AND EDUCATIONAL INTELLIGENCE.

CAMBRIDGE.—The following is the speech delivered by the Public Orator (Dr. Sandys) on March 1, in presenting for the degree of LL.D. *honoris causa* the Right Hon. the Earl of Kintore, G.C.M.G., M.A. Trinity, Governor of South Australia:—"Quam libenter salutamus ex alumnis nostris unum, qui Britanniae in parte Septentrionali Collegii florentissimi Aberdoniensis a conditore oriundus, inter colonias nostras Australes Academiam Adelaidensem, quam inter filias nostras non sine superbia numeramus, sua sub tutela positam esse gloriatur. Ibi provinciae maximae tota Gallia, tota Germania, plusquam quadruplo latius patenti praepositus, regionem tam immensam audacter peragravit, itineris tanti socium insignem nactus medicum Cantabrigiensem, cuius ipsum nomen Caledoniae suae castellum in memoriam revocat. Quid commemorem proconsulis nostri ductu plusquam quadraginta dies inter loca deserta atque arida fortiter toleratos, rerumque naturae solitudines reconditas feliciter reclusas? Quid (ne maiora dicam) etiam talpae genus novum, quod *notoryctes* nominatur, e latebris suis in lucem protractum? Quid eiusdem auspicio et imperio etiam beluae antiquae, quae *diprotodon* vocatur, relictas ingentes saeculo nostro denuo patefactas? Ipsum Sancti Georgii inter equites illustriores numeratum, non draconem fabulosum vi et armis domuisse dixerim, sed monstrorum haud minus horrendorum vestigia immania sumpto et labore maximo detegenda curavisse. Talium virorum auxilio non modo imperii Britannici provinciae remotissimae vinculis

<sup>1</sup> A pair of gloves are dichirally similar, or enantiomorphs. Equal and similar right-handed gloves are chirally similar.

artioribus nobiscum consociantur, sed etiam scientiarum fines nostris a filiis totiens propagati per spatia indies latiora extenduntur. Duco ad vos scientiarum patronum illustrem, provinciae maximae et proconsulem et investigatorem indefessum, virum et suo et fratris sui nomine nobis coniunctissimum, Algernon Keith-Falconer, Comitem de Kintore." Lord Kintore was accompanied on his adventurous journey of 2000 miles from Port Darwin to Adelaide by Dr. Edward Charles Stirling, Trinity Lecturer on Physiology in the University of Adelaide.

The following is the speech delivered by Dr. Sandys, on March 6, in presenting for the degree of Sc.D. Dr. S. Ramon y Cajal, Professor of Histology and Pathological Anatomy in the University of Madrid:—"Hodie laudis genus novum libenter auspicati, Hispanae gentis civem nunc primum salutamus. Salutamus virum de physiologiae scientia optime meritum, qui inter flumen Hiberum montesque Pyrenaeos duo et quadraginta abhinc annos natus et fluminis eiusdem in ripa Caesaraugustae educatus, primum ibidem, deinde Valentiae, deinceps Barcelonae munere Academico functus, tot honorum spatio feliciter decurso, nunc denique in urbe, quod gentis totius caput est, histologiae scientiam praeclare proficitur. Fere decem abhinc annos professoris munus Valentiae auspicatus, fore auguratus est, ut intra annos decem studiorum suorum in honorem etiam inter exteras gentes nomen suum notesceret. Non fellit augurium; etenim nuper etiam nostras ad oras a Societate Regia Londinensi honoris causa vocatus, muneris oratorio, virorum insignium nominibus iam pridem ornato, in hunc annum destinatus est. Omitto opera eius maiora de histologia et de anatomia conscripta; praeterea etiam opuscula eiusdem quadraginta intra lustra duo in lucem missa; haec enim omnia ad ipsa scientiae penetralia pertinent. Quid vero dicam de artificio pulcherrimo quo primum auri, deinde argenti ope, in corpore humano fila quaedam tenuissima sensibus motibusque ministrantia per ambages suas inextricabiles aliquatenus explorari poterant? In artificio illo argenti usum, inter Italos olim inventum, inter Hispanos ab hoc viro in melius mutatum et ad exitum feliciorum perductum esse constat. Si poeta quidam Romanus regione in eadem genitus, si Valerius Martialis, inquam, qui expertus didicit fere nihil in vita sine argento possi perfici, hodie ipse adesset, procul dubio popularem suum verbis suis paululum mutatis non sine superbia appellaret:—

<sup>4</sup> Vir Celtiberis non tacende gentibus,  
Nostraeque laus Hispaniae, ...  
Te nostri Hiberi ripa gloriabitur,  
Nec me tacebit Bilbilis.

Martial, l. 49, 1-2; 61, 11-12.

Duco ad vos virum et in Hispania et inter exteras gentes laudem merito adeptum, histologiae professorem insignem, Santiago Ramon y Cajal."

Dr. J. B. Bradbury, Physician to Addenbrooke's Hospital and Linacre Lecturer at St. John's College, has been elected to the Downing Professorship of Medicine, vacant by the resignation of Dr. Latham.

Mr. P. H. Cowell, Senior Wrangler in 1892, has been elected to the Isaac Newton Studentship in Physical Astronomy and Optics.

The Arnold Gerstenberg Studentship, worth about £90 a year, will be awarded next May, on the results of an examination in Psychology and Logic, commencing on May 21. Candidates must have obtained honours in one part of the Natural Sciences Tripos, and have commenced residence earlier than April 1888. The student elected must devote himself to moral or mental philosophy.

THE Queen has signified her approval of the appointment of the following Commissioners to consider what are the best methods of establishing a well-organised system of secondary education in England, taking into account existing deficiencies, and having regard to such local sources of revenue from endowment or otherwise as are available or may be made available for this purpose, and to make recommendations accordingly:—The Right Hon. J. Bryce, M.P.; the Right Hon. Sir J. T. Hibbert, M.P.; Mr. Henry Hobhouse, M.P.; Mr. H. Llewellyn Smith; Prof. R. C. Jebb, M.P.; Mrs. Henry Sidgwick; Mr. M. E. Sadler; the Rev. A. M. Fairbairn; the Hon. E. Lytton; Mrs. Bryant, D.Sc.; Dr. R. Wormell; the Very Rev. E. C. Maclure; Mr. George J. Cockburn; Mr. J. H. Yoxall; Sir Henry Roscoe, M.P., F.R.S.; Lady Frederick Cavendish; Mr. C. Fenwick, M.P.

A NEW departure in University Extension classes has been made at the Croydon centre, where a course of lectures on the "Geology and Scenery of the Alps" is being delivered by Miss M. M. Ogilvie, D.Sc. The course consists of ten lectures, six referring to general subjects bearing on the main question. Four lectures are devoted to special districts: the Western Alps, the Eastern Alps, the Bavarian Alps and North Tyrol, and the "Dolomites" of South Tyrol. The distribution of the population, political boundaries, trade routes, and many similar subjects controlled by the geology and physical geography are discussed. It is proposed to follow this course with an excursion to the Alps, during which various points discussed in the lectures will be studied on the ground.

MR. G. H. MORLEY informs us that the report that the late Mr. Thomas Avery, of Birmingham, bequeathed the sum of £2,000 to the Midland Institute, is incorrect. He left £2,000 to the Mason College, Birmingham, and only £1,000 to the Institute with which Mr. Morley is connected.

MR. F. W. DYSON has been appointed Prof. H. H. Turner's successor at the Royal Observatory, Greenwich. Mr. Dyson is a Fellow of Trinity College, and has held the Isaac Newton Studentship for the last two years.

WE learn from the Allahabad *Pioneer* that the Senate of the Madras University have reported unfavourably on the reference made to it by the Government regarding the proposal to establish degrees in science and agriculture.

### SCIENTIFIC SERIALS.

*Wiedemann's Annalen der Physik und Chemie*, No. 2.—On cathode rays in gases at atmospheric pressure and in extreme vacua, by Philipp Lenard. This paper gives a detailed account of the behaviour of cathode rays when allowed to penetrate through a metallic screen in the walls of the vacuum tube into the air or other gas outside. It is shown that their behaviour is of a distinctive character, and largely independent of the electric forces producing them. Photographic plates were successfully employed in studying the distribution and divergence of the rays in air and other gases.—Concerning the theory of magnetic and electric phenomena, by Hermann Ebert. This is an attempt to show that by a consistent application of the cyclical theory of electric and magnetic phenomena, as illustrated by Fitzgerald's ether model, a complete and simplified explanation of these phenomena may be obtained.—On the laws of galvanic polarisation and electrolysis, by O. Wiedeberg. This is a detailed investigation of polarisation phenomena from the point of view of a theory which assumes that only a fractional portion of the ions clustering round the electrodes give rise to an opposing electromotive force. The author shows that this assumption leads to a complete and consistent representation of observed facts.—Some forms of immersed electrodes for measurements of electrolytic resistance, by F. Kohlrusch. The electrodes, which consist of small platinum plates about 1 sq. cm. in area, are soldered to platinum wires which are mounted in a double capillary tube. They are also surrounded by a glass vessel with a hole at the bottom for letting in the liquid. In measuring resistances they need only be immersed, no further adjustments or precautions being necessary.—Some experiments concerning the so-called waterfall electricity, by K. Wesendonck. The author quotes a large number of experiments elucidating the generation of electricity by the impact of water-spray, vapour, and air upon water and metallic conductors. Vapour impinging upon a water surface charges the latter positively, this being analogous to waterfall electricity, and independent of friction.—A new actinometer, by O. Chwolson. This consists of two thermometers placed close together, and is based upon the method of observing the changes in the difference of temperatures of the two instruments, the warmer being in the shade, and the colder being exposed to the rays of the sun.

*American Journal of Mathematics*, vol. xvi. No. 1 (Baltimore, January).—Zur Kettenbruchentwicklung hyperelliptischer und ähnlicher Integrale, by E. B. van Vleck (pp. 1-91), is illustrated by numerous diagrams, but we miss the usual u-*ef* index of contents accompanying long papers in this *Journal*.—Waves and jets in a viscous liquid, by Mr. A. B. Basset, F.R.S. (pp. 93-110), in continuation of an article by Prof. Greenhill, in the ninth volume, in which he discusses wave-motion in a frictionless liquid, here considers certain problems of like character when the viscosity of the liquid is

taken into account.—Sur l'inversion des intégrales de fonction à multiplicateurs, by M. E. Picard (pp. 111-122), discusses in greater detail some points touched upon in chapter vi. of his memoir sur les fonctions algébriques de deux variables indépendantes (*Journal des Mathématiques*, 1889). On orthogonal substitutions that can be expressed as a function of a single alternate (or skew symmetric) Linear substitution, by H. Taber (pp. 123-130). This is a continuation of the author's previous work in the form of a proof of a theorem for certain orthogonal matrices discussed in a paper read by the writer at the Mathematical Congress in Chicago last year. The selected portrait is an excellent one (we feel sure) of Sophus Lie.

*Simons's Monthly Meteorological Magazine*, February, contains an article entitled "The January Frost." The author has tabulated all the lowest temperatures that he has been able to collect between the 5th and 8th of that month, and arranged them according to counties. The following are the minimum readings: Essex - 2°, Berwick - 3°, Aberdeen, Nottingham, and Warwick - 4°, York - 5°, Northumberland, Roxburgh, and Stirling - 6°, Fife and Perth - 8°, Forfar - 11°. In Ireland the temperature was higher, but still remarkable; between Cork and Tyrone several records were below 10°. A comparison with the great cold of January 1881 shows that that year was much more severe; the general mean for a number of representative stations was 3°·9, while this year it was 4°·7.

### SOCIETIES AND ACADEMIES.

LONDON.

Royal Society, February 8.—"Further Observations on the Organisation of the Fossil Plants of the Coal-Measures. Part I. *Calamites*, *Calamostachys*, and *Sphenophyllum*" By W. C. Williamson, LL.D. F.R.S., and D. H. Scott, M.A., Ph.D., F.L.S., F.G.S.

(1) *Calamites*.—The first part of the paper gives a detailed account of the vegetative structure of *Calamites*. It is proved that the primary structure of the young stem, before growth in thickness had begun, agreed in all essential points with that of an *Equisetum*, and thus the anatomical characters are found to completely confirm the supposed equisetaceous affinities of the genus. The true nature of the canals which accompany the vascular bundles in the internodes of *Calamites* is demonstrated, and their complete homology with the carinal canals of *Equisetum* established. In both cases the canal contains the disorganised protylem of the vascular bundle.

The development of the secondary tissues, which were always formed in *Calamites*, is traced in detail, and their origin from a normal cambium proved.

The formation of periderm in the cortex has also been clearly observed.

The position of the branches and their exact mode of connection with the tissues of the main stem is fully investigated. It is shown that many of the branches were abortive, and became enclosed in the wood.

The roots of *Calamites*, as M. Renault has proved, were identical with *Astromylon*.

(2) *Calamostachys*.—The anatomy of the axis of the strobilus has been fully investigated, and found to agree in the main features, though not in details, with that of *Calamites* or *Equisetum*.

In general anatomical and morphological characters the homosporous species, *C. Binneyana*, and the heterosporous *C. Casheana* show the closest agreement, and only present minute differences. In *C. Binneyana*, developing spores, still grouped in tetrads, are frequently found. One or more members of each tetrad were usually abortive. The abortion of these spores must have allowed of an increased nutrition of the survivors, and thus have been of considerable physiological importance. In *C. Casheana* the micro- and macro-sporangia were borne on the same strobilus. The diameter of the macrospores is three times that of the microspores. The macrospores are constantly accompanied by abortive spores. This abortion of certain spores, involving the better nutrition of their sister-cells, appears to throw considerable light on the origin of heterospory within this genus.

This axis of the strobilus of *C. Casheana* has a well-marked zone of secondary wood, thus affording direct evidence of the occurrence of secondary growth in a heterosporous cryptogam.

The affinities of *Calamostachys* are fully discussed. The fructification is evidently Calamarian, and the relation to *Calamites* itself is a close one.

(3) *Sphenophyllum*.—As is well known, the slender jointed stem bore verticils of superposed leaves, the number of which, in each whorl was some multiple of 3. In *S. plurifoliatum*, the species first described, the leaves probably numbered 18 in a whorl. The primary wood was triarch and centripetal, and so far resembled that of certain Lycopodiaceæ, with which, however, the genus has otherwise little in common. Abundant secondary tissues were formed. The cambium can be clearly demonstrated, and occupies the normal position between wood and bast. Sieve tubes have been detected in the phloem of *S. insignis*. Internal periderm was formed, giving rise to a regular scale-bark.

The fructification of *Sphenophyllum*, as has been shown by M. Zeiller, is that previously described under the name of *Bowmanites Dawsoni*. The axis of the strobilus bore numerous whorls of partially coherent bracts. The very long sporangiophores, each bearing a single recurved sporangium, arise from the upper surface of the whorl, two sporangiophores corresponding to each bract. The whole structure is quite unlike that of any other vascular cryptogam. The plant, so far as observed, was homosporous, and the alleged heterospory of another species is very doubtful. The genus is entirely isolated, and, though the structure is now completely known, its affinities cannot be determined until additional forms have been discovered.

March 1.—“Researches on the Structure, Organisation, and Classification of the Fossil Reptilia. Part IX. Section 1. On the Therosuchia.” By H. G. Seeley, F.R.S.

This paper discusses the classification of reputed Permian and Triassic Reptilia which have been referred to the Anomodontia as Theriodonts.

Prof. Cope's definition of the Theriodontia as distinguished from the Anomodontia by characters of the post-orbital arch is regarded as unsupported by evidence. The author would limit the Theriodontia to animals which conform to Sir R. Owen's original definition based on the dentition (1876), and have temporal vacuities and a small quadrate bone.

It appears that there is a series of groups of South African Reptilia which agree in having a palate which has some resemblances to mammals but approximates to *Sphenodon*, lizards, and crocodiles. All these sub-orders are combined as the Therosuchia. In this order or group may be included the Deuterosauria from the Permian rocks of Russia.

The relation of the Therosuchia to other Anomodontia is shown in the following grouping:—

THEROSUCHIA.—Pareiasauria, Procolophonina, Gorgonopsia, Dinocephalia, Deuterosauria, Theriodontia (*Lycosauria*, *Cynodontia*, *Gomphodontia*), Endothiodontia [*Theromora*]. THEROCHELONIA.—Dicyodontia, Kistecephalia. MESOSAURIA.

“Researches on the Structure, Organisation, and Classification of the Fossil Reptilia. Part IX. Section 2. On the Reputed Mammals from the Karroo Formation of Cape Colony.” By H. G. Seeley, F.R.S.

The author re-examines the remains of *Theriodon*, and contests the interpretation of the carpus given by Prof. Bardeleben, producing specimens of South African reptiles in which there is a single bone beneath the radius, as in *Theriodon*.

“Researches on the Structure, Organisation, and Classification of the Fossil Reptilia. Part IX. Section 3. On *Diademodon*.” By H. G. Seeley, F.R.S.

The author describes fragments of jaws and teeth from Upper Karroo strata at Wonderboom and Aliwal North, collected by Messrs. R. D. Kannemeyer and Alfred Brown. They may possibly belong to more than one genus; but, in absence of sufficient knowledge of the skull to establish differences, the four species are referred to a new genus, *Diademodon*.

The teeth are highly specialised, but distinct in plan from *Tritylodon*, and from all known reptiles. They closely approximate to some of the higher mammalia. The author refers *Diademodon* to a division of the Theriodontia in which the teeth become worn with use, which is named Gomphodontia.

Physical Society, February 23.—Prof. A. W. Rücker, F.R.S., President, in the chair.—A note on a new electrical theorem was read by Mr. T. H. Blakesley. Two or more dispositions of electromotive forces in any network of conductors which produce at every part of the network the same currents, are defined as *equivalent systems*. The following theorem is then stated and proved: In any system of conductors possessing seats of electromotive force at any number of points, if any of these sources be moved along the various bars of the conducting system, and where a point of junction is encountered, each

becoming a seat of the *same* electromotive force in *each* of the newly encountered bars, then the disposition at any moment is equivalent to that at any other moment, and therefore to the original disposition. Equivalent systems might also be defined as being such as produce equal expenditure of power in each part. From the above theorem the following propositions are deduced by the author: (1) That if any closed surface contains a portion of a network, then an electromotive force in any bar cutting the surface can be replaced by equal electromotive forces (in opposite directions as regards the surface) in all the other bars cutting the surface, without disturbing the current in any part of the network. (2) If two systems of electromotive forces be equivalent, one may be derived from the other.—Prof. C. V. Boys, F.R.S., read a note on the attachment of quartz fibres. When torsion fibres are required to carry large weights approaching the breaking weight, the ordinary method of attachment by shellac is not always satisfactory, for if the part of the fibre in the cement is twisted or bent, the yielding of the shellac causes uncertainty of zero. To avoid these troubles, Prof. Boys has devised and perfected a method of soldering the fibres, full details of which are given in the paper. After selecting a fibre of the right diameter and length, small weights are fixed on the ends by shellac. The end parts are then cleaned by dipping in strong nitric acid, washed, silvered, and electro-coppered. The weights are then cut off, and the coppered ends soldered to tags of tinned metal foil, chloride of zinc being used as a flux, and its capillarity serving to hold the ends to the tags whilst the latter are heated. The superfluous copper and silver are dissolved off by nitric acid, the tags and solder being protected by beeswax. After washing in boiling water the fibre is ready for use. Melted shellac is used for securing the tags to the torsion rod and suspended body. Several ingenious details of procedure to avoid capillary difficulties in the cleaning, plating, and washing processes are described in the paper. If fibres are required to conduct electricity, they are silvered and washed after the tags have been soldered on. Such fibres the author considers essential for making connection with electrometer needles of the greatest delicacy, for liquid connections are fatal to stability. Methods of rendering fibres visible by smoking with arsenic or magnesium are mentioned in the paper. At the meeting a perfectly circular hole,  $\frac{1}{1000}$  of an inch in diameter, made by soldering round a quartz fibre passing through a hole in a metal plate, and then drawing out the fibre, was exhibited under a microscope. Mr. Inwards asked if the shellac used to secure the tags was melted or dissolved. Mr. Blakesley inquired if silvering fibres did not destroy their perfect elasticity. Dr. Sumpner wished to know if any data as to the relative torsional rigidity of silvered and unsilvered fibres had been obtained, and if the electric resistance of silvered fibres had been determined. Mr. Watson said silvered fibres had been successfully used in electrometers. As regards their torsion, he had found it differ from day to day, and the resistance varied enormously. In reply to question, Prof. Boys described the exact process of soldering the coppered fibre to the tags. As to the torsion of silvered fibres, he would not expect much increase, as the film was very thin. He also thought the elasticity would not be destroyed, for silver and gold make very good torsion wires.—Mr. Littlewood read a note on a method of determining refractive indices, particularly well adapted for either homogeneous or heterogeneous liquids. A vertical scale stands in the liquid contained in a vessel open at the top, and two marks on the part of the scale below the liquid are observed in succession through an inclined telescope capable of moving horizontally parallel to itself along a graduated bar. The horizontal distance between the two positions of the telescope in which the two divisions on the vertical scale are sighted is noticed, and the corresponding distance between the sighted position of two marks on the part of the scale above the liquid determined. When the length between the two marks on the scale in air is equal to that between those in the liquid, the ratio of the corresponding horizontal distances moved through by the telescope gives the index of refraction of a uniform liquid. For liquids in which the density varies in a vertical direction, observations of several points on the scale in the liquid enable the curved path of the light in the liquid to be traced out with considerable accuracy. The accuracy of the laws of diffusion might be tested in this way. The President said the method described was a novel and interesting way of picking out the layers of liquid of different refracting power.

Chemical Society, February 15.—Dr. Armstrong, President, in the chair.—The following papers were read:—The

analytical determination of probably available "mineral" plant food in soils, by B. Dyer. The author has made a series of determinations of the average acidity of the root sap of about 100 plants in order to measure the power of dissolving the mineral constituents of soils possessed by plants. These experiments seemed to indicate the suitability of a 1 per cent. solution of citric acid as an analytical soil solvent; the effect of this solution on a number of the Rothamsted soils was therefore tried. The conclusion is drawn that valuable indications of comparative ("mineral") soil fertility are obtained by the use of such a solution. After the reading of the paper, Sir Henry Gilbert gave a short sketch of the development of soil analysis.—The behaviour of the more stable oxides at high temperatures. Part ii., by A. A. Read. At  $1750^{\circ}$ ,  $Sb_2O_3$  is converted into  $Sb_2O_5$ ,  $V_2O_5$  into  $V_2O_6$ , and  $Fe_2O_3$  into  $Fe_3O_4$ , whilst the oxides of cobalt and nickel are reduced to the metallic state.—The stability of the oxides considered in relation to the periodic law, by G. H. Bailey. In the even series of the periodic classification, the oxides are more stable the higher the atomic weight of the element concerned, the temperature of decomposition being taken as an index of stability; in the odd series the oxides become less stable as the atomic weight increases.—The interaction of benzil and benzylamine in presence of zinc chloride: a preliminary note, by F. R. Japp and W. B. Davidson. On heating benzil, benzylamine, and zinc chloride together at  $100^{\circ}$ , tetraphenylazine, benzyllophine, and dibenzyllophonium chloride are obtained.

**Geological Society, February 16.**—W. H. Hudleston, F.R.S., President, in the chair.—The Wollaston medal was awarded to Geheimrath Dr. Karl Alfred von Zittel, professor of geology and palæontology in the University of Munich, in recognition of the important services which he has rendered to palæontological science during a long period of time.—Mr. Aubrey Strahan was awarded the balance of the proceeds of the Wollaston Donation Fund, in token of appreciation of his geological work in several parts of England and on the Welsh border.—Mr. William Talbot Aveline received the Murchison medal, together with a sum of ten guineas, in recognition of the importance of his work as a geological surveyor.—The balance of the proceeds of the Murchison Geological Fund was handed to Mr. George Barrow, as a testimony of the value of his geological work both in Yorkshire and in Scotland.—The Lyell medal, with the sum of £46, was awarded to Prof. John Milne, F.R.S., of the Imperial College of Engineering, Tokio, Japan, in testimony of appreciation of his investigations in seismology.—The balance of the proceeds of the Lyell Geological Fund was presented to Mr. William Hill, in testimony of the value of his work amongst the Cretaceous rocks of this country during the last eight years.—A sum of £25 from the proceeds of the Barlow-Jameson Fund was given to Mr. Charles Davison, in token of appreciation of his work in geological dynamics, including under that term the study of earthquakes.—The President then read his anniversary address, which may be summarised as follows:—In continuation of the subject of the preceding anniversary address, relating to some recent work of the Geological Society, the remaining portion of the papers contributed within the septennial limits is classified under two groups. In the first group are placed papers descriptive of the newer palæozoic rocks, the older palæozoic rocks, and the fundamental rocks, and on general petrology, which relate more especially to the geology of the British Isles. This group is considered in detail, and constitutes the bulk of the address. In the second group are placed numerous papers which may roughly be classified under the following headings:—Miscellaneous geology, foreign and colonial—a somewhat exhaustive division, comprising about a score of papers, dealing with many subjects in different parts of the world. African geology, especially, comes to the front in this group. Miscellaneous invertebrate palæontology—a score of papers may be thus classified. Most of these matters are for the consideration of specialists, relating to corals, crinoidæ, bryozoa, ostracoda, cephalopoda, and to siliceous organisms. In palæobotany there has only been one paper of any importance; whilst under the heading dynamical problems are a few papers dealing with the movement of material. A notice of the Inverness earthquake, and a communication on the origin of the basins of the great lakes of America, complete this category. The detailed consideration of the first group commences with the newer palæozoic rocks. The carboniferous system has not yielded any important stratigraphical papers of late years, but there have been some interesting communications respecting the coal measures.

Questions as to the origin and faunal character of these are discussed by more than one writer, and very important deductions, as to the delimitation of the marine and freshwater beds, have been drawn. The subject of coal in the south-east of England was considered, *à propos* of a paper read at the Society some years ago, and the prospects of coal-getting at Dover and elsewhere in this part of England discussed. In Devonian geology, the structure and peculiarities of the South Devon limestones form the subject of an interesting communication; and there are also important stratigraphical papers in this connection, more especially one written subsequent to the visit of a party from the International Geological Congress of London. In the older palæozoic rocks a considerable amount of work has been done, more especially amongst the Silurian and Ordovician of the north-west of England, where additional evidence has been furnished of the value of graptolite-zones as a means of comparison with the older palæozoics of distant areas; and a further contribution has also been made to our knowledge of beds of this age in the Cross-Fell inlier. The papers dealing with the fossiliferous Cambrian are not numerous, but they are of great importance, including the recognition of a very low Cambrian fauna at the top of the Penrhyn quarries, and Sir J. W. Dawson's correlation of American with European Cambrians. The discovery of *Olenellus* in the "fucoid beds" of the north-west Highlands also serves to fix the Cambrian age of the Durness limestone, to which formation the altered limestone of Strath in Skye, at one time regarded as of Liassic age, is now held to belong. The physical relations and the post-Cambrian metamorphism of the rocks of the north-west Highlands are also considered under this heading. The fundamental rocks are roughly divided into three categories, viz. the sedimentary series, the volcanics, and the crystalline schists. The first includes the Torridon sandstone, the Longmynd rocks, the unfossiliferous Cambrians of Wales, &c. The volcanic series has already formed part of the subject of an address from the chair. Oddly enough, the best defined pre-Cambrian, or fundamental sedimentary series, is to be found in the north-west Highlands, a district which only a few years ago was an enigma, but which we hope may now supply a clue to regions more obscure. This, of course, is the Torridon sandstone, which has a well-defined base and a well-defined summit. Then there are certain rocks which some regard as Cambrian, others as pre-Cambrian, such as the Howth Hill and Bray Head beds, claimed as Upper Monian. Crossing St. George's Channel, we find ourselves in Anglesey, a land of pre-Cambrian mysteries. The older rocks have been described as belonging to the Monian system, an arrangement much controverted, and this controversy has extended to Shropshire. Lastly, there is the long-standing contention as to whether the unfossiliferous Cambrians of North Wales really belong to that system or should be placed on a lower horizon. The Malvernian controversy relates, in the main, to the crystalline schists. Under the heading of General Petrology is grouped a very large series of papers, more than sixty in number, divided roughly into two primary classes, according as they relate to the British Isles or to foreign countries, the former class being alone considered in detail. The arrangement is topographical, and the rocks under this heading may be of any age from the Archæan upwards. Scotland has yielded seven papers in this group—most of them of very great interest and importance, one or two being somewhat controversial. The subject of contact-metamorphism is raised with reference to more than one Scotch locality; and from the Lake District there has been a communication on the Shap granite and associated igneous and metamorphic rock, which again brings this question into prominence. Some of the papers relating to Wales have already been dealt with in a previous address, but the subjects of the variolite and also of the nodular felstones of the Lley are noticed on the present occasion. In Devonshire the rocks formerly known as "felspathic traps" have been described as basalts and andesites; whilst the igneous origin of the Dartmoor granite has been maintained against one of those theories which from time to time crop up with respect to this well-known *massif*. Allusion is also made to the controversy with respect to the Start rocks. There have been four papers dealing with the Lizard peninsula, in which questions as to priority of the several igneous masses and as to the origin of the banded gneisses are entertained. It cannot be doubted that considerable progress has been made of late towards a recognition of the true character of these rocks, which, for the extent of territory they occupy, are perhaps without equal in point of interest throughout the British Isles. The

address concludes with a notice of the rocks of Brittany and the Channel Isles, which have attracted the attention of more than one author.

CAMBRIDGE.

Philosophical Society, February 26.—Prof. Hughes, President, in the chair.—The following communications were made:—On current-sheets, specially on ellipsoids and anchor-rings, by Mr. R. H. D. Mayall. The electric currents induced in thin uniformly conducting sheets of any shape placed in a variable magnetic field were considered; and it was shown that they could be determined by the solution of a differential equation of the second order with the aid of the appropriate boundary conditions. Orthogonal curvilinear co-ordinates were used in every case, the equation to the surface of the conductor being got by making one co-ordinate constant. In this way results were worked out for the infinite plane, the sphere, the infinite right circular cylinder, and the ellipsoid with three unequal axes. The case of the anchor-ring was also discussed, and a set of linear equations found to determine the unknown coefficients in the expression for the current function. These were solved for the particular case when the exciting disturbance was represented by a harmonic of the first degree and symmetrical about the axis of the ring; and a simple expression was found for the modulus of decay of free currents of the same type.—The complete system of quaternariants for any degree, by Mr. D. B. Mair. A method is given for finding the concomitants of a quaternary form of any degree or of simultaneous quaternary forms. The cases of a single quadratic, a single cubic, a single quartic, a system of two quadratics, and a system of three quadratics, are treated at length.—The configuration of a pair of equal and opposite hollow straight vortices, of finite cross-section, moving steadily through a fluid, by Mr. H. C. Pocklington.—On a class of definite integrals connected with Bessel's functions, by Mr. A. B. Basset.

PARIS.

Academy of Sciences, February 26.—M. Lœwy in the chair.—On the scientific work of Jean Louis Armand de Quatrefages de Bréau, by M. Edmond Perrier.—On the equation of the vibrations of a membrane, by M. H. Poincaré.—On a way of obtaining a uniform circular movement by means of two vibratory movements, by M. Marcel Deprez.—Observations of the new planet AV (Courty, 1894, February 11), made at the Paris Observatory, by MM. O. Callandreaud and G. Bigourdan.—On the application of the method of successive approximations to the ordinary differential equations of the first order, by M. Ernest Lindelöf.—Observations on the preceding communication, by M. Émile Picard.—The combustion of the ordinary ballistic explosives, by M. P. Vieille. The old black and brown powders do not show combustion by parallel surfaces, whereas the new colloidal powders give data satisfying exactly the criterion of combustion by parallel surfaces.—On the fundamental laws of heat, by M. G. Mouret. The three laws concerning, the conservation of entropy in reversible operations, the conservation of heat in conduction, and the increase of entropy in irreversible operations, appear to be fundamental laws of heat, and not derivable from a more general law.—On a means of compensating the E.M.F. of a hydro-electric pile, by M. J. Schürr.—Measurement of the difference of phase between two alternating sinusoidal currents of the same period, by M. Albert Hess.—Action of heat on the double nitrites of metals of the alkali group and metals of the platinum group: ruthenium compounds, by MM. A. Joly and E. Leidić. The formulæ  $Ru_2(NO_2)_6 \cdot 4KNO_2$  and  $Ru_2O(NO_2)_4 \cdot 8KNO_2$  are now assigned to the potassium ruthenium nitrites. At  $360^\circ-440^\circ$  in a vacuum, explosive decomposition occurs of the latter compound, with the production of nitrogen, nitrogen dioxide, potassium nitrite, and an insoluble black substance,  $3Ru_2O_5 \cdot K_2O$ . The preparation and properties of the sodium compounds,  $Ru_2(NO_2)_6 \cdot 4NaNO_2 + 4H_2O$  and  $Ru \cdot NO \cdot Cl_3 \cdot 2NaCl$  are described. The former yields the compound  $Na_2O \cdot 3Ru_4O_9$  on heating in sulphur or mercury vapours; at a red heat  $RuO_2$  is produced.—On the isomerism of the nitrobenzoic acids, by M. Échsnér de Coninck. A study of the relative solubilities of the ortho-, meta-, and para-nitrobenzoic acids in distilled water, dilute alcohol, ether, benzene, light petroleum, carbon bisulphide, and chloroform is given.—On some derivatives of the oxazine and eurlodine series, by M. Charles Lauth.—Analysis of a moulded cheese: extraction of a new ptomaine, by M. Charles Lauth. A well-crystallised base of the formula

$C_{16}H_{24}N_2O_4$  has been isolated. It is bitter, inodorous, slightly acid to phthalein, soluble in alcohol but hardly soluble in water, and gives the usual alkaloid reactions but does not yield a tannin precipitate. Its specific rotatory power  $[\alpha]_D = +11.3^\circ$  in water. It causes diarrhoea.—On some laboratory apparatus, by M. André Bidet.—On the odour of benzoic acid (remarks on inodorous substances), by M. Jacques Passy.—Anatomy of the salivary glands of the *Philantidae*, by M. Bordas.—On the internal characteristics of the grape, and their utilisation in the determination of species and the distinction of hybrids, by M. Gustave Chauveau.—Artificial reproduction of *avens*, by M. Stanislas Meunier.—The five days' hurricane, from February 8 to 12, 1894, in Bohemia. A letter from M. Ch. V. Zenger to M. A. Cornu.

BOOKS, PAMPHLETS, and SERIALS RECEIVED.

Books.—Thermodynamics of Reversible Cycles in Gases and Saturated Vapours: Dr. M. I. Pupin (K. Paul).—The Badminton Library—Big Game Shooting, 2 vols.: C. Philipps-Wolley, &c. (Longmans).—Phillip's Systematic Atlas: E. G. Ravenstein (Phillip).—Nature Pictures for Little People: M. Mawer, &c. (Sunday School Association).—Le Climat de la Belgique en 1893: A. Lancaster (Bruxelles, Hayez).—Man the Primeval Savage: W. G. Smith (Stanford).—Report on North-Western Manitoba: J. B. Tyrrell (Ottawa, Dawson).—Ergebnisse der Meteorologischen Beobachtungen Jahrg. xv. (Hamburg).—A Treatise on Elementary Hydrostatics: J. Greaves (Cambridge University Press).—Joh. Müller's Lehrbuch der Kosmischen Physik and Atlas to ditto.—Fünfte umgearbeitete und Vermehrte Auflage: Dr. C. F. W. Peters (Braunschweig, Vieweg).—Analytical Geometry for Beginners: Rev. T. G. Vyvyan, Part 1 (Bell).—Introduction to Elementary Practical Biology: C. W. Dodge (New York, Harper).—Aero-Therapeutics: Dr. C. T. Williams (Macmillan).—Lehrbuch der Petrographie: Dr. F. Zirkel, Zweiter Band (Leipzig, Engelmann).  
PAMPHLETS.—The Texan Monsoons: M. W. Harrington (Washington).—Die Tropischen Orkane der Südsee, &c.: E. Knipping (Hamburg).—The Function of Museums, as considered by Mr. Ruskin: W. White.—Meteorology at the Paris Exposition: A. L. Roth.  
SERIALS.—Geological Magazine, March (K. Paul).—Records of the Botanical Survey of India, Vol. 1, Nos. 1 and 2 (Calcutta).—American Naturalist, February (Philadelphia).—Botanical Gazette, February (Madison, Wis.).—Geological Journal, March (Stanford).—Observaciones Magnéticas y Meteorológicas del Real Colegio de Belen, Julio-Dic. 1889 (Habana).—Bulletin of the New York Mathematical Society, Vol. 3, No. 5 (New York, Macmillan).—Science Progress, No. 1 (Scientific Press).—Quarterly Journal of Microscopical Science, March (Churchill).

CONTENTS.

|                                                                                                                                                         | PAGE |
|---------------------------------------------------------------------------------------------------------------------------------------------------------|------|
| Electromagnetism and Dynamo Construction. By Prof. A. Gray . . . . .                                                                                    | 429  |
| Internal Combustion Motors. By N. J. Lockyer . . . . .                                                                                                  | 430  |
| Physiology for Science Schools. By J. S. Eddins . . . . .                                                                                               | 431  |
| Our Book Shelf:—                                                                                                                                        |      |
| Glazebrook: "Light: an Elementary Text-book, Theoretical and Practical, for Colleges and Schools" . . . . .                                             | 432  |
| Newberry: "Beni Hasan." Part ii. . . . .                                                                                                                | 432  |
| Letters to the Editor:—                                                                                                                                 |      |
| Great Auk's Egg.—J. E. Harting . . . . .                                                                                                                | 432  |
| On M. Mercadier's Test of the Relative Validity of the Electrostatic and Electromagnetic Systems of Dimensions.—Dr. G. Johnstone Stoney, F.R.S. . . . . | 432  |
| Experiments in Elementary Physics.—W. Rheam . . . . .                                                                                                   | 433  |
| Spectacles for Double Vision. (With Diagram).—T. I. Dewar . . . . .                                                                                     | 433  |
| Recent Local Rising of Land in the North-West of Europe.—C. A. Lindvall . . . . .                                                                       | 433  |
| Apogamy in <i>Pteris serrulata</i> (L. fil.) var. <i>cristata</i> .—A. H. Trow . . . . .                                                                | 434  |
| Fireballs.—W. F. Denning . . . . .                                                                                                                      | 434  |
| Astronomy in Poetry.—G. W. Murdoch . . . . .                                                                                                            | 434  |
| Recent Publications of the American Geological Survey. By Prof. T. G. Bonney, F.R.S. . . . .                                                            | 434  |
| Measurements of Low Vapour Pressures. By J. W. Rodger . . . . .                                                                                         | 436  |
| Notes . . . . .                                                                                                                                         | 437  |
| Our Astronomical Column:—                                                                                                                               |      |
| The Aurora of February 28 . . . . .                                                                                                                     | 441  |
| Mira Ceti . . . . .                                                                                                                                     | 442  |
| Halley's Comet . . . . .                                                                                                                                | 442  |
| Iodine as a Base Forming Element. By A. E. Tutton . . . . .                                                                                             | 442  |
| Prince Henry the Navigator . . . . .                                                                                                                    | 443  |
| Science in the Magazines . . . . .                                                                                                                      | 443  |
| The Cambridge Diploma in Agriculture . . . . .                                                                                                          | 444  |
| On Homogeneous Division of Space. (Illustrated.) By Lord Kelvin, P.R.S. . . . .                                                                         | 445  |
| University and Educational Intelligence . . . . .                                                                                                       | 448  |
| Scientific Serials . . . . .                                                                                                                            | 449  |
| Societies and Academies . . . . .                                                                                                                       | 449  |
| Books, Pamphlets, and Serials Received . . . . .                                                                                                        | 452  |



THURSDAY, MARCH 15, 1894.

TROPICAL BOTANIC GARDENS AND  
THEIR USES.

*Der Botanische Garten "s Lands Plantentuin" 2 v. Buitenzorg auf Java.* Festschrift zur Feier seines 75 jährigen Bestehens. Mit 12 Lichtdruckbildern und 4 Plänen.

*Eine Botanische Tropenreise, Indomalayische Vegetationsbilder und Reiseskizzen.* Von Prof. Dr. Haberlandt. Mit 51 Abbildungen.

IF one casts a glance over the more modern botanical literature, it will become evident that special activity is being manifested in that department, which we may term, in accordance with the German usage, the biology of plants. The day has long passed since the eminence of a botanist depended on the number of plants—dried or otherwise—which he could recognise at sight. But it is not so long ago since exaggerated importance was attached to a minute and exhaustive knowledge of details of the internal structure of plants, although, fortunately, the practice did not last long enough, nor did it become sufficiently general, to render the mental burden so heavy as the load which the older systematists had to bear. It is clear, however, that in each instance the science passed, and indeed had inevitably to pass, through a similar phase. The facts must be accumulated before they can be grouped, or before sound general conclusions can be deduced from them. Of course, the processes of accumulation and deduction were not severed in point of time; but the success of the latter process depends largely upon the industry with which the first has been carried out. The practical results have culminated in the perception of the meaning of a "natural classification," on the one hand, and in the evolution of a morphology which embraces and welds together the dry facts of pure anatomy into a consistent system, on the other.

But the morphology of to-day differs widely from that of a quarter of a century ago, both in its breadth and, also, to some extent, in the way in which it deals with its materials. Thanks to the labours of men like Sachs, Schwendener, and others, we are attaining to a broader conception of the principles which underlie and which govern the structure of plants, and we recognise that the most minute details of the organisation may be traced, whether ultimately or immediately, back to the responsive action of the protoplasm to the exigencies of its environment.

And perhaps few causes have been more efficient in promoting this change of front from the older formal views, than the extended experience of the manifold adaptations exhibited by plants which has been gained as the result of observation and travel in regions where the conditions of vegetation differ widely from those which obtain in Europe. As one shock after another assails our crystallised notions of the "typical form," we are driven to admit that our carefully drawn up categories may

break down, and become obliterated, or fused beyond all recognition. The one fact which does stand out clearly through all, is the immense capacity for adaptive modification exhibited, not only by vegetation as a whole, but by individual organisms in particular.

If we find the plant more plastic in structure than we had supposed, the fault lies, not with nature, but in the too rigid formality of our ideas respecting what we had conceived to be typical forms of segmentation, and upon our too scanty recognition of the truth that bodily segmentation is after all only an expression of organisation. And as this principle becomes more clearly apprehended, the purely abstract and merely descriptive anatomy grows increasingly obsolete, and gives way to a more intelligent method of dealing with the subject. But if it is now possible for the best workers to seek out the meaning and the bearing of the new facts they discover, the merit of the older observers should not therefore be lost sight of. They laboured, and we have entered into their labours and are reaping the harvest which was not ripe for them to reap, which could not have even been sown, had their patience not been what it was. We can recognise, what they only saw dimly, that convergent and parallel lines of development have played an important part in the evolution of plants; that identical, or closely similar structural, form may be reached from independent and often widely different starting-points. Moreover, we see in this ultimate form, not the realisation of an ideal Type (which is really an outgrowth of nominalism), but the very practical expression of the fact that these evolutionary lines are those which best enable the organism, with its special inherent and inherited disposition, to cope most successfully with the complex difficulties of its environment, and to solve most successfully the problem of its existence. And these conclusions have been arrived at as the result of careful study, not merely of dried specimens and of pickled material, but also by the observation of living plants under their natural conditions of growth.

There can be no question that it is in the tropics that this last, and by no means least, important branch of a botanical education can be most suitably carried out. Nowhere else are the facts, which a study of the living organism will teach, more forcibly impressed on the mind than in those regions where the infinitely more complex conditions of existence demand a correspondingly greater variety of adaptation than is the case in our colder latitudes.

And with the establishment of gardens and laboratories in the tropics, it becomes increasingly easy for every botanist to avail himself of the immense advantages of a study of the vegetation of these parts of the world, not under the artificial conditions of stoves and hot-house culture, but under the widely different aspect of fierce mutual competition, in which they maintain their existence in a state of nature.

The publication of the interesting account of the justly famous garden and botanical station in Java, on the occasion of its seventy-fifth anniversary, comes at a peculiarly favourable juncture; and it is to be hoped that a perusal of its pages will do much to stimulate many botanists, who as yet lack a personal acquaintance

with tropical plant life, to go out and make use of the advantages now so easily within their reach.

The volume is a most interesting one; it tells of the difficulties which the enterprise of maintaining the "s Lands Plantentuin" had to encounter and to overcome. Founded in 1817, it has succeeded in asserting its value, not only to the colony but also to science, and its importance in the latter respect is testified to by the number of botanists and others who annually visit it, as well as by the large amount of good work begun or carried out in its laboratories.

The volume, besides containing a description, illustrated with plans and photographs, of the garden and establishment at Buitenzorg, includes also an account of the various experimental stations which have arisen as offshoots from it. It contains, further, a useful *résumé* of the numerous investigations which have been conducted in connection with the gardens, and which have been published in various journals and reports. There is interesting and valuable information given concerning the culture and uses of economic plants.

But the gardens in Java, like our own colonial establishments of a similar nature, do not exist solely for scientific or ornamental purposes. Their use to the colony, and their importance in serving as a means for introducing and experimenting on the cultivation of vegetable products suitable to the country, cannot be overrated. The present writer recollects a well-known Ceylon planter observing, *à propos* of the garden at Peradeniya (in Ceylon), that it would have abundantly justified both its existence and its expense had it done nothing but serve as the means of introducing the cultivation of Cinchona into the island, during the interregnum which prevailed between the collapse of the coffee industry and the rise of tea. And this remark was the more striking, as it was made some years after experience had been shown that the growth of Cinchona could not be profitably pursued any further. The plant had, however, served its turn, and had saved the country from possible bankruptcy.

Amongst the list of visitors to the Java garden, one notices the name of Prof. Haberlandt, and he has given us his impressions of the tropics in a most delightful volume. It is true that there is not, perhaps, much that is actually new to any one who is versed in modern botanical literature, but Dr. Haberlandt tells what he has to say in a charmingly enthusiastic and artistic manner; and his pages are illustrated with impressionist sketches which convey an excellent idea of the character of the objects portrayed.

The book is what it professes to be—an account of a "botanical excursion"; but besides the chapters on epiphytes, mangroves, hill and desert floras, there are sections devoted to observations on the natives and their ways, as well as others on the climate and meteorology of Java. The chief value of the volume lies in the perception of things which will, or should, attract the eye of a traveller new to the tropics; and while the work may be praised as one full of matter of considerable general interest, it may be especially commended to those who are themselves about to undertake a journey to the East.

J. B. F.

### THE TELEPHONE.

*A Manual of Telephony.* (The Specialists' Series)  
By W. H. Preece, C.B., F.R.S., and Arthur J. Stubbs.  
(London: Whittaker and Co., 1893.)

ONLY about four years ago we reviewed a treatise entitled "The Telephone," by Mr. W. H. Preece and Dr. Maier, which up till recently was the chief manual on its special subject in English. The rapid advance of telephony, however, had rendered large portions of that work completely out of date, and Mr. Preece, with, this time, Mr. A. J. Stubbs as co-worker, has completely re-discussed the subject, and replaced the former treatise by the present.

The work is divided into six parts, and each of these again into some half-dozen chapters. Part i. deals with the construction and mode of action of telephones and transmitters, ii. with general apparatus and switches, iii. with simple exchange stations, iv. and v. with the more complicated and extensive exchanges, their switchboards, &c., and vi. with the construction of telephone lines and cables.

What we said about the merits of the former book we have here to repeat. Nowhere else in English have we so full and accurate descriptions of telephones and transmitters, or so practical and detailed accounts of telephonic apparatus, and the mode of carrying on the work of telephone exchanges. This, by far the greater part of the book, is extremely well done, and we have no doubt that as a practical guide and help to the telephonic engineer, it will be of very great value.

Anything we have to say in the way of criticism on the contents of the book resolves itself in the main into a few remarks on the first chapter and the last, in both of which we find sections that seem to require slight improvements.

In chapter i. we have a very brief account of current induction. This is clear in general, but one or two statements ought to be amplified in order to prevent misunderstanding. On p. 9 it is affirmed that the intensity of the magnetic force in the field of a conductor carrying a current varies inversely as the square of the distance from the conductor. This statement cannot be said to be true except of a short current element, in which case the magnitude of the force is as stated, and its direction at right angles to the plane determined by the element and the line joining it to the point at which the force is being considered.

The conductor contemplated in the next sentence seems to be a straight one of unlimited length, for in other cases the lines of magnetic force are not *circles* round the wire, unless, of course, the wire be very thin, and the field at points only which are very close to the wire be considered. In the case of a single long straight conductor the magnetic force varies inversely as the distance from the conductor.

Again, it is stated in p. 11, that "there are two classes of induction": that is, induction of currents produced by the variation in position or magnitude of currents in neighbouring conductors, and induction due to changes in the magnetic field in which the conductor acted upon is situated. Of course the authors do not mean to assert

that these are really distinct, for both can be accounted for by changes in the magnetic field in which the conductor is situated. The field in one case is produced by magnets, in the other case by current-carrying conductors. It would have been well to point out this connection between the two things; in fact, the idea of a conductor carrying a current as equivalent to a certain magnetic distribution is in many cases very helpful in enabling the nature of the magnetic fields of conductors to be estimated, and the conductors to be properly arranged for the purpose in hand.

We took exception before to the statement in p. 12 that "the energy  $W$  of a current in a coil at any moment is expressed by the product of the current ( $C$ ) and the electromotive force ( $E$ ) that is  $W = EC$ ," and we are sorry it has escaped revision. Of course the authors are perfectly aware that  $EC$  is in reality power or activity, not energy, and merely use a very common but inaccurate mode of speaking of the quantity  $EC$ . The energy of the current  $C$  in a coil is  $\frac{1}{2}LC^2$ , where  $L$  is the self-inductance of the coil, and the expression ought to be reserved for this quantity.

Experienced electricians like the authors may and do avoid error from the adoption of popular but inaccurate language; but the mental confusion of power with energy is very common, and has led to the most absurd conclusions as to the electrical efficiency in the circuits of generators and motors. The misinterpretation, which used to be so common, of the so-called law of Jacobi is a case in point. In their anxiety for brevity of statement and intelligibility to practical men, the authors, it seems to us, run some risk of being seriously misunderstood.

The chapter on the theory of the Bell telephone is lucid, and gives a very good account of the various theories that have been advanced from time to time regarding molecular action, &c. Mr. Heaviside's simple explanation (given also, if we mistake not, by Mr. Trouton) of the part played by the permanent magnet in the telephone is stated at p. 28.

Chapter xxxi., on the limiting distance of speech, contains a clearly expressed summary, of course without any attempt at quantitative discussion, of the conditions of working an ordinary submarine or underground cable, of which the true theory, and therefore also, it may be remarked, the practice, was given long ago by Lord Kelvin. Mr. Preece has had an immense amount of practical telephonic experience; but we are not convinced that in circuits composed of non-magnetic metals, with rapid alternations of the kind concerned in speech-telephony, the influence of electromagnetic inertia is so slight as the authors seem to regard it.

We heartily commend this work to the technical readers to whom it is addressed. The account of telephone practice which it contains is worthy of all praise, and it will prove not only a most useful work of reference, but from its size a readily carried about and consulted handbook for all engaged in such work. We wish it all success, and a speedy reissue in a new edition, when the few improvements we have suggested may easily be made.

A. GRAY.

### GÜNTHER'S BACTERIOLOGY.

*Einführung in das Studium der Bakteriologie mit besonderer Berücksichtigung des mikroskopischen Technik. Für Aerzte und Studierende.* By Dr. Carl Günther. Third edition, 1893. 376 pp. (Leipzig: Georg Thieme.)

ACTIVITY in the bacteriological world shows no signs of decreasing, and whilst text-book after text-book make their appearance, new editions of older works follow one another in rapid succession.

The first edition of Dr Günther's book was published in 1890, and now we have already before us the third edition. A review of the second edition having appeared in these columns in March, 1893, it will only be necessary to draw attention briefly to some of the principal additions and alterations in the present volume.

The fact that 100 pages of new material have been added, is in itself a guarantee that the author has not failed to incorporate a great deal of fresh work, and, indeed, on going carefully through the letter-press, the reader is struck by the extreme care and thoroughness with which the revision has been carried out.

The section introductory to the special description of pathogenic bacteria has been increased from nineteen to thirty-one pages, and now contains a comprehensive review of the recent work on the subject of immunity. There is, however, no mention of the experiments in this direction which have been made with the glanders bacillus by Kresling, Semmer, and Wladimirov and Semmer, and which appeared early last year in the Russian journal, *Archives des Sciences Biologiques*, issued by the Imperial Institute of Preventive Medicine in St. Petersburg. In the account of the tubercle bacillus we find five additional pages, and a more moderate view taken of the value of tuberculine as a cure for consumption than appeared in the previous edition.

But, as was to be expected, it is in the description of the cholera comma bacillus that the largest amount of fresh material has been incorporated, close upon twenty extra pages having been found requisite to bring the work up to date. The various methods for the correct diagnosis of the cholera organism are very fully given, as well as the numerous devices for its isolation from water when present with other bacteria. Amongst the more important comma-shaped organisms endowed with pathogenic properties is included the *vibrio berolinensis*, which was found last summer by Neisser in the Berlin water supply. The account given of this vibrio is necessarily very slight, for Neisser's paper had not yet been published in full. This organism resembles the cholera comma bacillus very closely, and appears to be distinguished from the latter only in the appearance of the colonies on gelatine plates; but these differences are so slight, depending chiefly on the finer granulation of the contents and the less irregular contour of the colonies, that it is difficult not to regard it as a variety of the cholera vibrio.

Amongst the twenty-four saprophytic bacteria mentioned, the nitrifying organisms are conspicuous by their absence. The investigations made both in this country and on the continent have now firmly established the existence and individuality of these organisms, and it is

difficult to understand the omission, especially as space has been found for such uninteresting microbes as the *spirillum rubrum* and others.

The photographic illustrations, whilst remaining the same in number, have been in some cases changed; three of the new ones are devoted to comma-shaped bacilli resembling the cholera vibrio, one of them being the *vibrio aqualilis*, recently isolated by Dr. Günther himself from water, whilst two new plates have been added of the colonies of the cholera bacillus in different stages of development.

The volume is undoubtedly one of the best introductions to the study of bacteriology which has yet been produced.

G. C. FRANKLAND.

#### OUR BOOK SHELF.

*Lectures on Mathematics.* Delivered from August 28 to September 9, 1893, at North-Western University, Evanston, Ill., by Felix Klein. Reported by Alexander Ziwet. (London: Macmillan and Co., 1894.)

IN these twelve lectures, which are excellently reported by Mr. Ziwet, it was the intention of Prof. Klein to present his hearers with an account of some of the modern developments of mathematics, particularly in those branches in which the lecturer himself has worked. Each lecture is therefore a unit in itself, and the whole work thus covers a wide range of subjects. The nature of the case precludes exhaustive treatment; the lectures are cyclopædic in character, and the copious references will please the readers who may wish to look up the original memoirs for details. It would be useless in a short review to attempt to do more than briefly describe the matter contained in these ninety-eight pages. We notice that geometrical methods of research are particularly emphasised, and their usefulness demonstrated in widely different territories. The first four lectures are purely geometrical in character, being devoted to the work of Clebsch (i.), to the geometrical side of the researches of Lie (ii. and iii.), and to the modern results on the real nature of algebraic curves and surfaces (iv.). Chapter v. treats of the application of geometrical methods to function-theoretical questions, illustrated by the case of the hypergeometric function. In chapter vi. Prof. Klein discusses the nature of space-intuition and the relation of mathematics to the applied sciences. The following chapter contains an account of Hilbert's simple proof of the transcendency of the numbers  $e$  and  $\pi$ , and chapter viii. contains a beautiful application of geometrical methods to certain problems of the number theory. By a simple construction the author has given to the composition of binary algebraic forms, and to the ideal numbers, a high degree of simplicity and clearness. The remaining chapters treat successively of the solution of higher algebraic equations, hyper-elliptic and Abelian functions, and non-Euclidian geometry.

Appended also is a translation of the article by Prof. Klein, entitled "The Development of Mathematics at the German Universities," written originally for the section "Mathematik" in the work "Die Deutschen Universitäten" (Berlin: A. Asher and Co., 1893).

English mathematical readers have to thank Mr. Ziwet for laying before them in a neat form the residue, so to speak, of this Evanston Colloquium.

*Elementary Trigonometry.* By H. S. Hall, M.A., and S. R. Knight, B.A. (London: Macmillan and Co., 1893.)

IF the knowledge of the subject under consideration varied directly as the number of text-books on that subject, there is no doubt that elementary trigo-

nometry would be running very high for the first place among school-books. The law of the survival of the fittest, in its manifold forms, is appropriate for text-books, if for anything, and it is perhaps good that this is so, as we should soon be flooded out by their excessive number. Of late, however, books for beginners on this branch of mathematics have been of a high standard of excellence, and the one before us is no exception. The joint authors are well known for their school books on algebra, and their great experience in teaching has given them a real insight into "how to teach." To briefly enumerate the points which the authors name as special to this book, we may commence by saying that only those elementary parts have been handled which do not require the use of infinite series and imaginary quantities. Special prominence is given to examples, &c. on easy identities and equations, to enable the beginner to thoroughly master the fundamental properties of trigonometrical ratios. The subject of radian or circular measure is with advantage referred to later. Logarithms are fully dealt with, and special attention has been given to the exposition of problems on heights and distances. The examples in all chapters are numerous and typical. This book can safely be recommended to beginners, and it may, besides imparting to them a sound elementary knowledge of the subject, ingraft an intelligent interest for more advanced study.

#### LETTERS TO THE EDITOR.

[The Editor does not hold himself responsible for opinions expressed by his correspondents. Neither can he undertake to return, or to correspond with the writers of, rejected manuscripts intended for this or any other part of NATURE. No notice is taken of anonymous communications.]

#### Great Auk's Egg.

"A THANKLESS task the truth to tell," says a minor poet. In my note (*supra*, p. 412) I tried to do it in an impersonal way; but Mr. Harting, to my regret, introduces names (p. 432) while falling back upon a statement which was controverted three years ago, and is unsupported by fresh evidence. On some accounts I highly esteemed the late Mr. Bond, with whom I was acquainted for nearly forty years, and I am very sorry to impugn the accuracy of his memory: it is well known that he never kept a note of any specimen in his collection. I express no doubt that his tale of 1860 was correctly reported, and I have none as to the correctness of the report of the tale, purporting to be the same, told by him in 1889 (in Mr. Harting's presence, if I am not mistaken), and carefully taken down. A copy of this, now before me, shows that in the interim the tale, as tales are wont, had developed. In the later version the seller of the egg was "a fisherman who had been on a whaling ship"; but I hold that neither version is "deserving of consideration."

As to my own story my recollection is clear. I heard it more than once from Mr. Yarrell; and in its time it was common talk among the egg-collectors of those days, of whom I am one of the last. Not six months ago I was talking of it with the late Mr. Henry Walter, whom we have since lost. I find it supported by a memorandum made by me (I think) in 1862, which was based (I know) on one of earlier standing, though that is not forthcoming. But I have positive evidence in a letter written by Mr. Wolley from Lapland on February 5, 1857, in reply to one just received from me giving him particulars of the sale of Mr. Yarrell's collection in December, 1856. Therein Mr. Wolley, who on a point like this could not err, recalling its lately deceased possessor, and remarking on the change of owners, wrote of "Yarrell's eyes as he told the often repeated story of his buying the egg in Paris—this very egg now in Gardner's hands."

To some it will seem a small matter where Mr. Yarrell bought the egg; but to those who have tried to tell the *Garefowl's* true history, it is disheartening to find belief sought for the Boulogne version, as it shows how their trouble has been thrown away. No one with any knowledge of facts could suppose that the

species had a breeding-place near which any whaling ship, in the present century at least, ever went; and those who accept this version recur to errors that were refuted by Prof. Stenstrup more than five-and-thirty years ago. ALFRED NEWTON.

Magdalene College, Cambridge, March 10.

#### The Decomposition of Liquids by Contact with Cellulose.

THE recent work of Dr. Gore, on "The Decomposition of Liquids by Contact with Powdered Silica," presents a striking resemblance to what has from time to time been ascertained with such substances as cellulose. In fact, the properties ascribed to silica are very likely shared under some conditions by colloids in general, whether they be "organic" or "inorganic" bodies. Cellulose, when immersed in diluted solutions of some metallic salts, has the power of abstracting from them a certain quantity of the salt for which it may have no chemical affinity as ordinarily understood. The amount of salt abstracted is dependent upon several conditions: the degree of dilution of the salt; the ratio of cellulose to salt; the ratio of cellulose to weight of solution; the temperature; the physical condition of the cellulose; and the chemical constitution of the cellulose.

Let us, in order to eliminate the last-named condition, confine ourselves to pure cellulose or cotton. When cotton wool is placed in a solution of a metallic salt, it abstracts the salt from the solution until equilibrium is established. If we regard the part played by the cellulose in the light of Witt's theory of solid solution, the amount of salt retained by cellulose is conditioned by the relative solubility of the salt in water and cellulose, and the ratio in which the three exist together. If water is now added, a certain amount of the salt dissolved by the cellulose will become resolvable in the water. Also, if the solution be concentrated, the fibre will generally take up a further quantity. In some cases, however, the amount of salt taken up by the cellulose is not imparted to the solution on dilution. This is probably due, as in the case, I believe, of the ferric salts, to dissociation in solid solution. The dissociated base being insoluble (in water) is retained by the cellulose on addition of water, whereas the acid may be dissolved. The physical condition of the same cellulose has a great influence upon the amount of salt which it is capable of dissolving. If cellulose be finely disintegrated, it behaves differently from that in which the ultimate fibres remain intact.

The cotton fibre, when seen under the microscope, is found to vary considerably in shape and size. It is probable, then, that each fibre has a certain constant of absorption peculiar to itself. Cellulose, when rendered anhydrous by placing it in a water-bath or desiccator, is found to rise considerably in temperature when exposed to a damp atmosphere. This may, however, be caused by the liberation of heat, due to the condensation of moisture from the gaseous state. If so, no rise of temperature would be noticed in plunging anhydrous cellulose into water. It appears, however, that cellulose is susceptible of a certain degree of hydration in coming in contact with water, which is probably attended by the liberation of heat. I have found that dried cellulose placed in a damp atmosphere remains at a higher temperature than its surroundings so long as it is taking up moisture, which appears to be greatest when the rate of absorption is greatest. By the time it has recovered its normal condition of moisture it has sunk to the temperature of its surroundings.

The above considerations seem to point out that cellulose, like silica, exhibits well the phenomena of solid solution.

C. BEADLE.

#### Physiological Psychology and Psycho-physics.

IN a note contained in your issue of January 11 (p. 252), upon the teaching of psycho-physiology in University College, I notice two errors; which, as they are, unfortunately, very widespread, you will perhaps allow me to correct.

(1) "Physiological psychology" and "psycho-physics" are not one and the same thing. The former science is a specially limited and specially enlarged psychology. Limited: in that it pays more attention to experimentation carried out by physiological methods than to any other psychological experimentation. Enlarged: in that it discusses the most important problems relating to the physical basis of mental life. These latter problems belong to psycho-physics, which is the science of the relation of "mind" to "body."

(2) A "practical course in psycho-physiology," which confines itself to the senses, is not a representative or adequate course, as the note implies. The psycho-physics of sensation is no more the whole of psycho-physics than the physiology of the sense-organs is the whole of physiology, or the psychology of sensation, perception, and idea, is the whole of psychology. A historical accident has led to this popular restriction of the term; but a glance at the literature of the science will show its wrongness. E. B. TITCHENER.

Cornell University, February 16.

DR. TITCHENER'S criticism of my note strikes me as a little strange. First of all, he objects to my speaking of "physiological psychology or psycho-physics," maintaining that they are different, and then proceeds at once to subsume psycho-physics under physiological psychology. As a matter of fact, psycho-physics, as understood by Fechner, the coiner of the word, and generally up to quite recent times, does not directly refer to the relation of the organism to psychical phenomena at all, but to the relation between the (extra-organic) stimulus and sensation, though of course this inquiry leads on to two further inquiries: (a) the relation of the extra-organic to the organic process, and (b) the relation of this last to sensation. Munsterberg and others now use "psycho-physical" for relations generally between neural processes and psychical processes, but the change of meaning is a little confusing. Anyhow, it will be seen that there is no general agreement about the expressions "physiological psychology" and "psycho-physics," such as Dr. Titchener's note suggests.

I may add that in using "or" rather loosely (as I felt justified in doing in a short note), I did not mean to imply that the two branches of inquiry were identical. I wanted to call attention especially to the fact that the course would go systematically over an experimental inquiry into the senses which would necessarily include reference to stimulus, and so psycho-physics, and reference to nerve process, and so physiological psychology. As to Dr. Titchener's second "error," I find him hypercritical. I am well aware that psycho-physiology covers more than the senses, and I think that nothing which I say implies the contradictory of this. There can surely be a practical course on a subject which does not exhaust all divisions of the subject. As a matter of fact, however, Dr. Hill is taking up other branches, as reaction-time experiments. I was content to emphasise the fact that the senses would be systematically examined; and all who know what psycho-physiology has done, know that by far the larger part of the really fruitful work leading to definite results has been done in the investigation of the senses.

THE WRITER OF THE NOTE.

March 3.

#### THE LAST GREAT LAKES OF AFRICA.<sup>1</sup>

ADMIRABLY translated as it is, this book scarcely retains a trace of its previous existence in a foreign tongue; but although the translator states in the preface that she has slightly condensed the original matter in bringing it to its present form, we believe that much more rigid compression might wisely have been applied. Earlier books have placed later travels in Eastern Equatorial Africa so prominently before the British reader, that much of the ground which was full of fresh interest when the two gallant Austrians traversed it is now familiar, and its features common-place. Thus a great part of the first volume, detailing the troubles of inexperienced and, perhaps, somewhat imperious Europeans in organising a large caravan at Zanzibar and Pangani, and in crossing the coast-lands and ascending the slopes to Kikuyu, might well have been omitted without lessening the thrilling interest of subsequent chapters.

The expedition, primarily a sporting one, was also in large measure exploratory, and if the pursuit of big game, and the hairbreadth escapes of the hunters

<sup>1</sup> Discovery of Lakes Rudolf and Stefanie. A Narrative of Count Samuel Teleki's Exploring and Hunting Expedition in Eastern Equatorial Africa in 1874 and 1875. By his companion, Lieut. Ludwig von Höhnel. Translated by Nancy Bell (N. D'Anvers). With 179 original illustrations and five coloured maps. In two vols. (London: Longmans, Green, and Co., 1894.)

occupy a more prominent place than the physical character of the country and the nature of the people, the author doubtless consults the taste of the majority of his readers in the arrangement. Besides, the really valuable scientific results, due almost entirely to Lieut. von Höhnel's skill and enthusiasm as an observer, are well known to the scientific world from the admirably precise memoir published shortly after the return of the expedition. The casual reader of this more popular work would hardly realise the magnitude of the services rendered to African geography by the few modest references to observations and collections made by the author. Two appendices summarise Count Teleki's "bag," and the natural history collections. The latter comprise 12 reptiles or amphibia, 247 species of Coleoptera, of which 60 are new to science, and 59 species of Lepidoptera, including 15 that are new. The botanical collections, named by Prof. G. Schweinfurth, include 171 species of phanerogams illustrating more than 50

country. Many curious facts are mentioned incidentally as to camp management. When the supplies ran short, one of the Zanzibari head-men himself hit on the device of paring down the wooden bowl which was used to measure out the rice, so that day by day the rations were reduced but the measure was always full. The Zanzibaris being somewhat strict Mohammedans, and having many prejudices, were difficult to cater for; they would only eat elephant flesh when driven by severe hunger, and threatened to starve rather than devour donkey.

The reward for the increasing hardships came with the discovery of Lake Rudolf, a noble sheet of water 170 miles in length, probably the last of the greatest lakes to be found in Africa. It lies in a region of strong volcanic activity; a great mountain was seen, though not reached, from the crater of which a cloud of smoke ascended, and the scenery of some parts of the lake-shore suggest an analogy with the lunar surface. The water was brackish, or rather alkaline, containing sodium carbonate



Feshiat Woman.



Bum-Marlé Woman.

orders, and over 60 mosses and lichens, a large proportion of them being new to science.

While it is well to remember the solid contributions to different branches of science made by the expedition, the interest of the popular record inevitably centres in the larger field of exploration, and especially in the splendid discovery which supplies the title. The whole first volume is filled with the journey through Masai-land and the partial ascents of Mts. Kilimanjaro and Kenia, which in the main confirm, although they occasionally extend, the earlier records of Joseph Thomson and Mayer. Volume ii. conducts the party from Lake Baringo into the heart of the mysterious region which separates the land draining to the Victoria Nyanza from the Galla country and Somaliland. The march northward was a work of vast difficulty, and its success says much for the perseverance and foresight of the leaders, for food was very scarce, and water often altogether wanting, while the native guides frequently caused much trouble by their ignorance of the

in solution, so that when treated with tartaric acid it made a refreshing drink. The shores were absolutely barren, affording no food for cattle, and showed marks of recent great upheaval, while the lake itself was without outlet. After struggling along this land of volcanic gloom at imminent risk of death by starvation, the expedition reached the north end of Lake Rudolf, crossed a fertile region inhabited by hospitable tribes, and discovered Lake Stefanie, a smaller volcanic basin, the water of which seemed to be rapidly diminishing in volume. Here it was necessary to return; there were no maps of the country where the expedition was; no certainty of being able to gain the coast by the north or east, and failing supplies of goods for barter compelled a retreat on Lake Baringo and thence to Mombasa. The tribes of the Lake Rudolf region presented many points of great interest, and still remain an ethnological problem, although the observations of Lieut. von Höhnel on his expedition with Mr. Astor Chanler, from which he has recently been invalided home, may be expected to throw

much new light upon them. The contrast between the handsome and comparatively fair Reshiats and the ill-favoured and artificially deformed Buma and Marlé people is singularly marked, although the tribes reside near each other. The Buma-Marlé women wear lip ornaments, closely resembling those of the Botocudo and other savages of the Amazon basin. Dwelling on the west side of Lake Rudolf, the Turkana tribes set some of the most curious fashions in hair-dressing that even the African mind has devised.

For some time to come this district, first entered by Count Teleki and Lieut. von Höhnel, will be the base for new exploring journeys of high importance; but it is difficult of access, and all those who have tried to follow in the footsteps of the pioneers, have so far been obliged to turn back unsuccessful.

H. K. M.

#### THE BEETLES OF NEW ZEALAND.

TIMES have changed since the founders of entomology considered it sufficient to use the words "in India," when they were unacquainted with the locality of an insect they were describing; nor would it be possible now to publish a volume of "Insects of India," like Donovan's, issued no longer ago than the beginning of the present century, in which many of the species represented on the plates are conspicuous South American or African butterflies. At present it is hardly considered lawful to describe an insect without an exact locality, and the number of species has increased to an extent of which the older entomologists never dreamed. We cannot at present be acquainted with much fewer than 300,000 species of insects from all parts of the globe, and yet none but a few, even among entomologists themselves, have any conception of how much yet remains to be done before our knowledge of the insects of the world can be considered anything like complete; and some entomologists of great experience now mention ten millions as a mere guess at the approximate number of existing species.

But our knowledge of the insects of various countries is now being largely extended by the publication of local monographs of different groups of insects, mostly, but not always, relating to the *Lepidoptera*. These monographs are of the greatest value as a basis for future research, and are especially important in the case of islands for several reasons.

Firstly, an island has a restricted area, and hence its fauna forms a compact whole; nor can there usually arise much difficulty in ascertaining what species are really indigenous.

Secondly, from the restricted area of islands, and the facilities they offer for colonisation and cultivation, the bulk of the native fauna and flora is peculiarly liable to be exterminated, not merely from the advance of cultivation, with its usual accompaniments of clearing of forests and drainage of marshes, but from the irruption of powerful competitors in the shape of dominant, if not almost cosmopolitan species from abroad.

Thirdly, many insular species, especially in the case of oceanic islands, are endemic, being peculiar to the locality, and found nowhere else in the world, and are thus liable to be lost to science for ever. Nor are we yet in a position to estimate the value of such species. It is even not impossible that in some cases, at least, they may be the last remnants of the productions of some long-vanished continent, and they may some day prove of service in helping us to map out the rough features of the former geography of the world.

The volume before us, although issued as parts v., vi., and vii. of Captain Broun's "Manual of New Zealand Coleoptera," is really a supplement to the well-known and extremely useful work published by the Geological Survey and Museum Department between 1880 and 1886. These parts, issued as i.-iv., comprised 973 pages, and included descriptions of 1756 species. The present supplement continues the pagination to 1504 pages, and includes descriptions of 836 new species, thus raising the number of New Zealand beetles to 2592; and Captain Broun considers that over 700 species still remain undescribed. It will therefore be seen that, notwithstanding the extremely insular character of the New Zealand fauna, there is every reason to believe that the number of species of *Coleoptera* will ultimately far exceed that of our British beetles, which are not now considered to amount to quite 3000 species.

Dr. Hector, the Director of the Colonial Museum, Wellington, remarks, in his preface to Capt. Broun's work:

"Of the present additions, 660 have been described by Captain Broun, 172 by Dr. David Sharp, four by Mr. Matthews, and one by M. Fauvel; and in order to place these species in proper systematic position, Captain Broun has found it necessary to establish several new genera."

It is impossible to criticise a work like this, consisting almost entirely of technical descriptions of genera and species. A very few corrections to the former parts of the work are prefixed to this volume, in addition to a not very formidable list of errata. It is obvious that there could be no room in a book of this kind for more than a few of the most important comments which might be made on the earlier portions.

There is a good systematic index at the beginning of the volume, and we do not think that as there is no synonymy, the absence of an alphabetical index is of any importance. But we should have liked to have seen an index of localities, for although the places mentioned may be, and probably are, familiar to New Zealand colonists, yet other coleopterists may wish to know, at least, in which island each insect was taken; and in the case of mountain species, the approximate altitude, if known, should be recorded. We cannot have too much or too exact information on matters of this kind.

W. F. KIRBY.

#### NOTES.

THE preliminary arrangements for the seventh International Congress of Hygiene and Demography, to be held at Budapest from the 1st to the 9th of next September, are well advanced, as many as 440 papers having already been promised. Most of these treat of hygienic subjects, but 78 papers are devoted to demography. The Congress will be opened by the Archduke Karl Ludwig.

THE Government has decided to place the direction of the Customs and Inland Revenue Laboratories under one administrative chief, to be styled the Principal Chemist of the Government Laboratories. The Principal Chemist will also receive references from the Board of Agriculture, the Local Government Board, and other Government departments. The appointment, which is in the gift of the Treasury, has been offered to, and has been accepted by, Prof. Thorpe, F.R.S., who thereby vacates the Chair of Chemistry in the Royal College of Science, which he has held since 1885.

DR. ARTHUR W. BISHOP, late Assistant Professor at the Heriot-Watt College, Edinburgh, has been appointed, by the Secretary of State for India, Professor of Chemistry in his Highness the Maharajah of Travancore's College at Trivandrum, Travancore.

<sup>1</sup> "New Zealand Institute. Manual of the New Zealand Coleoptera." By Captain Thomas Broun. Parts v., vi., vii. Published by the Board of Governors, Wellington, New Zealand. (Government Printing Office: Samuel Costall, 1893.)

DR. W. J. RUSSELL, F.R.S., has been elected President of the Institute of Chemistry, in succession to Dr. W. A. Tilden, F.R.S.

DR. F. DAHL has been appointed Professor of Zoology, and Dr. F. Shütt Professor of Botany, in Kiel University.

DR. K. AUWERS, Privat-docent in Heidelberg University, has been appointed Professor of Physical Chemistry.

A COLLECTION of botanical specimens from the Pamirs, made by Captain Younghusband, has been added to the Herbarium at the Saharanpur Government Botanical Gardens.

THE *Pioneer Mail* says that direct telephonic communication was established between Calcutta and Nagpoor, a distance of 750 miles, on February 18. Messages were successfully interchanged between the two stations.

It is said that negotiations are in progress between Dr. Billings, on behalf of the United States Surgeon-General's Office, and the family of the late Prof. August Hirsch, of Berlin, for the purchase of the library left by the latter, which consists of about 10,000 volumes.

GALES or strong winds have occurred with great persistency over our Islands during the past week. On Saturday morning, the 10th instant, a storm centre lay off the north of Scotland, and between that time and Sunday morning a very severe gale was experienced in the north and west, while upwards of an inch and two-tenths of rain fell at Stornoway. On Monday afternoon another severe storm reached our south-west coasts, and on the succeeding night passed in a north-easterly direction to the North Sea. This disturbance was also accompanied with heavy rainfall at many places; at Holyhead it amounted to three quarters of an inch. The rainfall lately in Scotland has been greatly above the average; the excess in the north of Scotland is 8.6 inches since the beginning of the year.

THE report of the Berlin branch of the German Meteorological Society for the year 1894 contains an investigation by its President, Prof. G. Hellmann, on the temperature in and outside the town of Berlin. The influence of a large number of houses on the temperature is very marked, and Dr. Hellmann has been at great pains to secure trustworthy results; the instruments are carefully compared and exposed at several stations in properly constructed screens, and are in charge of persons interested in the work. The mean yearly temperature in the town is found to be nearly 1° higher than in the suburbs, the greatest difference occurring in the warmer season (March to August), and the least during winter. But in time of severe frost the difference has amounted to as much as 14°. The greatest variation naturally occurs in the evening, when the houses radiate the heat obtained during the day-time; in summer time this difference amounts to 2° or more, and on calm evenings may even amount to more than 5°; the temperature curve inside compared with that outside the town shows quite a different rate of fall.

A PAPER on the Texan monsoons was recently read before the Philosophical Society of Washington by Prof. M. W. Harrington. In order to ascertain the existence, locality, and character of recurring winds, maps were constructed from the tri-daily observations of the Weather Bureau, to exhibit the most frequent winds for each month of the year, and these maps showed a distinct seasonal change in wind direction in several localities of the United States. The southerly winds, or summer monsoons, in Texas first appear distinctly in March, and their area is most extensive from May to October, when it occupies about 500 miles in longitude and about 1000 miles in latitude, extending to the Canadian boundary. The northerly winds or winter monsoons first appear distinctly in December, and con-

tinue until the end of February, occurring for the most part under anticyclonic conditions to the north of Texas. They sometimes combine with the well-known "northers," causing a great fall of temperature. These monsoon winds play a very important part in the climate of Texas; the southerly winds bring coolness when it is most needed, while the northerly winds, although not so favourable, are not less so than the prevalent westerly winds to the northward of that State.

THAT the luminosity of a candle can be calculated direct from the dimensions of its flame, is the rather striking theorem of Herr P. Glan, who gives the results of his measurements in the current number of *Wiedemann's Annalen*. The volumes of the bright portions of various candle flames were measured by taking the length by means of a scale placed behind the flame, and the breadth at various points by gauging it with calipers or compasses. These bright portions have approximately the shape of cones, each of these cones being penetrated from below by a truncated cone, consisting of the dark central portion. The difference between the volumes of the two cones gave the volume of the brilliant portion. Stearine and paraffin candles of various thicknesses, and provided with different wicks, were compared by means of a rod photometer. It was soon found that the height of the flame was not the only factor determining the brightness. A stearine candle of 5.88 cm. circumference had, on the other hand, a higher luminosity than another 6.49 cm. in circumference. But a determination of the ratio of the volume to the illuminating power showed that this ratio is very nearly constant, the difference between the actual luminosity and that calculated from its volume never exceeding 3 per cent. In other words, equal volumes of the bright flame of any two candles give out the same amount of light.

AT a recent meeting of the Société Française de Physique, Dr. d'Arsonval exhibited a new form of electrical machine which has been devised by M. Bonetti. The machine is a modification of the ordinary Wimshurst pattern, the improvements introduced by M. Bonetti consisting in the suppression of the metallic sectors and the replacement of the single brushes at the extremities of the transverse conductor by three at either end. As a result of these changes, the output of the machine, and the length of spark it is capable of giving, are both increased. If two similar machines are taken, one having metallic sectors and the other without, and the output is measured with a Lane's jar, it is found that the machine without sectors gives an output from two to four times as great as the ordinary form. Another advantage possessed by the new form of machine is that it is not subject to a change in polarity while at work. Although the machine is not self-exciting, it can be started by placing the finger against the upper part of one of the rotating discs while it is in movement. If it is desired to change the polarity of the machine, it is only necessary to place the finger at the same part of the opposite disc.

IN a second paper, on the polarisation upon a thin metal partition in a voltameter (*Philosophical Magazine*, March 1894), Mr. John Daniel discusses the passage of ions through a gold-leaf partition, and also the minimum current-strength at which the ions are deposited visibly upon the partition for various electrolytes. In order to investigate the first point two similar voltameters with metallic partitions were set up at the same time, and, without passing the current quantitative analyses of the solution on the two sides of the partition, were made at stated intervals; then the current was passed, the voltameters being in series, quantitative analyses being again made of the solution on the cathode side, and the weight of copper deposited on the cathode determined, and finally the circuit was broken and the analyses again repeated. Curves plotted from these results show



no break nor change of slope for the intervals during which the current was passing. Thus it would appear that the current does not sensibly affect the diffusion of copper sulphate and sulphuric acid through a gold-leaf partition. In the experiments on the "critical current" it was found that the concentration of the electrolyte exerted an important influence on the value obtained, and the measurements made indicate that the "critical current" is proportional to the conductivity of the electrolyte. Experiments made to determine whether the variation of the temperature has the same effect upon the "critical current" as upon the conductivity, are not yet sufficiently complete to justify conclusions being drawn.

MR. HENRY GANNETT, of the United States Geological Survey, has published the results of his calculation of the average elevation of the United States with a magnificently-coloured contour-map of the whole area on the scale of about 100 miles to an inch. The contouring is in large part hypothetical, but the discussion takes all considerations into account in order to present the results as accurately as possible. It is estimated that the mean elevation of the United States is 2500 feet, a little greater than Dr. Murray's estimate of the mean elevation of the land of the globe. Delaware is the lowest State, averaging only 60 feet above sea-level, while Wyoming and Colorado are the highest, respectively 6700 and 6800 feet. Eleven States are above the average level, all being on the Pacific coast or in the adjacent Cordillera region. Florida and Louisiana are the least elevated States next to Delaware, being only 100 feet in average height. In making these calculations the levels of railway lines were extensively utilised to supplement the somewhat scanty determinations of altitude made by official surveys.

THE few regions of Europe still unexplored formed the subject of consideration at the last meeting of the Royal Geographical Society, when Mr. W. H. Cozens-Hardy described his recent journey through Montenegro and the borders of the adjacent Turkish provinces of Albania and Novi-Bazar. Mr. Cozens-Hardy has been able for the first time to map accurately the frontiers of Montenegro defined by the Treaty of Berlin, and he succeeded in gaining the good-will of the people, penetrating for some distance into Albania, where the practically independent tribes still make travelling dangerous. The northern and eastern parts of Montenegro consist of grassy mountains, forests, and fertile valleys, contrasting with the bare rocky hills and river-basins of the coast region and the centre.

THREE Norwegian whalers have attempted seal fishery in the Antarctic waters south of the Falkland Islands during the southern summer now ending. One of these vessels was as far south as 69° or 70° without finding enough ice to make sealing profitable, and it is reported that a considerable extent of new land has been discovered and charted.

THE botanical collections made by Messrs. Bark and W. E. Meehan during the Peary expedition, are described in the *Proceedings of the Philadelphia Academy*, under the title "Contribution to the Flora of Greenland." One hundred species of flowering plants and vascular cryptogams are enumerated, thirty-nine of lichens, and twenty-eight of mosses.

HERR S. CSAPODI records in the *Sitzungsberichte of the Ungarische naturwissenschaftliche Gesellschaft von Budapest*, the curious fact that several mould-fungi, especially *Mucor Mucedo*, will grow on solid compounds of arsenic, giving off arsenical vapours. This may be compared with Zukal's observation of the growth of *Halobysus moniliformis* in a saturated solution of sodium chloride, and the existence of living fungi in solutions of salts of copper.

NO. 1272, VOL. 49]

SIR DOUGLAS GALTON calls attention to an important and extensive investigation being carried out by the committee on the mental and physical condition of children, of which he is the chairman. About 50,000 school children have been seen individually, and from the notes taken it appears that about seven per cent. were mentally dull, and that sixteen per 1000 require special care and training. It is proposed to report upon 100,000 children if the necessary funds are forthcoming, and for this an appeal is made to all who, while desiring progressive education, also desire that the training of children should be conducive to the development of both sound bodies and brains.

MR. C. A. BARBER, Superintendent of Agriculture for the Leeward Islands, contributes to the *Leeward Islands Gazette* a report on the diseases of the sugar-cane in the West Indies. It refers chiefly to the insects which attack the canes, the various stages of the different species being described and figured. The *Kew Bulletin* for March contains also a correspondence on the subject between the Director of the Gardens and the Director of Forests and Gardens for Mauritius. This refers to the destruction of the crop by the parasitic fungus *Trichosphaeria Sacchari*, which has apparently been introduced into Mauritius from the West Indies.

THE *Journal of the Royal Asiatic Society of Bengal* for November 27, 1893, contains an interesting article on the "Blind Root-suckers of the Sunderbans," a tract of swampy littoral forest occupying the southern portion of the Delta of the Ganges. A large number of the trees which inhabit this area are furnished with root-suckers in the form of woody processes growing in an upward direction, and developed at irregular distances along the whole course of the roots. They project from one to three feet above the surface of the ground, and apparently cease to grow when the apex has reached the level of the highest spring-tides. The main object of these structures is to protect the tree against the uprooting effect of violent winds in the swampy soil; but they also contain a system of air-chambers for the aeration of the root. They never produce buds.

READERS of Hermann Müller's "Die Befruchtung der Blumen," or its excellent translation by Prof. D'Arcy Thompson, will remember its opening sentence: "It was not until the close of the last century that the true purport and significance of flowers began to be perceived. Christian Conrad Sprengel seems to have been the first to view the subject in the light of adaptation, and to show how all the colours, scents, and singular forms of flowers have some useful purpose. His book struck out a new path in botanical science, and its title, 'The Secret of Nature revealed in the Formation and Fertilisation of Flowers,' shows that the author was well aware of the importance of his discoveries." This work of Sprengel's, "Das entdeckte Geheimniss der Natur im Bau und in der Befruchtung der Blumen," was published in Berlin in 1793, and for many years has been an exceedingly rare and costly book. In spite of the teleological standpoint of all Sprengel's researches, it will always be a book of interest and of reference; we are therefore glad that advantage has been taken of the centenary of its appearance, to bring out a facsimile reprint, which has just been published as one of Mayer and Müller's "Wissenschaftliche Classiker in Facsimile-Drucken." The volume contains 224 quarto pages and twenty-five plates, and costs only eight marks.

IN a paper, "Influenza della luce solari sulle acque di rifiuto," Dr. Procacci contributes to the *Annali dell' Istituto a'Igiene Sperimentale di Roma*, vol. iii. p. 437, the results of his numerous investigations on the bactericidal action of sunshine on the microbes normally present in drain-water.

Cylindrical glass vessels about 60 c.m. high and 25 c.m. wide were employed; from some of these the light was excluded, whilst in others it was allowed free access. The temperature of the latter never exceeded that of the former by more than from  $2^{\circ}$ – $4^{\circ}$  C., and in neither case did it ever extend beyond from  $40^{\circ}$ – $42^{\circ}$  C. In every instance a marked diminution in the bacterial contents was observed in the insulated vessels, whilst at the same time a more or less marked increase took place in those protected from the sunshine; the period of exposure varied from one and a half to nine hours. Of particular interest are the investigations made to ascertain to what depth in the water the antiseptic action of the sun's rays extended. It appears that when the vessels were exposed to the perpendicular as well as the oblique rays of the sun, the bactericidal power of insolation was unimpaired at the bottom of the vessel, a depth of half a metre; but when the perpendicular rays only were admitted, no diminution took place in the number of bacteria present at this distance from the surface. That the oblique rays rendered important service in the destruction of the microorganisms was further shown by a special bacterial examination of portions of the liquid in the immediate vicinity of the sides of the cylinder, for when the latter was freely exposed to sunshine, the smallest number of microbes was found in those parts of the liquid which were nearest to the walls of the vessel. Dr. Procacci, in summarising his results, expresses his belief that the bacterial purification which takes place during a river's course may in many cases, where the rate of flow is presumably too great to admit of sedimentation taking place, be attributed directly to the destructive action of sunshine on the suspended microbes.

THE *Psychological Review* for March contains several important papers, among them being one on reaction-times and the velocity of the nervous impulse, by Profs. C. S. Dolley and J. McKeen Cattell. The object of the authors' investigations was to determine the conditions which affect the length of reaction-times on dermal stimuli, and to study the application of the reaction-time to the measurement of the velocity of the nervous impulse in motor and sensory nerves, and in the motor and sensory nerves of the spinal cord. For the application of the stimuli, two points were chosen on the arm over the median nerve, and two on the leg over the posterior tibial nerve. The points on the arm were 30 cm. apart, and those on the leg 50 cm. apart, and the length of intervening nerve would be nearly the same. It was found that the reaction-times were longer when the stimulus was applied to the lower points on the arm and leg than when the points less distant from the brain were used. If the difference of time is really due to the difference in length of the nerve traversed, the velocity of the impulse in the sensory nerve is 21.1 metres and 49.5 metres per second, respectively, for the two observers. The velocity in the sensory fibres of the posterior tibial nerves was 31.1 metres per second for Prof. Dolley, and 64.9 metres per second for Prof. Cattell. This large difference between the two observers, however, is attributed to differences in the cerebral processes rather than to differences in the velocity of the impulse in the sensory nerve. In the case of reaction experiments with dermal stimuli the electric shock was mostly used, but as the physiological effects of the shock were found to vary greatly on different parts of the body, a method was devised for applying a touch or a blow. It was found that the same objective force of blow was followed by the same subjective sensation more nearly than in the case of electrical stimulation. From the difference in the reactions on touch when the stimulus was applied to the arm and to the thigh, the velocity of the nervous impulse in the sensory tracts of the spinal cord was determined as about 40 metres per second.

MESSRS. R. FRIEDLÄNDER AND SON, of Berlin, have sent us a set of their "Naturæ Novitates," issued during the last four months. The circulars contain lists of current scientific literature, the works being classified according to subjects.

THE Director of the Botanical Survey of India has published two valuable additions to our knowledge of the flora of British India: a report on a botanical tour in Kashmir, by Mr. J. F. Duthie, and a report on a botanical tour in Sikkim, by Mr. G. A. Gammie.

WE have received a fresh instalment (Band 3, 2<sup>te</sup> Hälfte, 2<sup>te</sup> Lieferung) of Cohn's *Kryptogamen Flora von Schlesien*, which includes the Tuberineæ, Elaphomycetes, Saccharomycetes, and the commencement of the Pyrenomycetes. Two new genera and several new species are described.

A REPORT on North-Western Manitoba, and portions of the adjacent districts of Assiniboia and Saskatchewan, drawn up by Mr. J. B. Tyrrell, has been published by the Geological Survey of Canada. The report is accompanied by two maps, one showing the geology of the region, and the other the distribution and character of the forests.

IN the *Proceedings* of the Geologists' Association (vol. xiii, part 6) Mr. A. Smith Woodward briefly reviews the present state of knowledge of the sharks' teeth met with in British Cretaceous formations. The review is illustrated by two admirable plates, which will be of use to collectors; and several of the specimens described add something of importance to the facts previously known.

MM. RICHE AND ROUME contribute to the *Annales des Mines* (sér. 9, tome v., Liv. 1, 1894) a general account of the petroleum industry of the United States, the result of a visit to the districts made by the authors in 1892. The article deals in great part with the methods of refining, comparing them with processes used in France; but it also contains descriptions of the production areas in the Eastern States, and gives an interesting map of Pennsylvania showing the gas and oil districts.

MESSRS. SWAN SONNENSCHNEIN AND CO. will shortly publish a new book by Mr. J. W. Tutt, under the title of "Woodside, Burnside, Hillside and Marsh." This will consist of a series of illustrated literary sketches, on somewhat similar lines to the author's "Random Recollections of Woodland, Fen and Hill," and will describe a series of natural history rambles in various parts of Kent and the Scotch Highlands, dealing with various branches of natural science in a popular way.

THE fourteenth volume of the Index-Catalogue of the Library of the Surgeon-General's Office, U.S. Army, has been issued. The volume comprises words between "sutures" and "universally." It includes 10,124 titles, representing 6426 volumes and 8850 pamphlets. In addition to this bulk of matter, there are 9867 subject-titles of separate books and pamphlets, and 38,461 titles of articles in periodicals. When the catalogue is completed, it will literally represent a solid monument to industry.

THE first of a series of monthly guides to the beauties of animate nature has been published by Messrs. Bliss, Sands, and Foster, under the title "The Country, Month by Month." Mr. J. A. Owen and Prof. G. S. Bonlger are the authors of this little book, which will be followed by others, each devoted to a particular month of the year. The descriptions are interesting and brightly written, and dwellers in towns who read them will assuredly be tempted "to put forth and brave the blast" of this blustering month of March in order to see the woodlands returning to life.

WE have on several occasions referred to the interesting series of reprints being published by W. Engelmann, Leipzig. One

of the latest additions to the series is "Electrochemische Untersuchungen," edited by Prof. Ostwald, and containing Sir Humphrey Davy's Bakerian Lectures of 1806 and 1807, dealing with chemical changes produced by electricity (*Philosophical Transactions*, 1807 and 1808). Another reprint just received is Brücke's observations on the colour-changes of chameleons, originally published in 1852 under the title "Untersuchungen über den Farbenwechsel des Afrikanischen Chamäleons." The editor of this reprint is Dr. M. v. Frey.

WHAT is written by Dr. Paul Carus in a "Primer of Philosophy," published by the Open Court Publishing Co., Chicago, is written clearly. The book does not set out the ideas of any particular school of recent thought, but is rather "a critical reconciliation of rival philosophies of the type of Kantian apriorism and John Stuart Mill's empiricism." At the present time the man of science frequently ignores philosophy, and the cause of true science is injured thereby. Dr. Carus shows, however, that as all the sciences are inseparable from each other, so philosophy is inseparable from the sciences. When this truism is more widely recognised, a new vista will be opened to us, in which the old and the new scientific methods will be happily combined.

WE have received a copy of the official organ of the National Department of Hygiene in the Argentine, which is published weekly at Buenos Ayres, under the direction of the President of the Department, Dr. José M. Ramos Mejía. Besides containing original memoirs, it is intended to give, in a concise and handy form, abstracts and reviews of the more important papers on subjects connected with hygienic science which have appeared in foreign journals. We find in the present number an account of work recently published in the *Deutsche Medicinal Zeitung*, the *Therapeutic Gazette* (Philadelphia), the *Zeitschrift für Hygiene*, the *Revue Internationale de Bibliographie Médicale* (Paris), &c. The abstracts are not bare outlines, but are very full, containing elaborate tables and many details of the experiments described.

THE maps and plans illustrating the Report of the Royal Commission on Metropolitan Water Supply have now been issued. Of most general interest are a contoured map of the Thames Basin, and a geological map of the same area, reduced from the Geological Survey map. Both sheets are on the scale of four miles to one inch; the latter is illustrated by three geological sections. Diagrams are given of the flow of the Thames and Lea; rainfall and percolation at Lea Bridge; gaugings of the Chadwell Spring; quantity of water purified from the wells of the New River Company. There is also a map of Hertfordshire illustrating Mr. R. S. Middleton's special report to the Commission, which shows the underground water-contours, and a map by Mr. G. J. Symons showing the rainfall in the basins of the Thames and Lea. There are in all fourteen plates.

COLLECTIONS of aphorisms do not appeal very favourably to us, for the reason that they are apt to create a "conceit of knowledge." The tendency of to-day is to be content with bits of information on diverse subjects, and to eschew the steady reading necessary for a clear understanding of anything. A further objection is that it is extremely difficult to select extracts which give a true impression of the author's meaning. This has been done, however, by Miss J. R. Gingell, in "Aphorisms from the Writings of Mr. Herbert Spencer," published by Messrs. Chapman and Hall. The selections deal with education, evolution, science, sociology, politics, justice, liberty, truth and honesty, sympathy, happiness, self-control, &c. They are well arranged and to the point, and illustrate the scope of the synthetic philosophy. Miss Gingell's volume may therefore serve a

useful purpose by presenting in a handy form Mr. Spencer's views on many subjects.

MR. J. E. WALKER defines his "Voices of the Stars" (Elliot Stock) as "a book of scientific facts and of mystical correspondences between the natural and the supernatural." Just as in early records we find that many peoples have endeavoured to accommodate natural phenomena to the prevailing type of religion, so Mr. Walker finds that the facts of astronomy suggest spiritual similarities. His book is very largely made up of extracts from the works of various astronomers, all the sources of information being acknowledged in foot-notes. The compilation shows clearly that the author is in touch with recent advances, and is capable of properly estimating the weights of the words and works of different observers. We cannot enter much into his spiritual interpretations of astronomical marvels, though the book abounds with such comparisons of the material and immaterial. To our mind, however, the analogues are frequently far-fetched and never impressive. By all means let life be put into what are often regarded as the dry bones of science; but it may be doubted whether dogma is able to assist in the resuscitation.

THE observations made at the Blue Hill Meteorological Observatory, Mass., in the year 1892, have recently been published as vol. xl. part ii. of the *Annals of the Astronomical Observatory of Harvard College*. There is an appendix giving particulars of experiments on atmospheric electricity. The volume concludes with an article on sudden changes of atmospheric temperature, in which it is suggested that there is a meteorological period as well as a magnetic one corresponding to the period of the sun's rotation.

A USEFUL contribution to our knowledge of the tropical hurricanes of the South Sea, between Australia and the Paumotu Islands, appears in *Aus dem Archiv der Deutschen Seewarte* for 1893, by E. Knipping, formerly Director of the Meteorological Observatory at Tokio, Japan. It contains a list and short description of all storms observed since 1789, with references to the sources whence the information has been obtained, and the frequency of the hurricanes and their paths are plotted in five-degree squares. Of 125 hurricanes on which the discussion is based, 109 occur between December and March, 12 in April and November, and 4 in September, October, and May. Near the Fiji Islands the number of storms increases regularly from December to March, but near New Caledonia and the Samoa Islands the majority occur in January. The prevalent direction of their course is south-easterly, while others take a southerly and south-westerly direction. Some useful hints are also given as to the courses to be steered by vessels overtaken by the hurricanes.

DR. ALFRED KOCH'S *Jahresbericht über die Fortschritte in der Lehre von den Gährungs-Organismen* for 1892 has just been published. This is the third year of its issue, and affords an invaluable volume not only for purposes of reference for those engaged upon the original work on, but also for those interested in the history and literature of, the important subject of fermentation. Under the respective headings of i. Lehrbücher, Zusammenfassende Darstellungen, &c.; ii. Arbeitsverfahren, Apparate, &c.; iii. Morphologie der Bakterien und Hefen; iv. Allgemeine Physiologie der Bakterien und Hefen; v. Gährungen in Besonderen; vi. Fermente—are to be found notices of, and excellent abstracts of the more important original memoirs published during the year. It is, in fact, a record of scientific progress, not only in the department of fermentation, but also in other branches of bacteriology more or less closely connected with it. The work is admirably done, and it is to be hoped that Dr. Alfred Koch will find sufficient support to ensure

its continuation for many years to come. We would, however, suggest that its value for purposes of immediate reference would be greatly enhanced by its publication being more prompt.

THE additions to the Zoological Society's Gardens during the past week include a Wild Cat (*Felis catus*) from Invernesshire, presented by Mrs. Ellice; a Solitary Thrush (*Monticola cyanus*) European, presented by Mr. J. Young; a Diana Monkey (*Cercopithecus diana*, var. *ignitus*, ♀) from West Africa, deposited; three Alpine Accentors (*Accentor collaris*), a Bluethroat (*Cyanecula svecica*) European, purchased.

### OUR ASTRONOMICAL COLUMN.

A NEW ACHROMATIC OBJECT-GLASS.—It is well known that in consequence of the irrationality of dispersion the nominally achromatic object-glass is really very far from achromatic. There is always a residual colour, frequently called the secondary spectrum, so that the images of bright stars are surrounded by halos of blue and red light. For this reason a refracting telescope designed for visual observations cannot be employed for photography. Many attempts have been made to correct this colour aberration of the achromatic lens, but the plans hitherto suggested have never been practically adopted, owing to difficulties of construction, or to the imperfect durability of the glasses employed. Mr. H. D. Taylor, optical manager to Messrs. T. Cooke and Sons, has recently taken up the question, and he appears to have come very near to a practical solution of the problem. He has aimed at producing an objective which shall be (1) almost perfectly achromatic; (2) equally well corrected for photographic purposes as for visual purposes; (3) capable of practical construction in large sizes; and (4) of ordinary durability.

The new object-glass which is to satisfy these conditions is a combination of two positive lenses and one negative lens, each made of a kind of glass possessing different optical properties. The necessary glasses are manufactured by Messrs. Schott and Gen, of Jena, and there is no reason to believe that there will be any difficulty in the production of large discs. The separate lenses are so constructed that the partial dispersions of two of the lenses combined are as nearly as possible equal to those of the third lens when acting singly. It is calculated that with the kinds of glass actually available the greatest departure from focus in the case of a 12-inch object-glass of 15 feet focus would be about 0.06 inches for the H rays, or only  $\frac{1}{14}$  that in an ordinary object-glass of similar dimensions. The curvatures of the lenses are designed to minimise the difficulty of practical construction and testing, and no important loss of light is anticipated from the increased thickness of glass which the new object-glass requires. Indeed, it is probable that there will be a considerable gain of light-gathering power from the convergence of all the luminous rays to a common focus. (Full particulars are given in the Patent Specification, No. 17,994, 1892.)

SOLAR MAGNETIC INFLUENCES ON METEOROLOGY.—Under this title Prof. H. A. Hazen has published a pamphlet dealing with the supposed existence of electric or magnetic fields in the atmosphere, and the possibility of their accounting for weather phenomena. The subject has for some time been under investigation by Prof. F. H. Bigelow, and papers upon it have been published by the United States Weather Bureau, and in several American journals. Prof. Bigelow considers that under certain conditions of the sun there would be generated two distinct magnetic fields—one from the photosphere, and one from the nucleus, the earth being traversed by at least three fields of magnetic force: the lines of permanent magnetism, those from the electro-magnetic or radiant field, and those from the magnetic or coronal field. The radiant field would be favourable to producing warm, dry, high-pressure areas, as seen in the tropical belt, while the magnetic polar field would be favourable to the production of cold, dry, high-pressure areas, such as frequent the storm-belts farther north. It is with the latter influence that we have chiefly to do, in which Prof. Bigelow detected systematic changes recurring in about twenty-seven days. On projecting temperature curves for different

parts, according to this magnetic ephemeris, he found *inter alia* that there is a continual lag in the time at which the maximum and minimum points of the curve reach the stations lying to the eastward, e.g. a minimum point in the curve in the eastern part of the country corresponds to a maximum point in the west, and *vice versa*. Prof. Hazen puts these theories to various tests, amongst them the passage of hot and cold waves across the United States, and he concludes that the outcome of these investigations must be a "bitter disappointment" to those who believe in an all-important influence, aside from heat, from the sun upon our weather changes. He admits that there is undoubted evidence that some influence does exist, but at present it appears to be masked by terrestrial conditions, which have yet to be studied and eliminated.

A NEW TELESCOPE FOR GREENWICH.—The Observatory announces that Sir Henry Thompson has offered the magnificent sum of £5000 to the nation, through the Astronomer Royal, for the purpose of buying a telescope for Greenwich Observatory. The instrument is to be expressly designed for photographic purposes, and, subject to the acceptance of the offer by the Government, will have an aperture of 26 inches. It will be made from the model of the equatorials used for the photographic chart of the heavens, but with double the dimensions of those telescopes. The guiding telescope will be the 12 $\frac{3}{4}$ -inch Merz refractor, with a light tube. It is intended to house the new instrument under the Lassell Dome, on the top of the central octagon of the new Physical Observatory, now being built in the south grounds of the Royal Observatory.

OCCULTATION OF SPICA.—On the morning of Good Friday the bright star Spica will be occultated by the moon. At Greenwich the disappearance takes place at 4.5 a.m. at the position angle 123°, and the star will reappear at 5.13 a.m. at position angle 297°, the angles being read from north in the direction north, east, south, west. The occultation will be visible at places between latitudes 79° north and 16° north, which are not too far from the meridian of Greenwich. The moon will be a little past full at the time.

NEW NEBULÆ.—Dr. Max Wolf announces in *Astr. Nach.* 3214, that several new nebulous patches appear upon photographs of the regions  $\rho$  and  $\epsilon$  Cassiopeiæ, taken at the end of last year and the beginning of this, with exposures of about sixteen hours. Three of these spots have the following positions:

|          | h. | m. |   | Decl.        |
|----------|----|----|---|--------------|
| R.A. ... | 0  | 49 | 0 | 60° 20'      |
| " ...    | 0  | 51 | 9 | " ... 60° 5' |
| " ...    | 1  | 38 | 0 | " ... 59° 5' |

### THE MINUTE STRUCTURE OF THE NERVE CENTRES.

THE Croonian Lecture was delivered by Prof. Ramon y Cajal at the Royal Society on March 8. After giving a short historical survey of his subject and referring to the work of Kölliker, His, Van Gehuchten, Waldeyer, Edinger, Von Lenhossék, A. Sala, P. Ramon, and Retzius, Prof. Cajal proceeded to give an account of his own work, and pointed out in what particulars his results differed from those of Camilo Golgi, the originator of the silver impregnation method. Golgi had shown that the protoplasmic expansions of nerve cells terminate by free extremities in the grey matter, that the prolongations of the nerve cells give off in their course through the grey matter very fine ramifying collateral branches, and that two types of cells may be distinguished—a motor type, distinguished by an unbranched axis cylinder, which becomes continuous with a fibre in the white matter, and a sensory type, distinguished by possessing an axis cylinder which on leaving the cell divides so freely that its individuality is lost as it ramifies in the grey matter. Within the grey substance a network of fibres is formed by the terminal twigs of centripetal nerve fibres, ramifications from the network derived from sensory cells, and collaterals of protoplasmic processes of motor cells.

Passing on to the results of his own work, Prof. Cajal showed that axis cylinders, in addition to the protoplasmic prolongations, end by free terminations in the grey substance. He does not admit that there is any sharp functional difference between the

motor and sensory cells, since morphologically motor cells are found in the olfactory bulb and the retina, and Golgi's sensory cells are sparsely found in the same regions, and, consequently, it is impossible to deduce the function of a cell from its shape and mode of branching.

The connection of the axis cylinder with the sensory cells of the grey matter is not by the mediation of a network, but by free arborisations around cells.

In birds and mammals the cells in the root ganglia have an axis cylinder which extends from the periphery, and the internal branch, entering the cord by the posterior root, bifurcates in the white matter. An ascending branch can be traced for several centimetres along the posterior column, and is found to end by arborisations around cells in the grey matter. The descending branch has a similar distribution. All branches, however, do not bifurcate. Collateral branches, long and short, pass off in bundles at right angles from the main branch and its bifurcations; the destiny of the short collaterals is the grey matter where their varicose arborisations surround the cells in the head of the posterior horn and the cells of Clarke's column. The long collaterals pass in a bundle from the ascending or descending branches and ramify in the substance of the anterior horn, where they come in contact with the bodies or the protoplasmic prolongations of motor cells. From this distribution it is obvious that the extremity of the long collateral is in contact with the body or the protoplasmic processes of the motor cell. For this reason Prof. Cajal speaks of the long collaterals as "sensitivo-motor," though Kölliker's term "reflexo-motor" enables the physiology of these to be the more easily grasped.

The grey matter of the cord contains at least four types of cells—the commissural, where the axis cylinder of the cell is in connection with the opposite antero-lateral column by way of the anterior commissure, cells in connection with the antero-lateral and posterior columns of the same side, motor cells in connection with the anterior root and "pluricordonal" cells, where a complex axis cylinder furnishes two, three, or more medullated fibres in connection with the columns of one side or of both.

Cajal holds that, according to the strength of the excitation, impulses entering by the posterior root may pass by the long collateral to the motor cells, and the expression of this is a reflex, or where the excitation is stronger, besides this route, the short collaterals as well as the ascending and descending branches of the bifurcated sensory fibres may conduct, in consequence of which other cells are thrown into activity.

Cajal considers the retina as a nerve ganglion formed of three tiers of neurones, the first of which includes the rods and cones, together with their processes as far as the external granular layer; the second composed of the bipolar cells, and the third of the ganglionic cells.

The internal and external molecular layers are the regions where the connections of the neurones are established. The excitatory process, started in the rods and cones, passes along the bipolar cells, the ganglion cells, the fibres of the optic nerve, into the fusiform and pyramidal cells of the geniculate body and the corpus quadrigeminum.

The optic nerve contains also centrifugal fibres which terminate by varicose arborisations around the spongioblasts of the retina, to which they carry impulses started by nervous excitations of central origin, the significance of which is obscure.

In the cerebellum a transverse section shows three concentric layers of neurones; the first, or molecular layer, consists of small stellate cells, the second of the cells of Purkinje, and the third of the granular layer. All these elements have connections of two kinds—intrinsic, which place the cells of the three layers in connection with each other, and extrinsic between the cerebellar neurones and the neurones of other nervous organs.

The connections of the granules, which are nervous organs, with the cells of Purkinje, are of great interest. The former possess three or four very short protoplasmic processes, each of which breaks up into an arborisation. An axis cylinder of exceeding fineness passes up to the molecular zone, bifurcating at various levels. During their course they come into intimate contact with the protoplasmic processes of the cells of Purkinje. Since each of these parallel fibres traverses the total thickness of the grey matter of a cerebellar convolution and ends by free extremities at the surface, it follows that a single granule is able

to act on a multitude of cells of Purkinje. Each of these last is under the influence of a considerable number of granules.

The extrinsic relations (those between the cells of the cerebellum and those of other nervous centres) are very difficult to establish.

As Golgi first showed, the cells of Purkinje give rise to nervous prolongations of the long type of which the termination is unknown, and, on the other hand, there end in the grey matter of the cerebellum axis cylinders coming from other organs, of which the situation is very uncertain. These are the *fibres moussues* and the *fibres grimpantes*. The *fibres moussues* terminate in the molecular layer by collateral processes which are in contact with the protoplasmic expansion of the granules. The ultimate twigs terminate in a varicosity, or in a small ramification. The *fibres grimpantes* traverse the granular layer, coursing along the cells of Purkinje, and surrounding the ascending stem and the protoplasmic branches with an elongated terminal arborisation quite comparable with that of a motor fibre in muscle.

It appears therefore that the cells of Purkinje may receive nervous impulses from other centres, either by means of the *fibres moussues*, or by means of the *fibres grimpantes*: whilst the small stellate cells of the molecular layer, as well as the large stellate elements of the granular layer belong to the second type of Golgi's cells, appearing to have no relations with the extrinsic fibres. These last cells are therefore styled "association corpuscles," as they appear to have for their exclusive role the association of the cells of Purkinje, or the granules, into a dynamic whole of which the significance is unknown.

In the cerebral cortex, for the sake of clearness, three main layers may be distinguished, a molecular layer, a layer of large and small pyramidal cells, and a layer of cells of various shapes. The molecular layer, which is always found in the brains of vertebrates, is formed of a very complicated plexus, the principal factors of which are the peripheral ramifications of the pyramidal cells, the terminal nervous arborisations of certain cells of the pyramidal layer of which the axis cylinders are ascending, and the ramifications of certain cells of fusiform or triangular shape, the greater part of whose expansions become horizontal, and resolve themselves into a large number of twigs. One may compare these elements with the spongioblasts of the retina and with the granules of the olfactory bulbs, as they also are without a differentiation into protoplasmic and nervous expansions.

The layer of pyramidal cells, the thickest layer of the cortex, consists of many elongated cells of pyramidal form, the principal characteristic of which is the possession of a protoplasmic stem, terminating in the molecular layer as a more or less horizontal arborisation of fibres, covered with spiny processes, and giving off many lateral and descending protoplasmic branches, and finally giving rise to a descending axis-cylinder continued to the white substance. The last layer consists of cells of variable form, usually elongated, one of the prolongations very often going towards the surface. The axis cylinder penetrates the white substance, and resembles that of the pyramidal cell.

In their passage through the grey matter all the axis cylinders of the pyramidal cells and the cells of variable shape give off a large number of ramifying collaterals, which terminate freely around the nerve cells. The whole of the ramifying collaterals form in the grey substance, and around the cells, a plexus of extreme complexity, in which are also present ramifying collateral twigs from the white substance and terminal arborisations of fibres of association.

The connections of the pyramidal cells of the cortex may be distinguished as *superficial* (belonging to the molecular layer) and *deep* (belonging to the subjacent layers).

In the molecular layer each protoplasmic "plume" of the pyramidal cells is in contact with an almost infinite number of terminal nervous fibrillae derived from the terminal arborisations of fibres of association originating in cells in the hemisphere of the same or of the opposite side; from special cells in the subjacent layers; from special cells in the molecular layer itself; from collateral fibres from the white substance, or from the deep layers of the grey substance, and from other situations.

In the molecular layer, then, each pyramidal cell may be influenced not only by the cells of the same region of the cortex, but also by others which lie in other lobes, it may be of the same side or of the opposite side of the brain. It is also probable that the molecular layer receives the ultimate ramifications of

the sensory nerves. Thus the peripheral "plume" of the pyramidal cells would be the spot at which the voluntary motor impulse arises, to be communicated to the body of the pyramidal cell, and so to the fibres forming the pyramidal tract.

When an electrical stimulus is applied to the cortex, muscular movements are produced, because the stimulus acts either upon the "plumes" or upon the nervous fibrils whose function it is to carry impulses to the "plumes." Every nerve centre is made up of four constituents: nerve cells with short axis cylinders, terminal nerve fibres coming from other centres or from distant parts of the same centre, nerve cells with long axis cylinders, and collaterals which arise from axis cylinder prolongations of cells, or from nerve fibres of the whole substance. In the retina, olfactory bulb, and molecular layer of the cerebrum, there are in addition cells characterised by the absence of differentiation of nervous and protoplasmic expansions.

In organs where it is well established that excitatory processes arise the cells are polarised, *i.e.*, the nervous impulse always enters by way of the protoplasmic apparatus, or by the body of the cell, and leaves by the axis cylinder, which transmits it to a new protoplasmic apparatus. The differentiation of the protoplasmic apparatus is for the purpose of enabling each cell to be connected with different kinds of nerve fibres, and the more varied the protoplasmic expansion, the greater the number of cells under whose influence it comes. In the same way the more the nervous expansion of a cell is extended, and the more collaterals it possesses, the greater is the number of cells to which its impulses may pass.

In the pyramidal cell of the brain of mammals, the differentiation and extension of the protoplasmic expansion, and the multiplication of the collateral and terminal nervous twigs are carried to their highest point, and on descending the scale both the differentiation and the number of twigs becomes rapidly less; in fish the pyramidal cell is absent.

As regards the education of the brain mental activity is not able to improve the cerebral apparatus by augmenting the number of cells, as the nervous elements lose their power of dividing during the embryonic period, but it is probable that intellectual exercise may produce in certain regions of the brain a large development of the protoplasmic apparatus and of the system of nervous collaterals, so that the associations already existing between certain groups of nerve-cells would be perfected by a further development of terminal twigs, of protoplasmic endings, and of nervous collateral branches, whilst quite new intercellular connections might be established by a new formation of collaterals and protoplasmic expansions.

"Vis à vis de la thèse des réseaux celle des arborescences libres des expansions cellulaires susceptibles de s'accroître apparaît non seulement comme plus probable, mais aussi comme plus encourageante. Un réseau continu pré-établi—sorte de grillage de fils télégraphiques où ne peuvent se créer ni de nouvelles stations ni de nouvelles lignes—est quelque chose de rigide, d'immuable, d'immuable, qui heurte le sentiment que nous avons tous que l'organe de la pensée est, dans certaines limites, malléable et susceptible de perfection, surtout durant l'époque de son développement, au moyen d'une gymnastique mentale bien dirigée. Si nous ne craignons pas d'abuser des comparaisons, nous défendons notre conception en disant que l'écorce cérébrale est pareille à un jardin peuplé d'arbres nombrables, les cellules pyramidales, qui, grâce à une culture intelligente, peuvent multiplier leurs branches, enfoncer plus loin leurs racines, et produire des fleurs et des fruits chaque fois plus variés et exquis.

"Du reste nous sommes très loin de croire que l'hypothèse que nous venons d'esquisser puisse à elle seule expliquer les grandes différences quantitatives et qualitatives que présente le travail cérébral chez les divers animaux et dans la même espèce animale. La morphologie de la cellule pyramidale n'est qu'une des conditions anatomiques de la pensée. Or cette morphologie spéciale ne suffira jamais à nous expliquer les énormes différences qui existent au point de vue fonctionnel entre la cellule pyramidale d'un lapin et celle d'un homme, ainsi qu'entre la cellule pyramidale de l'écorce cérébrale et le corpuscule étoilé de la moelle ou du grand sympathique. Aussi à notre avis est-il très probable qu'en outre de la complexité de leurs rapports les cellules pyramidales possèdent encore une structure intraprotoplasmique toute spéciale, et même perfectionnée dans les intelligences d'élite, structure qui n'existerait pas dans les corpuscules de la moelle ou des ganglions."

#### ON THE IRRITABILITY OF PLANTS.<sup>1</sup>

SOME years ago I published my observations on the strange and till then undescribed effect produced by various bodies on the sporangiferous hyphæ of *Phycomyces nitens*, well known to every plant-physiologist. To be brief, the phenomenon consisted in the fact that certain bodies attract *Phycomyces*, *i.e.* these bodies cause the hyphæ growing in their vicinity, at a distance of from one to two centimetres, to make curves in their growth, the concavity of which is directed towards the said body. This was particularly the case with iron; zinc and aluminium exhibited the same phenomenon, though in a smaller degree (aluminium only so slightly, that I now feel inclined to count this body among the inactive ones), while other metals showed no effect. In many other bodies the same effect was observed. The sporangiferous hyphæ, on the other hand, have a repellent effect on each other. I formerly designated this phenomenon as dependent on "physiological action at a distance."

At the Edinburgh meeting of the British Association for the Advancement of Science, held in August, 1892, Prof. L. Errera, of Brussels, read a paper on this subject, which was published in the Report of the Society, p. 746, having appeared earlier in the "Annals of Botany" (vol. vi. No. 24, December, 1892). He considered the phenomenon to depend on a kind of hydrotropism.

It is a well known fact that the sporangiferous hyphæ are negatively hydrotropic, *i.e.* that they curve away from a surface which discharges aqueous vapour, and the reciprocal repulsion of the hyphæ was considered by Errera to be a case of negative hydrotropism. From this it was naturally concluded that they are, on the other hand, attracted by a body that absorbs water. The effect of iron, since iron does actually absorb water in a damp atmosphere, is set down by Errera as a confirmation of this supposition. Even in other bodies which absorb water, Errera was able to find the same effect of attraction; indeed, in one case the inflexion of the hyphæ led to the discovery of the hygroscopicity of certain bodies. Thus the phenomenon would be bereft of its mysterious character, and classified among the already known qualities of this plant.

According to my experience, however, the explanation of Errera is not sufficiently well based to be yet admitted.

If iron acts as a hygroscopic (*sil venia verbo*) body, we should expect the phenomenon to be very clearly observable in these bodies, which are known to be particularly hygroscopic; for instance, potash and calcium chloride. But if a stick of caustic potash is fixed in the usual way above the culture of *Phycomyces*, taking care that the fluid dripping from the stick does not fall on the hyphæ or on the substratum, but into a small glass tube closed at the bottom, no attraction will be observed. The stick of potash absorbs much water from the atmosphere, its upper layers actually deliquesce, but, neither in its vicinity nor at a distance, do the hyphæ undergo any regular deviation from their direction of growth. I have made this experiment several times, and always with the same negative result. It is the same with soda. With solid calcium chloride it is difficult to work, because it deliquesces too quickly. I therefore used a solution of calcium chloride (one part of salt to one and a half part of water), with which I soaked a dry cylinder of plaster. This solution slowly absorbed aqueous vapour from the air; the cylinder consequently acted as a hygroscopic body, but no attraction could be observed. In one experiment the increasing weight of the cylinder (length 50 mm., diameter 11 mm., weight 4.904 gr.) was observed during the experiment; it amounted in four hours to 0.262 gr., and even then the body was not yet saturated with aqueous vapour.

Dry plaster also actively absorbs water from the air. I took a slab, measuring 80 × 35 × 10 mm., and dried it at 100°; it weighed 23.077 gr. During an experiment of six hours this slab was without effect on the *Phycomyces*; but in that time it had condensed 1.665 gr. of water. Now we might suppose that in this case the slab, by absorbing so much water, very soon came into a state in which it caused, neither positively nor negatively, hydrotropical curvatures; that in fact it had absorbed too much water to effect attraction, and too little to cause repulsion. But in the following six hours it still increased 0.049 gr. in weight, without exercising even now the least effect on the fungi.

In comparison with this, a plate of iron absorbs very little water. Such a plate, the total surface of which was 4950 mm.<sup>2</sup>,

<sup>1</sup> "Öfversigt af Finsk. Vet. Soc. Förhand." Häft xxvii. 1894

and consequently correspondent to that of the above-mentioned cylinder of plaster, increased in weight, in an atmosphere saturated with aqueous vapour, by only 3.5 mgr. in twenty-four hours.

If we argue that the hygroscopicity is the cause of the curvatures, we might assume that *Phycomyces* is only affected by bodies which absorb very little water, and that the above-mentioned bodies, which are without effect on *Phycomyces*, are too strongly hygroscopic. But then a positive curvature ought to be seen, at a certain distance from the bodies, where the hygroscopic effect is weaker; and this is by no means the case.

With all these facts in view, I cannot agree with Errera's hypothesis that the attracting effect of iron depends on a kind of hydrotropism. According to the statement of Errera, many hygroscopic bodies attract the hyphae, but it is hardly to be presumed that this is actually owing to hygroscopicity, as other hygroscopic bodies are without effect. It seems to me that this is a case of radiation, depending on the molecular state of the body, and manifesting itself by the physiological effect.

In one point Errera corrects my statements as to the effect of iron. I had found that the condition of the surface (burnished, roughly brightened, or somewhat rusty) did not affect the results. Errera says that the effect of burnished steel is very slight, and this I can confirm as regards very well burnished steel. In this circumstance Errera finds a confirmation of his hypothesis, since a burnished surface gets rusty, *i.e.* absorbs water very slowly. In my opinion this fact only implies that the state of the surface is of a certain importance for the radiation in question, as is known to be the case with regard to the radiation of heat and light.

It is self-evident that my idea of this phenomenon, as dependent on molecular vibration, is a mere hypothesis. It is, however, somewhat confirmed by the fact that similar physiological effects are produced by some phenomena, which we must, from the present stand-point of science, declare to be molecular vibrations; and the statement of this fact is the principal object of this paper.

Platinum belongs to the inactive metals, and well-burnished steel has, as mentioned above, a very slight effect. But if exposed for some time to direct sunlight, these bodies become active, *i.e.* the sunlight creates in them a condition which, though otherwise imperceptible, manifests itself by the fact that the body, clearly and even powerfully, attracts *Phycomyces*. The power of attraction appears on the illuminated as well as on the opposite side of the body. This condition of the body lasts for a few hours, but afterwards ceases.

This phenomenon is somewhat mysterious. It is indeed astonishing to see how the same piece of platinum-foil, which during a series of experiments was without effect on our *Phycomyces*, will attract them after being exposed to the sun, without undergoing any outward change.

But this phenomenon is not entirely without analogy. It is a well-known fact that a number of nonluminous bodies after being exposed to illumination emit light in a manner which has been described as phosphorescence. Some bodies phosphoresce only for fractions of a second, others for more than twenty-four hours. Metals do not belong to the phosphorescing bodies, but in the present case a kind of phosphorescence seems to take place which is not perceptible to our eyes, but, on the other hand, is effective on *Phycomyces*. The phenomenon might be designated as dark phosphorescence.

It is interesting to note that E. Becquerel, who thoroughly studied the phenomena of phosphorescence, had foreseen something of the kind. He says ("La lumière, ses causes et ses effets," 1867, l. p. 259): "Même si les corps ne sont pas lumineux dans le phosphoroscope, on ne peut dire qu'il n'existe aucun effet après l'action du rayonnement; car la lumière pourrait exciter des vibrations d'une autre vitesse que celles qui sont perceptibles à nos yeux (et en général plus lentes), et capables de donner lieu soit à des effets de chaleur, soit à d'autres actions moléculaires encore inconnues."

With regard to the requisite intensity of light, I need only state that in August intense sunlight during seventy minutes was sufficient to cause activity, whereas an exposition of five hours in cloudy weather was without effect. I have not found out the shortest effective period of the insolation; and as to the duration of the state induced by light, I can only say that bodies activated in the afternoon, which, on being tested at once, caused curvatures in three to four hours, were without effect the next morning.

That the effect is due to light, not to heat, is proved by experiments in which the steel and platinum plates were heated for hours to the temperature (40–45°) indicated by the thermometers during the insolation.

That the ultra-violet rays of the sun have no particular share in the phenomenon, is proved by the fact that the light which has passed through a solution of quinine-sulphate activates the respective bodies.

In experimenting with other metals, and various non-phosphorescing bodies, I could not demonstrate with certainty any such activation by light, which fact, however, does not exclude the possible occurrence of a dark phosphorescence of too short a duration to cause a physiological reaction.

Finally, I have to mention that certain bodies are rendered active by heat. I have found zinc to be one of them. Having heated a stick of zinc (5 mm. in diameter) in a blow-pipe flame until it began to melt, and having then allowed it to cool down to the temperature of my hand, I got, after an experiment of a few hours, the most beautiful curvatures in *Phycomyces* I could wish for. After cooling down for several hours, the stick was no longer active in this manner. Here we can justly speak of positive thermotropism, which is all the more interesting, as Wortmann in his experiments (*Botanische Zeitung*, 1883, p. 452) found only negative thermotropism in *Phycomyces*.

Some other bodies are quite different from zinc. The same plate of platinum that was rendered active by an hour's insolation, remained, after being heated red-hot for five minutes, just as inactive as before. Also in copper, cobalt, nickel, tin, lead, and glass, no effect was to be produced by great heat. There is not the slightest doubt but that plants, in their thermotropic curvatures, are affected by vibrations issuing from the molecules of the body applied, and this is also very likely the case with regard to the effect of light. It therefore does not seem unjustifiable to assume that even molecular vibrations, which are inherent in the bodies themselves, or connected with some change that they undergo, may cause similar physiological effects. FREDRIK ELFVING.

#### THE NEW IODINE BASES.

FURTHER details are given in the latest *Berichte*, by Prof.

Victor Meyer and Dr. Hartmann, concerning their recently-discovered basic compounds of iodine. It will be remembered that the fundamental base from which these new substituted bases are derived is the hypothetical compound  $\text{HO.II}_2$ , and that the derivative  $\text{HO.I} \begin{matrix} \text{C}_6\text{H}_5 \\ \text{C}_6\text{H}_4\text{I} \end{matrix}$  had been isolated as a strongly al-

kaline substance readily soluble in water, and which forms salts with acids with elimination of water, exactly like ammonium hydroxide. For the parent substance, therefore, the name iodonium hydroxide is proposed. At the conclusion of their first paper, Prof. Meyer and Dr. Hartmann announced that they had just succeeded in isolating the simpler di-phenyl derivative  $\text{OII.I} (\text{C}_6\text{H}_5)_2$ , and the present communication describes the strange mode of its genesis, and the character of the free base and its salts. The beautifully crystalline iodide was frequently obtained in small quantities during the whole course of Prof. Meyer's work with iodoso-benzene. It was observed that methyl iodide acts with great energy at the ordinary temperature upon the latter compound, and the product yields in contact with moist silver oxide a liquid from which potassium iodide precipitates crystals of the new iodide,  $\text{I.I} (\text{C}_6\text{H}_5)_2$ . It was subsequently found that when iodoso-benzene itself is triturated with moist silver oxide, the filtered liquid likewise yields similar crystals of diphenyl-iodonium iodide upon the addition of potassium iodide. This discovery led to a systematic study of the conditions of the reaction, and it was eventually elicited that freshly-prepared iodoso-benzene is incapable of so acting, but that by a few days' exposure in a thin layer to daylight, or, better still, by heating for some hours to 60°, it is rendered capable of producing the new base when brought in contact with oxide of silver. Moreover, it was ascertained that potash or soda are likewise capable of bringing about the change, although owing to subsidiary decompositions, not so advantageously as moist oxide of silver. It has finally been proved that the reaction depends upon the fact that upon heating to 60° or exposure to sunlight iodoso-benzene,  $\text{C}_6\text{H}_5 \cdot \text{IO}$ , is partially converted into the more highly oxidised compound  $\text{C}_6\text{H}_5 \cdot \text{IO}_2$ , and by the action of moist silver oxide upon the mixture of the two

diphenyl-iodonium hydroxide and silver iodate are produced, in accordance with the following equation:—

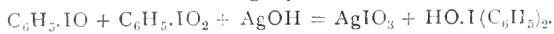

When a mixture of the two iodine aromatic derivatives, in the proportions required by the above equation, together with sufficient oxide of silver, is vigorously agitated for three hours in a triturating machine, such as that in use in the Heidelberg laboratory, and filtered, the clear solution upon the addition of potassium iodide solution yields over ninety per cent. of the calculated weight of crystals of diphenyl iodonium iodide. The iodic acid remains partly as silver salt in the residue, and partly as iodate of the new base in the solution.

The salts of the iodonium bases bear a remarkable resemblance to those of lead, silver, and in particular thallium. Those of the first di-covered base were described last week, but those of the diphenyl base are still more interesting, and many of them crystallise well.

The iodide obtained as above described forms large and beautifully grouped acicular crystals which melt at  $175^{\circ}$ – $176^{\circ}$ . During the act of melting it passes completely into mono-iodo-benzene, of which it is a polymer:—

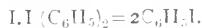

The chloride,  $Cl.I(C_6H_5)_2$ , is slowly precipitated upon the addition of a soluble chloride to the aqueous solution of the free base, in crystals which are very similar in aspect to those of lead chloride. From hot aqueous solutions excellent crystals separate upon cooling.

The bromide,  $Br.I(C_6H_5)_2$ , crystallises likewise from hot water, and the crystals are perfectly colourless, and frequently attain large size.

The aqueous solution of the free base,  $HOI(C_6H_5)_2$ , is very stable; it may be preserved unchanged for many days. Upon concentration of the strongly alkaline solution a thick syrup is eventually obtained of powerfully alkaline nature, but which has not yet been crystallised. It absorbs carbon dioxide with great avidity, forming a carbonate of the base, which effervesces upon the addition of a dilute acid; the carbonate, indeed, very much resembles that of thallium, being soluble in water.

Strangest of all these reactions, perhaps, is the behaviour of the solution of the base towards soluble sulphides. Sodium sulphide precipitates a bright yellow sulphide of the base, closely resembling arsenious sulphide, while ammonium sulphide precipitates a beautiful deep orange-coloured polysulphide, identical in appearance with freshly precipitated antimonious sulphide. Both sulphide and polysulphide decompose after a time with separation of an oil, consisting in the former case of iodobenzene and phenyl sulphide, and in the latter case of the same substances together with other phenyl sulphides. The work is being continued, and Prof. Meyer hopes before long to have something further to communicate concerning this unexpected and exceptionally interesting class of compounds. A. E. TUTTON.

### THE ETHNOGRAPHY OF THE ARAN ISLANDS, COUNTY GALWAY.

WHEN Professors Cunningham and Haddon opened their anthropometric laboratory in Dublin, rather more than two years ago, one of their objects was to promote systematic research in the country districts of Ireland. We have now received the first-fruits of the laboratory in the form of a paper on the ethnography of the Aran Islands, by Prof. A. C. Haddon and Dr. C. R. Browne, read before the Royal Irish Academy. The lines of research originally proposed have been considerably exceeded, and the paper before us is in reality a brief monograph of the islands. The observations, however, have been made chiefly on the inhabitants of Aranmore, the northern and largest of the three islands forming the group; and the southern island, Inisheer, was not visited at all.

The inhabitants of Inisheer, and of the middle island (Inishmaan), have been less subject to foreign influence than Aranmore, but the proximity of Inisheer to the mainland having rendered intercourse with Ireland easy, appears to have given to the inhabitants of that island a somewhat distinctive character.

The number of individuals actually measured by the authors was twenty-seven, twenty of them being natives of Aranmore, and the other seven being Inishmaan men; all were males.

The general physical characters of the people are thus described:—

*Height.*—The men are mostly of a slight but athletic build; and though tall men are occasionally to be met with among them, they are, as a rule, considerably below the average Irish stature. The Aran average is 1645 mm., or about 5 feet 4½ inches; that of 277 Irishmen is 1740 mm., or 5 feet 8½ inches.

*Limbs.*—The span is less than the stature in a quarter of the cases measured, a rather unusual feature in adult males. The hands are rather small, but the forearm is often unusually long.

*Head.*—The head is well shapen, rather long and narrow, but viewed from above, the sides are not parallel, there being a slight parietal bulging.

The mean cephalic index, when reduced to the cranial standard, is 75.1, consequently the average head is, to a slight extent, mesaticephalic; although, as a matter of fact, the number measured is nearly evenly divided between mesaticephalic and dolichocephalic. The top of the head is well vaulted, so that the height above the ears is considerable.

The forehead is broad, upright, and very rarely receding; not very high in most cases. The superciliary ridges are not prominent.

*Face.*—The face is long and oval, with well-marked features. The eyes are rather small, close together; they are marked at the outer corners by transverse wrinkles. The irises are in the great majority of cases blue or blue-grey in colour. The nose is sharp, narrow at the base, and slightly sinuous or aquiline in profile. The lower lip is, in many cases, rather large and full. The chin is well developed. The cheek-bones are not prominent. In quite a large proportion of cases, the ears, though not large, stand well out from the head. In many men the length between the nose and the chin has the appearance of being decidedly great. The complexion is clear and ruddy, and but seldom freckled. On the whole, the people are decidedly good-looking.

*Hair.*—The hair is brown in colour, in most cases of a light shade, and accompanied by a light and often reddish beard. As a rule, the hair on the face is moderately well developed.

*Sight and Hearing.*—The sight and hearing of the people are, as a rule, exceedingly keen, especially the former. The range and distinctness of the vision is astonishing, as we have had occasion to know; and we are informed by Dr. Kean that, on a clear day, any of the men whose eyesight is average can, with the naked eye, make out a small sailing-boat at Black Head, twenty miles away, before he can see it with a good binocular. The observations of the authors tend to show that the natives of Inishmaan are rather lighter than the Aranmore men.

The population is decreasing, but as the number of births is considerably in excess of the deaths, the decrease must be attributed to emigration. That some of the inhabitants live to a very advanced age is evidenced by the fact that a tombstone in Killeany records the death of a man in the 119th year of his age.

The islanders appear to be exceptionally honest, straightforward and upright in their dealings, and illegitimacy is almost unknown.

They are singularly non-musical, there being no piper, fiddler, or musician of any sort on the islands.

The majority of the people can understand and speak English, but Irish is the language most generally spoken among themselves.

Almost all the marriages take place immediately before Lent. There is no courting or love-making, but the young man who has decided to marry goes to the house where there is a suitable girl, and asks her to marry him; a man has been known to ask three girls in the same evening before he was accepted.

Wakes are held even upon those who die abroad. Occasionally a funeral procession stops on the road to the cemetery at certain spots, and the mourners raise small memorial heaps of stones; in Aranmore there are about two dozen of these roadside monuments; but the practice does not seem to date back beyond the beginning of the last century, and appears to have died out within the last twenty years.

The Aranites believe in fairies, banshees, and ghosts; and a corpse is always carried out of a house through the back door.

It is said that if anyone at a marriage repeats the benediction after the priest, and ties a knot on a piece of string at the mention of each of the three sacred names, that marriage will be childless for fifteen years, or until the knotted string has been burnt.



Pin-wells and rag-bushes are still frequented, and on the night before emigrating people will sleep in the open, beside one of the holy wells, in order that they may have good fortune in the country to which they are going. There is a firm belief in the power of the Evil Eye, and on certain days that are considered unlucky, even burials are avoided.

The antiquities of the Aran Islands are numerous and varied, but have never yet been systematically described; and the authors urge upon the Irish Academy the desirability of its undertaking a detailed survey of them.

No opinion is expressed as to what race or races the Aranites belong, but it is argued that they cannot be Firbolgs, if the latter are correctly described as "small, dark-haired, and swarthy."

A short bibliography is given at the end of the paper, and a few photographs, taken by Prof. Haddon, give a general idea of the appearance of the people.

### ELECTRICAL SANITATION.

A PRACTICAL application of electricity to sanitation has recently been made. Two systems have been tested upon a very considerable scale, in both of which the electrolytic action of the current has been utilised.

The two methods at present before the public are Mr. William Webster's, which is being carried out by the Electrical Purification Association (Limited), and that ascribed to Mr. Eugene Hermite, and worked by him in conjunction with Messrs. Paterson and Cooper.

As has occurred so frequently before, both these inventors appear to have conceived the same idea about the same time. Each of them took out three patents in the year 1887, but though each had the same object in view, and although in their early patents they seemed almost to be running on the same rather than on parallel lines, their recent practice is quite distinct.

Mr. Webster treats the sewage directly. He places parallel iron electrodes within a conduit or shoot, through which the sewage is passed, the electrodes being alternately connected with the positive and negative poles of a dynamo. The nascent ammonia thus evolved at the negative electrode produces an alkaline reaction, which effects the precipitation of the solid suspended matter, while at the positive pole nascent oxygen and chlorine are evolved, producing an acid reaction, whereby the organic impurities held in suspension or solution are readily decomposed and purified.

This system has been tested on a large scale, both at Crossness and at Salford. The amount of sludge formed is said to be smaller than in any precipitation process, and the effluent so pure as not to require further treatment by filtration. The process has been reported on in the most favourable manner, as regards the chemical tests of the effluent, and the ease and uniformity with which the results are obtained.

Mr. Hermite's system consists in the treatment of sea water or other chloride solutions by electrolysis. The water thus electrolysed in reservoirs is conducted as a disinfecting liquid by suitable pipes to places requiring disinfection, where it is stored in cisterns and used in place of ordinary water. The system has been experimentally tested at Havre, Lorient, Brest, and Nice, and has been reported upon most favourably in every case. It is now being tried at Worthing, where an installation has been set up under the auspices of the Mayor and corporation. As in the previous system, an oxygenated compound of chlorine is held to be produced, which burns up the sewage matter, and absolutely destroys all microbes.

Several questions have to be considered from a scientific and practical point of view, in connection with both these inventions, before their general application can be effected. The scientific view of the subject, after all, resolves itself into the answer to a single question: Is the process quite trustworthy to remove the maximum of organic matter from the sewage, and thoroughly sterilise it? As regards the practical point of view, the removal and utilisation of the sludge will have to be faced, in the first process referred to; whilst in the second, in which sludge is said not to be produced, a second water supply to houses, and the chemical action of this disinfecting water upon the pipes, tubes, and reservoirs through which it has to pass, will have to be very fully considered before the system can be adopted.

### ON HOMOGENEOUS DIVISION OF SPACE.<sup>1</sup>

#### II.

§ 10. NOW, suppose any one pair of the tetrahedrons to be taken away from their positions in the primitive parallelepiped, and, by purely translational motion, to be brought into position with their edges of length  $QB$  coincident, and the same to be done for each of the other two pairs. The sum of the six angles at the coincident edges being two right angles, the plane faces at the common edge will fit together, and the condition of parallelism in the motion of each pair fixes the order in which the three pairs come together in the new position, and shows us that in this position the three pairs form a parallelepiped essentially different from the primitive parallelepiped, provided that, for simplicity in our present considerations, we suppose each tetrahedron to be wholly scalene, that is to say, the seven lengths found amongst the edges to be all unequal. Next shift the tetrahedrons to bring the edges  $QE$  into coincidence, and next again to bring the edges  $QF$  into coincidence. Thus, including the primitive parallelepiped, we can make four different parallelepipeds in each of which six of the tetrahedrons have a common edge.

§ 11. Now take the two pairs of tetrahedrons having edges of length equal to  $QA$ , and put them together with these edges coincident. Thus we have a scalene octahedron. The remaining pair of tetrahedrons placed on a pair of its parallel faces complete a parallelepiped. Similarly two other parallelepipeds may be made by putting together the pairs that have edges of lengths equal to  $QB$  and  $QC$  respectively with those edges coincident, and finishing in each case with the remaining pair of tetrahedrons. The three parallelepipeds thus found are essentially different from one another, and from the four of § 10; and thus we have the seven parallelepipeds fulfilling the statement of § 9. Each of the seven parallelepipeds corresponds to one and the same homogeneous distribution of points.

§ 12. Going back to § 4, we see that, by the rule there given, we find four different ways of passing to the tetrakaidekahedron from any one chosen parallelepiped of a homogeneous assemblage. The four different cellular systems thus found involve four different sets of seven pairs of neighbours for each point. In each of these there are four pairs of neighbours in rows parallel to the three quartets of edges of the parallelepiped and to the chosen body-diagonal; and the other three pairs of neighbours are in three rows parallel to the face-diagonals which meet in the chosen body-diagonal. The second (§ 11) of the two modes of putting together tetrahedrons to form a parallelepiped which we have been considering suggests a second mode of dividing our primitive parallelepiped, in which we should first truncate two opposite corners and then divide the octahedron which is left, by two planes through one or other of its three diagonals. The six tetrahedrons obtained by any one of the twelve ways of effecting this second mode of division give, by their twenty-four corners, the twenty-four corners of a space-filling tetrakaidekahedron cell, by which our fundamental problem is solved. But every solution thus obtainable is clearly obtainable by the simpler rule of § 4, commencing with some one of the infinite number of primitive parallelepipeds which we may take as representative of any homogeneous distribution of points.

§ 13. The communication is illustrated by a model showing the six tetrahedrons derived by the rule 4 from a symmetrical kind of primitive parallelepiped, being a rhombohedron of which the axial-diagonal is equal in length to each of the edges. The homogeneous distribution of points corresponding to this form of parallelepiped is the well-known one in which every point is surrounded by eight others at the corners of a cube of which it is the centre; or, if we like to look at it so, two simple cubical distributions of single points, each point of one distribution being at the centre of a cube of points of the other. To understand the tactics of the single homogeneous assemblage constituted by these two cubic assemblages, let  $P$  be a point of one of the cubic assemblages, and  $Q$  any one of its four nearest neighbours of the other assemblage.  $Q$  is at the centre of a cube of which  $P$  is at one corner. Let  $PD$ ,  $PE$ ,  $PF$  be three consecutive edges of this cube so that  $A$ ,  $B$ ,  $C$  are points of the first assemblage nearest to  $P$ . Again  $Q$  is a corner of a cube of which  $P$  is the centre; and if  $QA$ ,  $QB$ ,  $QC$  are three consecutive edges of this cube,  $D$ ,  $E$ ,  $F$  are points of the second assemblage

<sup>1</sup> A paper read before the Royal Society on January 18, by Lord Kelvin, P.R.S. (Continued from p. 443.)

nearest to Q. The rhombohedron of which PQ is body-diagonal and PA, PB, PC the edges conterminous in P, and QD, QE, QF

they would be in the primitive parallelepiped, or farther and farther out from one another so as to give, by the four corners of the tetrahedrons, the twenty-four corners of all possible configurations of the plane-faced space-filling tetrakaidekahedron.

§ 15. The six skeletons being symmetrically arranged around an axial line we see that each arm is cut by lines of other skeletons in three points. For an important configuration, let the skeletons be separated out from the axial line just so far that each arm is divided into four equal parts, by those three intersectional points. The tetrakaidekahedron of which the twenty-four corners are the corners of the tetrahedrons thus placed may conveniently be called the orthic tetrakaidekahedron. It has six equal square faces and eight equal equiangular and equilateral hexagonal faces. It was described in § 12 of my paper on "The Division of Space with Minimum Partitional Area" (*Philosophical Magazine* 1887, second half year, and *Acta Mathematica*, vol. xi. pp. 121-124), under the name of "plane-faced isotropic tetrakaidekahedron"; but I now prefer to call it orthic, because, for each of its seven pairs of parallel faces, lines forming corresponding points in the two faces are perpendicular to the faces, and the planes of its three pairs of square faces are perpendicular to one another. Fig. 8 represents an orthogonal projection on a plane parallel to one of the four pairs of hexagonal faces. The heavy lines are edges of the tetrakaidekahedron. The light lines are edges of the tetrahedrons of § 13, or parts of those edges not coincident in projection with the edges of the tetrakaidekahedron. The figures 1, 1, 1; 2, 2, 2; . . . ; 6, 6, 6 show corners belonging respectively to the six tetrahedrons, two of the four corners of each being projected on one point in the diagram. Fig. 9 shows, on the same scale of magnitude with corresponding distinction between heavy and

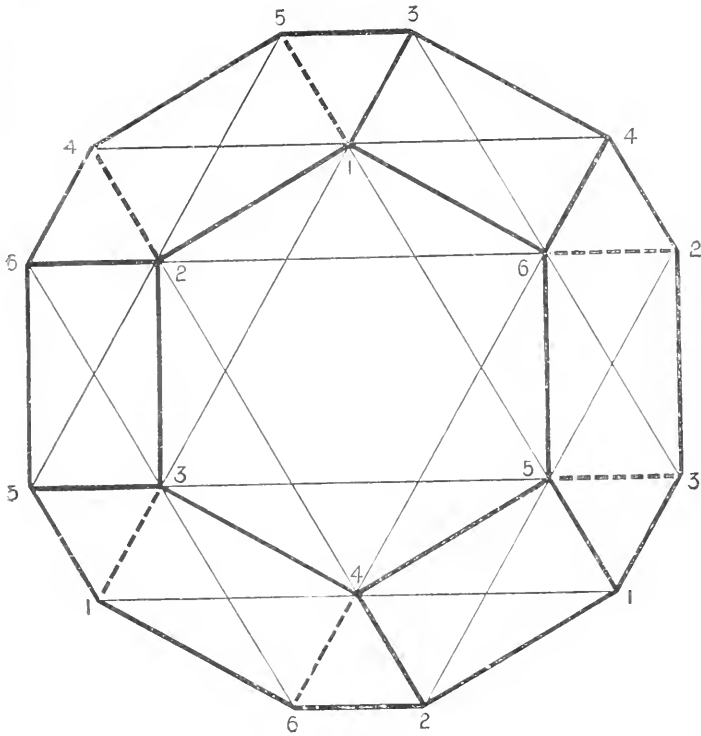

FIG. 8.

the edges conterminous in Q, is our present rhombohedron. The diagram of § 9 (Fig. 7, imagined to be altered to proportions for the present case, may be looked to for illustration. Its three face-diagonals through P, being PD, PE, PF, are perpendicular to one another. So also are QA, QB, QC, its three face-diagonals through Q. The body-diagonal of the cube PQ, being half the body diagonal of the cube whose edges are PD, PE, PF, is equal to  $PD \times \frac{1}{2} \sqrt{3}$ ; and PA, PB, PC are also each of them equal to this, because A, B, C are centres of other equal cubes, having P for a common corner.

§ 14. The tetrahedrons used in the model are those into which the parallelepiped is cut by three planes through the axial diagonal, which in this case cut one another at angles of  $60^\circ$ . We wish to be able to shift the tetrahedrons into positions corresponding to those of the triangles in Fig. 1, which we could not do if they were cut out of the solid. I, therefore, make a mere skeleton of each tetrahedron, consisting of a piece of wire bent at two points, one-third of its length from its ends, at angles of  $70\frac{1}{2}^\circ$ , being  $\sin^{-1} \frac{1}{2} \sqrt{3}$ , in planes inclined at  $60^\circ$  to one another. The six skeletons thus made are equal and similar, three homochirals and the other three also homochirals, their enantiomorphs. In their places in the primitive parallelepiped they have their middle lines coincident in its axial diagonal PQ, and their other  $6 \times 2$  arms coincident in three pairs of its six edges through P and Q. Looking at Fig. 7 we see, for example, three of the edges CP, PQ, QE, of one of the tetrahedrons thus constituted; and DQ, QP, PE, three edges of its enantiomorph. In the model they are put together with their middle lines at equal distances around the axial diagonal and their arms symmetrically arranged round it. Wherever two lines cross they are tied, not very tightly, together by thin cord many times round, and thus we can slip them along so as to bring the six middle lines either very close together, nearly as

light lines, the orthogonal projection on a plane parallel to a pair of square faces.

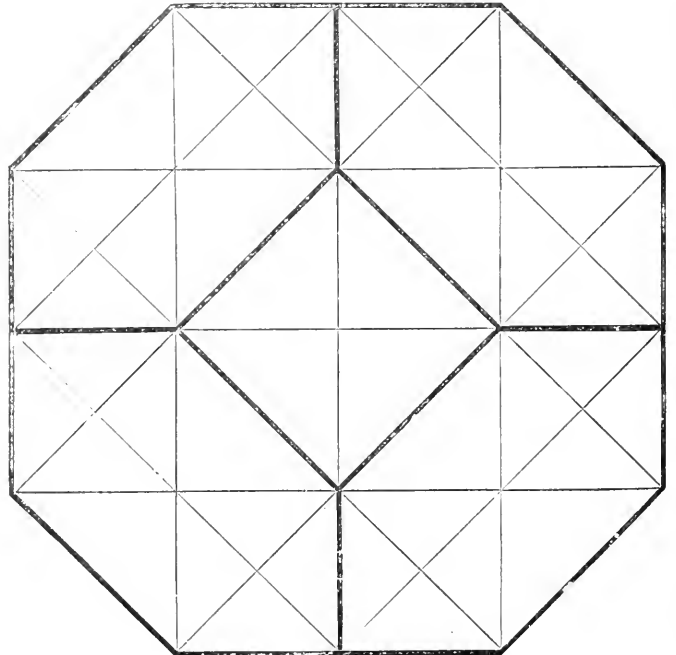

FIG. 9.

§ 16. If the rule of § 15 with reference to the division of each arm of a skeleton tetrahedron into four equal parts by points in

which it is cut by other lines of skeletons is fulfilled with all details of §§ 14 and 15 applied to any oblique parallelepiped, we find a tetrakaidekahedron which we may call orthoid, because it is an orthic tetrakaidekahedron, altered by homogeneous strain. Prof. Crum Brown has kindly made for me the beautiful model of an orthoidal tetrakaidekahedron thus defined which is placed before the Royal Society as an illustration of the present communication.

Fig. 10 is a stereoscopic picture of an orthic tetrakaidekahedron, made by soldering together thirty-six pieces of wire,

the practical teaching of my class conducted, and the physiological work carried on." So that the interval between the first and 500th meetings of the Science Club represents an important epoch in the history of the Cambridge Science School, and gives to the conversazione a special interest.

Although the aggregate number of members in the club during these twenty two years only slightly exceeds 150, it may be observed that this number includes sixteen Fellows of the Royal Society and eighteen Professors holding Chairs in British and colonial universities and colleges. In addition to these a

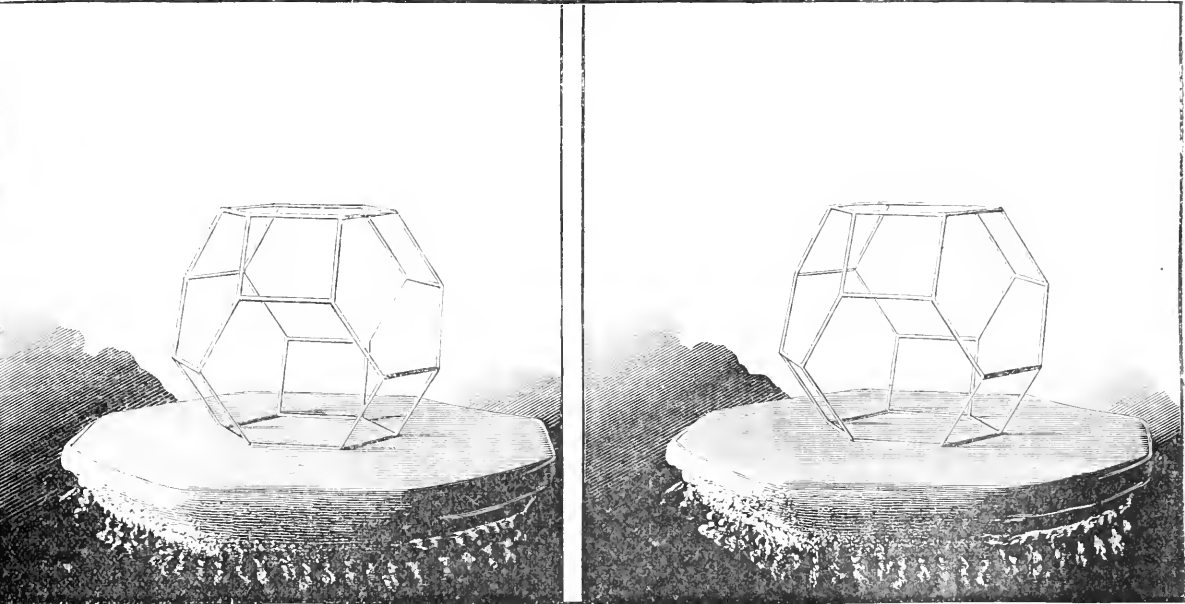

FIG. 10.

each 4 in. long, with three ends of wire at each of twenty-four corners.

§ 17. I cannot in the present communication enter upon the most general possible plane-faced partitional tetrakaidekahedron or show its relation to orthic and orthoidal tetrakaidekahedrons. I may merely say that the analogy in the homogeneous division of a plane is this:—an equilateral and equiangular hexagon (orthic); any other hexagon of three pairs of equal and parallel sides whose paracentric diagonals trisect one another (orthoidal). The angles of an orthoidal hexagon, other than equilateral, are not  $120^\circ$ . The angles of the left-hand hexagon Fig. 1 (§ 7) are  $120^\circ$ , and its paracentric diagonals do not trisect one another, as the diagram clearly shows.

UNIVERSITY AND EDUCATIONAL INTELLIGENCE.

CAMBRIDGE.—The Cambridge University Natural Science Club celebrated its 500th meeting by a conversazione in the University Physiological Laboratory on March 12. This club was an early outcome of the development of natural science in the University, being founded on March 10, 1872. Its members are drawn from the senior science students in the University. Among the original members (nine in number) may be mentioned Dr. H. Newell-Martin, Prof. Liversidge (now at Sydney), and the late Dr. P. H. Carpenter. At one of the earliest meetings the late Prof. F. M. Balfour was elected. Two years later saw Prof. S. H. Vines and the late Prof. Milnes Marshall added to the list of members. It is interesting to note that the first volume of "Studies from the Physiological Laboratory, Cambridge," published in 1873, contained contributions from four of the original members of the club. At that time this laboratory, which is now large enough to accommodate easily a large conversazione, consisted (in the words of Prof. M. Foster) of "two rooms in which my lectures are given,

considerable number of university and college lecturers have belonged to its membership during their student days, so that the club may fairly claim to have borne its part in the scientific teaching of the day.

The conversazione of the club, held on Monday, was attended by about 600 persons, including a considerable number of eminent men of science, both British and Continental. The Physiological Laboratory was gaily decorated for the occasion, and many exhibits in the different branches were on view. Prof. Ramon y Cajal kindly showed specimens illustrating the histology of the central nervous system. The Botanical Department included exhibits by Mr. F. Darwin, F.R.S., and Mr. W. Gardiner, F.R.S.; demonstrations in electricity were given by Prof. J. J. Thomson, F.R.S. One large room was devoted to the exhibition of scientific instruments and machines in motion, among which we might mention engineering apparatus, shown by Prof. Ewing, and Callendar's new pyrometer, by the Cambridge Scientific Instrument Company. Chemistry, geology, physiology, and pathology were also well represented. The Anatomical Museum was occupied by the Ethnological Department, under the direction of Prof. MacAlister, Mr. Hickson, Prof. A. C. Haddon, and Baron von Hügel. A great feature of the evening was in the lecture theatre, where Dr. A. R. Wallace, F.R.S., delivered a polemic on "Geographical Distribution," while Prof. C. V. Boys, F.R.S., lectured on "The Photography of Flying Bullets," and Mr. Martin Conway on his recent travels in high altitudes among the Himalayas.

Dr. Donald MacAlister, Fellow and Tutor of St. John's College, has been appointed Linacre Reader of Physic, in succession to Dr. Bradbury, the new Downing Professor of Medicine. Dr. MacAlister was Senior Wrangler and First Smith's Prizeman in 1877.

Prof. Foster has been appointed a delegate to represent the University at the eleventh International Medical Congress to be held this month in Rome.

Dr. Anderson, Medical Officer of Health for Cambridge,

and Dr. D. MacAlister, Assessor to the Regius Professor of Physic, have been appointed to represent the University at the International Congress of Hygiene and Demography to be held in September next in Budapest.

Mr. F. Darwin has been appointed an Elector to the Professorship of Botany, Prof. Ray Lankester an Elector to the Professorship of Zoology, Dr. G. J. Hinde an Elector to the Professorship of Geology, and the Rt. Hon. T. H. Huxley an Elector to the Professorship of Physiology, for the next eight years.

Mr. E. H. Douty, of King's College, has been appointed University Lecturer in Midwifery, in the room of Dr. Walter Griffith.

THE Senatus of Aberdeen University has conferred the honorary degree of LL.D. on Mr. Henry O. Forbes, recently appointed director of Liverpool museum.

THE Senatus of the University of Edinburgh has offered the honorary degree of LL.D. to Dr. W. H. Gaskell, F.R.S., Lecturer on Physiology, University of Cambridge; James A. Russell, Lord Provost of Edinburgh; and Dr. George Wilson, Medical Officer of Health, Mid-Warwick.

PROF. W. C. ARNISON and Dr. James Murphy have been selected by the Faculty of Medicine to represent the University of Durham at the forthcoming Medical Congress at Rome.

#### SCIENTIFIC SERIALS.

*L'Anthropologie*, tome iv. No. 5, September-October, 1893. —Dr. E. T. Hamy contributes a paper on the Merovingian and Carolinian crania of the Boulogne district. In the first volume of the *Revue d'Anthropologie*, Broca published a paper on the nasal index, in which he stated that of all European groups whose crania he had measured, the French group of Chelles, Champlieu, &c. was alone *mesorhine*, having a mean nasal index of 48.87, and he concluded that this anatomical peculiarity was derived from a cross with some more or less Mongoloid people previous to their appearance in the West. Dr. Hamy now gives a detailed description of thirty-five crania, twenty male and fifteen female, taken from four Merovingian burial-places in the Boulogne district, and in the second part of the paper he gives a comparative study of the crania, of a later date, exhumed by M. l'Abbé Debout from the mound of Tardinghen; some of them from the surface, and others from graves beneath flagstones, the Merovingian age of the former being clearly indicated by the articles buried with the bodies, and the latter probably belonging to the end of the Carolinian period. A critical examination of these crania leads to the conclusion that the original type of the inhabitants was altered by foreign occupation, and that the elements thus violently introduced were eliminated little by little, and the primitive population, thrown into the shade for a while, gradually regained their supremacy. Undoubtedly there remain on the coast of the Channel, especially on the Pas-de-Calais, many tall and strong men, with fair hair, ruddy complexion, narrow head, and long face, who represent, to some extent at least, with fidelity the Saxons or Franks from whom they are descended, but the brunettes who surround them are more numerous than they, and are gradually absorbing them. To take one example only: in the canton of Marquise, the school population, consisting of 1750 boys and girls, yields 913 subjects with dark hair (of whom 163 have black hair), against 779 blondes (54 of whom have red hair); consequently 52.2 per cent. are dark, and only 47.8 per cent. fair, and as these are for the most part children whose hair has not yet attained its final colour, some of those now classed as blondes will become brunettes as adults. —M. E. Deschamps describes some instances of albinism observed by him at Mahé, on the coast of Malabar, and M. Salomon Reinach contributes the first part of a vigorous attack on "Le Mirage Oriental," in which he argues that credit has been given to the East for a far greater influence upon European civilisation than has really been exercised by it. Mycenaean civilisation is entirely of European origin; it is only orientalised on the surface by contact with the civilisations of Syria and of Egypt. Greece, the Archipelago, and the coast of Asia Minor are the places where, in a remote antiquity, European, Asiatic, and Egyptian in-

fluences mingled. —Dr. P. Topinard continues his memoirs on the distribution of the colour of the eyes and of the hair in France, the subject of the present essay being the chart of red hair. He arrives at the following conclusions: (1) That, as in the British Isles, where red hair is comparatively common, and in Italy, Turkey, and Armenia, where it is seldom met with, so in France it is more commonly found in the middle of the country than elsewhere; (2) that in those French departments in which the blonde type predominates, red hair is twice or three times as frequent as in those inhabited by people with dark hair; (3) that, probably, red haired people are allied exclusively to the blonde type, of which they are a simple normal variety, without any anthropological signification. M. Topinard has consequently reunited the *cheveux blondes* and the *cheveux roux* under the name of *cheveux clairs*.

*Antropologia Generale*. —Lezioni su l'uomo secondo la teoria dell'evoluzione dettate nelle R. Università di Torino e di Genova dal Prof. Enrico Morselli. (Turin, 1894). —In the thirty-fourth part of this valuable work, Prof. Morselli treats of certain cases of atavism, and instances several cases of hypertrichosis, amongst others the Russian Adrian Jęftichjew, who was known as the "human dog," and the celebrated Julia Pastrana, the configuration of whose skull was so much like that of the Neanderthal. Reference is also made to steatopygia and the "Hottentot apron." The prehensile power sometimes met with in the human foot is discussed, and shown to be perfectly homologous with that of the hind hand of the ape.

#### SOCIETIES AND ACADEMIES.

LONDON.

Royal Society, February 1. —"Insect Sight and the Defining Power of Composite Eyes." By A. Mallock.

The optical arrangement of the simple eyes of vertebrates is well understood, but as regards the action of the composite eyes of insects and crustacea less certainty has hitherto prevailed.

In the former class of eye a single lens, or its equivalent, forms an image on a concave retina, built up, as a sort of tessellated pavement, of the sensitive terminations of the fibres of the optic nerve, and, if the lens is perfect and the pupil large enough, the definition is limited by the distance apart of the nerve-terminations, for, in order that two objects may appear as two to the eye, they must subtend at least such an angle that their images as formed by the lens shall not fall on the same nerve-termination.

In the human eye the distance between the sensitive points on the retina is such that it subtends about a minute of arc at the optic centre of the lens, and in good eyes the optical part of the apparatus is sufficiently perfect to allow of this degree of definition being attained over a small part of the field of view.

For reasons, however, which will be given presently, such definition as this is not to be looked for in composite eyes.

The general plan on which all composite eyes are constructed is that of a convex retina having a separate small lens in front of each sensitive part, together with an arrangement of screens which allows only that light coming from the immediate neighbourhood of the axis of the lens to reach the nerve.

The theory of "mosaic vision" put forward by Johannes Müller has been opposed by some physiologists who appear to have considered that each lens of a composite eye formed a complete image which was taken cognisance of by the nerves as in the vertebrate eye, and that the whole of these images were in some way added together and arranged by the brain. I here bring forward some optical reasons which show that Müller's view is the true one.

On the supposition, therefore, of "one lens, one impression," the definition obtained by a composite eye will be measured by the total solid angle of view ÷ whole number of lenses in the eye.

The simplest form of composite eye would be a spherical shell, AB, Fig. 1, perforated with radial holes,  $c, c, c$ , the diameter of these holes being small compared with the thickness of the shell.

If sensitive paper were placed in contact with the inner surface of the shell, it would be impressed with a picture of surrounding objects, for the light which reaches the bottom of any hole is limited to that making an angle less than  $\frac{1}{2}$  DEF with the

axis of the hole, which angle is of course equal to the diameter of the hole  $\div$  half its length.

It is interesting to see what proportions would have to be given to an eye of this kind if the definition is to be as good as that of the human eye.

The limit of definition in this case being 1 min., the holes would have to be 7000 diameters long (since 1 min. is nearly

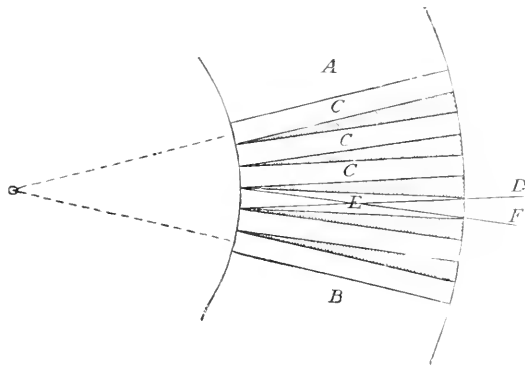

FIG. 1.

1/3500), and in order that diffraction may not interfere materially with the result,<sup>1</sup> the diameter of the holes should not be less than 2000 wave-lengths of light, say  $\frac{1}{27}$  in. Hence the thickness of the shell will be  $7000 \cdot \frac{1}{27}$  in., or 23 ft.

The radius of the sphere may be determined by the condition that, if the picture is to be continuous, the adjacent holes must just be in contact at the internal surface of the shell, that is to say, the diameter of the hole, viz.  $\frac{1}{27}$  in., must subtend 1 min. at the internal radius of the shell, which makes this radius therefore 11 ft. 6 in.

Thus an eye of this construction and power of definition would consist of some part of a spherical shell of 34 ft. 6 ins. external radius, and 23 ft. thick, perforated with radial holes  $\frac{1}{27}$  in. in diameter, and with their centres about  $\frac{1}{2}$  apart on the external surface.

If still keeping 1 min. as the limit of definition, we substitute the arrangement actually found in composite eyes, and in place of the long tunnels in thick shell, we use short tunnels with a lens at the outer end of each tunnel, and a diaphragm at the inner end, pierced with a small central hole (Fig. 2), the pro-

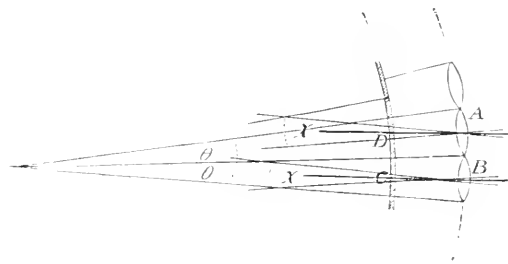

FIG. 2.

portions of the eye will be determined in the first place by the diameter of the lens which will just define 1 min., and secondly by making that diameter subtend 1 min. at the centre of the sphere.

Now the size of the image of a point formed by a lens (as seen from the optic centre of the lens) is inversely as the diameter of the lens, and it takes a lens 4 ins. in diameter to define 1 second, i.e. to separate points 1" apart; hence the lens which will just define 1 min. is  $\frac{1}{30}$  or 0.066 in. in diameter.

<sup>1</sup> It may be shown that the hole should not be much smaller than the first Huyghens zone of a system for which, if  $\lambda/r = r/R$ ,  $R$  = the length of the hole,  $\lambda$  and  $r$  being the wave-length of light and the radius of the zone respectively. How much less than  $r$  the diameter of the hole may be is, to some extent, a matter of judgment depending on the degree to which it is considered desirable to reduce the intensity of the diffracted light.

The radius at which 0.066 in. subtends 1 min. is about 19 ft. It is evident, therefore, that no composite eye of practicable dimensions, acting as supposed above, could be made to give definition even approaching that of the human eye.

If the diameter of the lenses is reduced, not only is the size of the sphere on which a given number of them would lie reduced, but, since the definition of each lens decreases with the diameter, a less number of lenses will be required to give the maximum definition attainable under the changed circumstances. Thus the radius of the sphere proper for the surface of a composite eye decreases as the square of the defining power of the separate lenses of which it is composed.

Let A and B (Fig. 2) be two adjacent lenses, C and D the sensitive spots of the retina. Let  $\theta$  be the angle between the axes of A and B, and  $\chi$  the limit of definition of the lens. Then, if  $\chi = \theta$ , the image of a distant object in the axis of A will just all clear of the sensitive point D, but if  $\chi < \theta$ , both C and D will be illuminated by light from the same object.

Supposing, however,  $\chi$  is less than  $\theta$ , nothing will be gained in definition unless each lens has more than one sensitive point to operate on. If, then, we find that in actual composite eyes  $\chi$  and  $\theta$  are nearly equal, that is, that the difference in the direction in which the adjacent lenses point is nearly equal to the defining power of the lens itself, it becomes almost certain that each lens has only one sensitive point behind it.

The following table contains measures, recently made by me, of the diameters and angles between the axes of the lenses of various insect eyes, and although the measure of the angle of view was necessarily rather rough, the agreement of the results, in the larger number of cases, with the supposition above, made seems to me sufficiently remarkable.

In estimating  $\theta$  there were two difficulties, one of which was that in many eyes the curvature of the surface was sharp at the margin and that the definition was probably bad there, and another that the line of sight of each lens was not always normal to the outer surface of the eye (Fig. 3). Generally I took the

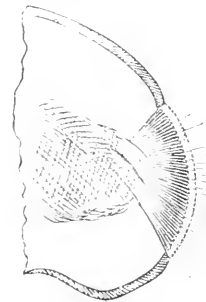

FIG. 3.

angle between the tangents to the surface at the ends of a measured chord, choosing the chord so that the surface outside it should have fairly uniform curvature. The length of the chord was usually about three-quarters, or a little more, of that of the eye.

Taking the length of the chord as  $l$ , and  $r$  as radius of the sphere which best represents the surface of the eye, we have for the angle of view  $\Theta$ ,

$$\sin \frac{1}{2}\Theta = l/2r,$$

and  $\theta = d/r$ , where  $d$  is the diameter of the lens

hence 
$$\theta = d/b \cdot 2 \sin \frac{1}{2}\Theta$$

The other columns of the table explain themselves.

On the whole, I think it must be concluded that insects do not see well, at any rate as regards their power of defining distant objects, and their behaviour certainly favours this view; but they have an advantage over simple-eyed animals in the fact that there is hardly any practical limit to the nearness of the objects they can examine. With the composite eye, indeed, the closer the object the better the sight, for the greater will be the number of lenses employed to produce the impression; whereas in the simple eye the focal length of the lens limits the distance at which a distinct view can be obtained.

The best of the eyes mentioned in the table would give a picture about as good as if executed in rather coarse wool-work and viewed at a distance of a foot; and, although a distant

landscape could only be indifferently represented on such a coarse-grained structure, it would do very well for things near enough to occupy a considerable part of the field of view.

| Species.                                       | Length of body. | Greatest dimension of eye. | Diameter of aperture of eyelet.                  | Angle between axes of adjacent eyelets in minutes. | Defining power of lens of diameter $d$ in minutes. |
|------------------------------------------------|-----------------|----------------------------|--------------------------------------------------|----------------------------------------------------|----------------------------------------------------|
| Diptera—                                       |                 |                            |                                                  |                                                    |                                                    |
| 1. Fly like a bee, <i>Eristalis</i> ...        | 0'60            | 0'108                      | 0'0012                                           | 56                                                 | 55                                                 |
| 2. Fly like a wasp, <i>Sericomyia</i> ...      | 0'70            | 0'12                       | 0'0016                                           | 48                                                 | 71                                                 |
| 3. Blow-fly, <i>Lucilla</i> ...                | 0'34            | 0'07                       | 0'0018                                           | 84                                                 | 35                                                 |
| 4. Very small flies, species not identified    | 0'20            | 0'026                      | 0'00076                                          | 126                                                | 87                                                 |
| 5. Ditto ...                                   | 0'13            | 0'021                      | 0'0005                                           | 105                                                | 113                                                |
| Hymenoptera—                                   |                 |                            |                                                  |                                                    |                                                    |
| 6. Hornet ...                                  | 1'0             | 0'152                      | 0'0014                                           | 53                                                 | 48                                                 |
| 7. Wasp ...                                    | 0'7             | 0'088                      | 0'0011                                           | 84                                                 | 60                                                 |
| 8. Bee ...                                     | 0'6             | 0'100                      | 0'00072                                          | 50                                                 | 90                                                 |
| 9. <i>Chrysis</i> , scarlet and blue ...       | 0'4             | 0'045                      | 0'00094                                          | 105                                                | 70                                                 |
| Lepidoptera—                                   |                 |                            |                                                  |                                                    |                                                    |
| 10. Small cabbage white ...                    | 0'8             | 0'059                      | 0'00072                                          | 86                                                 | 90                                                 |
| 11. Red admiral ...                            | 1'0             | 0'072                      | 0'00095                                          | 76                                                 | 69                                                 |
| 12. Small copper ...                           | 0'5             | 0'050                      | 0'00071                                          | 100                                                | 93                                                 |
| 13. Yellow under wing ...                      | 0'75            | 0'064                      | 0'00092                                          | 70                                                 | 72                                                 |
| 14. <i>Noctua</i> ...                          | 0'7             | 0'060                      | 0'00090                                          | 70                                                 | 74                                                 |
| Dragon-flies—                                  |                 |                            |                                                  |                                                    |                                                    |
| 15. Large dragon-fly, <i>Eschna cyanea</i> ... | 3'5             | 0'282                      | Large lenses<br>0'0023<br>Small lenses<br>0'0016 | 48                                                 | 41                                                 |
| 16. <i>Libellula striolata</i> ...             | 2'5             | 0'191                      | Large lenses<br>0'0027<br>Small lenses<br>0'0015 | 50                                                 | 45                                                 |
| 17. Green grass-hopper ...                     | 1'1             | 0'057                      | 0'0011                                           | 80                                                 | 60                                                 |
| 18. <i>Tipula</i> ...                          | 1'0             | 0'027                      | 0'00095                                          | 200                                                | 70                                                 |

out that this variety was described and figured by the late John Hancock in his "Catalogue of the Birds of Northumberland," where it had been met with more than twenty years ago, and in which county he himself had also procured a specimen at Corbridge-on-Tyne, which was preserved in the collection of varieties formed by the late Mr. F. Bond.—Mr. Norman Douglass exhibited a black variety of the water-vole, *Arvicola amphibius*, captured at Banchory, Kincardineshire; remarking that this variety, which was at one time considered to be restricted to Scotland, had been met with in several English counties (*Zoologist*, 1892, pp. 281-293) and was well established in the fen country of Norfolk and Cambridgeshire.—Mr. George Brebner read a paper on the origin of the filamentous thallus of *Dumontia filiformis*, in which, by the aid of the oxy-hydrogen lantern, he demonstrated (1) that *D. filiformis* has a creeping basal thallus by which it adheres to the substratum; (2) that the creeping thallus is perennial, and when epiphytic is attached to its host by plugs of tissue which cause marked disintegration of the cells of the host; (3) that the ordinary filiform thallus owes its origin to the intercalary transverse septation of the articulations of certain branches of the creeping thallus. The group of active filaments may be endogenous or exogenous, and the order in which the rows of cells became specialised is generally centrifugal; (4) these specialised out-growths emerge from the creeping thallus—remaining attached to it by the basal portion—and by the subsequent growth and division of the constituent filaments give rise to the annual well known *D. filiformis* thallus. The paper, which was listened to with great interest, was criticised by Dr. D. H. Scott, Mr. George Murray, and others.—On behalf of Mr. D. J. Scourfield, a paper was communicated by Prof. Miall, on Entomostraca and the surface-film of water. Briefly summarised, the principal views advanced in this paper were the following: (1) To many Entomostraca the surface film of water is a very dangerous element in their environment; to this category belong large numbers of the Cladocera and Ostracoda; (2) to some other Entomostraca, conversely, the surface film affords peculiar advantages. This class includes, so far as yet known, only a few specially modified Cladocera and Ostracoda, and some Copepods, which do not, however, present any apparent structural modifications; (3) in all cases (except where some Copepods possibly make use of the properties of the surface-film to attach themselves to aquatic plants above the general water-level) the relation to the surface-film, whether beneficial or the reverse, depends fundamentally upon the same physical principles, namely, the upward pull of the surface-film when forming a capillary depression, and the possession by the animals of water-repellent shells, ridges, scales, or setæ, capable of penetrating the surface-film, and producing capillary depressions.

Geological Society, Feb. 21.—Dr. H. Woodward, F.R.S. President, in the chair.—The following communications were read:—On the relations of the basic and acid rocks of the Tertiary volcanic series of the Inner Hebrides, by Sir Archibald Geikie, F.R.S. After an introductory sketch of his connection with the investigation of the Tertiary volcanic rocks of Britain, the author proceeded to describe the structure of the ground at the head of Glen Sligachan, Skye, which had recently been cited by Prof. Judd as affording inclusions of Tertiary granite in the gabbro, and as thus demonstrating that the latter was the younger rock. He first showed that the gabbro, instead of being one eruptive mass, consisted of numerous thin beds and sills of different varieties of gabbro, some of which were injected into the others. These various sheets, often admirably banded, were seen to be truncated by the line of junction with the great granophyre-tract of Glen Sligachan. A large mass of coarse agglomerate was likewise cut off along the same line. These structures were entirely opposed to the idea of the gabbro being an eruptive mass which had broken through the granophyre. They could only be accounted for, either by a fault which had brought the two rocks together, or by the acid rock having disrupted the basic. But there was ample evidence that no fault occurred at the boundary-line. The granophyre became fine-grained, felsitic, and spherulitic along its margin, where it abutted against the complex mass of basic rocks. These structures continued altogether independent of the varying distribution of the gabbros, and were seen even where the granophyre ran along the side of the agglomerate. Similar structures were of common occurrence along the margins of the granophyre-bosses and sills of the Inner Hebrides, being found not only next the gabbro, but next the Jurassic sand-

Linnean Society, February 15.—Prof. Stewart, President, in the chair.—Dr. Maxwell Masters exhibited a remarkably good specimen of *Peziza tuberosa* on root of *Anemone*. It is only comparatively recently that the hard lumps (sclerotia) in the soil of anemone beds have been definitely associated with the fruit of this *Peziza*; at one time the sclerotia were regarded as diseased masses of the root-stock. Dr. Masters also exhibited some root-galls on plum caused by *Cynips (Biorhiza) terminalis*. Mr. Cameron, in his monograph on the *Cynipide*, published by the Royal Society, has noticed galls formed by this insect on the beech, pine, and vine, but not on the plum.—Mr. Digby Nicholl exhibited a singular variety of the partridge (*Perdix cinerea*), which had been shot by Mr. A. Waugh, near Creswell, Northumberland, in September 1893. In colour it resembled the red grouse, having the breast and flanks suffused with large patches of dark reddish-brown, and the dorsal plumage very much darker than usual. Mr. Harting pointed

stones and shales. They were familiar phenomena of contact in all parts of the world, and were sufficient of themselves to show that the granophyre of Skye must be later than the gabbro. The author then described three conspicuous dykes, from 8 feet to 10 feet broad, which could be seen proceeding from the main body of granophyre and cutting across the banded gabbros. One of these was traceable for more than 800 feet in a nearly straight line. The material composing these dykes was identical with that constituting the marginal portion of the granophyre-mass. It presented the most exquisite flow-structure, with abundant rows of spherulites. The author exhibited a photograph of one of the dykes ascending vertically through the gabbros. Numerous dykes and veins of the same material, not visibly connected with the main granophyre-mass, traversed the gabbros of the ridge of which Dr. Drum an Eidhne formed a part. Some of these were described, and it was shown that the flow-structure followed the irregularities of the gabbro-walls and swept round enclosed blocks of altered gabbro. The "inclusions" described by Prof. Judd were portions of these dykes and veins. There was not, so far as the author could discover, a single granite-block enclosed in the gabbro anywhere to be seen at this locality. He therefore claimed not only that his original description of the relations of the rocks was perfectly correct, but that the evidence brought forward to contradict it by Prof. Judd furnished the most crushing testimony in its favour. The President said that Sir Archibald Geikie had made out his case so clearly that no one, it might be supposed, could for a moment doubt that the interpretation which he had given was the correct and the only one; nevertheless, he had reason to believe that Prof. Judd had, with careful study, arrived at quite a different view of these same rocks. Prof. Judd criticised the paper at some length, and the author replied to his remarks.—Note on the genus *Naiadites*, as occurring in the coal formation of Nova Scotia, by Sir J. William Dawson, K.C.M.G., F.R.S. With an appendix by Dr. Wheelton Hind. The specimens referred to occur most abundantly in calcareo-bituminous shales along the coast, at the South Joggins, and were described by the author in "Acanthian Geology," in 1860. A collection of them has been submitted to Dr. Wheelton Hind. In *Quart. Journ. Geol. Soc.* vol. xix. Mr. Salter referred the shells described as *Naiadites* to his new genera *Anthracoptera* and *Anthracomya*. In correspondence with Mr. Salter, the author held that the shells were probably freshwater, and objected to the name *Anthracomya* as expressing an incorrect view of the affinity of the shells; he also stated several reasons in support of his opinions. The author continued to use the name *Naiadites*, but did not object to the division of the species into two genera, for one of which Salter's name *Anthracoptera* should be retained. Additional reasons were given for the freshwater origin of these shells. Dr. Wheelton Hind believed that the "genus" *Naiadites* contained three distinct genera, for one of which the name must be retained. He proposed to retain the name for the forms called *Anthracomya*, affirming as this word does an altogether wrong affinity for the genus. (The name *Naiadites* was proposed in 1860; *Anthracomya* in 1861.) Dr. Hind was not able to state that any of the species submitted to him by Sir J. W. Dawson were the same as British forms. The shell originally described as *Naiadites carbonaria* was, he has no doubt, an *Anthracoptera*. He gave notes on *N. arenaria*, *N. angulata*, and *N. hevis*. A discussion followed, in which Prof. J. F. Blake, Dr. W. T. Bianchi, Dr. J. W. Gregory, the President, Prof. T. McKenny Hughes, and Mr. Marr took part.

Entomological Society, February 28.—Colonel Charles Swinhoe, Vice-President, in the chair.—Prof. August Forel, M.D., of the University of Zurich, was elected an Honorary Fellow of the Society, to fill the vacancy caused by the death of Prof. H. A. Hagen, M.D.—Mr. G. C. Champion called attention to a supposed new Longicorn beetle, described and figured by Herr A. F. Nonfried, of Rakonitz, Bohemia, under the name of *Callipogon friedländeri*, in the *Berl. Ent. Zeitschr.* 1892. He said that the supposed characters of the insect were due to the fact that the head had been gummed on upside down! He also exhibited an extensive collection of Coleoptera and Hemiptera-Heteroptera made by himself in the island of Corsica in May and June last.—The Rev. Theodore Wood exhibited a variety of *Saturnia carpinii*, with semi-transparent wings, a large proportion of the scales being apparently absent, bred with several examples of the type-form at Baldock, Herts; also a pale variety of *Smerinthus populi*, which was said

to have been bred, with several similar specimens, from larvae marked with rows of red spots on both sides.—Mr. R. South exhibited a variety of *Argynnis aghia*, approaching the form known as var. *charlotta*, and a variety of *Euchelia jacobae*, in which the crimson costal streak was continued along the outer margin almost to the inner margin, taken at Ringwood, Hants, in 1893; a variety of *Argynnis euphrosyne*, taken in Epping Forest in 1893; and a series of black and other forms of *Papilio padaria*, bred during the present year from a black female captured last spring.—Mr. H. Goss exhibited, for Mr. C. B. Taylor, of Jamaica, a beautifully coloured drawing of the larva of *Papilio homerus*.—Mr. F. W. Frohawk exhibited drawings showing the complete life-history of *Argynnis aghia* and *A. adippe*, every stage being figured; also enlarged drawings of the segments of the larvæ in their first and last stages, showing the remarkable difference in structure.—Mr. G. C. Champion read a paper entitled "On the *Tenebrionidae* collected in Australia and Tasmania by Mr. J. J. Walker, R.N., during the voyage of H.M.S. *Porpoise*, with descriptions of new genera and species." Mr. J. J. Walker and Colonel Swinhoe made some remarks on the paper.—Mr. Champion also read a paper entitled "An Entomological Excursion to Corsica," in which he described an expedition to the mountains of that island in June, 1893, in company with Mr. Stanton, Colonel Verbury, R.A., Mr. Lemann, Mr. Raïne, and others. Mr. Osbert Salvin, F.R.S., Colonel Verbury, and Colonel Swinhoe took part in the discussion which ensued.—Mr. Edward Saunders communicated a paper entitled "A List of Hemiptera-Heteroptera collected by Mr. Champion in Corsica, with a description of one new species."—Mr. W. F. Kirby read a paper entitled "Notes on *Dorydium westwoodii*, Buchanan-White, with observations on the use of the name *Dorydium*."—Mr. Charles B. Taylor communicated a paper entitled "Description of the larva and pupa of *Papilio homerus*, Fab."

Zoological Society, March 6.—Dr. A. Günther, F.R.S., Vice-President, in the chair.—The Secretary read a report on the additions that had been made to the Society's menagerie during the month of February 1894.—Mr. W. Bateson exhibited and made remarks on a series of pilchards, the scales of which presented some remarkable variations. Mr. Bateson also gave an account of an abnormally coloured brill.—Dr. J. W. Gregory gave an account of the factors that appear to have influenced zoological distribution in East Africa, and made some suggestions as to how the present anomalies of animal life in that part of the continent might be accounted for. Dr. Gregory also exhibited and made remarks on a series of lantern-slides illustrative of his recent journey to Mount Kenya.—A communication was read from Prof. F. Jeffrey Bell, containing an account of examples of three species of river-crab of the genus *Thelphusa* from different districts of East Africa.—Mr. W. H. Adams read some notes on the habits of the flying squirrels of the Gold Coast belonging to the genus *Anomalurus*.—Mr. W. Bateson gave an account of two cases of colour-variation in flat-fishes, illustrative of the principles of symmetry.—A communication from Prof. P. R. Uhler, of Vienna, contained an account of the Hemiptera-Heteroptera of Grenada, West Indies, based on specimens submitted to his examination by the committee for the exploration of the West Indies.—A communication was read from Mr. W. Schaus, containing descriptions of a large number of new species of moths from Tropical America.

## PARIS.

Academy of Sciences, March 5.—M. Leay in the chair.—Account of the scientific career of Admiral Mouchez, by M. O. Callanireau.—On Laplace's series, by M. H. Poincaré.—Preparation of a crystallised calcium carbide by means of the electric furnace; properties of this new body, by M. Henri Moissan. Pure lime is reduced by sugar charcoal in the electric furnace,  $\text{CaO} + 3\text{C} = \text{CaC}_2 + \text{CO}$ . The carbide forms a black crystalline mass, of sp. gr. 2.22. It reacts rapidly with water, producing pure acetylene. The properties of this carbide are given in great detail by the author.—Determination of the specific gravity of melted magnesia, by M. Henri Moissan. With a specimen of melted oxide of about 50 grams weight, a sp. gr. 3.654 has been reached.—Actinometric observations made at Montpellier Observatory in 1893, by M. Crova. A comparison of the average heat intensity with that at corresponding periods for the average of the preceding ten years is given, which shows clearly the great increase in the amount of

solar heat reaching the earth's surface during the months May-November.—Geodetical and astronomical survey work in Madagascar, by Father E. Colin.—On the abelian integrals which can be expressed by logarithms, by M. E. Goursat.—On the laws of the errors of situation of a point, by M. Maurice d'Ocagne.—On the distribution of deformations in metals subjected to stresses, by M. L. Hartmann. Several cases are considered, and the selective chemical action of acids on the lines of deformation of metals under the action of applied forces is noticed.—On the absorption of energy by an elastic thread, by M. Lucien de la Rive.—Production of sound in a microphone, under the action of an intermittent thermal radiation, by M. Eugène Semmola.—Experimental study on the expenditure of energy corresponding to the chemical action of light, by M. Georges Lemoine. The results show that in the case of the exothermic mixture of ferric chloride and normal oxalic acid, the ratio between the absorption corresponding to the molecular work and the total absorption does not exceed some ten-thousandths. Light seems to act only as an exciting agent in this reaction.—On exact atomic weights, determined with silver as secondary-standard substance, by M. G. Hinrichs. An abstract of a discussion of some of the results of J. P. Cooke, Dumas, Stas, and others, wherein the author concludes that he has shown reason for regarding the following atomic weights: Cl 35.5, Br 80, I 127, and S 32, as correct if silver be taken as 108.—On alloys of iron and nickel, by M. F. Osmond. The initial temperature of the alloy and its speed of cooling have the same effect on its properties as in the case of irons containing the same carbon percentage, and are not of such importance as in the cases of hard steels and alloys of iron with tungsten and chromium.—Action of bromine on paraxylene, by M. J. Allain Le Canu.—On cinchonifine, by MM. E. Jungfleisch and E. Léger.—On the isomerism of the nitrobenzoic acids, by M. Oechsner de Coninck. A study of the solubilities of these compounds in dilute acetic acid, dilute hydrochloric acid, acetone, methyl alcohol, and 92 per cent. ethyl alcohol. Great similarity is shown between the ortho and meta acids as regards solubility, whereas the solubility of the para acid is much less.—On dibromogallanilide and its triacetyl derivative, by M. P. Cazeneuve.—Researches on the anatomy and development of the male genital armature of lepidoptera, by M. Peytoureau.—On the nervous system of *Dreissensia polymorpha*, by M. Toureng.—On certain active principles in the Papayaceæ, by M. Léon Guignard. The author shows that just as in the case of families nearly related to the Cruciferae botanically, so here in a widely differing family the character and localisation of certain distinctive chemical principles resembles that obtaining in the Cruciferae.—The sexual reproduction of Mucorini, by MM. P. A. Dangeard and Maurice Léger.—Symbiosis of *Heterodera radicolica* with plants cultivated in the Sahara, by MM. Paul Vuillemin and Emile Legrain.—On some minerals of New Caledonia, by M. A. Lacroix.

## AMSTERDAM.

Royal Academy of Sciences, February 24.—Prof. van de Sande Bakhuyzen in the chair.—Mr. Pekelharing commented upon a communication of Dr. Grijns, of Batavia, on the determination of the volume of blood corpuscles. In connection with Eykman's researches on the question whether the sojourn in tropical regions causes an alteration of the blood in Europeans, Dr. Grijns has developed a new method of determining the volume in question, and has also determined the influence upon it of different substances in watery solution. Defibrinated blood was subjected to a whirling motion in small calibrated tubes; the height of the layer of cruor was measured, the serum removed, the cruor mixed with the solution in question, and again whirled. The solution in which the height of the cruor was the same as in the serum, was isotonic. The concentration of the solutions of salt, cane-sugar, milk-sugar, oxalate of sodium, potassium chloride, asparagin, that leave unaltered the volume of the cruor, were really found to be in isotonic relation. Other substances—urea, ammonium-chloride, ammonium-nitrate, glycerine, alcohol—are in no concentration isotonic with the blood corpuscles. Potassium bichromate and corrosive sublimate affect the blood corpuscles considerably in each concentration. On these preliminary results the author has founded a new method for the determination of the volume of the blood corpuscles.—Prof. Bakhuyzen read a paper on the variation of latitude. He showed by discussing series of

observations, made during the last thirty-five years at Greenwich, Washington, Pulkowa, Leyden, Berlin, Potsdam, Strasbourg, and Prague, that a variation in a period of about 430 days, as determined by Mr. Chandler, was manifest; that there was no evidence of a change in the length of the period, and that its most probable value was found to be 430.7 days, while the resulting value for the coefficient was 0".168.—Prof. Bakhuyzen also showed that the tidal observations, made at the Dutch station of Helder in the years 1855–92, indicated a marked variation of the sea-level in the same period with a coefficient of about 8 millimetres. Adopting the theory of Prof. Newcomb, based on the hypothesis that the earth is not absolutely rigid, the two results are in accordance with one another, and they seem to prove that the rigidity of the earth must be about 1.5 times as great as that of steel.

## BOOKS, PAMPHLETS, and SERIALS RECEIVED.

BOOKS.—Ostwald's *Klassiker der Exakten Wissenschaften*, No. 44, 48–51 (Engelmann, Leipzig).—The Country Month by Month: J. A. Owen and Prof. Boulger (Bliss).—The History of Human Marriage: F. Westermarck 2nd edition (Macmillan)—Scottish Land-Names: Sir H. Maxwell (Blackwood).—Aphorisms from the Writings of Herbert Spencer (Chapman and Hall).—Principia Nova Astronomica: Dr. H. Pratt (Williams and Norgate).—Surveying and Surveying Instruments: G. A. T. Middleton (Whittaker).—Grundzüge einer Entwicklungsgeschichte der Pflanzenwelt Mitteleuropas: Dr. A. Schulz (Jena, Fischer).—Elementary Metal Work: C. G. Leland (Whittaker).—Smithsonian Institution Annual Report to July 1891 (Washington).

PAMPHLETS.—Report on the Coal-Measures of Blount Mountain: A. M. Gibson (Montgomery, Alabama).—The Problem of Man Flight: J. Means (Boston).—The Average Elevation of the United States: H. Gannett (Washington).—On the Astigmatism of Rowland's Concave Gratings: Dr. Sirks (Amsterdam, J. Müller).—Di Alcune Esperienze di Radiofonia: E. Semmola (Napoli).

SERIALS.—Seismological Journal of Japan, Vol. 2, 1893 (Yokohama).—Annuaire de Ciencias Naturaes, No. 1 (Porto).—Medical Magazine, March (Southwood).—Illustrated Archeologist, March (C. J. Clark).—Internationales Archiv für Ethnographie, Band vii, Heft 1 (Leiden, Brill).—L'Anthropologie, tome v, No. 1 (Paris, Masson).—Hummel und Erde, March (Berlin, Paetel).—American Journal of Science, March (New Haven).—Journal of the Franklin Institute, March (Philadelphia).—Engineering Magazine, March (New York).—Psychological Review, No. 2 (Macmillan).

## CONTENTS.

PAGE

|                                                                                                    |     |
|----------------------------------------------------------------------------------------------------|-----|
| Tropical Botanic Gardens and their Uses. By J. B. F. . . . .                                       | 453 |
| The Telephone. By Prof. A. Gray . . . . .                                                          | 454 |
| Günther's Bacteriology. By Mrs. Percy Frankland                                                    | 455 |
| Our Book Shelf:—                                                                                   |     |
| Klein: "Lectures on Mathematics" . . . . .                                                         | 456 |
| Hall and Knight: "Elementary Trigonometry" . .                                                     | 456 |
| Letters to the Editor:—                                                                            |     |
| Great Auk's Egg.—Prof. Alfred Newton, F.R.S. .                                                     | 456 |
| The Decomposition of Liquids by Contact with Cellulose.—C. Beadle . . . . .                        | 457 |
| Physiological Psychology and Psycho-physics.—Dr. E. B. Titchener; The Writer of the Note . . . . . | 457 |
| The Last Great Lakes of Africa. (Illustrated.) By H. R. M. . . . .                                 | 457 |
| The Beetles of New Zealand. By W. F. Kirby . . . .                                                 | 459 |
| Notes . . . . .                                                                                    | 459 |
| Our Astronomical Column:—                                                                          |     |
| A New Achromatic Object-glass . . . . .                                                            | 464 |
| Solar Magnetic Influences on Meteorology . . . .                                                   | 464 |
| A New Telescope for Greenwich . . . . .                                                            | 464 |
| Occultation of Spica . . . . .                                                                     | 464 |
| New Nebulae . . . . .                                                                              | 464 |
| The Minute Structure of the Nerve Centres. By Prof. Ramon y Cajal . . . . .                        | 464 |
| On the Irritability of Plants. By Prof. F. Elfvig . . .                                            | 466 |
| The New Iodine Bases. By A. E. Tutton . . . . .                                                    | 467 |
| The Ethnography of the Aran Islands, County Galway . . . . .                                       | 468 |
| Electrical Sanitation . . . . .                                                                    | 469 |
| On Homogeneous Division of Space. II. (Illustrated.) By Lord Kelvin, P.R.S. . . . .                | 469 |
| University and Educational Intelligence . . . . .                                                  | 471 |
| Scientific Serials . . . . .                                                                       | 472 |
| Societies and Academies. (Illustrated.) . . . . .                                                  | 472 |
| Books, Pamphlets, and Serials Received . . . . .                                                   | 476 |



THURSDAY, MARCH 22, 1894.

## THEORY OF FUNCTIONS.

*A Treatise on the Theory of Functions.* By James Harkness, M.A., Associate Professor of Mathematics, Bryn Mawr College, Pa., and Frank Morley, M.A., Professor of Pure Mathematics in Haverford College, Pa. (London and New York: Macmillan and Co., 1893.)

IF evidence were wanted of the recent progress of the study of pure mathematics on English and American soil, none better could be furnished than the appearance on the two sides of the Atlantic, within a short interval, of two important works on the theory of functions of a complex variable. But a few years ago this great modern branch of mathematics was so little known to English-speaking mathematicians that scarcely a trace of its influence could be traced in their writings, and the majority of our text-books were disfigured by incompleteness, and not seldom by positive error arising from ignorance of its principles. Now the English reader has at his disposal two extensive works dealing with the fundamental principles of the theory from all the more important points of view; and also a very useful aid in Cathcart's valuable translation of Harnack's "Elements of the Differential and Integral Calculus." Probably nothing could serve better as an exorcist of the spirit of formalism which has oppressed the English school of mathematicians so heavily, in spite of all the great things that its leaders have done for the science, than the study of the theory of functions. In no other mathematical discipline is the fundamental unity of logic kept so constantly before the student; nowhere else in mathematics is it so clearly made evident that the manifold array of symbols is the clothing, and not the soul of mathematical thought; and nowhere else can we perceive so fully that progress is to be looked for mainly in strengthening our hold upon elementary conceptions, in continual refinement of definition and continual increase of stringency in inference, together with the necessary complement of this, viz. a continual widening of our power of imagining logical possibilities.<sup>1</sup> A single illustration of these general remarks may be cited here, viz. the important part now played in mathematics by the classification of the possible singularities of a function. Although as yet this classification has hardly proceeded beyond the first stage of distinguishing between what Weierstrass has called essential and non-essential singularities, yet the exceeding fruitfulness of the idea is very manifest in every part, not only of the theory itself, but of its applications. In this connection we may remark that anyone who is sceptical as to the value of function-theory, should compare the treatment of the theory of elliptic functions as given in chapter vii. of the treatise now before us, with the older method of dealing with the same subject. He will there find the theorems which used to be for many of us a mere savagery of riotous mathematical formulæ, sitting now

clothed in their right minds—the cultured dependents of a few leading ideas.

Our first impulse, after dipping here and there into the work of Messrs. Harkness and Morley, and recognising its substantial character, was to regret that so much learning and ability had been wasted in a field already covered by the admirable treatise of Forsyth. A more careful reading convinced us that this feeling was a mistake. The subject is wide enough to allow of two independent treatises; and the two works are independent so far as two mathematical works, each partly historical, dealing with the same subject, can be. Like Forsyth, Harkness and Morley are full of valuable references, not only to the great writers and the great memoirs on the subject, but also to the minor writers and to memoirs dealing with points of detail. So much is this the case, that we doubt whether in the matter of history and references the continental student has anything to equal, and certainly he has nothing to surpass, what the English student now possesses in Forsyth, combined with Harkness and Morley.

The more recent work does not, it is true, rival Forsyth in style and width of view. It is constructed more nearly on the model of a continental treatise, not reaching the airy elegance of a French work, but happily avoiding the intolerable prolixity and dulness of too many continental books, where a parade of generality not unfrequently engenders obscurity, or covers a poverty of fruitful ideas. It is inseparable from the nature of the subject that the unskilled reader should at times find passages that seem obscure. In such cases he will find it of great advantage to turn from Forsyth to Harkness and Morley, or from Harkness and Morley to Forsyth. The greater detail in some of the demonstrations in certain parts of the subject which characterises the treatise before us will often be a help to the reader who has run aground in Forsyth. A mere remark which constitutes a full demonstration to a mind properly prepared or naturally sufficiently nimble to receive it, often proves an enigma to another mind not so well "disposed," or, what is worse, is taken after the manner of the patient who, instead of taking his doctor's medicine, swallowed the prescription. If we might advise the beginner, we should say, first read Forsyth rapidly, possibly superficially with judicious omission, in order to get a good idea of the nature and aims of the theory; then proceed to work carefully through Harkness and Morley; and, finally, again read Forsyth carefully; so that the last impressions should be of the "poetry of the subject."

Chapter i. of Harkness and Morley's work is a very elegant and valuable geometric introduction to the subject, containing, besides the usual matter, a number of excellent graphical illustrations of the theory of invariants by means of Argand's diagram. Chapter ii. gives an account of the more recent refinements in the theory of functions of a real variable, in so far as such are necessary for the purpose in hand. In chapter iii. the theory of infinite series is dealt with in sufficient detail, and the reader is thus rapidly introduced to Weierstrass's theory of the analytic function, its continuation, its singular points and lacunary spaces. Chapter iv. deals specially with the algebraic function, its zeros, poles, and branch

<sup>1</sup> It is in this particular that the peculiar originality of Cauchy, Riemann, and Weierstrass, the three great leaders in the theory of functions, has been so conspicuous.

points, the expansions which represent it in the neighbourhood of ordinary and singular points, its cycles, &c. Chapter v., on integration, introduces the fundamental theorems of Cauchy, with their applications to the establishment of the theorems of Weierstrass and Mittag-Leffler regarding the general expressions for functions with assigned singularities. In chapters vi. and ix. we have the substance of Riemann's theory, both direct and inverse. The account of the inverse theory consists largely of an exposition of Schwarz's solution of Dirichlet's problem, on which depends the proof of the existence of "functions of position" on a given Riemannian surface. The applications of the theory are amply illustrated in chapter vii., which contains an admirable sketch, already alluded to, of the Weierstrassian theory of doubly periodic functions; and in chapters viii. and x. on double theta-functions and Abelian integrals.

From this enumeration our mathematical readers will see that Messrs. Harkness and Morley have provided for them an ample and varied bill of fare; and we have no hesitation in saying that the feast is worthy of the bill. We would merely express, in conclusion, our desire to see this pair of authors soon abroad again in another of the many fields that still await the conscientious writer of English mathematical text-books. G. CH.

#### THE CONSTRUCTION OF DRUM ARMATURES AND COMMUTATORS.

*Drum Armatures and Commutators.* By F. M. Weymouth. (London: The Electrician Printing and Publishing Co., 1893.)

**I**N the preface to this book we are told that it is intended as "a useful guide or introduction to those who may ultimately wish to proceed with the mathematical treatment of the subjects," and further, that "the beginner will read these pages during the early period of his training, while he is studying his mathematics, and so may combine the two together at a later and more advanced stage." To such this work can be recommended, for the author has collected a good deal of information, which is well illustrated by woodcuts, showing how different makers have built up their armatures and commutators, thus giving the student a variety of experience in this direction.

In the first three chapters the drum armature is discussed from a general point of view. It is contrasted with that of Gramme, and the generation of electromotive force explained. The distinctive difference between "electromotive force" and "potential difference" might have been at this stage (p. 9) pointed out with greater clearness. For instance, in a direct current dynamo when working on open circuit the "electromotive force" of the machine and the "potential difference" at the brushes are the same in magnitude if no current flows through the armature. But when giving current to the external circuit between the brushes, a difference at once steps in, the "electromotive force" being greater than the "potential difference" by an amount represented by the current into the ohmic resistance of the armature.

In chapter iii. the winding of armatures for heavy currents is discussed generally; then follow some notes on balancing armatures properly.

With regard to an effect of current in the armature, it is stated on p. 30 that when "the field is bored concentric with the axis of the armature, Foucault currents arise principally, if not entirely, when the bars pass under the trailing horns of the pole-pieces, where the induction lines are particularly dense. By 'trailing' horn is meant the last horn of a pole-piece which the bars leave or recede from as they revolve." This statement is not sufficient. Take the case of a shunt-wound motor (of the ordinary type) when loaded and working with a negative lead. Here it is at the "trailing" horn that the induction per unit area of the polar-surface is *less* dense than at any other part of the surface.<sup>1</sup> It should also be impressed upon the beginner that it is the "loading" of generator or motor which brings about this disturbance.

Six chapters (iv.-ix.) on the details of drum armatures for heavy currents, specially with reference to the end-connections, follow. These have been carefully compiled, and it must be said that they give a good insight into the construction of drum armatures. In the first of this series of chapters the prevention of Foucault currents is dealt with. With regard to making the air-space longer near the horns in order to remove the *cause* of Foucault currents, a word could be added. In what is generally termed the "inverted horse-shoe" type of machine, so largely used at the present time, the pull upon the armature due to magnetism is in an upward direction, and with concentric fields outbalances the weight of the armature, thus causing a considerable pressure on the upper brasses of the bearings. When such a dynamo is direct-coupled to a steam-engine which works with a constant *downward* thrust, serious stresses are brought into play by these opposite forces acting at different points on the shaft. In such cases the widening of the air spaces near the two top horn pieces is usually resorted to, to relieve the pull on armature due to magnetism.

After describing the Edison "plate" end connection in detail, we come, in chapter vi., to the "evolute" end connection, which is described firstly in connection with bars cranked radially towards the shaft. Then follows a description of "evolutes," in which the cranked bar is dispensed with entirely. With regard to this latter, it is unfortunate that the author has not given details of the "Siemens" bar armature, which would have added to the value of the work. He of course recognises Von Hefner Alteneck as the inventor of evolute end-connections.

Eickemeyer's evolute wire-winding, Kapp's helical end-connection, and Swinburne's chord-winding are described in great detail. Chapter ix. treats of the Parson's helical outside end-winding, which is specially interesting on account of the enormous speed at which these armatures rotate. A description of Fritsche's winding is also given.

The subject of commutators claims chapters x.-xiii. In the introductory chapter (x.) "end play" in the bearings is mentioned as tending to more even wear of the surface of commutators. In this connection the author does not mention the "Halpin" gear, which has been introduced for the purpose of automatically moving the brushes longitudinally backward and forward on the

<sup>1</sup> See *Proceedings* of the Royal Society, vol. li. p. 49.

commutator to produce even wear ; although with gauze brushes this would seem an unnecessary refinement—the wear of the commutator surface being in this case so small and even. With regard to “end play” a further word should be added. In the case of steam-dynamos, a fly-wheel is often placed between the dynamo and engine to steady the running. In such cases the fly-wheel becomes magnetised, and as a consequence the armature is pulled away from the engine, thus bringing into play a considerable pressure on the bearings. This is usually remedied by placing the armature core slightly out of symmetry (longitudinally) with regard to the magnet limbs.

The subject of insulation material for commutators is discussed—this being a point of great importance in armature building. Useful data under this head have been collected and tabulated.

Chapters xii, and xiii., on the *construction* of commutators and the manner of connecting the segments to the armature winding, are very good. Descriptions, amply illustrated by woodcuts, are given of the principal methods of construction adopted by makers, and the whole subject of commutators is well treated. On p. 116 a method is mentioned for preventing what is termed “slewing” of the segments caused by the washer going round with the nut (when not specially prevented) and taking the ends of the segments with it. This is a point in the construction of commutators worthy of attention.

In treating of the sparking at commutators, the author starts by giving an elementary theory of electric sparks, as introductory to the main subject ; and after a description of what he terms “elementary planes through commutator and armature,” he leads up to the elementary consideration of the brush itself.

A chapter is devoted to carbon brushes, and another to causes of sparking exterior to the machine. On the subject of armature reaction a good deal of information is given, and Sayer’s system of winding, in which what are termed “commutator coils” are interwound with the main winding of the armature, is very fully described.

The book concludes with a chapter on armature defects, and a few practical hints on the taper of commutator segments.

E. WILSON.

BRITISH MOSSES.

*Illustrated Guide to British Mosses.* By H. G. Jameson, M.A. (Eastbourne: Published by the Author, 6, College Road.)

MR. JAMESON has produced a very useful treatise on British mosses, well calculated to aid the student of their systematic classification. The book consists of an introduction giving clear and valuable information on the structure of the mosses, with a useful section on the practical examination of specimens ; a key to the genera ; a short account of each genus, followed by a key to its species ; and a series of 59 plates, containing over 2400 figures, all of which appear to be clear, and some of which are admirably drawn and lithographed. The figures are for the most part not those of the entire plant, but of those parts which are especially useful in distinguishing the species. As the book contains no de-

scription of each species, but of the genera only, the student must mainly rely on two things—on the key and on the plates. The result is to throw a great burthen on the key, which is framed on the familiar dichotomous arrangement, by which the student is continually presented with one or other of two courses, so that the success of his search depends on his taking the right one of the two alternatives before him at each successive step. A single false choice sends him off in the wrong direction, and all his labour is wasted. It follows that the choice put before the student at each step should be between two alternatives perfectly true, perfectly distinct, and, if possible, indubitable. Now, here Mr. Jameson seems to us sometimes to fail. We repeat that failure at a single point may be fatal to the student’s course. For instance, when the student has got to No. 119 in the key, he finds himself in face of these alternatives :—

- 119 { Stem evidently pinnate or bipinnate, or with numerous divergent branches.
- { Stem not pinnate, not or sparingly branched.

Now, suppose our student has before him a specimen not pinnate, but with branches, and even with divergent branches, it may come under either of the two alternatives ; and everything turns then on the antithesis of the two words “numerous” and “sparingly” ; and neither of these words has any exact meaning—*z.e.* both of them are only expressive of degree—and no standard is given us, or could be given us, by which to tell whether the branches on a given stem are to be called numerous or sparing. Take again No. 186 ; the two alternatives before the student are thus stated :—

- 186 { Leaves curled up or merely flexuose when dry.
- { Leaves crisped and twisted when dry.

Now here the point to be settled, and a point on which the whole future of the hunt depends, may be whether a dry leaf is curled up or crisped and twisted ; and surely the language used in the two cases does not, at least to us, state a clear antithesis. Again, there is to be found in many cases in these keys the use of adjectives in the comparative degree, which always seem to us bad in such a connection, because before you can find the plant to which it is applied you must find and make out the plant of which the positive degree is affirmed. Under “Fissidens,” we are offered, for instance, these alternatives—“plant small” and “plant larger,” “cells obscure” and “cells clearer.” Again, we can well imagine a specimen in respect of which anyone would be puzzled whether to accept the description “leaves acute, yellowish”—not yellow, be it observed—or “leaves rather obtuse, nerve and border orange, cells smaller.” Some of the characteristics given are open, also, to this objection, that they are certain to vary as to their obviousness, or even their accuracy, with the differences of the individuals, as regards age, nourishment, and habit. Linnaeus was very right when he wrote, “Magnitudo species non distinguit. Magnitudo mutatur a loco, solo, climate : mutatur a copia alimenti in plantis, non minus quam in animalibus.” But let us be fair to Mr. Jameson : he is not a sinner in these respects above many others who have gone before him, and have worried generations of students by the want of precision in the alternatives which they present to his choice. In one respect his

attempt is very laudable. Knowing how often mosses are found without fructification, he has endeavoured to rely upon characteristics afforded by the barren plant, and not upon those derived from the inflorescence or the capsule. Whether so important a part of the structure as the reproductive system can be safely neglected by the systematist, seems to us at least doubtful. One has heard the story of the man who boldly asserted that the peristomes of the mosses were created different in order to enable botanists to distinguish the species. That may be rash teleology, and certainly Mr. Jameson has not adopted it.

As the book is intended for beginners, we think that a glossary should have been given.

E. F.

#### OUR BOOK SHELF.

*Report of Observations of Injurious Insects and Common Farm Pests, during the Year 1893, with Methods of Prevention and Remedy.* By Eleanor A. Ormerod, F.R.Met.Soc., &c. Seventeenth Report. (London: Simpkin, Marshall, Hamilton, Kent and Co., Ltd.)

ALTHOUGH the indefatigable Miss Ormerod, our principal English agricultural entomologist, has lately retired from the post which she has so long and so worthily occupied in connection with the Royal Agricultural Society, we are pleased to see that she has by no means relaxed her exertions in the cause, but has again brought out her usual annual volume, which will bear comparison with any of those which have preceded it, in the interest and value of its contents.

The year 1893 was remarkable for the great drought, which though it affected both vegetation and insect-life less than might have been expected, was necessarily favourable to the increase of some species, and injurious to others. The most noticeable feature was undoubtedly the unusual abundance of wasps over almost the whole of Great Britain and the adjoining countries; and thirty pages of Miss Ormerod's report are devoted to wasps alone. The remainder of this report treats of various insects infesting apple, bean, corn and grass, gooseberry, hop, mangold, mustard, pear, strawberry, tomato and cucumber, turnip and willow; and to the occurrence of locusts and mites (*Phytioptidae*), not attached to particular plants. Most of the species noticed are freely illustrated in their various stages, so that there ought to be no difficulty about their identification, even by persons ignorant of entomology. Particular attention is given, as usual, to the best means of prevention and cure applicable to each case.

Fortunately the climate of England is less suited to the excessive multiplication of many insect pests which are highly destructive on the Continent and in America; and we are glad to notice that Miss Ormerod does not consider that the Hessian Fly, about which so much anxiety was felt a few years ago, is ever likely to become very destructive with us. Miss Ormerod also prints a letter from M. Schöven, announcing the introduction of this insect into Norway; another instance of the impossibility of preventing insect pests being carried by the constant international traffic from country to country, where they establish themselves if the climate and conditions are favourable, but if not, they soon die out, or linger on in too small numbers to be really injurious.

The introduction of locusts into England in brocoli from South Europe, and (dead) in large quantities among hay from Buenos Ayres, is likewise worthy of notice.

Mustard beetles, and others of the more familiar farm

and garden pests, still continue to require and to receive a considerable amount of attention.

In conclusion, we may express our hope that Miss Ormerod may long be spared to issue many more of her useful annual contributions to agricultural entomology.

W. F. K.

*On the Definitions of the Trigonometric Functions.* By A. Macfarlane. (Boston: J. S. Cushing and Co.)

DR. MACFARLANE has already written on space-analysis. The previous papers were on the principles of the algebra of physics, the imaginary of algebra, and the fundamental theorems of analysis generalised for space. The pamphlet before us was read before the Mathematical Congress at Chicago, August 22, 1893.

In the first of the above-cited papers the author introduced a trigonometric notation. This has been discussed by Mr. Heaviside in the *Electrician* (December 9, 1892). Dr. Macfarlane, by way of rejoinder, remarks: "I believe that this paper will show that trigonometry is not an application of space-analysis, but an element of it; and that the ideas of this element are of the greatest importance in developing the higher elements of the analysis." Our readers may remember that the notation was also discussed by Prof. Alfred Lodge (*NATURE*, November 3, 1892). To this our author replies: "I consider that the notation is a matter not of secondary, but of paramount importance. If the notation is arbitrary, it gives us no help in the further development of analysis; if on the other hand it is systematic and logically connected with the existing notation of analysis, it points the way to more general principles and results. I believe that this paper will show that my notation is systematic and logical." The pamphlet occupies 49 pages, and there are some other passages like those we have excerpted; so there is likely to be a pretty fight, of which our readers will soon hear more, if they do not take part in the strife. The pamphlet will repay perusal.

*Key to Mr. J. B. Lock's Shilling Arithmetic.* By Henry Carr, B.A. (London: Macmillan and Co., 1894.)

IN the worked-out results which we have now before us, Mr. Carr has not restricted himself to giving the mere answers, but has inserted in all cases the steps by which they are reached. This, especially for beginners, will be found of great service, and by judicious use will certainly lighten the teacher's task. We have selected many of the more advanced examples here and there, and worked them out as a test of the accuracy of the results given, and have found no mistakes. Others, perhaps, may not be so fortunate, but all necessary care seems to have been taken to give the right answers. All who use Mr. Lock's shilling book will find it of great assistance.

#### LETTERS TO THE EDITOR.

*The Editor does not hold himself responsible for opinions expressed by his correspondents. Neither can he undertake to return, or to correspond with the writers of, rejected manuscripts intended for this or any other part of NATURE. No notice is taken of anonymous communications.]*

#### The Thermal Expansion of Diamond.

IN view of the interest at present aroused by M. Moissan's successful experiments upon the artificial production of diamond, I venture to recount the results of some observations upon the thermal expansion of diamond, which, I think, are suggestive in connection with the particular manner in which M. Moissan has achieved success. M. Moissan has shown that the added condition of high pressure has rendered a method previously unsuccessful now for the first time successful.

Minute particulars being out of place here, I may briefly say

that the measurements given below were obtained by projecting, by aid of a 1" objective, the image of a diamond, which was rather less than 2 mm. in extreme length, into a camera, so that it was enlarged upon the screen to 11 c.m. across. Two micrometer eye-pieces with movable wires were directed upon opposite corners of the image, the diamond being manipulated in the field of the object-glass till these corners were in sharp focus. A movement of the wires of the reading microscopes by one division of the head of the micrometer in following the expansion of the image corresponded to a diametral enlargement of this latter by 0.0005 c.m., but owing to imperfect focus of the image no more than 0.001 could be accurately determined. If the coefficient of expansion of the substance were 0.00001 (that of platinum, about) the expansion of the image, due to 10° C. change of temperature, is just determinable. It will therefore be understood that over a wide range of temperature considerable certainty in the readings could be secured.

The heating was effected by radiation from a platinum ribbon folded in such a manner that the substance under observation occupied the central point of a narrow platinum tube. The ribbon was heated by a current. A beam of light from a very small sphere—2 mm. in diameter—of incandescent lime (heated in an oxyhydrogen flame) entered the tubular oven from the back. The adjustment of this beam greatly decided the sharpness of the projected image. Temperatures were determined

served by crystalline forces which will require to be brought into play by external conditions of pressure. It is probable that this is therefore an essential condition of success in its artificial production. It is perhaps of little interest to add that this reasoning gave rise to experiments—as I had leisure for them—which I only laid aside finally upon hearing of M. Moissan's success. I did not seek the aid of solution in a metal, but used an apparatus to compress graphite, as well as carbon prepared from sugar, between iron plates kept at a red heat, and urged together by the alternate heating and cooling of the bars of an iron yoke.

I am not without hope that the use of high pressure at a high temperature may ultimately prove sufficient—without resort to solution in a metal—to produce diamond. If the presence of a certain minute quantity of the carbide of a metal is essential, of course it will fail. It is difficult to imagine, however, that it should be essential.

Trinity College, Dublin, March 5.

J. JOLY.

The North-East Wind.

PROF. BONNEY, in his "Story of our Planet," explains the prevalence of east winds at this season as being due to the low winter temperature of eastern Europe compared with the Atlantic coasts. If this explanation be the true one, we should expect the phenomenon to occur in December and January. My impression is, although I have no accurate statistics, that east winds do not prevail in those months in our climate. Further, we should expect, crossing the Atlantic in winter, to find for the same reason west winds prevailing off the American coasts. If this is not found to be the case, I would suggest the following as, if not the cause, at all events one of the causes, of the phenomenon in question.

The difference of temperature between the northern Arctic regions and the tropics, to which, combined with the earth's rotation, the north-east trade wind is supposed to be due, is necessarily greater in the spring months, February to June, than on the average of the year. Because in the Arctic regions, little or no heat being received directly from the sun between the autumnal and the vernal equinox, the maximum of cold should be attained in March or from February to April.

In low latitudes these months are by no means the coldest. It is reason-

able to expect that when this difference of temperature becomes accentuated, and the gradients, so to speak, steeper, the north-east winds which are due to it should become prevalent in higher latitudes than those to which the trade winds proper are usually confined.

S. H. BURBURY.

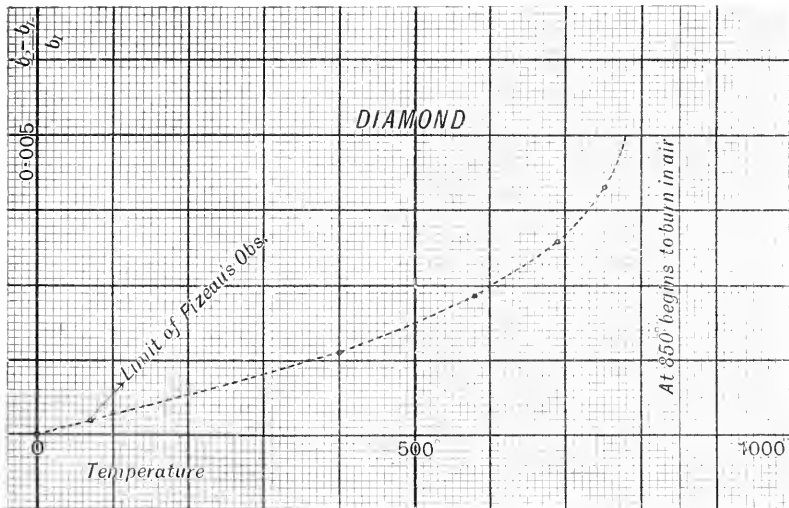

FIG. 1.

by melting substances of known melting-points in the oven, and reading the corresponding currents. Thus a curve of galvanometer readings plotted against temperature was obtained for subsequent use.

The results of the observations were four well-fixed points which give a curve (Fig. 1) seemingly tangential to Fizeau's results at low temperatures, but which curls up rapidly at about 750° C. At a temperature of 850°, and indeed below this, observations were stopped by the "efflorescence" upon the surface of the diamond of flaky particles which wriggled and twisted in a peculiar manner, finally disappearing. Once started, the "combustion" continued till the temperature of the oven was lowered to 712°. Cooling the oven, I subsequently photographed one face of the diamond. The picture obtained shows the face with a lamellar appearance, which was produced entirely by the heating, as at starting the faces were smoothly curved. Such an appearance is occasionally observed upon specimens of diamond. This photograph, as well as the curve of expansion, were shown at the *soirée* of the Royal Society in June 1892. The apparatus used was also shown in operation as applied to a minute globule of a melted basalt.

The sudden increase in volume or swelling-up of the diamond at high temperatures, suggests that the diamond is a form of carbon which has been subjected to high pressure when crystallising. Such changes we may expect to be reversible, and it is supposable that equilibrium at the higher density is only pre-

The Suspension of Foreign Bodies from Spiders' Webs.

THE following instance of the use of a stone by a spider as ballast for its web is interesting.

A web was noticed stretched between two trees at a distance of about ten feet from one another. From it hung a thread about two feet long, and attached to its lower end was a small pebble about the size of a pea, the stone hanging free about four feet from the ground. The stone had evidently been made use of in this special manner by the spider for the definite purpose either of keeping the web taut, or as ballast to give it stability against the wind, for on lifting the stone to remove the pressure, it was observed that the web became limp and slack, and was stirred out of position by the least breath of air.

This was noticed by a score or so of members of the German "Turnverein" here, in the garden of whose premises the occurrence took place.

Buenos Ayres, January 24.

R. PHILIPP.

THE FALLS OF NIAGARA AND ITS  
WATER-POWER.

TO render the vast energy of the Niagara Falls available for use in the industrial world has been the dream of many an enterprising spirit who has watched the immense volume of water plunging over the precipice, only to expend its energy in transforming itself (or its equivalent) into an invisible vapour, to be carried by the winds over to the lakes supplying the Falls, and pass through the same cycle again. But till quite recently little has been attempted. For many years past a few mills on the eastern cliff of the Niagara Gorge, below the Falls, have used a certain amount of the power, now aggregating about 6000 horse-power, by conducting water from the river above the Falls through a canal, and using it to drive turbines placed so as to benefit from only 90 to 100 feet or less of the total fall available, the water discharging down the side of the gorge after it has done its work. In this way it may be said that a start has been made, but it is only within the last few years that the utilisation of the power has been undertaken in a bold spirit, and this has become possible by the recent developments in electrical science, which enable power to be transmitted to a distance economically on a commercial basis.

To ensure success the enterprise had to be taken up on an extensive scale by a powerful company. Such a company is the Niagara Falls Power Company, who have been granted franchises for the utilisation of some of the water-power available. The company owns lands covering an area of 1500 acres on the "American" side, and extending along the upper river front for over two miles, on which they propose to develop a large manufacturing centre, but one of an entirely new order—one without the abominations of smoke and concomitant dirt, now so intimately associated with centres of the kind. An allied company has built a whole village on the lands of the Power Company; another has constructed railways to place the various factories in communication with the main lines of railway in the immediate neighbourhood; and others, again, have been formed to deal with the distribution of the power to all the cities and towns coming within the sphere of operations—a rather elastic term when dealing with high pressure electrical distribution. But although it is now more than three years since the Cataract Construction Company—the company formed for carrying out the engineering portion of the immense scheme projected by the Niagara Falls Power Company—commenced their operations, many in this country seem to be quite unaware that a great portion of their work has been already accomplished and the rest is in an advanced state, and of the manner in which the power is to be rendered available for industrial purposes. It is thought that a short description of the works, soon to be in operation, may not be without interest to the readers of NATURE.

That the Niagara Falls are peculiarly well suited to an undertaking of the kind now entered upon is well known. Situated in a comparatively narrow river, connecting Lakes Erie and Ontario, and supplied from a vast collecting ground, draining into the huge North American lakes forming the centre—Lake Superior, Lake Michigan, Lake Huron, and Lake Erie—the whole having an area of above 300,000 square miles, or nearly three times the area of Great Britain and Ireland combined, it might be expected that the discharge over the Falls would vary but slightly in volume or height. And such is the case. An estimated quantity of 265,000 cubic feet is precipitated over the Falls each second of time, with but slight variations, all the year round, in winter and summer, whether the river be laden with ice or the foot of the Falls appear choked with frozen spray, and in periods of drought or flood. The ordinary variations in level are

not more than 1 foot above or 5 feet below the Falls, wind in general having the greatest effect on the level of the river. "The greatest authenticated changes of level," says Prof. W. C. Unwin, "below the Falls, due to ice-blocks in the river and other causes, amount to only 13½ feet rise above mean level and 9 feet fall below it." The drop at the Falls being about 160 feet, or, with the rapids above and immediately below the Falls, 214 feet, within a distance of a mile or a mile and a quarter, it will be seen that the above variations are unimportant; and, in addition, the actual fall to be used for the turbines will be 140 feet. Further than the above, the level character of the land on the "American" side, adapted for the cutting of canals and erection of factories; the right-angular relative position of the upper and lower

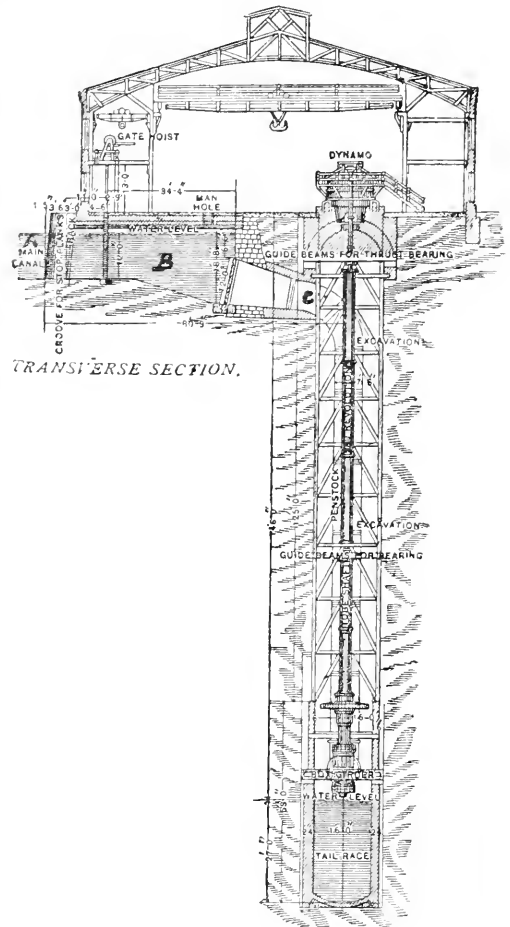

FIG. 1.

not more than 1 foot above or 5 feet below the Falls, wind in general having the greatest effect on the level of the river. "The greatest authenticated changes of level," says Prof. W. C. Unwin, "below the Falls, due to ice-blocks in the river and other causes, amount to only 13½ feet rise above mean level and 9 feet fall below it." The drop at the Falls being about 160 feet, or, with the rapids above and immediately below the Falls, 214 feet, within a distance of a mile or a mile and a quarter, it will be seen that the above variations are unimportant; and, in addition, the actual fall to be used for the turbines will be 140 feet. Further than the above, the level character of the land on the "American" side, adapted for the cutting of canals and erection of factories; the right-angular relative position of the upper and lower

rivers, facilitating the construction of tunnels or tail-races for the disposal of the discharge water from the turbines; and, finally, the abundant means of communication, for the transport of raw materials and manufactured goods, with distant parts, existing in the three or four great lines of railway and the huge chain of navigable lakes in connection with the upper river; all point to the neighbourhood as being one particularly well adapted to the requirements of a power centre for industrial works of the character of that now being formed. The hydraulic part of the works will be seen, on reference to Fig. 1, to consist broadly of a canal, a wheel-pit with its turbines, and a tunnel or tail-race. The canal, A, opens out from the upper river, about 1½ miles above the American Falls, that is, on the north or "American"

side, and extends in a north-easterly direction for 1500 feet, with a width of 350 feet, and a depth of 12 feet. At the end of this canal, on the north-west side, are sluice-gates controlling the flow of the water into side passages or head-races, B, which conduct the water to the penstocks, C, which guide it from the top of the wheel-pit to the turbines at the bottom. Fig. 2 shows the main canal in course of construction. In the background is seen the Upper Niagara River, flowing from left to right; and in the foreground appear two entrances to one of the head-races. The wheel-pit is nearly 200 feet deep, stone walled, and of sufficient length at present to accommodate three turbines, each of 5000 horse-power, and their penstocks. This will be extended as the demand for power increases. The turbines, which have been made by the I. P. Morris Company, of Philadelphia, from designs by Messrs. Faesch and Piccard, Geneva, Switzerland, are double and of the outward flow

shortly to be available, in the continuity of the supply. It is approximately 19 feet wide, and 21 feet high. It is in section in the form of a horse-shoe, and has a mean grade of about 7 per 1000, and is perfectly straight in a vertical plane. Its length is 7000 feet, or over  $1\frac{1}{4}$  miles. Four courses of hard brick set in cement line the tunnel throughout, the invert being paved with that of the hardest nature—vitrified brick—to resist the wearing action of the stream with its sand and other materials borne along by it. At the mouth of the tunnel the invert and sides are lined with steel plates forming a wave curve, the last few hundred feet sloping more than elsewhere, bringing the lower part of the mouth a few feet under the mean water-level. In this way the water of the river forms a cushion against which the discharge from the tunnel impinges. In Fig. 3 is seen, under the left-hand end of the suspension bridge, the incomplete mouth of the tunnel. In the distance are the American

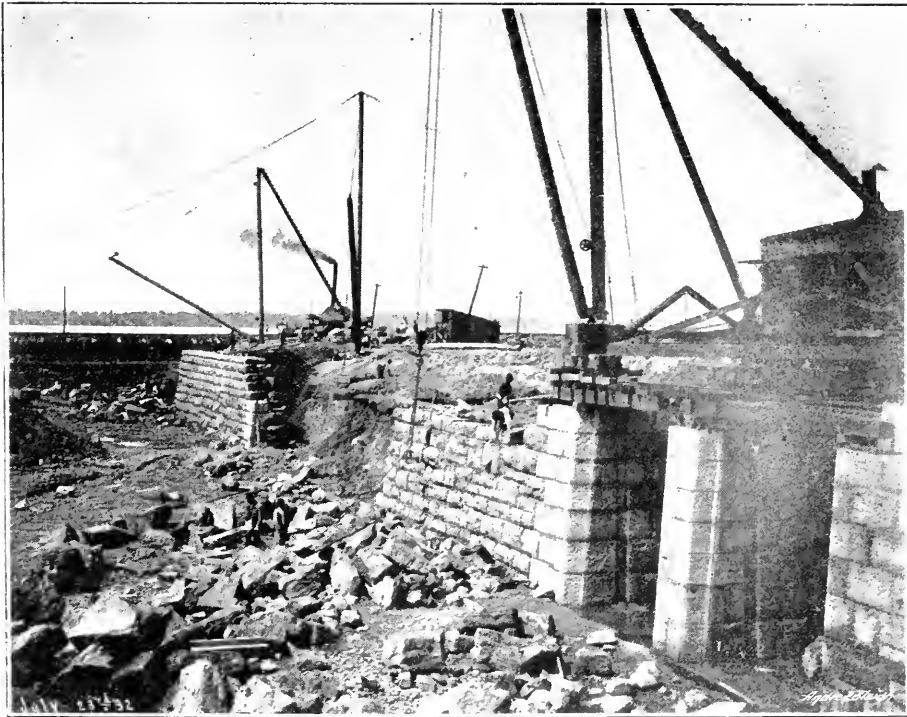

FIG. 2.

type, being placed horizontally, and driving the dynamos for distributing the power, also placed horizontally, in the power-house over the wheel-pit, by means of a long vertical steel shaft, hollow at all parts for the sake of lightness except at the bearings. The turbines and dynamos will revolve at 250 revs. per minute. From the bottom of the wheel-pit a channel leads into the great tunnel, or tail-race, through which the water is discharged into the lower river, a short distance below the upper suspension bridge, after it has passed through the turbines. This tunnel, now completed, is a great work, but only commensurate with the scale on which the whole scheme has been undertaken. It has a capacity sufficient for discharging the water from turbines aggregating about 100,000 h.p., which is the figure towards which the Cataract Construction Company is working at present, and has been constructed with a consideration for durability such as will arrest the confidence of those intending to make use of the power,

Falls, the Horse-shoe Falls being hidden from view. The small fraction of the Falls to be diverted for the 100,000 horse-power, represented by the *maximum* discharge from the tunnel, is forcibly shown by the picture. The regulation of the speed of the turbines will be effected by controlling the flow of water leaving them, by closing the exits from them more or less by means of balanced gates, controlled by governors on the floor of the power-house above.

Passing now from the hydraulic part of the works to the electrical or distributing part, we are presented with one of the most interesting and important developments in electrical engineering practice of the present day.

In the year 1890 the Cataract Construction Company invited selected engineers and engineering firms to consider the problem of distributing the power, and appointed a commission, called the International Niagara Commission, to examine and consider all the projects sent in. It

consisted of Lord Kelvin (then Sir William Thomson) as president; Dr. Coleman Sellers, of Philadelphia; Prof. E. Mascart, Paris; Colonel Theodore Turrettini, Geneva; and Prof. W. Cawthorne Unwin, F.R.S., as secretary. Funds were placed in their hands for the purpose of paying a fixed sum to each competitor sending in a scheme of sufficient importance, and awarding prizes. Meetings of the commissioners were held in London, but no decision was come to as to whether compressed air or electricity should be used—the two means of distributing the power for which schemes were submitted,—and they were not convinced of the superiority of an alternating current over a continuous current system of electrical distribution. Since the commission dissolved, however, a decision was come to in favour of the adoption of electrical distribution, and Prof. George Forbes, F.R.S., being appointed electrical consulting engineer, the outcome has been the adoption of the scheme originally submitted to the commission by him in 1890 and rejected at the time by every one of the commissioners. In that scheme it

in the continuous current system to increase the pressure to the figure necessary for economical transmission), and the admirable facility with which the alternating current can be reduced from high to low pressure, and *vice versa*, for the various requirements—such as electric traction, electro-metallurgy, motive-power and lighting—by that machine which does its work without mechanically moving parts—the alternating current transformer—are strong points in favour of the use of alternating currents. The question of motors is, on the other hand, a strong one, ordinarily, in favour of continuous currents. But when the frequency of the alternating current is low, as is to be the case at Niagara Falls, most of the advantages of continuous current motors over alternating current motors disappear, and the operation of many alternating current motors, already existing, is facilitated.

In regard to the frequency of alternation of the currents to be adopted at Niagara Falls, we find a very marked departure from existing practice. The frequency hitherto used has been from 70 to 100 periods per second in Europe, and 133 in America. There is an exception—



FIG. 3.

was insisted that alternating currents must be used, that the two-phase system should be adopted (that is, one employing two currents which differ from each other with respect to time by 90 degrees or a quarter of a complete period of alternation—when one has a *maximum* value, positive or negative, the other is a zero, and *vice versa*), that, using only machinery on the market, 2000 volts should be the pressure for local work, and step-up transformers be employed for raising the pressure for transmission to Buffalo (eighteen miles distant), and that the motors for converting the electrical power into mechanical power at the far ends of the lines should be synchronising motors, Tesla two-phase motors, and motors with commutators and laminated fields. This briefly describes the system to be now adopted; and it is interesting to note the conversion of the commissioners appointed by the Cataract Construction Company, with one notable exception, to viewing with favour the adoption of the alternating current in preference to the continuous current. But the difficulties connected with the insulation of the dynamos from the earth, which is necessary when using a number in series (an arrangement required

that of Messrs. Ganz and Co., of Buda-Pesth—who have adopted 42 periods per second. But the frequency to be used at Niagara Falls will eclipse all, inasmuch as it is to be one of 25 periods per second; and it may be remarked here that one of 16 periods per second would have been adopted, had not the weight of the machine for this periodicity been too heavy for the hydraulic piston (which supports the whole weight of the revolving parts of the turbine and dynamo, and the shaft connecting them, using the head of water driving the turbine, the thrust-bearing shown in Fig. 1 being merely for preventing motion vertically), using the induction in the iron desired by the manufacturers of the machines, which is lower than that which the Cataract Construction Company's electrical consulting engineer would have preferred.

The advantages to be derived from the use of so low a rate of alternation are many. One has already been mentioned here, namely, the increased number of alternating current motors which become available for use, to which may be added the further great advantage of an improved efficiency in the motors. But probably the greatest advantages of a low frequency are to be found



in connection with the conductors for the transmission of the power. There are many difficulties experienced with high frequency currents which are either largely mitigated, or entirely removed, by the adoption of a low rate of alternation. There is, first, the tendency of alternating currents to confine themselves to the outside of the conductors carrying them, thereby increasing the resistance, an effect increased by augmenting the frequency; secondly, there is the impedance of the line, due to the magnetic field formed between the go and return wires of a circuit, which is also increased by raising the frequency; another is the tendency to discharge from a conductor, shown so well by Dr. Lodge's experiments with extremely high rates of alternation, which is less marked the lower the frequency; a fourth is that tendency to break down solid insulators, shown by Mr. Tesla, again using currents of extremely high frequency, which is reduced the lower the rate; and lastly there is the loss due to capacity, both owing to static charge, and, combined with the self-induction of the circuit, resonant effects, which is reduced more and more the lower the frequency is made. There is one important objection, in general, to the use of a slow period of alternation, and this is that, with the frequency to be used at Niagara Falls, flickering of lamps, both arc and incandescent, is perceptible. But this objection is very easily overcome by changing the alternating current into a continuous current, as will have to be done for other purposes at Niagara Falls, which may be accomplished in one or two ways, to be mentioned later. This objection, too, had not the same weight at Niagara Falls as it might have at other places, as most of the power transmitted will be used for motive-power purposes.

The electric pressure selected for use in the neighbourhood of Niagara Falls, and for transmission to Buffalo—one of the first more distant places to be supplied with power—will be 2000 volts at first, for the former, and probably 20,000 volts for the latter. As regards the means of obtaining the 20,000 volts, it is much to be regretted that the inability to obtain from American manufacturers a guarantee for machines constructed for such a pressure, they having never supplied machines at a higher pressure than 2000 volts, has necessitated the adoption of step-up transformers. The consequence is that economy has had to give way to expediency, and this has again made itself felt in the pressure of 2000 volts decided upon, as probable, for the local distribution. The use of the extra high pressure, even here, would have obvious advantages. One would be the resulting uniformity in the whole system, local and distant; and a second, the saving to be effected in the amount of copper in the conductors. It is a significant fact in support of this contention that, to put in the most economical section, using 2000 volts, will require 3 sq. in. of copper for each conductor, or 12 sq. in. for each 5000 horse-power dynamo.

The dynamos for generating the power in two alternating currents differing in phase by  $90^\circ$ , at 2000 volts, will be mounted directly on the top of the turbine shafts. They will be of 5000 horse-power each, and were designed specially for the work by Prof. George Forbes, as the Company's electrical consulting engineer, three being now made by the Westinghouse Electric and Manufacturing Company, of Pittsburgh, Pa. In them the armature is fixed, the field magnet, formed of a nickel-steel ring, 12 ft. 9 in. in diameter, 4 ft. 2 in. high, and 6 in. thick, with the pole-pieces pointing radially inwards, revolving outside. In this way the pole-pieces are well held in against centrifugal force, and, moreover, the magnetic pull between the pole-pieces and armature opposes the centrifugal force of the revolving field magnet. The nickel-steel ring with the pole-pieces is suspended from a steel spider with eight arms, which spreads over the top of the armature like an umbrella,

being keyed to the solid steel shaft passing through the centre, and attached to the ring by studs and nuts. The attendants will be able to enter the interior of the armature at all times, whether the machine be running or not, for the purpose of attending to the two bearings inside, and the collecting rings on the under side of the spider and the brushes, for passing the current to the exciting coils, &c.

From the dynamos conductors will be led, in conduits in the floor of the power-house, to a large subway running the whole length of the house and opening into a large cellar underneath it, in which will be placed the transformers for raising the pressure for the transmission of the power outside, and other apparatus.

The means adopted for running the conductors between the power-house and the spots where the power is to be utilised is of the most satisfactory description. Bearing in mind the very real troubles likely to arise with a pole line from lightning, wind, and frost, including the formation of sleet upon the wires and insulators, the Cataract Construction Company abandoned this cheapest form of construction, and decided to build a subway large enough to carry the conductors, and allow of a man walking or travelling on a trolley along the whole length. The length built up to the present extends from the power-house to the Pittsburgh Reduction Company's works, to be devoted to the production of aluminium, and one of the first places to be supplied with power, a distance of 2500 feet. This subway, which may eventually be extended to Buffalo, is built after the design of the Cataract Construction Company's electrical consulting engineer, and is of concrete 9 or 10 inches in thickness. The height inside is 5 ft. 6 in. It is of the horse-shoe shape, as shown in Fig. 4, which is from a photograph of the actual work. Iron castings are embedded in the sides every 30 ft., on which are bolted brackets carrying oil insulators to carry the bare copper conductors. In front of the conductors, on each side, will be placed screens formed of wooden frames 10 ft. long, on which will be stretched open metal, covered with plaster to within about a foot of the top, which will there be left open to allow of inspection of the conductors behind. Down the centre space, 22 inches wide, will be a track for an electric trolley, with a conductor between the rails. Drainage, &c., has been well provided for, manholes built to the surface of the ground, and each casting carrying insulators is put to earth. The subway will probably be artificially dried by forcing a current of dry air through it. In this way a very satisfactory piece of work, both from the point of view of efficiency, and that of safety, has been undertaken and practically completed, making this part of the work of the same permanent character given to the rest of the undertaking.

It only remains to say a few words with regard to the motors to be used for converting the electrical power into mechanical power at the far ends of the lines, and the other purposes to which it will be put.

For electric lighting the current, as already stated, will have to be transformed into a continuous current on account of the low frequency of alternation adopted; a continuous current will also be required for other purposes, such as street railways, metallurgical works, and probably the working of the canal boats on the Erie Canal running from the Niagara River above the Falls to the Hudson River at Albany, 350 miles distant. This continuous current can be obtained in several ways, one being the well-known method of driving a continuous current dynamo by an alternating current motor; a second by using a commutator, placed where the continuous current is required, and there rotated. With this latter method, besides all the advantages of the alternating current being retained up to the point where the continuous current is required, the rectification can be effected with very inexpensive machinery and without

serious loss. Although no commutator for this special purpose is at present on the market, the solution of the problem has been practically achieved, and may be expected in the immediate future to result in important developments in the electrical distribution of power.

With both the continuous current and the alternating current of low frequency, then, for use at the far end of the lines of suitable pressure, the pressure having been reduced from that on the line wires by transformers, as at the transmitting end it was increased, continuous current motors can be used for power work where most suitable; the current can be used for electro-metallurgical work and for electric lighting in the ordinary well-known ways, and the alternating current can be used in motors direct, without rectification, everywhere else.

Already a great number of applications for power have been made. As before noted, the Pittsburg Reduction Company has started works for the production of aluminium, and will be supplied with power to the extent

above, it is by no means all that is in contemplation, or even being now prosecuted. On the same side of the Falls, rights of way have been obtained for driving a second tunnel, of the same capacity as the first—namely, 100,000 h.p.—and on the Canadian side powers have also been granted to the Company to use the water-power there, the extent contemplated to which it will be used reaching, it may be, 250,000 h.p. Altogether the total amount for which concessions have been granted amounts to 450,000 h.p., which will involve the abstraction from the Falls of about 12 per cent. of the water. But, large as this may seem at first sight, admirers of the Falls, from the æsthetic point of view, will be glad to hear that it is thought that the diversion of this amount will not be noticeable to visitors to the Falls. And the Niagara Falls Power Company have limited their demands on the side above the American Falls to the 200,000 h.p. It will no doubt be a long time before the full amount for which powers have been obtained will be taken up.

What may lie in the future it is impossible to forecast. But, so far, lovers of nature need fear little that they will be deprived of this great work of hers; they will still hear its thunder, be able to watch its ceaseless changing aspects, and revel in the other beauties of this mighty cataract.

#### NOTES.

THE first (or gentlemen's) soirée of the Royal Society is announced for Wednesday, May 2.

THE Duke of Bedford and Mr. Spencer Pickering, F.R.S., have arranged to start an experimental fruit station, in order to investigate both scientifically and practically the culture of hardy fruits. About twenty acres of land in the neighbourhood of Woburn Abbey have been set apart for the experiments, and the services of an able horticulturist, who will act as local manager, have been secured.

PROF. J. J. SYLVESTER, F.R.S., has been elected one of the twelve foreign members of the Italian Scientific Academy, founded in 1782, called "Dei Quaranta." Among the other foreign members of this Academy are Prof. Helmholtz, Lord Kelvin, Prof. Huxley, and M. Pasteur.

DR. J. R. REYNOLDS, F.R.S., has been re-elected President of the Royal College of Physicians.

THE death is announced of Dr. E. H. Jacob, Professor of Pathology in Yorkshire College, Leeds, at the early age of forty-four.

THE death occurred last week of General Favé, Academician Libré of the Paris Academy of Sciences, and for a long time head of the Ecole Polytechnique, where he was Professor of Military Art and Fortification.

WE regret to record the death of Mr. W. Pengelly, F.R.S., at Torquay, on Friday last, at the age of eighty-two. He was the author of various papers on geological and other subjects, and his exploration of Kent's Cavern, carried out under the auspices of the British Association, was of extreme importance in establishing the existence of prehistoric man. He also accumulated and arranged a fine collection of Devonian fossils, which, under the name of the Pengelly Collection, are now in the Oxford University Museum. The President and Committee of the Torquay Natural History Society intend to appeal to the scientific world for funds to build a new lecture-room to their museum, to be called the Pengelly Memorial. Mr. Pengelly



FIG. 4.

of, at present, 7000 h.p., at 150 volts. The Niagara Falls Paper Company have erected a mill on the lands of the Power Company, for the making of their wood-pulp, and have sunk their own pit for turbines to the extent of 6000 h.p. The Company will take water from the main canal, and lease the right to use the great tunnel of the Niagara Falls Power Company as a tail-race. This mill, as a power consumer, is representative of a type which will probably use largely the cheap power at the Falls, needing as they do power continuously day and night. Synchronising alternators, as motors, could with effect be used in such cases, hardly ever requiring stopping and starting as they would; and they are of high efficiency. The high pressure might be used in some of these cases, without transforming down, in addition. Applications for power have also been made from Albany, 350 miles from the Falls.

Large as is the extent of the operations described

was the founder of the Society, and acted as secretary for forty years.

IT is stated that the Municipal Council of Bry-sur-Marne, near Paris, has decided to erect a monument to Daguerre, the inventor of photography.

A CHAIR of Bacteriology is to be established at Erlangen, and Dr. Hauser, now Privat-docent in that University, will, the *British Medical Journal* states, probably be invited to occupy it.

THE legacy of 100,000 francs, placed at the disposal of the French Government by M. Giffard, has been assigned by the Minister of Public Instruction to the laboratory of the International Society of Electricians.

MR. SCOTT ELLIOT, who left England for Uganda last September, reached Usoga, on the northern shore of the Victoria Nyanza, in December. He proposes to explore the botany, geology, and natural history of the great mountain chain of Ruwenzori.

THE *Ceylon Observer* reports that at the annual meeting of the Planters' Association, held at the end of last month, it was resolved "that the Government be asked to arrange for the appointment of an entomologist to be attached to the Colombo Museum."

THE tenth congress organised by the National Horticultural Society of France will be held at Paris during the General Horticultural Exhibition, between May 23 and 28. Among the special questions to be discussed are the following:—Chlorophyll in relation to the vigour of cultivated plants; capillarity in relation to the preparation of the soil; the means of promoting the nitrification of nitrogenous substances, and of rendering the nitrogen more readily assimilable.

A REUTER'S telegram states that Mr. Theodore Bent and his party, on their return from their archæological expedition to Hadramaut, had reached the coast at Sheher, east of Makalla, on March 3. All were in good health, but the journey seems to have been accompanied by considerable danger. They were attacked on several occasions by hostile tribes, but appear to have made good use of their time traversing and, doubtless, mapping a large area of the interior.

THE annual dinner of the Institution of Civil Engineers was held on March 17, in Merchant Taylors' Hall. Mr. Alfred Giles occupied the chair, and among those present were Lord Kelvin, Sir F. Abel, Sir George Stokes, Sir F. Bramwell, Sir Douglas Galton, Sir John Fowler, Prof. Kennedy, Mr. J. W. Hulke, Sir R. Rawlinson, Mr. Alex. Siemens, Dr. James Riley, and Dr. Pole. The institution now numbers as many as 6000 members, and has offshoots in various branches of the engineering profession—marine engineers, naval architects, iron and steel founders, telegraph engineers, &c.

THE following are among the lecture arrangements at the Royal Institution after Easter:—Prof. J. A. Fleming, four lectures on "Electric Illumination"; Prof. J. W. Judd, three lectures on "Rubies: their nature, origin, and metamorphoses"; the Rev. W. H. Dallinger, three lectures on "The Modern Microscope"; Prof. Dewar, three lectures on "The Solid and Liquid States of Matter"; Mr. John A. Gray, two lectures on "Life among the Afghans"; Capt. Abney, three lectures on "Colour Vision" (the Tyndall Lectures). The Friday evening meetings will be resumed on April 6, when a discourse will be given by Prof. Victor Horsley on "Destructive Effects of Projectiles"; succeeding discourses will probably be given by Prof. J. J. Thomson, Dr. J. G. Garson, Prof. H. Marshall Ward, Dr. G. Sims Woodhead, Prof. A. M. Worthing-

ton, Sir Howard Grubb, Prof. Oliver Lodge, Prof. C. V. Boys, and others.

THE Committee appointed by the Secretary of State to inquire into the best means available for identifying habitual criminals have issued their report. The system of identification recommended for adoption embodies the practical results of Mr. Galton's investigations, and M. Bertillon's system of classification. It is proposed (1) to photograph prisoners as at present, stress being laid on the necessity of obtaining a perfectly clear side photograph showing distinctly the profile and the form of the ear. (2) To take the five measurements required for purposes of classification, namely, the length of the hand, the width of the head, the length of the left middle finger, the length of the left forearm, the length of the left foot. The measurements should be taken with the same instruments as in France, and should be stated in millimetres, so as to facilitate identification in international cases. (3) To take the finger-prints by Mr. Galton's method. (4) A description should also be taken as at present, but somewhat briefer, including the height in feet and inches, colour of hair, eye and complexion, and the distinctive marks. To carry out these suggestions the establishment of an Anthropometrical Registry is proposed. The Committee are strongly of opinion that it is essential to the complete success of the registry to secure the services of an expert practised in the methods of scientific anthropometry. It is certainly desirable that the English Anthropometric Office should from the first have the advantage of scientific guidance not inferior to that enjoyed by the French Service d'Identification.

M. MARCEL DUBOIS, in a series of articles recently concluded in the *Annales de Géographie*, has investigated the classification of rivers according to size. He points out the unscientific nature of a classification by length or volume alone, and proposes, in place of the uncertain methods hitherto employed, to classify river-systems according to the ratio which the whole annual discharge bears to the area of the drainage basins. This permits of a sub-classification according to climatic zones and varieties of vertical relief. Thus tropical islands have the largest rivers of all, on account of the great rainfall and the small area of the land. Peninsulas in tropical regions come next, but when great continents are considered the configuration of the land comes very prominently into play. Thus in Africa the plateau-structure favours a storing-up of rainfall in lakes and in the upper-courses of rivers barred by cataracts, while in South America the vast plain of the Amazon presents on the grandes scale a system of direct drainage, the whole water-supply flowing without interruption to the sea.

THE *Illustrated Archaeologist* for March retains the high character of its predecessors as regards the number and quality of the illustrations. Mr. Edward Lovett's article on prehistoric man in Jersey contains figures of flake-knives, scrapers, drills, piercers, spear-heads, and arrow-heads of flint found in a cave in the high and rugged cliffs near Plemon and Greve-de-Lecq. The height of the cave-floor above the present sea-level is sixty feet. Some exceedingly interesting objects were obtained from a layer of very dark-coloured carbonaceous matter found on the floor, and representing the remains of the last fire used in this ancient dwelling-place. They consisted of several calcined shells of the common limpet, some fragmentary remains of bone, and a few molar teeth of a cervine animal. The most interesting find in the ash, however, was a calcined nodule of iron pyrites which had probably been used with a flint flake for making the necessary spark to kindle the fire. This carries the flint-and-steel back to a very remote period, and gives a hoary antiquity to the tinder-box or its contents. In the whitish clay on the floor of the cave more than a thousand flints were found, every one of which bore, more or less, abundant

traces of careful chipping or flaking. The implements described and figured by Mr. Lovett do not belong to a highly-finished type; indeed, from the enormous number of flakes and chippings associated with them, it is highly probable that the cave was a neolithic workshop. The opinion is expressed that, at the time when the cave was inhabited, Jersey was probably joined to France, and perhaps France to England, which may explain the presence of chert from Portland.

THE current number of *L'Astronomie* contains an article by M. J. R. Plumondon on the application of meteorology to the art of war. The author quotes a number of passages from works of military history, showing how a foreknowledge of the weather for a day or so in advance would probably have changed the issue of certain engagements. With the view of facilitating weather predictions, and of utilising them for military purposes, the author has invented a meteoroscope, which is made by M. Richard, of Paris; it is an aneroid having a dial giving 160 simple predictions according to the reading of the barometer, the wind direction (as shown by the clouds), and the season. It is apparently similar in principle to a synoptic table published by the author some years ago, in which an index, when made to point to the wind direction, gave at right angles the direction of the centre of low pressure (Buys Ballot's law), then in concentric circles was given the probable weather for certain barometric conditions and for the particular season, based upon average conditions obtained from a large number of actual cases. The plan is founded upon scientific principles, but the apparatus can only be regarded as a popular indicator of possible changes in accordance with certain general types of weather.

MR. J. J. HICKS has sent us an account and some readings of Bartrum's open-scale barometer. The lower part of the instrument is like an ordinary mercurial barometer, and near the upper surface of the mercury the tube is enlarged, while above the surface it is again reduced and continued upwards for a length of 27 inches or more. The narrow tube above the mercury contains a red fluid, the upper end of which gives the barometer reading; a rise of mercury in the enlarged part of the tube causing a much greater rise of the fluid in the upper tube. The arrangement is very ingenious, and the readings agree well with the mercurial barometer reduced to a temperature of  $62^{\circ}$ , after the application of certain corrections, but we do not see why the correction should not be altered to agree with the standard temperature of  $32^{\circ}$  instead of  $62^{\circ}$ . By the adoption of artificial inches, and adjustment at some neutral point, the error for capacity might possibly be eliminated. An inch of mercury is represented on the scale by about 9 inches, and it is claimed that this long range enables a reading to be taken to one-thousandth of a mercurial inch without a vernier. The instrument appears to be more reasonable and accurate than other large scale barometers hitherto introduced, and is certainly more handy.

THE best method of using oil in calming troubled waters is thoroughly investigated in a pamphlet entitled "Die Lehre von der Wellenberuhigung," written by Dr. M. M. Richter. The author calls attention to a fact of paramount importance, viz. that the quieting effect of all oils or soaps used is in direct proportion to the amount of free oleic acid they contain. The chief desiderata in an efficient material for the purpose are chemical and physical stability, safety, and speed of expansion over the surface of the water. Such a substance would be found in free oleic acid dissolved in methyl or hexyl alcohol. The advantage of the alcohol is twofold. It prevents the solidification of the oleic acid at  $4^{\circ}$  C., and it greatly increases the rate of expansion. The latter depends, as the author shows, not so much upon a difference of surface tension as upon the solubility of the expanding surface in water. The observed fact that the more

viscous oils are more effective than the more mobile ones, is accounted for by the process of manufacture. Olive oil is prepared by pressing out the olives in the cold, while the various fish oils are prepared at high temperatures, and are much more efficient, owing to the decomposition of the oleic glyceride into glycerine and free oleic acid. But to save the prejudices of experienced navigators, who have found the more viscous oils answer their purpose better, Dr. Richter recommends that the oleic acid mixture be kept as viscous as possible. The force with which a drop of oleic acid spreads over the surface of sea water is sufficient to arrest the motion of a log of wood weighing as much as fifteen grams, when blown by a fairly strong wind, and even to start it in the opposite direction.

AT a recent meeting of the Société Française de Physique, M. Pellat read a paper on the point of application of electromagnetic forces. In the classic experiment of Foucault, where a disc of copper turns between the poles of a magnet, the electromagnetic forces acting on the induced currents, which are developed in the moving disc, do not perform any work, as can be seen from the following consideration. If we rotate the disc by expending an amount of work  $W$ , say by means of a falling weight, when the driving force ceases to act, the disc will be rapidly brought to rest. If now the disc is brought back to its initial state by the removal of the quantity of heat  $Q$  which has been developed, then  $T = JQ$  where  $T$  is the total work done by external forces on the system (disc). Now  $T$  is made up of two parts: (1) the work  $W$  supplied by the falling weight, (2) the work ( $x$ ) performed by the electromagnetic forces (also external forces, since we are not considering the magnet as forming part of the system under consideration). Therefore  $W + x = EQ$ ; but Violle has shown that  $W = JQ$ , hence  $x = 0$ , or the work done by the electromagnetic forces is zero. If, as is usually done, we suppose that the electromagnetic forces act on the matter conveying the electric currents (in this case the disc), then the resultant of these forces is so directed that if the point of application were displaced during the rotation they would perform a negative amount of work. Hence since  $x = 0$  the point of application of the electromagnetic forces does not move as the disc rotates. If, however, we suppose that the electric current is the point of application of the electromagnetic forces, then, as has been shown by Nobili, Antinori, and Matteucci, the position of the induced currents being fixed with reference to the magnet, there will be no work done by these electromagnetic forces. To explain how the energy of rotation of the disc becomes converted into heat, it is sufficient to admit that the induced currents (whose positions are fixed in space) exert a kind of friction on the moving disc. The following mechanical device is mentioned by the author as giving a representation of what happens in the electrical case: a copper disc  $D$  has its opposite faces pressed between the two arms of a clip  $P$  in such a manner that if the clip is held the disc turns with some friction. If the disc and clip are set in movement by the expenditure of an amount of external work  $W$ , then, if nothing prevents it, the clip will be dragged round by the disc. If, however, a pin  $B$  is placed so that the clip cannot rotate, then the disc will lose its energy of rotation, which will be converted into heat by the friction of the clip. The external force which has acted, *i.e.* the pressure exerted by  $B$  on the clip, has performed no work since its point of application has not moved. The quantity of heat developed in the disc and clip will be the equivalent of the work  $W$  spent in putting the disc in rotation. Thus the clip represents the induced currents in Foucault's experiment, and the pressure exerted by the pin  $B$  on the clip represents the electromagnetic force.

A COPY of the "Handbook of Jamaica," published by Mr. Edward Stanford, has been received. The work is now in its fourteenth year of publication, and comprises statistical, his-

tical, and general information concerning the island, compiled from official and other trustworthy records by Mr. S. P. Musson and Mr. T. Lawrence Roxburgh.

WE have received the first number of a new journal published at Oporto, and entitled *Annaes de Sciencias Naturaes*. The articles are mostly written in Portuguese, and among them we notice one on the flora of Oporto, and another on the birds of Portugal, as well as numerous notes on natural science matters.

MESSRS. MACMILLAN AND CO. have issued the thirty-first volume of the "Statesman's Year-Book," edited by Mr. J. Scott Keltie. The statistics have been well revised, and renewed in cases where recent information rendered such a course desirable. These changes, and the many additions that have been made, bring the volume in touch with current topics and maintain its character as an indispensable work of reference on all statistical and historical matters relating to the States of the world.

SEVERAL new crystallised compounds of hydroxylamine with the chlorides and sulphates of cobalt and manganese have been isolated by Dr. Feldt in the laboratory of the University of Berlin. The chlorides are analogous to the salts containing zinc, cadmium, and barium described some few years ago by Crismer, being constituted upon the type  $RCl_2 \cdot 2NH_2OH$ . The sulphates, however, only contain one molecular equivalent of hydroxylamine, but contain two molecules of water of crystallisation. The compound  $CoCl_2 \cdot 2NH_2OH$  is obtained by digesting in a flask through which a current of hydrogen is passing, and which is heated by a water bath, an alcoholic solution of cobaltous chloride with four molecular equivalents of hydroxylamine hydrochloride and a few cubic centimetres of an alcoholic solution of free hydroxylamine. Air requires to be excluded, as brown subsidiary products are otherwise produced. The liquid after a short time deposits the new compound in beautiful rose-coloured acicular crystals, which are fairly stable, and may be preserved for months out of contact with the air. They detonate somewhat violently, however, when heated, owing to sudden decomposition. The manganese salt  $MnCl_2 \cdot 2NH_2OH$  may be similarly obtained, and is more stable than the cobaltous compound. It explodes at  $160^\circ$ . The sulphates cannot be prepared in alcoholic solution, owing to the sparing solubility of the constituent sulphates in alcohol. By employing aqueous solutions salts of a similar nature are obtained, but with the difference of composition above mentioned. Both the salts  $CoSO_4 \cdot NH_2OH \cdot 2H_2O$  and  $MnSO_4 \cdot NH_2OH \cdot 2H_2O$  are similar in appearance to the chlorides, and are considerably more stable in their nature. The most interesting of Dr. Feldt's preparations, however, is a salt  $CoCl_3 \cdot 6NH_2OH$ , analogous to the well-known luteo-cobalt-ammonium chloride. When aqueous or alcoholic solutions of cobaltous chloride and hydroxylamine are mixed in contact with air, the rose-coloured precipitate rapidly darkens, taking up oxygen in all probability to form the compound  $CoOCl \cdot 2NH_2OH$ . If this substance is suspended in strongly cooled alcohol, and a similarly cooled alcoholic solution of hydrochloric acid is allowed to fall slowly in, a dark green liquid is produced, which eventually deposits a yellow crystalline powder. This precipitate dissolves readily in dilute aqueous hydrochloric acid, and the solution yields on evaporation the luteo-salt in large, well-formed, bronze-coloured crystals belonging to the monoclinic system. This somewhat remarkable compound is a particularly stable substance, which yields a crystalline precipitate of the corresponding oxalate,  $Co_2(C_2O_4)_3 \cdot 12NH_2OH$ , upon the addition of ammonium oxalate solution. Full details of the work are contributed to the *Berichte*.

THE publisher of "Der Botanische Garten zu Buitenzorg auf Java," and "Eine Botanische Tropenreise, Indo-malaysische  
NO. 1273, VOL. 49]

vegetationsbericht und Reisekizzen," published in these columns last week, is W. Engelmann, of Leipzig.

The additions to the Zoological Society's Gardens during the past week include a Diana Monkey (*Cercopithecus diana* ♀) from West Africa, presented by Miss L. D. Summerbell; a Wild Cat (*Felis catus* ♀) from Inverness-shire, presented by Mrs. Ellice; two Collared Peccaries (*Dicotyles tajaou* ♀ ♀); a Globose Curassow (*Crax globicera* ♂) from British Honduras, presented by H.C. Sir Alfred Molony, K.C.M.G.; two Cape Bucephalus (*Bucephalus capensis*); a Cape Viper (*Causus rhombeatus*) from South Africa, presented by Mr. J. E. Matcham; two Crossed Snakes (*Psammophis crucifer*); a Smooth-bellied Snake (*Homalosoma lutrix*); a Rhomb-marked Snake (*Psammophylax rhombeatus*) from South Africa, presented by Messrs. H. M. and C. Beddington; a Crossed Snake (*Psammophis crucifer*); a Hoary Snake (*Coronella cana*); a Puff Adder (*Vipera arictans*) from South Africa, deposited.

#### OUR ASTRONOMICAL COLUMN.

COMET-SPECTRA AS AFFECTED BY WIDTH OF SLIT.—The unaccountable differences between the spectrum of burning or electrically glowing carbon and the carbon bands observed in comets are successfully explained by Prof. H. Kayser in the *Astronomische Nachrichten*. The chief differences observed between the cometary and terrestrial spectra are the following:—The carbon flutings in the laboratory have a bright edge on the red side, which in the comet spectrum is displaced towards the red. But the maximum of luminosity in the latter is more refrangible than the bright edge in the former. Whereas in the true carbon spectrum the first fluting is the brightest, in cometary spectra the second has often appeared brighter than the first. It is suggested that all these anomalies are due to the fact that in astronomical spectroscopy the slit cannot be closed so far as in the laboratory, when the objects observed are as faint as comets usually are. If we suppose the true spectrum to be that produced by a very narrow slit, we may reproduce the impure cometary spectrum by sliding a wide slit along the true spectrum, and adding up for every position the strips of the true spectrum covered by the slit. We shall thus obtain the portion of the impure spectrum corresponding to the centre of the slit. When the wide slit encounters a band with a bright edge towards the red, it will at once begin to indicate a brightness, which will gradually increase until the slit is completely filled with light. The maximum will then have been obtained, and we see that it does not correspond to the bright edge, but to a line within it. Thus the first two anomalies are accounted for. Finally, if the slit is so wide that it comprehends two carbon bands at the same time, the maximum will not be obtained when the first or the second band occupies its centre, but when the first is just leaving and the third just entering. This accounts for the third anomaly. The experiment may be easily performed in the laboratory, by observing the arc spectra of calcium or iron. On widening the slit the line spectra of these elements show the same positions for the widened lines, but the carbon bands are diffused towards the red, and their maxima are displaced towards the violet.

THE ASTIGMATISM OF ROWLAND'S CONCAVE GRATINGS.—The astigmatism of the Rowland concave grating gives to this form of spectroscope the advantage of showing no dust lines along the spectrum, and of broadening out the spectrum of a star or a small electric spark into a band; but the same property makes it unsuitable for the simultaneous observation of two spectra by the usual method of illuminating one part of the slit with one source of light, and the other part with another source. By a special device, Prof. Rowland has no difficulty in obtaining photographic comparison spectra, but his method only holds good for photography. In a recent pamphlet by Dr. J. L. Sirks (Amsterdam: Johannes Müller), however, it is shown that a slight modification of the ordinary method will enable the desired comparison to be made, at least in the first and second order spectra. The comparison prism, or equivalent arrangement for introducing a second source of light, needs only to be placed some distance from the slit, at a point de-

terminated by the intersection of the line joining the slit and the grating, with a line drawn through the focus at a tangent to the circle having its centre in the middle of the line joining the grating with the focus. It is further suggested that the special qualities of a Rowland grating which are due to its astigmatism may be imparted to a "dioptric" spectroscope by giving a slight convex spherical curvature to one of the prisms, so that the instrument becomes slightly astigmatic.

### THE INSTITUTION OF NAVAL ARCHITECTS.

LAST week the Institution of Naval Architects held their annual spring meeting, under the chairmanship of Admiral Sir John Dalrymple Hay, one of the Vice-Presidents of the institution, the President, Lord Brassey, being absent abroad. There was an unusually strong list of papers; perhaps almost too strong, for it was impossible to do justice to the sixteen contributions, to say nothing of the formal proceedings and the chairman's address, within the limited space of a three days meeting. Some of the papers might have been referred back to the authors with advantage, notably the two long contributions, one on the detachable ram, and the other on the comparative merits of the cylindrical and water-tube boilers.

The following is a list of the papers on the agenda:—(1) "The qualities and performances of recent first-class battle-ships," by W. H. White, C.B., Assistant-Controller of the Navy, and Director of Naval Construction; (2) "The amplitude of rolling on non-synchronous waves," by Emile Bertin, Directeur de l'École d'Application Maritime, Paris; (3) "The stresses on a ship due to rolling," by Prof. A. G. Greenhill, Royal Artillery College, Woolwich; (4) "On Leclert's theorem," by Prof. A. G. Greenhill; (5) "Recent experiments in armour," by Charles E. Ellis, Managing Director of John Brown and Co., Limited, Sheffield; (6) "The detachable ram, or the submarine gun as a substitute for the ram," by Captain W. H. Jaques, late U.S. Navy; (7) "Leaves from a laboratory note-book: (a) some points affecting the combustion of fuel in marine boilers; (b) the spontaneous heating of coal," by Prof. V. B. Lewes, Royal Naval College, Greenwich; (8) "The circulation of water in Thornycroft water-tube boilers," by J. I. Thornycroft; (9) "On water-tube boilers," by J. T. Milton, Chief Engineer Surveyor Lloyd's Registry of Shipping; (10) "On the comparative merits of the cylindrical and water-tube boilers for ocean steamships," by James Howden; (11) "Further investigations on the vibration of steamers," by Otto Schlick; (12) "On the relation between stress and strain in the structure of vessels," by T. C. Read and G. Stanbury, assistants to the Chief Surveyor Lloyd's Registry of Shipping; (13) "Steam pressure losses in marine engines," by C. E. Stromeayer, Engineer Surveyor Lloyd's Registry of Shipping; (14) "Experience with triple expansion engines at reduced pressures," by D. Croll; (15) "Fluid pressure reversing gear," by David Joy. M. Bertin's paper and Prof. Greenhill's second paper were taken as read.

Mr. White's contribution had been looked forward to with some interest, as it was anticipated that a somewhat lively discussion would ensue between the constructors of the Admiralty and naval officers on the question of the rolling of the *Resolution*, a subject dealt with by the author. Although the admirals mustered in some force, the discussion was of a very quiet nature, and the general opinion was that the *Resolution* and her sister-ships are perfectly safe vessels, and quite as well designed in regard to rolling capabilities as the tried battle-ships which have preceded them. That this fact could be shown by scientific reasoning was known beforehand to those acquainted with the elements of design of the ships, and having sufficient technical knowledge to draw conclusions from the premises. Nevertheless the doubts raised by the fact that the *Resolution* had put back to port after encountering a heavy storm in the Bay of Biscay, and the certainly extravagant newspaper reports of the occurrence were an unpleasant feature, especially as they appeared to be shared by a certain number of naval officers. It is well, therefore, that the discussion took place, and the matter has been set at rest. Mr. White's was a very long contribution, far too long for us to attempt even to abstract it here; but it was none too long for the patience of the meeting, as it was full of suggestive matter from beginning to end. The author dealt in a masterly way with the questions, in relation to battle-ships, of draught and trim, stability, metacentric height, curves of

statical stability, period of oscillation, bilge keels, behaviour at sea, the behaviour of the *Resolution* in December 1893, performances under steam, manœuvring powers, relative size and cost of *Royal Sovereign* class, and the *Centurion* and *Barfleur* class. Unfavourable comments have been made on the *Royal Sovereign* class—the eight battle-ships of the Hamilton programme, of which the *Resolution* is one—because they have rolled heavily when small vessels have been comparatively steady. This, of course, is a circumstance for which the laws of nature are responsible rather than the designers of the ship; for however talented a naval architect may be, he cannot destroy natural laws, but can only seek to work so that they may be on his side, rather than fly in their face. To this end the constructor attempts to dispose dimensions and weights so that the natural period of oscillation of the ship may not synchronise with the period of waves more commonly encountered. A fair metacentric height is, of course, necessary in order that the ship may have stability, but an unduly large metacentric height tends to lessen the period of oscillation, and thus brings the period of the ship more nearly into harmony with that of waves ordinarily occurring. In fact, excessive stiffness produces undue motion amongst waves, whilst a very steady comfortable vessel might be one in danger of turning over under very small impulses. These facts are well known, of course, to those accustomed to the design of vessels, but they apparently are not fully grasped by many of those who go to sea in ships, to judge by the correspondence called forth by the *Resolution* incident. After the discussion that has been called forth by that incident, and the instruction given in connection with it, a hope may be expressed that "stability" and "steadiness" will not always be taken to accompany each other. The metacentric height of the *Royal Sovereign* class of the barrette type is  $3\frac{1}{2}$  feet, and past experience has shown that an excellent combination of stiffness and steadiness has been obtained with metacentric heights varying from  $2\frac{3}{4}$  to  $3\frac{1}{2}$  feet. It may be taken for granted that it is desirable to give vessels a long period in order to gain steadiness, and with these big vessels the metacentre could be higher than in smaller craft, and, under extreme conditions of lading, the *Royal Sovereign* class could have as great a height as 4 feet without unduly impairing their prospect of steadiness, whilst of course the stiffness would be great. It is worthy of note that the inclining experiments made with the *Royal Sovereign* showed the calculated centre of gravity to be but  $1\frac{3}{4}$  inches above the actual position; a result which speaks well for the care with which designs are got out at Whitehall. The period of oscillation of the *Royal Sovereign* with normal weights and  $3\frac{1}{2}$  feet metacentric height, is about eight seconds. This accords with the period of battleships which have acquired good reputations for steadiness in times past. Most of the latter ships, Mr. White tells us, have smaller metacentric heights, but they are also inferior in weight and moment of inertia; the latter, it must be remembered, having an important influence on the period of oscillation. Mr. White did not think it necessary to explain to a professional audience the manner in which rolling depends on the agreement between the period of the ship and the period of the wave, a fact that must be apparent to anyone who considers how a child's swing may be caused to oscillate through a wide range by small impulses applied at the right moment. Apparently the *Resolution* fell in with a sea, on the memorable occasion in the Bay of Biscay, which tilted her from side to side just as she herself was inclined to roll, whilst the little torpedo gun-boat *Gleaner*, which accompanied her, and made so much better weather of it, was not "fitted" by the big sea. In more moderate and more ordinary weather the relative conditions might have been reversed. In any case, it is as well to repeat, the *Resolution* at her greatest angle of roll had an ample margin of stability, and there was no reason to fear for the ship, although it was doubtless remarkably uncomfortable on board, and the captain exercised a wise discretion in coming back, having, as he did, an entirely untrained crew under him.

The paper by M. Emile Bertin treats with the subject of rolling of ships from a mathematical stand-point, carrying on the investigation of the question from a point where it was left by the late Prof. Jenkins, in a paper wherein he investigated the maximum effect which takes place at the extreme angle of roll. The author extends the theory to the effect at any intermediate part of the oscillation, and to the case in which the angle of maximum-righting moment may be less than a right angle. The difficulty of exact measurement of rolling is shown by the paper; a fact also well illustrated by Mr. White in the previous

contribution. The ordinary pendulum instrument has been known to give indications 50 per cent. from truth, and it is evident that all statements as to the rolling of ships at sea—other than those obtained by a trained staff of observers with approved appliances—must be taken with a very large grain of salt.

On the second day of the meeting, Thursday, March 15, the proceedings opened with Mr. Ellis's very interesting paper on armour. This was another long contribution, with an appendix which gave results of all firing experiments on nickel steel and Harveyised armour that have taken place, excepting two, and one of these is to be included later. The other was made with a Harveyised steel plate so manifestly inferior as not to be considered fairly within the category. There was not much discussion of results or expression of opinion in the paper, and it would be useless to attempt to abstract the details of the trials. The memoir will remain a standard record of what has been done in this field up to the present time, and as such we must be content to leave it. The discussion which followed was much of the same nature as the paper; but the gratifying fact seemed apparent that at present English makers of armour-plates are somewhat ahead of their foreign competitors. How long it will be before the see-saw of inventive progress will again put another country in the front, remains to be seen, and doubtless depends chiefly to what extent monopoly is allowed to rule.

The leaves from Prof. Lewes's laboratory note-book did not form quite so valuable a paper as we are accustomed to get from him. A good deal that was said about combustion was certainly not new, even to the common engineer who has not made a special study of chemistry, and the many practical points missed seriously detracted from the value of the matter set forth. Thursday evening's sitting was the big one of the meeting, indeed we have seldom seen the theatre so overcrowded as it was when Sir Nathaniel Barnaby took the chair at seven o'clock. The water-tube boiler is the great marine engineering question of the day, and there was a prospect of it being fully discussed after the reading of the three papers that were on the list. The boiler has never received the attention it deserves at the hands of engineers, the steam-engine apparently affording a much more interesting field of research. The neglect has carried with it its own punishment, for the boiler has always been the most fruitful source of trouble to the marine engineer. To such an extent has this been the case of late that engineers have perforce had to turn their attention to the less interesting branch of machinery design. The advent of the three-stage compound engine, and the consequent demand for higher pressures, has emphasised the need for a new departure, although the introduction of the corrugated flue and the application of steel to boiler construction has delayed the crisis somewhat. These advantages have, however, been fully worked up, yet still there is a demand for further advance, and a large number of prominent marine engineers appear to think that the water-tube boiler, or pipe boiler—in which the water is inside the tubes, and the fire outside—is the proper solution of the problem. Mr. Thornycroft—the well-known torpedo boat builder, who took the leading part in introducing the locomotive type of boiler afloat—was perhaps the earliest of the present-day advocates of the water-tube boiler in this country to experiment and invent. The result of his labours is that he has produced a water-tube boiler at once safe, quick steaming, light, economical, and durable. The chief point which has led to the attainment of these desirable qualities is that he has been able to combine automatic and sufficient water circulation with small water spaces. His boiler consists of three horizontal cylinders which are placed so that in cross section of the boiler they are at the three angles of an imaginary triangle. The top cylinder at the apex is connected to the two cylinders at the base by two series of curved pipes which form the heating surface of the boiler. The grate is under the base of the triangle, and the whole is enclosed in a smoke-jacket or casing, the chimney naturally being at the top. The products of combustion pass among the tubes, and thence up the chimney. Outside the casing the top cylinder is connected to the two bottom cylinders by a couple of large pipes. The top cylinder may be from a foot to three feet in diameter, according to the size of the boiler; the bottom cylinders are considerably smaller, and the pipes forming the heating surface will be about one inch in diameter. The circulation of water, the chief feature which has led to the success of this steam generator, is obtained in this way:—When the one-inch pipes become heated, the water in them is

turned partly into steam, and thus the mass becomes of less specific gravity than the column of solid water in the down-comer pipes outside the casing which connect the extreme end of the top cylinder to the extreme ends of the bottom cylinders. An ascending current of steam and water is thus set up in the tubes, whilst there must necessarily be a descending current in the down-comer pipes to compensate. In this way the water is always travelling round in a continuous stream, up the hot steam generating pipes, and down the colder down-comer pipes outside. Mr. Thornycroft has made some very pretty experiments with one of his boilers, which we lately had an opportunity of seeing at his works at Chiswick. He fitted a glass end—made of a number of sheets of plate-glass stuck together by a transparent cement—to the top horizontal cylinder, so that the circulation could be seen and measured. For the latter purpose a notched weir was put in the end of the cylinder, and the flow over it gauged according to the usual formula. The ends of the steam generating tubes could be seen spouting out water intermittently, and the circulation of water is so thorough that it was found by the weir measurements that the circulation of water was 105 times as rapid as the evaporation; that is to say, for each pound of steam generated 105 lbs. of water passed round the system, or, in other words, an equivalent of every pound of water passed 105 times round the cycle before being evaporated. It will be evident that with a volume of water sweeping with a rapidity such as this through the generating tubes, the surface would not be likely to be overheated, whatever the rate of combustion might be, and however fierce the fire. The problem of "drowned tubes" *v.* "above-surface tubes," which appears to be likely to be the burning question of the hour in water-tube boiler circles, is one into which we cannot enter here. Mr. Thornycroft is the leader of the "above-surface" school, whilst his great rival of the lower reaches, Mr. Yarrow, heads the "drowned tube" believers. Undoubtedly the Thornycroftians have more rapid circulation on their side; the question arises whether the Yarrowians have circulation enough.

Mr. Milton's paper consisted of a description of various types of water-tube boiler at present before the engineering world. It contains a large number of illustrations, and forms a valuable addition to his paper on the same subject read at the last summer meeting of the Institution held in Cardiff. Of Mr. Howden's paper it is not necessary to speak.

Friday's proceedings opened with a most interesting paper by Mr. Otto Schlick, whose investigations into the question of vibration of steam vessels will become classic. This further contribution carries the problem a step further, or, perhaps it should be said, enables the engineer to draw his conclusions with greater clearness. By means of a model designed to represent the hull of a steam vessel, the author showed the effect of placing various engines in different parts of the vessel. There were engines of many types—single, double, triple, and quadruple cranks. Pistons were weighted to represent difference in sequence of cylinders, and cranks were arranged at various angles. The model engines were shifted from part to part of the plank which represented the hull of the vessel. This plank, suspended from a frame by helical springs, naturally had a period of vibration of its own, which period was of the first order, *i.e.* with two nodal points; and as the engines were placed upon the nodes or else in other positions, the vibration was intensified or not when the revolutions of the engines reached that critical number, when synchronism was obtained between revolutions and the period of vibration of the plank or hull, according to the now well-known rule. We cannot pretend to give all the varying changes that were rung by Herr Schlick upon his model. Sometimes the changing of the high pressure for the low-pressure piston would start most violent oscillations, or *vice versa*, whilst the shifting of the engines to an equivalent of a few feet in an actual ship would have a really wonderful effect. For the details of these experiments we must refer our readers to the original paper, wherein both naval architects, engineers, physicists, and mathematicians may find matter of much interest.

Messrs. Read and Stanbury's paper is one of that admirable series on the subject of stress and strain in vessels upon which the first-named author especially has devoted so much time and thought. The present is a paper of almost purely professional interest, and is one with which it would be impossible to deal in brief. Mr. Taylor's paper was not read, Mr. Froude, in the absence of the author, giving an abstract. The problem of calculating the pressure and velocity of water at

every point of the immersed surface of a ship, upon the lines and speed being given, is one which will long remain to be solved; but every step towards that end must be of interest, and the best way to proceed is naturally to divest the subject of those elements which tend to obscure its solution, and thus grapple with difficulties in detail. This the author proceeds to do by imagining a set of conditions which by no means exist. Thus, he supposes the surface of the water covered by rigid smooth ice, and the vessel to be flat-bottomed with vertical sides. In this way similar water lines are obtained, and the flow of water will be in plane stream lines only. This simplifies the work, since the methods and formulæ dealing with stream lines in two dimensions are much simpler than those for stream lines in three dimensions. The author proceeds to work out his problem on these lines at some length, and it will be evident from what has been said that it would be impossible to deal adequately with the question in a report such as this; in fact, the paper requires more study than we have been able to give to it up to the present. A short discussion followed the reading.

Mr. Stromeyer's paper discussed steam pressure losses in steam-engines due to various causes, such as friction of steam in pipes and passages; the spring of eccentric straps, rods, and links; inaccuracies in slide valve motion; piston leakage; throttling of steam, &c. Mr. Croll's paper dealt with a subject that has occupied the attention of marine engineers for some time past—the best method of working engines at lower powers; and Mr. Joy described his arrangement for reversing engines by means of an hydraulic cylinder placed inside the eccentric, so that an effect, in some respects, similar to that obtained by means of the loose eccentric is reached without the uncertainty of the latter device, and also with the further benefit of being able to "link up" or to stop the engines by making the eccentric disc coaxial with the shaft. The arrangement is certainly a very taking one, and appears to promise well, though of course such a tried device as link motion will not be ousted until any new arrangement has thoroughly proved its superiority.

The meeting terminated with the usual votes of thanks. The summer meeting will be held at Southampton, in July.

### CHOLERA.<sup>1</sup>

IF anyone had undertaken, thirty years ago, to classify the communicable diseases according to whether they are easy or difficult of prevention, he would have doubtless placed cholera, the disease I have chosen for the subject of this lecture, in the front rank amongst the non-preventible, or, at any rate, amongst those diseases that are preventible with very great difficulty; while, if anyone were at the present time to revise this classification, he would find himself in the fortunate position of placing cholera in the front rank amongst those diseases that are easily prevented; in fact, he would be able to tell you that the prevention of the spread of cholera is beset with less difficulty than that of some of the communicable diseases which in towns we have almost constantly among us, as, for instance, pneumonia, diphtheria, measles, and scarlet fever. Nothing could more forcibly illustrate the great advance in practical sanitation than the comparative immunity from cholera in an epidemic form, which this country has enjoyed for the last twenty-five years. By saying "comparative immunity," I am not forgetting that we have had cases of Asiatic cholera in this country during the last autumn, and it is precisely the remarkably limited character of this last outbreak which furnishes the best proof of our advance in sanitation, and gives satisfactory evidence of the correctness of the views on which the measures adopted for the prevention of the spread of cholera are based, and of the justification of placing cholera amongst the easily preventible diseases. To give you an idea of what sanitation has been able to do, and the complete success which attended the practice of good sanitation in preventing the spread of cholera, I will quote in illustration the following remarkable instance:<sup>2</sup>—A well-known fact which has received, unfortunately, a great many illustrations, is this: that pilgrims in India carry the contagium of cholera from the fairs or festivals, to which the disease is brought from the endemic area, to localities which were

previously free from cholera. One such fair is particularly notorious, and it has in the past always been a source of the utmost anxiety to the Government of India; this is the great religious festival or Kumbh fair of Hardwâr, a town on the Ganges, but situated outside the endemic area of cholera. This great Kumbh occurs once in twelve years, and it is attended by large numbers of pilgrims, a proportion of these coming from districts in which cholera is always endemic. It has thus frequently happened that this great concourse of pilgrims has been followed by a wide diffusion of the disease. The great Kumbh is principally a religious festival, and is looked upon by Hindus as one of peculiar sanctity, and the very aim and object of their pilgrimage is to bathe in the sacred Ganges, and drink of its holy waters. In 1891, when the last Kumbh fair was held, 800,000 to 1,000,000 pilgrims assembled in Hardwâr; and to get an approximate estimation of the enormous pollution to which the sacred Ganges at Hardwâr is on this occasion subjected, and the great risk from cholera to which those who drink of its waters are exposed, I will mention what Dr. Simpson, the able health officer of Calcutta, states. In describing the scene at the "sacred pool" at Hardwâr—somewhat retired from the rest of the river—to bathe in which and to drink whose waters the pilgrims gather together in such multitudes, Dr. Simpson states that as the bathing of the pilgrims went on the clear stream became a muddy one; that from April 8 to 12 there was always passing through the sacred waters a "seething mass of humanity" in constant motion, passing through the pool at the rate of 400 to 500 per minute. You can easily picture to yourself that a few cases of cholera introduced into such a multitude, living under such conditions, would easily cause not only an outbreak of cholera there and then, but would by the returning pilgrims be carried far and wide. Thus a sanitary commissioner says of the Kumbh, previous to 1867: "Very little remains on record, but that little is a record of disease and death." In 1867, and again in 1879, the festival was followed by an epidemic outbreak of cholera, which on the latter occasion rapidly extended to the western districts. Now, all through the winter of 1890-91 there was much cholera in the north-west provinces and along the pilgrim routes below the hills. So grave was the outlook; that the question of prohibiting the fair to be held in April, 1891, was seriously discussed, and the official opinion of a civil-surgeon, in conformity with that of many other officials of great experience, was to the effect that "the most complete sanitary arrangement will be powerless to prevent the spread of cholera should the contemplated fair at Hardwâr be permitted to take place." Now mark what Mr. Ernest Hart says:

"The fair took place in April, 1891. In December, 1890, proceedings began at and about Hardwâr by the construction of seven bridges, by means of which access to the sacred pool from various parts was much facilitated. The whole of the site was then cleared of undergrowth, all filth was scraped away and removed, and arrangements made for the trenching of night soil. A small army of 1342 sweepers was engaged, and means were taken to prevent their desertion, an event which previous experience had shown to be not unlikely. The whole site was divided into sanitary sections, each with its temporary hospital and its sanitary patrol, every constable of which had his own fixed beat, within which he was instructed to (1) prevent overcrowding, (2) see to surface cleanliness, (3) give notice and remove nuisances, (4) report offenders, (5) remove those sick of infectious diseases, (6) see to the proper location of animals. The sanitary, police, and medical sections were made to correspond, each section being equipped with a special hospital, a number of constables, sanitary inspectors, an ambulance, and a large staff of conservancy men. Each section was thus complete and self-contained, and was directly responsible to the sanitary and deputy sanitary commissioners for the conditions of its own area. The members of the sanitary patrol had each their given beats, over which they exercised a constant supervision, acting also as detectives for sickness.

"The key to the sanitary management of the fair lay in the searching out and rapid removal of all cases of suspicious disease, in the maintenance of perfect cleanliness in the camp, and in the measures taken to prevent all possibility of contamination. Various improvements, however, were made in the conduct of the bathing festival, which were no doubt of great importance.

"The pilgrims coming from cholera-infected districts brought the infection with them, and two people died of undoubted cholera at Hardwâr during the most crowded period, but they were promptly isolated, and the infection did not spread. No

<sup>1</sup> A Lecture delivered at the London Institution on February 15, 1894, by Dr. E. Klein, F.R.S.

<sup>2</sup> This account is taken from Mr. Ernest Hart's description in the *Daily Graphic*, September, 1893.



more cases arose in the town or camp, nor did the disease develop on the track of the dispersing pilgrims. And thus we had the novel experience of a Kumbh fair at Hardwâr without an epidemic of cholera spreading all over the surrounding country concurrently with the dispersion of the gathering."

This is unquestionably one of the most remarkable and brilliant achievements of sanitation in the whole history of cholera. Not only in India, but also in Europe, has it been demonstrated that cholera is a preventible disease. The history and character of the epidemic which prevailed in France, Italy, and Spain between 1884 and 1886, and in Russia in 1892 and 1893, was in no way different from what it used to be thirty years ago in other European countries; it is expressed by stating that the population of villages and towns of whole districts were smitten by disease and decimated by death. But it was different with England and Germany. In 1892 cholera broke out in Hamburg, and asserted itself with great severity; the insanitary conditions of its dock and port population, the neglect in supplying Hamburg with wholesome drinking water—Hamburg being then supplied with unfiltered, polluted Elbe water—brought for Hamburg the long-predicted day of reckoning. In former years the establishment of such a focus of cholera as Hamburg, having such vast communications and intercourse with the whole of Germany, would have been followed by innumerable foci of cholera all over Germany; yet we have the remarkable fact that, with the exception of few cases in a limited number of towns, Germany did not suffer from any further epidemic outbreaks. And in a perhaps more striking manner was the same fact illustrated in 1892, here in England. Grimsby, and Hull also, had cases of cholera in 1893, the former officially at the commencement of September, unofficially some weeks before. The sanitary condition of Grimsby, as revealed at the time by inquiry, and published by the *Times* and the *British Medical Journal*, remind us, in some respects, almost of the times and conditions of a former generation, and the result, as was to be expected, was an unnecessary loss of life through cholera. But although Grimsby carries on a considerable trade by rail and sea with the rest of England, and is in notoriously extensive personal railway communication with the rest of the northern and midland counties (*vide* the enormous fish and oyster trade of Grimsby and Cleethorpes, and the extensive tourist communication with Cleethorpes), with two or three exceptions in which a small local outbreak occurred (Ashbourne, Derbyshire; Rotherham, Yorkshire; North Bierley, Staffordshire), only isolated cases of cholera were noticed in the rest of England. What is this comparative immunity due to, what is the cause of the conspicuous limitation of cholera, that has been experienced lately both in England and Germany? In both countries foci of cholera had been established, sufficient, judging from former experience, for the dissemination and production of cholera in an epidemic form in numbers of localities, and although the transmission and spread of cholera from the first foci, owing to the increased facilities of human intercourse, was possible in a greater degree than in former periods, yet the country remained practically free from cholera epidemics.

Sir John Simon has years back insisted on the importance of considering cholera, as also typhoid fever, as a "filth disease"; that is to say, both in cholera and in typhoid fever the contagium voided with the dejecta of a patient, affected with the one or the other disease, is capable of setting up the disease, if it finds access to the alimentary canal of a susceptible person, either by specifically polluted drinking water or articles of food, or by the instrumentality of the hands that had been in contact with specifically soiled linen or other textile articles.

Since the recognition of these facts it has become an axiom in sanitary science to isolate the patient, to disinfect or destroy not only the dejecta, but all articles that may have become soiled by the dejecta of a patient affected with cholera, to prevent such filth from gaining access to drinking water and to articles of food, and to insist that the hands that have been in contact with such soiled articles ought to be scrupulously cleansed in order to avoid self-infection; in short, to prevent and to avoid the contagium being "swallowed." By carrying out these precepts it has become possible, and, as events proved, it has been successfully accomplished that cholera did not spread epidemically either at the last Kumbh fair at Hardwâr, or in England or in Germany. This success implies two things: (1) the locality, prior to the introduction of a case of cholera, should

be in a proper sanitary condition, and (2) on the appearance of a case of cholera the measures for isolation and disinfection should at once be put in practice; there should be no attempt at hiding or ignoring, but boldly and openly the fact should be recognised, and action taken accordingly; for if in any locality even a few cases are allowed to pass undealt with, and supposing the sanitary conditions of that locality be of an inferior character, the dissemination of the contagium and the creation of a number of further and independent foci may in a short time bring about a state of things in which the check of the epidemic spread of the disease becomes a matter of the greatest difficulty—an occurrence which had its illustration both in Hamburg and in Grimsby. Though a great portion of England may claim to be fairly well prepared, as far as general sanitation, drinking-water, drainage, and general cleanliness are concerned, it is notorious that there remain localities which escaped a visitation by cholera during last year; but their luck may not hold out on a second occasion, and a day of reckoning may arrive on which they will be rudely awakened, like Hamburg, to the fact that by their negligence in the past they have to pay a heavy penalty in human life.

Now, it will be asked, is it a fact that those isolated cases which occurred in different localities in England during the last autumn were really cases of true or Asiatic cholera, and that owing to the better preparation and stricter execution in regard to sanitary measures, insisted on by our Public Health authorities, those isolated cases did not spread, and were not followed by further outbreaks of the disease? It must be evident that if those cases were not cases of true cholera—that is to say, if they were of the character of that disease which occurs in each year during the summer and autumn in a sporadic form, known as English cholera or cholera nostras, then the above proposition as to the supposed superiority of our sanitation for the prevention of the spread of epidemic or Asiatic cholera remains as yet untried and has still to be proved. No one, I presume, will deny that we had in September, 1893, true or Asiatic cholera in Hull, Grimsby, and certain other places; the character of the disease, the grouping of the cases, and the high percentage of mortality prove this; besides, it is known that cases of cholera have reached our shores both in 1892 and 1893. Similarly, it will not be denied that the cases that occurred in Rotherham, Ashbourne, and North Bierley were of the same nature; the symptoms, the epidemic character, and the high fatality alone prove this. But what has been questioned is whether the isolated cases which occurred in Retford, Leicester, Derby, Doncaster, Yarmouth, London, and other places, were true cholera. Now, it is agreed that as regards their clinical history and mortality (these were all fatal cases) a distinction between them and typical true cholera could not be drawn. But it is said that (a) on account of their occurring as isolated cases, and (b) on account of the impossibility of tracing the way in which the infection had been imported, the proof that they were cases of true cholera has not been satisfactorily established.

As to (a). If in any locality after the appearance of one or more suspicious choleraic cases there should follow, sooner or later, a gradually increasing number of similar cases with high fatality, the preliminary conclusion that these are cases of true cholera is justified. But whether in any locality one case is followed by others, or remains an isolated one, obviously depends on the condition whether the contagium, either by the prevailing insanitary conditions, or by the laxity of the application of sanitary measures, has or has not been allowed to take a footing and to spread; for if, as stated above, the conditions as to drinking water, drainage, &c. are satisfactory, and if on the introduction of the first case this is at once isolated, its dejecta disinfected and destroyed, and infection from it therefore prevented from being disseminated, it is clear that no further cases would be forthcoming. The epidemic diffusion of the disease depends then on deficient sanitation, and cannot therefore be a distinguishing character between what is true and what is not true cholera. No one doubts that the few cases that were imported from cholera-infected districts in 1891 into Hardwâr were cases of true cholera, yet we saw that owing to the excellent and thorough sanitary measures taken before and during the fair no epidemic occurred; those few cases therefore remain cases of true cholera, notwithstanding the unwonted absence of an epidemic outbreak.

In a like manner it must be evident that numbers of persons that contracted the infection in Hamburg in 1892 travelled to many places in Germany where they sickened of, and some of

them succumbed to, the disease; others came over to England and to London, yet they did not produce an epidemic in the localities in which they arrived or died, for the simple reason that they were looked after, isolated, and their dejecta and belongings disinfected or destroyed. But they do not cease to be cases of true cholera, though they were not followed by others.

The following case, that occurred in England last September, may serve as an illustration. A man, landlord of an hotel in Retford, who for some days was suffering from diarrhoea, had been to Doncaster, where he partook of oysters brought from a cholera-infected locality. Soon after arriving home he was seized with violent cramping pains of the arms and legs, sickness, vomiting, and diarrhoea; the doctor who was called in noticed the altered voice, which was like a whisper; the patient was very restless, and complained of great depression; the evacuations were like rice-water, there was suppression of urine; he rapidly became collapsed, the extremities became cold, and the surface of the body livid and shrunken. He died after an acute illness of fifteen hours and a half. I have read to you the clinical history of this case because it presents the picture of true virulent cholera, such as is described in text-books as a most typical case of Asiatic cholera. It is presumable that the above person became infected by eating oysters, because these were derived from a place where cholera was rife, but it is only presumable so; the man had not been either at Grimsby, Hull, or Cleethorpes, or any cholera locality; but that he suffered from, and succumbed to true cholera, can hardly be doubted, and I shall give you presently further evidence to that effect; and yet this remained, thanks to the prompt sanitary measures taken, the only case of cholera that occurred at Retford. You see, then, that a case remaining an isolated one does not necessarily cease to be a case of true cholera.

As to (*b*). As regards the inability to trace every one of the isolated cases that occurred in the different localities to a previous focus of cholera, and the allegation on this ground that it remains doubtful whether these cases were or were not true cholera. It is unquestionably a great help, in order to make a correct diagnosis and to take the necessary precautions, to trace the manner in which the infection found entrance into a given locality. But, unfortunately, the way in which the contagium of cholera, as well as that of typhoid fever, travels, is not always a straight one or easily followed; in many cases the way can be followed with approximate accuracy, but in others—amongst them some epidemics of undoubted true cholera—the manner in which the contagium was introduced has baffled even experienced sanitarians, and it is owing precisely to such instances (they have occurred both in India and in Europe), that the solution of the problem as to the origin of some of those cholera epidemics is beset with great difficulties, and has called forth a division of opinion amongst epidemiologists. If the problem were of such simplicity as is implied by the assertion, that in every case of cholera we must be able to trace the infection to a known focus, the division of opinion as to the origin of some of the epidemics of true cholera would long ago have disappeared.

Koch first showed that in the rice-water-like dejecta and in the rice-water-like contents of the intestine of a typical case of Asiatic cholera, there occur certain bacteria, which, on account of their shape, were called by him comma-bacilli; he showed that in some of the typical cholera cases, in which the dejecta or the intestinal contents are of what is called rice-water-like character (that is to say, in a more or less translucent fluid are suspended large and small flakes, composed of the detached epithelium lining of the intestinal mucous membrane), the flakes, as also the fluid, contain these comma bacilli in enormous numbers; and that the flakes contain them in a characteristic linear arrangement, occasionally to the total exclusion of other kinds of bacteria, such as may be found inhabiting the normal alimentary canal.

I exhibit here on the screen photographs of the microscopic character of the rice-water-like dejecta of typical cases of Asiatic cholera; one from a case in India, several from typical cases that occurred last year in England. The illustrations show not only a great number of the comma bacilli and a total exclusion of other bacteria, but also the characteristic linear arrangement of the vibrios in the flakes.

It is now agreed by all who have devoted attention to this subject, that such a condition as I have shown you here does not occur in any other acute disease of the alimentary canal in man except in Asiatic or true cholera. A large number

of cases of cholera nostras, or English cholera, have been subjected to examination abroad and in England in non-cholera years, and the result was always the same—viz. a condition such as I described and showed to you does not occur in them. So much so, that all pathologists agree that, supposing a case presents the principal symptoms of cholera, inclusive of the rice-water-like dejecta, if the flakes suspended in the fluid portions of the dejecta show under the microscope crowds of the comma bacilli, particularly in the above linear arrangement, the diagnosis "true cholera" is fully justified. Whether a case of this kind is an isolated one, and whether we are able or unable to trace the way in which the infection has come about, does not, to my mind, alter the diagnosis in the slightest degree. We may be successful in putting our finger on the probable or demonstrable path on which the cholera infection travelled, or we may be baffled in this attempt; we may say—as in the cases that occurred in Hull and Grimsby, in Rotherham, Ashbourne, North Bierley, and elsewhere—here we have a succession of cases presenting all the clinical and pathological characters of true cholera, showing the high fatality found only in true cholera; the flakes of the rice-water-like evacuations show the microscopic characters observed only in Asiatic cholera; therefore we are dealing with true cholera, and we do not further trouble ourselves (for the object of making correct diagnosis) with finding out how the first case was introduced, particularly if we remember that most of these places, owing to their situation, may have been exposed to importation of the contagium from cholera-infected localities. Or we may say, as in the Retford case, we presume that the patient, having partaken of oysters which came from an infected locality, caught the infection through these oysters, and the case, presenting all the clinical and pathological characters of virulent true cholera, and the flakes of the intestinal contents showing the microscopic characters found only in Asiatic cholera, must be one of true cholera, notwithstanding that the case is for Retford an isolated one. But I fail to see how the assertion can be justified, that has been repeatedly made during the last autumn, of various isolated cases occurring in different localities—Leicester, Derby, Westminster, and others—viz. the assertion that these cases, which were all fatal, which presented the symptoms and pathology characteristic of virulent true cholera, and which showed in the flakes of the rice-water-like dejecta the microscopic appearances characteristic of, and found only in, true cholera. The assertion, I say, that these cases cannot be true cholera, because we were not able to trace the manner in which infection was introduced, and because they have not been followed by other similar cases, cannot be accepted.

I take for illustration the noted case of the woman, the cleaner in the House of Commons; she died in Westminster last September, after a very short illness; the symptoms were those of true cholera; the pathological condition of the intestine, the microscopic character of the flakes of the rice-water-like dejecta were such as are found only in typical cases of true cholera, and in no other known acute disease of the intestine; but the manner in which she contracted infection could not be discovered, nor was this case followed by others; rigorous sanitary precautions were at once applied to the house in which she lived and all that appertained to it.

I show you here the microscopic character of the flakes of the rice-water-like dejecta of this case, and you can see that it presents in a conspicuous degree the characteristic appearances, both as to the number and arrangement of the comma bacilli.

The comma bacilli, derived from cases of Asiatic cholera, when tested by cultivation under the different conditions, such as are used in the laboratory for distinguishing one species of bacteria from another, are admitted on all sides to represent a definite group of organisms, of which the principal distinguishing characters in cultivation and in microscopic specimens are shown in these photographs.

One character of particular interest which these cholera vibrios, or cholera spirilla, or Koch's comma bacilli show, is their behaviour when grown at the body temperature (37° C.) in a solution containing peptone and salt; in this solution they grow well and multiply very rapidly, and produce in it nitrites and indol; the presence of these products can be demonstrated already after a few hours (6-8) by adding to the culture a few drops of pure sulphuric acid; the culture at once assumes a distinct rose-coloured tint; this reaction is called the cholera-red reaction. Now, there are known other species of comma

bacilli or vibrios, which in shape, size, motility, manner of growth in the different media, more or less resemble the cholera vibrios of Koch. Some of them also give the cholera-red reaction, sooner or later, when grown in peptone salt culture.

But there is at present known only one comma bacillus from the diseased human intestine that shows certain cultural characters, that grows at 37° C. in peptone salt cultivation with great rapidity, and gives in very short time the distinct cholera-red reaction; and this is the comma bacillus of Koch, found by him in the human intestine in Asiatic cholera. From this it follows that if in any case of choleraic disease this particular species should by microscopic examination, and by the culture test, be demonstrated as present in the bowel, the conclusion is justified that we are dealing with true cholera.

In those isolated fatal cases of choleraic disease which occurred in different localities in England during last autumn (Leicester, Derby, Westminster, Doncaster, Yarmouth, and others), apart from the symptoms and the pathological conditions of the intestine and the characteristic microscopic appearances as to the distribution of the comma bacilli, this species of vibrio was demonstrated by cultivation, and therefore we are justified in saying that these cases were of the true or Asiatic type, and we are further justified in saying that it was owing to the prompt action of the sanitary authorities that these cases were not followed by epidemic outbreaks.

But while we can state from the bacteriological examination that a particular case is true cholera, we cannot affirm with equal reliability whether this comma bacillus plays any and which rôle in the causation of the disease; nor that a case in which the bacterioscopic examination does not demonstrate the presence of Koch's vibrios in the intestinal discharges is not true cholera; and this for the important reason that in various epidemic outbreaks of true cholera there occurred in the same locality and at the same time, side by side, with undoubted cases of Asiatic cholera, and presenting the same clinical symptoms, the same pathology, and the same high death-rate, a certain proportion of cases in which Koch's comma bacilli could not be demonstrated. In what respects the bacteriology of such cases differs from cases of sporadic or English cholera, is a subject for future inquiry; at present no sufficient data are at hand.

## GEOLOGICAL SURVEY OF THE UNITED KINGDOM.<sup>1</sup>

### I.

#### ENGLAND AND WALES.

*Drift Survey.*—In the early maps published by the Survey, superficial deposits were generally left unrepresented. The importance of these deposits in questions of agriculture, drainage, water-supply, and public health having at length been recognised, it was determined that in future they should be traced and shown upon the maps. As at first they were inadequately understood by geologists, the mapping of them could not be made wholly satisfactory and complete. But as they came to be more thoroughly studied and more carefully traced, they have been represented with increasing fulness and accuracy upon the maps. It has been thought desirable to revise and complete the earlier drift surveys in the north of England, and to extend these surveys over the other parts of the country where they have not previously been made. This renewed examination of the ground is carried on upon maps of the scale of six inches to the mile, and advantage is taken of it to check, and where needful to correct, the already published mapping of the older geological formations underneath.

As the Geological Survey advanced into the eastern counties of England, the importance of the drift deposits became increasingly manifest. Over large districts indeed it was impossible satisfactorily to delineate on maps the structure and boundaries of the formations underlying the drifts which spread as a deep cover above them. For such areas drift maps only could be issued.

<sup>1</sup> Annual Report of the Geological Survey for the year ending December, 31, 1892. By Sir Archibald Geikie, F.R.S., Director General. From the Report of the Science and Art Department for 1892. (Some of those portions of the Report which describe the scientific results of the Survey operations during the last few years are reprinted here.)

It was not until the original survey of the whole of England and Wales had been completed that the systematic re-survey of the drifts was begun on the six-inch scale, over those areas not previously surveyed for this purpose. In the south-east of England, where the work is under the charge of Mr. Whitaker, it has extended from Huntingdonshire across the counties of Bedford, Hertford, Buckingham, Oxford, Berks, Wilts, Hants, and the south of Sussex.

*Tertiary.*—The re-examination of the Tertiary areas to the west of London for the Drift Survey has shown the general accuracy of the old mapping, though the boundary-lines have been occasionally improved. In Hampshire and the Isle of Wight more extensive alterations have been necessary. Thus, the Hamstead Beds, in place of occupying mere isolated patches on the high ground, as was believed when the original map was prepared, are now known to cover a large area. This was proved by Mr. Reid, chiefly by the use of portable boring-rods, such as had for some time previously been employed by the Belgian Geological Survey. These tools have also proved of great service in some recent work in the eastern counties, Certain small outliers on the Chalk of Hampshire, shown as Eocene on the old map, have now been placed among the drifts, and have been mapped as "Clay-with-flints." Probably here, as is often the case in parts of the London Basin, the so-called "Clay-with-flints" is in great part re-arranged Eocene material.

*Cretaceous.*—On the older one-inch maps the Chalk was shown as one mass, no attempt being made to indicate its subdivisions. Indeed no such subdivisions were formerly recognised, save a general grouping into Chalk-with-flints and Chalk-without-flints. Sometimes the lowest portion was separately referred to as Chalk Marl. In later surveys, however, advantage has been taken of the opportunity of tracing on the ground the subdivisions that can now be mapped. These are as follows:—

- Upper Chalk.
- Chalk Rock.
- Middle Chalk, with Melbourn Rock (at the base).
- Lower Chalk, with Totternhoe Stone.
- Chalk Marl.

The separation of the thick mass of Chalk into so many distinct subdivisions has both an economic and a scientific interest. By revealing the actual structure of the Chalk and the outcrops of its several members the new mapping renders essential service in questions of water supply. It likewise indicates the undulations into which, in consequence of subterranean disturbances, the Chalk has been thrown. These undulations, though often too gentle to be safely inferred from surface exposures, are apparent when the outcrops of the several subdivisions of the Chalk are continuously traced.

In the Chalk-area of Hampshire, Mr. Hawkins, by mapping out these horizons, has proved the general accuracy of the interpretation of the structure of that region given by Dr. Barrois. The uprise at Winchester is well marked, Lower Chalk being there brought to the surface. The folds traversing the Chalk in the western part of the Hampshire Basin, though more strongly marked than those of the London Basin, can only be satisfactorily made out by mapping the subdivisions of the Chalk. Some of the ruptures attendant on the plication of the rocks, so marked in Dorsetshire, are prolonged even into Sussex, and have been detected by Mr. Reid as far east as Eastbourne, where on the foreshore the Cretaceous strata are repeated by faults and over-thrusts.

It seems not impossible that the detailed and accurate mapping of the disturbances in the Chalk may ultimately give a clue to the depths of the underlying Palæozoic rocks, a question of the utmost practical importance in regard to the tracing of coal-bearing deposits beneath the south of England.

In 1891 phosphatic Chalk, closely resembling that which is commercially worked in the North of France and in Belgium, was noticed for the first time in this country by Mr. Strahan. The bed is exposed in a Chalk-pit at Taplow, but at present has not been detected elsewhere.

The relations of the Gault and Upper Greensand have long been a matter of uncertainty. Mr. Bristow, the late Senior Director, believed that the two were really one formation, one being locally developed at the expense of the other. Mr. Godwin-Austen regarded the Upper Greensand as a shore-deposit, in part contemporaneous with the Gault of deeper waters. Other geologists have expressed similar views. These

opinions have received support from our recent surveys. The upper part of the Gault becomes more sandy to the west, and was there mapped as Upper Greensand; the clay coloured as Gault in Wiltshire representing only about the lower third part of the Gault of Folkestone. This clay becomes so thin to the west that it cannot be separately mapped.

Mr. Jukes-Browne makes three divisions of the Gault and Upper Greensand series, which are now found to constitute really one formation:—

3. Greensands and Sandstone, and chert beds (Zone of *Pecten asper*).
2. Buff Sands, Malmstones, and silty Marls; the last representing the Upper Gault (Zone of *Ammonites rostratus*).
1. Lower Gault Clays (Zone of *Ammonites lautus* and *Amn. interruptus*).

The Chert-beds of Wiltshire and Devonshire are local developments in the Zone of *Pecten asper*. They are not found in Dorset, but they attain importance in the Isle of Wight, and were there separately mapped by Mr. Strahan.

In the neighbourhood of Devizes the subdivisions of the Upper Greensand are well marked. The lower one, or "Malmstone," contains, especially in the lower part, colloidal silica in the form of small round globules and sponge spicules, sometimes to the extent of from 40 to 50 per cent. of the stone. The upper division, about 70 feet thick, near Devizes, consists of green and grey sands. As these are irregular in thickness, thin out rapidly to the north, and extend as a band in a nearly east and west direction, they may represent an ancient sand-bank. The persistence of the Malmstone over a very wide extent of the "Upper Greensand" of England is a noteworthy fact.

A revived industry of some interest on the borders of Bedfordshire and Buckinghamshire is the extraction of fuller's earth from the Lower Greensand. This deposit is now worked by mines on the flanks of the escarpment. Mr. Cameron has frequently visited these mines, and has described them in papers read before the British Association and elsewhere.

*Jurassic*.—Some of the most important recent additions to our knowledge of the structure of the Jurassic and Cretaceous rocks of the South of England have been made by Mr. Strahan in his re-examination of Dorsetshire for the Drift Survey. The area known as the Isle of Purbeck has long had a peculiar geological interest, not only from the fact that the Portland and Purbeck rocks there reach their maximum development, but also from its structure. It is traversed by an extremely sharp and faulted monoclinical fold, a continuation of the Isle of Wight monocline, from which, however, it differs in being accompanied by inversion of the strata and much overthrust faulting. This structure may in fact be regarded as an intermediate stage between a simple monocline and a complete overthrust. The deeply indented coast affords unusual facilities for examining the effect of the movement. The old one-inch map, on account of the smallness of the scale, gave merely a diagrammatic view of the structure of the "island." In the re-survey on the six-inch scale both the faults and the subdivisions of the strata have been traced with a detail that was before impossible. In the Isle of Purbeck the principal additions to the map consist in the tracing of the subdivisions of the Cretaceous system. The Lower Greensand, which is so well developed in the Isle of Wight, was known to exist in the Isle of Purbeck also, but its limits had never been determined. It has now been separated from the Wealden group, with which it was formerly confused, and it has been traced westward until it finally thins away, while at the same time the Wealden Shales, which form the uppermost subdivision of the Wealden group in the Isle of Wight, have been traced through the Isle of Purbeck as far westward as they extend.

During the mapping of the Lower Greensand some interesting evidence as to its relation with the overlying Gault came to light. This evidence tends to confirm the conclusions formed during the re-mapping of the Isle of Wight, for the break at the base of the Gault, which was there only suspected, becomes so much more pronounced westwards as to suggest that the base of the Cretaceous system might have been more suitably drawn at the bottom of the Gault than at the bottom of the Wealden group, which is inseparably connected with the Purbeck beds. Moreover, a conglomerate which forms the base of the Gault seems to correspond to the Carstone of the Isle of Wight, which has again been correlated with the Folkestone beds. The suggestion, therefore, made long ago, that a portion of the

Folkestone beds should be included in the Upper Cretaceous group receives support. In the Weymouth Peninsula the principal alterations relate to the mapping of the subdivisions of the Chalk as far westward as they are recognisable, and in the tracing of certain subdivisions of the Corallian rocks which are locally developed near Weymouth. The numerous faults of the area have also been followed, with a minuteness of detail which was impossible on the old one-inch map. An interesting result has been obtained from this work. The faults and foldings of the strata, though nearly all agreeing in direction, were found to have been formed at two different periods, the one set affecting the Oolitic rocks but passing under the Upper Cretaceous strata without disturbing them, the other breaking through both Oolitic and Cretaceous rocks alike. The older movements took place between the deposition of the Upper and Lower Cretaceous strata, while the later set were obviously contemporaneous with the Isle of Wight and Isle of Purbeck monoclines, which are believed to be of Miocene age. In more than one case, faults of the later age cross obliquely the older lines of fracture, producing a complication which could only be worked out on the large scale map. The break at the base of the Gault mentioned above seems to have been due to the faulting and upheaving of the rocks during the first of these periods of disturbance. It becomes here a most pronounced unconformability, and the Gault with a thin conglomerate at its base passes over the edges of the Wealden, Purbeck and Kimeridgian rocks in rapid succession.

*Triassic*.—Advantage has been taken of the prosecution of the Drift Survey across the salt districts of Cheshire and Staffordshire to obtain much additional information regarding the Triassic rocks, especially with reference to their industrial aspects. Mr. C. E. de Rance has collected 208 sections of the salt deposits at Northwich, Middlewich, Winsford and Lawton. He has likewise reduced some mining plans of salt-workings and placed their details on the six-inch maps, and has further collected tables of the levels of the brines at various periods, reducing these levels to Ordnance datum, and thus showing the height of the Upper and Lower rock-salt surfaces.

*Carboniferous*.—It is in the re-examination of the great coal-field of South Wales that the chief recent operations of the Survey in the Carboniferous system have lain. Sufficient progress has now been made to show of how much practical value a detailed survey of this coal-field will prove to be. Mr. Strahan, who has had charge of this work, soon ascertained that while the great thickness and uniformity of character of the widespread "Pennant Grit" makes it difficult to obtain indications of the geological structure over large tracts of ground, the position of a certain coal-seam known as the "Mynyddislyn Vein" affords an excellent horizon from which the lie of the other strata can be followed in great detail. He has accordingly devoted special attention to tracing the outcrop of this seam, and the trend of the numerous faults which have been met with in working it. He has had occasion to examine a large series of plans of old workings, and to reduce from these the necessary data upon the six-inch Ordnance maps. When these maps are completed, with all the available detailed information, they will probably afford a sufficient and accurate guide to the depth and dip of the various coal-seams over a large part of the area. The information thus worked out, combined with a precise geological mapping of the ground, will prevent the waste of large sums of money in seeking for coal, by showing exactly the limits within which the seams may be looked for, and the depths at which they may be expected.

*Devonian*.—Mr. Ussher, in the South of Devonshire, by a sedulous scrutiny of the ground, has been enabled to detect the presence of organic remains previously unnoticed, and by their aid to distinguish and trace the three great divisions of the Devonian system over the district between Newton Abbot and Plymouth. According to his observations, the following grouping may now be considered as established both by palæontological and stratigraphical evidence:—

1. *Upper Devonian*.—Slates, lying on Goniatic Limestone in the Limestone areas, and with local volcanic rocks.
2. *Middle Devonian*.—Slates, Limestones, and Volcanic rocks. The Limestones are developed in a local or sporadic manner, and in the intermediate districts they are replaced by volcanic rocks (the Ashprington Series), while their basement beds are represented by occasional calcareous bands and lentils in the slate bounding the volcanic series.
3. *Lower Devonian*.—Red and Grey Grits, Sandstones, and

Shales, apparently passing upward into the Middle Devonian Slates by the irregular intercalation of grits with slates.

During the progress of the field-work in South Devonshire a large series of specimens, sent up by Mr. Ussher, has been sliced and subjected to microscopic investigation by the petrographer to the Survey, Mr. J. J. H. Teall, F.R.S., who reports that the detailed examination of the rocks from the metamorphic area of South Devon has brought to light the fact that the previously published descriptions of the green varieties of rock were very imperfect. The specimens which have been least altered by surface-agencies consist essentially of hornblende, albite and epidote. In altered specimens hornblende is more or less replaced by chlorite; and when this is the case calcite is usually present. The hornblende is either uralitic or actinolitic in character, never compact. The feldspar is water-clear, and usually without any trace of cleavage or twinning. It has been definitely determined to be albite in one case, and from its uniform character in all the slides examined there can be no doubt that this is the dominant if not the only species present. The association of albite with hornblende, epidote, chlorite and calcite has been described by Lossen in his various papers relating to the modification of the diabases associated with Devonian rocks in the Hartz. Quartz, which had previously been supposed to form an important constituent of these rocks, appears to be comparatively scarce.

*Petrographical Department.*—The important assistance of the petrographical department has again during the past year been largely extended to the field officers, and has greatly aided their work. Mr. Teall, besides the microscopic and chemical work carried on by him in this office, and the determinations and reports made by him for the guidance of the officers in the field, has during the past year undertaken some field-work himself. As he is specially charged with the investigation of the petrography of the Lewisian gneiss—the most ancient rock in the British Isles—it was considered desirable that he should make himself practically familiar with the minutest details of the complex structure of this venerable formation, and for that end should himself map a portion of its area on the six-inch scale. The Island of Rona, lying between Skye and Ross-shire, was selected for him, and he spent nearly two months in mapping it.

With regard to the ordinary work of the department in the office and to the more important scientific results obtained by Mr. Teall during the last few years, he has at my request drawn up a memorandum, from which the following passages are taken:—The principal work of the petrographical department during the year has been the examination and description of specimens sent up by the officers in the field. Of these 492 have been prepared for microscopic examination and have been described in detail. The total number of Scottish rocks from which sections have been cut is now more than 5000. The system of cataloguing has been improved during the year. Each field officer now numbers his specimens consecutively. These specimens are entered in a book under the name of the officer who sends them up, and a record is kept of the destination of each. Those specimens of which sections are prepared are numbered consecutively in the order in which they are cut, and are entered in books kept for the purpose. When they have been described and named they are again entered in two distinct catalogues, one of which is arranged according to the sheets of the one-inch map, and the other according to petrographical types. It will thus be seen that every sliced specimen is entered four times, and that every specimen sent up for examination, whether sliced or not, can at once be found.

On the general question of metamorphism much important detail has been accumulated. The fact that the central and southern Highlands of Scotland are largely composed of highly crystalline rocks of sedimentary origin has long been known. Petrographical work has tended to render the correctness of this view more and more certain. Thus fine-grained quartzo-feldspathic rocks, which show no decided indications of clastic origin, have been found to be traversed by narrow dark bands in which minute crystals of zircon, rutile, and ilmenite abound. Similar bands occur in loose sandy deposits of much later geological age, so that the doubtful rock may be recognised as really a sandstone consolidated by the secondary enlargement of the quartz, and possibly also of the feldspar grains. The detailed microscopic work of the department has also thrown much light on the nature of the processes by which the present mineralogical and structural characters of the Highland rocks have been produced.

(To be continued.)

NO. 1273, VOL. 49]

### UNIVERSITY AND EDUCATIONAL INTELLIGENCE.

THE results of an inquiry into the position taken by Universities in different parts of the world as regards the admission of women, are given in the *Revue Scientifique*. It appears that the French Faculties opened their doors to women for the first time in 1863. None of the German Universities yet admit women either to lectures or examinations. There will be a difficulty, however, in resisting for long the force of opinion in favour of the admission of women to courses of study, and especially to medical classes. A petition for the removal of the present restrictions was presented to the Reichstag not long ago, containing more than 50,000 signatures of women. In Austria-Hungary and Spain the laws are against the access of women to higher education. Women possess a special school of medicine in Russia, in spite of their exclusion from the Universities. In Belgium, women are admitted to the courses in all the Faculties, and are eligible for all diplomas. They may also follow the medical profession, or become dispensing chemists. Holland has a large number of women students in its Universities, but Switzerland heads the list in this respect. During the summer semester of 1892, no less than 541 women students were studying in Swiss Universities. In Italy women are admitted to all the Faculties, and are at liberty to exercise all professions except the legal. Among the professors in Bologna University, a lady occupies the chair of histology in the Faculty of Medicine. The Universities of Jasi and Bucharest, in Roumania, are open to women, as are also those of Denmark, Sweden, Norway, and Iceland. Higher education is available for women in most parts of the United States. The result of this is that America has about 3500 women following various branches of the medical profession, 70 have been appointed physicians in hospitals, and nearly 100 are professors in schools of medicine.

THE Council of the Association of Technical Institutions have sent a letter to Mr. Gladstone with reference to the Royal Commission on Secondary Education, the appointment of which was recently announced. The signatories point out that, as the education given in the institutions represented by them is a necessary and important part of the general secondary education of the country, it is of great importance that the Royal Commission should be fully informed as to the nature of the work that is being done, as to the best means of improving and extending this work, and so enabling the institutions most efficiently to take their share in the work of national education. They therefore urge that the Royal Commission should be expressly empowered to deal with technical education, and in order that it might be able to do so effectually, that there should be among the Royal Commissioners an adequate number of gentlemen of experience as administrators and teachers of technical institutions.

THE Italian Government has decided to suppress six small universities—those of Messina, Catania, Modena, Parma, Sassari, and Siena—the academic population of which is from 100 to 400.

### SCIENTIFIC SERIALS.

*Bulletin of the New York Mathematical Society*, vol. iii. No. 5.—Prof. Klein's recent visit to Chicago was taken advantage of by American mathematicians. One of the most interesting results was the publication of twelve lectures on mathematics, with the title of "The Evanston Colloquium." An abstract of the contents of this work, by H. S. White, occupies pp. 119–122 of the present number. L. E. Dickson contributes a note on the number of inscribable regular polygons (pp. 123–125). E. M. Blake (pp. 125–127) writes upon the "Bibliography of Mathematical Dissertations." His remarks are based upon two recently issued works, viz. "Catalogues des Thèses de Sciences soutenues en France de 1810 à 1890 inclusivement, par A. Marie (1892)," and "Verzeichniss der Seit 1850 an den Deutschen Universitäten erschienenen Doctor-Dissertationen und Habilitationsschriften aus der reinen und Angewandten Mathematik" (München, 1892). The Paris dissertations are 701 in number, and the departments furnish 172 more. The German work gives references to 939 dissertations. Both books supply a want which has long been felt, for most of these dissertations appear unannounced at irregular intervals, and are with difficulty

run to earth. The remaining article is on the teaching of mathematics in the secondary schools (pp. 127-130), and consists of an extract from the report rendered to the National Educational Society, December 1893, by the Committee on Secondary School Studies.

*Meteorologische Zeitschrift*, February.—The results of the Swedish International Polar Expedition at Cape Thorsden, Spitzbergen, 1882-83, by Dr. J. Hann. The meteorological results, which have only recently been published, show that the winter temperature is relatively very mild compared with that observed at all the other Polar stations north of 70° N. latitude. In the year commencing September 1882, and ending August 1883, Cape Thorsden, latitude 78° 28', had the smallest extreme cold, with the exception of Jan Mayen, latitude 71°, while the summer was very cool. The lowest mean monthly temperature was -1°·3 in December, and the absolute minimum -31°·9 in January; the highest mean monthly temperature was 40°·3, and the absolute maximum 56°·5, both in August. The yearly rainfall (including snow), was 7·4 inches; no real hail fell during the year. The daily range of the barometer shows a double period, as in lower latitudes, but the maxima and minima occur at different hours; the day maximum occurs about 1h p.m., and the minimum about 6h. a.m., and there is a second maximum from 10h. p.m. to midnight, and a second minimum about 6h. p.m. In summer the amplitudes are much smaller than in winter; the day maximum then occurs from about noon to 1h. p.m., and the afternoon minimum about 6h. p.m. The prevalent wind directions are east and west; in summer the south-west wind is most frequent, and in winter north-west and east. The daily range of wind velocity is very marked in summer, the maximum occurring about 1h. p.m., and the minimum about 1h. a.m.; while the reverse obtains in winter, but with less regularity.

#### SOCIETIES AND ACADEMIES.

##### LONDON.

Royal Society, March 1.—“Terrestrial Refraction in the Western Himalayan Mountains.” By General J. T. Walker, C.B., F.R.S.

In the operations of the great Trigonometrical Survey of India it is customary to determine the coefficient of refraction by reciprocal vertical observations between contiguous stations on the sides of all the principal triangles, and also as many as possible of the secondary triangles.

The values of the coefficient thus obtained for the operations in the Western Himalayas—between the meridians of 73° and 80° east of Greenwich—have been grouped together for comparison in successive ranges of 2000 feet of altitude between the elevations of 5000 and 21,000 feet above the sea-level. The operations happen naturally to have been divided into two sections; for the regions lying between the great snowy ranges on the southern face of the Himalayas and the plains of India were first completed, and some time subsequently the still higher regions to the north, extending up to the Karakoram and Kuenlun Ranges, which look down on the plains of Turkestan. The first portion appertains to what is called the N.W. Himalyan Series, the second to what is called the Kashmir Triangulation. Thus the values of the coefficients of refraction were obtained separately for each section, and the results show that at each range of altitude the coefficient of refraction was greater in the Southern than in the Northern Section; also that from the height of 13,000 feet upwards the coefficient decreased in magnitude, as it theoretically should do, in the Northern Triangulation, but, on the other hand, in the Southern it increased until it became twice as great as in the Northern. These differences of behaviour in the two regions are very curious and difficult to account for. They point to some difference in the atmospheric conditions to the north and south of the outer Himalayan Range, and this may possibly arise from the circumstance that the atmosphere to the south is more heavily laden with moisture than the atmosphere to the north; for the great southern range is the first to receive the clouds which come up from the Indian Ocean, and which are the chief source of Himalayan moisture; these clouds are mostly condensed into rain on the southern face of the range, and thus only a comparatively small portion of their contents is carried on beyond into the more northerly regions. Whatever the cause, the fact is very remarkable that the coefficient of

refraction has a minimum value at an altitude of 20,000 feet on the north side of the Himalayan Ranges, and a maximum value at the same altitude on the south side.

“On a Spherical Vortex.” By Dr. J. M. Hill, Professor of Mathematics at University College, London.

The nature of the irrotational motion of an infinite mass of frictionless fluid, in which a solid sphere is moving, is well known. The object of this investigation is to show that continuous motion throughout space is possible if the solid sphere be replaced by a spherical mass of rotationally moving fluid. This spherical mass is the spherical vortex of the investigation. Its centre moves with uniform velocity along a straight line, which may be called the axis of the vortex. The surfaces inside the vortex which contain the same particles of fluid throughout the motion are ring-shaped surfaces of revolution about the axis, but are not anchor-rings. The molecular rotation at any point of the vortex is proportional to the distance of the point from the axis. The cyclic constant of the spherical vortex is equal to five times the product of the radius of the sphere and the uniform velocity with which the vortex moves along its axis.

Dr. E. L. Mellus made a preliminary report of the results of experimental investigation of the central nervous system of the monkey (*Macacus sinicus*) at the pathological laboratory of University College. Small portions of the cortex cerebri were removed from the left hemisphere, amounting in each case to about 16 sq. mm. At the end of three weeks the animals were killed, and the resulting degeneration traced by Marchi's method. Two foci of representation were selected for excision: the focus for the movements of the hallux, and the focus for the movements of the thumb. In the former, degeneration had taken place extensively throughout the pyramid of the left side down to the decussation in the cervical region, where the degenerated fibres were seen to divide, the greater portion, about two-thirds, crossing over to the opposite (right) lateral column, the remainder passing through the grey matter to the lateral column of the left side. This degeneration was maintained throughout the entire cord to the lower lumbar region. In the case of the removal of the thumb centre similar degeneration was observed, though the number of degenerate fibres was less than in the former. At the decussation the tract also divided, though the proportion of fibres going to the left lateral tract was much less than in the case of the hallux, and there was no degeneration of the cord below the level of the second dorsal nerve.

Mathematical Society, March 8.—Mr. A. B. Kempe, F.R.S., President, in the chair.—The following papers were read:—Groups of points on curves, by Mr. F. S. Macaulay. In the earlier part of the paper a proof is given that any  $n^{\text{ic}}$  through all the points of intersection of two given curves  $C_l, C_m$  of orders  $l$  and  $m$  is necessarily of the form

$$S_n \equiv C_l S_{n-l} + C_m S_{n-m} = 0$$

but the chief part of the paper is an investigation of the amount of independence of a group of points on a given curve which are residual to the partial intersection of the given curve by another curve of any order. The question may be expressed thus:—“If three curves  $C_l, C_m, C_n$  ( $l \neq m \neq n$ ) have  $N$  points common ( $N$  being not less than  $\frac{1}{2}(l+m+3)$ ), what is the amount of independence of the remaining points common to  $C_l, C_m$  (and those common to  $C_m, C_l$ ) for curves of any order passing through them, and what is the number of absolute relations that connect either of the above groups of points among themselves?” The method of investigation is geometrical, *i.e.* it does not depend on the solution of any equations or on the investigation of the properties of a curve from its equations.—On a simple contrivance for compounding elliptic motions, by Mr. G. H. Bryan. The author exhibited a number of “pendulum curves” drawn with a very simple arrangement based on the principle of a pendulum curve-tracer that he saw exhibited at the British Association meeting at Nottingham. The paper to be drawn on is placed on a heavily weighted board suspended from two points overhead by strings attached to its four corners in such a way that it can swing in any direction without twisting round. From the under-side of the board is suspended a weight, thus giving two periods of oscillation. The pen is attached to a triangular framework, hinged to fixed supports, and carefully counterpoised. The pen thus rests gently on the paper, which moves about underneath. The author uses a kind of “reservoir pen,”

formed by bending down the nib of an unfinished and unhardened barrel pen, so as to rest against the under-side of the nib of an ordinary fine grey steel pen, the space between the two nibs holding sufficient ink to draw the finest and most elaborate patterns without the ink running into blots. The most beautiful curves are those obtained by compounding two circular motions whose periods are nearly but not quite in the proportion of, say, two to one. To do this, however, a certain amount of skill is requisite in starting the machine.—On the buckling and wrinkling of plating supported on a framework under the influence of oblique stresses, by Mr. G. H. Bryan. The present investigation is chiefly interesting as forming an addition to the small class of soluble problems in which the question of stability arises in connection with the theory of elasticity. In a previous communication the author discussed the kind of buckling which arises when a rectangular plate has to support thrusts in its own plane, applied perpendicularly to its edges, and of sufficient magnitude to render the plane form unstable. The problem now considered is that of a sheet of plating of indefinite extent supported on equidistant parallel ribs, or on a rectangular framework formed by two such sets of ribs crossing each other, and which is compressed by thrusts applied in any direction not necessarily perpendicular or parallel to the ribs. Let the plating be supported on parallel ribs at distances  $b$  apart, and let it be compressed by a thrust  $P$  (per unit length measured in the plane of the plate) in a direction making an angle  $\alpha$  with the ribs. Then using  $C$  to denote the cylindrical rigidity of the surface, the conditions of instability may be summed up as follows:—

(1) If  $\alpha < 30^\circ$ , the plane form will become unstable when

$$P > \frac{4\pi^2 C}{b^2}$$

and wrinkles will then appear on the surface. These wrinkles will run in directions perpendicular to the direction of  $P$  (*i.e.* at an angle  $90^\circ + \alpha$  with the ribs, and will consist of alternate elevations and depressions, the lines separating which will be at distances  $b$  apart. In other words, the wrinkles with the ribs will divide the plate into rhombi, in which the displacements will be alternately to one side and to the other of the plane form.

(2) If  $\alpha < 30^\circ$ , the same form will become unstable if

$$P > \frac{\pi^2 C}{b^2 \sin^2 \alpha}$$

and the plating will then buckle into simple corrugations running parallel to the ribs, the displaced form of the plate being a cylindrical surface, of which the section perpendicular to the ribs is a curve of sines. The corresponding results are also worked out for a plate supported on a rectangular framework. A simple rough-and-ready illustration of these results is afforded when a sheet of paper is thrown into wrinkles.—On the motion of paired vortices with a common axis, by Mr. A. E. H. Love. One of the difficulties of the application of the vortex atom theory to problems of radiation lies in the great frequency of all the modes of oscillation of a single ring. The periods are all of the order of magnitude of the time taken by the ring to move over a distance equal to its diameter, and theories of radiation appear to require the existence of very much longer periods. It is not unlikely that such periods may depend on the relative motions of the constituents of a molecule or molecular group consisting of several ring atoms. The simplest case is that of two rings on the same axis passing through each other alternately. The period of this motion when the rings have very different diameters would be very difficult to determine, but it is probable that its order of magnitude can be obtained by considering the corresponding problem in two dimensions. A pair of cylindrical vortices of equal and opposite strengths moves perpendicularly to the plane joining the vortices, and thus behaves like a single ring. Two such pairs with their planes parallel can pass alternately through each other. The case considered is that in which all the vortices are of equal strength (disregarding sign). It is proved that the relative path is always such that, at some instant, the four vortices are in a straight line at right angles to the axis of symmetry, or one pair is passing through the other. It is proved that the relative motion is periodic provided the ratio of the breadth of the wider to that of the more contracted pair, at the instant when one is passing through the other, is less than  $3 + 2\sqrt{2}$ . The curves described by either vortex of one pair relative to the homologous

vortex of the other pair are found. These curves are very nearly ellipses, with their major axes parallel to the axis of symmetry, and they tend to become very elongated when the condition for the motion to be non-periodic is nearly fulfilled, but they are very nearly circular when the ratio of the breadths of the pairs at the instant when one is passing through the other is as great as 2. This result seems to have some bearing on the theoretical conditions of chemical combination. The length of the period is proved to be  $\frac{4\pi^2 c^2 (1 + \kappa')^2}{m \kappa' (1 - \kappa')} (E - K\kappa')$ , where  $m$

is the strength of one of the vortices,  $2c$  the mean breadth of the two pairs,  $E$  and  $K$  are complete elliptic integrals of the second and first kinds of a certain modulus  $\kappa$ , and  $\kappa'$  is the complementary modulus. The modulus  $\kappa'$  is  $(6Rr - R^2 - r^2)/(R + r)^2$ , where  $2R$  and  $2r$  are the breadths of the pairs at the instant when one is passing through the other. The expression for the period is discussed in particular cases, and it is shown that if the order of magnitude of the corresponding period for two vortex rings is the same as that for two vortex pairs, it is in fact long compared with any period of oscillation of a single ring.—On the existence of a root of a rational integral equation, by Prof. Elliott, F.R.S.

DUBLIN.

Royal Dublin Society, February 21.—Prof. Arthur A. Rambaut, Astronomer Royal for Ireland, in the chair.—Mr. W. E. Adeney read a paper on the reduction of manganese peroxide in sewage. The author stated that freshly precipitated peroxide of manganese, when mixed with sewage matters, and allowed to air-dry slowly, becomes gradually decomposed into manganous carbonate. He gave an analysis of some manganous carbonate, formed in this way, showing that the reduction of the peroxide is complete when it is exposed in small heaps to the air in the course of about three months.—A paper on eozoneal structure of the ejected blocks of Monte Somma, by Dr. J. W. Gregory and Prof. H. J. Johnston-Lavis, was communicated to the Society by Prof. G. A. J. Cole. The authors show that the limestone-blocks of Mesozoic age in Monte Somma have frequently become metamorphosed into crystalline masses consisting of alternating bands of calcite and various silicates. The authors regard the silica, magnesia, &c. as derived from the igneous rock by chemical interpenetration and interaction. Where the silicate, as often happens, is olivine (montecellite), or a pyroxene, a complete simulation of the structure of *Eozoon canadense* is produced. The layers of silicates occur parallel to the surfaces of any igneous vein that may have intruded into the limestone, and they become closer to one another in the areas farther removed from contact. The "proper wall," the "stolons," and in places the "canal system" of *eozoon* are recognisable under the microscope; and the authors adduce evidence to show that the typical eozoneal limestone of Canada may have arisen similarly as a product of contact metamorphism.—Prof. Cole then presented a paper upon derived crystals in basaltic andesite of Glasdrumman Port, co. Down. The author described a large composite dyke showing at this point a band of andesite on each side of it, from 4 to 17 feet wide, and a more recent dyke of eruite in the centre, 36 feet across. The eruite includes numerous blocks of andesite, and sends off veins into it; but the pyroxene and glass of the latter rock have become remelted at the contact, a delicate interpenetration of the two magmas has occurred, and the porphyritic crystals of quartz and pink felspar from the eruite are found completely surrounded by the dark andesite. Thus a pre-existing rock comes to include crystals derived from one that has subsequently invaded it, and hand specimens, apart from study in the field, would be of a most misleading character.—Sir Howard Grubb read a paper on a new form of equatorial mounting for monster reflecting telescopes, observing that as our neighbours in France intend constructing a 3-metre reflector for the Paris Exhibition of 1900, this may not be an inappropriate time to discuss the question of mounting reflecting telescopes of monster sizes, *i.e.* of 8 or 10 feet diameter. The problem to be solved is that of mounting, on an equatorial movement, a telescope of, say, 50 or 100 tons weight, so perfectly equiposed and relieved of friction that it can be conveniently manipulated and carried by clock-work, or some motive power, to follow a celestial object with such accuracy that it will not at any moment vary from its correct position by a quantity equal to the apparent motion of that object in a space of one-tenth or one-twentieth part of a second. To effect this the author proposes to develop further a

system already adopted by Dr. Common, viz. the flotation of the polar axis of the telescope. This is done by making a tube for the Newtonian reflecting telescope (which is necessarily closed at the lower end) of such a weight, and with its weight so distributed that it will not only float in water at a certain point (preferably near the upper end), but will be in a state of equilibrium when placed at any position down to a certain angle, say to within 20° of the horizon, the angle depending on the exact outside form of the tube. With a pair of trunnions attached at the water-line, an 80-ton telescope could be mounted and carried by an equatorial without throwing any weight whatever on that equatorial, the force necessary to drive the instrument being dependent only on the friction to be overcome in carrying the tube at an exceedingly slow rate through the water.

PARIS.

Academy of Sciences, March 12.—M. Lœwy in the chair.—Observations of the new planet BB (Charlois), made at the Paris Observatory, by MM. O. Callandreau and G. Bigourdan.—Preparation and properties of boron carbide, by M. Henri Moissan. Several methods are given for the preparation of this compound at the high temperatures of the electric arc. Clearly-defined crystals of CB<sub>6</sub> are obtained by heating the requisite quantities of carbon and boron with about twice their weight of copper in the electric furnace for six or seven minutes. After solution of the copper and extraction of a little graphite, the residue has a density of 2.51, and is hard enough to polish diamond. The properties of this compound are given at length.—On the reproductive organs of *Ancylus fluviatilis*, by M. de Lacaze-Duthiers.—On the internal pressure of fluids and the form of the function  $\phi(pv) = O$ , by M. E. H. Amagat. The author takes the general form  $(p + \pi)(v - a) = RT$ , hence develops the formula  $(p + T \frac{dp}{dt} - p)(v - a) = RT$ , in which  $\frac{dp}{dt}(v - a) = R$ , whence the values of  $a$  for a series of volumes are calculated. These values may be represented by the expression  $a_i = a + B(v - a)^n$  where  $B = 0.00077$ ,  $n = \frac{1}{2}$ , and  $a = 0.0004$ . But, from the variation of  $\pi$  (the internal pressure) with the volume, we have  $\pi = A \frac{v - \epsilon}{v^m}$ ; for hydrogen  $A = 0.000506$ ,  $m = 3$ , and  $\epsilon = 0.002111$ . With these values of the arbitrary constants the formula

$$\left( p + A \frac{v - \epsilon}{v^m} \right) (v - [a + B(v - a)^n]) = RT$$

gives for hydrogen values for the pressure calculated from the volume agreeing well with the actual pressures from 100 to 2800 atmospheres. The calculated interior pressure for unit volume at zero temperature and normal pressure is 0.000875 atmos. Kelvin and Joule's experiments make the value 0.0008 atmos.—Magnetic observations in Madagascar in 1892, by P. E. Colin.—On the presence of a polymorphous microbe in syphilis, by Dr. Golasz. The author gives evidence of the existence in the blood of syphilitic patients of a polymorphous bacillus belonging to a species nearly related to *Leptothrix* and *Cladothrix*, and hence similar to the species found in cases of tuberculosis, leprosy, and glanders.—On the triangle of sequences. An abstract of a memoir by M. Désiré André.—Observations of the new planets AX (Wolf, March 1) and AZ (Court, March 5) made at Lyons Observatory, by M. G. Le Cadet.—Observation of the planet 1894 AZ, made with the great equatorial of the Bordeaux Observatory, by M. L. Picart.—Observations of planets, made at the Toulouse Observatory (Brunner equatorial), by M. F. Ro-sard.—Solar phenomena observed during the third and fourth quarters of 1893, at the observatory of the Roman College. A letter from M. P. Tacchini.—On the capillary depression of the barometer, by M. C. Maltézos. A mathematical investigation resulting in the expression of the opinion that the practical comparison method must still be relied on for correcting barometric heights for capillarity.—Achromatism and chromatism of interference fringes, by M. J. Macé de Lépinay.—Use of electricity for following the phases of certain chemical reactions, by M. Jules Garnier.—A contribution to the study of ferments, by MM. P. Hautefeuille and A. Perrey.—On the spark spectra of some minerals, by M. A. de Gramont. The mineral sulphides, selenides, and tellurides, and native gold, silver, copper, bismuth, arsenic, and antimony have been studied.—Influence of time on the absorption of carbon

monoxide by the blood, by M. N. Gréhan.—On the prostatic utriculus and the vasa deferentia in the cetacæ, by MM. H. Beauregard and R. Boulart.—On composite ascidians of the genus *Distaplia*, by M. Caullery.—On ears of maize attacked by *Aluicite des cereales* in Central France, by M. A. Laboulbène.—Influence of potassium salts on nitrification, by MM. J. Dumont and J. Crochetelle.—On the fertility of the giant *Persicairre* (*Polygonum sachalinense*), by M. Ch. Baltet.—Physiological researches on fungi, by M. Pierre Lesage.—On the fossil *Cedroxylon varolense*. A note by MM. B. Renault and A. Roche.—On the variation of the composition of the water of lakes with the depth and according to the seasons, by M. A. Delebecque.—On the temperature of caverns, by M. E. A. Martel.

BOOKS, PAMPHLETS, and SERIALS RECEIVED.

Books.—Statesman's Year-Book, 1894 (Macmillan).—A Handbook of Gold-Mining: H. Louis (Macmillan).—The Handbook of Jamaica for 1894 (Stanford).—Ueber die Spectren der Elemente: H. Kayser and C. Runge (Berlin, Reimer).—Deutsche Uebersetische Meteorologische Beobachtungen, Heft vi. (Berlin).—Construction et Resistance des Machines a Vapeur: Alheilig (Paris, Gauthier-Villars).—Machines Frigorifiques a Air: R. E. de Marchena (Paris, Gauthier-Villars).—Popular Lectures and Addresses: Lord Kelvin, Vol. 2, Geology and General Physics (Macmillan).—A Treatise on Hydrostatics: Prof. A. G. Greenhill (Macmillan).—Methods of Pathological Histology: Prof. C. von Kahliden, translated and edited by Dr. H. M. Fletcher (Macmillan).  
PAMPHLETS.—Return of Mineral Production in India for 1892 (Simla).—River Temperature, Part 1: H. B. Guppy.—The Aerial Oxidation of Terpenes and Essential Oils: C. T. Kingzett.—Quelques Conclusions et Applications de l'Anthropologie (Paris, Masson).  
SERIALS.—Bulletin of the Natural History Society of New Brunswick, No. 11 (St. John, N.B.).—Journal of the Chemical Society, March (Gurney and Jackson). Insect Life, Vol. 6, No. 3 (Washington).—Rendiconto dell' Accademia delle Scienze Fisiche e Matematiche, serie 2<sup>a</sup>, Vol. 8, fasc. 1<sup>o</sup>, e 2<sup>o</sup> (Napoli).—Economic Journal, March (Macmillan).—Journal of the Institution of Electrical Engineers, No. 109, Vol. xxiii. (Spon).—American Naturalist, March (Philadelphia).—Royal Natural History, Vol. 1, Part 5 (Warne).—Proceedings of the Indiana Academy of Sciences, 1892 (Brookville, Ind.).

CONTENTS.

|                                                                                                                                                                        | PAGE |
|------------------------------------------------------------------------------------------------------------------------------------------------------------------------|------|
| Theory of Functions. By G. Ch. . . . .                                                                                                                                 | 477  |
| The Construction of Drum Armatures and Commutators. By E. Wilson . . . . .                                                                                             | 478  |
| British Mosses. By E. F. . . . .                                                                                                                                       | 479  |
| Our Book Shelf:—                                                                                                                                                       |      |
| Eleanor A. Ormerod: "Report of Observations of Injurious Insects and Common Farm Pests, during the Year 1893, with Methods of Prevention and Remedy."—W. F. K. . . . . | 480  |
| Macfarlane: "On the Definitions of the Trigonometric Functions" . . . . .                                                                                              | 480  |
| Carr: "Key to Mr. J. B. Lock's Shilling Arithmetic" . . . . .                                                                                                          | 480  |
| Letters to the Editor:—                                                                                                                                                |      |
| The Thermal Expansion of Diamond. ( <i>With Diagram.</i> )—Dr. J. Joly, F.R.S. . . . .                                                                                 | 480  |
| The North-East Wind.—S. H. Burbury, F.R.S. . . . .                                                                                                                     | 481  |
| The Suspension of Foreign Bolies from Spiders' Webs.—R. Philipp . . . . .                                                                                              | 481  |
| The Falls of Niagara and its Water-Power. ( <i>Illustrated.</i> ) . . . . .                                                                                            | 482  |
| Notes . . . . .                                                                                                                                                        | 486  |
| Our Astronomical Column:—                                                                                                                                              |      |
| Comet Spectra as affected by Width of Slit . . . . .                                                                                                                   | 489  |
| The Astigmatism of Rowland's Concave Gratings . . . . .                                                                                                                | 489  |
| The Institution of Naval Architects . . . . .                                                                                                                          | 490  |
| Cholera. By Dr. E. Klein, F.R.S. . . . .                                                                                                                               | 492  |
| Geological Survey of the United Kingdom. I. By Sir Archibald Geikie, F.R.S. . . . .                                                                                    | 495  |
| University and Educational Intelligence . . . . .                                                                                                                      | 497  |
| Scientific Serials . . . . .                                                                                                                                           | 497  |
| Societies and Academies . . . . .                                                                                                                                      | 498  |
| Books, Pamphlets, and Serials Received . . . . .                                                                                                                       | 500  |



THURSDAY, MARCH 29, 1894.

## THE FLOWERING PLANTS OF WESTERN INDIA.

*The Flowering Plants of Western India.* By Rev. A. K. Nairne. 8vo. pp. 401. (London: W. H. Allen and Co. Bombay: The Education Society's Press, Byculla.)

NOW that the "Flora of British India," by Sir Joseph Hooker and his helpers, is nearing completion, we are sure to get works more or less founded upon it, dealing with smaller areas which it includes. The first portion of Trimen's "Flora of Ceylon" has already appeared. This is a strictly scientific work, and a thoroughly complete enumeration of the plants of the island; and now we have the present volume, which is merely a popular account of the principal plants occurring within the Presidency of Bombay, excluding Sindh. The author, the Rev. Alexander Nairne, belonged to the Bombay Civil Service, and made, whilst resident in India, notes on the habit and character of the more striking plants, which he saw, together with their native names and uses. Previously to the present work the only special books on the same district were the "Bombay Flora," published in 1861 by Dalzell and Gibson (the latter the energetic Conservator of Bombay Forests), and the "Catalogue of Plants growing in Bombay and its vicinity," which was published by Mr. Graham in 1839. But one cannot omit reference to the names of Mr. Law and Dr. Stocks. Mr. Law and Mr. Dalzell worked the Concan Flora most ably and energetically. Mr. Law resided for many years at Tannah, near Bombay, and explored the Northern Concan; while Mr. Dalzell chiefly employed himself in the Southern Concan and adjacent province of Canara. Dr. Stocks officiated for Dr. Gibson during that gentleman's visit to Europe. He collected in Sindh, and, amongst other plants, gathered the curious *Gossypium*, which bears his name, the probable parent of all the forms of Indian cotton, and also in the mountains of the Concan, the small *Impatiens Stocksii*. Besides the books mentioned, many Bombay plants are described in Roxburgh's "Flora," and in Wight and Arnott's "Prodromus," and many are figured in Wight's "Icones." Mr. Nairne states that he knows the Concan fairly well, which, with the ghauts which bound it on the east, are botanically the richest part of the Presidency. He also claims a fair acquaintance with the Deccan, but he has never been in the Southern Maratta country at all, and his acquaintance with Guzerat is decidedly limited. The mode in which the scientific part of this book is made up is as follows: "The nomenclature and classification are entirely those of Hooker's 'Indian Flora'; the descriptions of orders are mainly Hooker's, but with details from other writers. The descriptions of genera are Hooker's, very much compressed"; so much compressed, we are afraid, as to be in some cases quite unintelligible. As has before been mentioned, the descriptions of species are from the author's own notes, compared with those of other writers, chiefly Hooker's and Dalzell's. The title appears to us decidedly misleading ("The Flowering Plants of

Western India"), as one might naturally expect at least an enumeration of all the Phanerogamous plants growing within the Presidency, and this is far from being the case. What will Mr. C. B. Clarke, the talented monographer of the natural order *Cyperaceæ*, say when he sees that his especial *protégés* find no place in the Flora? *Gramineæ* are also omitted. Mr. Nairne states that their flowers "consist only of bracts or scales," and does not evidently consider these two orders sufficiently merit the rank of flowering plants. The book, we are told, is intended for two classes—"Firstly, the Englishmen and Englishwomen whose duty calls them to Western India, and who wish to know something about the trees and flowers which surround them; and secondly, the educated natives of the country." It is a small octavo, and can be easily carried for field work. The contents consist of a prelude of several pages of quotations, introduction, definition of terms used in the work, several pages to explain the system of classification employed, then the body of the work, and it concludes with a couple of indices—one for Latin and English names, and one for the native names. In the body of the work you first get a conspectus of the orders, then under each order you get a more amplified description, a short key to the genera, and then the species, for which no authorities are given, are described briefly in English. The less important species are described in smaller type, and a quotation is generally added from a well-known writer.

We are afraid much might be said in criticism of the work. Taking *Malvaceæ*, for instance, on page 27, we hardly think the generic characters are correct or sufficient. The diagnostic character applied to *Malva* is "Downy herbs, involucre of three distinct bracts," and the author evidently has not grasped the fact that the chief distinction between *Sida* and *Abutilon* is that in the one the carpels are uniovulate, while in the other they are multiovulate. We should also like to know why *Sida mysorensis* and *Sida cuneifolia* (*S. Schimperiana*) are omitted? A quotation from Le Maout is inserted, saying, "The plants of the order are all wholesome." We think the conspectus of the orders ought to be entirely revised, or almost rewritten. On page 138 we find a key to the orders of monopetalous Exogens. No primary division is based on the position of the ovary. Division (*a*), including *Plumbaginaceæ*, *Primulaceæ*, *Myrsineæ*, &c., is characterised by having "stamens 5, corolla regular," while division (*a'*), including *Rubiaceæ* (except *Randia* and *Gardenia*), *Loganiaceæ*, *Boraginaceæ*, *Campanulaceæ*, &c. has "stamens 4 or 5, flowers regular." This is a distinction without a difference. *Compositæ* is not included in the conspectus, because "it is an order quite by itself with flowers composed of many distinct *perfect* florets." *Sapotaceæ*, *Ebenaceæ*, and *Styraceæ* are classed together as "trees, almost all with many stamens." We are left in doubt as to how we are to distinguish the one from the other; and here, as in several other cases, Mr. Nairne has shirked his responsibilities.

The Flora of the Bombay Presidency, as compared with that of the Nilghiris, is poor in forest types. The whole Concan is much more open than Malabar, and heavy forests are rarer, and many tropical Malayan forms disappear and are replaced by such plants as grow

on the east side of tropical Africa. It is said that in the northern province of Sindh, whose vegetation was first made known to science by Griffith, more than nine-tenths of the plants, on a rough estimate, are indigenous in Africa. At least one-half of these are common in Nubia or Egypt.

It is interesting to take for example the genus *Psychotria*, possibly the most difficult genus of the very large and difficult natural order to which it belongs. In Hooker's "Flora" there are 52 species, of which only 4 (Mr. Nairne has only 2) are found within the Bombay Presidency.

In conclusion, we may say that it is evident that the author has taken a good deal of pains over the book, but from a scientific point of view it is painfully incomplete as a conspectus of the plants of the district to which it relates.

#### THE PARASITIC THEORY OF THE CAUSATION OF MALIGNANT TUMOURS.

*Cancer, Sarcoma, and other Morbid Growths considered in Relation to the Sporozoa.* By J. Jackson Clarke, M.B.Lond., F.R.C.S. (London: Baillière, Tindall, and Cox, 1893.)

IT is perhaps not to be expected that in the present state of our knowledge of the relation of lower animal parasites to morbid growths any very definite opinion can be given on certain of the points raised in the small monograph now under review, and, especially, as to the accuracy of the opinions put forward. Indeed we imagine that many readers, after surveying with interest the arrangement and character of the work, will come to the conclusion that whether the theories advanced by the author are ultimately accepted or not, he has certainly not brought forward sufficient evidence in support of his thesis, and that had the energy and skill expended in polemical discussion and theoretical statement been brought to bear in carrying out more extended observations and the accumulation of facts, a very large amount of definite information might have been contributed to this very interesting subject. The interpretation put on the observations of others, and didactic assertion, can never be accepted in lieu of accurate observations, and a mere statement as to the inaccuracy of the work of the older observers, unless it is backed by prolonged investigation and accurate description, can never take the place of such older work.

After a careful perusal of the book now before us, and with the above reservations, we feel justified in stating that for those who wish to obtain a general outline of the subject treated, the abstracts and references given by the author will render this a comparatively easy task. As regards the original portion of the work, one cannot but feel that the author goes considerably beyond his proof in assuming that pathologists cannot obtain results similar to his—first of all, because they have not familiarised themselves with the newer methods of research, and secondly, because they have not "realised the protean characters of the sporozoa"; for, as the author himself points out, a large number of workers, some of them skilled histologists and trained biologists and pathologists, have been laboriously engaged in trying

to set at rest some of the questions of which he so light-heartedly disposes, but with which no evidence of his own capacity to deal is offered in this original part of the work. In some cases the drawings certainly do not bear out the descriptions given in the text, whilst in others few observers will be able to accept the somewhat diagrammatic representations made to do duty as illustrations, as being anything more than familiar degenerative appearances seen through the eye of a somewhat partial observer. It appears to us to be a mistake for any one to try to make facts fit into theories; a far more profitable occupation is to make theories accord with facts. Again, some of the author's observations may be accepted as accurate in themselves, but it is difficult to see what bearing they have on the existence of a causal relationship between the lower animal parasites and malignant tumours. That some such relationship does exist is daily becoming more probable, but the evidence accumulated up to the present, in spite of the great amount of work that has recently been done, is still but scanty, and it remains for workers to follow out carefully and accurately the various "parasitic" forms that have been described, and to learn something more of their mode of origin, life-history, and ultimate destiny, before they can begin to build up elaborate theories on the relation of these organisms to morbid growths with any well-grounded hope that such theories will have anything more than an ephemeral existence.

#### OUR BOOK SHELF.

*The Fauna of the Deep Sea.* By Sydney J. Hickson, M.A., D.Sc. (London: Kegan Paul, Trench, Trübner, and Co., Limited, 1894.)

THIS little volume forms one of the "Modern Science" series edited by the Right Hon. Sir J. Lubbock, Bart. It treats of a very interesting subject, which for the last twenty-five years has attracted the attention and engaged the service of many biologists. Great though the contributions of our American and French *compères* have been towards its elucidation, yet the long series of splendid volumes of our own *Challenger* reports will stand as a proof of what this country has done in this direction; nor in writing this do we forget for a moment the fact that many of the *Challenger* reports were written by the sons of other nations besides our own. With these reports and those by Agassiz on the "Voyages of the *Blake*," our author certainly had abundance of material for his sketch of the subject, for he pretends to nothing more. He gives us a short history of the deep-sea investigations, going back some fifty years ago, to the time of Goodsir's haul in Davis Straits, to Dr. Wallich's bringing up star-fish from some 1260 fathoms of depth, and so till he tells of the as yet unfinished researches off the eastern slopes of the Pacific Ocean by the *Albatross*, and those in the Indian ocean by H.M. *Investigator*.

No doubt it was a difficult task to crowd into sixteen pages even a *précis* of such a mass of facts, and yet we think it might have been improved had the author looked into a volume, from which as far as we can judge he does not quote, by Wyville Thomson, on "The Depths of the Sea." The second chapter, on the physical conditions of the Abyss, is well written. Might not the pelagic algae, which are sometimes to be found covering the surface for miles, play a more important part than is seemingly

ascribed to them as food for the deep-sea forms; though not weighted, like the radiolarians, diatoms, &c., with siliceous shells, still they might in time fall from the table of the upper waters on, or rather down, to that of the hungry deep-dwelling forms. In the chapter on the relations of the Abyssal zone and the origin of its fauna, the author introduces the new classification of the ocean fauna, "Plankton," "Nekton," and "Benthos," and he is good enough to write that though "it will not be necessary to use these terms very frequently in this little book, it may be advisable for the reader to bear in mind that in any exhaustive treatise on the marine fauna such terms would be used and employed." We, however, only find in the index one reference to them, and that the one we have just quoted; nor in the following chapter, treating of the characters of the deep sea fauna, does the author employ them, though here their use might have assisted the meaning. Perhaps this Greek armour was found too cumbersome.

The last paragraph of this chapter we would have preferred omitted. We cannot see the relevancy of Moseley in comparing the deep sea fauna, even "as a whole," as in any way similar to the flora of the high mountains. If some of the deep-sea forms are dwarfed, this is surely the exception, and giants of almost all the groups are to be found among them; whereas what gigantic representatives of any group are to be found on the mountain tops?

The remaining four chapters treat of the Protozoa, Coelentera, Echinoderma, Vermes, Mollusca, Arthropoda, and Fish of the deep sea. They open with a regret that "although thousands of species of animals have been described in the volumes that have been devoted to deep-sea work, yet the number of the sub-kingdoms and classes remains the same," and conclude with a hope, in which we join, "that in the future there may be a new stimulus given to deep-sea research, and that the many unsolved problems may be again seriously studied and eventually solved."

*A Treatise on Elementary Hydrostatics.* By John Greaves, M.A. (Cambridge University Press, 1894.)

A BRIEF examination of this treatise is sufficient to allow us to form a favourable opinion of its contents. Nearly every proposition or description shows that the author is a thorough master of his subject, and, what is also of equal importance, can impart his knowledge to his readers in language both concise and fresh. The treatise is intended for those preparing for the first part of the Mathematical Tripos, and is different from other elementary works on the same subject in the following manner: In this Tripos examination one is now allowed to use the notation of the calculus, which for some students is a great boon, in that problems can be more easily solved, and in less time. We are thus presented in the text of this treatise not only with the usual proofs; but with alternative proofs when the use of the calculus is a distinct advantage. This alteration will be found an improvement. The definition of a fluid, from which are deduced the principles of the subject, is given as "a substance which will yield to any continued shearing stress, however small, or," in other words, "when a fluid is in equilibrium, the stress across any plane in it is entirely normal to that plane."

Among other useful additions to the subject may be mentioned propositions relating to a heterogeneous fluid in equilibrium under any system of forces, and some cases of simple motion, the latter of which may be left for a second reading. In chapter ix. the author deduces several well-known capillary phenomena from the experimental result that the energy of a material system depends to a great extent on the surfaces separating the different substances.

As the book is printed in clear type and contains neat diagrams, it will be sure to find favour with students.

## LETTERS TO THE EDITOR.

*The Editor does not hold himself responsible for opinions expressed by his correspondents. Neither can he undertake to return, or to correspond with the writers of, rejected manuscripts intended for this or any other part of NATURE. No notice is taken of anonymous communications.]*

## Sun-spots and Magnetic Disturbances.

The note in NATURE for February 22, 1894 (p. 397) concerning "Sun-spots and Magnetic Disturbances" illustrates most clearly the necessity for the adoption of a proper method in order to arrive at any conclusion respecting the relation between these phenomena. I must continue to insist, as I have done heretofore in the columns of NATURE and elsewhere, that the study of the periodicity of magnetic storms and auroras at intervals of about twenty-seven and one quarter days must precede that of the attendant solar conditions, otherwise no results will be obtained. For example, during the month of August 1893, to which the note above mentioned refers, sun-spots were so numerous that it would be utterly impossible to determine which group, if any, were in a location upon the sun capable of originating terrestrial magnetic effects. The proper way is to begin by disregarding solar conditions entirely, and arrange the magnetic storms or auroras of the period that it is desired to study, in series as they actually occurred at the twenty-seven and one quarter day interval. This being done, it is possible at a glance to determine what particular solar conditions reappear invariably when magnetic perturbations are recorded. In this way, and in this way alone, it becomes evident that whenever these magnetic effects appear, there is always a disturbed portion of the sun at the eastern limb and near the plane of the earth's orbit in that location. If the series of recurrences is sufficiently persistent to last through many solar rotations, it will be found that the disturbed area continues to have its effect in spite of considerable variations in the size of the spots, and that at times these effects may continue even when nothing but groups of faculae remain, these being however, unusually bright and extensive in such a case. By following the history of such recurrences into the portion of the year in which any given disturbed portion of the sun is at a distance from the plane of the earth's orbit, when at the eastern limb, it is found that outbreaks of violent thunderstorms, which do not produce any disturbance of the magnetic needle, take the place of magnetic storms and auroras in the regular order of recurrence. There have been some phenomenal illustrations of this the past winter. Usually in this part of the United States a thunderstorm in winter is very rare, and, if it occurs, stands forth as a prominent event. Thus the thunderstorms of Christmas-day and night, in which buildings were struck by lightning in this State, were most exceptional, and, falling as they did upon the proper date to form the continuation of the strongest and most persistent series of thunderstorms and auroras that has been current the past year, were most striking. The above method of attacking the question is that which the writer has gradually developed for the purpose of systematic study. The relation having once been established by tracing the history faithfully and in detail, in the manner described, it is no longer absolutely essential to enter into the question of periodicity in order to secure evidence bearing upon the question. As soon as it is known what has to be looked for, it will only be necessary, when any very large increase of thunderstorms occurs, or any notable magnetic perturbations, as the case may be, to look at the proper part of the sun, and see whether it is the seat of disturbance. In this way it will be found that it is not the size of solar disturbances, but their activity at the critical date when they are in the proper location, that determines the terrestrial effects to which reference has been made. Thus it is a question throughout of the adoption of a proper method of investigation. M. A. VEEDER.

Lyons, N.Y., March 12.

## Dredging Expedition at Port Erin.

THE Liverpool Marine Biology Committee organised a dredging expedition from the Port Erin Biological Station at Easter. The party of a dozen naturalists included several members of the committee, Mr. I. C. Thompson, Mr. A. Leicester and Prof. Herdman, Prof. Weiss, Dr. Hurst, Mr

Gamble, and Mr. Hick from Owens College, Mr. W. I. Beaumont, and Mr. E. T. Browne. The steam trawler *Lady Loch* was chartered for two days, and the weather was perfect for work at sea. On the first day, the sea-bottom to the north of Port Erin, from Fleshwick to Contrary Head at Peel, was explored at twelve stations ranging from quarter of a mile to four miles from the coast, and from depths of ten to twenty fathoms. On the second day the steamer coasted along the west side of Calf Island and about four miles further to the west, dredging at nine stations from one to four miles from land, and at depths of nineteen to twenty-five fathoms. Two series of samples of the bottom deposits brought up in the dredge were preserved, the one set for more detailed examination in the laboratory, the other for transmission to the Jermyn Street Museum, where the Director-General of the Survey is forming a series illustrating the submarine deposits of our coasts. Besides the more ordinary gravels, sands, and muds, several peculiar deposits occurred, one of which was almost entirely composed of the shells of *Pectunculus glycimeris*, while another, which looked like a coarse sand, was seen to be formed of the broken spines of *Spatangus* and other Echinoderms. In some places the bottom for considerable distances is covered with *Melobesia* and *Lithothamnium*.

The greater part of the material obtained has still to be examined in detail, and will be treated of in future reports of the Liverpool Marine Biological Committee. Among the more noticeable forms obtained were:—The massive state of *Cliona celata*, *Sarcodictyon catenata*, the Echinoderms *Antedon rosaceus*, *Palmipes membranaceus*, *Luidia savignyi*, *Stichaster roseus*, *Echinocardium flavescens*, *Cucumaria hynchmani*, *Thyone fusus*, and *T. raphanus*, *Cellaria fistulosa*, *Scalpellum*, *Tellina crassa*, and the Ascidians *Polycarpa comata*, *Engyra glutinans*, *Ascidia plebeia*, *Cynthia morus*, and a *Microcosmus* which seems an unknown form. Mr. Thompson and Mr. Frowne worked townets both on the surface and also at the bottom attached to the dredge. Most of the crabs and other higher Crustacea were found to be spawning, and some of the Nudibranchs are spawning in the tanks at the Biological Station. A common anemone a few weeks ago produced about fifty young, which have now from twelve to sixteen tentacles.

Several of the dredging party are staying on to work at the Biological Station during a part or the whole of April, and another dredging expedition will be arranged by the committee at Whitsuntide.

W. A. HERDMAN.

University College, Liverpool, March 26.

#### THE SCOPE OF PSYCHO-PHYSIOLOGY.

UNDER the title of psycho-physiology may be comprised those investigations in psychology which have explicit or tacit reference to the concomitant physiological processes, and which are characterised by the application of the experimental method. The boundaries of the subject are somewhat ill-defined, since it shades off into physiology on the one hand, and into introspective psychology on the other. I shall endeavour in this article to indicate the scope of such experimental investigations.

A chick, not many hours old, will peck with fair but not complete accuracy at any small object which catches its eye. Here we have a reflex and responsive action. A stimulus is received in a sense-organ; an impulse is carried centripetally along ingoing or afferent nerve-fibres; certain nerve-centres are thrown into activity; and an outgoing impulse is carried by efferent nerve-fibres to muscles which are thus thrown into co-ordinated activity. It is probable that, on the first occurrence of such an action, it is purely automatic and is performed in virtue of the possession, by the chick, of an inherited organic mechanism. It is accompanied by, but not guided by, consciousness. Such guidance, however, soon becomes evident. Throw to a chick two or three days old half a dozen caterpillars, some of them common "loopers," others yellow and black "cinnabars." In the absence of previous experience they will be equally seized. But the loopers will be swallowed, while the cinnabars will be dropped. Repeat the experiment

next day. The loopers will be gobbled up at once. The cinnabars will remain almost, if not quite, untouched. An association has been formed between the sight and taste in the two cases. Consciousness is no longer merely an accompaniment of the action. It controls; enforcing the action in one case, inhibiting or restraining it in the other. It is probable that in the higher parts of the brain there are special centres, the physiological functioning of which is associated with this conscious control. Such activities of the chick, first those which are merely responsive and automatic, secondly those which are under conscious control, exemplify a wide range of activities both in animals and man.

Let us note the scope of the experimental work that they suggest. First, there is the nature and range of stimulation of the nerve-endings in the sense-organ. Secondly, there is the nature and rate of transmission of the impulses along the nerve-fibres afferent and efferent. Thirdly, there are the nature and localisation of the activities of the automatic centres, and the time occupied by their peculiar functioning. Fourthly, there is the physiological and psychological investigation of the nature and mode of origin of the consciousness which accompanies the movements of parts of the body during response. Fifthly, there are the conditions, psychological and physiological, of association. And sixthly, there is the mode of application of the control, and the localisation of specialised control centres, together with the estimation of the time-element in control.

All of these have been made the subject of careful and systematic inquiry by the method of experiment. In all cases such experimental investigation has led, if not to brilliant positive results, at all events to salutary acknowledgment of ignorance. Difficulties of interpretation abound. Nowhere are these difficulties greater than in the investigation of the physiology and psychology of colour-vision. Take a dozen individuals, and get them successively to indicate by means of the cross-fibres of the spectroscope how far they can see along the spectrum, first in the direction of the extreme red, then in the direction of the extreme violet. You will find marked differences. Perhaps one will show a quite unusual amount of variation, and you will probably find by other tests that he is colour-blind. Is this variation in the retina or in the visual centre of the brain? It is well known that the psycho-physiology of vision is still a matter under discussion. One of the difficulties seems to arise from the fact that what is physiologically complex is psychologically simple. Purple gives a simple psychological sensation; but it is due to a combination of physiological impulses, the coalescence or synthesis of which is, so to speak, below the threshold of consciousness. One cannot, or I cannot, psychologically analyse purple into its constituents, as one can analyse a musical chord. There is still a wide field for research in the psycho-physiology of sensation.

An important line of investigation, which has now been followed up for many years, deals, not with differences of kind or of quality in sensation, but with variations in intensity. Given a stimulus which excites sensation; now diminish it, on the one hand, until it ceases to excite sensation, and increase it, on the other hand, until it reaches a maximum of sensation. Then formulate the law which shall express the relation which increase of stimulation bears to the increase of sensation. The results of Weber's researches went to show that we must look not to the absolute, but to the relative increments of stimulus; and Fechner, extending and generalising Weber's results, formulated the law of the relations thus:—When the stimuli increase in geometrical progression, the sensations increase in arithmetical progression, or the sensation is proportional to the logarithm of its stimulus. Concerning this law, the exactitude and range of its applicability, and its philosophical *raison*

*d'être*, there has been much animated discussion, into which I do not propose here to enter. Suffice it to say that if we represent by a curve the rise of sensation from the threshold where it first dawns, to its maximum, the law seems to hold good only for the mid-region. Various methods of experimentation are employed. Weber and Fechner employed chiefly the method of tabulating the just discernible differences in sensation, of increasing, that is to say, the intensity of the stimulus, and noting when this increment is just perceptible. Others, using larger intervals, have employed the method of estimating equal increments. Others, again, have constantly doubled the stimulus and noted the change in sensation. In all cases it must be remembered that what we are really dealing with is the perception of the relations between certain given sensations. This is a fact too often lost sight of. We have to infer from these relations the intensity-curve in sensation.

In addition to experimental investigations concerning the qualities and intensities of sensory elements in consciousness, there are others which deal with the feeling-tone, that is, the pleasurable or painfulness of the sensation. Here with increase in the stimulus there is a rapid culmination of tone to the pleasurable maximum, after which it falls off pretty rapidly, and further increase gives rise not to pleasure, but to pain.

Researches on the rate of transmission of impulses along the afferent and efferent nerves may be regarded as mainly physiological. Suffice it to say that the rate is about 120 feet per second for ingoing impulses, and about 110 feet per second for outgoing impulses. Transmission in the spinal cord appears to be less rapid.

The results of experimental investigations on the localisation of function in the brain appear to justify the hypothesis that the automatic centres—or the centres concerned in merely organic response—are quite distinct from the control-centres, which are probably restricted to the cerebral cortex. It is a good working hypothesis that the centres which minister to control are the seat of those molecular disturbances which are concomitant with consciousness. Consciousness apart from control would be a mere epi-phenomenon of no practical use to the organism. It is scarcely necessary for me to do more than remind the reader of the conspicuous success which has crowned the efforts of those who have patiently and systematically applied the experimental method to the localisation of the centres of motor control. The motor regions of the hemispheres have now been mapped out with considerable exactitude. The centres of motor control in this region would seem to play down, so to speak, along the specialised channel of the "pyramidal tract," upon the lower automatic centres enforcing or inhibiting, as the case may be, their activity. They would seem to be developed on a secondary arc—the arc of control!—superposed upon the lower reflex or responsive arc with its automatic centres. Sensory centres in this arc of control would seem to be, as might well be expected, less definitely restricted in position, as they are also more difficult of investigation. In all this field of research, as in the transmission of impulses, we are experimenting more on the physiological than on the psychological side of psycho-physiology.

When we come to association, very little that is exact and assured is known of the physiological aspect. It is said that association tracts—that is, groups of fibres connecting together the several centres in the cerebral cortex—are almost, if not quite, absent at birth, and are established during the development of experience, which may well enough be so; but what may be the physiological conditions of their development, we can at present only guess. On the psychological side much has been written on association; and in recent times Mr. Francis Galton, followed by Trautscholdt and others, have carried out experiments with the object of estimating the time that

elapses between the reception of a simple impression and the occurrence of a simple idea suggested thereby. Such time would seem to be about three-quarters of a second.

Much attention has been paid to what is termed "reaction time"; that is, the time which elapses between a given simple stimulation and the resulting responsive motion. This was found by Lange to vary according as the person who is being tested directs his attention to the expected sense-impression or the anticipated motor response. In the case of a simple response to a visual stimulus, the reaction time in the former case is rather more than one-fourth of a second, but in the latter case only about one-sixth of a second. Practice tends to shorten the time, while fatigue lengthens it. A premonitory signal just before the stimulation markedly shortens it. Other experiments have been conducted with a view to ascertaining the time taken in simple cases of discrimination. This, too, varies very much with practice; and it is questionable whether the shorter time-values measure an act of discrimination properly so called. This part of the subject is full of difficulties in the interpretation of the results obtained.

In the Harvard psychological laboratory interesting researches have recently been carried out under the direction of Prof. Münsterberg. One of these deals with memory. Experimental results seem to show that a series of presentations offered to two senses at the same time, *e.g.* to sight and hearing, is much more easily reproduced than if given only to sight or only to hearing—a fact of educational value. Another series of experiments deals with the effect of attention. The unexpected result is reached that all stimuli appear relatively less when the attention is from the outset directed to them, as compared with stimuli received while the attention is otherwise occupied, *e.g.*, with simple addition sums. This result and the methods employed in the investigation are likely to undergo criticism.

Enough has now been said to indicate the kind of work on experimental lines which is being done in psychophysiology. In England, while valuable researches have been prosecuted in cerebral localisation, comparatively little has been done on the lines which are followed up in the German and American psychological laboratories, though Mr. Francis Galton's valuable psychometric observations have been based on somewhat similar methods. I think that this is a matter for regret. It is true that both methods and results need perfecting and clarifying. That is generally so in pioneer work. It is true that it is mainly to elementary and simple psychological processes that the methods are applicable. But we must begin with the simple, however desirous we may be of reaching a knowledge of the complex. It is true that such experimental work cannot take the place of introspective observation. But may it not be used to supplement the older method? English psychologists have done such good work on the old lines, that one could wish that the newer methods should be given a fuller and more extensive trial. Somewhat is indeed being done, and there are signs of improvement. We need also systematic work in zoological psychology. Observations which I have made on newly-hatched chicks and ducklings, stimulated thereto by suggestions from my friend Mr. T. Mann Jones, have convinced me that there is a wide field for careful experimental work on the instincts and the dawning phases of intelligence in young animals. We must employ the experimental method if we would make further advance in the study of the mental faculties of animals. Is it too much to hope that the time is not far distant when there shall be established in England chairs of zoological and experimental psychology, the occupants of which shall have the direction of adequately equipped laboratories wherein systematic observations, on the lines I have above indicated, may be conducted?

C. LLOYD MORGAN.

THE BEHAVIOUR OF LIQUIDS UNDER  
HIGH PRESSURES.

ONE of the most important generalisations which has been obtained in recent years from the study of the effect of temperature and pressure on the volume of stable liquids and gases may be expressed by the law that if the volume of a given mass of substance be kept constant, increase of pressure is proportional to increase of temperature. This relationship was proposed as early as 1878 by Lévy, who was indeed anticipated to some extent by Dupré in 1869, but was first set upon a firm experimental basis, at least for vapours, by Ramsay and Young in 1887. They represent it algebraically by the equation  $p = bt - a$ , in which  $p$  is the pressure,  $t$  the temperature, and  $b$  and  $a$  are constants which vary with the volume and the chemical nature of the substances employed, and the curve corresponding to this equation they term an isochor. The law may therefore be shortly expressed by stating that for stable substances the isochors are straight lines. This generalisation leads, as Fitzgerald has shown, to the significant conclusions that specific heat at constant volume must be a function of the temperature only, and internal energy and entropy must be expressible as the sum of two functions, one of which is a function of the temperature only, and the other a function of the volume only.

The experiments of Ramsay and Young extend at most over a pressure range of about 100 atmospheres, and it thus becomes a matter of considerable interest to ascertain if the linear isochor still persists under pressures which are very much higher, especially when the substances operated upon are liquids at temperatures which are well below their critical temperatures. Important data on this point may be gleaned from Nos. 92 and 96 of the *Bulletin* of the United States Geological Survey, wherein are grouped together accounts of the varied researches carried out during the last few years by Mr. Carl Barus on several of the high pressure phenomena of liquid substances.

His earlier work (*Bulletin* 92), completed in 1889, dealt with the isothermal compressibility of some fourteen liquids at temperatures and pressures having values as high as 310° and 600 atm. respectively—the pressure range being thus six times as great as that employed by the English observers.

From the data obtained, isochors<sup>1</sup> were eventually deduced with the result that, although below 180° they pursued a linear course, above this temperature under the high pressures employed they gave definite indication of being curved. To test by careful experiment over still wider ranges of pressure, this important question of curvature is the object of the later observations of Mr. Barus, which are detailed in No. 96 of the *Bulletin*.

The principle of the method there described consists in keeping the volume of the substance constant, and directly measuring the pressures which it supports at different temperatures, and thus obtaining immediately the data necessary for plotting the isochors. A new compression pump was devised, by means of which the enormous pressures of 2000 or 3000 atm. could be exerted. The temperature range was similar to that of the previous experiments, and the substances operated upon were ether, alcohol, thymol, para-toluidine, and diphenylamine.

The results thus obtained pointed conclusively to the fact that at high temperatures and high pressures the isochors of the liquids employed are really curved. In general the linear isochor persisted up to pressures of 1000 atm., and over temperature ranges which varied with the nature of the substance, the maximum temperature being about 115 in the case of ether, and

65° in the case of diphenylamine for the volumes used. These volumes, it may be mentioned, were not measured, so that no stress can be put upon the absolute slopes obtained for the curves. In all cases but that of thymol, the deviation from the straight curve was a marked abrupt phenomenon, and occurred generally between 1000 and 1500 atm. Thymol, however, gave no appreciable deviation.

What this curvature may mean is as yet but a matter for speculation. The author inclines to the belief that it indicates a change of molecular state, and evidence into which he does not enter may be taken to point to the same conclusion. Ramsay and Young's work on dissociating gaseous substances like nitrogen peroxide and acetic acid has shown that during the progress of molecular decomposition curved isochors are obtained, which apparently bridge over the gap between the linear isochors corresponding with the simple and complex molecular states. If a like explanation applies to the liquids at present under consideration, it leads to rather a curious result, for the curvature of the isochor for alcohol is in the opposite direction to that of the isochors for all the other liquids. It would therefore follow that under increasing pressure at constant volume the alteration of the molecular state of alcohol is in the opposite sense to that of all the other liquids, and the observed direction of curvature favours the view that the liquid alcohol molecule eventually becomes simpler, while those of the other liquids become more complex. Such a condition of things may the more readily be conceived when it is borne in mind that the general physical behaviour of alcohol, and more especially its behaviour with regard to surface energy, indicate that under ordinary conditions it probably contains molecular aggregates, the complexity of which alters as the temperature alters. A liquid like ether, on the other hand, seems to contain under ordinary conditions simple gaseous molecules. The above results would thus have the interpretation that, volume remaining constant, the complex molecule of liquid alcohol corresponding with the origin of the isochor remains of the same degree of complexity over wide ranges of pressure until in the region of high pressures it becomes less complex: whereas the simple molecules of a liquid like ether, under the same conditions, eventually become associated into more complex aggregations. Of course, until more data have been accumulated, the above explanation must be regarded as but a conjecture; indeed, any definite reason why the molecular complexities of liquids like alcohol and ether should be so different, under ordinary conditions, is at present entirely wanting. Whatever happens, the significant observations here considered have definitely shown that the law of linear isochors, although it is valid throughout wide variations in the external conditions, eventually breaks down in the region of high pressures and high temperatures.

No less striking results are obtained by Mr. Barus on the effect of pressure in solidifying a liquid. Here he studies the volume changes produced by pressure during the solidification and fusion of naphthalene at various constant temperatures, and he is thus enabled to plot several of the isothermal lines for liquid-solid naphthalene between the temperatures of 60° and 130°, and between the pressures of 40 and 1700 atm.

The remarkable result arrived at in this way is, that during change of state the "on" curve obtained by increasing the pressure and passing from liquid to solid is quite distinct from the "off" curve obtained on passing from solid to liquid. At any temperature solidification always occurred at a higher pressure than that at which the solid fused. This is, of course, in harmony with the well-known fact that the temperature of the ordinary melting point of a substance is in general higher than its temperature of solidification.

<sup>1</sup> Instead of isochor, Mr. Barus uses throughout his papers the term isometric, originally proposed by Willard Gibbs.

The curious cyclic shape of the isothermals is diagrammatically indicated in the figure, which also brings out another difference in the processes of fusion and solidification. For when the liquid begins to solidify there is a sharp angle in the curve, solidification being an abrupt phenomenon. When the solid melts, however, there is no such sharp angle, the inclined portion of the isothermal gradually curves round and merges into the horizontal portion which represents the condition of the substance when fusion has actually set in. By repeated tests the author satisfied himself that this curvature of the isothermal was not the result of imperfect experiment, but indicated a real condition of the substance, and it may therefore be taken to correspond to a portion of the continuous curve originally proposed by Prof. James Thomson to express what actually goes on during isothermal change of state, and which is predicted for liquids and gases by the equations of van der Waals and of Ramsay and Young. From a general survey of the isothermals obtained, it appears that the volume at which solidification begins, decreases, and the volume at which it ends remains constant, or perhaps slightly increases as temperature rises. These facts are indicated by the

sented on a single diagram. When this has been accomplished, material will be to hand for framing a comprehensive theory of what goes on during the obscure processes of change of state. Enough has already been done to give some idea of the extent to which the complexity of an equation like that of van der Waals, which involves but the third power of the volume, must be increased when attempting to express the complete passage from gas to liquid and from liquid to solid.

J. W. RODGER.

NOTES.

It is announced that an International Electrical Exposition will be held in Paris from July 1 to October 31, 1895.

DR. W. HAVELBURG has been appointed director of a laboratory recently established at Rio de Janeiro for the study of leprosy.

THE death is announced of Dr. L. Calderon, Professor of Chemistry in Madrid University, and of Dr. Karl Schmidt, Professor of Chemistry in Dorpat University.

WITH reference to the brief notice of the death of Mr. W. Pengelly, F.R.S., in our last number, Mrs. Pengelly points out to us that "he was spoken of as Secretary, instead of Honorary Secretary, of the Torquay Natural History Society, a title of which he was naturally and reasonably jealous, seeing that his connection with the Society was always of a donative, and never of a receptive, character."

MR. F. MOCKLER'S collection of relics of Dr. Jenner, recently exhibited at Bristol, is now on view at the First Avenue Hotel, Holborn. Admission to the exhibition is free to all members of the medical profession. A movement is on foot to purchase the relics as a whole by public subscription, and to offer them to the Royal College of Surgeons.

SIR PHILIP CUNLIFFE-OWEN, whose death occurred on Friday last, at the age of sixty-six, played an important part in the development of the Department of Science and Art. In 1857 he was appointed Deputy-General Superintendent of the South Kensington Museum, and three years later he became Assistant Director. He succeeded Sir Henry Cole as Director of the Museum in 1873, and held that position until last year, when he retired. He did much to organise the collections at South Kensington, and in the Bethnal-green Museum, of which he was also a Director. His ability to organise, and great energy, led to his appointment as executive commissioner on a number of exhibitions of the works of science and the arts, and for these labours, numerous British and foreign orders were conferred upon him. Though not a man of science, he claims our esteem for the many things he did to advance scientific interests.

THE British Museum has recently acquired a section of a trunk of *Sequoia gigantea* from California, having a diameter of somewhat over 15 feet. The annual rings have been carefully counted by Mr. Carruthers, and, two years ago, when the tree was cut down, it was 1330 years old. It was then still living and vigorous. It had, therefore, already attained a considerable age when St. Augustine introduced Christianity into Great Britain. The rings indicate a remarkably symmetrical growth on all sides of the tree. For the first five or six centuries they show a considerable annual increase in the girth of the trunk, getting gradually thinner as the superficies to be covered became larger, and becoming very thin for the last three or four centuries. It is satisfactory to learn, on the authority of Mr. Carruthers, that there were, in 1884, in all the groves which he visited, trees of various ages, so that the *Sequoia* is in no danger of early extinction.

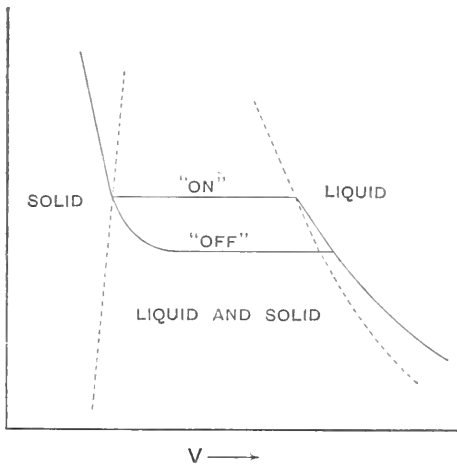

General shape of a Liquid-solid Isothermal.

dotted lines in the figure. We are thus enabled to map out a diagram for solid-liquid in precisely the same way as for liquid-gas, and arrive at the conclusion that at sufficiently high temperatures and pressures we shall reach the solid-liquid critical point. As far as the present experiments go, this point lies in the region of pressures above 4000 atm. and of temperatures higher than 200°. When the critical point is reached, the observations also show that the cyclic character of the isothermals will disappear. There will be no "volume lag" during fusion.

This "volume lag" the author regards as but a special case of hysteresis, having, besides its electrical and magnetic analogues, its counterpart in the phenomena of supersaturation, and the occurrence of all such phenomena he attributes to changes of molecular state. That a similar change lies at the root of the phenomena of solid-viscosity is the aim of a special series of investigations by Mr. Barus, which are collected in No. 94 of the *Bulletin*. The results obtained, however, are beyond the scope of the present article.

The main importance attaching to this work on naphthalene lies in the fact that it constitutes the beginning of a systematic study of the phenomena of solidification, which in conjunction with what is known regarding liquefaction, will ultimately permit of the entire transition from gas to liquid and from liquid to solid being repre-

THE committee appointed by the Council of the Royal College of Surgeons of England to state conditions for giving effect to the proposals of Mr. Charles Clement Walker for the foundation of a prize with a view to the encouragement of the investigation of cancer have, says the *Lancet*, recommended the adoption of the following regulations:—(1) The prize shall be awarded for the best work in advancing the knowledge of the pathology and therapeutics of cancer done either partially or wholly within the five years preceding the year in which the prize shall be awarded; (2) the first award shall be for the period ending December 31, 1895, after which the prize shall be awarded quinquennially, (3) the prize shall consist of £100 except on the first occasion, when it will be £60; (4) the prize shall be awarded at the quarterly meeting of the Council in the April immediately following the termination of each period, and will not be awarded unless the committee appointed to judge shall consider some work deserving of it; (5) the committee shall consist of five members chosen by the Council, but not of necessity members of the Council, and they shall be appointed not less than one year prior to the date of the award of the prize; (6) the grounds upon which the prize is awarded shall be made public; (7) the prize shall be open to foreigners as well as British subjects, members of the Council of the Royal College of Surgeons alone being debarred from competition.

In order to determine the heights of the highest cirrus clouds, only two methods have as yet been successfully attempted, namely, the measurement of altitude and azimuth by two or more observers some distance apart, and the determination of the exact time at which clouds are first seen illuminated by the morning sun, or last seen by the setting sun, coupled with which should be an approximate determination of the altitude and azimuth of the cloud. Prof. Cleveland Abbe gives an account of an observation of the latter kind in the U. S. *Monthly Weather Review*. On December 16, 1893, at 5.30 a.m. an observer at Potosi, Missouri, saw in the sky nearly overhead a bright redness of a tint like that of the rising sun. The phenomenon, which lasted for about fifty seconds, was not caused by a comet or meteor, nor was it auroral light, but was evidently the illumination by the sun's rays of a high, delicate cirrus cloud. The time of observation was about 1 hour and 40 minutes before sunrise, and allowing for the refraction by the air, it was found that if the cherry-tinted rays of the sun were at that time to illuminate a cloud in the position seen by the observer at Potosi, the cloud must have had an altitude of at least ten miles. Prof. Abbe remarks that in the clear sky of the early morning, and especially in the dry weather of summer, observers will be surprised to find how very early in the morning these delicate clouds may be observed, whence it follows that they must be correspondingly high, in fact, at latitude 52°, and on the 20th and 22nd of June they are reported to have been seen at midnight, when the sun is only 15° below the northern horizon.

*Himmel und Erde* for February contains an important lecture on cloud-formation, by Prof. W. v. Bezold. He discusses at some length the three principal causes of clouds:—(1) loss of heat by contact with the cold surface of the earth or sea; (2) mixture of unequally heated masses of air at or near the point of saturation; (3) expansion of air owing to change of pressure without sufficient increase of heat; and he illustrates each case by simple experiments. The paper contains some good representative pictures of clouds from photographs taken by Prof. Riggenbach and Dr. Neuhaus; and attention is specially drawn to certain wave-clouds not included in the classifications, but which Prof. v. Helmholtz has shown must occur by the passage of one stratum of air over another of different density, similar in all respects to the waves caused by

the wind passing over a cornfield, or over the surface of the water. These clouds become visible when the two strata of air possess sufficient humidity; they occur at very different heights, although they appear to belong more to the middle and higher regions of the atmosphere than to the lower. When they are high enough for several of them to be seen at one time, they form the cirro-cumulus cloud, or mackerel sky. Two pictures of these clouds are given in the text.

WE learn from the *American Meteorological Journal* for March, that the papers read at the Chicago Congress of Meteorology, Climatology, and Terrestrial Magnetism, held last August, are to be published by the United States Weather Bureau in several parts, corresponding to the different sections of the Congress. The first part is nearly ready, and the remaining ones are expected to appear shortly.

THE island of Sakhalin, in the extreme east of Asia, remains one of the least known regions of the Western Pacific, partly, it is probable, because of its use by the Russian authorities as a penal station reserved for the worst offenders, to which outsiders are rarely admitted. In the new number of *Petermanns Mitteilungen*, F. Immanuel gives an admirable epitome of the geography and the present condition of the island, collected from the most recent Russian authorities and illustrated by a map. The mountainous northern interior of Sakhalin is still practically unexplored, but the southern and middle portions are fairly well known. The island has mineral resources of considerable importance, over two million tons of coal having been raised at Dui in 1890. The climate is changeable and ungenial, rain or snow falling on more than half the days of the year, and snow more frequently than rain. The population in 1891 was estimated to include 16,400 Russians and 3200 natives, the latter being mainly Gilyaks (1700) in the north, and Ainu (1100) in the south.

FROM a note in *Insect Life* it appears that attempts are being made to introduce an effective system of quarantine against injurious insects in California. The State is now importing fruits, trees, shrubs, plants, and seeds from Europe, Australia, China, Japan, South Sea Islands, South and Central America, and other localities, and hardly a vessel arrives at its ports which does not bring such objects, many of which are infested with some insect or fungus pest. At the Cape of Good Hope a quarantine law is in operation giving the Governor the power to provide by proclamation for protection against the importation and spread of pests, and providing a heavy penalty for its contravention. It is proposed to adopt similar legislation in California, and if the State succeeds in making its measures in this direction effective, its example will in all probability be widely followed.

THE relation of the sounds of fog signals to other sounds forms the subject of an important paper contributed to *Science* by Charles A. White, of the Smithsonian Institution. The areas of inaudibility which occur well within the range of most, if not all, the fog signals which the various civilised governments have established along their coasts, usually in connection with a lighthouse, are of two kinds. For the first kind the author suggests the name of *mountain* areas, since they are true acoustic shadows cast by mountain ridges or islands within the range of the signals. The other kind, which is found in the open sea, and whose origin is not yet understood, he proposes to call *pseudomountain*, since they imitate the phenomena of acoustic shadows. There is, however, one important difference. From experiments performed at Sandy Hook upon a pseudomountain area it appears that sounds such as that of a steamer's



whistle were audible at the lighthouse when proceeding from a point within the area, whilst the fog signal itself was inaudible on board the steamer. This would indicate a peculiar one-sided action of the boundary of the area, or a differential effect upon the two kinds of sounds. Another peculiarity of these areas of inaudibility is that they do not annul sounds except those coming in a particular direction. Thus a vessel may be in a montumbral area with respect to a fog signal. A schooner with all sails set and close-hauled may be proceeding outside this area in such a manner as to produce a sail-echo of the fog signal audible on the first vessel. The signal will then appear to those on board to come from the direction of the schooner. Of the two kinds, the pseudumbral areas are the more dangerous, since their place is never quite fixed, and they can only be discovered and mapped empirically—in the present state of our knowledge, at all events.

THE current number of the *Electrician* contains a note by Prof. Fitzgerald on a recent paper of Herr P. Lenard's, which appeared in *Wiedemann's Annalen*. Herr Lenard has continued his interesting observations on the cathode rays in gases under ordinary pressures and in extreme vacua. In the experiments with high vacua, exhaustion was carried on till a coil, capable of giving a spark 15 cm. long in air, could not produce any discharge between terminals sealed into the experimental tube. Herr Lenard estimates that, when he had condensed the mercury vapour in a connected globe by lowering its temperature to  $-21^{\circ}\text{C}$ ., the pressure of the remaining gas was about  $0.03 \times 10^{-6}$  of an atmosphere, or about 0.03 dyne per square centimetre. In a tube in which the exhaustion had been carried to this extent nothing was visible on the path of the rays except where they impinged on the glass at the opposite end of a tube 150 cm. long, and when there were no magnets near, they were propagated in straight lines. From these and many other interesting observations Herr Lenard concludes that the cathode rays are phenomena in the ether, and are independent of the presence of matter. With reference to this point Prof. Fitzgerald says:—"If this be so they are a most remarkable addition to the properties of the ether. Phenomena that may all be classed under light propagation are the only known phenomena of propagation in free ether. There is a very essential difference between these cathode rays and ordinary light propagation, and only for this these rays might be very rapid ultra-violet waves, which are known to be rapidly absorbed by air and other gases, but which may be able to run the gauntlet of hundreds of thousands of molecules without being finally absorbed, and might, in accordance with the known transparency of gold leaf, be able to penetrate any solid, even though a conductor, because for their extremely rapid vibrations the molecular motions upon which ordinary conductivity depends may be much too slow to have any sensible effect. The fact that seems conclusive against this view is the deflection of the rays by a magnet. These rays are deflected in the same way as a conductor carrying a current of electricity away from the cathode. No such action has ever been observed on rays of light. It would be most natural to explain the action by the presence of the matter which is generally required in order to be acted upon by a magnet. There seems very little reason for supposing that a magnet would act upon electric displacement currents in the ether, even if displacement currents of the straight ray kind were possible in the ether without propagating themselves out sideways with the velocity of light. When we recollect that in the vacua described by Herr Lenard there are still  $10^{10}$  molecules per cubic m.m. there does not seem sufficient reason for looking to an unknown property of the ether when there is so much matter present to explain the phenomenon."

NO. 1274, VOL. 49]

PROF. KAYSER AND RUNGE's seventh paper on the spectra of the elements, communicated to the Berlin Academy of Sciences in December last, has been published in separate form. The elements of which the spectra are described in the paper are tin, lead, arsenic, antimony, and bismuth. In the case of the spectrum of tin the lines extend from wave-length 2053.8 to 5631.91, and fourteen lines are marked as new. The spectrum of lead was investigated between  $\lambda\lambda$  2088.5 and 6002.08, and thirteen new lines were discovered. Lines are tabulated for arsenic from  $\lambda$  2009.31 to  $\lambda$  3119.69. The antimony spectrum is limited by a line at 2068.54 in the ultra-violet, and one at 5730.52 in the red, seven new lines being included. Bismuth has had its spectrum observed between the wave-lengths 2061.77 and 5742.74, and twenty-two new lines have been discovered. At the end of the paper the authors discuss the distribution of the lines and groups in the different spectra, and show that the positions admit of being determined mathematically.

THE behaviour of the filtrate from tetanus cultures when exposed to sun-shine is perhaps the most interesting of the numerous observations made by Fermi and Pernossi. Already in 1891 Kitasato tested the pathogenic properties of tetanus filtrates obtained from broth cultures kept in the dark and light respectively, and found that exposure to diffused light gradually rendered them innocuous; it was, however, a very slow process, for even after from nine to ten weeks the filtrate was still feebly toxic. On the other hand, similar filtrates preserved in the dark were still, after 300 days, just as actively pathogenic to animals as when they were originally prepared. In direct sunshine ( $35^{\circ}$ - $43^{\circ}\text{C}$ .), however, such filtrates were rendered perfectly harmless in from fifteen to eighteen hours. On the other hand, Fermi and Pernossi found that the toxic properties were destroyed after from eight to ten hours of sunshine during which the maximum temperature reached was between  $38^{\circ}$ - $41^{\circ}\text{C}$ ., whilst when similarly exposed, the temperature, however (owing to the experimental tubes being immersed in water), not rising beyond  $37^{\circ}\text{C}$ . it required fifteen hours to produce the same result. When, however, the filtrate was first dried and then exposed to sunshine, it remained toxic even after 100 hours' insolation, the same results being obtained when the desiccated filtrate was mixed with chloroform, ether, benzol, and amyl alcohol respectively, and exposed to sunshine. The elaborate nature of the experiments, as well as the large number undertaken and the conscientious care with which they have been conducted, combine to render this one of the most important memoirs which has been yet published on the subject of tetanus.

A FURTHER illustration of the singular media in which fungi will thrive is afforded by the observation of M. Heim, recorded in the *Bulletin* of the Société Mycologique de France, of an abundant fungus-mycete in a solution of sulphate of quinine. It produces a fructification which shows that it belongs to the genus *Aspergillus*, and M. Heim proposes for it the name *Aspergillus quinina* sp. n. (?)

THE annual report of the Board of Regents of the Smithsonian Institution, showing the operations, expenditures, and condition of the institution to July 1891, has just reached us. The volume contains an appendix comprising a selection of miscellaneous memoirs of interest to collaborators and correspondents of the institution, teachers, and others engaged in the promotion of knowledge.

WE have received parts i. and ii. of the thirty-seventh volume of the *Transactions* of the Royal Society of Edinburgh, and vol. xx. (pp. 97-160) of the *Proceedings*. Among the investigations described in the volumes we note the work of Prof. Crum Brown and Dr. James on the electrolytic synthesis of

dibasic acids; of Prof. Tait on impact; of Mr. Aitken on the particles in fogs and clouds; of Dr. John Murray on the chemical changes which take place in the composition of seawater associated with blue-muds on the ocean floor; and of Dr. Poë on colour-blindness. Prof. Copeland's paper on Nova Aurigæ is included; and also that of Prof. Knott on circular magnetisation; of Prof. Ewart on the lateral sense-organs of *Masobranchs*; of Prof. James Geikie on the glacial succession in Europe; of Dr. Noël Paton on the action of the valves of the mammalian heart; and of Dr. Macfarlane on the minute structure of plant hybrids in relation to that of their parents.

RATHER more than one hundred years ago Christian Konrad Sprengel gave to the world his investigations on flower-fertilisation. The acute observations contained in "Das Entdeckte Geheimniss der Natur im Bau und in der Befruchtung der Blumen"—the secrets of nature in the forms and fertilisation of flowers discovered—have been reprinted by Engelmann, of Leipzig, in Nos. 48 51 of Ostwald's *Klassiker der Exakten Wissenschaften*. Every naturalist now knows that Sprengel's theory of insect fertilisation was not a full interpretation of nature's secrets. His careful observations, however, were of prime importance in helping to establish the true theory of cross-fertilisation presented by Darwin some seventy years after the publication of his work. In addition to the above reprint we have received No. 44 of the same series, entitled "Das Ausdehnungsgesetz der Gase." The volume contains a capital collection of papers on the law of gaseous expansion, by Gay-Lussac, Dalton, Dulong and Petit, Rudberg, Gustav Magnus, and Regnault, published from 1802 to 1842.

THERE is a school of philosophers who insist that all investigation into the causes of things is wasted labour, and that science progresses solely through the study of phenomena and their laws. Mr. Lester Ward is not one of these, for in a lecture on the "Status of the Mind Problem," recently delivered before the Anthropological Society of Washington, he showed that the work of Ramón y Cajal, and others, indicated that protoplasm is not merely the physical basis of life, but is the physical basis of mind also. In his words, "the prevailing fashion among scientific men of emphasising the 'mystery of mind' is unnecessary and illogical, since mind is no more a mystery than matter, and all that there is any ground for confessing is that, in consequence of the greater complexity of mental phenomena, due to the higher state of development of the material basis of mind, we possess as yet much less knowledge of them than we do of many of the simpler phenomena of nature."

A SERIES of compounds of sugars with mercaptans, the sulphur alcohols, of a nature similar in many respects to that of the recently isolated glucosides formed by the combination of ordinary alcohols with the sugars, are described by Prof. Emil Fischer in the current *Berichte*. These new substances differ from the glucosides of the alcohols in their constitution, however, for they contain two equivalents of the sulphur alcohol to one equivalent of the sugar; hence they are more nearly allied to the similarly constituted compounds of mercaptans with ordinary aldehydes. The members of the series fully described are the ethyl mercaptals of grape sugar and of galactose, and the amyl mercaptal of the former. In addition to these Prof. Fischer has isolated the ethyl mercaptals of mannose, arabinose, rhamnose, and  $\alpha$ -glucoheptose, and has qualitatively proved the generality of the reaction for xylose, maltose, and milk sugar. The compounds appear likely to prove of very great importance, for their formation occurs so readily, that they will serve admirably in many cases as valuable aids in the identification and isolation of either the well-known or newly-discovered sugars. The amyl compound in particular appears likely to be of great service, on account of its slight solubility. They are all sub-

stances of considerable stability, and crystallise well. Glucose ethyl mercaptal,  $C_6H_{12}O_5(SC_2H_5)_2$ , is prepared by mixing ethyl mercaptan with an ice-cold solution of grape sugar in fuming hydrochloric acid. Upon cooling, after the slight rise of temperature which accompanies the reaction, crystals of the new compound separate, and may be advantageously recrystallised from absolute alcohol. The reaction is simply an addition of two molecules of the mercaptan to one of glucose with elimination of a molecule of water.

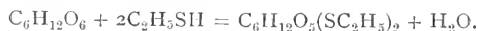

Glucose ethyl mercaptal crystallises in colourless needles and plates, which possess a taste very different to that of sugar, being disagreeably bitter. The crystals melt at 127°, and the liquid may be partially distilled at a higher temperature. The substance is only slightly soluble in cold water, and the solution is *lævo*-rotatory. It behaves as a weak acid, and it is somewhat remarkable that alkalis dissolve the crystals in large quantity, and upon the addition of a dilute acid the compound is precipitated. Indeed the sodium salt,  $C_{10}H_{21}S_2O_5Na$ , has been isolated in well-defined crystals by treating the compound with sodium dissolved in methyl alcohol. That the substance is very different in its nature from the original glucose is further evidenced by the fact that it does not reduce Fehling's solution. The other members of the series appear to be characterised by similar but graduated properties, the solubility, for instance, diminishing as the homologous series of mercaptans is ascended.

CHLORAUROATE of silver,  $AgAuCl_4$ , an interesting compound of the very soluble and deliquescent chloride of gold with the particularly insoluble chloride of silver, is described by Dr. Hermann, of Aschaffenburg, in the same number of the *Berichte*. This compound has formed the object of previous unsuccessful researches, but its preparation is very simple when the necessary conditions are known. Four parts by weight of metallic gold is dissolved in aqua regia, and the solution evaporated over the water bath, until upon cooling the resulting chlorauric acid,  $HAuCl_4$ , crystallises. One part by weight of silver dissolved in dilute nitric acid is then added, when silver chloride is precipitated in its usual form. Upon repeated evaporation of the whole with concentrated nitric acid containing a trace of hydrochloric acid the silver chloride changes, becoming coloured bright red, and eventually is completely converted into a mass of crystals of silver chloraurate. The crystals are long prisms terminated by pyramids and dome-faces; they appear to be coloured bright orange-red when singly examined by reflected light, but are pure yellow by transmitted light, and the finely-powdered substance reflects bright yellow light. It is interesting to note that when enclosed in a sealed tube containing perfectly dry air the compound is quite stable and unaffected by bright sunlight, but the moment it is exposed to sunshine in ordinary moist air it commences to bronze, and eventually becomes superficially coated with a dark bronze metallic coating. Dilute hydrochloric acid instantly decomposes it with formation of silver chloride and a solution of chlorauric acid. Ammonia, on the other hand, decomposes it with production of the usual ammoniacal solution of silver chloride and deposition of fulminating gold.

THE additions to the Zoological Society's Gardens during the past week include a Vervet Monkey (*Cercopithecus landi*) from South Africa, presented by Mrs. White; two Cockateels (*Calopsitta nove-hollandie*) from Australia, presented by Mrs. Tidey; a Leadbeater's Cockatoo (*Cacatua leadbeateri*) from Australia, presented by Mr. J. Ward; a White-bellied Eagle (*Haliaeetus leucogaster*) from Australia, presented by Mrs. Scales; a Ring-necked Parrakeet (*Palaeornis torquatus*) from India, presented by Miss Castle; two Peregrine Falcons (*Falco peregrinus*) British, presented by Mr. Penn C. Sherbrooke; a

Great Eagle Owl (*Bubo maximus*) European, presented by Mr. H. Godman; two Black Apes (*Cynopithecus niger* ♂ & ♀) from the Celebes, a Greater Sulphur-crested Cockatoo (*Cacatua galerita*) from Australia, deposited; two Alpine Accentors (*Accentor collaris*) European, purchased; a Coypu (*Myopotamus coypus*) born in the Gardens.

### OUR ASTRONOMICAL COLUMN.

PHOTOGRAPHIC NEBULOSITIES IN THE MILKY WAY.—In the March number of *Astronomy and Astro-Physics*, and in several recent numbers of *Knowledge*, Prof. E. E. Barnard describes a number of wisps of nebulosity and diffused masses of luminous haze discovered upon photographs taken by him with a portrait lens six inches in aperture and having a focal length of thirty-one inches. A remarkable and large nebulous mass, situated about R.A. 21h. 34m. Decl. + 56° 50' appeared upon a plate exposed for seven hours. The picture shows a straggling group of bright stars in the centre of the nebula, which is more than two degrees in diameter. The group of stars is visible to the naked eye as a hazy spot, about three degrees north-west of the variable  $\mu$  Cephei, the brightest star in the group being D.M. + 56° 2617. The star D.M. + 57° 2309 (mag. 6.5) is also shown by the photograph to be surrounded by a rather unsymmetrical dense circular nebulosity. This object was not previously known to be nebulous, though Prof. Barnard says that with the telescope the nebulosity can be seen as a hazy glow about the star. The region of the Milky Way lying north and east of Orion appears to be singularly rich in large diffused nebulosities. Photographs show that  $\omega$  Orionis and  $\lambda$  Orionis are nebulous, while there is a faint and large diffused glow near the stars  $\nu$  and  $\xi$  Orionis. There was a suspicion of a large nebulosity about  $\alpha$  Orionis on one of the plates, but this has not yet been verified. The existence of the other nebulosities, however, has been established either by telescopic observation or new photographs. A photograph obtained at the beginning of last month shows two very singular fan-shaped patches of nebulosity close to  $\gamma$  Cassiopeie. These are about 15' in diameter and point towards the star. They could just be seen by Prof. Barnard with the 12-inch of the Lick Observatory, but he thinks they would never have been detected if the photographic plate had not revealed them. Photographs of the region about 15 Monoceros show that this group of bright stars is mixed up with misty matter having a diameter of about three degrees. The place of 15 Monoceros for 1860 is R.A. 6h. 33m. 16s. Decl. + 10° 1' 3, and the condensation of the remarkable nebula in question is 12' south preceding the star. Prof. Barnard has now photographed the Milky Way from Scorpio to Orion, discovering many masses of nebulosity on the way. His pictures are not only beautiful views, but valuable records of the structure of the different regions portrayed.

MADRAS OBSERVATORY.—From the report of the Madras Observatory, just published in the Monthly Notices of the Royal Astronomical Society (vol. liv, No. 4), it appears that the Secretary of State for India has given his sanction to the proposals made by the Government of India regarding the future of the observatory. The observatory, which has hitherto been under the Madras Government, will, from April 1, be transferred to the Imperial Government. According to the report, a new observatory for solar physics will be erected at Kodarkanal, on the Palani Hills, under the direction of the present officiating Government Astronomer, who will, for the present, also have charge of the existing observatory. The new institution will undertake the work of solar photography now carried on at Dehra Dun, and will also take up spectroscopic work on the sun, and actinometric researches.

A NEW COMET.—The first comet of this year was discovered by Mr. Denning on Monday evening in R.A. 9h. 55m. Decl. +32° 15'. It was small and faint, and exhibited a short fan-shaped tail. The object was moving towards the east-south-east at the rate of nearly one degree per day.

### RECENT INVESTIGATIONS AND IDEAS ON THE FIXATION OF NITROGEN BY PLANTS.

THREE totally different, though convergent, scientific controversies have arisen during the latter half of the present century concerning the *role* played in nature by nitrogen, as

met with in the air, rain, and soil, free or combined, in connection with the ordinary plants of agriculture and forestry; and, quite apart from their real relations to one another, these three controversies have at times been somewhat confused in their issues.

One of these controversies turned on the question of the transformations of combined nitrogen, as met with in the forms of ammonia, nitrites, and nitrates, and as organic compounds of nitrogen resulting from the decomposition of the remains of living beings—plants and animals—in the soil. The outcome has been the proof that oxidations and de-oxidations of these compounds are intimately bound up with the physiological activities of living organisms, especially bacteria in the soil: the investigations of Giltay and Aberson, and Winogradsky's brilliant researches especially, have brought what had long been regarded as purely chemical problems into the domain of biology. "Nitrification" and "de-nitrification," to use the current terms, are phenomena incorporated with those of fermentation, respiration, &c., and therefore involve biological science for their elucidation.

Another of these controversies turned on the question whether the free nitrogen which forms so large a proportion of that huge gaseous ocean, the atmosphere, can be again directly employed by green leaves, and built up as combined nitrogen in plants; or whether, once having been disengaged from organic and other compounds, and passed into the air as gaseous nitrogen, it is for ever lost, except in so far as electric discharges and other energetic physical and chemical processes force this relatively inert element into combinations, which the rain then brings down as inorganic salts, and so help to restore the balance of nitrogenous substances in the soil.

This controversy, a long and involved one, started and for some time continued as a peculiarly chemical question, has passed through various phases and branched out into several subsidiary controversies, if we may so term them.

Thus the alleged "fixation" in the soil, especially investigated by Berthelot and André, became a scientific question apparently on definite lines of its own, and (so far as any such question can be independent) independent of the question whether ordinary green-leaved plants, such as peas, lucerne, wheat, &c. can assimilate the free nitrogen of the atmosphere by processes more or less comparable to those by which they are known to assimilate the carbon they wrench from the carbon-dioxide of that gaseous environment.

The latter question, again, became a divided one, chiefly owing to assertions that green leaves could directly assimilate the ammonia, if not the free nitrogen, of the air, and some time was occupied in arriving at the conclusion that ordinary green plants do not directly assimilate or fix either the gaseous ammonia or the free nitrogen of the atmosphere. This conclusion, in opposition to that arrived at by Ville, was regarded as so thoroughly established by the experiments of Boussingault and of Lawes, Gilbert, and Pugh, that it has been definitely accepted and taught for many years—and rightly so, from the evidence to hand.

The third of the three controversies referred to at the outset, is the more recent one concerned with the question whether certain of the higher green-leaved plants, particularly those known as leguminous plants (such as peas, beans, clovers, vetches, lupins, robinia, &c.), when living as they normally do in symbiotic association with certain micro-copie and essentially parasitic fungoid organisms which invade their roots, are differently placed from other green plants as regards the power of "fixing," and assimilating, the free nitrogen of the atmosphere.

The present position of opinions on this last and most remarkable controversy is the subject of this article, so far as it can be done justice to in the short space at disposal.

It is now well known that leguminous plants are normally found to have certain nodosities or swellings on their roots, and that these swellings are caused by the activity of certain minute organisms which, as the writer of this article first proved, invade the roots from outside, after the manner of a parasitic fungus. The controversy as to the exact nature of these organisms—bacteria, according to Prazmowski, Beyerinck, and others, degraded allies of the Ustilaginæ, or some lower fungus, according to my observations, and the confirmatory evidence of Laurent—in no way affects the truth that these organisms do not kill the plants attacked, or even make them diseased, but incite them to more active life for a time. The evidence on

which these organisms (termed "bacteroids") have been taken to be bacteria—their growth in gelatine tubes, staining, and their minute size—is equally in favour of their being lower fungi, and is not sufficiently conclusive. Eventually the nutritious contents of these nodules, with the symbiotic "bacteroids," are absorbed, in whole or in part, by the leguminous plant, and their rich stores of nitrogenous material assimilated by the latter.

The experiments of Hellriegel and Wilfarth, of Lawes and Gilbert, and of others and myself, placed it beyond reasonable doubt that, taking the leguminous plant and its symbiotic organisms together with the pot of soil in which it is grown as a closed system, this system contains more nitrogen at the end of several weeks than can be accounted for by the nitrogen in the soil and the seed at the commencement of the experiment; and this was true in cases where careful precautions were taken to prevent the addition of any nitrogen further than the free nitrogen of the air. The only legitimate conclusion was that somewhere, and somehow, the system fixes free nitrogen from the air.

This matter has been since carried further, however, by Laurent and Schloësing, who, by growing various plants in an air-tight apparatus under such perfect control that they could analyse the quantity of nitrogen both in the plant and soil, and in the purified air, showed that the gain of nitrogen in the former during the progress of the experiments, is balanced by a corresponding loss in the latter. They further showed that only two kinds of plants could thus "fix" the nitrogen of the air. These are leguminous plants, and certain lower algæ (perhaps mixed with bacteria) or allied forms. This fixation only occurs under certain definite conditions, moreover. The leguminous plants must be infected with the symbiotic "bacteroids," and the algæ must be exposed freely to the air and light in the apparatus: even a thin layer of the sterilised sand employed sufficed to stop the action of the algæ.

Laurent and Schloësing found no fixation in the case of artichoke, oats, tobacco, mustard, cress, or any other plants experimented with; and their experiments, taken as crowning the edifice of evidence accumulated by them and numerous other observers, have been fairly regarded as proving that leguminous plants, at any rate, and perhaps certain lower algæ, do somehow "fix" the free nitrogen of the atmosphere and assimilate it.

Koch and Kossowitsch have recently claimed to confirm the above results of Laurent and Schloësing with algæ, and it should be mentioned that Frank had previously stated that such fixation by lower cryptogams occurs. Unfortunately we are as yet uninformed what species of algæ are exactly concerned here, and no one has cultivated them pure and confirmed the results.

It will be noticed that, so far, all that is established is that the infected leguminous plants, and the algæ of sorts, *plus* the known soil (usually sterilised sand to which known additions are made), somewhere and somehow gain in nitrogen at the expense of the free nitrogen of the atmosphere.

Now come the other aspects of the controversy, which is raging chiefly around the question as to exactly where and how this gaseous nitrogen is fixed.

Obviously several possibilities could be suggested.

(1) The gaseous nitrogen could be conceived as directly fixed by the plant which gains in nitrogen—as absorbed by the protoplasm of the living cells exposed to the air—*e.g.* the cells of the leaves of the leguminous plant, or those of the algæ on the surface of the soil. This view is actively maintained by Frank and a few supporters, who go as far as is possible in this direction, and really again raise the old question which originated with De Saussure, and was rightly regarded as refuted by Boussingault and Lawes and Gilbert.

(2) The gaseous nitrogen could be conceived to be fixed in the soil by means of bacteria or lower algæ (we have seen these are left indefinite), and, when it has been converted into nitrogenous compounds of some kind in the soil, eventually absorbed by the roots of the leguminous or other higher green plant in the ordinary course of events. The principal champion of this view is Berthelot, who claims to have proved that certain soil-bacteria, and also the organisms of the leguminous root-nodules, have the power of fixing the free nitrogen of the air, and so enriching the soil in nitrogenous compounds. In this connection, of course, the whole question of nitrification and de-nitrification in the soil will no doubt be involved with the question of the fixation of free nitrogen from the atmosphere.

(3) The fixation of the atmospheric nitrogen could be con-

ceived of as a powerful act of the machinery of the leguminous plant, urged to the necessary expenditure of energy by the stimulating action of the symbiotic organism in its roots. This view, held especially by Hellriegel, Prazmowski, and others, is also shared by Frank, who believes that it is only in their being thus stimulated to greater activity that the leguminosæ differ from many other plants, which, he says, also fix the atmospheric nitrogen directly, but to so much less an extent that the experimental proof of their power to do it is far more difficult.

(4) Another possible view is that the root-organisms act merely as accumulators of nitrogenous material, which has been derived from atmospheric nitrogen fixed and combined in the soil, by physical or chemical processes, or in the open ground by the action of soil-organisms; and the leguminous plant benefits by devouring (if we may employ this word) the bacteroids eventually, and profiting by their stores of nitrogenous material.

Let us now take these four possibilities in order, and examine them a little more in detail.

The first view rests almost entirely on the statements of Frank, of Berlin, who brings forward a number of experiments which in his opinion show that many higher plants, in addition to the leguminosæ, are capable of directly assimilating the free nitrogen of the atmosphere. For instance, Frank gives results showing that oats, buckbeans, spurrey, turnips, mustard, potatoes, and Norway maple are all capable of fixing atmospheric nitrogen.

Most of Frank's experiments were made in the open air, the pots of plants being simply sheltered from rain; but in some cases, he affirms that he got positive increase of nitrogen with mustard-plants under bell-jars, properly shut off from the outer air, and through which purified air was drawn.

Apart from these latter, and in spite of Frank's assertion that the quantities of combined nitrogen in the air are so immeasurably small that they may be neglected, it seems fair to object that, in the present state of science, we cannot trust experiments in the open air to decide such a point; while, with regard to the experiments with mustard, it must not be forgotten that not only the old results of Boussingault and Lawes and Gilbert are entirely and emphatically opposed to them, but the exceedingly careful recent experiments of Schloësing and Laurent, made with all modern appliances and methods, showed the contrary—no signs of fixation of nitrogen could be obtained in oats, tobacco, cress, mustard, cabbage, spurrey, and potato, the very plants Frank used.

Frank replies that completely normal plants cannot be grown under such closely covered glass vessels as these experimenters use, but he accepts their positive results in all cases. Frank's contention is that the plant must be very vigorous, and near its maturing point, before it has power to energetically seize and "fix" the atmospheric nitrogen; but (without denying that it is possible that the utmost vigour may not be as yet attainable under the conditions necessary for culture in closed glass receptacles of limited capacity) it is impossible to overlook the danger that in experiments in the open air, the time which must necessarily elapse before Frank's critical period of maturity on the part of the plant is reached, is long enough for all sorts of disturbing influences to come in, especially if any kind of "fixation" in the soil, such as Berthelot asserts, really occurs: the root-hairs would take up, and the plant absorb, nitrogenous bodies as fast as they were formed in the soil around them, while there would be ample time for the development of many generations of micro-organisms in the medium.

In view of the tenacity with which the belief in a direct absorption of atmospheric nitrogen is cherished by many foresters and agriculturists, it seems imperative that critical experiments should be persevered in; as matters stand, we cannot accept Frank's position as proved, or even as rendered probable.

The possibility mentioned above as an explanation of the danger of accepting Frank's results would be rendered a certainty if the recent researches of Laurent and Schloësing, Koch and Kossowitsch, and Berthelot, in part supporting earlier statements by Frank himself, turn out to have been properly interpreted.

Laurent and Schloësing—and their results are confirmed by Koch and Kossowitsch—declare that sterilised sand, devoid of nitrogenous material, when covered with a growth of certain green and blue-green algæ, probably mixed, however, really does "fix" the atmospheric nitrogen, and gains in nitrogen-

compounds, but only if the algal growth is freely exposed to the atmosphere in the closed chambers employed. These statements confirm earlier, but less definite, experimental results by Frank; and the latter has recently expressly stated that certain fungi—*e.g.* *Penicillium cladosporioides*—can flourish in a medium to which no nitrogen but that of the atmosphere has access.

Berthelot goes further, and claims to have established that several species of soil-bacteria and fungi, including the fungoid organism of the leguminous tubercles cultivated separately, can "fix" free nitrogen; and if the analyses of the small quantities of materials in his flasks survive the criticism of the chemists, it seems difficult to refuse credence to the views he puts forward; but, as in most of these cases, it is the enormous difficulties of analyses which lie at the root of the matter.

Moreover, different observers differ considerably on this question. Beyerinck, while regarding it as probable that the nodule-organisms "fix" atmospheric nitrogen, admits that he does not prove it; and in Laurent's special investigation into this question, he left it also uncertain; while Immendorf failed to satisfy himself that these organisms can flourish without organic compounds of nitrogen; and Frank insists that they do not thrive at all without organic nitrogenous food-materials. Moreover, it must not be overlooked that other observers, *e.g.* Gautier and Drouin, have given evidence pointing to possible phenomena of "fixation" of nitrogen by compounds of iron and other substances clinging to particles of the sand employed, which may interfere with the accuracy of conclusions drawn from experiments where sterilised soil in the open air is concerned.

When we reflect how very minute these organisms are, and what excessively small quantities of nitrogen they need for their life-purposes, we cannot be surprised at the difficulties met with in these investigations. But, however far from proved we may regard the question of fixation of free nitrogen by soil organisms, it is perfectly clear that here is a most pressing question for further experimental research, and agricultural and forest practice are alike keenly interested in having the question definitely answered.

The third possible view—that the leguminosæ are able to force free nitrogen into combination with other elements, owing to the energetic action of their protoplasmic machinery stimulated by the symbiotic fungoid organism—deserves more consideration than may at first sight appear, especially to those who are not familiarised with the remarkable phenomena of symbiosis generally.

In the first place, the fact that leguminous plants amply provided with the root-nodules do "fix" the atmospheric nitrogen, under conditions in which the same plants devoid of the nodules fail to increase their supplies of nitrogen, is far better established than any of the other cases discussed, and must now be accepted as proved by the experiments of Frank, Hellriegel, myself, Lawes and Gilbert, and especially by the recent splendid investigations of Laurent and Schloësing.

It is true that Frank says the symbiosis is not absolutely necessary for the fixation to proceed, but even he declares that the leguminosæ are stimulated to greater powers of nitrogen-fixation by the nodule-organisms.

A curious and significant confirmation of the symbiosis theory comes from the experiments of Nobbe, Schmid, Hiltner, and Hotter, who find that *Elaeagnus* plants, the roots of which develop nodules due to the invasion of a fungus totally different from the one causing the leguminous nodules, also "fix" and assimilate the free nitrogen of the atmosphere, as shown by their growing and flourishing much better and more rapidly than *Elaeagnus* plants side by side with them, but not infected with the root organism. It will be interesting to see if further research shows similar results with any of the physiologically similar root-outgrowths, due to very different fungi, met with in *Taxodium*, *Podocarpus*, *Abnus*, *Fucus*, and many other plants, including some vascular Cryptogams.

Now comes the question, in what part of the leguminous plant does the actual "fixation" of the free nitrogen occur? Frank stands practically alone in claiming the leaves to be the organs concerned. Nearly all other observers regard the roots as the region, and the nodules themselves as the actual seat of fixation.

Kossowitsch has even attempted the heroic task of deciding between leaves and roots, by enclosing the former or the latter respectively in air-tight receptacles, shut off from the non-enclosed

parts, in which gases devoid of nitrogen were circulated. He could not always keep the apparatus perfectly gas-tight, however, and this and other failures met with in these exceedingly difficult experiments, undoubtedly weakens the force of his conclusions that it is in the roots and not in the leaves that the process occurs, though it does look as if the balance of evidence obtained fairly support his conclusion so far as it goes.

There are facts, however, to be gathered from the microscopic analyses of the root-nodules, as furnished by myself and others, which have been in great part overlooked in the discussions on this subject, and which, although not conclusive, seem to support the view that the seat of fixation may be in the nodules themselves. For instance, the nodules are supplied with a regular system of conducting vascular bundles, communicating with those of the roots; then their cells, during the period of incubation of the symbiotic organism, are abundantly supplied with starch; further, the cells in which the fungoid organism is vigorously flourishing are evidently exceedingly active, as may be deduced from their large size, brilliant nuclei, protoplasm, and sap-vacuole, all of which show signs of intense metabolic activity, lasting for considerable periods. The fact that the sap expressed from these active tissues is alkaline, has been interpreted as in accordance with Lœw's suggestion that the living protoplasm, in presence of an alkali and free nitrogen, can build up ammonium nitrite, or some similar body. Be this as it may, there can be no question as regards the infected nodule-cells being centres where intense physiological activity is going on; and it seems impossible to avoid the conclusion that the vascular supplies from the roots into the nodules bring to these cells water in which various salts, carbo-hydrates, &c. are dissolved, and carry off from them the soluble products of metabolism.

Presumably these products of metabolism include nitrogenous bodies.

In the ordinary course of events, theory teaches that these nitrogenous bodies—*e.g.* amides, preceded by simpler compounds—are built up by the machinery of the ordinary living cell-protoplasm from carbo-hydrates and nitrates, the energy necessary for the metabolism being derived chiefly (if not entirely) by the oxidation of part of the carbo-hydrates supplied.

This constructive metabolic work of the protoplasm is an act which we cannot explain in detail. We can only dimly perceive that it must be due to some remarkable power the protoplasm possesses—and in virtue of which it is an illimitable machine much more economical in its actions than any apparatus we can construct—of so placing the atoms and molecules of the nitrate, carbo-hydrate, water, &c. with which it works, that they are enabled to undergo movements into which we cannot as yet force them in the laboratory.

The whole matter seems to depend on some peculiar mode of presentment of the atoms and molecules concerned; and we can see no further than that this can be done in the living cell, because the protoplasm is a suitable engine for thus bringing the combining elements into the necessary positions in space.

Now, if this is so, there seems no exclusion of the possibility, at any rate, that the cell-machinery may be so stimulated into greater activity that it can even force the notoriously inert nitrogen molecules, properly presented, into combinations with other molecules, resulting in the production of nitrites, amides, or similar bodies in ascending order.

The whole matter no doubt resolves itself into some such question of a properly adapted engine sufficiently supplied with energy. The matter seems capable of explanation, in some degree, if we remember that carbo-hydrates and oxygen are present in abundance; the real difficulty is with the machinery, for we cannot as yet picture the exact construction or working of such an engine, as physiology nevertheless impels us to suppose the cell-protoplasm must be.

It may be remarked, by the way, that the likeness of the living protoplasm to an engine, in the sense implied, may hold good whether the former is an "emulsion," in the sense of the defenders of that hypothesis, or a "structure," in the sense of those who refuse the emulsion hypothesis.

The fourth of the possible views as to the means by which free nitrogen becomes available to the leguminous plant, however, reminds us that, although the evidence points to the stimulated leguminous plant as the best established example of one capable of doing this work, there are other possibilities.

Berthelot's recent insistence that certain soil-bacteria can fix free nitrogen, taken with Frank's, Laurent and Schloësing's, and

Koch and Kossowitsch's experiments, make it impossible to deny that the above hypothesis as to the powers of the protoplasmic machinery may apply to the cells of some lower organisms, without symbiosis coming into play at all. The remarkable facts brought to light regarding sulphur-bacteria and iron-bacteria by Winogradsky, and the still more unexpected results this observer obtained with nitrifying organisms, show that the machinery of the cell can avail itself of sources of energy undreamt of by earlier observers. If, by the oxidation of sulphur or sulphuretted hydrogen, or of lower iron-compounds, or of ammonia, certain of these organisms can obtain the energy necessary to set going machinery capable of so presenting other molecules of the elements they take up to one another that organic compounds result, it is by no means inconceivable that, at the cost of carbon-compounds which they oxidise powerfully, the necessary energy can be obtained to force even free nitrogen into combinations.

It is equally conceivable that in the case of the leguminosæ, the symbiotic organism is really more of a parasite (it is necessarily a parasite in some degree) than is assumed in the third view, and that, at the expense of the carbo-hydrates so richly furnished to it by the host plant, the fungoid organism alone supplies the machinery for forcing the nitrogen into combination, and that when it has stored up relatively large quantities, owing to its activity in the incubators—the root-nodules—provided for it by its host-plant, and is diminishing in resisting power, the latter at length turns round and absorbs the stores.

The chief objection to this view is that the gains in total nitrogen seem to be greater than would be thus explained, unless the organisms in the soil outside the roots are also fixing free nitrogen.

Such then, put too shortly as regards the numerous experimental facts, are some of the chief ideas agitating the scientific world on this question, a question which, be it emphatically stated, promises to be of more importance to agriculture in the future than any legislation as to prices, &c. that we can conceive; for if it turns out that the acquisition of free nitrogen by the land, or, what amounts to the same thing, the plants growing on it, can be economically promoted, the farmer and forester may have the control of sources of real wealth not yet dreamt of. Unquestionably there is an enormous amount of careful and very difficult experimental work to be done before we arrive at the solution of the various vital questions raised; but the astounding results obtained during the last decade by a few earnest workers promise brilliant results in the future.

H. MARSHALL WARD.

### THE HAR DALAM CAVERN AND ITS OSSIFEROUS CONTENTS.

IT is now about half a century since Admiral Spratt first recorded the discovery of the Maltese ossiferous cavern deposits in which, at a later period, Prof. Leith Adams found so remarkable an assemblage of mammalian and other remains.

The fauna which was then brought to light was of a most unique and interesting character, consisting of three species of elephants, one of which *E. falconeri* was, when full grown, no larger than an average size Newfoundland dog; two species of hippopotamus, one *H. minutus*, about the size of a small donkey, several species of gigantic swans, large dormice, land tortoises, cranes, vultures, &c.

These remarkable discoveries in an area so circumscribed attracted much attention in the scientific world, and considerable interest was evinced in them; and this the more so as that Dr. Falconer was at that time engaged in determining certain organic remains which had been found in similar deposits, and under similar conditions, in Sicily. The result of the explorations in the two islands was to demonstrate that Malta had, at no very remote period, been directly in connection with the continental areas on the European side, and indirectly with those of Africa. Brilliant, however, as were the discoveries made by Spratt and Adams, many difficulties of vital interest to the archæologist, the geologist, and the physical geographer were left unsolved when Adams departed from these islands in 1872. Dr. Caruana, a Maltese archæologist, then carried on the work for a short time, but finally abandoned it; and from that time to the arrival of Dr. John Murray, in 1889, nothing further was done. In that

and the following year, Dr. Murray undertook a thorough investigation into the marine strata of the islands, and recognising the value of the work that still remained to be done in the Pleistocene beds, he urged the desirability of a careful examination of them being made. Several interesting discoveries of Pleistocene deposits had already been made by Mr. John H. Cooke, in the island of Gozo; and accordingly, at the suggestion of Dr. John Murray, and with the assistance of the Royal Society, Mr. Cooke undertook to carry on the work.

In the spring of 1892 the excavation of a large cavern situate in the Har Dalam Gorge was commenced, the results of which have materially assisted in clearing up many of the more debatable problems which had been left unsolved by previous workers. These results have been embodied, by Mr. Cooke, in a memoir which was communicated to the Royal Society.

The gorge in question is one of many gorges of erosion, which are to be found in the low-lying and denuded areas of Malta and Gozo. It is situated in the eastern part of Malta, and debouches on the broad, extensive bay of Marsa Scirocco. It forms the drainage channel of a catchment basin of considerable area, but owing to the very small annual rainfall of the islands the stream that now courses through it for a few occasional hours in the winter season is insignificant in size, and impotent as an eroding agent.

But it was not always so. The rounded boulders, the water-worn debris, and the curvilinear undercuttings with which the sides of the gorge are scored, as well as the character of the caves in the vicinity and of their deposits, all attest to the former action of torrential volumes of water such as could only have been formed during the existence of climatic conditions of a much more severe and humid nature than those that now endure. The cavern, which has been named after the gorge in which it occurs, is situated 500 yards from the shore on the northern side of the gorge, and consists of a main gallery, 400 feet in length, when it ramifies in various directions, forming smaller tunnels and chambers, which follow the jointings and bedding planes of the rock. One branch fissure is 250 feet in length, 15 feet high, and just wide enough for a man to pass along it, widening out at intervals into dome-shaped rock chambers.

Two of the other galleries are of considerable height, but do not exceed 20 feet in length; and they were filled with debris to within 1 ft. 6 in. to 2 ft. of the roof with a reddish plastic clay, kept moist by percolation from the roof, the sides of all the galleries being encrusted with a stalactitic lining.

The mouth of the main gallery is 26 feet wide and 10 feet high, and has been used during late years as a cattle shelter, the entrance being walled up and provided with a doorway. It widens inwards into a spacious chamber, 60 feet wide and 17 feet high, having a branch on the right hand, which was filled to the roof with alluvial soil and boulders.

The roof of the cavern was formerly covered with stalactites, but most of them have been broken off by the action of the torrents that invaded the cave, and they were afterwards buried in the floor deposits.

These stalactites and their corresponding stalagmitic bosses were observed at three different levels, each being covered by fresh alluvial deposits, indicating the intermittent character of the floods that invaded the cavern and the long periods that elapsed between them.

The deposits met with vary considerably in different parts of the cave. At the furthest extremity they are mainly composed of red loam; in the middle of large boulders, broken stalactites, and old pottery enclosed in clay; towards the entrance of a grey indurated marl with abundant remains of land shells, roots of plants, bones of deer, and boulders.

The cave is everywhere strewn with enormous quantities of water-worn boulders, similar to those met with so abundantly in the valleys and gorges of the islands.

From the differential characters exhibited by the earlier and later layers, it was evident that the deposits belonged to two distinct epochs, each of which was characterised by a special fauna.

In the lower series were found the remains of *Ursus (arctos?)*, *Elephas mnadrænsis*, *Hippopotami pentlandii*, *Canis* (equalling a wolf in size), *Cervus elaphus*, var. *barbarus*, and *Human remains*; while the upper series was found to abound in the remains of man and domestic animals—pig, goat, sheep, *bos*, small land chelonian, and *Cervus elaphus*, var. *barbarus*.

The discovery of the carnivore was specially significant. As early as 1859 Spratt had observed that many of the bones that

he had exhumed bore traces of having been gnawed; and later on Adams made similar observations.

Notwithstanding, however, the most diligent research extending over a period of twenty years, no further evidences of the presence of carnivora were forthcoming. These were the first remains met with.

Equally interesting was the discovery which was made in Trench v. Among the remains which were exhumed Mr. Arthur Smith Woodward has determined the third metacarpal of man. It was found at a depth of 3 ft. 6 in. from the surface, and underlying a layer containing pottery. It is probably of great antiquity, having been extracted from one of the earliest layers in the cavern.

That these deposits are of great antiquity there can be no doubt. The state of mineralisation in which the bones were found was most complete; and when, in addition to this, the height of forty feet above the gorge bed at which the cavern is at present situated be considered, in conjunction with the extremely slow and gradual character of the processes of erosion which were engaged in cutting down the bed of the gorge to its present level—when these, and the other equally important points regarding the great changes in climate that have taken place between this and then be duly weighed, the author thinks that he would be justified in referring the Har Dalam deposits to a considerably remote epoch.

Such then in brief are a few of the evidences bearing on the prehistoric history of the Maltese Islands which these excavations have supplied us with—evidences which have added one more arch to the bridge with which the geologist and the archæologist in the Maltese Islands are endeavouring to span the gulf which at present divides their labours.

#### GEOGRAPHY IN CAUCASUS.

A RECENT volume of the Memoirs (Zapiski) of the Caucasian Branch of the Russian Geographical Society (vol. xv.) is of more than usual interest. It opens with a paper, by Mr. Konshin, on the old beds of the Amu-daria, accompanied by a map which shows the consecutive decrease of the area of the Caspian sea since the beginning of the Post-Pliocene epoch. It is known that the Russian geologist was first to point out that what had been previously described as old beds of the Amu are not beds at all, but elongated channels occupied once by the salt waters of the Caspian. The writers of antiquity were not wrong in representing the Caspian sea as a basin, elongated from west to east, and in ignoring the existence of Lake Aral as a lake separated from the Caspian. At the beginning of the Post-Pliocene epoch, and perhaps later on as well, the Caspian sent eastward two wide gulfs, one of which reached the longitude of Merv, and covered what is now a depression in the south of the Kara-kum elevated plain; while another gulf, stretching north-eastwards, included Lake Aral and what is now the delta of the Amu, as far as Khiva and Pitnyak. Thus, it was not the Amu which reached the Caspian, but the sea which reached the river by extending much further eastward than it does now. The Chink, which has so often been described as an old bed of the Amu, was the northern coast of the Kara-kum gulf; while the river-like beds of the Sary-kamysh depression were narrow channels through which the waters of Lake Aral occasionally found their way into the Caspian, long time after the two great lakes had been separated from each other. Mr. Konshin's little map very well illustrates the subsequent changes of the form of the Caspian. It may only be added that an exploration of the Ust-urt, and especially of the chain of lakes which crosses it from west to east—connecting, so to say, the Caspian with Lake Aral—is extremely desirable; it seems very probable that another channel of communication between the two great lakes will be discovered in that direction as well. A. V. Pastukhoff's communication about his ascension on the Elbrus and the Khalatsa peak, in July, 1890, is also full of interest, and is accompanied by excellent photographs and a map. On the top of this latter peak, which reaches 11,915 feet, the party was overtaken by a snowstorm, during which they were surrounded by a most beautiful display of electric fires; all their fur coats, their hair, their moustaches, as well as the poles of their tents and all metallic things, were enveloped in luminous discharges, which came to an end only after a discharge of thunder. The thunderstorm was terrible, especially one discharge of globular thunder, which rendered all the party senseless for a time.

Dr. Dinnik's descriptions of his journey in Western Ossetia, as well as in Pshavia and Khevsuria, are full of valuable observations, especially as regards glaciers and traces of an extensive previous glaciation of the main chain. And Mr. Filipoff's remarks relative to the present changes of level in the Caspian, show that the level of the sea is continually oscillating in its different parts, and never remains quite horizontal; it depends very much upon the different winds.

Mr. N. Alboff's reports of his botanical explorations in Abhasia and Lazistan are most valuable, the more so as his conclusions relative to the flora of West Caucasus, very different from those arrived at by MM. Krasnoff and Kuznetsoff, are based on most elaborate studies and extensive collections.

Another important paper is contributed to the same volume by K. N. Rossikoff, on the desiccation of lakes on the northern slope of Caucasus. These lakes belong to three different categories. Those on the coasts of both the Caspian sea and the sea of Azov have originated from old lagunæ, or in the deltas of the rivers. They attain but a small depth ( $3\frac{1}{2}$  fathoms is the maximum depth observed), and many of them are brackish. The lakes of the Steppe-region occupy distinct depressions of the surface, and are fed by little temporary streams and underground water. And, finally, there is a small number of lakes at the footings of the Main Ridge and in the mountain region itself. Now, all the lakes relative to which there are reliable observations made during the years 1881 to 1891, are decidedly in a period of desiccation. Most of the lakes of the Steppe-region have either entirely disappeared, or are living the last years of their existence; they will exist no more in a few years. The lakes scattered at the foot of the mountains are also in decrease; their levels have sunk during the last eight years of the above period by an average of ninety inches. As to the lakes of the mountain region, their desiccation seems chiefly to depend upon the destruction of forests. These facts entirely confirm the widely-spread belief that the climate of Caucasus is becoming more and more dry during the last forty or fifty years.

The volume is concluded with an extensive paper by Dr. Pantyukhoff, full of most valuable anthropological measurements of representatives of the various nationalities and tribes of Caucasus, and accompanied by many engravings.

#### ISOPERIMETRICAL PROBLEMS.<sup>1</sup>

- Dido, *b.c.* 500 or 600.  
 Horatius Cocles, *b.c.* 503.  
 Pappus, *B. 606 v. A. D.* 390.  
 John Bernoulli, *A. D.* 1700.  
 Euler, *A. D.* 1744.  
 Maupertuis (Least Action), *b. 1668, d. 1759.*  
 Lagrange (Calculus of Variations), 1759.  
 Hamilton (Actional Equations of Dynamics), 1834.  
 Liouville, 1840 to 1860.

THE first isoperimetric problem known in history was practically solved by Dido, a clever Phœnician princess, who left her Tyrian home and emigrated to North Africa, with all her property and a large retinue, because her brother Pygmalion murdered her rich uncle and husband Acerbas, and plotted to defraud her of the money which he left. On landing in a bay about the middle of the north coast of Africa she obtained a grant from Hiarbas, the native chief of the district, of as much land as she could enclose with an ox-hide. She cut the ox-hide into an exceedingly long strip, and succeeded in enclosing between it and the sea a very valuable territory<sup>2</sup> on which she built Carthage.

The next isoperimetric problem on record was three or four hundred years later, when Horatius Cocles, after saving his country by defending the bridge until it was destroyed by the Romans behind him, saved his own life and got back into Rome by swimming the Tiber under the broken bridge, and was rewarded by his grateful countrymen with a grant of as much land as he could plough round in a day.

In Dido's problem the greatest value of land was to be enclosed by a line of given length. If the land is all of equal value the general solution of the problem shows that her line of ox-hide should be laid down in a circle. It shows also that if the sea is to be part of the boundary, starting, let us say, south-

<sup>1</sup> A lecture delivered at the Royal Institution, May 12, 1877, by Lord Kelvin, Pres. R.S.

<sup>2</sup> Called *Byrsa*, from *βύρρα*, the hide of a bull. (Smith's "Dictionary of Greek and Roman Biography and Mythology," article "Dido.")

ward from any given point A of the coast, the inland bounding line must at its far end cut the coast line perpendicularly. Here, then, to complete our solution, we have a very curious and interesting, but not at all easy, geometrical question to answer:—What must be the radius of a circular arc A D C, of given length, and in what direction must it leave the point A, in order that it may cut a given curve A B C perpendicularly at some unknown point C? I do not believe Dido could have passed an examination on the subject, but no doubt she gave a very good practical solution, and better than she would have found if she had

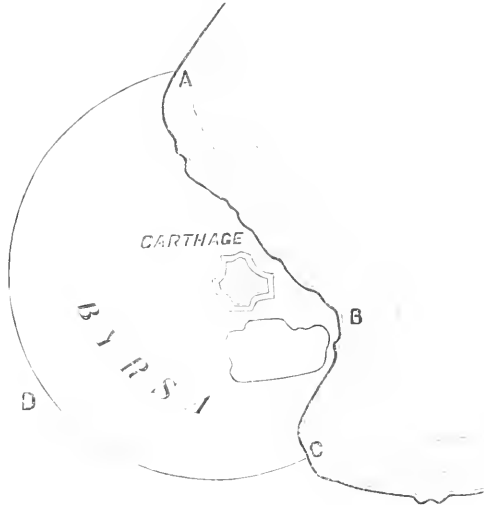

just mathematics enough to make her fancy the boundary ought to be a circle. No doubt she gave it different curvature in different parts to bring in as much as possible of the more valuable parts of the land offered to her, even though difference of curvature in different parts would cause the total area enclosed to be less than it would be with a circular boundary of the same length.

The Roman reward to Horatius Cocles brings in quite a new idea, now well known in the general subject of isoperimetrics: the greater or less speed attainable according to the nature of the country through which the line travelled over passes. If it had been equally easy to plough the furrow in all parts of the area offered for enclosure, and if the value of the land per acre was equal throughout, Cocles would certainly have ploughed as nearly in a circle as he could, and would only have deviated from a single circular path if he found that he had misjudged its proper curvature. Thus, he might find that he had begun on too large a circle, and, in order to get back to the starting-point and complete the enclosure before nightfall, he must deviate from it on the concave side; or he would deviate from it on the other side if he found that he had begun on too small a circle, and that he had still time to spare for a wider sweep. But, in reality, he must also have considered the character of the ground he had to plough through, which cannot but have been very unequal in different parts, and he would naturally vary the curvature of his path to avoid places where his ploughing must be very slow, and to choose those where it would be most rapid.

He must also have had, as Dido had, to consider the different value of the land in different parts, and thus he had a very complex problem to practically solve. He had to be guided both by the value of the land to be enclosed and the speed at which he could plough according to the path chosen; and he had a very brain-trying task to judge what line he must follow to get the largest value of land enclosed before night.

These two very ancient stories, whether severe critics will call them mythical or allow them to be historic, are nevertheless full of scientific interest. Each of them expresses a perfectly definite case of the great isoperimetric problem: to which the whole of dynamics is reduced by the modern mathematical methods of Euler, Lagrange, Hamilton and Liouville (Liouville's Journal, 1840-1850). In Dido's and Horatius Cocles' problems, we find perfect illustrations of all the fundamental principles and details of the generalised treatment of dynamics which we have learned from these great mathematicians of the eighteenth and nineteenth centuries.

Nine hundred years after the time of Horatius Cocles we find, in the fifth Book of the collected Mathematical and Physical Papers of Pappus of Alexandria, still another idea belonging to isoperimetrics—the economy of valuable material used for building a wall; which, however, is virtually the same as the time per yard of furrow in Cocles' ploughing. In this new case the economist is not a clever princess, nor a patriot soldier, but a humble bee who is praised in the introduction to the book not only for his admirable obedience to the Authorities of his Republic, for the neat and tidy manner in which he collects honey, and for his prudent thoughtfulness in arranging for its storage and preservation for future use, but also for his knowledge of the geometrical truth that a "hexagon can enclose more honey than a square or a triangle with equal quantities of building material in the walls," and for his choosing on this account the hexagonal form for his cells. Pappus, concluding his introduction with the remark that bees only know as much of geometry as is practically useful to them, proceeds to apply what he calls his own superior human intelligence to investigation of useless knowledge, and gives results in his Book V. which consists of fifty-five theorems and fifty-seven propositions on the areas of various plane figures having equal circumferences. In this Book, written originally in Greek, we find (Theorem IX. Proposition X.) the expression "isoperimetric figures," which is, so far as I know, the first use of the adjective "isoperimetric" in geometry; and we may, I believe, justly regard Pappus as the originator, for mathematics, of *isoperimetric problems*, the designation technically given in the nineteenth century<sup>1</sup> to that large province of mathematical and engineering science in which different figures having equal circumferences, or different paths between two given points, or between some two points on two given curves, or on one given curve, are compared in connection with definite questions of greatest efficiency and smallest cost.

In the modern engineering of railways, an isoperimetric problem of continual recurrence is the laying out of a line between two towns along which a railway may be made at the smallest prime cost. If this were to be done irrespectively of all other considerations, the requisite datum for its solution would be simply the cost per yard of making the railway in any part of the country between the two towns. Practically the solution would be found in the engineers' drawing-office by laying down two or three trial lines to begin with, and calculating the cost of each, and choosing the one of which the cost is least. In practice various other considerations than very slight differences in the cost of construction will decide the ultimate choice of the exact line to be taken; but if the problem were put before a capable engineer to find very exactly the line of minimum total cost, with an absolutely definite statement of the cost per yard in every part of the country, he or his draughtsmen would know perfectly how to find the solution. Having found something near the true line by a few rough trials they would try small deviations from the rough approximation, and calculate differences of cost for different lines differing very little from one another. From their drawings and calculations they would judge by eye which way they must deviate from the best line already found to find one still better. At last they would find two lines for which their calculation shows no difference of cost. Either of these might be chosen; or, according to judgment, a line midway between them, or somewhere between them, or even not between them but near to one of them, might be chosen, as the best approximation to the exact solution of the mathematical problem which they care to take the labour of trying for. But it is clear that if the price per yard of the line were accurately given (however determined or assumed) there would be an absolutely definite solution of the problem, and we can easily understand that the skill available in a good engineer's drawing-office would suffice to find the solution with any degree of accuracy that might be prescribed; the minuter the accuracy to be attained the greater the labour, of course. You must not imagine that I suggest, as a thing of practical engineering, the attainment of minute accuracy in the solution of a problem thus arbitrarily proposed; but it is interesting to know that there is no limit to the accuracy to which this ideal problem may be worked out by the methods which are actually used every day by engineers in their calculations and drawings.

The modern method of the "calculus of variations," brought into the perfect and beautiful analytical form in which we now have it by Lagrange, gives for this particular problem a theorem

<sup>1</sup> Example, Woodhouse's "Isoperimetric Problems," Cambridge, 1810.



which would be very valuable to the draughtsman if he were required to produce an exceedingly accurate drawing of the required curve. The curvature of the curve at any point is convex towards the side on which the price per unit length of line is less, and is numerically equal to the rate per mile perpendicular to the line at which the Neperian logarithm of the price per unit length of the line varies. This statement would give the radius of curvature in fraction of a mile. If we wish to have it in yards we must take the rate per yard at which the Neperian logarithm of the price per unit length of the line varies. I commend the Neperian logarithm of price in pounds, shillings and pence to our Honorary Secretary, to whom no doubt it will present a perfectly clear idea; but less powerful men would prefer to reckon the price in pence, or in pounds and decimals of a pound. In every possible case of its subject the "calculus of variations" gives a theorem of curvature less simple in all other cases than in that very simple case of the railway line of minimum first cost, but always interpretable and intelligible according to the same principles.

Thus in Dido's problem we find by the calculus of variations that the curvature of the enclosing line varies in simple proportion to the value of the land at the places through which it passes; and the curvature at any one place is determined by the condition that the whole length of the ox-hide just completes the enclosure.

The problem of Horatius Cocles combines the railway problem with that of Dido. In it the curvature of the boundary is the sum of two parts; one, as in the railway, equal to the rate of variation perpendicular to the line, of the Neperian logarithm of the cost in time per yard of the furrow (instead of cost in money per yard of the railway); the other varying proportionally to the value of the land as in Dido's problem, but now divided by the cost per yard of the line, which is constant in Dido's case. The first of these parts, added to the ratio of the money-value per square yard of the land to the money-cost per lineal yard of the boundary (a wall suppose), is the curvature of the boundary when the problem is simply to make the most you can of a grant of as much land as you please to take provided you build a proper and sufficient stone wall round it at your own expense. This problem, unless wall-building is so costly that no part of the offered land will pay for the wall round it, has clearly a determinate finite solution if the offered land is an oasis surrounded by valueless desert. It has also a determinate finite solution even though the land be nowhere valueless, if the wall is sufficiently more and more expensive at greater and greater distances from some place where there are quarries, or habitations for the builders.

The simplified case of this problem, in which all equal areas of the land are equally valuable, is identical with the old well-known Cambridge dynamical plane problem of finding the motion of a particle relatively to a line of reference revolving uniformly in a plane: to which belongs that considerable part of the "Lunar Theory" in which any possible motion of the moon is calculated on the supposition that the centre of gravity of the earth and moon moves uniformly in a circle round the sun, and that the motions of the earth and moon are exactly in this plane. The rule for curvature which I have given you expresses in words the essence of the calculation, and suggests a graphic method for finding solutions by which not uninteresting approximations<sup>1</sup> to the cusped and looped orbits of G. F. Hill<sup>2</sup> and Poincaré<sup>3</sup> can be obtained without disproportionately great labour.

In the dynamical problem, the angular velocity of the revolving line of reference is numerically equal to half the value of the land per square yard; and the relative velocity of the moving particle is numerically equal to the cost of the wall per lineal yard in the land question.

But now as to the proper theorem of curvature for each case; both Dido and Horatius Cocles no doubt felt it instinctively and were guided by it, though they could not put it into words, still less prove it by the "calculus of variations." It was useless knowledge to the bees, and, therefore, they did not know it; because they had only to do with straight lines. But as you are not bees I advise you all, even though you have no interest in acquiring as much property as you can enclose by a wall of

given length, to try Dido's problem for yourselves, simplifying it, however, by doing away with the rugged coast line for part of your boundary, and completing the enclosure by the wall itself. Take forty inches of thin soft black thread with its ends knotted together and let it represent the wall; lay it down on a large sheet of white paper and try to enclose the greatest area with it you can. You will feel that you must stretch it in a circle to do this, and then, perhaps, you will like to read Pappus (Liber V. Theorema II. Propositio II.) to find mathematical demonstration that you have judged rightly for the case of all equal areas of the enclosed land equally valuable. Next try a case in which the land is of different value in different parts. Take a square foot of white paper and divide it into 144 square inches to represent square miles, your forty inches of endless thread representing a forty miles wall to enclose the area you are to acquire. Write on each square the value of that particular square mile of land, and place your endless thread upon the paper, stretched round a large number of smooth pins stuck through the paper into a drawing-board below it, so as to enclose as much value as you can, judging first roughly by eye and then correcting according to the sum of the values of complete squares and proportional values of parts of squares enclosed by it. In a very short time you will find with practical accuracy the proper shape of the wall to enclose the greatest value of the land that can be enclosed by forty miles of wall. When you have done this you will understand exactly the subject of the calculus of variations, and those of you who are mathematical students may be inclined to read Lagrange, Woodhouse, and other modern writers on the subject. The problem of Horatius Cocles, when not only the different values of the land in different places but also the different speed of the plough according to the nature of the ground through which the furrow is cut are taken into consideration, though more complex and difficult, is still quite practicable by the ordinary graphic method of trial and error. The analytical method of the calculus of variations, of which I have told you the result, gives simply the proper curvature for the furrow in any particular direction through any particular place. It gives this and it cannot give anything but this, for any plane isoperimetric problem whatever, or for any isoperimetric problem on a given curved surface of any kind.

Beautiful, simple, and clear as isoperimetrics is in geometry, its greatest interest, to my mind, is in its dynamical applications. The great theorem of least action, somewhat mystically and vaguely propounded by Maupertuis, was magnificently developed by Lagrange and Hamilton, and by them demonstrated to be not only true throughout the whole material world, but also a sufficient foundation for the whole of dynamical science.

It would require nearly another hour if I were to explain to you fully this grand generalisation for any number of bodies moving freely, such as the planets and satellites of the solar system, or any number of bodies connected [by cords, links, or mutual pressures between hard surfaces, as in a spinning-wheel, or lathe and treadle, or a steam engine, or a crane, or a machine of any kind; but even if it were convenient to you to remain here an hour longer, I fear that two hours of pure mathematics and dynamics might be too fatiguing. I must, therefore, perforce limit myself to the two-dimensional, but otherwise wholly comprehensive, problems of Dido and Horatius Cocles. Going back to the simpler included case of the railway of minimum cost between two towns, the dynamical analogue is this:—For price per unit length of the line substitute the velocity of a point moving in a plane under the influence of a given conservative system of forces, that is to say, such a system that when material particles not mutually influencing one another are projected from one and the same point in different directions, but with equal velocities, the subsequent velocity of each is calculable from its position at any instant, and all have equal velocities in travelling through the same place whatever may be their directions. The theorem of curvature, of which I told you in connection with the railway engineering problem, is now simply the well-known elementary law of relation between curvature and centrifugal force of the motion of a particle.

The motion of a particle in a plane is, as Liouville has proved, a case to which every possible problem of dynamics involving just two freedoms to move can be reduced. But to bring you to see clearly its relation to isoperimetrics, I must tell you of another admirable theorem of Liouville's, reducing to a still simpler case the most general dynamics of two-freedom motion. Though not all mathematical experts, I am sure you can all per-

<sup>1</sup> Kelvin, "On Graphic Solution of Dynamical Problems." *Phil. Mag.* 1892 (2nd half-year).

<sup>2</sup> Hill, "Researches in the Lunar Theory," Part 3, "National Academy of Sciences," 1887.

<sup>3</sup> "Méthodes Nouvelles de la Mécanique Céleste," p. 104 (1872).

fectly understand the simplicity of the problem of drawing the shortest line on any given convex surface, such as the surface of this block of wood (shaped to illustrate Newton's dynamical theory of the elliptic motion of a planet round the sun) which you see on the table before you. I solve the problem practically by stretching a thin cord between the two points, and pressing it a little this way or that way with my fingers till I see and feel that it lies along the shortest distance between them. And now, when I tell you that Liouville has reduced to this splendidly simple problem of drawing a shortest line (geodetic line it is called) on any given curved surface every conceivable problem of dynamics involving only two freedoms to move, I am sure you will understand sufficiently to admire the great beauty of this theorem.

The doctrine of isoperimetrical problems in its relation to dynamics is very valuable in helping to theoretical investigation of an exceedingly important subject for astronomy and physics—the stability of motion, regarding which, however, I can only this evening venture to show you some experimental illustrations.

The lecture was concluded with experiments illustrating—

(1) Rigid bodies (teetotums, boys' tops, ovals, oblates, &c.) placed on a horizontal plane, and caused to spin round on a vertical axis, and found to be thus rendered stable or unstable according as the equilibrium without spinning is unstable or stable.

(2) The stability or instability of a simple pendulum whose point of support is caused to vibrate up and down in a vertical line, investigated mathematically by Lord Rayleigh.

(3) The crispations of a liquid supported on a vibrating plate, investigated experimentally by Faraday; and the instability of a liquid in a glass jar, vibrating up and down in a vertical line, demonstrated mathematically by Lord Rayleigh.

(4) The instability of water in a prolate hollow vessel, and its stability in an oblate hollow vessel, each caused to rotate rapidly round its axis of figure,<sup>1</sup> which were announced to Section A of the British Association at its Glasgow meeting in 1876 as results of an investigation not then published, and which has not been published up to the present time.

## GEOLOGICAL SURVEY OF THE UNITED KINGDOM.<sup>2</sup>

### II.

#### SCOTLAND.

*Lewisian Gneiss.*—The most ancient rocks in the British Islands, forming what is known as the Lewisian Gneiss, have now been mapped continuously throughout the whole of their extent on the mainland, from Cape Wrath to the Kyles of Skye. They have been found to occur there in two distinct conditions. Along the western borders of Sutherland and Ross they form an irregular platform on which all later formations rest. The detailed work of the survey has brought to light the fact that this platform had an exceedingly uneven surface before the very oldest of the sedimentary formations were laid down upon it. Mountains of gneiss from 2000 to 3000 feet high, with wide and deep intervening valleys, already existed before the period of the Torridon Sandstone, and were submerged beneath the waters in which that Sandstone was accumulated. But to the east of this primeval topography, owing to the gigantic dislocations which have now been traced for upwards of 100 miles from the northern shores of Sutherland into Skye, large slices of the deeply buried gneiss have been torn off and have been driven westward upon fractured and crushed rocks of much later date. There are thus areas of gneiss which have been moved and have undergone much consequent internal rearrangement, while to the west of these the old platform, still in great part covered with the younger formations, has been left unaffected and reveals the condition of the oldest rocks at the time when the earliest of these over-lying formations was deposited upon them.

The mapping of this region has shown the Lewisian Gneiss to

consist of what were probably masses of various deep-seated igneous rocks, which, partly by segregation and intrusion, and partly by subsequent intense mechanical deformation, have in large measure acquired a gneissic structure. An order of sequence has been made out among the more marked types of erupted material, and it has been further ascertained that the structures superinduced by crushing have taken place at successive periods of great disturbance.

Some of the most important observations in the area of the ancient gneiss are those made in the Loch Maree district. Mr. Clough has found there a group of rocks quite unlike the usual types of the Lewisian series. They consist chiefly of fine mica-schist, quartz-schist, graphite-schist, and limestone, and may be altered sedimentary rocks. If such should prove to be their origin they will possess a special interest as being by far the most ancient vestiges of detrital deposits yet detected in this country. The relation of these rocks to the normal types of gneiss around them have not been very satisfactorily determined.

In the course of the examination of the old gneiss where it lies undisturbed below the unmoved Torridon Sandstone, the officers of the Survey have ascertained that it had undergone successive disruptions and much mechanical deformation before the deposition of that Sandstone, that in short it had already acquired all its present structure and had been irregularly and deeply laid bare by denudation. We are still unable to say how far the earliest foliated arrangement of the gneiss may be due to movements such as those of flow-structure within a plutonic magma, in which the component minerals have segregated out. But there can be no doubt that after any such early structure had been established other structures were superinduced upon the gneiss by subterranean movements. Evidence of these disruptions and of their effects has now been accumulated over the whole area of the mainland.

*Torridonian.*—The striking mass of chocolate-coloured sandstones, which enters so prominently into the scenery of the west of Sutherland and Ross-shire, has now been mapped throughout its extent on the mainland, with the exception of a small area in the west of the latter county which remains to be completed. Like the far more ancient gneiss on which these strata rest with so marked an unconformability, they are met with in two distinct conditions. To the westward, where they have escaped from the great dislocations already referred to, they lie in almost their original undisturbed positions, inasmuch that one can hardly at first realise that their relative antiquity can be so great as it demonstrably is. They resemble portions of the Old Red Sandstone with which at first they were identified, and this resemblance extends even into the practical uses that may be made of them. Along many parts of the West of Sutherland and Ross-shire the thick bedded chocolate-coloured freestones would furnish an excellent building stone in practically unlimited quantities.

An important group of shales has been found to occupy a prominent place towards the base of the Torridon Sandstone in Western Ross-shire. This group has now been followed to the sea-coast, and has been found by Mr. Clough to attain a still larger development in the southern part of the island of Skye. They there contain thin bands of impure limestone, and one of their members of much interest, forming only a thin bed, consists largely of grains of magnetite and zircon. A diligent search for fossils has recently been made by Mr. A. Macconochie in this lower shaly group of the Torridon Sandstone, but hitherto with scarcely any success, certain doubtful track-like markings being the only indications of possible organic remains which have been met with.

In mapping the Applecross district, where the Torridon Sandstone rises into an imposing group of mountains, Mr. Horne has encountered some singular volcanic orifices on a sandstone plateau about 1000 feet above the sea. Two small "necks" which rise there through the Torridon rocks, are filled with blocks of the sandstone mingled with occasional bombs of basalt, the whole being set in a dark green and grey paste of similar materials. The fragments of sandstone have been subjected to considerable alteration, for they have a glazed aspect, while their quartz-grains have acquired a milky opalescent or blue tint. There is no indication of the ages of these two volcanic vents, but they may with some probability be assigned to the widespread Tertiary series which has left such prominent memorials in the opposite island of Skye.

During the past year in the district between Loch Kishorn

<sup>1</sup> *Nature*, 1891, vol. xv, p. 297, "On the Precessional Motion of a Liquid."

<sup>2</sup> Annual Report of the Geological Survey for the year ending December 31, 1892. By Sir Archibald Geikie, F.R.S., Director General. It in the Report of the Science and Art Department for 1892. (Some of those portions of the Report which describe the scientific results of the Survey operations during the last few years are reprinted here.) (Continued from page 497.)

and the head of Loch Carron some tracts of Torridon Sandstone have been mapped, where the effects of the great displacements upon the internal structure of the sandstone are well displayed. In that region, by the effect of these stupendous movements, a wide area of Torridon Sandstone and old gneiss has been inverted and pushed bodily westwards so as now to lie upon the Cambrian formations. This inversion is seen on a great scale in the district of Loch Carron, where the Torridon Sandstone, pushed over the quartzites and limestones, dips eastward for several miles until its base passes under the overturned Lewisian gneiss. The actual inverted unconformable junction of the gneiss and sandstone can still be traced in various places, though elsewhere it has been effaced by intense deformation. And not only may the inverted unconformability be recognised, but it can be shown that an overlap of the older parts of the Torridon Sandstone takes place against the uneven surface of the overlying gneiss. Messrs. Peach and Horne, who have mapped this remarkable structure, find that the sandstones have been crushed and have become partially schistose, with a development of mica and other minerals along the planes of movement; also that pegmatitic veins of quartz and felspar have been formed by segregation in rents of the strata.

The same intense subterranean movements have profoundly affected the structure of the overlying masses of old gneiss. As these rocks are followed eastwards for several miles they appear more and more sheared, until at last they are succeeded by siliceous granulitic flagstones, such as have been named by the surveyors "Moine-schists." On the south side of Loch Carron, Mr. Peach has recently obtained evidence which, if confirmed by further research, will have an important bearing on the interpretation of these schists, which have hitherto presented a very difficult problem. He finds that from the nature of the schists and their mode of occurrence in that locality, they appear to be altered Torridon Sandstone, which has been caught and enclosed within a great synclinal fold by the mass of old gneiss as it was driven westward. They consist of material similar to that of the undoubted Torridon Sandstone, where it has been affected by the greater movements, and they show in many places that they have been originally pebbly felspathic grits. To the eastward of this zone of probably clastic material other huge masses of the Lewisian gneiss have been pushed up and more or less deformed.

*Eastern or Younger Gneiss.*—While the chief part of the working season in the north-west Highlands has been devoted to the prosecution of the critical work in the districts just referred to, some progress has also been made in the mapping of the area of the eastern or younger schists (Moine-schists), which, brought forward by the higher thrust-planes, spread over so large an area of Sutherland and Ross. I have referred above to the extreme difficulty of ascertaining what has been the origin of these schists, and to the suggestive observations of Mr. Peach which may eventually lead to the recognition of these rocks as altered sediments. When the officers of the survey some years ago made a few preliminary traverses across the north of Sutherland, before beginning to map that region in detail, they were disposed to believe that certain belts of coarse, banded, gneisses which appear on the coast, were portions of the old gneiss that had escaped the crushing which produced the peculiar granulitic structure of the so-called Moine-schists. Closer examination and detailed mapping of these rocks have led Mr. Horne to modify this view. He regards it as certain that altered sediments form an integral portion of the granulitic schists and gneiss of that district. But he also finds that these schists and gneisses are traversed by abundant belts and veins of foliated and unfoliated granite, showing no cataclastic structure. From these larger portions of granitic material countless minute folia of the same substance have proceeded along the foliation planes of the schists. Hence three distinct types of gneiss have been produced: (1) granitoid gneiss or gneissose granite; (2) an intermediate type consisting of alternations of granulitic and granitic materials; (3) well-banded biotite-gneiss. If these Kirktony gneisses really belonged to the Lewisian system, it would follow that the granitic types thus developed must be later than the granulitic schists and gneisses. If, on the other hand, as is most probable, they are of post-Cambrian age, then we must admit that in rocks of this type petrographical characters cannot be regarded as furnishing by themselves a reliable chronological index.

*Schists of Central and Southern Highlands.*—In the Central and Southern Highlands, accumulating evidence, both in the field and, as already stated, from microscopical research, goes

to show that the main mass of the rocks composing that region are a thick and varied series of sedimentary deposits which, together with their associated igneous materials, have undergone extensive metamorphism. The degree of alteration sometimes reaches a point beyond which the original clastic structures are no longer traceable. But even where this is the case with some members of the series, others are found associated with them which can be recognised, and which indicate the persistence of the several stratigraphical groups. An area where there has been hardly any metamorphism has recently been mapped by Mr. J. G. Hill in the district of Loch Awe. The rocks in that tract consist of grits, phyllites and limestones, which in their unaltered condition resemble ordinary Palaeozoic sedimentary strata. These have been traced by Mr. Hill continuously into the crystalline schists of the central Highlands.

Much attention has recently been given to the eruptive rocks associated with the schists of the central and southern Highlands. Some of these are dark basic sills, which were injected before the plication and metamorphism of the surrounding rocks, others are later granitic intrusions, probably of different epochs of eruption. That a gradation from basic to acid composition within the same eruptive mass may sometimes be detected, indicating probably the order of consolidation of the component materials of an igneous protrusion, has been well shown by recent work of Messrs. Dakyns and Teall. Mr. Barrow's work in Forfarshire has brought to light the existence of a vast number of comparatively small bosses, veins, or lenticles of a granite, with both white and black mica, and usually showing a more or less distinctly foliated structure. He has also found numerous intrusions of a biotite gneiss. Both these rocks are accompanied by an alteration of the surrounding schists.

*Jurassic.*—In pursuance of the plan of field-work sketched in previous reports, Mr. H. B. Woodward was stationed in the Isle of Raasay, for the purpose of mapping the various members of the Jurassic series there exposed. He had nearly completed this survey when the short season came to an end, having traced the limits of the Great and Inferior Oolite, the Upper, Middle, and Lower Lias, and the Red Rocks underlying the Lias which are probably of Triassic age. In the course of his work he discovered a hitherto unsuspected bed of Oolitic ironstone in the upper part of the Middle Lias. A thickness of 4 feet 6 inches was seen by him, but the bed may possibly be a little thicker. In geological position this bed corresponds with the well known Cleveland iron-ore and other seams. An analysis, made by Mr. A. Dick, junr., under the superintendence of his father Mr. Allan Dick, who made in 1856 one of the earlier analyses of the Cleveland ore, showed the Raasay stone to contain a little more than 30 per cent. of metallic iron, the proportion in the Cleveland ore ranging from 30 to a little above 33 per cent.

*Glacial Deposits.*—In Scotland the mapping of the superficial deposits has gone on simultaneously with that of the solid rocks underneath, and in some parts of the country, where these deposits are especially complicated, the progress of the surveying is necessarily somewhat retarded. In the north-west Highlands some singular evidence has been obtained as to the thickness and flow of the great ice-sheet, at what seems to have been the time of maximum glaciation. Not only are the sides of the mountains well ice-worn, but there is evidence that the fragments of the characteristic Moine-schists of the interior of Sutherland and Ross have been carried up westward across the great ridges, thus proving that the axis of movement of the ice did not coincide with the present watershed of the country.

Some interesting relics of the later or valley glaciers have been mapped at Loch Torridon. Mr. Hinxman has traced the moraines down to the latest raised beaches of the west coast, Mr. Peach finds evidence that in the north of Sutherland glaciers continued to shed their moraines in the sea at the time of the formation of the 50-foot Raised Beach. Some of the high-level terraces of the River Naver in that district appear to have been formed between the edge of the ice and the side of the valley at a time when a glacier passed down the bed of the valley. Successive terraces, formed in this way as the glacier shrank backwards, may never have reached across the valley, though similar shelves of gravel may now occur on either side.

#### IRELAND.

The most important recent work of the staff of the survey of Ireland has been a re-examination of certain portions of the country with the view of determining how far the gneisses and schists represented on the maps could be correlated with those

of Great Britain, and in particular whether any of them could be separated from the rest and compared with the Lewisian or Anglesea gneisses of undoubtedly pre-Cambrian age. When the mapping of these rocks by the Survey was begun many years ago, no attempt had been made by geologists to distinguish the various pre-Cambrian groups of rock now known to exist in Britain, and when the survey of the country was completed by the mapping of Donegal, all that could be definitely stated about the schists of that region was that they were in the main metamorphosed sedimentary deposits, like those of the central and south-western Highlands of Scotland, of which they were obviously a prolongation. No certain trace could there be found of any nucleus of still more ancient rocks upon which these altered sediments had originally been deposited. It was recognised, however, that in other parts of Ireland rocks had been met with in the course of the survey which presented some resemblance to so-called "Archæan" masses, but of which the stratigraphical relations and petrographical characters had not been worked out. It was thus possible that isolated areas of pre-Cambrian rocks might be detected if diligently sought for, and that in this way traces might be recovered of the earliest topography of the region.

Some progress has now been made in this interesting search, and successful results have been obtained, whereby the mapping of the older formations has been materially improved. In the west of Tyrone and the adjacent borders of Donegal a group of rocks was found to present many of the typical characters of the Lewisian gneiss of the north-west of Scotland. Mr. McHenry, who first suggested the true nature of these rocks, was instructed to map them out in conjunction with Mr. Kilroe. They were found to occupy a clearly defined area and to be easily separable from the schists and quartzites of Donegal which are classed with the metamorphosed rocks of the south-western Highlands of Scotland. Unfortunately no distinct line of contact between the two groups of rock was traceable, though there could be little doubt that they must be separated by a great unconformability, and that the older gneiss had already acquired much of its present character before the deposition and metamorphism of the younger schistose series.

Probably the most important tract yet examined is that of the long ridge which runs from Sliogo to Castlebar, and of which the Slieve Gamp or Ox Mountains form a conspicuous portion. Here Mr. McHenry has found that at the base of the younger series coarse conglomerates occur, made out of the gneiss, and lying apparently in violent unconformability upon the older rock. If this observation is confirmed, it will establish an important point, not only in Irish but in British geology. It will show that the metamorphosed sedimentary rocks which form now the schists that build up the central and north-western Highlands of Scotland and the north-west of Ireland lie upon the uneven surface of an ancient gneiss, which presents the characters of the Lewisian gneiss of Sutherland and Ross-shire.

#### SCIENTIFIC SERIALS.

*American Journal of Science*, March.—Continuity of the glacial epoch, by G. F. Wright. In opposition to the author's view that the erosion of the rocky gorge of the Ohio river and its tributaries was preglacial, Prof. Chamberlin has maintained that the most important part of this rock erosion was interglacial. The author summarises the leading facts concerning the American glacial epoch by supposing that the earlier portions of the tertiary period were characterised by low altitude of land and warm temperature up to near the pole. A period of slow continental elevation of the regions which are now covered by glacial drift was in progress late in the pliocene epoch. During this stage the fiords of northern Europe and America and the extensive rocky gorges, like those of the upper Ohio and its tributaries, were eroded. Owing to this elevation glacial conditions characterised all the higher latitudes of North America and Western Europe. The glaciated area then began to sink until the land was, north of the great lakes at any rate, several hundred feet lower than it is now. The channels of the Allegheny, the Susquehanna, and the Delaware rivers were silted up by glacial debris, but were re-excavated by torrents of clear water during the re-elevation of the continent consequent upon the melting of some thousands of feet of ice. There were doubtless many oscillations of the ice-front both during the general advance and the general retreat of the ice-sheet, but

there does not seem to be any evidence of oscillations of the front sufficient to break the proper continuity of the period.—Deformation of the Lundy Beach and birth of Lake Erie, by J. W. Spencer. The inferred rate of terrestrial deformation in the Niagara district being 1.25 feet a century, it appears that before Niagara Falls can have receded past the Devonian ridge near Buffalo, the drainage of the upper lakes will have been turned into the Mississippi valley, which may require 7000 or 8000 years.—Six and seven-day weather periods, by H. Helm Clayton. The observation of barometric minima reveals many instances of six and seven-day periodicities lasting several weeks, and sufficiently striking to be easily recognised. In the case of successive individual storms, it was found that during an interval of about twenty-seven days, corresponding with a solar rotation, the storm tracts were found in groups, in each of which the cyclones all followed the same general direction, and were separated from each other by intervals of six or seven days, or in some cases by half these intervals.

*Symon's Monthly Meteorological Magazine*, March.—A wet February in Edinburgh, by the Editor. In different parts of Edinburgh observations of rainfall have been made for 116 years, the wettest previous February being 5.21 inches, in 1848, while this year the fall amounted to 7.62 inches at one station, or more than four and a half times the average.—Mild winter weather, by A. B. M. The writer points out that for a long time past (since the beginning of the century at least) we have had a conspicuously mild first quarter of the year every twelve or thirteen years. The average mean temperature for London for the first quarter for 130 years, according to Buchan, is 39°.8; the first quarter quoted is 1809, 42°.1, and the last 1884, 43°.6. According to this we might expect the first quarter of 1896 or 1897 to have a high mean temperature. With the exception of the first year, 1809, the mild quarters have been followed by fine, hot summers.

*L'Anthropologie*, tome iv. No. 6, November-December, 1893.—In 1891 Dr. Topinard was requested by the *New York Herald* to give his opinion as to the qualities that should be possessed by (1) *the perfect man*, and by (2) *the coming man*. He replied to the first question in a brief note which has since been embodied, with about 150 others of a similar character, in a work entitled "Ideals of Life," by Dr. Wallace Wood, of New York. Dr. Topinard now discusses the subject at greater length in an article on "Certain inferences and applications of Anthropology." From a natural history point of view, *the perfect man* is he who, with the highest sense of his own personality, can best adapt himself to circumstances, and possesses personal advantages which assure him, in the struggle for existence, pre-eminence over his fellows, over other species, and over the agencies and powers of nature. It is he who has the soundest mind in the healthiest body, and commands, especially, the greatest power of estimating the importance of his actions, and of making them conduce to the utmost to the satisfaction of his necessities, his interest, and his pleasure. From the social point of view, *the perfect man* is he who is the best adapted to that state; who possesses in the highest degree sentiments of fellowship, of justice, of altruism, of the distinction between good and evil, of duty, &c. which have been bequeathed to him by his ancestors, and which form the essential basis of our social organisation; who regards these principles as articles of faith, and makes them the invariable rule of his own conduct. From the psychological point of view, *the perfect man* is he whose brain is the healthiest, the most philosophic, the most capacious, and the most active; who comprehends and retains the most, and who can, with the best effect, draw upon his storehouse of knowledge at a moment's notice.—M. Ch. Féré contributes a short note on the relation of the length of the trunk to the height, in which he shows that the relative proportion becomes gradually less as the stature increases.—M. Salomon Reinach continues his criticism of the Eastern Mirage, and discusses, in this number, the influence exercised by Egypt and Assyria on the civilisation of Eastern Europe.—M. G. De Lapouge describes sixty-two crania taken from a modern cemetery at Karlsruhe. These crania had been previously measured by Dr. Wilser, directly after they had been cleaned, and very shortly after their removal from the vault, and it was agreed that these two anthropologists should publish the results of their observations independently, so that the modifications produced by drying might be studied, and that an estimate might be formed of the different results

given by the craniometric methods of Broca and Jhering. M. Lapouge measured the skulls exactly one year after Dr. Wilser, and during the whole of that time they had been thoroughly dried under the sunny roof of his laboratory at Montpellier. He also made a double series of measurements of the length and breadth of the skulls, first, by Broca's method, with a pair of calipers, and secondly, with Ammon's sliding compass, and after the method of Jhering, in precisely the same manner as Dr. Wilser's observations had been made. The results obtained are exceedingly interesting, and show that, in competent hands, it is a matter of perfect indifference which instrument is used, and that although, as one would naturally expect, the cephalic index is slightly greater when Jhering's method is employed, yet the difference is so small as to be almost insignificant. By Jhering's method the mean index of the series is 82.54, while Broca's index is 81.87. Both the length and breadth of the skull appear to be somewhat increased by drying, and the value of the cephalic index is a little raised, that obtained by Dr. Wilser from the fresh skulls being 81.84, while M. Lapouge's measurements of the dried skulls gave an index of 82.54. It will be observed that the difference is almost exactly the same as the excess of Jhering's index over Broca's. The flattening of skulls under the influence of desiccation is a phenomenon well known to all anthropologists, and in the case of these Karlsruhe skulls the mean diminution of height was more than a centimetre, so that, although the hygrometric conditions under which skulls are measured do not seem to affect the cephalic index of a series to an appreciable degree, the vertical and transverse indices of damp and dry crania are not comparable with one another.

## SOCIETIES AND ACADEMIES.

### LONDON.

**Physical Society,** March 9.—Prof. A. W. Rücker, F.R.S., President, in the chair.—Prof. O. Henrici, F.R.S., made a communication on mathematical calculating machines, especially a new harmonic analyser. After mentioning the general principles on which such machines are based, the author showed a new arithmometer devised by Prof. Selling, in which the jerky motions of the numeral wheels common in such instruments are eliminated, and the operations simplified. Another arithmometer of very compact design, named the "Brunsviga," had been placed on the table by Prof. Boys. The simple and ingenious "hatchet" integrator was then shown. It resembles a small hatchet with a tracing-point projecting at right angles to, and at the end of, the handle. Moving the point from near the centre of mass of any closed curve, round the curve once and back to the starting-point, the distance between the initial and final positions of the hatchet-head is a measure of the area of the curve. The instrument has been found very useful for indicator diagrams. A Hine and Robertson's planimeter (lent by Prof. Perry), an Amsler planimeter combined with a pentograph for measuring small areas, an Amsler integrator to give areas and first moments, and a beautiful sphere and cylinder rolling-integrator of great accuracy, by Coradi of Zürich, were shown, as well as an ingenious integrator devised by Abdank Abakonowicz. Passing on to harmonic analysers, Prof. Henrici explained the object of such instruments, viz. to determine the coefficients in Fourier's expansion for any periodic curve,

$$y = A_0 + A_1 \cos \theta + A_2 \cos 2\theta + \dots + B_1 \sin \theta + B_2 \sin 2\theta + \dots$$

and briefly described Lord Kelvin's instrument now in use at the Meteorological Office. This machine gives the first term and three pairs of coefficients A and B, but is large and expensive. The author had endeavoured to devise a simple and more portable instrument, and now described the various stages in the evolution of his new analyser. Using Clifford's method of wrapping the curve round a cylinder, he saw that by imparting a simple harmonic motion to a plane tangential to the cylinder, which plane carried an Amsler planimeter whose tracing point followed the intersection of the plane with the curve, as the cylinder rotated, any coefficient A, or B, could be determined. This arrangement had considerable friction, and only gave one coefficient at a time; it also necessitated readjustment of the period of the harmonic motion for each pair of terms. Another

machine founded on integration by parts was then constructed, in which the relative periods of cylinder and registering wheels was adjusted by a disc and roller, the motion being transmitted to the wheels by bands driven from the disc spindle. This gave A, and B, at one operation. Mr. A. Sharp used this machine for some time and then designed an inversion of it, in which the curve was laid out flat and the machine rolled over it. This arrangement greatly facilitated the multiplication of registering wheels, and thereby enabled several pairs of coefficients to be determined at once. The first machine of this kind showed several small errors which were avoided in a second instrument, a specimen of which, made by Coradi, was exhibited and described. A rectangular frame carried on three rollers (two being fixed to the ends of a long axis) traverses the paper in the direction of  $y$ , and the tracing point is fixed to a carriage which moves on the frame in a direction perpendicular to  $y$ , i.e. in the direction of  $\theta$ . A band is attached to this carriage and imparts a motion proportional to  $\theta$  to two horizontal axes (one for the A coefficients, and one for the B's), placed above and parallel to the long roller axis above mentioned. Each of the two axes carries five pinions having teeth in the ratios 1, 2, 3, 4, 5, respectively, which gear with crown wheels fixed to vertical spindles. The latter, therefore, rotate through angles proportional to  $\theta$ ,  $2\theta$ ,  $3\theta$ ,  $4\theta$ , and  $5\theta$ . To the lower ends of these spindles horizontal rings are attached, in which the bearings of a registering wheel are formed; each wheel rests on a cylinder carried by the long axis, and rolls or slides thereon according as its axis is parallel or perpendicular to that of the cylinder. Moving the tracing-point once round the curve gives five pairs of coefficients. By changing the driving-band to other pulleys so as to turn the pinions at different rates relative to the  $\theta$  movement, the 6th, 8th, 10th, and 7th and 9th pairs can be determined. The chief drawback of the instrument is that the registering wheels are not easy to read, whilst the back-lash of the crown wheels and pinions introduces small errors. In the latest form of instrument toothed wheels are dispensed with, and glass spheres carried in frames on the vertical spindles roll on the horizontal cylinders; each sphere actuates two registering wheels on fixed areas at right angles to each other, and these give respectively the sine and cosine coefficients. The number of vertical spindles is therefore halved, and the instrument greatly simplified. These details have been introduced by Coradi. A working drawing of another analyser, designed by Mr. Sharp, which gives the amplitude and epoch of the curve resulting from each pair of terms in Fourier's expansion, was exhibited. The discussion on Prof. Henrici's communication was postponed until next meeting.—Mr. H. Wilde, F.R.S., then exhibited and described his "magnetarium." This consists of a hollow geographical globe, wound all over the inner surface with insulated wire in planes parallel to the equator. Within this globe is a sphere wound with wire on its surface, and having its axis inclined at  $23\frac{1}{2}^\circ$  to that of the outer globe. By means of epicyclic gearing the spheres can be made to rotate at slightly different rates. When electric currents of suitable strength are passed through the two windings, the magnetic condition of the earth can be imitated, both as regards distribution at any epoch, and the secular variations. A better result was obtained by putting sheet iron over the land areas, and a still closer approximation by using thin iron over the water areas. A magnetic chart and tables giving the magnetic elements at various places for different epochs as determined by the magnetarium were shown. The author mentioned that recent observations by the United States Survey at Ascension Island, and by Prof. Thorpe in Senegambia, had confirmed results obtained by his instrument. The President said he had tried the apparatus, and found the Siberian oval closely imitated. The secular variations at Greenwich were also well shown. In South America the approximation was not so good. In reply to a question by Mr. Blakesley, Mr. Wilde said the present position of the pole of the inner sphere was  $84^\circ$  W.,  $67^\circ$  N.

**Geological Society,** March 7.—Dr. Henry Woodward, F.R.S., President, in the chair.—The Secretary announced that a portrait of the late Sir Richard Owen had been presented to the Society by Mr. Ernest Swain.—The following communications were read:—The systematic position of the Trilobites, by Mr. H. M. Bernard. The author, in his work on "The Apodidæ," endeavoured to show that *Apus* was the ancestral form of all existing crustacea except the ostracoda,

and as such might be expected to throw light upon the trilobites. Since the publication of this work he had been studying the organisation of the trilobites themselves, and the results were given in the present communication. He discussed the great variability in the number of segments shown by the trilobites; the formation of the head by the gradual incorporation of trunk-segments; the bending round ventrally of the first segment; the "wandering" of the eyes; the existence and modification of the "dorsal organ"; and especially the character of the limbs. As a result of this discussion, he stated that the zoological position of the trilobites can now be fixed with considerable probability. The features described serve to connect the trilobites with *Apus*. *Apus* must be assumed to lie low in the direct line up from the original annelidan ancestor towards the modern crustacea, and the trilobites must have branched off laterally from this line, either once or more than once, in times anterior to the primitive *Apus*, as forms specialised for creeping under the protection of a hard imbricated carapace, obtained by the repetition on every segment of the pleura of the head-segments, which together form the head-shield. The trilobites may be briefly described as fixed specialised stages in the evolution of the crustacea from an annelidan ancestor with its mouth bent round ventrally, so as to use its parapodia as jaws. The President agreed with Mr. Bernard that the earlier trilobites presented forms with very numerous segments, but pointed out that the later ones showed signs of advance in having fewer free thoracic rings and a well-developed pygidial shield. He had always cherished the idea that the Isopoda might have branched off at some distant time from the Trilobita, and he drew attention to such points of structure as the pores in the free cheeks, which were present in such Isopoda as *Sphaerona* and *Scolis*, and in such trilobites as *Phillipsia*, *Grimthides*, *Amfyx*, and *Franucus*. The Rev. T. R. Stebbing agreed with the author in thinking that the trilobites have little connection with the isopods, though the resemblance was sometimes striking, and was often favoured rather than otherwise by the character and position of the eyes. Prof. G. B. Howes said that he believed the discovery of the terminal anus in the trilobite dealt the death-blow to the association of the trilobites with the arachnid series. He believed that the facts and arguments brought forward by the author of the paper proved the trilobites to be crustacea, and fully justified their association with *Apus* as an early offshoot on the crustacean line. Mr. Malcolm Laurie also spoke, and the author replied.—Landscape marble, by Mr. Beeby Thompson. The Cotham stone is a hard, close-grained, argillaceous limestone with conchoidal fracture. The dark arborescent markings of the stone rise from a more or less stratified dark base, spread out as they rise, and terminate upwards in wavy handed portions of the limestones. In some specimens two "landscapes" are seen, one above the other, each rising from a distinct dark layer. The author described the microscopical and chemical characters of the rock, and its mode of occurrence, and discussed the explanations which have been put forward to account for its formation, especially that of Edward Owen, who in 1754 gave the first published description of the Cotham stone, and that advanced by Mr. H. B. Woodward in the *Geological Magazine* for 1892. He then proposed a new explanation to account for the formation of the rock, and maintained that its peculiar characters are due to interbedded layers of vegetable matter, which decomposed and evolved carbonic acid gas and marsh gas. This decomposition continued while several inches of new sediment were laid down, the result being that arborescent markings were produced along the lines taken by the escaping bubbles, and that the upward pressure of these gases, after their escape had been prevented by increasing coherence or greater thickness of the upper layers of sediment, caused the corrugations in the upper surface of the stone. He further discussed the composition of the stone, and described experiments which he made to illustrate his views. Mr. H. B. Woodward, Prof. T. Rupert Jones, Mr. F. A. Bather, and Mr. Moulton spoke upon the subject of the paper, and the author replied.—On the discovery of molluscs in the Upper Keuper at Shrewley, in Warwickshire, by the Rev. P. B. Brodie. Mr. R. B. Newton read a paper at the meeting of the British Association at Nottingham in 1893, on some lamellibranchs found at Shrewley by the author of the present paper and Mr. Richards. This paper gave details of the section where the shells were found, and their interest and importance were pointed out, no shells having been previously detected anywhere in the New Red Sands one in this country.

Entomological Society, March 14.—Colonel Swinhoe, Vice-President, in the chair.—Dr. D. Sharp, F.R.S., exhibited a collection of white ants (*Termites*), formed by Mr. G. D. Haviland in Singapore, which comprised about twelve species, of most of which the various forms were obtained. He said that Prof. Grassi had recently made observations on the European species, and had brought to light some important particulars; and also that in the discussion that had recently been carried on between Mr. Herbert Spencer and Prof. Weismann, the former had stated that in his opinion the different forms of social insects were produced by nutrition. Prof. Grassi's observations showed this view to be correct, and the specimens now exhibited confirmed one of the most important points in his observations. Dr. Sharp also stated that Mr. Haviland found in one nest eleven neotenic queens—that is to say, individuals having the appearance of the queen in some respects, while in others they are still immature. Mr. Haviland gave an account of the structure of some of the nests, and stated that two of the species of white ants exhibited certainly grow fungus for their use, as described by Smeathman, many years ago, in the *Philosophical Transactions*. Mr. H. Goss remarked that the fact that the different forms of social insects were produced by nutrition was known to Virgil, who referred to it, and to the subject of parthenogenesis in bees, in the "Georgics," book iv. Mr. McLachlan, Colonel Swinhoe, Mr. Champion, Mr. Jenner-Weir, and Dr. Sharp continued the discussion.—Mr. O. E. Janson exhibited specimens of *Dicranocephalus adamsi*, Pascoe, from Sze-chuen, Western China, and *D. dabryi*, Auz., recently received from the neighbourhood of Moupin, in the same district; he observed that, although the latter had been quoted by Lucas, Bates, and others, as a synonym of *adamsi*, the two species were perfectly distinct; the females of both were unknown to the authors when describing them, and presented a remarkable difference.—Mr. C. O. Waterhouse exhibited, for Mr. E. A. Waterhouse, a specimen of *Colias edusa* resembling *C. erate*, a continental species, which was taken on Wimbledon Common; a varied series of *Chrysophanus phleas*, from Barnes Common; and a series of *Lycaena arion*, from Cornwall.—The Rev. Canon Fowler read a paper entitled "Some New Species of *Membracidae*."—Mr. F. Merrifield read a paper entitled "Temperature Experiments in 1893, on several Species of *Tanessa* and other Lepidoptera." He said that the results tended to confirm Dr. Dixey's conclusions as to the origin of the wing-markings in the *Nymphalidae*, brought out many ancestral features, and in some cases were very striking. There was much difference in sensitiveness between the seasonal broods of the same species, even in *V. c. album*, although both broods of that species passed the pupal state in the warmer part of the year.—Dr. Dixey read a paper entitled "On Mr. Merrifield's Experiments in Temperature Variation as bearing on Theories of Heredity," which was supplemental to the previous paper. Colonel Swinhoe, Mr. Hampsden, Mr. Jenner-Weir, Mr. Merrifield, and Dr. Dixey took part in the discussion which ensued.

Linnean Society, March 15.—Prof. Stewart, President, in the chair.—Mr. Clement Reid exhibited some cones of Scotch fir, and also some carbonised pine wood from a peat moss at Parkstone, Dorset. He said the pine had become extinct in the South of England after Neolithic times, and had been reintroduced only recently. Its extinction was commonly supposed to be due to forest fires. He found that every piece of pine wood imbedded in the peat moss was similarly charred, while portions imbedded in sand were little altered, and he suggested that the appearance of burning might possibly be due to the action of the growing peat, and have nothing to do with fire. A discussion followed, in which Messrs. Carruthers, Hanbury Christy, and others gave reasons for adhering to the older theory. Mr. Carruthers exhibited a diagrammatic table showing an accurate counting of the annual rings of growth in three gigantic specimens of Wellingtonia, *Sequoia gigantea*, from which he calculated the age of the trees (see p. 507). A section of one in the British Museum (Natural History), fifteen feet in diameter, which was a living tree when cut down, he estimated to be 1330 years old. As illustrative of the size to which these trees grow, he mentioned that he had measured two in America, one of which was 92 feet and the other 77 feet in circumference. A discussion followed on the conditions which accelerated or retarded growth, and Mr. G. Murray, in reply to a suggestion of Mr. Reid, pointed out that a number of experiments had

been made on various trees to test their rate of growth under different conditions of weather and temperature, but that the results varied to such an extent as to afford no basis for sound conclusions. Mr. A. B. Rendle exhibited the fruit of *Melocanna bambusoides* from the Mauritius, where it had been introduced, and gave some account of its structure and mode of growth, referring to the figure of it given by Roxburgh in his "Plants of the Coast of Coromandel" (pl. 243), under the name *Bambusa baccifera*.—Mr. C. B. Clarke gave the substance of a paper "on certain authentic *Cyperaceæ* of Linnæus," describing the results of his examination of the type specimens in the Linnean Herbarium, with suggestions for some rectifications in the nomenclature. Referring incidentally to the history of this Herbarium, he regretted the additions which had been made to it since the death of Linnæus, and the introduction of plants which Linnæus had never seen. In the discussion which followed, Mr. Carruthers and Mr. Daydon Jackson explained under what circumstances these additions had been made, and showed that it was antecedent to the collection coming into the possession of the Society, since which time no alteration in its condition had taken place.—Mr. George Brebner read a paper "on the development of the mucilage-canals of the *Marattiaceæ*," in which, with the aid of some excellent lantern slides, he showed that these canals are schizogenous intercellular spaces arising from the separation of cells, and are lined by a persistent epithelium. The secretion is thus the product of the activity of living cells, and not the result of cell-degradation. An interesting discussion followed, in which Dr. D. H. Scott, Prof. Reynolds Green, and others took part, and the meeting adjourned to April 5.

Zoological Society, March 20.—Prof. G. B. Howes in the chair.—The Secretary exhibited and made remarks on a photograph of a young male Indian bison (*Bos gaurus*), proposed to be sent home as a present to the Society's menagerie by Major G. S. Roden.—Mr. F. G. Parsons read a paper on the myology of the Hystricomorphine and Sciuricomorphine rodents, and stated that it was based on the dissection of the muscles of examples of twenty-one species of rodents, belonging to many families of the Hystricomorpha and Sciuricomorpha, made at the Society's gardens. The results of these dissections had been compared with the writings of other observers, and arranged, firstly under the heads of the different muscles, and secondly under those of the different families. The arrangement of the muscles coincided in a marked manner with the usual classification of the order, and seemed to depend much more upon the affinities of the animals than upon their habits and mode of life. The muscles which seemed most characteristic of the two principal sections were the masseter, the long flexors of the foot, the sterno-scapular, and the digastric. Three genera of the *Dipodide* had been examined, and were found to resemble the Hystricomorpha in many respects, while in others they approached the Sciuricomorphine type.—A communication was read from Babu Ram Bramha Sanyal, containing remarks on a rare carnivorous mammal of Borneo (*Cynogale bennetti*), based on a specimen living in the Zoological Gardens of Calcutta.—A communication was read from Dr. R. W. Shufeldt, containing an account of the osteology of certain Cranes, Rails, and their allies, with remarks upon their affinities.—A communication was read from Mr. O. V. Aplin, containing field-notes on the Mammals of Uruguay, made during his recent expedition to that country.

Chemical Society, March 1.—Dr. Armstrong, President, in the chair.—The following papers were read:—The aerial oxidation of terpenes and essential oils, by C. T. Kingzett.—The amides of sodium, potassium, and lithium, by A. W. Titherley. Sodamide,  $\text{NaNH}_2$ , is obtained as a white crystalline mass by passing ammonia over sodium at  $300^\circ\text{--}400^\circ$ ; no sodium nitride,  $\text{Na}_3\text{N}$ , or disodium amide,  $\text{Na}_2\text{NH}$ , could be prepared. Potassamide,  $\text{KNH}_2$ , is similarly prepared, and sublimes at  $400^\circ$ . Lithamide,  $\text{LiNH}_2$ , is obtained in the same way, and has similar properties to the sodium and potassium amides.

Quekett Microscopical Club, March 16.—Mr. A. D. Michael, Vice-President, in the chair.—The secretary said they had received a donation which required something more than a formal acknowledgment. As members were aware, the club's collection was undergoing revision, and Mr. Morland, who had undertaken the Diatomaceæ, had presented a series of

thirty-seven slides to replace others found to be bad or wanting. A special vote of thanks to Mr. Morland was carried unanimously. The chairman, on behalf of the subscribers, presented Mr. F. A. Parsons with an address and a valuable gold watch, as a testimonial to his zealous endeavours as secretary of the excursions sub-committee, during the last ten years, to make the gatherings a success. Coupled with these was a special series of pond-life, prepared and presented by Mr. C. F. Rousselet. Prof. Edlinger's photographic and drawing apparatus, made by Leitz, was exhibited by Mr. C. L. Curties.—Messrs. Swift exhibited and described their new biological microscope, which had the posterior limb of the tripod doubled and rotating on a pivot, thus giving increased steadiness to the stand, and at the same time enabling it to be packed in a smaller case. It was explained that the pivot was provided with a strong spiral spring, which would prevent it becoming loose, and also take up any wear at the bearing surfaces.—Mr. E. M. Nelson's paper on "the determination of the foci of microscopical objectives; lantern and camera lenses by arithmetical formulæ," was taken as read.—Mr. H. W. King read a paper on "Amoeba." A discussion ensued, in which Mr. J. D. Hardy, the chairman, and the author took part.

## CAMBRIDGE.

Philosophical Society, March 12.—Prof. T. McK. Hughes, President, in the chair.—Dr. W. H. R. Rivers showed apparatus devised by Prof. Hering to illustrate (1) colour-blindness of peripheral retina; (2) mirror-contrast; (3) influence of strength of illumination and of contrast on quality of colour; (4) diagnosis of colour-blindness.—Mr. J. C. Willis exhibited a plant of *Deherainea smaragdina* in flower. The flowers are interesting on account of their green colour, their large size and disagreeable smell. They are extremely protandrous. In the early stage the extrorse anthers completely surround and hide the stigma; later on the stamens bend away and come to rest on the corolla, and the flower is now female. From its colour scent, &c. it is probably adapted to large flies.—Notes on the Bunbury Collection of Fossil Plants, by Mr. A. C. Seward. Attention was called to the exceedingly interesting and representative collection of fossil plants recently acquired by the Botanical Department through the generosity of Lady Bunbury. Among the plants exhibited at the meeting were several type specimens from the coal-measures of the Sydney coal-field, Cape Breton; also some figured specimens from English rocks of Carboniferous and Jurassic age. One of the Jurassic species, *Pecopteris exilis*, Phill. was briefly described, and it was pointed out that Sir Charles Bunbury's account of this plant and his figure of the sporangia was entirely supported by a re-examination of the figured specimen. The generic name of *Klukia*, recently instituted by Raciborski for certain species of Mesozoic Schizaceous ferns, was therefore preferable to the older provisional genus *Pecopteris*, originally adopted for this Jurassic species.—Note on the liver-ferment, by Miss M. C. Tebb. By extraction with glycerin Claude Bernard obtained from liver a ferment which converted glycogen into sugar, but the properties of this sugar were not described. In the present research it was found that pig's liver, rapidly dried, produced dextrose when allowed to act on starch or glycogen. In all cases whether an extract or the dried tissue itself was used, the product of the action on starch or glycogen always gave crystals of phenyl glucosazone with phenyl hydrazin, and the reducing power increased *only slightly* on boiling with acid; hence the conclusion was drawn that one product of the action is *dextrose*. As far as they have gone, experiments with fresh liver have yielded the same result.

## DUBLIN.

Royal Irish Academy, February 25.—Dr. J. K. Ingram, President, in the chair.—A paper was read by the Right Rev. Dr. Graves, on the discovery in the south of Ireland of a stone with a most perfect Ogham inscription.—Mr. Henry Dixon read some notes on the peculiar method of the development of the axillary buds of *Vanda teres*. The buds in developing break through the lower part of the petioles, and appear below the laminae of the subtending leaf opposite to the lamina of the leaf next below it. This manner of development was also found in *Dendrobium arides* and several species of *Vanda*. The chains of cells, with siliceous bodies found accompanying the sclerenchymatous fibres of the bundles in many Monocotyledons, were detected in the leaves but not in the stem of this orchid. The development of these cells was found to be

the same as that described by Prof. Strasburger in *Cocos flexuosa*. In tracing the outer stem bundles downwards, one occasionally was found to end in the woody fundamental tissue of the stem without fusing with another from a lower leaf. In the cylindrical leaf of *Vanda teres* the bilateral symmetry characteristic of most leaves was replaced by an imperfect radial symmetry; the upper surface of the leaf is, however, represented by a longitudinal groove in the lamina. In *Dendrobium teretifolium* almost perfect radial symmetry was found, the upper surface being represented by a canal running axially down the leaf; the walls of this canal for the greater part of its length are in close apposition, and are lined with epidermal cells, having a strongly marked cuticle. The development of this leaf was found to correspond with that of *V. teres*, except that the collar of tissue from which it arises enlarges uniformly, and not, as in *V. teres*, mostly on that side on which the lamina stands. The leaf in *Brassavola Haudeveni* is an interesting connecting link between that of *Dendrobium teretifolium* and *Vanda teres*; the distal portion of the leaf is circular on cross-section, lower down a deep groove represents the upper surface, while at a still lower point the sides of the groove fused over it and the groove becomes a "canal" passing obliquely inwards into the leaf, till it finally occupies an almost axial position. The memoir was illustrated by a large series of drawings representing the various structures referred to, and a selection of these, of which photographs had been made, were thrown on the screen. Both papers were referred to the Council for publication in the *Proceedings* of the Academy.

PARIS.

Academy of Sciences, March 19.—M. Loewy in the chair.—The death of General Favé was announced by the President.—An apparatus illustrating the horizontal movements in walking, by M. H. Resal.—On intestinal absorption and the lacteals of the rat, by M. L. Ranvier.—Observations of the planets 1894, AX Wolf, AY Wolf, AZ Courty, BA Charlois, made at Toulouse Observatory (Brunner equatorial), by M. E. Cosserat.—Observations of the new planets BB (Charlois, Nice, March 8) and AN (Heidelberg, March 1), made at Lyons Observatory by M. G. Le Cadet.—On the variations of the Peltier effect produced by magnetisation, by M. L. Houllévegue. A theoretical consideration of the cases of iron and bismuth longitudinally and transversely magnetised and nickel longitudinally magnetised, with copper as the second element of the couple. The equation  $V_T = \int \phi (T_1 M) dT$  furnishes a general

solution of the problem "to find, at any temperature T, the difference of potential between a soft metal and the same metal in a field M," which the author is examining experimentally.—New method of studying electric convection in gases, by M. N. Pilchikoff. A point discharge is directed on to the surface of castor oil, and the depression of this surface studied under varying conditions.—Application of the vectorial method to the study of apparatus giving intermittent secondary currents, by M. A. Blondel.—The *monochromatoscope*, a new apparatus, by M. Maurice de Thierry.—On the general law of the solubility of normal substances, by M. H. Le Chatelier. A mathematical paper in which one of the deductions is as follows: If latent heat of solution were independent of temperature and concentration, the normal curve of solubility of any given substance would be the same in all solvents.—On a new automatic apparatus for measuring simultaneously the weight and volume of liquids, by M. Louis Bedout.—On the molecular weight of ferric chloride, by M. P. Th. Muller. The raising of the boiling points of alcohol and of ether by dissolved ferric chloride show that the molecular weight at the boiling point of alcohol is represented by the formula  $FeCl_3$ ; in the case of ether solutions, the molecular weight diminishes with the increase in dilution.—On the composition and heat of formation of the hydrate of nitrous oxide, by M. Villard. The composition of this substance corresponds to the formula  $N_2O \cdot 6H_2O$ . Two determinations of its heat of formation gave 77.84 cal. and 77.76 cal. for 1 gram of water.—On thallium hypophosphates, by M. A. Joly. The salts  $Tl_2H_2P_3O_6$  and  $Tl_2P_2O_6$  are described. The latter decomposes with liberation of heat when heated to 250°;  $Tl_2P_2O_6 = 2TlPO_3 + 2Tl$ .—On the distribution of strains in metals under stresses, by M. F. Osmond.—On  $\beta$  dibromopropionic acid, by M. R. Thomas Mamert.  $CHBr_2 \cdot CH_2 \cdot CO_2H$  is obtained by the action of fuming hydrobromic acid on  $CHBr \cdot CH_2 \cdot CO_2H$  at 100°. It melts at 71°.—On the

influence of the method of distribution of manures on their utilisation by plants, by M. A. Prunet.—Researches on the pathology of pancreatic diabetes, by M. M. Kaufmann.—The glucose formation exciting nerves, by MM. Morat and Dufourt.—On the anal sacs of Ophidians, by M. Portier.—Anatomy of the trachean system of the larvæ of Hymenoptera, by M. Bordas. This system may be represented as formed by two long lateral parallel cylinders, giving off numerous transverse branches, united anteriorly by a large trunk, and posteriorly by two unequal branches forming a perirectal ring.—On the degeneration of the genital products among the Polyclinidæ, by M. Caullery.—Bacillary maladies of several plants, by MM. Prillieux and Delacroix.—On *Pterophyllum*, by M. B. Renault.—On the gabbros and amphibolites of the bed rock of Belle-donne, by MM. L. Duparc and A. Delebecque.—The *tectonique* zones of the Alps of Switzerland and Savoy, by M. Emile Haug.—Researches on mud overflows, by M. Stanislas Meunier.

BOOKS, PAMPHLETS, and SERIALS RECEIVED.

BOOKS.—Life and Rock: R. Lydekker (Universal Press, High Holborn).—The Microscope and Microscopical Methods: Prof. S. H. Gage, 5th edition (Ithaca, New York).—A Standard Dictionary of the English Language, Vol. 1 (Funk and Wagnalls Co.).—Introduction to the Mathematical Theory of the Stress and Strain of Elastic Solids: Dr. B. Williamson (Longmans).—The Outlines of Quaternions: Lieut.-Colonel H. W. L. Hime (Longmans).—Everybody's Guide to Gardening: H. H. Warner (Saxon).—Perennial Irrigation and Flood Protection for Egypt (Cairo).

PAMPHLETS.—Hand-Guide to the Royal Botanic Gardens, Péradeniya: H. Trimen, 4th edition (Colombo).—Die Magnetischen Localabweichungen bei Moskau, &c.: Dr. H. Fritsche.—Report on the Operations of the Department of Land Records and Agriculture, Madras Presidency, 1892-93 (Madras).

SERIALS.—Timehri. December (Stanford).—Beiträge zur Geophysik, 2 Band, 1 Heft (Stuttgart).—Astonomy and Astro-Physics, March (Wesley).—Natural Science, April (Macmillan).—Geographical Journal, April (Stanford).—Morphologisches Jahrbuch, 21 Band, 1 Heft (Williams and Norgate).—Transactions of the Astronomical and Physical Society of Toronto for 1893 (Toronto).—The American Antiquarian and Oriental Journal, November (K. Paul).—Humanitarian, April (Sonnenschein).—Epsom College Natural History Society Report for Year 1893 (Holmes).

CONTENTS.

|                                                                                                                  | PAGE |
|------------------------------------------------------------------------------------------------------------------|------|
| The Flowering Plants of Western India . . . . .                                                                  | 501  |
| The Parasitic Theory of the Causation of Malignant Tumours . . . . .                                             | 502  |
| Our Book Shelf:—                                                                                                 |      |
| Hickson: "The Fauna of the Deep Sea" . . . . .                                                                   | 502  |
| Greaves: "A Treatise on Elementary Hydrostatics" . . . . .                                                       | 503  |
| Letters to the Editor:—                                                                                          |      |
| Sun-spots and Magnetic Disturbances.—Dr. M. A. Veeder . . . . .                                                  | 503  |
| Dredging Expedition at Port Erin.—Prof. W. A. Herdman, F.R.S. . . . .                                            | 503  |
| The Scope of Psycho-Physiology. By Prof. C. Lloyd Morgan . . . . .                                               | 504  |
| The Behaviour of Liquids under High Pressures. (With Diagram.) By J. W. Rodger . . . . .                         | 506  |
| Notes . . . . .                                                                                                  | 507  |
| Our Astronomical Column:—                                                                                        |      |
| Photographic Nebulosities in the Milky Way . . . . .                                                             | 511  |
| Madras Observatory . . . . .                                                                                     | 511  |
| A New Comet . . . . .                                                                                            | 511  |
| Recent Investigations and Ideas on the Fixation of Nitrogen by Plants. By Prof. H. Marshall Ward, F.R.S. . . . . | 511  |
| The Har Dalam Cavern and its Ossiferous Contents . . . . .                                                       | 514  |
| Geography in Caucasus . . . . .                                                                                  | 515  |
| Isoperimetrical Problems. (Illustrated.) By Lord Kelvin, Pres. R.S. . . . .                                      | 515  |
| Geological Survey of the United Kingdom. II. By Sir Archibald Geikie, F.R.S. . . . .                             | 518  |
| Scientific Serials . . . . .                                                                                     | 520  |
| Societies and Academies . . . . .                                                                                | 521  |
| Books, Pamphlets, and Serials Received . . . . .                                                                 | 524  |



THURSDAY, APRIL 5, 1894.

THE NEW PHARMACOPŒIA OF THE  
UNITED STATES.

*The Pharmacopœia of the United States of America.*  
Seventh decennial revision (1890). (Philadelphia,  
Pa., 1893.)

THE history of the various editions of the United States Pharmacopœia presents some points of interest. The first Pharmacopœia, published both in Latin and English, appeared in 1820, and so obviously filled a want that a second edition was supplied in 1828. The original intention was to issue a second Pharmacopœia in 1830, but in consequence of serious difference of opinion amongst the delegates to the convention, the design was nearly frustrated. The contending parties were for a time unable to reconcile their differences, and two works were produced, one in New York, and the other in Philadelphia, neither of which received official sanction. However, towards the end of the year, a second national Pharmacopœia was published in New York, and was reissued, in a slightly amended form, in Philadelphia in 1831. Ten years elapsed before any further steps were taken, but in 1842 unanimity prevailed, and the third revision appeared. The Pharmacopœia of 1851 gave such satisfaction that in 1855 it reached a second edition. In 1873 there appeared what is officially known as the fifth revision, which was followed in 1882 by a sixth Pharmacopœia. The present issue is called the seventh decennial revision of 1890, but did not come into force until January 1894.

The mode of obtaining materials for the revision of the United States Pharmacopœia differs somewhat from that employed in this country. To give it the requisite degree of popularity as a national undertaking it is considered desirable that every State should assist in its production. A number of universities, associations, and medical societies are invited to send delegates to a general meeting at Washington, which appoints certain permanent officers and a committee for the revision and publication of the work. It appears that the delegates from the more distant States do not as a rule appear in person, but they are technically represented, and any friction between the often conflicting interests of the East and West is avoided. In the case of the present revision the first meeting was held early in 1890, and the requisite materials being at hand, the work was completed with commendable dispatch. The committee were fortunate in having for their chairman Dr. Horatio C. Wood, of Philadelphia, an accomplished pharmacologist, and the author of a work on the physiological action of drugs, which is a model of lucid reasoning based on scientific research. Before adjourning, the convention made arrangements for publishing a supplement at the end of five years, and for the issue of a complete revision in 1900.

Several matters of considerable importance engaged the attention of the framers of the present edition. First and foremost was the question of establishing a fixed proportion, or possibly of fixing the limits of the

active principles in the preparations, of the more active drugs capable of being accurately assayed. The matter was very fully discussed, but after carefully investigating the various processes, which from time to time had been suggested either as general methods of assay or as being applicable to special drugs, the convention came to the conclusion that reliable measures resulting in even approximately uniform results when carried out by different observers were available only in the case of a very small number of drugs. It was considered necessary that particular caution should be exercised in this matter, seeing that pharmacopœial requirements and assay processes are often made the basis of legal proceedings by public inspectors and others entrusted with the duty of enforcing the regulations relating to the adulteration of food and drugs. It was determined to apply the processes of assay to three drugs only, opium, nux vomica, and cinchona, and their preparations, leaving the extension of the system to some future date. The committee were of opinion that there was a fair prospect of being able to add materially to this list at the next revision.

It was deemed undesirable to make the tinctures of uniform strength, for it was feared that more harm would be done by so radical a change than would be compensated for by the advantage of ensuring simplicity and uniformity. It will be seen that the committee were careful not to introduce drastic remedies in matters of policy.

The adoption of the metric system in the directions for making the various preparations is distinctly a move in the right direction, whilst we note with pleasure that the term "official" has superseded the old word "official."

Certain minor alterations respecting the spelling, mode of printing, and interpunctuation to be followed in the use of botanical names were adopted in accordance with the suggestions of the Paris Codex of 1867. It was decided that species names should be printed with a small initial letter even if derived from geographical names. Certain exceptions were made to this rule, as when the specific name had itself at any previous time been a genus name—*Datura Stramonium*, to wit— or when the species name is derived from the name of a person, or when it is an undecidable noun.

The changes which have been made in the body of the work call for detailed notice. In the first place we find that ninety drugs and preparations have been "dismissed," presumably on the ground that they are valueless, or are no longer extensively employed. The majority of them, it must be confessed, will not be missed. It is probable that few physicians in this country, at all events, have any knowledge of the therapeutical properties of azedarach, cydonium, or magnolia. We are surprised, however, to find extract of malt in the list of expurgated remedies. There is probably no drug more extensively employed, and from which greater benefit has been derived in all forms of wasting diseases. We are justified in concluding that it has been omitted not from any want of faith in its medicinal value, but from the difficulty which has always been experienced in accurately defining it. The arguments against introducing it into the last edition of

the British Pharmacopœia were purely pharmaceutical, and were in no way connected with any disbelief in its therapeutical properties. The exclusion of Ignatia will be regarded with feelings of regret by many prescribers who have been accustomed to consider it of much value in the treatment of hysteria and other affections incidental to women. It undoubtedly contains active principles identical with those of nux vomica, but therapeutically the two drugs appear not to be interchangeable. Thuja, again, although comparatively little known, has many enthusiastic supporters. The evidence in favour of these drugs, it is true, is purely clinical, and rests on no firm pharmacological basis.

The list of articles added to the Pharmacopœia, some eighty-eight in number, is of importance as indicating the measure of popularity which certain drugs have obtained in the United States. The selection will meet with the approval of the great majority of therapeutists in this country. We note with pleasure that the bromide lactate and iodide of strontium have received official recognition. These salts, thanks to the researches of Paraf-Javal, can now be obtained in a state of absolute purity. The bromide especially is extensively employed, and has, to a great extent, superseded the other bromides in the treatment of epilepsy and other convulsive disorders. It rarely produces a rash on the skin, or any of the other symptoms included under the term "bromism." The lactate is said to be useful in Bright's disease and chronic albuminuria, whilst the iodide is of much value in the treatment of tertiary syphilis. Strophanthus, the pharmacological action of which was so exhaustively worked out by Prof. T. R. Fraser, of Edinburgh, very properly receives admission, its value as a substitute for digitalis ensuring its ready acceptance. Convallaria, another member of the digitalis group, is not so generally used, and of late years has lost rather than gained popularity. Its admission may perhaps excite some surprise; but if there is a difference of opinion respecting the value of any particular drug, it is as well to err on the side of liberality. Rosorcin is another drug which has hardly maintained its early reputation, but it is still extensively employed in Germany, and its admission may fairly be considered justifiable. Lanoline, cocaine, menthol, naphthol, and salol have passed into the category of domestic remedies, and are so largely used that they could not be overlooked. Nitrite of sodium, the introduction of which some years ago excited much controversy, has slowly but surely established itself in public favour, and has now an assured position as a therapeutical agent. We find, with some surprise, that pepsin, the manufacture of which has been carried to an amazing pitch of perfection by American chemists, is now for the first time admitted into their Pharmacopœia. The method of estimating its activity differs materially from that recommended in the British Pharmacopœia, the standard being considerably higher, so that many of our commercial pepsins would hardly pass muster in America. Pancreatin, now so largely employed for predigesting milk and other foods, takes its place beside pepsin. The ever-popular anti-febrin is introduced under the name of acetanilidum, but we look in vain for antipyrine, sulphonal, saccharin and many other remedies of undoubted value. The explana-

tion of the absence of some recently introduced remedies may be found in the statement contained in the preface that "in accordance with the positive instructions of the convention those of the new synthetic remedies which cannot be produced otherwise than under patented processes, or which are protected by proprietary rights, are not admitted into the Pharmacopœia." Pure terebene and terpin hydrate, which clearly do not come under the ban, are admitted without question. It is clear that the framers of an official publication, such as a national Pharmacopœia, exercise a wise discretion in refusing to admit drugs the exact composition of which is unknown whilst their mode of manufacture is practically a trade secret.

In conclusion, we must offer our sincere congratulations to the committee and those who have assisted in the work on the admirable manner in which their gigantic task has been accomplished.

#### TWO BOOKS ON FORESTRY.

No. 2. *Tree Pruning. A Treatise on Pruning Forest and Ornamental Trees.* By A. des Cars. Translated from the seventh French edition by C. S. Sargent, Professor of Arboriculture in Harvard University, U.S.A. (London: Rider, 1893.)

No. 3. *Practical Forestry.* By Angus D. Webster, Wood Manager to the Duke of Bedford. (London: Rider.)

MESSRS. RIDER AND SON are publishing a series of technical handbooks, the first of which dealt with the economical transmission of power, and Nos. 2 and 3 have just been issued. Des Cars' treatise on pruning is in many ways an excellent little book, which has been thoroughly well translated by Prof. Sargent, and it contains sixty plates admirably illustrating the text.

The book is written in a most persuasive style, and no landowner with trees in his hedgerows, or some parcels of woodland, will read it without being tempted to set to work straightway and prune his trees. Des Cars somewhat ambitiously considers pruning as "a means of growing the greatest number of full-grown trees on a given area, and making them attain their greatest value in the shortest time without injury to the underwood beneath them."

The first fifty-six pages of the book deal with the oak, the species usually grown in Britain and in the north of France as standards over coppice; and from an incidental remark, it may also be considered applicable to the elm and ash, though no distinction is made regarding sycamore or other trees which do not recover readily from pruning.

Only three pages are given to soft-woods, poplars and conifers, and for firs and spruces Des Cars very wisely advises that pruning should be restricted to dead and dying branches, to be cut off close to the trunk, so as to prevent the knots which interfere with their growth, and eventually produce holes in boards and planks. His advice regarding pines is not quite so sound, for though it is quite true that when grown isolated they develop large branches, yet no one wanting pine timber would

dream of growing the trees far apart. Pruning off the large branches of isolated pines, which Des Cars says can be safely reduced to half or one-third of their length, provided foliage branches are left above the section to draw up the sap, will not improve the timber of these trees; nor certainly, as Des Cars says, render them fit for masts and spars, which can only be obtained from the densely-planted and slowly-grown pine-forests of Northern Europe.

To return to the treatment proposed for oak trees: Des Cars will not persuade foresters that large living branches can be pruned off without danger to the future quality of the timber, however carefully the operation may be performed. It is safer to restrict pruning, in the case of oak, to dead or dying branches, or to branches still too young to contain any heart-wood, and which therefore heal up speedily. Broillard, one of the best of French foresters, who has recently written an excellent book<sup>1</sup> on forest management in France, praises the hedgerow oaks of England especially because they are left with their natural crowns intact. If oaks are to be trained, it should be done whilst they are young. Having premised the danger of too great enthusiasm for pruning on the part of inexperienced persons, there can be no doubt that it may sometimes be necessary to prune large branches of neglected roadside avenue trees, which, however, should have been done whilst they were still only formed of sap-wood; and in such cases, and in all cases of pruning small branches, Des Cars is an excellent guide, and thoroughly explains how the pruning should be effected, his main ideas being to prune close to the stem, and in merely shortening branches to leave a sap-lifter above the wound, to maintain life in the shortened branch. Finally, all wounds should be dressed with coal-tar. For carrying out the work, De Courval's strong heavy pruning hatchet is recommended, and the use of the saw deprecated, as requiring much practice to use skilfully; but it is better only to employ skilful woodmen to prune trees, and then the saw is generally the better instrument to use.

"Webster's Practical Forestry" is another useful little book, giving the experience of a practical man who has devoted his lifetime to the every-day duties of a forester. It is not, however, by any means an exhaustive treatise, and, curiously enough, not a word is said about pruning; but the author wisely advises that wherever trees are grown for their economic value, they should be kept close with an unbroken leaf-canopy, so that the lower branches may be killed outright for fully one-half the length of the stems.

Nothing is said about coppice or coppice with standards, which are the commonest modes of growing woods in England.

The efficacy of drainage on forest growth is too much insisted on, while the opinion of French foresters on moisture in the soil may be summarised as follows from Broillard's book, already quoted:—

Dry lands will only produce timber under dense growth of shady trees, which keeps the soil somewhat moist in summer.

Soils which in summer never dry below 6–8 inches

<sup>1</sup> "Le traitement des bois en France," par Ch. Broillard, ancien professeur à l'école forestière. (Paris: Berger Levrault et Cie, 1894.)

allow most forest species to thrive. Moist soils, which when pressed in the hand always leave some trace of moisture, are the most fertile, and suit the pedunculate oak, the ash, and the elm.

Wet soils, usually saturated with water, provided the latter is in movement, and therefore aerated, as along the banks of watercourses, suit alders, willows, and poplars.

Marshes are usually unproductive, but they afford moisture to neighbouring lands, and fine trees are found along their borders. Thus drainage is only required where there is not enough fall of the ground for the water to move about, and, provided the water does not stagnate the roots of forest trees are the best drainers of a soil.

Webster gives some useful notes on trees adapted for various soils and for town planting, and ranks the maiden-hair tree (*Ginkgo biloba*) and *Ailanthus glandulosa* next to the plane as trees flourishing in spite of the smoke of large cities. He also gives an excellent list of trees adapted to grow exposed to sea-breezes, of which *Pinus Laricio* is the best among conifers, and Norway maple and sycamore among broad-leaved trees. The larch, it appears, when grown on gravel generally becomes rotten at the core, and Webster's advice to study the relationship of trees and soils is greatly needed in England, where it is frequently the practice to plant alternate lines of spruce, Scotch pine, larch, and beech without any regard to the different demands they make on the soil. His complaint of preferential railway rates to foreign growers, which have rendered osier-beds unremunerative, points to a great obstacle to forestry in the United Kingdom. An Irish land-agent recently said that it was impossible to send wood from the interior to the ports at a profit; and if our railways cannot provide cheap goods carriage, it is time that canal extension on a large scale were proposed for the transport of our heavy country produce, and that existing canals were withdrawn from the control of the railway companies.

W. R. FISHER.

#### RECENT RESEARCHES ON SACCHARO-MYCETES.

*Micro-Organisms and Fermentation.* By Alfred Jörgensen (Copenhagen). Translated from the third edition in German by A. K. Miller and E. A. Lennholm, and revised by the author. (London: F. W. Lyon, 1893.)

THE development of bacteriology is closely linked together with the advances made in our knowledge of fermentation, which was first placed on a truly scientific basis through the far-reaching investigations of Louis Pasteur in his "Études sur la bière." He propounded the doctrine that every fermentation and putrefaction is caused by micro-organisms. This is an accepted theory now, if by fermentation we understand alcoholic fermentation. For there are other processes of fermentation which are produced by unorganised substances, whose chemical nature is as yet undefinable, such as ptyalin, pepsin, trypsin. The part played by micro-organisms as ferments in disease is still shrouded in mystery. At one time it was thought that they produce a specific lesion by means of basic bodies allied to the vegetable alkaloids, but differing from them in chemical composition and

reactions, to which the name "ptomaines" was given, and which were carefully investigated by Brieger. When Hankin discovered an albumose amongst the metabolic products of anthrax bacilli, the ptomaines were regarded with suspicion, and toxalbumins in the form of albumoses, peptones, globulins, separated from artificial cultures of pathogenic bacteria, and pronounced to be the true toxins. The fact that in snake venom and some vegetable poisons, such as abrin and ricin, similar toxalbumins were obtained, lent still further interest to the whole question, and our path seemed perfectly clear. Duclaux, of Paris, at all times raised objections of great weight against this conception of toxalbumins, and the recent works of Buchner, Sidney Martin, and others tend to show that the toxins of most pathogenic micro-organisms are ferment-like bodies, not reacting as ordinary albumoses, peptones, globulins, or albumins when the germs are grown in non-albuminous substances.

Dr. Jørgensen's work discusses the phenomena of alcoholic fermentation only and especially as applied to the brewing of beer, and does not give a general account of fermentation in all its aspects, physiological or pathological, as we had hoped from the title of the book. The Danish savant is, however, hardly responsible for the slight disappointment which we experienced on finding that the scope of the book, which numbers over 250 pages, is limited to alcoholic fermentation, for the German word "Gährung" is generally used to signify this special kind of fermentation. Though this book appeals in the first instance to scientific brewers, and none the less to practical ones, it contains much of special interest to the biologist, bacteriologist, and chemist. The greatest merit is the collection and summary of Hansen's work on yeasts, and we must be grateful to the translators for having given us the results of the patient and laborious investigations made at the Carlsberg Laboratory in an English rendering. Hansen cleared the hopeless confusion existing regarding the saccharomycetes by finding methods for obtaining pure cultures and separating and distinguishing various allied forms which, though hitherto included under the same name, were mere impurities. He rendered a great service to botany and biology by giving an accurate description of the sporulation of these organisms, their various forms of spores, and their germination, facts which enabled him to differentiate between various groups of saccharomycetes. Amongst the latter only organisms are found capable of rapidly and vigorously fermenting maltose, and the yeasts for breweries and distilleries must therefore be sought among them, and a suitable species must always be selected for each particular kind of beer. Hansen studied also and discovered groups of wild yeasts which produce diseases in beer, such as bitter taste and turbidity, and he showed that these unwelcome guests are capable of doing harm only when introduced into the wort at the commencement of fermentation. He has also pointed out ways and means to avoid and prevent disease in beer. Dr. Jørgensen carefully describes the various species and varieties of saccharomycetes and torulæ, and a point of special interest is the tendency of many among them to form mycelia or pro-mycelia, a tendency which by Klein and others has also been observed in schizomycetes, such as diphtheria, tubercle, and

anthrax bacilli. For industrial purposes absolutely pure and carefully selected yeast cultures should be used for brewing. This is already done by many breweries on the continent and in America. In England, however, we are slow in applying scientific research to industrial pursuits, and though a number of breweries already use Hansen's system, it can hardly be said that it has received the attention it deserves, and chance, tradition, and blind empiricism still govern too much the manufacture of beer in England. As Prof. P. Frankland says: "Scientific accuracy and the certainty of success can only be introduced into the industry of brewing with a due appreciation of these brilliant researches."

Dr. Jørgensen has treated his subject in a thoroughly scientific and withal clear and concise manner, which suffers but little, if at all, from the translation. To brewers and those interested in the mycotic chemistry of brewing, the book will be welcome, and to those who are not able to read the works of Hansen in the language in which they have been written, it will be invaluable. We hope that this work will assist in banishing empiricism from the English systems of beer fermentation. The general application of Hansen's method is merely a question of time.

A. A. KANTHACK.

#### OUR BOOK SHELF.

*A Year amongst the Persians. Impressions as to the Life, Character, and Thought of the People of Persia, received during twelve months' residence in that country in the years 1887-8.* By Edward G. Browne, M.A., M.B., Lecturer in Persian to the University of Cambridge (London: A and C. Black, 1893.)

MR. BROWNE'S studies lie in the realms of metaphysics and linguistics, subjects which appeal readily to the cultured Persians of the cities. Hence he has obtained more insight into the intellectual side of Persian life than falls to the lot of most foreigners visiting the Shah's dominions. His sympathies are wide, and his tact considerable, for he succeeded in winning the confidence of the persecuted Bâbis and down-trodden *Guebres* of Shiraz and Yezd without incurring the enmity of the official classes. The story of these people and their beliefs is admirably told, but from its nature it lies outside the scope of critical consideration in this journal. Amongst the *Guebres* or Zoroastrians of Yezd Mr. Browne recognised the most perfect representatives of the ancient Persian race, the physical type being kept pure by the unceasing persecution to which the sect has been subjected since the commencement of Mohammedan supremacy. These people are in constant communication with their kinsmen the well-to-do Parsis of Bombay, who occasionally revisit the country of their origin. The glimpses of the habits and customs of Persian life and thought are singularly vivid, and although the author rather avoids mere topographical detail, his brief sketches of the cities in which he sojourned are powerfully drawn and strikingly accurate. The great want of the country appears to be irrigation, which is carried on at present very partially and in a wasteful manner. Near Kashan a stream was found carefully dammed at intervals to cause the water to overflow the bank and trickle into the channel below heavily charged with mud, the reason assigned being that muddy water evaporates less rapidly than clear.

While the book is generally free from error, we note a slip, hardly to be expected of a Cambridge graduate, on p. 463, where he speaks of a hole a yard square, when the

obvious meaning is a yard cube. This obscures the point of a very good story in which mathematical and legal reasoning are shown to differ in their results. There are some curious stories of magic which would have repaid fuller investigation.

*Nature Pictures for Little People.* By W. Mawer, and others. (London: The Sunday School Association.

SOME parts of this book are very good; others impress us much less favourably. In order to test whether the little people for whom the book is intended were interested in its contents, we gave it to a few average boys to read, and found that their verdict was the same as that expressed above. The authors frequently assume that their young readers are familiar with things not commonly seen, and with expressions not usually found in children's reading-books. For instance, one section of the book is headed *Ἀπὸ τῆς θάλασσης* and begins with the sentence, "Rara avis in terris indeed!" This is very well in its way, but is out of place in a book of this character. Also, the numerous small witticisms and puns do not add to the interest or value of the descriptions. "You will wonder," we find in an account of whales "notwithstanding all you have read, how the big whale in the picture was drawn out of the sea and placed upon that rock. I have an opinion of my own upon the subject, and will confide it to you: the artist *drew* him up there." The following specimen is also unattractive, if not misleading. "When collecting those tiny shells which you find ready perforated for threading into necklaces, do you wonder *why* they are so perforated? If so, let me tell you. The little creature which lives in the shell is the favourite food of those bigger ones which have been introduced to you as Roaring Buckies—namely, whelks, as well as purples: and to get out the sweet morsel—oh! so sweet—with their tongues (or what you may call their tongues) they file out the little round hole, and then—oh!" There is much brilliant writing of this character, the style being after that in Kingsley's "Water Babies," and a very long way after. In our opinion, however, the best parts are those *not* containing composition of the kind quoted. Several excellent illustrations, and two or three simply-worded and interesting sections, are the book's only redeeming features.

LETTERS TO THE EDITOR.

[The Editor does not hold himself responsible for opinions expressed by his correspondents. Neither can he undertake to return, or to correspond with the writers of, rejected manuscripts intended for this or any other part of NATURE. No notice is taken of anonymous communications.]

The Foundations of Dynamics.

DYNAMICAL investigations are often made to depend upon the following three propositions, viz., the principle of linear momentum, the principle of angular momentum, and the principle of energy. In treatises which are concerned with ordinary mechanical systems, such as rigid bodies, elastic solids and frictionless fluids, the word energy is generally employed in the restricted sense of mechanical energy, and is confined to two particular species, viz. kinetic energy arising from such motions of the system as can be controlled by ordinary mechanical agencies, and potential energy arising from the configuration of the system or from its position in space. All other forms of energy, such as molecular kinetic energy arising from the production of heat by friction, and chemical potential energy contained in fuel, explosive compounds, &c., are excluded from consideration. In systems of this kind the sum of the kinetic and potential energies is an invariable quantity, and this proposition may be termed the principle of the conservation of mechanical energy.

It is important to recollect that the principle of momentum is a proposition of a wider character than the principle of the

conservation of mechanical energy, for the former proposition is true when the system possesses viscosity or internal friction which gives rise to a conversion of mechanical energy into heat. From this fact it follows that the principles of momentum and energy cannot be regarded as axiomatic, but depend upon certain propositions of a more fundamental character, which ought to be capable of explaining why it is that the principle of momentum is true in the case of viscous systems, whilst the principle of the conservation of mechanical energy does not hold good.

In order to examine this question we shall start with Newton's three Laws of Motion, which will be regarded as fundamental axioms, and shall first inquire how far they will carry us; and we shall find that when we consider the motion of masses of matter of finite size, Newton's Laws are not sufficient to enable us to determine the motion unless the matter is in the ideal state of a frictionless or perfect fluid. In all other cases an additional hypothesis is necessary.

To clear the ground, it may be well to point out that the parallelogram of forces is a direct consequence of Newton's second law, and that the parallelogram of couples is a consequence of the parallelogram of forces; whence all the propositions relating to the composition of forces and couples, including the one which enables any system of forces and couples to be compounded into a wrench, are deductions from the second law.

There are two methods of investigating the motion of a mass of matter of finite size. In the first place, we may suppose the matter to consist of very small discrete masses under the influence of molecular forces, together with bodily forces, such as gravity and the like; in the second place, we may regard the mass as a continuous one which may be subdivided into small differential elements of volume. We shall consider the subject from the first point of view.

Let  $m_1, m_2$  be the masses of any two elements  $(x_1, y_1, z_1), (x_2, y_2, z_2)$ , their co-ordinates referred to fixed axes; let  $R_{12}$  be the molecular force of  $m_2$  on  $m_1, R_{21}$  of  $m_1$  on  $m_2$ ; also let  $F_1$  be the bodily force acting on  $m_1$ .

By Newton's second law, the forces  $R_{12}, F_1$  may be resolved into components  $f_{12}, g_{12}, h_{12}$ , and  $X_1, Y_1, Z_1$  parallel to the axes; also by the same law, the equations of motion of the elements are

$$m_1 \ddot{x}_1 = X_1 + f_{12} + f_{13} + \dots \quad (1)$$

$$m_2 \ddot{x}_2 = X_2 + f_{21} + f_{23} + \dots \quad (2)$$

It follows from Newton's third law that the molecular force of  $m_2$  on  $m_1$  is equal in magnitude and opposite in direction to that of  $m_1$  on  $m_2$ ; whence  $f_{12} = -f_{21}$ , &c. Accordingly, if we add the system of equations (1) it follows that all the molecular forces disappear, and we obtain

$$\Sigma m \ddot{x} = \Sigma (X) \quad (3)$$

Equation (3) is the analytical expression for the principle of linear momentum, and from the above investigation it follows that this principle is a direct consequence of the second and third laws.

Since the equations of motion of a perfect fluid can be deduced from the above principle, it follows that the whole theory of the hydrodynamics of frictionless fluids depends solely on Newton's second and third laws.

We must next consider the principle of angular momentum. From (1) and (2) we obtain

$$\Sigma m(x\ddot{y} - y\ddot{x}) = \Sigma(xY - yX) + g_{12}x_1 + g_{21}x_2 - f_{12}y_1 - f_{21}y_2 + \dots \quad (4)$$

By the third law the last four terms may be written

$$f_{12}(y_2 - y_1) - g_{12}(x_2 - x_1) \dots \quad (5)$$

which represents one of the components of the couple due to the mutual action of  $m_1$  and  $m_2$ .

Now Newton's third law states that the action of  $m_1$  on  $m_2$  is equal and opposite to that of  $m_2$  on  $m_1$ ; but it makes no assertion to the effect that the mutual action consists of a force acting along the line joining them. An assumption of this kind would limit the generality of the law, and would be one of a somewhat doubtful character, for in viscous systems there are grounds for thinking that this mutual action may consist in part

of a force perpendicular to the line joining two elements. If in any particular case the mutual force between two elements *did* act along the line joining them, all the expressions of the form (5) would vanish; but the point to which I particularly wish to call attention is that the *principle of angular momentum cannot be deduced from Newton's laws, but a further hypothesis is necessary.*

We have not yet considered Newton's first law, and if we discard the hypothesis that the mutual action between two elements consists of a force acting along the line joining them, the next step is to inquire whether the first law will assist us. We have already pointed out that all the molecular forces <sup>1</sup> may be compounded into a wrench. Now Newton's first law asserts, in effect, that when the mass is at rest or is moving uniformly in a straight line, this wrench is zero; but the first law is limited to these two cases, and asserts nothing with regard to what happens when the mass possesses *acceleration*, and it is easy to see that when the mass is in either of the states contemplated by Newton's first law, the molecular forces are not the same as when it is in other states. For example, the molecular forces exerted across any section of a pendulum rod, which is oscillating, are not the same as when the rod is held at rest in any of the positions which it assumes during its motion. Newton's first law does not therefore help us. We have, however, proved by Newton's second and third laws that the *force* constituent of the wrench due to molecular forces is zero; and if we assume that the *couple* constituent is also zero, the sum of all such terms as (5) will vanish, and (4) becomes

$$\Sigma m(x\ddot{y} - y\ddot{x}) = \Sigma(x\dot{Y} - y\dot{X}) \dots \dots (6)$$

which is the analytical expression for the principle of angular momentum.

The latter principle may therefore be deduced from Newton's laws with the aid of one or other of the following additional hypotheses, viz. :—

(a) *The molecular action between two elements consists of a force acting along the line joining them.* Or,

(b) *The resultant couple due to molecular action is zero, whether the mass of matter be at rest or in motion.*

We must lastly consider the principle of energy.

Assuming that the bodily forces have a potential, we easily deduce from (1) and (2)—

$$\frac{1}{2} \frac{d}{dt} \Sigma m(\dot{x}^2 + \dot{y}^2 + \dot{z}^2) + \frac{dV}{dt} = (f_{12} + f_{13} + \dots)\dot{x}_1 + (g_{12} + g_{13} + \dots)\dot{y}_1 + \dots + (f_{21} + f_{23} + \dots)\dot{x}_2 + \dots \dots (7)$$

whence if T denote the kinetic energy, and F denote the right-hand side of (7) the equation becomes

$$\frac{dT}{dt} + \frac{dV}{dt} = F. \dots \dots (8)$$

The function F is an unknown quantity which it is impossible to determine without making some special hypothesis respecting the constitution of matter or the law of molecular force. We shall presently show that F is zero when the matter is rigid. In the case of a viscous liquid it can be shown by means of the general equations (which depend upon the principles of linear and angular momenta, combined with a certain hypothesis concerning molecular action) that F is the dissipation function; whilst, in the case of an elastic solid it can similarly be shown that - F represents the time variation of the potential energy due to strain. That F is zero when the matter consists of a rigid body can be proved as follows:—Let  $\omega_1, \omega_2, \omega_3$  be its component angular velocities about the axes; then

$$\dot{x}_2 = \dot{x}_1 - (y_2 - y_1)\omega_3 + (z_2 - z_1)\omega_2$$

and the terms in F depending on the mutual action of  $m_1$  and  $m_2$  become

$$(f_{12} + f_{21})\dot{x}_1 - f_{21}(y_2 - y_1)\omega_3 + f_{21}(z_2 - z_1)\omega_2 + \text{similar terms in } g \text{ and } h.$$

This may be written—

$$(f_{12} + f_{21})\dot{x}_1 - \omega_3\{f_{21}(y_2 - y_1) - g_{21}(z_2 - z_1)\} - \dots$$

<sup>1</sup> It seems hardly necessary to suppose that the mutual action between two elements consists of a *couple* as well as a force; for even in the case of magnetized matter, we may regard each element as the limit of a pair of positive and negative ones which are rigidly connected together, and we may deduce the theorem that the mutual action between two magnetic elements consists of a couple by considering the forces between each pair of simple elements.

By the third law  $f_{12} + f_{21} = 0$ , and also by either of the subsidiary hypotheses (a) or (b) all the expressions of the form

$$\omega_3\{f_{21}(y_2 - y_1) - g_{21}(z_2 - z_1)\}$$

vanish; whence  $F = 0$ , and (8) becomes

$$T + V = \text{const.},$$

which is the analytical form of the principle of the conservation of mechanical energy. A. B. BASSET.

The Artificial Formation of the Diamond.

WITH your kind permission I wish to make a few observations on Prof. Joly's interesting letter in your issue of March 22, in which he concludes from a consideration of the curve representing the expansion of diamond by heat that "the diamond is a form of carbon which has been subjected to high pressure when crystallising," and in which he remarks that these theoretical considerations gave rise to experiments which he only laid aside finally upon hearing of M. Moissan's success. He also says: "M. Moissan has shown that the *added condition* of high pressure has rendered a method previously unsuccessful *now for the first time successful*." (The italics are mine.) Prof. Joly here makes a claim for M. Moissan which I must say, in justice to that gentleman, he has never made for himself.

If Prof. Joly will kindly turn to my paper on the "Artificial Formation of the Diamond," in the *Proceedings* of the Royal Society, No. 204, 1880, he will find that pressure is *not* an "added condition," and that M. Moissan has *not* "rendered a method hitherto unsuccessful for the first time successful."

Further, he will find that his theoretical deductions were practically demonstrated by me fourteen years ago, and I then described experiments showing that carbon, set free by metals under great pressure, was denser and harder the higher the pressure, and my experiments culminated in the preparation of minute quantities of carbon identical in hardness, density, and action on polarised light with natural diamond.

M. Moissan has done no more, but he has devised a process of great ingenuity which does not entail the danger and expense of mine, and which can be repeated with much greater chance of success.

If Prof. Joly will turn to my paper, he will find that, like Moissan, I obtained my diamond in conjunction with a fused mass containing iron, and fused under extreme pressure. Again, in the *Proceedings* of the Royal Society, of June 14, 1888, he will find that the Hon. C. A. Parsons there describes experiments which produced true diamond (thoroughly corroborated since the publication of his paper), and he proved conclusively that pressure is absolutely essential; and as his method is one which lends itself to the treatment of carbon in quantity at the necessary temperature and at any pressure, it is of much greater practical importance than Moissan's method.

I have the highest admiration of Moissan's work, not only with his electric furnace, but in the several fields; in which he has distinguished himself; and as he has courteously admitted that I was the first to define the conditions and actually prepare artificial diamond, I feel constrained to point out that both Parsons and I had fully enunciated the conditions which Prof. Joly attributes to Moissan.

I quite agree with Prof. Joly's concluding paragraph, and my researches led me about a year ago to the construction of an apparatus capable of producing pressures up to forty tons on the square inch, in which I have good hopes of being able to melt carbon in quantity and produce diamond by fusion instead of solution.

Carbon, at ordinary pressures, passes directly from the solid to the gaseous state, and only under enormous pressure can it be made to pass through the liquid state.

It would be premature for me to say more at present, but I hope you will kindly allow me to put these facts on record, as they seem to have been forgotten even by those who are working in the field. J. B. HANNAY.

Cove Castle, Loch Long, N.B., March 26.

I WAS in hopes that the limited claim for priority which I made for M. Moissan would have secured me from controversy as to the claims of previous workers. Although well acquainted with the paper to which Mr. Hannay refers me, I had never derived from it the idea that Mr. Hannay attributed his results to the crystallisation of carbon out of a metal.

While I regret having incorrectly inferred Mr. Hannay's claims, readers of the paper to which he refers will, I think, perceive that the error was not without some justification.  
Trinity College, Dublin. J. JOLY.

#### The New Comet.

THE comet discovered here on March 26 was re-observed on the 27th, 28th, 29th, 30th, 31st, and April 1st, 2nd, and 3rd, and its places on four nights were determined as follows:—

| 1894     | G. M. T.  | R. A.     |          |         | Decl. |
|----------|-----------|-----------|----------|---------|-------|
|          |           | h. m.     | h. m. s. |         |       |
| March 26 | ... 9 30  | ... 9 54  | 37       | ... +32 | 13    |
| 27       | ... 10 30 | ... 9 58  | 32       | ... +31 | 38    |
| 30       | ... 9 50  | ... 10 9  | 12       | ... +30 | 1     |
| 31       | ... 11 15 | ... 10 12 | 48       | ... +29 | 27    |

The motion is becoming slower, whence it may be inferred that the perihelion passage occurred some time ago.

The comet is small and faint, with a stellar nucleus of about 12th magnitude and a short fan-shaped tail. It was discovered with a 10 inch reflector and comet eyepiece magnifying thirty times. To my eye the comet is now decidedly more obvious than it was when first seen, but this may either be due to more favourable atmosphere, or to the fact that greater familiarity with an object is apt to render it plainer.

Bristol, April 4.

W. F. DENNING.

#### Sun-spot Phenomena and Thunderstorms.

A SMALL portion of that most interesting field of research again dealt with in NATURE (vol. xlix. p. 503), perhaps requires to be trodden with caution. Of course all *a priori* reasoning as to probabilities of a connection between solar physics and the occurrence of thunderstorms may be laid aside, and it does not seem that writers on the subject have fallen into that kind of anti-scientific error. At the same time, we readily admit that a connection between solar activity and thunderstorm phenomena exists. But having devoted a little time to the consideration of the question, I may be permitted to make a remark. In the first place, so far as our observations at present extend, it is quite impossible to find a distinct relation of time between prevalence of thunderstorms over our planet and solar periodicities. In the second place, thunderstorms have been classified, and much require further classification (to which, by the way, I am just about to contribute a few results of study). Artificial or conventional classification would by no means be an object of pursuit to Dr. Veeder. Natural classification does not seem to bring us now at all near to the connection which we might anticipate. In fact, it seems to me that in reference to the thunderstorms mentioned in NATURE for March 29, 1894, natural classification leads us away from the connection.

April 2.

W. CLEMENT LEY.

#### A Lecture Experiment.

THE following experiment, to illustrate the anomalous contraction and expansion of water due to decrease of temperature, I have found to be very striking:—

A large test tube is fitted with a cork, through which a glass tube passes just far enough to allow a rubber tube to be attached. The rubber tube should be long enough to reach to the bottom of the test tube. Close the lower end of the rubber tube, and fill it and the glass tube with mercury up to a little above the top of the cork. Fill the test tube with water, insert the rubber tube, and cork and press the latter firmly in place, taking care that no air-bubbles are imprisoned between it and the water. The pressure of the cork against the surface of the water will cause the mercury to rise in the glass tube. Place the apparatus thus prepared into a freezing mixture of ice and salt. The mercury will fall slowly in the tube until the water has attained its maximum density, remain stationary for a moment, then rise on the further cooling of the water, and at the instant of freezing will make a rapid movement upward.

Armour Institute, Chicago, U.S.A.

J. C. FOYE.

#### Centipedes and their Young.

THE members of the Trinidad Field Naturalists' Club will be glad if any of your correspondents can throw additional

NO. 1275, VOL. 49]

light upon the following facts in the history of centipedes, which have recently come under their notice:—

On September 17, 1892, Mr. Charles Libert, of this town, sent to Mr. R. R. Mole a centipede (*Scolopendra prasina*) which enclosed in a circle formed of the fore part of its body a circular mass of young centipedes about the size of a half-penny, and about quarter of an inch thick. The young ones were quite white. The old centipede was very vicious. The centipede and the young ones were exhibited at a conversazione of the Victoria Institute the same evening. The old centipede did not alter her position at all, and on the 21st was packed up for transmission to the Gardens of the Zoological Society, London. Dr. Sclater wrote, on October 27, to Mr. Mole stating that the centipede was dead on arrival, and only one young one could be found in the box. Mr. Libert informs me that he has once or twice found young centipedes clinging to various parts of the body of an adult. Mr. T. D. A. Cockerell (late of Jamaica), of whom inquiries were made, said this habit was new to him.

At a meeting of the Trinidad Field Naturalists' Club on July 7, 1893, the President (Mr. Caracciolo) exhibited a sketch of a centipede carrying its young between the legs of the anterior twelve segments of its body. He stated that he received the centipede, from which the sketch was made, from Mr. Guiseppi on June 20. The creature protected her young in this manner until June 25, when she altered her position, and lay flat over them. On June 30 she left them, "but kept an eye on them." When undisturbed the young centipedes formed a heap, in which they remained for four days. They then gradually began wandering away from the heap, one by one, in search of food. There were about 140 young ones altogether.

At the meeting of the Club on February 2, 1894, Mr. Potter said he had been told by Mr. S. W. Knaggs that he had recently found a centipede coiled up spirally on itself. On attempting to uncoil it a number of pellets of small size fell from its under-surface. These bore the appearance of eggs. He subsequently found others clasped by the numerous legs against the creature's under-surface. The pellets, or eggs, were situated all along the under-surface of the body, and dropped from it on its being uncoiled.

Several text-books and works on natural history have been consulted with the view of finding out more about this interesting habit, but without success; and in most books it is stated that centipedes lay their eggs under dead leaves, or in a dark corner, and manifest no further concern about them.

F. W. URICH.

Port of Spain, Trinidad, B. W. I., March 6.

#### PROF. IRA REMSEN ON CHEMICAL LABORATORIES.<sup>1</sup>

ON January 1 the Kent Chemical Laboratory was dedicated with appropriate exercises. The beautiful building was thrown open to inspection, and many passed through its rooms expressing admiration. Its plans were explained and a general account was given of the uses to which it is to be put. Honour, "as is most justly due," was paid to the generous donor, whose name from this day forth will be intimately associated with progress in chemistry in this country. The exercises of yesterday have led by an easy step to those of today, and a chemist is called upon to give the Convocation address. What theme more natural to him, or more appropriate, than "The Chemical Laboratory?" It is to this theme that I ask your attention. My purpose is to treat the chemical laboratory, not from the material point of view, but in its broader aspects, as far as I may find this possible. I shall attempt to answer briefly three questions, and these are:—

(1) When and how did chemical laboratories come to be established in universities?

(2) What part have chemical laboratories played in the advancement of knowledge?

<sup>1</sup> Address delivered by Prof. Ira Remsen on January 2, 1894, in connection with the opening of the Kent Chemical Laboratory of the University of Chicago, U.S.A.

(3) What are the legitimate uses of the chemical laboratory of a university at the present time in this country?

The first laboratory ever erected for the teaching of chemistry—indeed, the first laboratory for teaching any branch—was that of the University of Giessen, Germany, which owed its existence to the enthusiasm of Liebig. The story is an interesting one, and especially instructive on an occasion such as this. Liebig was born in the year 1803. According to his own account, he had a hard time of it in the schools. He says: "My position at school was very deplorable; I had no ear-memory, and retained nothing or very little of what is learned through this sense. I found myself in the most uncomfortable position in which a boy could possibly be; languages and everything that is acquired by their means, that gains praise and honour in the school, were out of my reach; and when the venerable rector of the gymnasium, on one occasion of his examination of my class, came to me and made a most cutting remonstrance with me for my want of diligence—how I was the plague of my teacher and the sorrow of my parents, and what did I think was to become of me—and I answered him that I would be a chemist, the whole school and the good old man himself broke into an uncontrollable fit of laughter, for no one at that time had any idea that chemistry was a thing that could be studied."

This was truly an unpropitious beginning, yet this butt of his school was soon contributing more to the development of chemistry than any one ever had before or than any one ever has since. Filled with the determination to study chemical things and phenomena, he left the school where he had been such a failure, and entered an apothecary shop, but at the end of ten months the proprietor was so tired of him that he sent him back to his father. As Liebig said, he wanted to be a chemist, not a druggist. He must have been about fifteen years of age when, in spite of his inadequate preparation in languages, he was received as a student in the University of Bonn, and from here a little later he went to Erlangen. But he appears not to have been much better satisfied at the university than he was in the apothecary shop. He speaks almost with contempt of the teachers under whom he studied. "It was then a very wretched time for chemistry in Germany," he says. "At most of the universities there was no special chair of chemistry; it was generally handed over to the Professor of Medicine, who taught it, as much as he knew of it—and that was little enough—along with the branches of toxicology, pharmacology, materia medica, practical medicine, and pharmacy." Referring to the equipment of the universities for the teaching of chemistry, he says: "I remember, at a much later period, Prof. Wurzer, who had the chair of chemistry at Marburg, showing me a wooden table-drawer, which had the property of producing quicksilver every three months. He possessed an apparatus which mainly consisted of a long clay pipe-stem, with which he converted oxygen into nitrogen by making the porous pipe-stem red-hot in charcoal, and passing oxygen through it. Chemical laboratories, in which instruction in chemical analysis was imparted, existed nowhere at that time. What passed by that name were more like kitchens fitted with all sorts of furnaces and utensils for the carrying out of metallurgical or pharmaceutical processes. No one really understood how to teach it."

After a comparatively short sojourn in Erlangen, Liebig returned home fully persuaded that he could not attain his ends in Germany. Some of the young men of that time had gone to Stockholm to study chemistry, attracted thither by the fame of the great Berzelius. But Liebig decided in favour of Paris. He was then seventeen and a half years old, and, as we have seen, he could not have been well prepared in chemistry, yet in a short time after his arrival, he made such an impression on Alexander von Humboldt that he was admitted to the labora-

tory of one of the most brilliant chemists of the day, Gay-Lussac. He had previously begun an investigation on certain fulminating compounds to which his attention was first directed in a curious way at his home in Darmstadt.

Let me again use his own words: "In the market at Darmstadt I watched how a peripatetic dealer in odds and ends made fulminating silver for his pea-crackers. I observed the red vapours which were formed when he dissolved his silver, and that he added to it nitric acid, and then a liquid which smelt of brandy, and with which he cleaned dirty collars for the people." Gay-Lussac gladly joined him in the investigation, and he gratefully refers to this opportunity. He acknowledges that the foundation of all his later work was laid in Gay-Lussac's laboratory.

And now to the main point. When Liebig was in his twenty-first year he received an appointment to a professorship of chemistry at Giessen through the influence of von Humboldt. His opportunity had come. He determined to have a laboratory for teaching. The great advantages he had reaped from his contact with Gay-Lussac showed him clearly that if students were to study chemistry at all it must be in a well-equipped laboratory in contact with a teacher. And so the first laboratory was built, and became one of the great forces of the world. Soon students flocked to the little university from all parts of the civilised world, and the most flourishing and powerful school of chemistry that has ever existed was rapidly developed. One of the most brilliant pupils of this school, the late Prof. Hofmann, of Berlin, in speaking of its influence, says: "The foundation of this school forms an epoch in the history of chemical science. It was here that experimental instruction such as now prevails in our laboratories received its earliest form and fashion; and if, at the present moment, we are proud of the magnificent temples raised to chemical science in all our schools and universities, let it never be forgotten that they all owe their origin to the prototype set up by Liebig." The foundation of this school marked an epoch not only in the history of chemical science but in the history of science. The great success of this laboratory led naturally to the building of others, and in a comparatively few years a chemical laboratory, at least, came to be regarded as essential to every university. At first these were of necessity modest affairs. One of the earliest was that at Tübingen, in regard to which a curious fact may be mentioned. It appears that the ground available for Liebig's laboratory in Giessen was not altogether well adapted to its purpose, and in consequence, one of the larger working-rooms received light from only one side. When the laboratory of Tübingen was built later, that at Giessen was copied in every detail even to the dark room, notwithstanding the fact that there were no buildings in the immediate neighbourhood, and light in abundance was available.

As time passed, the era of the palatial laboratory was introduced. Probably we shall be very near the truth if we fix the responsibility of this era upon Bonn. Hofmann was called to Bonn from England, whither he had gone under the most flattering conditions, and, before accepting the new call, he had, no doubt, received promises with reference to a laboratory. At all events, a building was erected, much finer than anything in the way of a laboratory that had ever appeared. As is customary in Germany, the professor's dwelling-rooms were in the building, and so beautiful were all the arrangements, that when the King of Prussia passed through at the time of the formal opening, he is said to have remarked, "I should like to live here myself." Soon after this Hofmann built the laboratory at Berlin, and again magnificence was the order of the day. Statues and carvings, and tiles and frescoes, took their place in the laboratory, and since then in Germany and France and Austria and Switzerland immense sums have been expended in the erection not only of chemical



but of physical, and physiological, and petrographical, and anatomical, and pharmacological, and geological laboratories. While of late years there has perhaps been a reaction, and a tendency to somewhat simpler buildings than those that at one time were the fashion, it is still true that the laboratories are semi-palatial, and a strict economist might find ground for complaint, claiming that results as good might have been obtained at smaller cost. It would hardly be profitable to discuss this point here. In this country we cannot be said in general to have been extravagant in building laboratories; certainly not, if we keep the European standard in mind. Most of the larger laboratories in this country are modest in their fittings, and the strictest economist could hardly find fault.

If we had the power to estimate the value of the work that has been done for the world by the scientific laboratories, it is certain that the money spent for them, however great the sum may be, would appear to us ridiculously small. The scientific method, as it is called, has been spread among men, and has changed the whole aspect of things. The influence of the laboratory is felt in every branch of knowledge. The methods of investigation have changed, and everywhere the scientific method has been adopted. Who can tell what an enormous influence this has already had upon the thoughts and actions of men, and what still greater influence is to be exerted? The laboratory has impressed upon the world the truth that in order to learn about anything it will not suffice to stand aloof and speculate, and that it is necessary to come into as close contact with that thing as possible. When the old philosopher wished to solve a problem, his method was to sit down and think about it. He relied upon the workings of his brain to frame a theory, and beautiful theories were undoubtedly framed, and many of these, probably all of those which had reference to natural phenomena, were far in advance of facts known, and often directly opposed to facts discovered later. Minds were not hampered by facts, and theories grew apace. The age was one of mental operations. A beautiful thought was evidently regarded as something much superior to knowledge. We have not learned to think less of beautiful thoughts or of mental processes, but we have learned to think more of facts, and to let our beautiful thoughts be guided by them.

And how did this come about? It is curious that the scientific method of work, which is altogether the simplest, should be the last to be adopted by the world as it is by individuals. It would be impossible to determine all the causes that have led to this result, but one of the immediate causes is undoubtedly to be found in the fact that, at an early period in the history of the world, those who worked with their hands came to be looked upon as inferior to those who worked with their heads alone. This operated powerfully to keep those who were best fitted to advance knowledge, from adopting the simplest method, viz. that of studying things. One who engaged in experiment did it surreptitiously, or lost caste.

Probably the most powerful force that first led men to experiment systematically was the conception of the philosopher's stone, and out of the labours of the alchemists sprang experimental science. Strange as it may seem, it was the love of gold that led to the development of scientific methods of investigation. In some way, probably through superficial observations, men came early to think it possible that the ordinary or base metals could be transformed into gold, and with this idea came the desire to experiment on the subject, and the experiments on this subject have been kept up until the present century. So that in one sense, certainly, it is not true that "the love of money is the root of all evil." While much folly was com-

mitted in the name of alchemy—as much folly is committed to-day in the name of chemistry, and of medicine, and of other lines of work—it is clear that the true alchemist was as ardent a worker as the world has perhaps ever seen; he was engaged in experimenting. He was teaching the world that the way to a correct knowledge of nature lies not in philosophy alone but through coming in contact with the things of nature, and becoming personally acquainted with them. Paracelsus speaks of the alchemists of his time thus: "They are not given to idleness, nor go in a proud habit, or plush or velvet garments, often showing their rings upon their fingers, or wearing swords with silver hilts by their sides, or fine and gay gloves upon their hands, but diligently follow their labours, sweating whole days and nights by their furnaces. They do not spend their time abroad for recreation, but take delight in their laboratory. They wear leather garments with a pouch, and an apron wherewith they wipe their hands. They put their fingers among coals, and into clay, not into gold rings. They are sooty and black like smiths and colliers, and do not pride themselves upon clean and beautiful faces."

This is certainly the picture of a hard worker, and as such we must look upon the alchemist. The work done by the alchemists was chemical work. It was allied very closely to the work done by chemists now-a-days. They hoped to find the philosopher's stone among chemical substances, and the transformation they hoped for was to be accomplished by a chemical method. They consequently devoted themselves to careful study of all known chemical substances, and in further studying the action of these substances upon one another they came into possession of new facts. There can be no doubt that we owe to the alchemists not only the foundation of chemistry, but the foundation of experimental science. In our superior way we smile at their futile labours to discover the philosopher's stone, but the tremendous results reached by them must not be lost sight of. The theory of the philosopher's stone was shown to be a false theory; but what of that? Probably many of the theories now held are false, but they are none the less valuable. An idea is of value if it leads to active work. Working hypotheses are the stepping-stones of intellectual progress. The philosopher's stone was more than a stepping-stone—it was a magnificent bridge. "Any idea," says Liebig, "which stimulates men to work, excites the perceptive faculty, and brings perseverance, is a gain for science, for it is work that leads to discoveries. The most lively imagination, the most profound wisdom, is not capable of suggesting a thought which could have acted more powerfully and lastingly upon the mind and powers of man than did the idea of the philosopher's stone. Without this idea chemistry could not exist to-day in its present perfection."

Let us now turn from the past to the present, and inquire, What is the province of a chemical laboratory in a university in this country? The first chemical laboratories had for their sole object the training of chemists, and consequently, the methods adopted in them were adapted to this end alone. Afterwards, and indeed only quite recently, the importance of laboratory training in chemistry for those looking forward to the study of medicine came to be recognised: and, still later, the idea that such training might be made a valuable part of a general education appeared. At present, then, a chemical laboratory is called upon to furnish opportunities (1) for the general student who does not expect to become either a technical chemist or a teacher of chemistry; (2) for the medical student; (3) for him who expects to devote himself to the practice of chemistry, either in a chemical factory or in an analytical

laboratory; and (4) for him who is to devote his life to teaching and investigation. In addition to furnishing these opportunities, it should also be a place in which investigation is constantly carried on by the teachers and advanced students.

As regards the teaching of chemistry to general students much might be said, but it will be possible to touch upon only a few points on this occasion. Most of the teaching is of this kind, and the subject is under active discussion. There can be no question that much of the work done in schools and colleges is highly unsatisfactory, many of the courses which are called scientific are most unscientific, and the student is often more harmed than benefited by his work. If a course in a science, whatever that science may be, does not tend in some degree to develop a scientific habit of mind in the student, it is not serving its legitimate purpose. If the experience of twenty-one years in teaching in college and university in this country is worth anything, your speaker, who has during that time had to deal with many students from all parts of the country, is justified in asserting that the minds of students who enter college are very far from being scientific, and the same can be said of most of those fresh from the colleges. By a scientific mind is meant one that tends to deal with questions objectively, to judge things on their merits, and that does not tend to prejudice every question by the aid of ideas formed independently of the things themselves. Perhaps an anecdote, though trivial, will make this clearer. In a book used by my classes for a number of years, there was one error that served as a simple test of the condition of the students' minds. In the directions for performing a certain experiment, the statement was made that a blue solution would result at one stage. As a matter of fact, the solution referred to was always a bright green. Each student being required to write out an accurate description of what he had seen, each one in turn for a series of years described the green solution as blue, disregarding the evidence of his senses, and accepting the evidence of the printed word as more reliable. Occasionally one would appear whose conscience was troubled by the discrepancy, and who would boldly assert that the book must be wrong, but the number of these exceptions was insignificant. Surely this tendency to disregard the evidence of the senses is one that in the great majority of cases can be overcome. It would be better if it did not exist at all, and it probably would not exist if our educational methods were what they should be. We need teachers properly trained for carrying on scientific courses in our schools and colleges, and one of the most important branches of work in a university is the training of such teachers. Many of the courses in the schools and colleges are at present too ambitious. The attempt is made in them to do in a small way just what is done in a large way in the most advanced courses in universities. Instead of being what they should be, school courses and college courses, they are reduced university courses. Young men who have had the advantages of advanced courses feel so plainly the benefits they have received, that they naturally wish their own students in turn, whatever their ages may be, to get the same benefits. But time will not permit further discussion of this topic, and the main object in referring to it at all is to make it clear that the university laboratory has a great field of work in connection with the improvement of methods of teaching chemistry.

The teaching of chemistry to medical students suggests a number of thoughts, but they are rather of a special character, and this branch of our subject may be passed over with the remark that there is practical agreement as to this point, that what the medical student most needs

at first is good scientific training, and that a course in general chemistry is well suited to this purpose. The most recently established medical schools require training in chemistry as one of the conditions of matriculation, and it is distinctly understood that it is chemistry, and not medical chemistry nor physiological chemistry, that is wanted.

The relation of the science of chemistry to the chemical industries is suggested by the next division of the subject. Here a most instructive object lesson was afforded during the past summer by a visit to the chemical exhibits in Jackson Park, where for the time being the products of the earth were concentrated. If you had had an intelligent chemical guide he would have pointed out many an interesting product from England, France, Russia, Italy, and this country, but his enthusiasm would have been reserved for the exhibit of the German chemical industries. He would have pointed out a great variety of beautiful and valuable products, and you would, I am sure, have carried away with you the conviction that the Germans excel the world in this line of work. The reason is not hard to find. It has often been discussed, but it would not be right to let this opportunity pass without again calling attention to it. Those who are familiar with the subject do not hesitate to acknowledge that the reason why the chemical industries have reached such a flourishing condition in Germany is that the pure science has been so assiduously cultivated. The value of pure science in the industries has long been recognised there, much more clearly than in any other country, and the scientific method has become established in the factories much to their advantage. Men deeply versed in pure chemistry, whose minds have been clarified by training in the university laboratories, are eagerly sought for in the factories. So thoroughly convinced are the Germans of the value of pure science for the industries that in the polytechnic schools, the plan of instruction in chemistry is essentially the same as in the universities, and some of the best purely scientific work is done in the laboratories of these polytechnic schools. We, in this country, have yet to learn the importance of this relation between science and industry, though undoubtedly some progress has been made in this line. We still endeavour to make iron and steel chemists, and soap chemists, and sugar chemists, and turn out hosts of raw products that are not worth their salt. Training along such narrow lines is a positive injury to the students. They are the victims of false pretences. Let the training be as broad as possible and as thorough as possible, and the student will at least not be crippled when he ought to be strengthened.

Finally, a few words in regard to what is commonly and properly spoken of as the highest work of the university laboratory—the training of teachers and investigators. Here, again, we find that Germany leads the world, and to her we must look for guidance; and, as is well known, to her we have looked for guidance for many years past. Just as Liebig betook himself to Paris, and Wöhler to Stockholm, so in turn Americans have betaken themselves to Germany to work with the great masters. This movement began soon after the establishment of the Giessen laboratory, and many an American obtained his inspiration in that laboratory. There are living to-day a number of American chemists who sat at Liebig's feet; a still larger number look back with pride to the time spent in the Göttingen laboratory, where Wöhler's was for many years the master mind. Bunsen and Hofmann attracted large numbers in their best days; and now Bayer in Munich, Ostwald in Leipsic, Victor Meyer in Heidelberg, and Fischer in Berlin, appear to exert the strongest influence upon American students. Most of the chemists holding prominent places in this country have had more or less

prolonged training in German universities, and it is not to be wondered at, therefore, that German methods have found their way into our laboratories. Indeed, there are some who appear to hold that, unless a method has a German tag on it, it is not worth considering. These hold, also, that the goal to strive for is the development of a laboratory like the best in Germany.

For many years Americans have been returning to this country after having enjoyed the best opportunities afforded abroad. Each annual crop have at least one thought in common, and that is, that chemistry in this country is in a deplorable condition, and that their labours are needed to bring about a reform. These young reformers are, of course, quite out of joint with the country, and often render themselves incapable of bringing about the results they desire, by refusing to recognise what is good and endeavouring to build upon that. The true and efficient reformer is a believer in continuity. Progress has always been by easy stages. The history of chemistry in this country shows that there has been a slow and steady advancement, and there is much promise in the present.

We owe to Germany very largely the investigating tendency which is showing itself more and more every year, and while even now the amount of original work done, as compared with that done abroad, is small, it is quite natural that it should be so.

A large part of the experimental work in Germany is done by advanced students and young chemists who are waiting for positions. It is by the aid of the former class especially that the professors work out their problems. Now, the number of advanced students of chemistry in this country is much smaller than in Germany, and the same is true even to a still greater degree of young chemists waiting for positions. Increase the number of these two classes here, and the amount of investigating work will be increased accordingly. But such increase must be determined largely by the demand, and the demand for thoroughly trained chemists is by no means as large as in Germany. The most important reason for this has already been spoken of. The value of these thoroughly trained chemists in the industries has not yet been generally recognised. Indeed, those particular industries in which the aid of scientific chemists is specially needed do not exist to any great extent, so that there is very little demand for such men. Most of the advanced students are looking forward to teaching, and the graduate departments in our universities must for years to come look to these men for re-enforcement. Plainly, the number of such students must be comparatively limited, or the supply will exceed the demand. After completing their regular courses these students must secure occupation. The "bread and butter question" is involved. But the number of places to be filled is limited, and every year young men well fitted to take good places are left, at least for a time, without means of support, and all their efforts must go to securing positions; and, further, when they secure their places, the conditions are for the most part unfavourable to the carrying on of higher work, and although many of them struggle manfully for a time to keep up their enthusiasm, it gradually dies out for want of nourishment.

All this is discouraging, of course, to the advanced students of chemistry, and to those who wish to study chemistry, and thus the number is necessarily kept down. It is a fair question whether the number of graduates now studying chemistry is not unnaturally large. However this may be, it is clear that, as the amount of investigating work depends upon the number of advanced students, the amount of this work must of necessity be comparatively small. More could be

done, no doubt, by teachers in colleges throughout the land, and the amount done by these teachers is increasing year by year, but it is difficult for them to secure co-workers, and, with unaided hands, the amount of chemical work that can be done by an individual is small.

Some of the most active workers in Germany are, as has been remarked, the young chemists, who are waiting for positions. These form a comparatively large class of picked men—men who have a strong tendency to investigation, and in some way see their way clear to at least a sufficient income to "keep body and soul together." Most of them have a hard struggle, though, on the other hand, some are men of means, whose ambition is not destroyed by the fact that they have fortunes. These men, of course, are desirous of securing advancement, and they know that their only chance lies in doing good work. It is the tremendous competition among these men that leads to the results for which Germany is famed.

Very well, you will say, if that is the secret, let us have that system here. But that is the very thing we cannot get. We may be able to secure a few able professors, a number of bright advanced students, good laboratories, and supplies, but this intermediate class of active workers cannot be secured, save under conditions that do not exist here, and are not likely to exist here for many years to come. Abroad the university career is one of the most attractive open to men; a professor is a very much respected member of the community, and his life is an unusually pleasant one. Without entering into a detailed comparison between the university career in this country and abroad, we may accept the general statement that this career exerts a much stronger attraction upon students there than here. Then, too, the opportunities in other fields are more limited there, so that these two forces working together, lead a number of the ablest young men to choose the university career, and to face the great difficulties which they know they will have to overcome before they attain success. The first condition of that success is good work done. There is absolutely no chance for one who does not carry on investigation, nor for one who is lukewarm in his work. The school is a merciless one, but the results probably justify the means.

What possibility is there of introducing this system in this country? Let the experiment be tried. Offer young men of ability the privilege of teaching in a university and nothing else, and how many, think you, will avail themselves of it? Or if some few exceptional men under most exceptional conditions should do so, how long will they remain in the position? To keep them it will be necessary to pay them at least enough to live on, and then the very soul of the German system is destroyed. In short, we have our own problems to work out under conditions that we cannot control, and while we may be inclined to regret that we cannot have all that we should like to have; while we in this generation at least must necessarily be content to do with less scientific work than those who have breathed the German atmosphere have been accustomed to, there is pleasure in working out new educational problems, and there is satisfaction in causing the tree of knowledge to grow where before it languished. We have a great field to cultivate. It is fertile. Labour expended upon it will yield rich harvests. So let us to work. Those who have been in the chemical field for years welcome the new workers, and especially such a body of workers as has been brought together in this University. May the great activity in chemical work which has characterised this University during its short life continue unabated. The Kent Chemical Laboratory is already known of all the world, even before its doors are open. May its fame increase year by year.

## THE TEACHING UNIVERSITY.

AT the ensuing meeting of Convocation of the University of London (on April 10 next), the rejection of the Gresham Commission scheme will be the subject of the first motion. It is intended (if possible) to propose an amendment which will, in effect, be a declaration that Convocation generally approves of the scheme as enabling the University to make extended provision for teaching, and for the advancement of learning, and for original research in London in accordance with, and in furtherance of, the principles already sanctioned by the several charters of the University. The following special, among other reasons, in general support of the Gresham Commission proposals, are now submitted to the consideration of your readers and the members of Convocation interested in the welfare of their University:—

(1) The original London University was intended to be both a teaching and a degree-conferring body.

(2) The University of the "30's" was open to collegiate candidates only, and was governed by a strictly professional body, consisting of the examiners, who formed the senate of the University.

(3) Under the charter of 1858 the non-collegiate student was admitted to the examinations, but the older system has never been abolished, nor has the principle thereof ever been abrogated.

(4) In the existing charter (Sec. 2) the object is declared to be "*to hold forth . . . an encouragement for pursuing a liberal and regular course of education.*"

In Sec. 34 a long list of affiliated colleges is given, in the next section power is conferred to "alter, vary, and amend" such list, and in Sec. 36 non-collegiate students are made admissible (except in medicine) "on such conditions" as the Senate may prescribe.

(5) Under Sections 18-38, and following, the Senate is empowered to examine for, and confer degrees on such conditions as it may think fit (subject to general law and the charter) to confer *ad eundem* degrees, and grant certificates of proficiency.

(6) It is, therefore, clear that the University is still essentially what it was originally—a collegiate University, with the added faculty of admitting non-collegiate students "upon conditions." The chief fault found with the collegiate system in 1858 was, in effect, that it was imperfectly established and insufficiently administered. It could have been reformed, and its maintenance was supported by 531 graduates against 38 who advocated the admission of the non-collegiate, as well as of the collegiate, student.

(7) It is equally clear that nothing in the existing charters prevents the University from establishing special examinations (if need be, which is very doubtful) for collegiate and non-collegiate students respectively, Professorships, Boards of Studies, Faculties, and even (probably) an Academic Council or its equivalent, such as provided by the Gresham Commission scheme, which, running counter to no principle sanctioned by any former or by the present charters, mainly restores and extends the University, methodises and regulates its educational machinery, and enables it to exercise such direct control over teaching as any well-wisher to academic education must surely desire to see it endowed with.

(8) The non-collegiate student, in whose favour alone does the Gresham scheme depart from the original principle of the University, cannot but gain by having his studies directed by the whole teaching force of the metropolis. At present only two professors actually engaged in teaching, representing only one out of the numerous subjects comprised within the faculties of Art, Science, Medicine, and Laws (exclusive of clinical medicine,

which is well represented), sit upon the councils of the University. Even Convocation, during its whole existence, appears to have elected only two professors. Such a divorce of testing from teaching has been long regretted by most teachers of eminence, metropolitan or provincial, and by most, if not all, of the Examiners of the University.

(9) Lastly, as measuring the comparative academical success of collegiate and non-collegiate courses of study, the figures which I give in a note are not uninteresting:—

If conclusions may be drawn from these figures, the academical success of the graduates who were largely non-collegiate, would appear to be one-half of that of the graduates who were largely collegiate, and one-fourth of that of the graduates who have always been wholly collegiate.

(10) As collegiate and non-collegiate candidates are certainly of equal intrinsic quality, it would seem that the difference is to be ascribed to the superiority of collegiate over non-collegiate courses of study.

(11) Hence the collegiate principle, the original principle of the University, which it has never abrogated, would appear to be the principle most likely to repay extension—and this is precisely what the Gresham Commission scheme proposes to do—and there is nothing to show that its extension need in the slightest degree interfere with the interests of the non-collegiate student. On the contrary, it would facilitate the increase of his opportunities for regular instruction of the highest character.

(12) In conclusion, the assumption underlying the foregoing remarks is that the chief object of a University is the advancement of learning and research, and not the mere granting of degrees, which are but a means to an end. The eloquent appeal of Lord Reay, appended to the Gresham Report, should be carefully studied by all interested in the University questions.

F. VICTOR DICKINS.

## WILLIAM PENGELLY.

THE death of William Pengelly, at the ripe age of eighty-two, deserves more than a passing notice, because he was one of the last survivors of a scientific type represented by Sedgwick, Lyell, Phillips, Murchison, and the other old heroes who laid the foundation of geological science. He belongs to the heroic age of geology—to that group of men who found British Geology almost a *terra incognita*, and left it so completely explored that there is little left for their successors but to correct mistakes and fill in minute details.

Pengelly was born in 1812, at East Looe, in Cornwall, of a Quaker stock, and lived all his life in the west country. Like Prof. Dana, he took to the sea and served before the mast. Having, however, a decided taste for mathematics and geology, he gave up seafaring and

<sup>1</sup> During the last five years the annual number of B.A.'s (largely non-collegiate) has sunk from 238 in 1889, to 156 in 1893, a diminution of 34 per cent. From 1858 to 1893, the annual number of B.A.'s has increased from 70 to 156, of B.Sc.'s from 5 to 80 (in 1892—for some reason or other—the number dwindled to 65 in 1893), of M.B.'s from 20 to 89, and of M.D.'s from 16 to 59.

[The science candidates are mainly collegiate, the medical candidates have always been wholly collegiate.]

During the last three years, 1891-2-3,

|                                                 |                |
|-------------------------------------------------|----------------|
| Of 639 B.A.'s, 38 took 1st Class Honours, about | 5 per cent.    |
| Of 250 B.Sc.'s, 23                              | " " " " " 11 " |
| Of 249 M.B.'s, 55                               | " " " " " 22 " |

Of some 500 graduates in Honours at the B.Sc. examination (since the institution of the degree in 1881 to 1892), 470 were collegiate students, and only 30 were non-collegiate.

During the same period, of some 1080 B.A. Honours men, only 260 were wholly non-collegiate, the remainder, 720, were collegiate students. Of the 260 non-collegiates, 42 obtained a 1st Class in Honours, chiefly in modern languages; the remaining 218 were largely placed in the 3rd Class.

settled down as a teacher in Torquay. Here for some sixty years he threw himself into the work of higher education, and more especially in the direction of natural science. In 1837, through his energy, the Torquay Mechanics Institute, which had fallen on evil days, was reorganised and put on a satisfactory working basis. Seven years later he founded the Torquay Natural History Society, and in 1863 he extended the range of his personal influence by establishing the Devonshire Association that took root and flourished exceedingly, and has been of great service in the West of England. It is impossible to read any one of the many volumes published by the Association without realising how great has been his influence in bringing natural knowledge within reach of the people. The museum at Torquay is also an enduring monument to his energy, which will continue to teach when his name is forgotten.

Pengelly was, however, beyond all other things, a geologist, devoted to the study of Devonshire. The collection of Devonian fossils in the Oxford Museum is spoil of his hammer. He collected also the materials for the "Monograph on the Lignite Formation of Bovey Tracey," a joint publication with Dr. Heer, that has thrown so much light on the Miocene forests which clothed the slopes around the Lake of Bovey. During the second quarter of the present century, the question of the antiquity of man was steadily coming to the front. In 1847 Boucher de Perthes published his discovery of flint implements along with the extinct mammalia in the river-gravels of Amiens and Abbeville. Similar discoveries in Kent's Hole by Mr. M'Enery, made some time between 1825 and 1839, had been verified by Godwin-Austen in 1840, and the Torquay Natural History Society in 1846. So strong, however, were the prejudices against the antiquity of man, that the matter was not thought worthy of further investigation, until the year 1858. Then it was determined that a new cave at Brixham, near Torquay, should be explored by a joint committee of the Royal and Geological Societies, consisting, among others, of Lyell, Falconer, Ramsay, Prestwich, Owen, and Godwin-Austen, with Pengelly as the superintendent of the work. The result of the exploration established beyond all doubt the existence of palæolithic man in the Pleistocene age, and caused the whole of the scientific world to awake to the fact of the vast antiquity of the human race. From this time Pengelly's energies were mainly directed towards cave exploration. In 1865 he undertook the superintendence of the exploration of Kent's Hole by a committee of the British Association. It was at this time that I first became associated with him in cave-digging, and as we came to know one another, I learnt to admire his method, and his patient and accurate work. Day by day, excepting when the work was stopped, he visited the cave and recorded on maps and plans the exact spot where each specimen was found, for no less than sixteen years. The vast collection of palæolithic implements and fossil bones, each of which bears traces of his handiwork, is represented in most of the museums in this country, and the annual reports, listened to with so much pleasure by crowds at the meetings of the British Association, are the most complete that have ever been published. It may be objected that the accumulation of so much evidence of the existence of man in the Pleistocene age, in the south of England, was unnecessary. It was, however, necessary to sweep away the mass of prejudice, and this could best be done by repeating the evidence. Had this not been done, early man would not occupy the recognised position which he now holds in the annals of geology. The rest of Pengelly's life was mainly given up to the researches in other caves in Devonshire. In estimating his scientific work, it must not be forgotten that it was done in addition to the daily task of bread-winning.

NO. 1275, VOL. 49]

There remains one other side of Pengelly's many-sided character which deserves remark. He was a fluent and genial speaker and lecturer. For many years he was a leading figure at the meetings of the British Association, and there are but few large centres where he was not known as a lecturer and not welcomed as a friend. Some of his *jeux d'esprit*, such as, for example, his saying in treating of the thorny question of man's antiquity, "that you may be as naughty as you like," will long be remembered. He has died full of years, and with his services honourably recognised by his private friends and by the scientific world. He has left behind an example of what one man can do in advancing knowledge by energy and perseverance.

W. BOYD DAWKINS.

#### THE LATE CAPTAIN CAMERON.

CAPTAIN VERNEY LOVETT CAMERON, C.B., R.N., died very suddenly, in his fiftieth year, on March 26, in consequence of being thrown from his horse while returning from a day's stag-hunting. His name is associated with the most stirring period of modern inland exploration in Africa. In 1871 Mr. H. M. Stanley met and relieved Livingstone at Ujiji, and on returning to the east coast met the Livingstone relief expedition of the Royal Geographical Society, the leader of which, believing his work to be forestalled, declined to proceed, and broke up his caravan. Lieutenant Cameron had for some time been anxious to explore Africa, and had been one of the unsuccessful applicants for the command of the abortive expedition. On its collapse he submitted proposals for the exploration of the Victoria Nyanza and of east equatorial Africa to the Royal Geographical Society, and in 1872 he was entrusted with a new Livingstone relief expedition, which was to proceed from the east coast, while another expedition, under Lieutenant Grandy, pushed its way up the Congo.

Leaving Bagamoyo early in 1873, Lieutenant Cameron started on his march inland, but was met by the melancholy little group of Livingstone's black servants carrying the body of their master. Although the main aim of the expedition was thus frustrated, and all the Europeans of the party were suffering severely from the climate, Cameron determined to push on alone, and not return until he had accomplished some new geographical work. Early in 1874 he reached Lake Tanganyika, surveyed its southern half, and settled the existence of an outflow by the Lukuga; then turning north-eastward, he reached the Lualaba in the Manyema country, and attempted to descend the river. He could not, however, overcome the difficulties in the way, and turning southwards again, made his way by slow stages suffering greatly in health, to the west coast at Benguela. Here he arrived in November 1875, at the very time when Stanley, more fortunate, was on his march westward from Uganda to finally solve the great problem of the Congo. In 1877 Cameron published his book, "Across Africa," and received various marks of public approval for his services, including his promotion to the rank of Commander, a C.B., the degree of D.C.L. from Oxford, and the gold medal of the Royal Geographical Society. In 1882 he visited the Gold Coast, in company with Sir Richard Burton, on a commercial mission, and during his later years he became more and more deeply interested in various trading companies engaged in the exploitation of Africa. Captain Cameron was respected as an authority on Central African affairs, and took a prominent place, both in this country and in France, in promoting new enterprises.

## NOTES.

A FAMOUS physician and physiologist has just passed away. We allude to Dr. Brown-Séguard, of the Paris Academy of Sciences, whose death occurred on Sunday night. Dr. Séguard was born at Port Louis, Mauritius, in 1817, and was, therefore, seventy-seven years of age at the time of his death.

WE regret to record the death of M. H. C. G. Pouchet, Professor of Comparative Anatomy at the Paris Museum of Natural History, at the age of sixty-one. He became assistant-naturalist and head of the anatomical department of the museum thirty years ago, and in 1870 was appointed to the chair he occupied up to his death. He was the author of numerous works of scientific value, among which may be mentioned his "Traité d'Ostéologie Comparée," published in 1889.

PROF. ROBERTSON SMITH has also passed away at the early age of forty-eight.

THE following deaths have recently occurred abroad:—Dr. W. H. Delffs, Professor of Chemistry in Heidelberg University, Dr. G. A. Weiss, Professor of Botany at Prague, and Dr. F. Ulrich, Professor of Mineralogy and Geology in Hanover Polytechnic.

THE Royal Meteorological Society's fourteenth exhibition of instruments, which will open on Tuesday next in the rooms of the Institution of Civil Engineers, 25 Great George-street, Westminster, will be devoted mostly to instruments, drawings, and photographs relating to the representation and measurement of clouds. The exhibition promises to be a very interesting one, and will include original cloud sketches by Luke Howard, as well as photographs of clouds by the highest authorities in various parts of the world. The exhibition will remain open till the 20th inst.

THE eleventh International Medical Congress was formally opened by the King of Italy on March 29. It is said that the congress includes more than six thousand members. The President, Prof. Baccelli, delivered the inaugural address in Latin, and dwelt on the importance of the "great and solemn festivals of science." Prof. Virchow, speaking as the President of the tenth International Congress, held at Berlin in 1890, expressed the thanks of the members of the eleventh congress for the warmth of the welcome extended to them by the city of Rome and by Italy. The *British Medical Journal*, to whom we are indebted for this information, contains a number of portraits of some of the officers of the congress and readers of addresses, among them being an excellent one of Prof. Michael Foster. Members of the Congress were invited to a garden party in the Quirinal Gardens on Monday, and in this and other ways the King of Italy and the Italian Government have shown their interest in the meeting. Foreign visitors must marvel at the different way things are managed here, where the Royal Family and Government generally ignore them.

INFORMATION has been received, through Reuter's agency, that the members of the International Sanitary Conference met on April 2, at the Ministry for Foreign Affairs in Paris, as a private committee, to collate the different copies of the text of the convention. The instrument was to have been signed on Tuesday by the plenipotentiaries of all the Powers, except the representatives of Turkey. A very complete scheme has been formulated in order to diminish to the utmost any chance of the cholera being conveyed to Europe by means of the Indian pilgrimages to the Hedjaz, and also to improve the unsatisfactory conditions to which pilgrims are exposed in the Red Sea and Arabia, both

on the outward and homeward journeys. These changes will involve a complete reorganisation of the sanitary stations now controlled, and the creation of a number of hospitals and refuges at Jedda, Mecca, and elsewhere. With the exception of Turkey, all the countries represented at the congress, including Persia, are unanimous in their decisions.

DR. G. S. TURPIN, of the Storey Institute, Lancaster, has been appointed principal of the Huddersfield Technical School.

PROF. O. MATTIROLO has been appointed Extraordinary Professor of Botany and Director of the Botanic Garden at the University of Bologna.

WE learn from the *Journal of Botany* that the first volume of the *Conspectus Floræ Africae*, by M. Durand and Dr. Schinz, will shortly appear.

PROF. GUIDO CORA, of the Royal University of Turin, is representing the Société d'Anthropologie de Paris at the International Medical Congress, now being held in Rome.

DR. H. KAYSER, who, with Prof. Runge, has carried out some important spectroscopic researches, has been appointed Professor of Physics at Bonn University, in succession to the late Prof. Hertz.

IT has been decided by the Veterinary Section of the Wurttemberg Academy of Medicine to establish a laboratory for the preparation of vaccines by Pasteur methods. The laboratory will bear Pasteur's name.

THE Rouen Académie des Sciences, Belles-Lettres, et Arts, offers a prize of five hundred francs to the author of the best work on a new method of accurately measuring high temperatures, or for the improvement of one of the methods already known.

THE Liverpool Library Science and Arts Committee have received an anonymous offer of £5000 towards the cost of erecting central buildings for the School of Science, Technology, and Arts, on condition that the Corporation subscribe a like amount.

MR. J. JENNER WEIR, the well-known entomologist, died on March 23, in his seventy-second year. He became a Fellow of the Entomological Society fifty years ago, and was also a Fellow of the Linnean, the Zoological, and other Societies. His first paper was contributed to the *Zoologist* in 1845; his last appears in the April number of the *Entomologist*. As an enthusiastic worker, and an acute observer, he was esteemed by all, and by his death natural history suffers a severe loss.

MR. GEORGE PYCROFT died at Torquay a few days ago. He was one of the founders of the Devonshire Association for the Advancement of Science and Art.

MESSRS. BALY AND CHORLEY have devised a high temperature thermometer, the novelty of which consists in the replacement of mercury by the singular liquid alloy of potassium and sodium. The boiling point of this alloy lies somewhere in the neighbourhood of 700°, and its solidifying point is -8°, so that between these limits the liquid is particularly suitable for thermometric use. In order not to inconveniently lengthen the thermometer, the graduations are caused to commence at 200°, the bore for this purpose being widened just above the bulb. The space above the alloy is filled with pure nitrogen at such a pressure that when the glass begins to glow, and therefore soften, the interior pressure shall be equal to the atmospheric, and thus any

tendency to alteration of volume avoided. The alloy exerts a slight action upon the glass at a red heat, causing a browning, but after the first heating during the preparation of the instrument the action ceases, the stained interior surface resisting further action. It is only necessary to heat the bulb and a small portion of the stem, for the coefficient of expansion of the alloy increases with the temperature in such a manner as to compensate for the error due to the portion not heated. The graduations are thus equidistant, and various points in them are determined by immersion of the lower portion of the instrument in the vapour of high boiling substances whose temperatures of ebullition have been well ascertained. The instrument should be a very useful one for the determination of high boiling points.

THE "Hand-Guide to the Royal Botanic Gardens, Péradeniya," prepared by Mr. Henry Trimen, F.R.S., the Director, contains some interesting information. The gardens were opened in 1821, six years after the final occupation of the Kandy Kingdom by the English. A plan for a proper botanical garden in Ceylon was drawn up by Sir Joseph Banks as far back as 1810, the site chosen being Slave Island, Colombo. Mr. W. Kerr took charge of this establishment in 1812, but he died two years later, and was succeeded by Mr. Alexander Moon. It was during Moon's rule that the gardens were moved to the present site at Péradeniya. Moon was a diligent student of the flora of Ceylon, and published a valuable work upon it, but after his death, in 1825, a succession of more or less unqualified persons were placed in charge. With the appointment in 1844, however, of Mr. George Gardner, the gardens started on the active, independent, and useful existence which they have since maintained. Mr. Gardner died in 1849, and was succeeded by Dr. Thwaites, who kept Péradeniya in a high state of efficiency for more than thirty years, and died at Kandy in 1882, having never left the island since his arrival. The present director has held his position since 1880.

A PAMPHLET has been published by the observatory of Villa Colon, near Montevideo, containing the results of rainfall observations for the ten years 1883-1892, computed by the Rev. L. Morandi. The mean annual fall is 35.3 inches; the maximum and minimum values for each month show that they varied from 11.7 inches in January 1889 to 0.0 inch in August 1886, whereas the normal values for these months are 3.4 inches and 3.5 inches respectively. The greatest fall in one day was 3.15 inches, on January 26, 1889, while on the 6th of the same month 1.9 inch fell in 2½ hours. The number of days on which rain fell in the year varied from 68 to 109. The greatest number of consecutive rainy days was 9, and of dry days 38; the greater quantity falls in the early morning. Other tables show the relation between the rainfall, atmospheric pressure, and wind.

AN extremely brilliant aurora borealis was observed on March 30. The Hon. Rollo Russell saw the display from Haslemere. In a letter to us, he says:—"A bluish-white illumination, like late twilight, was first noticed in the north-west, and this continued with little variation for about fifteen minutes, namely, from 10.15 to 10.30 p.m. A red streamer then shot up towards the zenith, and was for about half a minute rather well-defined, but afterwards gradually became fainter and broader. A considerable amount of pale white light remained in the north-west at 10.40. When the phenomenon was at its brightest, the stars in its direction ceased to be visible." The following particulars, received from Mr. C. E. Stromeyer, of Glasgow, are of interest:—"Luminous (white) rays were seen to converge from all parts of the horizon towards a common centre, which, as nearly as I could gauge, shifted its position as follows:—At 10.30 p.m.,

11h. 30m. N. 50°; at 11 p.m., 10h., N. 40°; at 11.30 p.m. the centre was not well defined, and few rays showed themselves." Mr. Stromeyer remarks that at first the centre was occupied by luminous clouds of an irregular streaky nature, which sometimes took the form of spirals. Occasionally waves of light were also seen passing rapidly along the rays toward the centre. Mr. Preece, writing to the *Times*, says the aurora was accompanied, as usual, by very strong earth currents on all telegraph lines. At 10.20, a peculiar noise was heard upon a telephone inserted upon a long Irish wire at Llanfairpwll in Anglesey, and at 2 a.m. on Saturday, March 31, "twangs" were heard, as if a stretched wire had been struck.

WE are informed that the fund established by Mrs. Elizabeth Thompson, of Stamford, Connecticut, "for the advancement and prosecution of scientific research in its broadest sense," now amounts to \$26,000. As accumulated income will be available in June next, the trustees desire to receive applications for appropriations in aid of scientific work. This endowment is not for the benefit of any one department of science, but it is the intention of the trustees to give the preference to those investigations which cannot otherwise be provided for, which have for their object the advancement of human knowledge or the benefit of mankind in general, rather than to researches directed to the solution of questions of merely local importance. Applications for assistance from this fund, in order to receive consideration, must be accompanied by full information, especially in regard to the following points: (1) Precise amount required; (2) exact nature of the investigation proposed; (3) conditions under which the research is to be prosecuted; (4) manner in which the appropriation asked for is to be expended. All applications should reach the Secretary of the Board of Trustees, Dr. C. S. Minot, Harvard Medical School, Boston, Mass., U.S.A., before June 1. The following grants have been made, in addition to those contained in the list previously noted in these columns (*NATURE*, vol. xlv. p. 91): \$300 to Prof. E. Wiedemann, Erlangen, for researches on luminous electric discharges; \$200 to Prof. S. Exner, Vienna, for experiments with carrier pigeons; \$100 to Prof. K. Kobert, Dorpat, for researches on sphacelinic acid and cornutine; \$200 to Prof. A. Béchamp, Paris, for researches on the composition of milk; \$200 to Prof. E. Drechsel, Leipzig, for researches on bases derived from albumens.

AN ordinary general meeting of the Institution of Mechanical Engineers will be held on Thursday and Friday, April 19 and 20. Prof. A. B. W. Kennedy, F.R.S., will deliver his inaugural address on the former date, after which papers will be read and discussed.

AT the twenty-fifth annual meeting of the Norfolk and Norwich Naturalists' Society, held on March 27, Prof. Robert Collett, of Christiania, and Mr. E. T. Newton, F.R.S., were elected honorary members, and Dr. Charles Plowright was appointed president, in succession to Mr. T. Southwell. It was resolved by the meeting that the society be enrolled as a corresponding society of the British Association.

THE Worthing correspondent of the *Daily Chronicle* says that an unfavourable report upon the results of the trial of M. Hermite's system of treating sewage matter with electrolysed sea-water (see p. 469) has been prepared by Dr. C. Kelly, medical officer of health of the borough and of the combined sanitary district of West Sussex. The report contains the results of chemical and bacteriological analyses made respectively by Dr. Dupré and Dr. Klein. The results of the various tests are set out in detail, and Dr. Kelly concludes:—"Since there is no instantaneous decomposition of fæcal matter and no

sterilisation of sewage, I am of opinion that the process, so far as the late trials have gone, has therefore failed to produce the results which are claimed for it by its inventor." This is the first time M. Hermite's system has been publicly tested in England.

DR. H. R. MILL and Mr. E. Heawood have made a careful bathymetrical survey of Haweswater, thus completing the soundings necessary for the construction of contoured maps of all the larger lake-basins in England. The greatest depth found was 103 feet, rather less than one-third of the depth which local tradition assigned to the lake. Haweswater presents an interesting example of a long narrow lake which has been nearly separated into two sheets of water by the large delta of a mountain torrent, illustrating a stage in the history of such severed lakes as Buttermere and Crummock, or Derwentwater and Bassenthwaite. The temperature of the mass of water in the lake was, on March 26, 39° 7 F. with a surface temperature of 41° 5 in the deep, and 43° in the shallow parts of the lake.

WE have received from the Deutsche Seewarte, part vi. of *Deutsche ueberseeische meteorologische Beobachtungen*, containing observations made at six places in Labrador, one at Walfisch Bay, one at Apia (Samoa), four on the east coast of Africa, and one at Chemulpo (Corea). The stations in Labrador were first established in 1882, and furnished a very important addition to the international polar observations made in that year, as they formed a link between the stations in Canada and West Greenland. The establishment of the other stations is mostly due to the efforts made by Germany to extend her colonial possessions, and to the praiseworthy desire of having scientific observations made wherever her countrymen gain a footing. The result is the publication of a valuable series of observations in remote places, made with good instruments, and upon a uniform plan. The readings are made three times daily, while the state of the weather, &c. is represented by international symbols. We think it would add to the value of the work if each part contained the key to these symbols, as they are probably unknown to many persons into whose hands the volumes fall.

IN the last Report of the Meteorological Society of Scotland it was stated that an inquiry had been completed into the diurnal variation of the barometer on Ben Nevis during the days of clear weather on the one hand, and days of fog or mist on the other. The results gave two sets of curves essentially different from each other; and as these suggested important applications to other meteorological inquiries, it was resolved to submit the barometric observations at the Fort-William Observatory to a similar discussion. The same days were selected that were used in the discussion for the top of Ben Nevis. At the general meeting of the Society on March 29, the Council reported that the discussion has been completed, with the highly important result that, just as happens at the top, the hourly diurnal curves for clear and foggy weather respectively are essentially different from each other. The result, broadly stated, is that for clear weather, the diurnal curves are strongly pronounced forms of the curves for dry continental climates about the latitude of Fort-William; and those for foggy or misty days strongly pronounced forms of the curves for wet climates on the coasts in similar latitudes. Further, the combination of these curves for widely different types of weather is identical with the curves calculated from all the observations. This resolution of the Fort-William diurnal barometric curve is new to the science and is of the highest importance.

MR. A. F. MILLER has made a spectroscopic examination of the light emitted by the small luminous beetle, *Photinus*

*corruscus* (*Transactions of the Astronomical and Physical Society of Toronto*). The light emitted appears to be of two different kinds. From the lower part of the insect's abdomen a glow of a pale greenish tint, like that of phosphorus or a phosphorescent substance, was pretty constantly visible. This light gave a faint spectrum consisting of a wide green band situated between  $\lambda$  5160 and  $\lambda$  5805 approximately. The second kind of light was emitted in flashes lasting generally about a quarter of a second, though sometimes the insect emitted several in quick succession. The source of this light is in the same region of the abdomen, but the luminous intensity is much greater than in the former case. The flash has a pale green colour, and its spectrum is perfectly continuous through the region it occupies, that is, from about  $\lambda$  5000 to about  $\lambda$  6605. The specimens examined did not seem to give any emission of blue or violet light, though there might have been faint radiations in this region imperceptible to the eye through the sudden character of the flash, and the overpowering preponderance of the less refrangible waves. It would be of interest to test the action of both kinds of luminosity upon a photographic plate. Mr. Miller's observations go to show that the whole energy devoted to the insects to light-production is expended in originating those rays which powerfully affect the visual organs. They thus support the conclusion of Prof. S. P. Langley, that nature produces the most economic kind of light.

At a recent meeting of the Académie des Sciences (Paris) M. Lippmann presented a paper by M. N. Piltchikoff, on a new method of studying the electric discharge. This method consists in joining one pole of a Voss electric machine to a metallic point which is held over a layer of castor oil contained in a copper dish, connected to the other pole of the machine. If the point is positively charged a large depression is formed, at the centre of which a secondary depression is seen if the distance between the point and the oil is diminished. If a small screen is placed between the point and the oil, an elevation is produced at the centre of the depression; the shape of this elevation being the same as that of the shadow that would be formed if the electrified point were luminous. The level inside this shadow is the same as that of the unaffected liquid, so that it appears that the screen stops the action and produced an electric shadow. This curious effect is shown in a very striking manner by the employment of mica screens cut into various geometrical forms; in every case the "shadow" formed on the depression was an exact reproduction of the screen. One cannot help being struck with the resemblance of the above experiment to some of those of Prof. Crookes. The same phenomena are produced with the negative discharge. The discharge acts in a very powerful manner, and the phenomena show themselves even when a strong blast of air is caused to play between the point and the oil. Using different gases the author finds that at the ordinary atmospheric pressure the electric shadows are in all cases the same; the only differences obtained were in the secondary depressions which appear when the electrified point is very near the surface of the oil. With very low pressures, however, the shadows are not formed. The author has succeeded in photographing the depressions and the shadows, and has obtained sharp and well-defined negatives with an exposure of about twenty seconds, showing that, at any rate for this length of time, the phenomenon does not change appreciably.

THE current number of the *Istituto d'Igiene sperimentale di Roma* contains an exhaustive and very important memoir "Sul veleno del Tetano," by Dr. Fermi and Dr. Pernossi. It covers close upon sixty pages, and records numerous experiments on the behaviour of the toxic soluble products of tetanus



cultures under various conditions. Amongst these the action of heat was investigated, and it was ascertained that the tetanus filtrate diluted with water was deprived of all pathogenic properties when exposed for one hour to 55° C., but when completely desiccated it was still toxic after being exposed for one hour to 120° C. The action of an electric current on its pathogenic properties was also examined, and they were found to be destroyed after exposure for about two hours to a current of about 0.5 amperes. Numerous chemical substances were also investigated. Amongst the gases experimented with, it was found that oxygen, carbonic anhydride and hydrogen produced no appreciable effect even after from ten to fifteen hours' contact.

MESSRS. SAXON AND CO. have published a useful little book, entitled "Everybody's Guide to Gardening," by Mr. H. H. Warner.

DR. THOMAS LYNN'S "Health Resorts of Europe" (Bristol: John Wright and Co.), being a guide to the mineral springs, climates, mountain and sea-side stations of Europe, has reached a second edition.

THE Calendar of the Royal University of Ireland, for the year 1894, has just been published. The papers set at the examinations in 1893 are published in a separate volume, forming a supplement to the Calendar.

THE Botanical Exchange Club of Vienna has issued an extensive list of specimens of rare plants, which it is ready to exchange or sell. Several new species are also described. The list may be obtained from Herr J. Dorfner, of I. Burging 7, Vienna.

DR. J. W. MOLL, the Director of the Botanic Garden at Groningen, publishes (in French) a list of forty-two species of Papaveraceæ grown in the Garden, three of which are probably hybrids. Seeds of a large number of the species are offered to other horticulturists.

WE have received the number of the *Journal of the Royal Horticultural Society* for January. Besides extracts from the *Proceedings* of the Society and its committees, it contains reports on the growth of a number of garden plants and vegetables at Chiswick, and papers by specialists on various subjects interesting to horticulturists.

DR. C. V. RILEY, of Washington, has sent us a paper on "Parasitic and Predaceous Insects in applied Entomology," and one entitled "Further Notes on Yucca Insects and Yucca Pollination." The pollination of *Yucca whipplei* by *Pronuba maculata* is described in detail. In another paper he describes two new species of *Megastismus*, a genus of Chalcididæ which is essentially parasitic, chiefly on gall-making Cynipidæ.

MR. A. E. MUNBY has prepared a pamphlet entitled "Notes on Polarised Light, for Students of Mineralogy," and published by Messrs. Reid, Sons, and Co., Newcastle-on-Tyne. In the twenty-eight pages, of which the pamphlet consists, an elementary description is given of the optical principles utilised in the construction of the polariscope, and of phenomena observable with that instrument used as an adjunct to the microscope. The notes should be of use to elementary students of mineralogy, for they contain clear explanations of the various points connected with the classification of crystals according to their optical symmetry.

SOME years ago Liebig wrote to the Royal Agricultural and Commercial Society of British Guiana: "There cannot be a more beautiful and striking exemplification of the genuine British spirit than the disposition shown by the most distinguished and best-informed men in the remotest parts of the

great empire to form themselves into Societies, which have for their object the extension, promotion and application, for the public good, of scientific principles." On March 18, the Society to which these words were addressed attained its jubilee, and in view of this fact a short account of its establishment and work is given in the current number of its excellent journal, *Timehri*. In addition to this description, the journal contains a long paper, in which Mr. Edward F. im Thurn details the incidents of one of his journeys into the far interior of Guiana.

WHEN the Natural History Society of Rugby School was founded in 1867 it was laid down that the objects for which it was established were (1) to work out the natural history of Rugby; (2) to keep an annual register of all facts connected with natural history observed there; (3) to assist in the formation of a museum for reference; (4) to hold meetings for the reading and discussion of papers on scientific subjects. The report just issued by the Society shows that most of the original objects were faithfully carried out during 1893. The members of the botanical section have worked well, and, thanks to their exertions, have prepared a useful list of Rugby mosses. In the entomological section, also, good work was done. The report includes an observation list of Rugby Lepidoptera, containing 293 species, of which six are new to the district, and Mr. F. D. Morice contributes some additions to his list of Hymenoptera. Up to December of last year he had found upwards of 140 species of Aculeates in the Rugby neighbourhood. Other sections of the Society concern themselves with zoology, archæology, geology, photography, and meteorology. The report not only contains the proceedings of these sections, but also a brief statement of the observations made at the Rugby Observatory, and several papers read at the meetings. We have also received the last report of the Epsom College Natural History Society. Such societies deserve the greatest encouragement, and the only matter for regret is that their work is not found interesting to a larger proportion of the schools to which they belong, instead of being left to a few enthusiasts.

A DETAILED account of his investigations concerning the gaseous fluorides of the simpler organic radicles is contributed by M. Meslans to the March number of the *Annales de Chimie et de Physique*. The fluorides of methyl and ethyl have already been fully described by M. Moissan and other workers, and the fluorides now described are those of the radicles propyl, isopropyl, allyl, and acetyl, together with the interesting analogue of chloroform, fluoroform. Propyl fluoride may be obtained by reacting with the corresponding chloride, bromide, or iodide upon anhydrous fluoride of silver. The iodide is most convenient as it reacts at the ordinary temperature, while propyl bromide requires heating to the neighbourhood of 100°, and the chloride to a still higher temperature. The reaction between propyl iodide and silver fluoride may be best carried out in a copper tube immersed in tepid water. The propyl iodide is admitted to the tube already containing the silver fluoride from a dropping funnel, and the gaseous product of the reaction passes upwards through a leaden condensing worm, cooled by iced water, and subsequently through three U-tubes containing fragments of silver fluoride, and finally through a delivery tube to the mercury trough over which the gas is to be collected. The reaction does not simply result in the formation of propyl fluoride and silver iodide. A third substance is produced, a red solid substance which is found to be an iodo-fluoride of silver of the composition Ag<sub>2</sub>FI. The amounts of propyl fluoride and of the latter substance obtained correspond to the equation

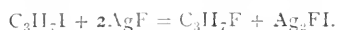

Propyl fluoride is a colourless gas possessing an odour similar to that of the analogous chloride. It burns with a brilliantly lumi-

nous flame forming aqueous vapour, carbon dioxide, and hydrofluoric acid. It liquefies at  $-3^{\circ}$  at the ordinary pressure to a colourless mobile liquid which is without action upon glass. The difference of boiling point between this liquid and propyl chloride ( $+45^{\circ}$ ) is  $48^{\circ}$ , about the same as that between ethyl fluoride and chloride, and almost twice as great as that between the chlorides and bromides of the two radicles. The gas is decomposed by melted sodium, with sudden and brilliant incandescence accompanied by deposition of carbon. It is soluble in water to the extent of one and a half times the volume of the latter. Isopropyl fluoride and allyl fluoride are prepared in a similar manner from the corresponding iodides. They are both gaseous substances capable of condensation to liquids by reduction of temperature or augmentation of pressure. A mixture of allyl-fluoride with four times its volume of oxygen explodes with great violence under the agency of an electric spark, or when brought in contact with a flame.

FLUOROFORM,  $\text{CHF}_3$ , has been prepared in the pure state by M. Me-lans only after repeated unsuccessful attempts. When free fluorine from the platinum delivery tube of the electrolysis apparatus is allowed to escape into chloroform an energetic reaction occurs, chlorine is liberated, and in a few moments an explosion is produced, with copious formation of carbon tetra-fluoride and fluoroform. If the fluorine is caused to enter a vessel containing air charged with vapour of chloroform an immediate explosion is produced. When finely-powdered silver fluoride and iodoform are mixed a vigorous reaction also occurs, usually with incandescence, and the fluoroform produced is contaminated with other gaseous products. The reaction may be modified, however, by adding chloroform and cooling with ice, and the gas may be purified from chloroform by passing through alcoholic potash, which is without action upon fluoroform, from carbonic oxide, which is usually present in small quantity, by means of a solution of cuprous chloride in hydrochloric acid, followed by desiccation over fused potash, and finally from last traces of impurities by passage over silver fluoride heated to  $150^{\circ}$ . The gas thus treated is pure fluoroform, a gas which liquefies at  $0^{\circ}$  under a pressure of twenty atmospheres. It is incombustible, but imparts a bluish-green colour to a Bunsen flame when injected into it. It is insoluble in water, and possesses an odour similar to but feebler than that of fluoroform. The action of free fluorine upon it is interesting. A flame is produced at the end of the platinum tube delivering fluorine, and the one atom of hydrogen contained in the fluoroform is extracted and converted into hydrofluoric acid without any deposition of carbon, the latter element being at the same time entirely converted to the gaseous tetra-fluoride.

THE additions to the Zoological Society's Gardens during the past week include a Rhesus Monkey (*Macacus rhesus*) from India, presented by Mr. W. Chrystal; a Squirrel Monkey (*Chrysothrix sciurea*) from Brazil, presented by Mrs. E. M. Parkinson; two — Bears (*Ursus* sp. inc.) from the Caucasus Mountains, presented by Mr. Arnold Pike; a Striped Hyæna (*Hyaena striata*) from North-west Africa, presented by Señor Don. D. M. Macleod; a Kinkajou (*Cercoleptes caudivolutus*) from South America, presented by Mr. A. Murray; a Hairy Armadillo (*Dasypus villosus*); a Common Teguxin (*Tapinambis teguxin*) from h America, presented by Captain W. Clift; an American Turkey (*Meleagris gallo-pavo*) from North America, presented by Mr. Blayney Percival; two Pink-footed Geese (*Anser brachyrhynchus*), British, presented by Colonel W. H. Feilden; a Greek Tortoise (*Testudo græca*), European, presented by Mr. George Hollis; a Green Tree Frog (*Hyla arborea*), European, presented by Mr. Thomas Plowman; two — Pittas (*Pitta* sp. inc.) from Australia, purchased.

## OUR ASTRONOMICAL COLUMN.

THE RECKONING OF THE ASTRONOMICAL DAY.—The Canadian Institute, in co-operation with the Astronomical and Physical Society of Toronto, have for some time had under consideration the subject of astronomical time reckoning, and last May the joint committee appointed sent out a circular letter for the purpose of obtaining the views of scientific men interested in the matter. Answers were invited to the following question:

"Is it desirable, all interests considered, that on and after the first day of January 1901. the Astronomical Day should everywhere begin at mean midnight?" At the present time, as all astronomers know, the astronomical day is reckoned from mean noon to mean noon, and is 12 hours behind the civil day. Hence, if the proposed change were adopted, the only difference between astronomical and civil times would be that the former would have a twenty-four hour, and the latter a twelve-hour notation. The astronomical day would therefore be identical with the universal day, reckoning from 0 to 24 hours, and commencing at midnight. From the fourth annual report of the Toronto Physical and Astronomical Society, it appears that 170 answers to the question had been received. Of these, 107 were in the affirmative, and 63 in the negative. Twenty-one astronomers in the British Islands thought the change desirable, and four were against it. In the United States, twenty-eight astronomers favoured the departure from present custom, and ten opposed it. German astronomers are strongly against the suggested change, as many as thirty-one replying in the negative, while only seven sent affirmative answers. In fact, Germany was the only country which furnished a majority of negative answers. Most of the replies received were simply in the affirmative or in the negative, but many were qualified in some respect. All the categorical replies were in English, and of the answers received from foreign countries, with notes written in English, five were from Germany, four from Italy, four from Austria, and one each from Russia, France, Norway, Holland, and Colombia. As Miss A. A. Gray, who compiled the answers, points out, this shows that the English language is rapidly becoming an international medium for the communication of scientific information.

THE HEIGHT OF AN AURORA.—Among the many interesting communications to the Astronomical and Physical Society of Toronto during the year 1893, and contained in the volume of the *Transactions* just received, is one by Mr. Arthur Harvey, on the widely observed aurora of July 15. During the display, an arch of auroral light rolled up out of the north, and passed the zenith of Toronto, spanning the sky from east to west. Its width was fairly uniform, being from  $5^{\circ}$  to  $7^{\circ}$ . After lasting for several minutes, its continuity broke up in the east, it wavered at the zenith, and soon vanished. Fortunately, Mr. G. E. Lumsden saw the arch break up and vanish in the same manner. He was at Bala, 110 miles north of Toronto, and saw the arch projected across the constellation Aquilla, at a point some five degrees north of the celestial equator, or  $40^{\circ}$  south of the zenith. At Toronto, Mr. Harvey saw the same arch at the same time lying across Lyra, at a point about  $10^{\circ}$  south of the zenith. From these observations the perpendicular height of the arch was found to be 166 miles, and its breadth about 15 miles. If the arch maintained an equal height above the earth, its ends were 1150 miles away, so that the magnificent sight was presented of an auroral belt in the sky with 2300 miles between its two extremities.

AN ANNULAR ECLIPSE OF THE SUN.—There will be an annular eclipse of the sun to-morrow, which, however, will not be visible in this country. It will be seen as a partial eclipse in Norway and Sweden, Eastern Europe, and Asia; and as a central one along a line starting from a point in the Indian Ocean, crossing India a little north of Madras, passing through Calcutta, Upper Burma, China, and Eastern Siberia. The central eclipse begins at 2.24 a.m. Greenwich mean time, in longitude  $53^{\circ} 48'$  east, latitude  $6^{\circ} 51'$  north, and ends at 5.23 a.m. in longitude  $157^{\circ} 38'$  west, latitude  $62^{\circ} 48'$  north. The greatest duration of annularity will be about 32 seconds. An eclipse of this kind excites but little scientific interest, the chief observations of value being those of the times of the four contacts.

## THE SATELLITE OF NEPTUNE.

THE planet Neptune is now in the constellation Taurus, a little to the north-east of Aldebaran; so the following free translation of a paper on its satellite, read by M. Tisserand to the Société Astronomique de France in February, and reprinted in the March number of *L'Astronomie*, is of interest at the present time.

Less than a month after Galle discovered Neptune<sup>1</sup> in the place assigned to it by Le Verrier, Lassell suspected the existence of a small satellite, and confirmed his suspicion in 1847. This body is very faint, being of the fourteenth magnitude, and a large telescope is required in order to see it. According to Pickering's photometric observations, its size is about the same as that of our moon, but it is 12,000 times further removed from us, and hence the light we receive from it is very dim.

It is well known that the satellite is in retrograde motion round Neptune, in the same way as the satellites of Uranus. In this respect these two planets on the borders of the solar system strikingly differ from the others. Comparing Neptune with other planets, it would be expected that he would possess more than one satellite, but though many scrutinies have been made with powerful telescopes, particularly that at Washington, no one has found a new attendant.

Neptune's moon is not troubled by the motions of companion satellites, so it ought to present a movement of great simplicity, rigorously realising the geometrical movement considered by Kepler. In fact, some astronomers have proposed to use the satellite as a means of testing the uniformity of certain movements in the planetary system. The body would constitute a clock of marvellous precision, and with nothing apparently to put it out of order. Accumulated observations have, however, brought to light a singular fact with regard to the satellite's orbit. Five or six years ago, Mr. Marth pointed out that observations made from 1852 to 1883 showed that the orbit was being slowly displaced in a certain direction, its inclination to the plane of Neptune's orbit during this period of thirty-one years having increased by about five degrees—an amount too great to be ascribed to errors of observation. What is more, the observations made by H. Struve with the great refractor at Pulkova, during the last ten years, confirm this variation, both as regards its direction and amount. This being so, the question arises as to the cause of the disturbance.

There can be no hesitation in attributing the change to the oblateness of the planet. The amount of polar compression has not yet been determined by direct measurement, and it will doubtless escape detection for some time to come. This is because the disc of Neptune only subtends to us the small angle of about two seconds of arc, and if the oblateness were, say, 1/100, the ellipticity of the disc would be beyond our perception.

But in order to account for the changes established by observation, it is necessary to take other matters into consideration. If the plane of the orbit of the satellite coincided with the equator of the planet, there would be no reason why this coincidence should not be maintained indefinitely. It seems, however, that the two planes are inclined at a certain angle, and it can be demonstrated that in this case the orbital plane must be displaced with respect to the equatorial one, while the angle between the two remains constant.

If the poles of these two planes are supposed to be projected upon the celestial sphere, the former will move uniformly round the latter in a circle, and by the accumulation of observations for two or three centuries, the position of this circle could be very accurately determined. The centre of the circle would be above the north pole of the planet; so by this means it becomes possible to determine the direction of the polar axis—a datum which, as we have seen, cannot be determined directly. The facts at present at the disposal of astronomers are insufficient for the purpose of doing this. It appears probable, however, that the angle referred to is from twenty to twenty-five degrees, and the oblateness less than 1/100. Prof. Newcomb, without going into detailed calculations, has assigned the same cause to the phenomenon.

The fifth satellite of Jupiter, discovered by Prof. Barnard in 1893, ought to exhibit a similar change to that undergone by Neptune's attendant. It does not appear that the four larger Jovian satellites are able to disturb the new one in an appreciable manner; in this case, moreover, the large oblate-

ness of Jupiter must be taken into consideration. But the oblateness produces another effect. It may not modify the position of the orbit of the satellite because this small body revolves in the plane of the planet's equator, but it may cause the orbit to turn in its plane, and calculations show that it ought to produce a complete turn in about five months. If, therefore, this orbit is not exactly circular, but ever so little eccentric, a time must come when the satellite must appear at a greater distance from the east than from the west limb of the planet, and this is what Prof. Barnard has actually observed. But seventy-five days after these distances must be reversed, for the greater distance should then be from the west limb. It is to be hoped that future observations will decide this point. The effect referred to ought also to be shown by the satellite of Neptune, though it is much less pronounced than the change of the orbital plane; nevertheless, its determination will not be long delayed.

## SCIENCE IN THE MAGAZINES.

SCARCELY a month passes but what we have to notice astronomical articles in the magazines, a fact which testifies to the interest taken in all that appertains to stargazing. The *Century* contains an article of this kind, entitled "A Comet-Finder," by Mr. F. W. Mack, and recounting the ways and work of Mr. W. R. Brooks, well known among astronomers as the discoverer of numerous comets. The title of the article is rather misleading, for while it refers to the man, it is apt to be confounded with the instrument he uses. From the article it appears that Mr. Brooks was born at Maidstone, in 1844, and went to America when he was thirteen years old. In 1870 he settled in Phelps, sixty miles from Syracuse, where he became the village photographer. Like many other notable astronomers, Mr. Brooks made his own telescopes. His first comet was discovered in 1881 with a five-inch reflector constructed by himself, and shortly afterwards he made the nine-inch silver-on-glass Newtonian instrument, with which, up to 1888, he discovered ten comets. Mr. Brooks then removed to Geneva, N. Y., to take charge of the Smith Observatory, which possesses a two-inch refractor. During his residence there he has discovered eight comets, four of them within less than one year. The total number of his discoveries is now nineteen. The article is illustrated by a photograph of Mr. Brooks, and views of some of the comets found by him. Under the title, "Driven out of Tibet," Mr. W. W. Rockhill describes an attempt made by him in 1891-92 to pass from China through Thibet into India. Mr. G. E. Waring discusses the different methods of sewage disposal, under the heading "Out of Sight, out of Mind." He favours an irrigation system similar to that used at Wayne, Pennsylvania. From an excellent article on "Forest Legislation in Europe," by Mr. B. E. Fernow, we obtain the following facts. In Germany, contrary to general opinion, laws regarding the use of private forest property are less stringent than among other nations who have paid attention to the matter. In Prussia, which represents two-thirds of Germany, private forests are absolutely free from governmental influence. In Saxony no State control exists. Other States differ in their laws regarding forest property. Of the private forests, seventy per cent. are without any control whatever, and thirty per cent. are subject to slight supervision. In Austria, however, the status of forest legislation is very different, a strict supervision being exercised not only over forests owned by communities, but also over those belonging to private individuals. To ensure a rational management of the forests, the owners of large areas must employ competent foresters whose qualifications satisfy the authorities, opportunity for the education of such being given in eight schools of forestry. In Hungary and Italy also the control of private forest property is vested in the State. In Russia, until lately, liberty to cut, burn, destroy, and devastate forests was unrestricted, but in 1888 a law came in force which, to some extent, put an end to this liberty of vandalism. The Russian Government now sustains twenty-four schools of forestry. A federal law was passed in Switzerland in 1876 giving the federation control over the forests of the mountain region, embracing eight entire cantons and parts of seven others, or over one million acres of forest. The employment of educated foresters is obligatory, and to render this possible, courses of lectures to the active foresters are instituted in the cantons. There is also an

<sup>1</sup> Neptune was looked for and found by Galle on September 23, 1846; the satellite was discovered by Lassell on October 10 of the same year.

excellent fore-stry school at Zurich. In France not only does the State manage its own forest property in approved manner, and supervise the management of forests belonging to communities and other public institutions, but it extends its control over private forests by forbidding any clearing except with the consent of the forest administration.

Sir Robert Ball commences a series of articles on "The Great Astronomers" in *Good Words*, the subject of his sketch this month being Tycho Brahe. Dr. Dreyer's book on "The Life and Work of Tycho Brahe" has furnished the author with most of his facts, so the article can hardly be abstracted, and there is nothing in it to comment upon. Mrs. Percy Frankland contributes an article entitled "Half an Hour with the Microbes," and manages to compress a large amount of information in a few pages. An article by Sir Herbert Maxwell, headed "Assisted Sight," will be found interesting to Selbornians, for it deals with the sights of bird-life and movement which a spy-glass reveals to him who will be at the trouble to carry it.

A passing notice must suffice for the other magazines received by us.

In *Longman's*, Mr. C. T. Buckland, a cousin of the late Frank Buckland, describes some of his personal experiences with alligators, and W. Schooling recounts some of the myths and marvels concerning the Pleiades. Lord Lilford writes upon the destruction of wild birds in the *National Review*. He considers that the legal protection of eggs under specific names is impracticable, if not utterly impossible. The *National* also contains an article of interest to nature lovers, by "A Son of the Marshes." Two articles of more or less scientific interest appear in *Chambers's Journal*, one on "The Smoke Problem," the other on the new powder, Amberite. Mr. Phil Robinson contributes to the *Contemporary* a description of natural objects in spring, in which poetical fancy is happily blended with scientific observation. Serpent-worship, and the serpent's strange appearance and manner of progression, is Mr. W. H. Hudson's theme in the *Fortnightly*. Mr. R. B. Anderson describes, in *Scribner*, a winter's journey up the coast of Norway, and Mr. Morley Roberts writes on cannibalism in the *Humanitarian*.

DUST AND METEOROLOGICAL PHENOMENA.<sup>1</sup>

IN this communication are given tables containing over 1000 observations of the dust particles in the atmosphere, along with simultaneous observations on other meteorological phenomena, made by the author during the years 1891, 1892, and 1893. In Parts i. and ii. on the same subject are nearly 500 similar observations, made at the same places, during the two preceding years; so that there are in all now over 1500 observations of atmospheric dust, to produce which required the testing of over 15,000 samples of air. With such a number of observations it seemed not unreasonable to expect that more definite results could now be worked out than were possible before.

At the beginning of the paper reference is made to observations made in the south of France, at Hyeres, Cannes, and Mentone. After this the observations made at the Italian lakes are described. At none of the places in these districts was very pure air ever met with. No air with a smaller number of particles than 600 per c.c. was tested.

At Baveno, in addition to the usual test at low level, a number were made at different elevations on the slopes of Monte Motterone, with the following results. With the wind blowing up the slopes, the means of seven observations gave the following number of particles per c.c. at the different levels:—

|               |               |               |               |
|---------------|---------------|---------------|---------------|
| At low level. | At 1000 feet. | At 1500 feet. | At 2000 feet. |
| 4857          | 4750          | 3430          | 3125          |

And the mean values of eight observations when the wind did not blow up the slopes:—

|               |               |               |               |
|---------------|---------------|---------------|---------------|
| At low level. | At 1000 feet. | At 1500 feet. | At 2000 feet. |
| 4743          | 3270          | 2195          | 1453          |

Thus with the wind blowing up the slopes, and carrying up the impure air, the amount of dust at 2000 feet was only reduced

<sup>1</sup> Abstract of paper read before the Royal Society of Edinburgh, by John Attkin, F.R.S., on February 19. (Communicated by permission of the Council of the Society.)

to 0.64 of the number at low level, while if the wind was from other directions it was reduced to 0.3.

The observations made on the Rigi Kulm during three visits, of a week each, in the different years are then discussed, and the conditions existing during each day described separately, along with the different meteorological phenomena witnessed on the different days. The conclusion arrived at in the previous visits as to the exaggerated descriptions given by many writers, of the beauty of the colouring on earth and sky seen at high level at sunrise and sunset, is entirely confirmed. During the visit, in the five years no colouring at sunrise or sunset has been witnessed from the Rigi equal to what is frequently seen at low level.

The observations show that the sunset colours depend very much on the amount of dust in the air. When the atmosphere is comparatively free from dust the colouring is cold, but the lighting is clear and sharp; and when there is much dust, there is more colour on the mountains and clouds, and in the air itself, and the colouring is warmer and softer. At high level the colouring is not only more feeble, but it is also of shorter duration. A thick veil of haze seemed to hang in the air between the observer and the mountains on all days when the number of particles was great, and it became very faint when the number was small.

The paper then proceeds to investigate the effect of the direction of the wind on the number of particles at this station, and discusses the conditions with the aid of the dust observations and the weather charts of Switzerland—the general air calculation over Switzerland being obtained from the reports of the high level observatories, namely the Santis, St. Gothard, and Pilatus, and low level currents from the reports of the low level observing stations. The results of this investigation are summed up in two tables. In one of these tables are given the highest and lowest numbers observed when the wind was southerly and blew from the pure area of the Alps; and in the other, the observations when the wind was from the inhabited parts of Switzerland. The following are the means of all the observations:—

|                    |                 |                |                      |
|--------------------|-----------------|----------------|----------------------|
| Direction of wind. | Highest number. | Lowest number. | State of the air.    |
| Wind from Alps     | 1305            | 421            | Clear to very clear. |
| Wind from plains   | 5750            | 1063           | Medium to thick.     |

The condition of the air on the occasions of the different visits to the Rigi varied greatly. During the visit in 1889, the wind always blew from the Alps, the number of particles was low, and air very clear. During the visits in 1892 and 1893, the wind never blew steadily for any length of time from the pure direction, the air was always much hazed, and the number of particles great.

The effect of the amount of dust on the transparency of the air on the Rigi is then discussed. The above table, showing the effect of the direction of the wind on the number of particles, also shows the effect of the dust on the transparency. On all days when the wind was southerly, and the number of particles low, the air was clear, or very clear; whereas when the wind blew from the plains, and the number went high, the air was always greatly hazed. The effect of the dust on the transparency is then shown in another way, the result being given in the following table, in which are entered the number of times Hochgerrach was visible, and the condition of the air at the time as regards haze, dust, and humidity:—

|                          |                                |                              |                      |
|--------------------------|--------------------------------|------------------------------|----------------------|
| Number of times visible. | Amount of haze on Hochgerrach. | Number of particles per c.c. | Wet bulb depression. |
| 8                        | ¼ to ½                         | 326 to 850                   | 3° to 10°            |
| 2                        | ¾                              | 1375 to 1575                 | 6°·5 to 8°           |
| 3                        | Just visible                   | 1825 to 2050                 | 4° to 6°·5           |

Hochgerrach is situated at a distance of about seventy miles from the Rigi, in an easterly direction; its visibility, therefore, may be taken as an indication of very clear air. The above table shows that it was visible on thirteen occasions. On eight of these it was only from ¼ to ½ hazed, and the number of particles was at a minimum. The table also shows that as the number of particles increased the haze also increased, and at last the mountain became invisible when the number went a little over 2000 per c.c. As the number of particles frequently remained above 2000 for days at a time, Hochgerrach could only be seen at intervals.

The paper then passes on to consider the daily maximum on

the Rigi. The daily maximum does not appear on all days; winds from pure directions generally prevent it, either by checking the ascent of the valley air, or by the valley air being pure, or by the pure valley air not being much heated by the sun, and therefore having but little tendency to rise. The daily maximum is very marked when the wind is from the plains. The hour at which the rise in numbers begins and the hour of maximum are very irregular. Sometimes the rise begins in the morning, but sometimes it is the afternoon before it puts in its appearance. The maximum number is generally attained some time in the afternoon, if not checked at an earlier hour by change of wind, or by clouds. The amount of the daily maximum varies greatly; sometimes it is only two or three times the morning number, but it has been observed as much as eight times.

While on the Rigi the author had frequent opportunities of observing the well-known tendency of Pilatus to be shrouded in cloud. The clouding was frequently observed to extend down the slopes far below the level of the Rigi Kulm, while the Rigi kept free of cloud. It is shown that this greater cloudiness of Pilatus is only what might be expected from the nature of the surroundings. The Rigi is a true isolated mountain, whereas Pilatus is not, though it looks quite as isolated as the Rigi from many points of view. It is, however, only the terminal peak of a very long wall of mountains extending in a westerly direction for about twenty-five miles. As the upper ridges of this wall are from 6000 to 7000 feet high, all winds from the north and west are compelled to rise when they meet this barrier, and in rising condensation takes place; whereas winds from all directions can pass on all sides of the Rigi, and are not compelled to rise to the same amount. It is well known that the north and west winds cause Pilatus to be clouded, and these are the winds specially compelled by the Pilatus range to rise and to form clouds.

The observations made at Kingairloch, in Argyllshire, are then described, along with a parallel series of observations made at the same hours on Ben Nevis. Diagrams are given showing the conditions at the two stations during July in the different years. Attention is first drawn to some very abnormal dust readings obtained at Kingairloch. During north-west winds the number of particles is generally very low, but on the afternoons of some days the numbers went high. It was found that these abnormal readings were always accompanied by certain conditions of weather: if the sky remained completely clouded all day, the numbers were always low during the whole of the day; but, on the other hand, if breaks formed in the clouds, the number began to rise, and the increase was very much in proportion to the amount of clear sky. It is also shown that these abnormal readings came far more frequently with anticyclonic than with cyclonic circulation; but as these are the conditions which bring more or less cloudy skies, they do not seem to have much influence in themselves. Tests were made to see if the abnormal readings were due to local impurity, but no evidence of this could be obtained. The fact that they come and go with sunshine seems to negative any such idea; at least, if they are local, they must be of a nature of which at present we know nothing. It is suggested that it may be possible that sunshine under certain conditions may produce some change in the constituents of our atmosphere, which gives rise to something that forms a nucleus in saturated or supersaturated air. The fact that during the days of abnormally high readings the air did not become hazed to anything like the extent indicated by the number of particles, seems to suggest that these nuclei are of molecular dimensions, and it is even possible they may not be nuclei at all while the air is dry, but form nuclei in saturated air. Nothing corresponding to these abnormal readings can be discovered in the observations made at other places. In discussing the effects of dust, these abnormal readings have been omitted, and the mean of the morning and evening figures taken as the number for the day.

The investigation of the amount of dust, and the direction of the wind, shows that winds from the north-west quadrant are the purest at this station, and those from the south-east quadrant the most impure. All the high readings at Ben Nevis were observed in south-east winds. The effect of the direction of the wind is shown by diagrams, the dust curves being low with north-westerly, and very high with south-easterly winds.

The next point discussed is the relation between the transparency of the atmosphere and the number of dust particles.

The observations made during the last three years, as in the previous two, show that on all days when the number was small the air was clear, if the wet bulb depression was over 2°. In order to make the haze observations more satisfactory, it has been the custom for the last three years to enter in the notes the *limit of visibility in miles* at the hour the other observations were taken. This is done by estimating the amount of haze on a mountain at a known distance, and calculating the extreme limit it would be visible at in the same air. In working out the relation between the number of particles and the transparency, it is necessary to reject all observations made during rainy or doubtful weather. For reasons frequently explained, the observations were separated into sets, according to the humidity at the time; all the observations taken when the wet-bulb depression was from 2° to 4° being entered in one table, all those when it was from 4° to 7° in another, and all when it was 7° to 10° in a third. In the tables were entered the highest, lowest, and mean numbers of particles observed, while the conditions remained at all steady, and in another column was entered the limit of visibility at the time. The different observations were arranged in the tables in the order of the mean number of particles, beginning at the top with the observation with the least number, and ending at the foot with the observation with the greatest number. This will be easiest understood by an example. The following table represents in abstract one of the tables with the Kingairloch observations for 1893, when the wet bulb depression was from 4° to 7°. As it is unnecessary to give all the observations, only the first and last are entered.

| Date.       | Lowest number. | Highest number. | Mean number. | Limit of visibility in miles. | C.      |
|-------------|----------------|-----------------|--------------|-------------------------------|---------|
| July 14 ... | 85 ...         | 850 ...         | 467 ...      | 250 ...                       | 117,000 |
| July 2 ...  | 1600 ...       | 2400 ...        | 2000 ...     | 40 ...                        | 80,000  |

Mean.  
106,000

If we look down the column headed limit of visibility in the different tables, it is seen that in all of them the highest limit of visibility is always associated with the least amount of dust, and the least limit with the greatest amount of dust. The tables show clearly that the amount of haze depends directly on the number of dust particles in the air. It seemed probable that the same number of particles would produce the same amount of haze, whether these particles be distributed through a long or short length of air. If this be so, then the mean number of particles multiplied into the limit of visibility ought to be a constant. In the tables are columns headed C, in which the numbers so calculated are entered. From the tables it is seen that though the values of C for the different observations are not alike, yet they agree as well as could be expected, considering the difficulty in estimating the amount of haze and the probable variations in the size of the dust particles, which would influence their hazing effect. The tables for the Kingairloch observations in 1893 show that when the wet bulb depression was between 2° and 4° the value of C was 77,000; when the wet bulb depression was from 4° to 7° C was equal to 106,000 (see table above), and when the wet bulb depression was from 7° to 10° the value was 141,000.

The Kingairloch observations, when arranged in these tables, show the effect of the humidity, as well as of the dust, on the transparency. The value of C when the wet bulb depression is from 2° to 4° is only about one-half of what it is when the depression is from 7° to 10°. The damper air has therefore nearly double the hazing effect of the drier, because C is proportional to the number of particles required to produce a complete haze, that is, a haze thick enough to shut out all view. What that number of particles really is, is obtained by multiplying the different values of C by 160,932, the number of centimetres in a mile. When this is done we get the number of particles of dust per square centimetre, and of lengths of from 10 to 250 miles required to produce complete haze in air giving different wet bulb depressions.

| Wet bulb depression. | Number of particles required to produce complete haze. |
|----------------------|--------------------------------------------------------|
| 2° to 4° ...         | 12,500,000,000                                         |
| 4° to 7° ...         | 17,100,000,000                                         |
| 7° to 10° ...        | 22,600,000,000                                         |

The above figures show the effect of the humidity very clearly. Nearly double the number of particles are required to produce

the same amount of haze when the air is very dry than when it is dampish. It will also be noticed that the transparency of the air is roughly proportional to the wet bulb depression. It should be noted that it is not the amount of vapour in the air that produces this effect, but the nearness of the vapour to the dew point which seems to enable the dust particles to condense more vapour by surface attraction and otherwise, and thus, by becoming larger, they have a greater hazing effect. The above table shows the relation between the humidity, the dust, and the transparency, so that knowing any two of them we can calculate the third.

The paper then proceeds to an examination of the relation between the dust and the haze from the Ben Nevis reports for the periods of the Kingairloch observations, when it is seen that on all days when the air was very clear the number of particles was small at high and low levels, and the transparency was least when the amount of dust was greatest. On one occasion Ireland, which is 125 miles distant, was seen from Ben Nevis, and only a thin haze was visible. On that day the number was about 200 per cc. at low level, and under 200 at high level, and, as the numbers remained very constant at both levels all day, this day may be looked upon as one of the purest as well as one of the clearest observed.

The next set of observations discussed are those made at Alford, in Aberdeenshire. The air at that station was always very pure, except when the wind was southerly, and brought impure air from the inhabited districts. The values of C for the different humidities were calculated from the Alford observations, and the results will be found in the following table. When at Alford some observations were made on Callievar, a hill about 1747 feet high. The values of C from three observations made on Callievar do not agree with the others, being only about one-half as great.

The difference in the value of C obtained from the Callievar observations opened up the question of the value of C as obtained from observations at low level. The difference in the two values might be due to the tests at low level being made in locally impure air, near the surface of the earth, while the estimates of haze are made partly through purer upper air, and in calculating the value of C it is assumed that the air all through the length in which the haze is estimated has the same amount of dust as at low level, whereas it may have less. If, then, the low level observations be made in polluted areas, they will give too high a value for C. The difference between the amount of dust at Kingairloch and Ben Nevis does not, however, account for anything like the difference given by the Callievar observations. As there were only three observations made on Callievar, it was thought as well to test this point by working out the values of C from the Rigi observations. When this was done they were found to be similar to those for the Kingairloch observations. The following table shows the different values of C at the different wet bulb depressions, calculated from the different sets of observations:—

| Place.                      | Wet bulb depression. |          |           |
|-----------------------------|----------------------|----------|-----------|
|                             | 2° to 4°             | 4° to 7° | 7° to 10° |
| Kingairloch, 1893 . . . . . | 77,000               | 106,000  | 141,000   |
| „ 1892 . . . . .            | No observations      | 117,000  | 175,000   |
| Alford . . . . .            | 75,000               | 95,000   | 125,000   |
| Rigi Kulm . . . . .         | 75,000               | 104,000  | 124,000   |
| Mean . . . . .              | 76,000               | 106,000  | 141,000   |

What are called purifying areas in this paper are those regions on the earth's surface in which the air loses more impurity than it gains. In all densely inhabited areas it loses its purity, and in all uninhabited ones it tends to regain it; but all uninhabited areas are not equally good purifying ones. Much of the dusty impurity discharged into our atmosphere from artificial sources, by volcanoes, and by the disintegration of meteoric matter, falls to the ground, but much of it is so fine it will hardly settle. The deposition of vapour on these very small particles seems to be the method adopted by nature for cleansing them away; they become centres of cloud particles, and ultimately fall with the rain. It may be remarked that all very low numbers

at Kingairloch were obtained in close misty rain, and in the clouds near the earth, in the very area in which the dust was being used up. This experience is confirmed by the observations made on Ben Nevis. From this it might be expected that the areas where most clouds form, and most rain falls, will have the greatest purifying influence. This conclusion is confirmed by the dust observations made in air coming from four great purifying areas, namely, the Mediterranean, the Alps, the Highlands of Scotland, and the Atlantic. The following figures show the mean values of the lowest readings observed in each of the five years in air coming from these areas; the Mediterranean, 891 per c.c.; the Alps, 381; the Highlands, 141; and the Atlantic, 72. It should be noted that these are not the mean numbers, but the mean of the lowest, and represent the maximum purifying power of the different areas.

#### UNIVERSITY AND EDUCATIONAL INTELLIGENCE.

THE sixth summer meeting of University Extension and other students will be held in Oxford from July 27 to August 24. Courses of study are provided in numerous subjects of interest and importance. Among the science courses are included lectures on physical problems relating to astronomy, by Dr. A. H. Fison. Mr. Henry Balfour, Curator of the Pitt-Rivers Museum, will lecture upon the arts of mankind and their evolution, illustrating his discourses by specimens exhibited in the museum. Geology, both lectures and field work, has been undertaken by Prof. A. H. Green, F.R.S. Dr. C. H. Wade will conduct lectures and classes in hygiene, and Mr. J. E. Marsh have charge of students in courses of practical chemistry at the chemical laboratory in the University Museum. A lecture on colour vision will also be given by Captain W. Abney. In addition to these courses, and many others on history, literature, economics, and art, there will be a course on the science and art of education, comprising lectures on psychology, the theory of education, and the educational systems of England, France, and Germany. Instruction in wood-carving, Sloyd, and photography can also be obtained at the meeting.

THE *Oxford University Extension Gazette* announces that the council of the London Society for the Extension of University Teaching has decided to hold in London, on June 22 and 23, a conference representative of all the authorities concerned in the work of University Extension. The purpose of the conference will be to sum up and present the educational results of University Extension work since the inauguration of the movement, and to discuss practical proposals and a general policy for the future in the light of past experience. Official representatives of the Universities of Oxford, Cambridge, and London will be asked to preside over the three sessions of the conference, which by emphasising the unity of the University Extension system, will doubtless increase public interest in this branch of educational work.

#### SCIENTIFIC SERIALS.

*Bulletin de l'Académie Royale de Belgique*, No. 1.—Another word on the definition of latitude, by F. Folie. If a displacement of the pole of inertia really exists, the difference between the astronomical latitudes of two places situated upon opposite meridians, such as Berlin and Honolulu, will be positive in summer and negative in winter. It is therefore best to take as a point of reference, not the instantaneous pole, but the mean position of the pole of inertia, *i.e.* the geographical pole. As regards the direction of displacement of the pole of inertia, M. Folie's latest conclusion is that it is retrograde, with a period of 321 instead of 423 days.—Explanation of the systematic differences between the catalogues of Greenwich, Melbourne, and the Cape, by diurnal nutation and the annual displacement of the pole of inertia, by the same author. The hitherto unexplained systematic differences between the three catalogues are eliminated by the introduction of the constant term entering into the expression for diurnal nutation.—A new gradual synthesis of benzene, by Maurice Delacre. This synthesis starts, like the one previously described, with acetophenone, and passes through dypnone and dypnopinacone to the  $\gamma$  varieties (not the  $\alpha$  series) of dypnopinacone, dypnopinalcohol, and dypnopinalcolene to triphenylbenzene.—Application of the refractometer

to the study of chemical reactions, by J. Verschaffelt. The Pulfrich refractometer used, when compared with a standard spectrometer, gave a constant difference in the index of refraction amounting to  $-0.00059$ , this being probably due to the insertion of a prism of different material in the refractometer. With this correction the refractometer readings could be taken as absolutely trustworthy to the fourth decimal place. The author shows that all disagreements with the law governing the index of refraction of mixtures indicate a chemical reaction (1) if the observed index is lower than the calculated index; or (2) if it is higher by such an amount that the difference cannot be attributed to a change of volume.—On the parietal eye, the epiphysis, the paraphysis, and the choroid plexus of the third ventricle, by P. Francotti. This paper contains a detailed description, illustrated by excellent microphotographs, of these rudimentary organs as they appear in the slow-worm and the human embryo.

*Wiedemann's Annalen der Physik und Chemie*, No. 3.—On elliptic polarisation of reflected light, by K. E. F. Schmidt. This first part of the work deals with the influence of foreign surface layers. Contrary to the conclusions of Drude, Röntgen, and Lord Rayleigh, the author shows that no observation justifies us in assuming that the elliptic polarisation of light reflected from polished surfaces is produced by layers of the polishing material. The polish attached to the mirror is only capable of modifying the phenomenon. The constancy of the ellipticity of light reflected from mirrors cleaned by means of a gelatine film, which is pulled off when hardened, implies a constancy of the cause of this phenomenon, independent of the polishing powder used.—Remarks upon Paschen's paper on "The emission of heated gases," by E. Prinzheim. The author maintains that the so-called discontinuous heat spectra observed by Paschen, cannot be fitly described as such, since the "band" due to  $\text{CO}_2$  extends over a region three times as large, and that of steam over one twenty times as large, as the whole visible spectrum.—On normal and anomalous changes of phase during the reflection of light by metals, by W. Wernicke. The change of phase produced by the reflection of light from a silver film between two transparent media, the anterior one of which has the higher index of refraction, is an acceleration which increases continuously from zero to  $\frac{1}{4}$  or  $\frac{2}{3}$  of a wave-length as the thickness of the silver grows from zero to opacity. This is the normal change of phase. An anomalous retardation takes place when there are traces of another substance between the silver and the front medium. It may amount to something between  $\frac{1}{4}$  and  $\frac{2}{3}$  of a wave-length.—On the proportionality between lowering of freezing point and osmotic pressure, by Svante Arrhenius.—On a more exact method for the determination of the lowering of freezing points, by E. H. Loomis. The apparatus used was an improved form of Beckmann's freezing tube. To avoid the fluctuations of temperature associated with the melting or solidifying of ice in water, sometimes amounting to  $0.1^\circ \text{C}$ ., the tube was lengthened so as to remove the substance from the warmer air, and a freezing mixture was in each case employed, which gave a temperature only about  $0.3^\circ$  lower than the actual freezing point of the substance experimented upon.

In the numbers of the *Journal of Botany* for March and April, the articles are almost entirely descriptive. Mr. E. G. Baker has an interesting paper on the section *Rhynchopetalum* of *Lobelia*, in which two new species from Africa are described and figured.

## SOCIETIES AND ACADEMIES.

### LONDON.

Royal Meteorological Society, March 21.—Mr. R. Inwards, President, in the chair.—Mr. W. H. Dines read a paper on the relation between the mean quarterly temperature and the death-rate. The Registrar-General's Quarterly Returns for the whole of England since 1862 were taken by the author, and the number of deaths in each quarter expressed as a departure per thousand from that particular quarter's average; the value so obtained being placed side by side with the corresponding departure of the temperature at Greenwich from its mean value. The rule seems to be that a cold winter is unhealthy, and a mild winter healthy; and that a hot summer is always unhealthy, and a cold summer healthy. Mr. Dines also

read a paper on the duration and lateral extent of gusts of wind and the measurement of their intensity. From observations and experiments which he has made with his new anemometer, Mr. Dines is inclined to think that a gust seldom maintains its full force for more than one or two seconds; and also that the extreme velocity mostly occurs in lines which are roughly parallel to the direction of the wind.—Mr. R. H. Scott, F.R.S., exhibited a diagram showing some remarkable sudden changes of the barometer in the Hebrides on February 23, 1894. At 8 a.m. the reading at Stornoway was 29.39 inches, being a fall of 0.7 inch since the previous day, and at 6 p.m. the reading was 28.58 inches. From the trace of the self-recording aneroid it appears that the minimum, 28.50 inches, occurred about 5.30 p.m., and that the fall during the half-hour preceding the minimum was nearly 0.2 inch, the rise after the minimum being nearly as rapid.—The other paper read was on the calculation of photographic cloud measurements, by Dr. K. G. Olsson.

Geological Society, March 21.—Dr. Henry Woodward, F.R.S., President, in the chair.—The following communications were read:—On the origin of certain novaculites and quartzites, by Frank Rutley. The novaculites of Arkansas have already been admirably described by Mr. Griswold in vol. iii. of the Arkansas Survey Report for 1890. One of the characteristic microscopic features in Ouachita stone is there stated to consist in the presence of numerous cavities, often of sharply-defined rhombohedral form, which Mr. Griswold considers to have been originally occupied by crystals of calcite or dolomite. The author, while admitting that the cavities were no doubt once filled by the latter mineral, differs from Mr. Griswold, and some of the authorities he cites, concerning the origin of the rock. Crystalline dolomites, when dissolving, become disintegrated into minute but well-formed rhombohedra. As the process of dissolution proceeds these crystals may become so eroded that the rhombohedral form is no longer to be recognised. The author pointed out that no inconsiderable proportion of the cavities in Ouachita stone present irregular boundaries, such as the moulds of partially eroded rhombohedra would show. He then offered a fresh interpretation of these cavities, so far as the origin of the rock was concerned: (1) He assumed that beds of crystalline magnesian limestone have been slowly dissolved by ordinary atmospheric agency and the percolation of water charged with carbonic acid or other solvent. (2) That, as the limestone was being dissolved, it was at the same time being replaced by silica, which enveloped minute isolated crystals and groups of crystals, some perfect, others in various stages of erosion. (3) That the silica assumed the condition of chalcedony, its specific gravity, as stated by Mr. Griswold and as determined by the author, being low in comparison with that of quartz. (4) The residuum of the original dolomite or dolomitic limestone was removed, leaving the perfect and imperfect rhombohedral cavities. A calciferous, gold-bearing quartzite from the Zululand gold-fields was described, and a similar origin ascribed to it, but in this case the original rock appears to have been simply a limestone, not a dolomite. The gold seemed to occur chiefly in the calcareous portions of the rock. The author also suggested a similar origin for the saddle-reefs of the Benligo gold-field. In all of these cases the train of reasoning is based upon the conclusions arrived at in his previous paper, "On the dwindling and disappearance of limestones." He indicated that the stratigraphical relations of the Arkansas novaculites, as described in Mr. Griswold's report, were such as to warrant the assumption that limestones once occupied in the position now occupied by beds of novaculite. Many collateral matters were dealt with in the paper which cannot be given in abstract; among them was an attempt to classify quartzites. Dr. G. J. Hinde and Prof. Hull discussed some of the conclusions in the paper, and the author briefly replied.—Note on the occurrence of perlitic cracks in quartz, by W. W. Watts. The author of this communication described some specimens of the porphyritic pitchstone of Sandy Braes in Antrim, which are deposited in the Museum of Science and Art in Dublin, and in that of Practical Geology in Jernyn Street. They exhibit admirable examples of perlitic structure in the brown glassy matrix, and the presence of polygonal, circumferential, and radial cracks is noticed. The porphyritic crystals of quartz are traversed by curved fissures of retreat, not so perfect as those found in the glass, but better than those usually produced by the rapid cooling of Canada balsam. The fissures in the quartz are frequently prolonged into the matrix,

undergoing only a very slight and almost imperceptible deviation in direction at the junction. But in addition to this the quartz is often found to act as a centre of strain, the inner cracks of the perlite being wholly in quartz, the next traversing both, and the outer ones in glass only. In other examples the outer cracks of a matrix perlite sometimes enter the quartz, while in others polygonal cracks occur, and join up, in the quartz, and give off radial cracks precisely like those of the matrix. These observations lead to the conclusion that the quartz and glass must have contracted at about the same rate, and that the observation of perlitic structure in a rock with trachytic or felsitic matrix by no means proves that the rock is necessarily a devitrified glass.—Mr. Rutley, Mr. Harker, and Prof. J. F. Blake spoke upon the subject of the paper, and the author replied to their remarks.

PARIS.

Academy of Sciences, March 27.—M. Lœwy in the chair.—A study of the crystallised acetylides of barium and strontium, by M. Henri Moissan. Nearly pure crystalline C<sub>2</sub>Ba and C<sub>2</sub>Sr are produced by heating the oxides of barium and strontium (or carbonates) with sugar charcoal in the electric furnace. These bodies are immediately decomposed by water, and give pure acetylene. Their properties and reactions resemble those of calcium acetylide. When exposed to the action of halogens at a slightly raised temperature they become incandescent, the barium compound being most readily attacked.—Electric registration of the movements of the semilunar valves determining the opening and closing of the aortic orifice, by M. A. Chauveau.—On two isomeric methylecanamphors, by MM. A. Haller and Minguin. The preparation and properties

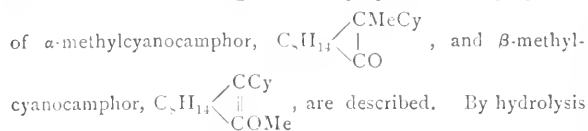

with alcoholic potash the former yields a dicarboxylic acid, the latter gives a hydroxymonocarboxylic acid and methyl alcohol.—Occultation of Spica Virginis, March 22, 1894, observed at Paris Observatory, by M. G. Bigourdan.—Observations of the planet BC, made at the Paris Observatory, by M. G. Bigourdan.—Note by M. Ch. Trépiéd on photographic observations of planets, made by MM. Rambaud and F. Sv, at the Algiers Observatory.—On the approximate development of the perturbation function in the case of inequalities of a high order.—Applications to Mercury and Venus, by M. Maurice Hamy.—On a corollary of Catalan's theorem, by M. Maurice Moureaux. An extension proving a theorem of which Catalan's is a special case. "It a sum of  $n$  squares be raised to any power which is itself a power of 2, there results a sum of  $n$  squares."—Results obtained by new arrangements for diminishing the vibrations of vessels, by M. Augustin Normand.—On the minimum electromotive force requisite for the electrolysis of electrolytes, by M. Max Le Blanc. A discussion of the remarks made by M. Berthelot on a previous paper, followed by further remarks by the latter. On the mutual solubility of salts, by M. H. Le Chatelier.—Action of nitrogen, nitrous oxide, and nitric oxide on alkaline ammoniums, by M. A. Joannis. Nitrogen has no action on sodammonium or potassammonium. Nitrous oxide, not in excess, reacts in accordance with the equation:



if the oxide be in excess a further action takes place:



An alkaline salt of hydrazoic acid is thus produced from purely inorganic materials. Nitric oxide forms the alkaline hyponitrites KNO and NaNO with K<sub>2</sub>N<sub>2</sub>H<sub>6</sub> and Na<sub>2</sub>N<sub>2</sub>H<sub>6</sub> dissolved in liquid ammonia.—On the mode of action of the pancreas in the regulation of the glucose-forming function of the liver. New facts concerning the mechanism of pancreatic diabetes. Note by M. M. Kaufmann.—On physiological antiseptics, by M. A. Tripier.—Properties of the serum of animals protected by inoculation against the poison of serpents, by M. A. Calmette. The great value of such serum as a therapeutic agent is emphasised. Injections of the protected serum together with solution of chloride of lime possess great therapeutic power.—On the copulation of some Cephalopoda.—*Sepioloa Rondelletii* (Leach), *Rossia macrosoma* (d. Ch.), and *Octopus vulgaris* (Lam.), by

M. Émile G. Racovitz.—On the seismic rose of a place, by M. de Montessus.

GÖTTINGEN.

Royal Society of Sciences.—In Nos. 15 to 21 of the *Nachrichten* appear the following papers of scientific interest:—

November 1.—Gauss, de integratione formulæ differentialis  $(1 + n \cos \phi) r d \phi$ , edited (in Latin) by E. Schering. The paper was found by Prof. W. Meyer in the archives of the Society, and probably dates from 1795.

November 8.—W. Voigt, contributions to the molecular theory of piezo-electricity.

November 15.—A. Peter, experiments on the cultivation of "resting" seeds. J. Thomae, on the differentiation of a definite integral with regard to its upper limit.

December 13.—Robert Fricke, on indefinite quadratic forms with three and four variables. H. Weber, the equalisation of temperature between two heterogeneous bodies in contact. O. Wallach, on the behaviour of the oximes of cyclical ketones (I).

December 20.—A. Brill, on symmetric functions of pairs of variables. W. Nernst, a method for the determination of dielectric constants.

December 27.—Robert Haussner, the theory of Bernoulli's and Euler's numbers.

BOOKS, PAMPHLETS, and SERIALS RECEIVED.

BOOKS.—Royal University of Ireland, Calendar for the Year 1894 (Dublin, Thom).—Fauna of British India, including Ceylon and Burma; Moths, Vol. 2: G. F. Hampson (Taylor and Francis).—A Monograph of Lichens: Rev. J. M. Crombie, Part 1 (London, British Museum, Natural History).—Papers and Notes on the Glacial Geology of Great Britain and Ireland: H. C. Lewis (Longmans).—The Health Results of Europe: Dr. T. Linn, 2nd edition (Kimpton).—Biological Lectures delivered at the Marine Biological Laboratory of Wood's Hole in the Summer Session of 1893 (Boston, Ginn).—Disease and Race: Jadroo (Sonnenschein).—Annals of the Royal Botanic Garden, Calcutta; Vol. iv., the Anonaceæ of British India: Dr. G. King (Calcutta).

PAMPHLETS.—Notes on Polarised Light: A. E. Munby (Newcastle-on-Tyne, Reid).—Investigations of Recent Typhoid-Fever Epidemics in Massachusetts: Prof. W. T. Sedgwick (Boston).—A New Story of the Stars: A. W. Bickerton (Christchurch, N.Z.).

SERIALS.—Bulletin of the New York Mathematical Society, March (New York, Macmillan).—Science Progress, No. 2 (Scientific Press).—Journal of the Royal Agricultural Society of England, Vol. v. Part 1, No. 17 (Murray).—Internationales Archiv für Ethnographie, Band vii, Heft 2 (K. Paul).

CONTENTS.

|                                                                                    | PAGE |
|------------------------------------------------------------------------------------|------|
| The New Pharmacopœia of the United States . . .                                    | 525  |
| Two Books on Forestry. By Prof. W. R. Fisher . . .                                 | 526  |
| Recent Researches on Saccharomycetes. By Dr. A. A. Kanthack . . . . .              | 527  |
| Our Book Shelf:—                                                                   |      |
| Browne: "A Year amongst the Persians" . . . . .                                    | 528  |
| Mawer and others: "Nature Pictures for Little People" . . . . .                    | 529  |
| Letters to the Editor:—                                                            |      |
| The Foundations of Dynamics.—A. B. Basset, F.R.S. . . . .                          | 529  |
| The Artificial Formation of the Diamond.—J. B. Hannay; Dr. J. Joly, F.R.S. . . . . | 530  |
| The New Comet.—W. F. Denning . . . . .                                             | 531  |
| Sun-spot Phenomena and Thunderstorms.—Rev. W. Clement Ley . . . . .                | 531  |
| A Lecture Experiment.—J. C. Foye . . . . .                                         | 531  |
| Centipedes and their Young.—F. W. Ulrich . . . . .                                 | 531  |
| Prof. Ira Remsen on Chemical Laboratories . . . . .                                | 531  |
| The Teaching University. By F. Victor Dickins . . . . .                            | 536  |
| William Pengelly. By Prof. W. Boyd Dawkins, F.R.S. . . . .                         | 536  |
| The Late Captain Cameron . . . . .                                                 | 538  |
| Notes . . . . .                                                                    | 538  |
| Our Astronomical Column:—                                                          |      |
| The Reckoning of the Astronomical Day . . . . .                                    | 542  |
| The Height of an Aurora . . . . .                                                  | 542  |
| An Annular Eclipse of the Sun . . . . .                                            | 542  |
| The Satellite of Neptune . . . . .                                                 | 543  |
| Science in the Magazines . . . . .                                                 | 543  |
| Dust and Meteorological Phenomena. By John Aitken, F.R.S. . . . .                  | 544  |
| University and Educational Intelligence . . . . .                                  | 546  |
| Scientific Serials . . . . .                                                       | 546  |
| Societies and Academies . . . . .                                                  | 547  |
| Books, Pamphlets, and Serials Received . . . . .                                   | 548  |



THURSDAY, APRIL 12, 1894.

## THE FUTURE OF CIVILISATION.

*Social Evolution.* By Benjamin Kidd. (London: Macmillan and Co., 1894.)

THIS is a very remarkable book; and one which must have a good effect in preparing students of sociology for the inevitable changes which are rapidly coming upon us. It is thoroughly scientific in its methods, inasmuch as it is based upon the theory of evolution; yet it is altogether original in its treatment of the subject, and gives us a theory of social progress which is in many respects very different from that generally accepted by evolutionists. This theory appears on the whole to be a sound one, although the author has fallen into certain errors which will be pointed out. These, however, do not materially affect the general theory.

In his first chapter, "The Outlook," the author gives a sketch of the progress of opinion during the present century, showing that the old political parties, whose watchwords are almost confined to the completion of the programme of political equality, find that the world is rapidly moving beyond them. As he well puts it:—

"One of the most striking and significant signs of the times is the spectacle of Demos, with these new battle-cries ringing in his ears, gradually emerging from the long silence of social and political serfdom. Not now does he come with the violence of revolution foredoomed to failure, but with the slow majestic progress which marks a natural evolution. He is no longer unwashed and illiterate, for we have universal education. He is no longer muzzled and without political power, for we have universal suffrage. With his advent socialism has ceased to be a philanthropic sentiment merely. . . . The advent of Demos is the natural result of a long series of concessions, beginning in England with the passing of the Factory Acts, and the legislation of combination, and leading gradually up to the avowedly socialistic legislation for which the times appear to be ripening."

A forcible sketch is given of the growing power of capitalism on the one side, and of socialism on the other; and then we come to what forms the keynote of the work, in the declaration that religion is not, as the scientific urge, a mere system of superstition and error, a clog on the wheels of progress, the enemy of science and enlightenment, and, as Grant Allen has described it, a mere "grotesque fungoid growth"; but, on the contrary, that it has been one of the most important agencies in social development, and is closely bound up with that portion of our nature to which all recent social advance is due, and which will inevitably decide the course of our future progress. Of course this has nothing to do with dogmatic religion, but only with those great ethical principles which have always formed part of religious teaching, and whose influence is in great part due to it.

The conditions of human progress form the subject of the next chapter, and it is laid down that no progress is possible without some form of selection.

"It may appear strange, but it is strictly true, that if each of us were allowed by the conditions of life to follow his own inclinations, the average of one generation would

have no tendency whatever to rise beyond the average of the preceding one."

But the author goes further than this. He fully accepts Weismann's view of the non-inheritance of acquired characters, and is under the mistaken impression that the theory of *panmixia* leads to continuous and unlimited degeneration. Many writers have pointed out that this is an error. The amount of the degeneration thus produced would be limited to that of the average of those *born* during the preceding generations in place of the average of those that had *survived*. As Prof. Lloyd Morgan puts it, the survival-mean would fall back to the birth-mean. This error is of especial importance because it is used as an argument against the possibility of any form of socialism which removes the individual struggle for existence.

The chapter which follows bears the startling heading—"There is no Rational Sanction for the Conditions of Progress"; by which is meant that at any moment the great bulk of the people have no interest in preserving the conditions that are essential to it, but rather, in altering them. The author urges that, in our existing societies, where we base on the fabric of political equality the most obvious social and material inequality, the lower classes of our population have no sanction from their reason for maintaining existing conditions. In a question of this kind reason has nothing to do with any existence but the present, which, it insists, it is our duty to ourselves to make the most of.

"The prevailing conditions of existence can, therefore, have no such sanction for large masses of the people in societies where life is a long onerous rivalry, where in the nature of things it is impossible for all to attain to success, and where the many work and suffer and only the few have leisure and ease. Regard it how we may, the conclusion seems inevitable, that, to the great masses of the people, the so-called lower classes, in the advanced civilisations of to-day, the conditions under which they live and work are still without any rational sanction."

We now come to the question of the causes of the evolution of society and of modern civilisation, which are found, not in the growth of intellect and of science, but in the continuous action of religious beliefs. The argument by which this conclusion is reached is ingenious, elaborate, and I think quite sound, but is difficult to condense. Societies and civilisations have prevailed in the struggle for existence in proportion as they have been efficiently organised, and this organisation has always rested on some form of religious sanction. The doctrines of caste, of class, of the divine right of kings, of subjection to popes and bishops, have been powerful in welding together tribes and peoples, have checked the supremacy of brute force, and have been the most efficient agency in that subordination of the many to the few which was essential to the production and accumulation of wealth, to the growth of the arts, and to the firm establishment of that national unity which is the most important factor in the growth of civilisation.

This was its function in the early development of European civilisation, but during the last two or three centuries its influence has been exerted in a different manner, which has had even more important results. As nations became more advanced

in education and the arts, and a considerable middle class arose whose interests were opposed to those of the warrior caste and to constant war and bloodshed, the ethical side of all religious teaching began to have more influence, and ideas of justice and mercy, and of the inherent rights of man independent of class or caste, obtained for the first time some real effect throughout all ranks of society. Hence arose that gradual amelioration in our punishments, that recognition of human rights in even the lowest classes, that love of equal justice for all men, which has, little by little, permeated all civilised nations; and which has culminated during the present century in the abolition of slavery and of class and religious privileges; in general education, and in the grant of almost universal suffrage. This long process of social evolution is thus briefly summarised by our author:—

“Throughout the history of the Western peoples there is one central fact which underlies all the shifting scenes which move across the pages of the historian. The political history of the centuries so far may be summed up in a single sentence: it is the story of the political and social enfranchisement of the masses of the people hitherto universally excluded from participation in the rivalry of existence on terms of equality. This change, it is seen, is being accomplished against the most prolonged and determined resistance at many points and under innumerable forms, of the power-holding classes which obtained under an earlier constitution of society the influence which they have hitherto, to a large extent, although in gradually diminishing measure, continued to enjoy. The point at which the process tends to culminate is a condition of society in which the whole mass of the excluded people will be at last brought into the rivalry of existence on a footing of equality of opportunity.”

He points out the immense significance of this process of development, which is absolutely unique in the history of the race; and that its whole tendency is, not to suspend the rivalry of life, but to raise it to the highest possible degree of efficiency as a cause of progress. This progress towards equalisation of the conditions of life is in no sense due to an intellectual movement. From the point of view of the power-holding classes the conception of the native equality of men is essentially irrational, besides being wholly opposed to what they have always conceived to be their interests. As classes they have always opposed any concessions to the masses as being destructive of society, and had not the softening of character due to ethical teaching and impulse permeated their own organisation, thus taking heart and unanimity out of their opposition, each successive concession would never have been made. The whole movement is therefore due to the all-pervading influence in our civilisation of that ever-growing fund of altruism, that development of humanitarian feelings, that deepening sense of justice, which, in the author's opinion, is “the direct and peculiar product of the religious system on which our civilisation is founded.”

There is one difficulty here with which the author fails to grapple. His fundamental doctrine is that all human progress is due to selection in the struggle for existence, whether that struggle acts most severely upon individuals or upon communities. But it is not shown *how* the rude struggles of the two thousand years terminating in the sixteenth century could have had any tendency to in-

crease and develop these altruistic and ethical sentiments. During the ages when might was right, when violence, cruelty, and rapine held sway over Europe, how were the mild, the true, the humane and the just so constantly preserved in the struggle, as to steadily increase and ultimately permeate all society as they do now? It is pointed out that neither in Greece nor in Rome, at the period of their greatest intellectual splendour, was there any such development of these altruistic and higher ethical sentiments. The mere *teaching* of their principles could not have created the sentiments themselves without selection, and selection in this case seems altogether absent. The natural possessors of such sentiments were usually buried in religious houses, and, as a rule, left no descendants. All selection seems rather to have tended to the extermination of the possessors of humane and altruistic sentiments, not to their continuous preservation and increase. Yet nothing is more certain than that they *do* now prevail to an extent never before known, and if they have not been developed by selection they must have been inherent in the race, developed perhaps at some earlier period, and have lain dormant till a more peaceful and more intellectual epoch called for their manifestation.

Though not a socialist, Mr. Kidd goes so far that, by the upholders of the present system, he will be thought hardly less dangerous an innovator. The whole drift and burthen of his work is, that we are inevitably moving towards a system of society in which, not only will all men be politically equal, but all will exist under conditions of *equal social opportunities*. Again and again he recurs to this point. He speaks of “the movement which is tending to ultimately bring all the people into the rivalry of life on conditions of equality.” He recognises that this means that the position of the lower classes will be raised “*at the expense of the wealthier classes*,” and that this is “*a conditio sine qua non* of any measure that carries us a step forward in our social development.” And again, in his concluding chapter, he thus speaks of this inevitable social movement:—

“The practical consequence is of great significance. It is, that the development in which the excluded masses of the people are being brought into the competition of life on a footing of equality of opportunity is proceeding, and will apparently continue to proceed in Great Britain, not by the violent stages of revolution, but as a gradual and orderly process of social change. The power-holding classes are in retreat before the people; but the retreat on the one side is orderly and unbroken, while the advance on the other is the steady, unhastening, onward movement of a party conscious of the strength and rectitude of its cause, and in no doubt as to the final issue.”

Although thus clear as to the nature and final result of the movement now in progress towards securing for all men “equality of opportunity in the rivalry of life,” Mr. Kidd nowhere explains what that term really means, and how complete is the revolution that it implies. It is clear, in the first place, that there can be no equality of opportunity so long as a limited class remains in possession of the land on and by which all must live, and the whole inherent value of which is the creation of society. The resumption of the land of the country by the community is therefore the first essential to “equality of opportunity.” Again, hereditary wealth is equally op-

posed to the principle, since it gives to a class the power to live permanently at the expense of the workers. In like manner, those whose parents can give their children a better education, and supply them with the means of a good start in life, have greater opportunities than have the children of the poor. Equality of opportunity demands, therefore, in the first place the same means of education for all, and, afterwards, a sufficient endowment to give every young person an equally good start in life. It will thus be seen that the principle of "equality of opportunity in the rivalry of life" goes very far indeed, and it will be judged by many to involve as drastic, and as much to be dreaded, a change as socialism itself. It differs from socialism, however, inasmuch as it will leave rivalry and competition, not only unchecked but even increased in intensity, and in order to avoid the corresponding increase of some of the evils which result from our comparatively limited competition, society will probably, *pari passu* with this development, so organise itself that every community will form a congeries of co-operative societies by which all will benefit, thus bringing about a form of voluntary municipal socialism.

This great principle of "equality of opportunities," to which Mr. Kidd's inquiry has led him, has been already fully set forth and advocated by a school of Belgian economists, and is worked out in detail by Agathon de Potter in his "Économie Sociale," published at Brussels in 1874. A similar principle obtains in the scheme of Dr. Hertzka, as explained in his interesting work, "Freeland," and now in course of experimental realisation.

Many other points of interest are discussed by Mr. Kidd, and will well repay careful study. Among these is his examination of the general belief as to the great intellectual inferiority of most savages, on which question he arrives at conclusions opposed to the views of most anthropologists. The chapter headed "Human Evolution is not primarily Intellectual" is full of original and interesting views, though mingled with details that are of doubtful accuracy. Sufficient, however, has been said to show that we have here the work of a very able thinker who deals with the fundamental problems of civilisation and progress in a far more hopeful manner than does another recent author, also of great ability—Mr. Pearson. The two following extracts from the concluding paragraph of Mr. Kidd's volume will serve to exhibit the general result of his inquiry:—

"The movement which is uplifting the people—necessarily to a large extent at the expense of those above them—is but the final result of a long process of organic development. All anticipations and forebodings as to the future of the incoming democracy, founded upon comparisons with the past, are unreliable or worthless. For the world has never before witnessed a democracy of the kind that is now slowly assuming supreme power among the Western peoples." . . .

"There are many who speak of the new ruler of nations as if he were the same idle Demos whose ears the dishonest courtiers have tickled from time immemorial. It is not so. Even those who attempt to lead him do not rightly apprehend the nature of his strength. They do not perceive that his arrival is the crowning result of an ethical movement in which qualities and attributes which we have all been taught to regard as the

very highest of which human nature is capable, find the highest expression they have ever reached in the history of the race."

Every true reformer, every earnest student of society, every believer in human progress, will cordially welcome such conclusions, founded as they are upon a careful study of history, enlightened by a thorough appreciation of the theory of evolution and the principle of natural selection.

ALFRED R. WALLACE.

#### ESSAYS IN HISTORICAL CHEMISTRY.

*Essays in Historical Chemistry.* By T. E. Thorpe, Ph.D., B.Sc., Sc.D., F.R.S. Pp. vii.; 381. (Macmillan and Co., 1894.)

A REVIEWER is not bound to read the whole of the book which he reviews. I opened this book with the half-formed intention of practising the art of judicious skipping; but I have been obliged to read it all. I fancy that most people who take up the book, if they have some little acquaintance with chemistry will not care to put it down till they have read it through; and that those who dip into it, knowing no chemistry, will determine to become more familiar with this, the most fascinating and the most human of the sciences.

"This book consists mainly of lectures and addresses given at various times, and to audiences of very different type, during the last eighteen or twenty years. . . . The book has no pretensions to be considered a history of chemistry, even of the time over which its narratives extend."

These sentences, from the preface, sufficiently define the aim and scope of Prof. Thorpe's essays. Accounts are given of the lives and labours of Boyle, Priestley, Scheele, Cavendish, Lavoisier, Faraday, Graham, Wöhler, Dumas, and Mendeléeff; there is also an essay on "Priestley, Cavendish, Lavoisier, and *La Révolution Chimique*"; and another on "The Rise and Development of Synthetical Chemistry." The form of the book—a collection of essays written at different times—serves admirably to keep before the reader the manifoldness and the diversity of chemistry; for chemistry is a branch of natural science whose immediate object and scope change much from time to time. The characters and careers of the men whose lives are sketched in these essays were nearly as different as are the aspects of the science to which they were all devoted. But as the one aim of chemistry is to bring the mind into actual contact with certain classes of natural occurrences, so the one aim of Boyle, and Priestley, and Faraday, and Lavoisier, and the other students of nature about whom Dr. Thorpe has written, was, as far as in them lay, to "know the soul of nature, and see things as they are." There is Priestley, the brilliant discoverer, the teacher of Latin, Greek, Hebrew, French and Italian, the lecturer on logic, elocution, the theory of languages, oratory and criticism, history and general policy, civil law, and anatomy; and there is Cavendish, the recluse, the measurer of natural quantities, the man who arranged his dinner-parties by a formula, dinner =  $\frac{\text{legs of mutton}}{x}$  ( $x$  being proportional to the number of guests), the man who, when he felt

death coming, said to his servant, "Mind what I say—I am going to die. When I am dead, but not till then, go to Lord George Cavendish and tell him—go." There are Lavoisier and Dumas, at once men of action in many departments of public life and men of thought, men of the world, and men of science; and there is Faraday, the humblest, the simplest, the most accurate, and the most original, of men.

The book abounds in examples of the dangers, the difficulties, and the triumphs, of the scientific method. We see Priestley on the verge of great discoveries regarding the composition of water and metallic calces, but held back by his devotion to that idol of the theatre, *phlogiston*. We see Boyle meeting the statement of Linus, that the mercury in the Torricellian vacuum is upheld by a kind of internal cord, by measuring the decrease in the volume of a portion of air caused by increasing the pressure on that air, and so arriving at the fundamental statement regarding the relation of gaseous volumes to pressure which is known as *Boyle's law*.

We are able, too, to compare the thoroughness and methodical application of the Germans, as shown in the work and lives of Wöhler and Kopp, with the brilliancy and sweep of the French naturalists Lavoisier and Dumas, and also with the stubborn perseverance and imaginative grasp of such English men of science as Dalton, Graham, Faraday, and Boyle.

The comparison of the two great atomists, Dalton and Graham, made on pp. 225-6, is succinct and suggestive. But I cannot agree with the author in his apparent approval of Henry's statement that imagination had no part in the discoveries of Dalton. I am sure that everyone who has attempted to teach the essentials of the atomic theory must be convinced that without vivid imagination it is impossible to gain any firm hold of this great conception. The whole of Dr. Thorpe's book, indeed, may be taken as a complete refutation of the vulgar mistake that the man of science has no need of imagination.

One may be repelled by the solitary, non-human life of Cavendish; but the character of Faraday, as set forth in Dr. Thorpe's sketch, must attract every reader. The accounts of the first meetings of Wöhler with Berzelius, and Dumas with Humboldt, given in the words of Wöhler and Dumas themselves, show that to men of science too comes sometimes the glow of hero-worship.

Who but a Frenchman would express his joy at a new discovery made in the laboratory by seizing the discoverer and waltzing with him round the benches! This was Gay-Lussac's method. I have been present when the arrival of a few tarry, evil smelling, drops of a long-wished for compound has been hailed with shouts and songs; but the translation of the emotions of a chemist into the poetry of movement is a higher and more inspiring light.

The criticism given by Dr. Thorpe of the conception that underlies the hypothesis of Prout is one that chemists would do well to remember. In its original form, Prout's hypothesis suggested that the atoms of the elements are collocations of atoms of hydrogen, and that, therefore, the atomic weights of the elements are whole multiples of the

atomic weight of hydrogen. Dr. Thorpe very justly remarks of the work of Stas (p. 229):

"It may be that it demolished Prout's hypothesis in its original form, but it has not touched the wider question; indeed it is very doubtful whether the wider question is capable of being reached by direct experiments of the nature of those of Stas, unless the weight of the common atom is some very considerable fraction, say one-half or one-fourth, of that of the hydrogen atom."

It seems to me that chemists have been very ready to forget "the wider question" that underlies the hypothesis of Prout. That wider question is: Are the elementary atoms collocations of different numbers of atoms of one fundamental kind of matter? And Prof. Thorpe does well to point out that this question cannot be answered by measurements of the relative weights of the atoms of the kinds of matter that we call elements. If the best established values for the atomic weights are multiplied by one hundred, all the values will be expressed in whole numbers; it is then only necessary to assume that the atom of the fundamental matter is one hundred times lighter than the atom of hydrogen, and, if the wider question underlying Prout's hypothesis can be answered by measurements of atomic weights, that question is answered. The solution of the world-old enigma of the unity of matter must be sought for by other methods.

On p. 154 the author quotes from Faraday, who, when writing to a scientific man at variance with another, remarked:

"These polemics of the scientific world are very unfortunate things; they form the great stain to which the beautiful edifice of scientific truth is subject. Are they inevitable?"

Would it not have been better had Dr. Thorpe, remembering this wise remark made by Faraday, who was the perfect representative of the true scientific student of nature, omitted from his collected essays that entitled "Priestley, Cavendish, Lavoisier, and *La Révolution Chimique*"? This essay jars somewhat. It is not in harmony with the others; it is not concerned with matters of universal interest; it revives a controversy that surely had better been left in forgetfulness. For is it of much importance to determine whether Lavoisier was or was not wholly indebted to Priestley for the fact that *red precipitate*, when heated, gives off a gas wherein a taper burns brilliantly?

Lavoisier can afford to make full acknowledgment of indebtedness to Priestley. Priestley discovered dephlogisticated air; Lavoisier gave oxygen to science.

M. M. PATTISON MUIR.

#### THE ORIGIN OF GLACIAL DRIFTS.

*The Canadian Ice-Age.* By Sir J. William Dawson, C.M.G., F.R.S. (Montreal: William V. Dawson. New York and London: The Scientific Publishing Company, 1893.)

IT is continually brought to the notice of geologists that the most recent period in the long history of the earth is also that which excites the greatest controversy. We can deal complacently with earth-movements, mountain-thrusts, and submergences of half a

continent, so long as the organisms affected by these occurrences are less specialised mammals than ourselves; but we find it hard to believe in great physical or climatic changes within the limits of our own written or unwritten history. Moreover, our knowledge of the post-Pliocene period is burdened with an excess of detail; and broad and sweeping generalisations seem at present out of the question. And, if we go one step further, we may fairly attribute our friendly agreement with regard to the conditions of the older periods to our ignorance rather than to our information.

Sir William Dawson, in the present work, summarises several previous papers of his own, just as M. Gaudry's detailed memoirs were summarised for general use in "Les Ancêtres de nos Animaux." This handy paper-bound volume deals strictly with Canada, and is in no way a "Theory of the Earth." It is moderate in tone, and forms a serious plea for a rational treatment of the glacial epoch. Whatever caused the cold conditions in the northern hemisphere, or in parts of the northern hemisphere, it is pointed out that the land-ice in Canada radiated from two local centres, and not from the hypothetical ice-cap at the pole. Readers of NATURE will remember the evidence brought forward by Dr. G. M. Dawson as to the "Laurentide" centre of glaciation on the east and the "Cordilleran" centre on the west (NATURE, vol. xlii, p. 650). The conditions maintained by Sir W. Dawson as most favourable to the development of glaciers are high masses of land in proximity to cold seas; and, as he properly points out, these conditions still prevail in North America to a greater extent than in North Europe. They prevail, moreover, in Greenland, but not in Grinnell Land, to cite two closely neighbouring areas.

It will be clear, then, that Sir W. Dawson urges that differential earth-movement was the main factor in the production of Canadian glaciation. The evidence of marine shells in the drift, of the bones of whales, of the character of the deposits themselves, all points to the existence of wide areas of submergence. With regard, for example, to the Cordilleran centre in British Columbia, our author writes:—

"The conditions were combined of a high mountain chain with the Pacific on the west, and the then submerged area of the great plains on the east, affording next to Greenland the grandest gathering-ground for snow and ice that the northern hemisphere has seen."

Of recent years it has been far too generally assumed that we have to picture the glaciers of the ice-age moving across the features of the country as we at present know them. The views of Prof. Suess with regard to earth-movements in the historic period are perhaps only fair criticism of somewhat hasty observations; but, in face of the extraordinary evidence of post-Pliocene upheavals, it is at least irrational to believe that these terminated with man's appearance on the globe. Many English "glacialists" accept a recent submergence of their country to a depth of 500 feet, and yet postulate the most catastrophic occurrences to account for marine beds at twice that height above the sea. Yet we now have, in addition to the old Lyellian instances, such as the Astian or even later beds in Sicily, which are elevated some 3000 feet,

evidence given us by Prof. Andrew Lawson of a post-Pliocene uplift of the continental coast of California to heights of from 800 to 1500 feet; and Sir W. Dawson's requirements to explain the distribution of the Canadian drift are such as will seem moderate and natural to every rational uniformitarian.

On p. 111 of the present work, the author discusses the possibility of distinguishing striations produced by the "huge ice-islands" in shallow seas from the deeper and firmer markings of true glacier-ice. Granted the submergence, which in itself assists in the formation of snow and ice, the phenomena of the distribution of boulders receive at once their simplest explanation; and in chapter v. the local details of the drifts are taken, area by area, into consideration. Our own British islands must similarly be discussed area by area. Because it seems probable that Scotland in the glacial epoch was a local Greenland, there is no reason why England should also have been lifted above the sea. The evidence accumulating in Ireland goes far in favour of a long submergence of that country, with the production of an archipelago of picturesque and snow-capped islands. Hence it is that we may welcome Sir W. Dawson's summary of results in Canada as a reminder that land-ice and enormous terminal moraines are not to be left in undisputed possession of the field. We can even sympathise with him in his final sense of irritation, when he charges some glacialists with "misunderstanding or misrepresenting the glacial work now going on in the arctic and boreal regions." "These are grave accusations," he continues, "but I find none of the memoirs or other writings of the current school of glacialists free from such errors; and I think it is time that reasonable men should discountenance these misrepresentations, and adopt more moderate and rational views."

Of course Sir W. Dawson cannot resist the temptation of stating as "an inevitable conclusion" (p. 289) "that the origin of specific types is quite distinct from varietal modification"; but this is a cheerful side-thrust, as it were, in a work on quite another subject. On p. 36 the use of "Neozoic" as equivalent to "Tertiary" seems unusual; and on p. 51 there is a sentence on the origin of fiords, quoted from an earlier paper by the author, which describes them as "often evidences of the action of the waves." They may have nothing to do with glacial excavation, but still less can they be regarded as products of marine erosion, unless the author confines himself to the cases that he has specially examined in Nova Scotia.

G. A. J. C.

#### OUR BOOK SHELF.

*Grundzüge einer Entwicklungsgeschichte der Pflanzenwelt Mitteleuropas seit dem Ausgang der Tertiärzeit.* Von Dr. August Schulz. (Jena: Gustav Fischer, 1894. Svo. pp. 206.) (Outlines of a History of the Development of the Flora of Central Europe since the close of the Tertiary Period.)

IN a preliminary note by the author, we are informed that this dissertation is an extract from a more extended essay on the vegetation of Central Europe, which present circumstances prevent him from publishing in full. The title cited above is really that of the first chapter of the work only. A second deals with the

spread of the "thermophytes" in Central Europe since the "fourth ice-period"; and a third with the division of Central Europe into floral districts; followed by some seventy pages of explanatory remarks on the points raised in the preceding chapters. Unfortunately for those who would wish to consult this book, it has neither index nor headings of any kind. There is no attempt whatever to classify the facts and data; no map, no summary, no digest, no general conclusions; indeed, no help at all for the reader desirous of knowing what the writer has arrived at, or is leading up to. He begins with the assumption, that only very few of the plants which now inhabit Europe were already here in Miocene times, and that a large majority of the present vegetable inhabitants consist of immigrants and such as have originated within the territory since the beginning of the Pliocene period. The homes of the migrated species he would seek in Arctic America, but chiefly in Asia; and a very small number he considers have migrated from North Africa. In illustration of migrations the author gives full details of the present distribution of a small selection of plants; but only in words, so that it is a study to trace the areas. Having thus called attention to this work, we must leave it to the reader with leisure to follow the writer through his four ice-periods, and the present distribution of the leading elements of the flora of Central Europe; and we may add, that he will find much interesting matter.

*Elementary Metal Work.* By G. C. Leland. (Whittaker and Co., 1894.)

THIS book is devoid of scientific or general interest, merely treating of certain kinds of decorative metal work which can be executed by amateurs and children, and which, as a general rule, we would far rather be without. There have been instances, however, in which metal working at home, directed by energetic people of taste and leisure, has been found to greatly benefit working men and their families who are forced to be comparatively idle in winter. In a certain charming spot in the Lake District, where such objects are readily disposed of to tourists, the results have been most satisfactory, and we wish some such home industries could be introduced into parts of Ireland and Scotland frequented by visitors in summer, where the enforced winter idleness produces an amount of poverty painful to think of.

J. S. G.

#### LETTERS TO THE EDITOR.

[The Editor does not hold himself responsible for opinions expressed by his correspondents. Neither can he undertake to return, or to correspond with the writers of, rejected manuscripts intended for this or any other part of NATURE. No notice is taken of anonymous communications.]

##### Earth Currents.

THE Astronomer Royal was kind enough to show me the permanent photographic records of earth currents during the great magnetic storm on February 20-21, and they indicated so unmistakably such rapid and violent alternations, that I supplied our principal relay stations with telephones and with instructions to insert them in circuit whenever they observed indications of disturbances. This happened on March 30-31, during the display of the Aurora Borealis. Mr. Donnithorne, in Llanfair P.G., Anglesea, reports:—"At 2.0 a.m. (Saturday) the telephone receiver was again tried, and then 'twangs' were heard as if a stretched wire had been struck, and a kind of whistling sound. The strength of the earth current was 177 milliamperes." Mr. Miles, in Lowestoft, reports:—"Noise on 408 (Liverpool-Hamburg) wire seemed like that heard when a fly-wheel is rapidly revolving," and "sounds in telephone appear like heavy carts rumbling in the distance." Mr. Scaife, in Haverfordwest, reports:—"March 31, 2.5 a.m.

Earth currents on all wires; wires completely stopped. . . . Peculiar and weird sounds distinctly perceived, some highly-pitched musical notes, others resembling murmur of waves on a distant beach. . . . The musical sounds would very much resemble those emitted by a number of sirens driven at first slowly, then increased until a 'screech' is produced, then again dying away. Duration of each averaged about twenty seconds." These experienced observers, situated at three distant points, and perfectly acquainted with the ordinary inductive disturbances on telephone circuit, simultaneously observed and independently recorded their own impressions of peculiar sounds exerted in telephones by very rapid alternations or pulsations of currents which accompanied or were consequent on sun-spots, earth currents, and the Aurora Borealis.

W. H. PREECE.

G. P. O., April 9.

##### The Aurora of March 30.

I VENTURE to supplement the reference in NATURE to the Aurora of March 30, by a brief account of an observation made by me at Bristol.

At about 10.30 p.m. I noticed against a dark blue sky a single narrow rose-coloured ray stretching from between  $\alpha$  and  $\beta$  Ursa Majoris to the neighbourhood of  $\delta$  Aurigæ, and slightly beyond it. It was speedily joined by a second and then by a third ray, apparently diverging from a common centre about 5 degrees beyond  $\alpha$  and  $\beta$  Ursa Majoris. The three rays gradually became less divergent, and merged into one broad beam, which ultimately faded away: the whole phenomenon lasting about 5 or 6 minutes only. At the same time there was a greenish-white luminosity on the N.N.W. horizon, suggestive of a belated and misplaced sunset. I understand that this had endured for a long time, perhaps an hour or more.

J. RYAN.

University College, Bristol, April 9.

##### Crystalline Schists of Devonian Age.

IN a recent number of NATURE (vol. xlix, p. 435) Prof. Bonney writes:—"Speaking for ourselves we think he (Prof. van Hise) is disposed to . . . admit on too slight evidence that in 'Silurian, Devonian, and even later times, completely crystalline schists have been produced over large areas'; for in the past this assertion has been so often made, and so often proved erroneous, that on the principle, 'once bit, twice shy,' we are disposed to be a little sceptical."

Mere assertions in geology, as in general science, are scarcely worth the trouble of contradicting; but in one case, at least, the evidence of the existence of completely crystalline "Devonian" schists does not rest on mere assertion.

I published certain microscopic evidence in favour of the Devonian age of the schists of the Start and Bolt district in the *Geological Magazine* in 1892, and as Prof. Bonney would not condescend to weigh the said evidence, but contented himself by attempting to defend his own position by "abusing plaintiff's attorney," I proceeded to dissect his own argument for the Archaean age of the rocks in question in a separate publication.

Until the facts and arguments advanced in support of the "Devonian" age of these crystalline rocks, and the arguments against Prof. Bonney's rival hypothesis, (the latter based on a brief week's investigation of a district which has puzzled geologists for over half a century) are all fairly met, I must deprecate any attempt being made to lead the readers of your journal to believe that the doctrine of the "Devonian" age of the Devonshire schists has been "proved erroneous."

Torquay, March 23.

ARTHUR K. HUNT.

P.S.—When the above was written I had not seen the remarks of the Director-General of the Geological Survey on the metamorphic area of South Devon, published in your issue of March 22 (NATURE, vol. xlix, p. 497).

##### William Pengelly.

PROF. BOYD DAWKINS, in his otherwise excellent obituary of Pengelly, refers to the Bovey Tracey beds as a Miocene Lake deposit. They are, however, not lacustrine but fluvial, consisting of current-bedded coarse grits alternating with lignitic muds, such as are deposited in stretches of still water when the main current cuts itself a new channel. Lithologically these beds are identical with those of Corfe and Bournemouth, and there is no reason to doubt their being the

deposits of one and the same river. Neither are they Miocene, if the evidence of fossils is to be trusted; and we have no other guides in this case but the lithology and paleontology, since the identifiable and most characteristic fossils are also found in the Middle Bagshots of Bournemouth, in a precisely similar matrix, and in the same state of preservation. In determining the age of the deposits, great stress was laid on the supposed identity of the *Sequoia Coultsii* of Bovey with that of the Hamstead beds; but by visiting Bovey not long since, and obtaining perfect specimens of the cones, I satisfied myself that the Bovey plant is a true *Sequoia*, with scales growing at right angles from the axis, and with compressed winged seeds; while even more perfect specimens from Hamstead, obtained soon after, showed the scales inserted at the base, and the seeds wingless, falling thus more properly into *Athrotaxis*. The foliage growth is also entirely different, though the leaves are similar. The point is of some importance, yet the mistake having been made by such "heroes of geology" as Heer and Pengelly, is extremely hard to eradicate.

J. STARKIE GARDNER.

A Rejected Address.

CONSCIOUS that the protestant is a weak-kneed *urochs*, I ask permission to protest by implication against a common trivial mistake. How long will people go on writing about "political meteorology" and the like, meaning, by this, haphazard prediction? The meteorologist is as near a cousin to the local "weather-prophet" as Helmholtz to the artisan who is making a spectacle-case; or, to use an illustration lent me by a lady, as the astronomer is to the astrologer.

NUBES.

April 9.

THE LIMBS OF LEPIDOSIREN PARALONA.

DR GÜNTHER, in his valuable work, "The Study of Fishes," says of Natterer's *Lepidosiren* from the Amazons, "It is one of the greatest desiderata of

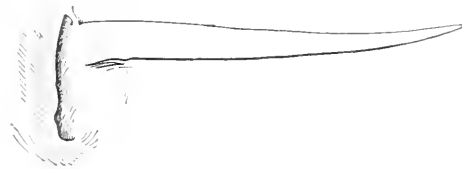

FIG. 1.



FIG. 2.

natural history collections." In fact, only seven years ago the opinion was current that Natterer had been deceived by specimens of *Protopterus* imported from Africa, or that in some way African specimens had been mixed with his American collections.

I was therefore greatly pleased to obtain recently for the Oxford University Museum, by purchase from a London dealer, specimens of the *Lepidosiren* of the Amazon well preserved in spirit. I immediately noticed a peculiarity about the pelvic fins, which it is the object of the present note to make known. These fins, whilst more robust than the pectorals, were remarkable for exhibiting upon their dorso-mediad surface a clothing of well-developed "villi," the appearance of which is best gathered from the accompanying sketches (Figs. 2 and 3).

As many as four "villi" were in some cases united at the base, or mounted on a short trunk.

No such "villi" are known in the African *Protopterus*, nor in *Ceratodus*.

The specimen figured by Natterer showed no trace of these "villi." This was a female, whilst the specimens recently imported which exhibit the "villi" are males.

I am at present engaged in an examination of the minute structure of these "villi" of the pelvic limbs of

*Lepidosiren*. Whether tactile or respiratory, they form a most remarkable feature, and it seems worth while to place a brief notice of them at once in the hands of naturalists.

Natterer's figure of *Lepidosiren* (which has often been copied) is not good. It does not give a fair idea of the proportions of the animal. I hope soon to publish a careful drawing of life-size. *Lepidosiren* is distinctly



FIG. 3.

longer in proportion to breadth than is *Protopterus*, and there is a greater distance between the pectoral and pelvic fins in *Lepidosiren* (in proportion to total length) than in *Protopterus*. The median fin is not so deep in *Lepidosiren* as in *Protopterus*.

The woodcuts are as follows:—

Fig. 1 represents the left pectoral fin and opercular opening.

Fig. 2 shows the left pelvic fin, drawn to the same scale, in its natural position of rest; the long axis nearly parallel with the long axis of the body.

Fig. 3 shows the same pelvic fin turned forward (a position which the animal can give it in life), exposing the dorso-mediad face of the fin with its numerous "villi."

ANT.

POST.

The lifting of the fin has also exposed the anus, which lies on the left side of the median line of the body.

E. RAY LANKESTER.

March 20.

BEEES AND DEAD CARCASSES.<sup>1</sup>

DURING the last two hundred years our knowledge of natural and physical science has advanced by leaps and bounds, until, in most departments, it has risen to a level far exceeding anything which has been recorded during historic times. Hence, in dealing with improbable or impossible statements which have come down to us from classical or mediæval times, we are perhaps too apt to forget the old proverb that "there is no smoke without fire," and to dismiss them at once as vulgar superstitions, instead of seeking for the substratum of truth which will often be found to underlie them. Even so plain and simple a statement as that ants store up food was long discredited; for, as the ants of Northern Europe do not possess this habit, it was supposed to

<sup>1</sup> On the so-called *Engonia* of the Ancients, and its Relation to *Eristalis tenax*, a Two-winged Insect. By Baron C. R. Osten Sacken. Reprinted from the *Bulletino della Società Entomologica Italiana*, Anno xxv. 1893.

have arisen from their having been seen carrying their pupæ (or, in common talk, "ant-eggs"). But a case which nearer concerns our present subject is that of the distant islands, upon which, as many Arabic writers gravely assured us, grew trees bearing fruit resembling human heads, which cry out "Wák-wák" at sunrise and sunset. What could be made of such a story? One fine day Mr. Wallace landed in the Aru Islands, and found that the Birds of Paradise were in the habit of settling on the trees in flocks, about sunrise, uttering this very cry. So the mystery was cleared up, though it is quite possible that Mr. Wallace himself may have been unaware of the existence of the legend when he put the explanation on record.

Everyone must be well aware that the ancients believed that bees either established themselves, or were produced spontaneously in dead carcasses. The two most familiar instances are to be found in the story of Samson (Judges, ch. xiv.), and in Virgil's *Georgics* iv.; but there are many other references to it in various authors, many of them of good repute, down to a very recent period. But with the dawn of a more scientific age the idea of bees being produced from carcasses was rejected; and the Biblical narrative was interpreted to mean that the bees had made their nest in a dried-up carcass or skeleton. As the Septuagint says expressly that Samson found the bees and honey in the *mouth* of the lion, this explanation might not perhaps have appeared so very unreasonable, in default of a better. But several writers suggested that in cases where the spontaneous generation of bees from carcasses was positively asserted, flesh flies may have been mistaken for bees; and in the pamphlet before us, which has suggested our own remarks, Baron Osten-Sacken, the eminent dipterist, has given a long account of the popular idea of "Bugonia," or the production of bees from the carcasses of oxen, and puts forth what certainly appears to be the correct explanation. "The original cause of this delusion lies in the fact that a very common fly, scientifically called *Eristalis tenax* (popularly the drone fly), lays its eggs upon carcasses of animals, that its larvæ develop within the putrescent mass, and finally change into a swarm of flies which in their shape, hairy clothing, and colour, look exactly like bees, although they belong to a totally different order of insects. Bees belong to the order *Hymenoptera*, and have four wings; the female is provided with a sting at the end of the body. The fly *Eristalis* belongs to the order *Diptera*, has only two wings, and no sting."

This thesis Osten-Sacken works out in great detail, quoting or referring to a large number of authors. Among other interesting points, he calls attention to another classical notion that *wasps* were produced from the carcasses of horses. These supposed wasps he identifies with *Helophilus*, a wasp-like genus of flies not far removed from *Eristalis*. Thus the one error illustrates and explains the other in a singularly apposite manner. As regards Samson, Osten-Sacken remarks, "The riddle . . . affords the proof of another fact, that the belief in the *Bugonia* was current among the people at that time, because, without that substratum, the riddle would not have had any meaning."

Osten-Sacken concludes his pamphlet with a detailed account of *Eristalis tenax*. The fly appears to be common in almost all parts of the Old World (and has latterly been introduced into America, also), so that the story of the *Bugonia* could easily have originated spontaneously (even if the bees themselves do not) in any country. Indeed, in all probability the story may have sprung up independently in more than one part of the world.

Baron Osten-Sacken has lived much in America, and is usually in the habit of writing in English to whatever journal he addresses his observations; and his present

interesting pamphlet is no exception. It will be seen that he writes not for entomologists only, but for scholars and literary men; and we have not attempted to do more than give a brief sketch of a critical essay which, to be appreciated, must be read in its entirety. But we cannot now do better than quote the Baron's concluding remarks.

"Except the silkworm and the honey-bee, I hardly know of any insect that can show an historical record equal to that of *Eristalis tenax*. The record begins in the dusk of prehistoric times, and continues up to the present date. In its earliest days *E. tenax* appears like a myth, a misunderstood and unnamed being, praised for qualities which it never possessed, a theme for mythology in prose and poetry, later on, the bubble of its glory having burst, it gradually settles into a kind of commensalism with man, it obtains from him 'a local habitation and a name'; it joins the Anglo-Saxon race in its immense colonial development, it vies with it in prodigies of fecundity, and at present renders hitherto unrecognised services in converting 'atrocious stuff' into pure and clean living matter!

"I close this chapter on the *Bugonia*-craze with the moral of it, contained in another sentence from Goethe:—

'Man sieht nur was man weiss.'

W. F. KIRBY.

#### CHARLES EDWARD BROWN-SÉQUARD.

THIS distinguished physiologist and physician was born on April 8, 1817, at Port Louis, Mauritius. His father, Edward Brown, of Philadelphia, was of Irish origin, and his mother was of a French family which had been settled for some time at the "Isle of France." His early education was carried on in his native island, where at Port Louis there was and is a most excellent college for literature and science; but wishing to study for the medical profession, the young Charles Edward was sent, in about his twentieth year of age, to Paris, where he adopted a surname composed of his two patronymics.

In 1840 he obtained the M.D. degree at Paris, and as a pupil of Claude Bernard's, he followed closely the brilliant researches of his master, and with a boundless enthusiasm he commenced the study of nerve physiology, which he continued with but brief periods of intermission for the next fifty years of his life. By the accidents of his birth he became from his earliest years equally proficient in both the English and French tongues; but though an Englishman by birth, he always seemed to regard France as his home, and Paris as his resting-place. Owing in part to Brown-Séquard's facility of writing both French and English, his various papers on the functions of the sympathetic nerves and ganglia soon made his views known to a large circle of inquirers, and in 1858 he was invited to deliver a course of six lectures at the Royal College of Surgeons, in Lincoln's-Inn Fields. About this period, also, a number of the younger physicians and surgeons of Dublin persuaded him to come as far west as Dublin, to repeat this course, but at that time no college in the Irish capital was found willing to open its doors to the experimental physiologist, and the lectures were delivered in the back room of a concert hall. For the first ten or twelve years after taking his doctor's degree the struggle for life was somewhat arduous; his line of research was not productive of an income, and the pecuniary rewards for scientific writing or for scientific reports was excessively small. The writer calls to mind a visit paid to Brown-Séquard at his lodgings in Paris; the two rooms occupied by him were just under the sky, and their chief furniture consisted of books, pamphlets, and writing paper.



His first of many visits to the United States was made about 1850, and his work on "Experimental Researches applied to Physiology and Pathology" was published in New York in 1853. In January 1858 the first part appeared of the *Journal de la Physiologie de l'Homme et des Animaux*. It was dedicated to Biot, Rayer, Flourens, and James Paget, as a "hommage de reconnaissance et de respectueuse affection." His experimental researches had already proved of immense importance in their bearings on various pathological conditions, and the results of experiment had not only aided in the diagnosis of disease, but had also furnished means and hints whereby suffering humanity could be relieved, so that it was not very surprising that when, in 1860, the Hospital for the Paralyzed and Epileptic was opened in London, Brown-Séquard was selected to be its physician. Arduous as were his new duties, they had a special attraction for him. His labours, however, did not end with his hospital work; a large private practice demanded a great expenditure of his own nerve force, and after a couple of years he talked of it as being overwhelming. A visit paid to him at this time was a contrast to the one at Paris. The large reception-room in his house in Cavendish-square was filled with anxious patients and their friends. A hasty interview on the staircase was all that he could afford; it ended with a "come and have a talk over old times, but come at night for fear of the patients." To those who knew him well it was therefore no surprise that in 1864 he should give up his hospital appointment, his patients, and his house in London, and go to the Harvard University, as Professor of Physiology and Pathology of the Nervous System. The rest at Cambridge did him good, and he recommenced original work; but shortly afterwards his wife died, and in a fit of poignant grief he gave up his appointment and returned once more, with his son, to Europe (February 1885), passing through Dublin on his way to Paris.

In 1868 he founded, in conjunction with Charcot and Vulpien, the *Archives de Physiologie*. Early in 1869 he was nominated "Professeur agrégé à la Faculté de Médecine de Paris." In this year he was elected an honorary member of the Royal Irish Academy. About 1870 he again returned to the United States, staying for some time in New York; but he came back to Paris in 1878, and succeeded Claude Bernard in the chair of Experimental Medicine at the College of France. He was awarded the Baly medal by the Royal College of Physicians of London in 1881, and was elected to Vulpien's place in the French Academy in 1886. He was a F.R.S. as well as a member of many continental and American Societies.

His experimental researches, undertaken in his later days—between 1889 and 1893—to sustain or even to renew the vital powers, it is not necessary for us to particularly mention: dreams allowed to a poet are forbidden to the philosopher, and time will alone tell whether there be any germ of reason in Brown-Séquard's investigations; if not, they may be forgotten and forgiven. Wishing peace to his memory, we will not soon forget the gentleness of his disposition or his affection as a friend. He died at Paris on Sunday, April 1.

#### PROFESSOR ROBERTSON SMITH.

THE death of Prof Robertson Smith, on March 31, at a comparatively early age, is a profound loss to the whole thinking world.

Unfortunately for Science, and (in too many respects) for himself, his splendid intellectual power was diverted, early in his career, from Physics and Mathematics, in which he had given sure earnest of success. He turned his attention to eastern languages, and acquired a knowledge

of Hebrew, Arabic, and other tongues, quite exceptional in the case of a Briton.

Dr Smith was born at Keig, Aberdeenshire, in 1846, and educated at Aberdeen University, the New College, Edinburgh, and the Universities of Bonn and Göttingen. In 1868 he became Assistant to the Professor of Physics in Edinburgh University; in 1870, at the age of twenty-four, he was appointed to the chair of Hebrew in the Free Church College of Aberdeen. A few years later he fell under the suspicion of holding heterodox views concerning Biblical history. Orthodoxy raised her voice against him in the newspapers, in the churches, in the Presbyteries, and finally, in the General Assembly of the Free Church of Scotland, and the clamour culminated in his dismissal from the Professorship at Aberdeen in 1881. This was effected, not by a direct condemnation of his published opinions, but by a monstrous (temporary) alliance between ignorant fanaticism and cultivated jesuitry, which deplored the "unsettling tendency" of his articles!

He next became successor to Prof. Baynes in the Editorship of the last edition of the *Encyclopædia Britannica*; and here his business qualities, as well as his extraordinary range of learning, came prominently before the world. In 1883 Dr. Smith was appointed Reader in Arabic at Cambridge, and three years later he succeeded the late Mr. Bradshaw as librarian to the University. He was afterwards elected to a Fellowship at Christ's College, and to the Professorship of Arabic.

What Smith might have done in science is shown by his masterly paper "*On the Flow of Electricity in Conducting Surfaces*" (*Proc. R.S.E.*, 1870), which was rapidly written in the brief intervals of leisure afforded by his dual life as simultaneously a Student in the Free Church College, and Assistant to the Professor of Natural Philosophy in Edinburgh University.

We understand that his engagement as Assistant to Prof. Tait had its origin in the extremely remarkable appearance made by young Smith as a Candidate in the Examination for the Ferguson Scholarships, an examination in which most of the very best men in the four Scottish Universities are annually pitted against one another.

In Edinburgh University he did splendid service in the work of initiating the Physical Laboratory:—and there can be no doubt that the *esprit de corps*, and the genuine enthusiasm for scientific investigation, which he was so influential in exciting there, have inaugurated and promoted many a successful career (not in this country alone, but in far regions everywhere), and that, near and far, his death will be heard of with heart-felt sorrow.

A light and playful feature of his too few years of scientific work consisted in his exposures of the hollowness of the pretensions of certain "philosophers": when they ventured to tread on scientific ground. Several of these will be found in the *Proceedings and Transactions* of the Royal Society of Edinburgh (1869-71). Smith treats his antagonist "tenderly, as if he loved him," but the exposure is none the less complete.

A writer in the *Times* thus testifies to Dr. Smith's remarkable powers: "In him there has passed away a man who possessed not only one of the most learned but also one of the most brilliant and striking minds in either of the great English Universities, and who was held in the highest regard by the leading orientalists of the continent. His extraordinary range of knowledge, the swiftness and acuteness of his intellect, and his passionate love of truth combined to make an almost unique personality. His talents for mathematics and physical science were scarcely less remarkable than those for linguistic studies, and if he had not preferred the latter, there is no question that he could have reached great eminence in the former."

## NOTES.

AT the meeting of the Convocation of the University of London on Tuesday, the University was saved from committing an act detrimental to its best interests. The report of the annual committee condemning the recommendations of the Gresham Commissioners as to the reconstruction of the University was under consideration. It was urged by the supporters of the report that the rapidly increasing number of candidates who present themselves for the University examinations, was a sufficient argument against any change of constitution. We agree with Dr. Hart, that the University has raised the standard of education, that it has encouraged the aspirations of persons unable to bear the expense of residence in University towns, and that it has done much for the higher education of women. But the time has arrived when the University must become more than a mere examining body, if it wishes to keep pace with the times. Members of Convocation who are jealous of the prerogative position at present occupied should look around, and then ask themselves whether London ought not to have a teaching University like those of other capitals in Europe. A mistaken idea as to the dignity of the University should not be allowed to stand in the way of the proposed developments. It would be far more dignified to accept the changes, unless, indeed, the University of London desires to find itself eclipsed by another with a charter more suited to the requirements of to-day. Some of the most eminent members of Convocation recognise the necessity of the old order giving place to the new. Prof. Sylvanus Thompson pointed out that when functions were, as in the case of London University, extremely limited, they should be extended. "Why should not," he said, "the University perform all those great duties of encouraging research and learning and of teaching, which were an essential part of a true University. He hoped the matter would be approached in a temperate spirit, and that they would not stand on a mistaken notion of their dignity. There might be blots on the scheme which they should seek to remove, but was it wise to oppose the scheme in a thoroughly hostile spirit? Let them beware of showing such a spirit, for it might be that a new University would arise, discharging all the functions of a University, and the present University of London might be left in the cold. The substitution of a new charter for an old did not, as they knew from past experience, impair the continuity of their existence. It would be a great pity if two Universities should arise—one not called by the name of the capital, but doing all the work of a University, whilst that which was called the University of London was restricted to the narrow sphere of examinations." Mr. Threlton Dyer also supported the recommendations of the Royal Commissioners, rightly remarking that the scheme would enable the University to develop its full powers, especially in the department of post-graduate study, in which lies the true glory of a University. The resolution of the annual committee, protesting against the withdrawal of the present charter, was eventually set aside by an almost unanimous vote. This is satisfactory as far as it goes, but it does not dispose of the matter in a very effective manner. A motion was afterwards proposed by Sir Albert Rollit, in the following form:—"That, with a view to the speedy and satisfactory reconstitution of the University, it is desirable to secure, if possible, the co-operation of the Senate and Convocation, and with this object Convocation refers the whole question of the reconstitution of the University to the annual committee, with power to nominate members of a joint consultative committee of the Senate and Convocation." This was unanimously adopted; so the University is once more given the chance of reconsidering its policy, and of gracefully accepting the proposed changes before they are forced upon it.

IN August, 1892, the Board of Trade sent to the Directors of each of the railway companies of the United Kingdom a copy of the report of the Royal Society's committee on colour vision (*NATURE*, vol. xlv. p. 33), asking for observations upon the recommendations it contains. It was pointed out that, as regards the officers employed in the mercantile marine, the Board of Trade had taken steps to give effect to the recommendations of the committee on the method of testing, and the Directors were urged to give careful consideration to the matter as far as concerned persons employed on their railways. A Parliamentary paper just published contains the replies received from the railway companies. On the whole, the result is satisfactory. Many of the companies accept Holmgren's wool test for colour vision, and Snellen's type system of testing form, though a large number use modifications of them, or supplement them with other tests. The necessity of periodical examinations is generally recognised, but the interval between the examinations varies in different companies from six months to five years. The directors of the Metropolitan District Railway consider that the committee's recommendation that the colours used for lights on board ship, and for lamp signals on railways, should, as far as possible, be uniform in tint, as quite inadmissible. They say that the shades of light adopted for their signals are the result of long and careful experiments, and of trials of many shades and gradations, and are best adapted to the peculiar circumstances of underground working. It is also remarked that the cases of sighting at sea and sighting upon a railway, subject to such atmospheric variations as occur on the underground systems, are totally different. This strikes us, however, as sheer nonsense.

THE French National Society of Horticulture will hold its tenth congress next month, and at the same time the annual horticultural exhibition will take place. The congress will be of an international character, and a number of interesting questions are down for discussion. Among these subjects are: Chlorophyll considered in relation to the vigour of cultivated plants; capillarity in relation to the preparation of the soil; the means of accelerating the nitrification of substances containing nitrogen, and therefore to render them more easily assimilable; the necessity of a unit of comparison for use in connection with the various systems of heating with hot water. Further information concerning the congress can be obtained by application to the Society, 84, Rue de Grenelle, Paris.

AN International Exhibition of Horticulture and Fruit Culture will be opened in St. Petersburg on September 22, and will remain open until November 12.

THE death is announced, at Saratoff, of M. Paul Jablochkoff, the inventor of the Jablochkoff candle system of electric lighting.

THE Right Hon. Lord Bowen, a friend of science and a supporter of her interests, died on Tuesday at the age of fifty-nine. He was elected a Fellow of the Royal Society in 1885.

AN astronomical congress will be held in San Francisco in June next, in connection with the Californian Midwinter International Exhibition.

MR. A. D. HALL has been appointed Principal of the Agricultural College at Wye, established by the joint county councils of Kent and Surrey.

A WRITER in the current number of the *Chemical News* enumerates some of the streets, avenues, and public squares in Paris, named after eminent men on account of their scientific labours. In some instances the streets thus designated are appropriately placed near learned institutions with which the

investigators' names were associated; in others, the names of men engaged in the same branch of science are grouped within small areas. It is pointed out that the "Jardin des Plantes is bounded by streets named respectively Cuvier, Buffon, and Geoffroy St. Hilaire; while in the immediate vicinity are the streets Lacépède and the Place Jussieu. Elsewhere in Paris the following names occur:—Lamarck, Linnaeus, de Saussure, and Humboldt. Near the École de Médecine runs the street Dupuytren, and in the same quarter the eminent physician Velpeau is honoured. Near the Hospital La Salpêtrière two English physicians lend their names to streets, Harvey and Jenner. In the neighbourhood of the Arc de Triomphe occur the names of the astronomers Copernicus, Galileo, Kepler, Euler, and Newton; elsewhere we find the streets Huyghens, Laplace, and Herschell. Mathematicians and physicists have not been forgotten, as shown by the occurrence of the following street names:—Biot, Pascal, Lalande, Lahire, D'Alembert, Delong, Arago, Monge, Legendre, Ampère, Fresnel, Becquerel, Galvani, Volta, Franklin, and Faraday. Amère, Galvani, and Faraday are near each other. Philosophy is represented by Descartes, Auguste Comte, and Bacon; engineering by Vauban, Watt, Stephenson, and Fulton; useful inventions by Beinard Palissy and Guttenberg; exploration by Christopher Columbus and Magellan. Chemists have received, however, a larger share of the honours than any other single class, not even excepting men of letters. Thus we find streets named after the French chemists Bayen, Berthollet, Cadet, Chaptal, Darcet, Daguerre, Gay-Lussac, Lavoisier, Laugier, Orfila, Parmentier, Payen, Raspail, Réaumur, Rouelle, Thénard, and Vauquelin; the Swede Berzelius; and the Englishmen Davy, Faraday, Priestley, Cavendish, and Watt." A straw is sufficient to tell which way the wind blows, and the above simple facts serve to show that the municipal authorities of Paris consider the names of men of science just as worthy of being handed down to posterity as those of followers of other professions. Similar authorities on this side of the Channel have not yet reached the condition in which scientific workers are thus recognised.

THE Paris Geographical Society has made the following awards for geographical research:—A gold medal to M. Casimir Maistre for his exploration between the Congo and Niger; a gold medal to Prince Henry of Orleans for his scientific journey to Tonkin and in the Laos country; Prix Pierre-Felix Fournier to M. Vital Cuinet for his important work on "Turkey in Asia"; a gold medal to M. André Delebecque for his researches on French lakes; a gold medal to M. E. Foa for his explorations in South Africa, from the Cape to Lake Nyasa; Prix Herbet Fournet to M. P. Savorgnan de Brazza for his explorations in the French Congo, and for the part he has played in the colonial expansion of France; a gold medal to M. M. Monnier for the whole of his explorations, and especially for his voyage to the Ivory Coast; a gold medal to M. H. Schirmer for his monograph on the Sahara; a silver medal to Dr. A. Hagen for his scientific studies on the New Hebrides; a silver medal to M. L. Vignon for his works on French colonies, and especially for his important work "La France en Algérie"; Prix Jomard to M. Camille Imbault-Huart for his work on the "Island of Formosa."

THE exploration of the Lukuga river, which forms the periodic outlet of Lake Tanganyika, by the Kuanga expedition under M. Delcommune, forms the subject of a short article and map in a recent issue of the *Mouvement Géographique*. The river was traced down to its confluence with the Lualaba or Upper Congo, in the last months of 1892. After leaving the lake the river pierced the Kakazi hills in a gorge, lined by cliffs 300 metres high, then expands in a marshy tract, contracts to pass another gorge, and expands once more on

the plain, where it enters the Lualaba 230 miles from its source in Lake Tanganyika, and at a level 300 metres lower. Though the volume of the river was small at the time of observation, and the water very shallow, evidence was found of the occasional occurrence of very heavy floods. It appeared that the Lukuga first became an outlet of the lake in consequence of an exceptional rise of the water-level forcing an exit through the most easily breached part of its coast-line.

THE Norwegian whaler *Jasom*, Captain Larsen, has succeeded in reaching what is probably a higher southern latitude than any steam vessel had previously done. Part of the log of the vessel has been forwarded to Dr. John Murray, who communicated it to the April number of the *Scottish Geographical Magazine*, along with a map of the *Jasom's* route. The discoveries made were, in Dr. Murray's opinion, the most important since Ross's voyage. The Dundee and Norwegian sealers in 1892 found the sea to the south of Joinville and Louis Philippe Lands blocked with ice and swarming with seals; but in November 1893, Captain Larsen found clear water, and saw few seals. On December 1, when in lat. 60° 4' S. and long. 59° 49' W., rocky land was seen to the east, the coast-tending from N.W. to S.E. High snow-covered land was seen to the south on December 4, in lat. 67° S. and long. 60° W., and two days later the ship reached her farthest south point, 68° 10' S., finding a stretch of low bay ice with few cracks. A group of islands was found on the return, situated about 65° 7' S. and 58° 22' W., on two of which active volcanoes were observed. Captain Larsen landed on these islands, which were not covered with snow; but in order to do so, he had to cross seven miles of ice, using Norwegian snow-shoes for that purpose. Volcanic rocks were strewn on this ice, evidently thrown up by the volcanoes. The currents were observed to come from the south, and southerly winds were frequently met with, indicating the possibility of an Antarctic area of high atmospheric pressure. The map on which these discoveries are marked shows Graham's Land as a peninsula, and involves a slight alteration in the provisional sketch of the probable outline of the Antarctic continent. The result of this cruise adds great point to the agitation for an Antarctic expedition on a large scale, and it is interesting to note that the open sea so far south occurred simultaneously with an exceptional dispersal of Antarctic ice over the southern ocean.

BUT comparatively little is known of the bacterial contents of sea-water, and by far the greater part of the information which we have on this subject has been collected by Dr. H. L. Russell. The first observations made by this investigator were carried out at the Naples Zoological Station, and were subsequently published in the *Zeitschrift f. Hygiene*, vol. xi. 1891. Since then Dr. Russell has made an elaborate inquiry into the conditions affecting the distribution of bacteria, both in sea-water and mud, collected from the Atlantic Ocean near the coast of Massachusetts. A reprint in pamphlet form of these results, published from time to time in the *Botanical Gazette*, places very conveniently before the reader the various questions which have been attacked. Four new varieties of bacteria have been isolated, described, and carefully drawn, but to none of them was any pathogenic property attached. One of the most prevalent of the sea-mud forms that was isolated in the Mediterranean, was also found to be a common inhabitant of the sea-slime in this part of the Atlantic. One of the varieties isolated was found exclusively in the ground layers of the sea-bottom, whilst the three other forms were found both in the water and the underlying ground layers. Sunshine produced as disastrous results on these sea-water bacteria as on those obtained from fresh water. In his conclusions Dr. Russell points out that the indigenous marine flora of both

water and sea-floor is restricted to relatively few species; a marked contrast to the bacterial contents of rivers, lakes, &c.

WE have received from the Berlin Aquarium Society a copy of the regulations and of several other documents relating to the Marine Zoological Station established in 1891 by that enterprising body at Rovigno, in the Adriatic. Primarily intended as a source of supply of living marine animals to the Berlin Aquarium, the Rovigno station is also equipped for the purposes of scientific research with all the ordinary apparatus and reagents of a biological laboratory, a Jung microtome, a circulation of pure sea-water, a steam-launch, and a growing library. The site of the laboratory seems to have been very carefully chosen with a view to the purity of the sea-water supply, several available and nearer sites having been rejected owing to the existence of an excess of fresh-water or some other source of contamination. The fauna is rich and varied, the climate mild and genial; and Rovigno, without pretending to be in the van of modern culture, seems to be a pleasant and hospitable town, not least among its attractions being an excellent light wine at sixpence per litre! No charge is made for working in the laboratory, and permission may generally be obtained upon application to the Berlin Aquarium. The Rovigno staff is always willing to supply information as to lodgings in the town, and can also put up four naturalists at a time in the laboratory house at the moderate charge of one shilling per day. Altogether, British naturalists in search of fresh seas and creatures new may well consider the generous claims of the Rovigno station.

THE Royal Meteorological Institute of the Netherlands has issued its forty-fourth *Jaarboek*, containing observations made thrice daily at a number of stations, and hourly at four places. A considerable improvement has recently been made in the Dutch meteorological service by the adoption of the international scheme of publication recommended by the meteorological congresses; but it has already been pointed out by Dr. Hellmann that a further improvement might be made by taking the evening observations at one hour, instead of 7h., 8h., or 10h. p.m. as at present. There are few countries that can boast of a longer continuous series of trustworthy observations.

THE Rev. S. Chevalier, Director of the Zi-ka-wei Observatory, near Shanghai, has published a detailed discussion of the typhoons of 1892, based on observations made in the months of July, August, and September, on ships and at land stations. The pamphlet contains synoptic charts and valuable data for the study of the behaviour of these storms, and also a chapter devoted to the examination of some important questions relating to them. It has been stated that an area of high pressure always precedes, by some days, the arrival of a typhoon, but out of five of the principal typhoons of the year 1892 the author finds that only one was preceded by an anticyclone. Another important question is that of the convergence of the winds towards the centre of the cyclone. The observations show that the winds do converge towards the centre, not only in the exterior zone of the typhoon but also in the whirl itself. With regard to determining the distance of the centre of the typhoon according to the fall of the barometer, the conclusion arrived at is that while the fall is more likely to give an idea of the distance of the centre than the absolute height, the figures show clearly that no exact measure of the distance can be obtained by that means. An empirical rule for determining the rate of progress of the centre, formulated by Captain Fournier, has been found useful in some cases. An explanation of this rule and examples of its application are given in the pamphlet in question.

THE determination of the pitches of very high notes appears to be greatly facilitated by an arrangement recently worked out

by F. Melde, and described in the current number of *Wiedemann's Annalen*. The extreme difficulty of distinguishing between the various octaves of the same high note, led Mr. Melde to abandon the use of the ear altogether, and to apply the microscope to the more reliable vibrographic method. To prepare the plate for taking the traces, he melted a mixture of stearine and olive oil, and spread it out with the finger, thus obtaining a thin layer with a delicate ridged structure, which could be renewed by simply passing the finger over it. The tracing point chosen was a short piece of hair from the violin bow. By attaching one of these to each of the vibrating bodies, say a high tuning-fork and a rod vibrating longitudinally, and drawing the glass plate rapidly over the two tracing points, wave curves were obtained whose periods could be easily compared under the microscope. The tuning-forks were set vibrating preferably by means of a wet glass rod rubbing over a piece of cork attached to one of the prongs. This manner of exciting vibrations offers several advantages over that of the violin bow. The sounds produced are much more intense, they can be produced by either hand, or two at a time, and the rod is less perishable and less likely to get into the way of the other apparatus.

AN interesting paper on the difference of potential between an aqueous and alcoholic solution of the same salt, by A. Campetti, appears in the *Atti dell'Accademia di Torino*, vol. xxix. The author has determined the difference of potential which exists at the surface of separation between an alcoholic and aqueous solution of various salts, such as ammonium chloride, lithium chloride, calcium chloride, &c., which are soluble both in water and alcohol. The difference of potential was measured by means of dropping mercury electrodes, which have given satisfactory results in the hands of Pascheri. The measurements were undertaken with a view to seeing whether the numbers obtained by experiment agreed with the values obtained from Planck's formula, which gives the difference of potential in terms of the concentrations and ionic velocities of the electrolytes. The author finds that the formula is not applicable, but that in the case of two different solvents it is necessary to suppose there is some additional force coming into play, which is not taken account of in Planck's equation. He intends, in a subsequent paper, to give the results he has obtained on the ionic velocities in different solutions.

IN connection with the question as to the point of application of the mechanical force experienced by a conductor conveying a current in a magnetic field, M. Pellat has communicated a second paper to the Société Française de Physique, in which he comes to an opposite conclusion to that given in a former paper on this subject (see note in NATURE, March 22). The error in the former paper was due to the omission of a term in one of the equations. For if we consider a gramme ring at rest and on short circuit, and suppose that the field magnets are rotating, the wire of the armature is traversed by an induced current which warms it up, and it would be necessary to withdraw a quantity of heat  $Q$  to bring it back to its initial condition. If we consider the armature alone as a system, the electromagnetic forces, in this case, perform no work, and this heat communicated to the ring can only be due to energy supplied to the ring by the action of the electromagnetic forces, the product of an electromotive force by the quantity of electricity displaced being the equivalent of work, and this product may be called the work of the electromotive forces; it is work done on the system, and calling it  $\epsilon$  we have  $\epsilon = JQ$ . The same takes place when the ring is replaced by the Foucault disc. Consequently, in the case when the disc is in movement, the field magnets being fixed, it  $w$  is the work done by the weights which drive the disc, and  $x$  that done by the electromagnetic forces, we get

$e + x + w = JQ$ . Hence, since  $e = JQ$ ,  $x = -w$ . On the other hand, if we consider the disc and field magnets as forming the system under consideration, then  $w = JQ$ , and therefore  $e = -w$ . Since, therefore, the work done by the electromagnetic forces, in the case of the turning disc, is not zero, while the induced currents remain at rest with regard to the field magnets, the point of application of the electromagnetic forces must be the matter conveying the currents, and not the current itself, as the faulty reasoning in the previous paper indicated.

DURING 1893 a number of British agriculturists visited Canada, with a view to report upon the agricultural resources of the country. Among these visitors were Profs. James Long and Robert Wallace, and the reports prepared by these gentlemen have just been published. With the object of seeing exactly what is done by the Government for the benefit of the farmer, Prof. Long visited three of the five experimental farms which are now in full working order in the Dominion—those of Ottawa, Brandon, and Indian Head. The Ottawa farm is some five hundred acres in extent, and the reports of the experimental work done in it are sent to 25,000 farmers. The Manitoba experimental farm consists of 625 acres of land, in which a large number of valuable tests of grain suited to the country have been carried out. The experimental farm at Indian Head covers 680 acres. These farms are of the utmost importance to agriculturists. Hundreds of experiments are made in them with cereals, pulse, grasses, fruits, vegetables, forest trees, and plants of other kinds, with the object of providing the farmer with the best seed or the best variety. Some day, perhaps, our Government will promote the prosperity of agricultural interests in the British Islands, by establishing and endowing similar experimental stations here.

THE members of the London Geological Field Class will visit Wanborough and Guildford on Saturday, April 21, under the direction of Prof. H. G. Seeley, F.R.S.

MESSRS. BLACKIE AND SON have issued a guide to the Science and Art Department examinations in heat, and one to the examinations in hygiene. Both books contain answers to questions set from 1886 to 1893, inclusive.

THE "Handbook of Tasmania" for the year 1893, has been received. It contains a large amount of important statistical information referring to the colony, and a brief epitome of the historical portion of the "Tasmanian Official Record," which will in future be issued tri-annually instead of annually.

THE April volume of *The Country Month by Month* (Bliss, Sands, and Foster) should be obtained by all rambles through "meadows pied" and over "hillsides breaking in blossom," during this month. The book is brightly written by Mrs. J. A. Owen and Prof. G. S. Boulger, and forms a most interesting companion for country walks.

THE scientific publications of the Government of South Australia are very much in arrears. We have only just received the volume of meteorological observations made at the Adelaide Observatory and other places in South Australia and the northern territory, during the years 1886-7, under the direction of Sir Charles Todd, C.M.G., F.R.S.

THE Camera Club Conference will be opened by Captain Abney, at the Society of Arts, on Monday, April 23. Among the papers down for reading on the following day is one by Prof. W. Roberts-Austen "On the Methods of Recording High Temperatures by the Aid of Photography." Mr. A. Mallock will treat of "The Amount of Photographic Action Produced by Various Lengths of Exposure and Intensities of Light," and Mr. Andrew Pringle on "The Keeping Qualities of the Modern Dry Plate."

THE *Journal* of the Royal Statistical Society for March contains an important and comprehensive paper (the Howard Medal Prize Essay) on "The Perils and Protection of Infant Life," by Dr. Hugh R. Jones. The author concludes by saying: "I have insisted that the preventable forms of child neglect are in the main referable to want of parental responsibility—a condition which, it is certain, largely depends on ignorance. The remedy—the only remedy—in which I have any faith or confidence, is education."

THE report of Mr. C. Meldrum, the Director of the Royal Alfred Observatory, for the year 1892 has recently been issued. Though the work of the observatory refers chiefly to meteorology and terrestrial magnetism, a very useful part of it belongs to astronomical physics, for photographs of the sun are taken every day, when the weather permits. During 1892, 303 solar negatives and 285 prints were forwarded to the Solar Physics Committee for reduction. Records were obtained of well-marked magnetic disturbances on the following dates:—January 4-5, February 13-15 (this was the disturbance which accompanied the great sun-spot of February 1892), March 6-7, March 12-13, April 25-27, May 18-20, June 27-29, July 12-14, July 16-17, August 12-13, September 13, and December 5-6.

THE Royal Meteorological Society and the Sanitary Institute have arranged a course of lectures on meteorology in relation to hygiene, to be given in the Parkes Museum on Mondays and Thursdays, from April 23 to May 10. Mr. G. J. Symons, F.R.S., will begin the course with a lecture on "Instruments and Observations and their Representation." He will be followed by Dr. H. K. Mill on the "Temperature of Air, Soil, and Water." Mr. R. H. Scott, F.R.S., will lecture on "Barometric Conditions and Air Movements"; Mr. W. Marriott on "Moisture, its Determination and Measurement"; Dr. C. Theodore Williams on "Climate in Relation to Health, and Geographical Distribution of Disease"; and Mr. F. Gaster on "Fog, Clouds, and Sunshine."

WE have received from Messrs. O. Newmann and Co. a copy of a small book, devised and arranged after the directions of Dr. H. Zwick, on "Optical Experiments." In it are described a series of 150 experiments illustrating the laws of the propagation, reflection, and refraction of light. To make this course more useful to the class of student for which it is specially intended, namely beginners, the apparatus chosen is of a simple kind. The light source adapted throughout is that of a candle, and the experiments are selected accordingly. All the instruments referred to in the text are stated to be perfectly trustworthy, and the experiments are arranged for class-work so that many scholars may view them at the same time. For those wishing to occupy themselves with the more simple physical experiments, the book will be a useful guide. The descriptions of the experiments would perhaps have been improved if some of the technical terms employed had been more fully defined; for instance, in the first experiment the beginner is introduced to the words "rectilinear transmission," "translucent," &c. In the preface, however, Dr. Zwick refers the reader, concerning the headings, to any good text-book of natural philosophy, thus restricting himself solely to the description of the experiments. Numerous diagrams accompany the text.

AT the Institution of Civil Engineers, on April 3, Mr. C. Hunt gave some interesting particulars with regard to the manufacture of gas. It has been generally assumed that the deficient yield of tar which usually accompanied the use of a high carbonising temperature is fully made up by increased production of gas. In Mr. Hunt's experience, however, the highest production of gas has been accompanied by the largest yield, both of tar and ammoniated liquor. Experiments have

shown that there is a falling off of illuminating value when very high yields of gas are obtained. While the best general results may be obtained from carbonising at a fairly high temperature, it is essential that the gaseous products should be enabled to pass freely away and without encountering in the ascension-pipe any absorbent of hydrocarbons such as thick tar. Mr. Hunt has also tested the lime and air process for eliminating sulphur compounds from gas. Daily tests were made of the amount of oxygen in the gas from certain gas-works, and it was almost invariably found that when the oxygen went up the sulphur compounds followed. From this experience it was concluded (1) that oxygen, so far from assisting in the removal of sulphur compounds, was actually prejudicial, at all events, when present in any appreciable quantity; (2) that it was of use mainly for oxidation of the sulphuretted hydrogen by which economy of lime was effected, and the spent lime, being chiefly in the form of carbonate, with a large percentage of free sulphur, was rendered practically inodorous; (3) that the quantity of oxygen, either pure or as atmospheric air, which might be safely employed, having regard to reduction of sulphur compounds, varied with the  $\text{CO}_2$  present, *i.e.* the less  $\text{CO}_2$  the more oxygen. It further appeared that unless air could be almost completely excluded, the lime and air process was less suitable for the removal of sulphur compounds than one in which each impurity was separately attacked.

THE final results of an elaborate investigation of the atomic weight of barium are communicated by Prof. Richards, of Harvard, to the current issue of the *Zeitschrift für Anorganische Chemie*. The care which has been bestowed upon the perfection of the analytical processes involved, and upon the preparation of absolutely pure materials, together with the really remarkable agreement between the large number of individual values obtained, will doubtless cause this stoichiometrical contribution of the Harvard laboratory to take high rank among the more exact atomic weight determinations. A short time ago, Prof. Richards gave an account in the same publication of a series of determinations based upon the analysis of barium bromide, from which the value 137.43 for the atomic weight of barium was derived. This number is considerably higher than the usually accepted value, 136.8, derived from the determinations of former observers. In order to confirm his work, Prof. Richards has since carried out a similar investigation of the chloride of barium, an undertaking much more complicated than that of the bromide, on account of the slight solubility of silver chloride in water. Eleven series of experiments, including altogether forty-nine individual atomic weight estimations, have now been carried out, having for their object the determination of the ratio of barium chloride to silver chloride, of barium chloride to metallic silver, of barium bromide to silver bromide, and of barium bromide to silver. The atomic weight finally arrived at, if oxygen is valued at 16, is 137.43; the actual number obtained by use of the chloride was 137.439, and that derived from the bromide 137.430. Moreover, the highest and lowest individual values obtained among the whole fifty separate estimations were 137.42 and 137.45, an amount of accordance which affords evidence of the extreme precautions taken, and of the high degree of accuracy attained. If the Stas value for oxygen, 15.96, is assumed, the atomic weight of barium is 137.10, and if the new value, 15.83, is taken as comparative standard, that of barium becomes 136.41. It is interesting that the experiments with barium chloride afford a means of independently ascertaining the atomic weight of chlorine, and the number thus obtained is 35.457, identical with the value ascribed to it by Stas.

THE additions to the Zoological Society's Gardens during the past week include a Brown Capuchin (*Cebus f. nelli*) from

Guiana, presented by Mrs. Walter Palmer; two Leopards (*Felis pardus*, ♂ ♀) from south-east Africa, presented by Mr. J. Gardiner Muir; a Vulpine Phalanger (*Phalangista vulpina*, ♂) from Australia, presented by Mr. Raymond W. Cooper; a Crab-eating Opossum (*Didelphys cancrivora*, ♂) from St. Vincent, presented by Mr. G. Stephen; a Tawny Owl (*Syrnium aluco*) British, presented by Mr. G. L. Hunt; a Greek Tortoise (*Testudo græca*) European, presented by Miss Leigh; a — Elap; (*Elaps*, sp. inc.), a Pointed Tree Snake (*Dryophis acuminata*), a Clouded Snake (*Leptotyphlops nebulosus*) from Trinidad, W.I., presented by Mr. R. R. Mole; a Tarantula Spider (*Mysale*, sp. inc.) from Trinidad, W.I., presented by the Rev. S. D. Wright; a Malabar Parakeet (*Palaornis columboides*) from India, deposited; four Bahama ducks (*Dryfla bahamensis*, ♂♂, ♀♀) from South America, two Mandarin Ducks (*Erythraea galericulata*, ♀♀) from China, a Spotted-billed Duck (*Anas platyrhynchos*, ♀) from India, a Ruddy Sheldrake (*Tadorna casarca*, ♀) European, four White-backed Pigeons (*Columba leucostota*) from India, purchased; a Barbic Wild Sheep (*Ovis barrhel*, ♂) from the Himalayas, received in exchange.

#### OUR ASTRONOMICAL COLUMN.

DENNING'S COMET.—*Astronomische Nachrichten* (No. 3222) contains the following elements, computed by M. Schulhof, for the comet discovered by Mr. Denning on March 26:—

T = 1894 February 13<sup>h</sup> 20<sup>m</sup> 39<sup>s</sup> Paris Mean Time.

$$\left. \begin{aligned} \lambda &= 132^{\circ} 14' 31.6'' \\ \beta &= 75^{\circ} 51' 46.1'' \\ i &= 6^{\circ} 31' 14.0'' \end{aligned} \right\} \text{Mean Eq. 1894.}$$

$\log q = 0.084720$

These elements resemble those of comets seen in 1231 and 1746.

#### Ephemeris for Berlin Midnight.

| 1894.    | R.A.     | Decl.      |
|----------|----------|------------|
|          | h. m. s. | ° ' "      |
| April 12 | 10 47 37 | +23 14' 6" |
| 13       | 50 7     | 22 45' 5"  |
| 14       | 52 33    | 22 16' 9"  |
| 15       | 54 57    | 21 48' 6"  |
| 16       | 57 18    | 21 20' 7"  |
| 17       | 10 59 36 | 20 53' 3"  |
| 18       | 11 1 51  | 20 26' 3"  |

THE NATAL OBSERVATORY.—The superintendent of the Natal Observatory has issued his report for the fiscal year 1892-93. The principal series of observations made during this period was the comparison of the declinations deduced from observations made at the observatories in the northern and southern hemispheres, by a comparison by Talcott's method, of the zenith distances of northern stars and southern circumpolar stars. The opposition of Mars in 1892 threw a deal of extra work upon the observatory. Thirty-eight sets of meridian observations of the planet were obtained, and sixty-two sets of observations taken on opposite sides of the meridian towards the eastern or western horizon. The whole series of these observations have been completely reduced and tabulated, ready for the final discussion for obtaining the value of the solar parallax and distance of the sun as soon as the meridian observations of the planet, made in the northern hemisphere, have been received. The observations made at the Cape observatory supplement those obtained at Natal, and the two sets combine to form a complete set extending over the whole period of opposition. This year will bring another favourable opportunity for determining the solar distance from observations for the opposition of Mars, and the observatory will be far better equipped for observing this opposition than was the case during the last one, and if the weather be favourable a very satisfactory series of observations should be obtained during this, the last, opportunity until the year 1911.

A NEW COMET.—The following announcement has been sent out by the Astronomer Royal:—"Bright comet Holmes, April 9. Right Ascension, 17h. 58m.; North Declination, 71° 30'."

THE INTERNATIONAL MEDICAL  
CONGRESS.

THE International Medical Congress, held at Rome, came to an end last week. In point of numbers it was a great success, as many as seven thousand members and recognised guests being in attendance, without mentioning the large number of visitors not connected with the Congress.

The Congress was formally closed on April 5, the final proceedings being very enthusiastic.

Prof. Baccelli, the president, in bidding the delegates farewell, said that in attending the Congress they bore testimony to the fact that for enlightened minds the claims of science were paramount. He proposed that the next Congress, which would be the twelfth, should be held in Russia, leaving it to the Government of that country to determine the place of meeting.

M. Danileffky, in the name of the Russian Government, accepted Signor Baccelli's proposal, the announcement being received with applause. The representatives of all the foreign committees then spoke in turn, and referred in warm terms to the hospitality shown to them by the King and Queen of Italy and the Italian Government.

We hope to give in our next issue an account of the proceedings of some of the sections. In the meantime, however, we reprint from the *British Medical Journal* the abstracts of two addresses of great interest.

Prof. Michael Foster on the Organisation of Science.

One of the most salient features of animals is a division of parts whereby each part does its best to fulfil the work required of it. On the other hand, all the parts of the body are so united that every part works for the common good. Just as in the body politic there are laws and unwritten customs which regulate the actions of the members, so also with the workers in science. Differentiation had proceeded to a great degree amongst scientific workers; each inquirer has now to limit his inquiries not only to one science, but to one part of that science, and there is no doubt that in the future division of labour will have to proceed still further.

So much for division; but what about integration? Is it possible for anything to be done to unite the different scientific workers together? I think that there is, and it seems to me that this International Congress of Medicine—of medicine which is the mother of all sciences—is a suitable opportunity, and Rome is a fitting place to propose the doctrine that human wit may well devise some tie that will bind all the workers of the world together by one indissoluble knot. What is wanted in science is organisation; by this the labours of the individual will be lightened and the progress of science will be furthered. Let me now ask whether organisation can be applied and inquiries carried out by single investigators?

There is, however, a danger which I do not want to under-rate, for we must bear in mind that an investigator is like a poet, *nasitur non fit*, and there is a danger that by organisation we may tend to nurse the unfit and hamper the fit. There are two main incitements to investigation—one is love of fame and the other love of truth, that curiosity to know the truth which drove Adam and Eve from the garden, and which has ever since stimulated mankind. Ambition will be hampered by organisation, the lover of truth for its own sake will be aided, and the latter is undoubtedly the more important of the two. As I look around me, I see everywhere waste of effort. Every inquirer knows that when he commences an inquiry he is sure to come upon side issues which have to be investigated, and he is obliged either to devote much time to them and partly to solve them, or he has to leave them alone. Every inquirer goes to his rest leaving many of his problems unsolved. There are plenty of young men capable and anxious to solve them, but, owing to the want of organisation, they do not know what to undertake, or they dig wells where there is no water. In all this energy is wasted, and in addition a great deal of work is thrust upon the world which the world were much better without—work which is crude, unfinished, unmaured, a veritable sewage thrown into the pure stream of science, which has to be got rid of before the stream can again become free from impurity. Is there any way by which this waste of energy may be diminished and this increasing flow of useless matter lessened? It is on this point that I wish to make a suggestion to the Congress. In the old times there were guilds by which the workers in any one

branch were united together. Now in science many men have laboratories and no men to work in them, or no men that are fitted to work in them; others, again, have men and no laboratories. Would it not be possible to form a guild, and so unite these workers, so that by the guild the work done might be polished and completed before it is given to the world?

There are many kinds of inquiry which would be much benefited by concerted action. Two of these which merge into each other are statistical inquiry and what we may call skilled inquiry. The chief feature of the former is that the data which are gathered should be homogeneous. There should be no exercise of individual judgment by the inquirer. It is evident that the value of statistics largely depends upon the width of the field covered, and the collection of statistics by many nations at the same time would be of the greatest value. I can especially aver that this is the case in the biological sciences. By this means we might avoid the collection of statistics based on insufficient cases or over so limited an area as to be worthless, couched in percentages, so that they have an apparent value which is most misleading and dangerous. The second kind of inquiry is the skilled inquiry, that kind of inquiry which should only be undertaken by skilled men. As an example, I may mention a solar eclipse. How valuable the knowledge that has resulted from several skilled men observing and discovering the same thing at the same time! The favourable opportunity for an investigation may be a short one, and the advantage gained by concerted action would be in such a case very great. Again, the number of skilled observers living at any one time is not great, and they are spread over many lands. The problems of the future must be faced by the best men, and why should not these men work together? Why should not the best men be selected—now an Italian, now a German, now a Frenchman—because they are best to do the work for which they are best fitted? It is only in this way that we can get the best work done in the future.

Expense is another reason why scientific work should be taken up by nations in common, for every day the pursuit of scientific investigations becomes more costly, and may in any given case be too expensive even for the richest nation.

If such a proposal be a good one, then there must be some international organisation if it is to be possible. No nation waits to prepare for war until the drum beats to arms, so in science we should be ready with our organisation for whatever work may present itself. The chief difficulty of starting such an organisation is the expense at the commencement; when that is once got over, the cost of fuel to keep it going is not great. If once in working order, a permanent organisation could at any time start the machinery which was necessary for any special work. Scientific work is the property of the whole world, and as such the whole world should combine to fight the powers of darkness and ignorance.

The dangers which apply to the individual in such an organisation also apply to the nation. Ambition when applied to a nation is called patriotism; but surely the love of truth is higher even than patriotism. Leaving generalities, every worker knows how much difficultly small things create in his work. For instance, nomenclature. How great a help it would be if there were only an international tribunal before whom every new name had to go, and who would, as it were, stamp the coin of science before it was allowed to pass into circulation. Again, it may happen that some inquiry has to be carried on under special conditions. An example of this is the work done at the zoological station at Naples. This is in reality an international institution, although it has been chiefly originated by one man; such an institution ought to be international, and ought not to depend for its existence upon the energy of one man.

One more instance. The condition of scientific literature can only be described as one of chaos. Think of the literature that a scientific worker has to read through before he can know what has been done by others—journals, weekly, monthly, yearly, in all languages, journals upon all subjects! Whereas, if all the papers on one subject could be collected under one cover, think of the saving of time! Even if this cannot be done, at least it might be possible to have a universal index which should appear at frequent intervals, and which should be re-classified every five, and again in ten years, and so on. Such a list of titles would enormously lessen our labours. I would suggest that this Congress should initiate the work, should set in motion the formation of such an index. If this be done it will be a commencement in organisation, and if this be done successfully we

may then pass on to other international works which may present more danger and greater difficulty.

**Prof. V. Babes on the Position of the State in Respect to Modern Bacteriological Research.**

The health of the community is under the care of the Department for Internal Administration of the State; and inasmuch as health is essential to the happiness of the individual and the development of human energy, it appears, for most important economic reasons, to have a first claim on the Government. Those learned in such matters are, however, of opinion that, in spite of its immense importance, of all the different departments of internal administration that of hygiene has remained the least developed in Europe. I will first attempt to throw light on this sad circumstance, affecting as it does the most valuable of human possessions—one that gives value to other possessions—and then I will search for means to obtain for sanitation its proper position amongst State institutions.

**HISTORICAL SURVEY.**

The care of public health does not necessarily advance hand in hand with education; a lively and practical public spirit and a great vitality in the people cause a place to be yielded to the demands of State sanitation. The oldest civilised peoples regarded it as a public duty to protect the health of the individuals. With a view to this, the laws of Sparta, of the ancient Egyptians, and of the Israelites, had more hold than modern legislation on the life of individuals. Still, their rules were not founded on any sure basis, but rested entirely on old traditions and experiences, which the spirit of the period clothed in religious or political dress.

In the laws of these old nations matters were regulated, which, according to our modern feelings are now left to the care of the individual, and sexual disease was more rigorously opposed than it is at present. Leprosy, from which the first civilised nations ran great danger, was opposed by more rational laws than it is thought can be opposed to the just as dangerous or more harmful diseases of to-day. The good results of the working of the Mosaic laws can still be seen even in our days when State sanitation can derive so much aid from modern sanitary science. The Mosaic laws owing to their religious form took deep root in the domestic life of the people, and the vitality of the Jews of to-day bears witness to their wisdom. The Jews thrive where the native population, in spite of special legal protection, is decimated by infant mortality and infectious diseases. The hardening of the constitution, the dress and baths of the people are neglected by modern legislation for the reason, though expressed in various ways, that the State has only to look after the health of individuals so far as the health of individuals affects the community."

When one contrasts this vaunted principle of individual liberty with the limitation of this liberty which is effected in the interest of religion, of the ruling classes, and even of traditions and conventional ideas, one cannot repress the thought that this magnanimous permission of the State allowing each individual to make himself ill if he likes, to treat himself as he thinks best, and spread his illness, is not merely dependent on the principle of individual liberty.

But also in another direction did the civilised nations of antiquity set us a good example—namely, in the repression of general causes of disease. Aqueducts and canals were made at great expense, marshes were drained; during the plague of Athens great fires were made and excreta burned, dead bodies were cremated, and the principles of public hygiene were also popularised by lectures. In spite of the much greater State incomes and the technical facilities of modern times, most modern States cannot nearly rival those of ancient times in the proportion of their sanitary undertakings to the number of their population.

In respect of public health, Rome advanced still further than Eastern civilisation. Aqueducts and canals were undertaken in early times; owing to the number of public baths in Rome, probably each citizen could have a free bath daily, and similar establishments existed in the smaller towns of the Roman empire. The irruption of barbarian hordes on the Roman empire disturbed the whole organisation of public health, and Christianity to some extent helped in producing this disturbance, especially by its ascetic disregard for corporal welfare, and by

the absolute separation, which it enjoined, of religion from all matters of bodily health.

Epidemics raged and exercised a wholesome influence, in part by reducing the population, and by directing attention to the infectious nature of diseases. People began to notice that contagion was carried about by men and clothing, with the result that quarantine and sanitary police were introduced by some towns of Upper Italy. Venice was particularly active in these matters of hygiene, but the unsettled political state of Italy long prevented the proper development of State sanitation. After the unification of Italy this development soon began to show itself, and the law of 1866, and particularly that of 1888 ("Sulla tutela dell' Igiene e della Sanità pubblica"), were framed, the latter of which might serve as a model to other States of Europe, with the exception perhaps of England. By this law the authorities on hygiene take that position which, as competent authorities, is due to them. As well as a competent upper board of health there are provincial boards of health, all of which of their own initiative can move proposals on hygienic questions, and must be consulted on sanitary ordinances. These boards of health are not dependent on the administrative officers, and all urgent measures recommended by them must be immediately carried out by the prefects.

In England a practical public spirit early developed itself. What was accomplished in hygiene began from below, and took deep root in the customs of the people, before developing into institutions of the State; this insured its usefulness and recognition. The practical independence of the parishes, as well as the Parliamentary system of that country, showed to advantage in this matter; there were water supply committees, and the parishes left to the sanitary authorities the choice of their own methods. As in other countries, infectious diseases first gave occasion for thorough trial of sanitary arrangements. Committees were formed for statistical inquiry into mortality with regard to soil, overcrowding, with regard to the pollution of air, water, &c., and the activity of these committees led to important conclusions regarding the artisan population, which had attained so great an importance owing to the growth of the manufacturing towns.

The Public Health Act of 1848 was formed in accordance with the then existing state of scientific knowledge on a statistical basis, a testimony to the public spirit of the country. Local bodies, under the guidance of a doctor, had executive power, and could levy rates to cover the expense of water supply, canalisation, &c. Unfortunately, as usually happens in such cases, when a better hygienic condition was reached, the means by which it had been obtained were neglected. The Board of Health was abolished, but, on the other hand, the Local Boards gained in power. In 1871-72 a Board was instituted for seeing to the poor, sanitary matters, and Local Government, the whole country being divided up for this purpose into sanitary districts. Each of these districts possesses a medical officer of health, a sanitary inspector, and a public analyst. These officers work in connection with each other, and with the central officers, and possess the power of taking measures to oppose epidemics.

In Prussia the sanitary arrangements have a bureaucratic aspect. There was a College of Medicine and a special College of Hygiene, to which the doctors of towns and districts were subservient. In 1862 officers were appointed to the different provinces, but their power was limited by the central bureau.

In Austria, since 1870, there has been a chief sanitary officer working with the junior ones, who, at all events, have the power to take first steps.

In Roumania, by the law of 1873, the sanitary administration is placed in active communication with the doctors of towns and districts, and controls them by yearly inspection. The latter are, in the same way as the hospital doctors, recommended by the special sanitary adviser to the central administration.

In France, although the medical schools are distinguished, public health is not sufficiently cared for, because the learned scientific bodies have hardly any voice in its administration. The prefect and the mayor do all the administrative work, and an authority on hygiene is only consulted when the prefect thinks fit.

Of late years attempts have been made to include institutions for the furtherance of scientific medicine within the State



organisations for hygiene. We shall see that just the most rational hygienic measures are opposed and partly abolished on the plea of their being inconvenient to commerce and intercourse, and to the influential Government administrators. International arrangements for protection against epidemics have also lately several times been neglected for the sake of the commerce and intercourse of the great nations, and partly at the sacrifice of smaller nations with less complete sanitary arrangements.

*The Position of Doctors towards the State.*—The medical profession in many countries is not permitted to exercise any executive right to protect the country against epidemics. It must be allowed that there is a tendency for the scientific men employed in some State institutions of hygiene to separate themselves from the statesmen who founded these institutions. It must appear to us doctors unintelligible that, though statesmen recognise the immense importance of public health, they will not surrender the executive power of sanitary administration into the hands of those who have made it their special study. Doctors constitute a hard-worked class, possessing neither the time nor the authority to make their claim felt, and it is to be regretted that so few members of the upper classes of society devote themselves to medicine, which offers them such a field for useful work.

Doctors are not much attracted towards State matters of hygiene, because of the smallness of the pay allowed to those who enter the service of public hygiene. The State should pay its sanitary advisers better, since it expects of them a special professional education, and should, at the same time, forbid them the practice of ordinary or legal medicine. Doctors would then be able to devote themselves to finding out and remedying the causes injurious to public health, just as they would those injurious to the health of a family. Finally, every facility should be given them of making themselves familiar with the science of government, especially legislation, political economy, and statistics.

*Government Sanitary Institutions.*—The best way to improve the quality of the doctors is for the State to afford them the means of attaining the highest essential education. This necessitates State institutions specially designed for the purpose. An attempt of this kind was made in 1876 in Germany, but want of understanding and money caused the institution to fall short of the mark. The Imperial Board of Health at present does not possess, as it was at first intended, the superintendence either of medical and veterinary measures or of medical instruction, neither are the laboratories sufficiently endowed to meet the requirements of proper sanitary research. Nevertheless, with the exception of Roumania, no other country possesses a similar institution, though they possess institutions, privately erected, for the study of infectious diseases, which act more or less in harmony with the State administration.

A few words, therefore, may be said on this institution of Roumania. As Roumania stands on the boundary between East and West, it was peculiarly exposed to infectious diseases, not to mention several imperfectly known diseases of the country itself. In 1887, epidemics amongst the cattle and widespread hydrophobia rendered it advisable to establish such an institution in Roumania; moreover, no sort of institution for pathological anatomy, pathology, or bacteriology existed there at that time. The institution is well endowed, and adapted to meet the requirements of scientific investigation and instruction, but unfortunately possesses no administrative authority.

[Prof. Babes then gave a description of the work carried on in the various departments of the Roumanian Institute, showing in what way a State institution of this nature may, even in spite of special difficulties, render service to hygiene and science. He went on to say that:]—

Such an institute should always be in connection with a hospital for infectious diseases, and the institute itself should be divided into five or six closely-connected parts: (1) For clinical treatment and experimentation; (2) for pathological anatomy, bacteriology, and experimental pathology; (3) for infectious diseases of animals; (4) for chemistry; (5) for statistics, superintendence, and the library; (6) for lecture rooms, museum, and management.

The building should consist of a main edifice and several pavilions. The chief edifice must be for laboratories, and, if outside the town, there must be a dwelling house close by for the director, staff, and servants. There must be a completely

isolated pavilion for inoculation of men, and about three others for examination of animals, and there must be several places for breeding animals.

The staff should consist of director, about four superintendents of departments, eight assistants, officials in charge of statistics, a librarian, a manager, and about eight or ten servants. The total cost of the undertaking would reach about 1,000,000 francs.

The director and his staff should give lectures, &c., with special regard to hygienic administration in its widest sense—for doctors in the public service, for candidates desirous of obtaining medical offices, for architects, engineers, administrative officials, and students. The institute for pathology and bacteriology might be under the control of a "home office" or a "health office," but must have the right of preparing hygienic laws for the State authorities.

Besides this great institution there should be well-endowed professional schools for lower officers of health, and the elements of hygiene should be taught by capable teachers in all schools. No public buildings, aqueducts, or canals should be constructed by persons who have not received proper instruction in hygiene.

Institutions of this kind could systematically investigate the most important hygienic and medical questions. In times of peace the fight should be for the people's health, and only a scheme of this kind will enable hygiene to secure her place as the most important part of statesmanship.

#### THE ATTITUDE OF STATESMEN TOWARDS THE CLAIMS OF HYGIENE.

The chief reasons advanced why statesmen refuse to give very great power to the hygienic authorities, may be enumerated as follows: That the necessary means are wanting to enable the State to undertake the task demanded; that the personal liberty of the individual would be endangered; that the scientific basis is still not sufficiently sure; that the demands of science are very often hard to carry out; and, lastly, that if they were carried out, other equally necessary State duties might have thereby to be neglected, or the consequences might be injurious to the State (Löhning).

(a) *Liberty of the Individual.*—Different countries and schools are not agreed on its proper bounds. One opinion is that the State has not the right to exercise restraint on a man, provided that he hurts himself only. Stein, on the other hand, considers that the health of the individual affects the community just as much as it does the individual himself; and, indeed, so many diseases have turned out to be more or less of infectious nature, that the ground is now removed on which the former opinion was founded. Some hold up as their model English principles of individual liberty, whereas it is exactly in England that the sanitary authorities have most control over this individual liberty. It is obviously not logical to argue that because it is not right to compel a man to undergo an ordinary amputation, therefore one should have no power over a man when he has an infectious disease. Again, if the State is compelled to control the liberty of a criminal, why should it not also control that of persons affected with syphilis or tuberculosis, who may spread their diseases and thus harm others? Another reason (less frequently mentioned) against the right of restricting individual liberty is that this power might be misused for the sake of party politics, &c. This affords an additional argument in favour of having a sanitary administration quite independent of party politics.

(b) *The Disposal of Public Funds.*—A more difficult question is whether the State possesses money enough at her disposal both for looking after public health and the health of individuals. Emergency measures adopted during epidemics such as cholera, can often not be carried out owing to want of previous organisation in the hygienic department. A bureaucratic paper regiment is nowhere so unpractical as in battle against the powers of nature. The administrations for war and religion in most large nations are best endowed, whilst the condition of the other administrations depends greatly on the energy and influence of the Minister at the time, and since hygiene is usually included in the department of the Minister for the Interior, who is no professional man, but often influenced by party interests, the prospect in this direction is not very hopeful. An independent Ministry of Hygiene, with a professional man at its head, could do much more.

Under the present state of "armed peace" in Europe, the

maintenance of such large armies is very costly to the different Governments. Part of the army might possibly be made use of for sanitary purposes without impairing its power in case of war. But besides the army, other departments (religion and law) are richly supplied in comparison with hygiene. On the whole, it seems that hygiene is neglected because the State funds are employed for other and less necessary purposes.

(c) *The Importance of Hygienic in comparison with other State Expenses.*—It must be allowed that quarantine is hurtful to commerce, but modern quarantine methods are much less so than the older ones. Quarantine is also a hindrance to intercourse, but in this respect affects the ruling and wealthy classes rather than the lower ones, to which latter, on the other hand, epidemics are more baneful. If the money gained by neglecting quarantine arrangements were spent for other sanitary purposes or for the lower classes, one could not object so strongly; but it is spent on the army, and therefore against the direct interests of the lower classes.

It is objected that quarantine is impractical. I cannot enter on that question here, but perhaps the failure of quarantine measures on the frontier depends not so much on the nature of the infectious disease as on insufficient knowledge or want of exactness in carrying out the measures. At any rate no international arrangement has the right to withdraw rational quarantine from a State which has hitherto been protected by it, and whose internal arrangements are not sufficiently organised to suppress an epidemic should one arise. The Hamburg cholera epidemic was more injurious to the town than a rational quarantine would have been. However important school instruction may be to the State, schools should be closed immediately on the outbreak of an epidemic. The danger in institutions for small children is especially great on account of their peculiar susceptibility to disease and mortality from it.

#### POSITION OF MODERN BACTERIOLOGY WITH RESPECT TO ITS USEFULNESS TO THE STATE.

One reason given for the State neglecting the care of health is the belief that medical science and hygiene cannot on sure ground fight against and keep off disease. This cannot be altogether denied, and must be discussed as regards the various diseases, but the belief arises in part from the means employed by the State against the diseases being insufficient, and therefore failing to produce the required effect.

(a) *Precautions about Water and Soil.*—Modern science has demonstrated the important part played by drinking water in the production of some diseases. Cholera bacilli have been found in bad drinking water, so also saprogenic bacilli, which, according to my investigation, play an important part in infantile diarrhoea, enteric fever, and dysentery. The bacteria of suppuration have likewise been found in drinking water; and, according to my latest investigations, it appears that the parasites of malaria pass through one stage of their development in water. It is therefore clear that one urgent duty of the State is to provide good drinking water. This may be obtained from deep wells or from springs direct from the rocks, or (under careful management) by filtration through sand. Our discovery that by small quantities of alum, water may not only be clarified, but also sterilised, may in time be made of some practical use. On the whole, one must doubt whether water obtained by sand filtration is sufficiently good to be used as drinking water, and the various household filters must be rejected.

The soil must be purified by drainage, but the canalisation of towns is still an open question. The drains of a town can only be carried into a river when the river is of large size. In last year's cholera epidemic in Roumania, I found that the water from the centre of the Danube was almost sterile at only a small distance below the infected towns, although the cholera bacillus could be repeatedly found in the water of the immediate neighbourhood of the towns. Therefore, although drinking-water from the Danube in the immediate neighbourhood of the towns could undoubtedly be a cause of the spread of cholera, it seems to me very unlikely that a town can be infected from another town lying much higher up on the river.

[Prof. Babes pointed out that the air can only be rendered infective through dust, though different gases in impure air can produce other illnesses. He afterwards considered the means to counteract such diseases as tuberculosis, syphilis, cholera, typhus, yellow fever, the plague, and small-pox, urging that the State should interfere to prevent the spread of all these and many others. Continuing, he said:]—

From these few examples it becomes manifest that a State, perfected in the way I have laid down, could by the means at our disposal already do much more for the health of its citizens than it does at present, and it is clear that the erection of proper institutions would help to this end. It is clear also that we are not justified in separating the public health from that of the individual, but just on this account the State work will be increased and a thorough reform of the sanitary administration appears necessary.

If we were to contrast the demands made here with those acknowledged by statesmen, we should see that the latter limit the rights of the State too much and do not take the universal importance of hygiene into due consideration. Although they profess to acknowledge the immense importance of hygiene, they place other State interests in the front, which prevent the carrying out of measures for the advantage of hygiene; they only recognise certain conditions under which the State can take care of the health of individuals, and they always dread the interference of the State with family life, though in the interest of public health.

Against these objections science will be powerless until it can practically and clearly demonstrate the results of modern research; but on our part it will first be necessary to free ourselves of all non-scientific interests, and leave to others the interests of commerce, industry, politics, the army, and the family. There should be doctors who are not deterred by practice, but specially trained to make known to the ruling bodies—especially the Parliament—the advances and practical application of science, so as to obtain that position for the organisation of hygiene which belongs to it as being of the greatest importance for the happiness of the citizens.

The first result of this should be the erection of a richly-endowed institute of State hygiene, in which laboratory work may be turned to practical use, and which may serve as a high school for the statesmen in question, directors of hygiene and hospitals, and all Government officials, whether of the departments for instruction, medicine, or the useful arts, who occupy themselves with matters of hygiene.

An irrational and social reform should be obtained, because individual health cannot be separated from public health, because the health of one class is necessarily the health of other classes, and the health of the lower classes is of the highest economical value to the State. It is true, however, of the lower classes is affected by an unjust want of the primary necessities of life and health, as well as that the sufficient care taken by the State for public and private health. A settling of the social question becomes, therefore, essential for public health.

Furthermore, there would have to be an interference and agreement by which the sanitary interests of the working classes are placed above the interests of capital and competition, and by which a part of the expenses of State institutions—namely, the armies—are lent or given over for hygienic purposes.

The position of the sanitary officials should be fixed, and all the strength of the sanitary department should be used to fill up lacunæ in professional knowledge. The municipal administration should have equal power with the Ministries, and be without the political instability of the latter, and, on urgent occasions, should have the free right of direction. The sanitary should be more numerous, higher placed, well paid, and excluded from all other political or medical work.

Under such conditions sanitary questions can be thoroughly and scientifically considered, and the proper extent can be found to which the State shall enter on matters of individual and public health.

Although the free mental development of the individual is necessary for progress, the proper conditions of bodily development, which consist chiefly of the keeping out of harmful external influences, are more and more found to belong to the sphere of State work. The State thus protected is justified and bound to interfere directly or indirectly in the freedom of individual life, and moreover to a much greater extent than before seemed justifiable, because modern science tells that this is in favour of the sanitary development of the community.

Although the sanitary administration of some even in the best developed countries, is but poorly furnished with power, and in most civilised countries is absolutely powerless, nevertheless, in some few countries rational measures could be carried into effect which would clearly show how beneficial the general

adoption of such measures would be. As soon as a sanitary measure has been approved anywhere, as soon as some hygienic discovery has been made in the work-shops of medical science, it should be the duty of the State to try it, to estimate its practical value, and to make it generally known.

It is only by such means that hygiene will become a science, that this science will become the most important part of statesman-ship, and that the State will become, as it ought to, a healthy State.

#### ACROSS CENTRAL ASIA.

AT the meeting of the Royal Geographical Society, on April 9, Mr. St. George Littledale read a paper on his recent journey across Central Asia. Mr. and Mrs. Littledale left England in January 1893, with the intention of crossing Asia from west to east, filling up some blanks in the map, and procuring specimens of the wild camel. After purchasing nearly two pony-loads of silver Yamboos, known on the Chinese coast as Sycee Silver, they travelled in carts to Kurla, where they organized a caravan of twenty ponies and forty donkeys, and followed the river Tarim to Lob Nor. They camped by the Lob Nor swamp, but found the water too salt near the edge to drink; by wading out some distance they were able to get some less brackish, which was just drinkable. Along the Altyn Tag range, as far as the Galechan Balak, there was a certain amount of water and grazing. This was the point where the great Russian traveller, Pjjevalsky, turned back; but beyond, the desert was of an appalling nature—hardly any grass was to be found, and water was very scarce; all the men suffered greatly from thirst, the animals lost flesh rapidly, and many died. Water as a rule was only found every second day. Mr. Littledale in this district lost four wild camels, one of which he has presented to the British Museum. Pjjevalsky's wild horse was not seen. The guides were thorough scoundrels, and tried to wreck the expedition in every way; on one occasion they denied the existence of a spring from which they were discovered getting water secretly during the night.

Mr. Littledale was unable to see any trace of a large range of mountains marked on the maps as running north-east from the Altyn Tag. When a few days' journey from Sai-ju they met the first inhabitants, and in vain tried by bribes to get a guide to show a pass over the mountains. They afterwards discovered that their interpreter was playing false; he was scheming to get to some town where he could desert.

They passed an embankment several miles in length, which it was difficult to account for unless it was a continuation of the Great Wall of China from Suchan, two hundred miles to the east. At Sai-ju the Chinese officials were civil, but tried to prevent the travellers returning to the mountains, and their men, exhausted with their journey, were now in addition terrified at the tales they heard of the Tonguts, a Tibetan robber tribe, and refused a first to go on.

Colonel Yule questioned the accuracy of Marco Polo's statement that it was a month's journey from Lob Nor to Sai-ju; but, curiously enough, it took Mr. Littledale exactly thirty days to traverse the distance. As they travelled further east, and crossed the Humboldt range, they found the map which had been constructed from native evidence entirely wrong, and a considerable readjustment is necessary in order to secure an approach to accuracy. They passed large herds of yaks and thousands of antelopes and wild asses. Guides were a great difficulty, and the party were soon left to find their own way. At one place upwards of a hundred mounted Tonguts, carrying lances at least fourteen feet long, march-lock guns, and swords, came past their camp. Their followers predicted an immediate attack. Two badakis were sent to parley with them; one expounded a repeating rifle with such marked effect that when the other man proposed to explain the beauties of a revolver they begged him to put it aside, and any idea, if it ever existed, of a tacking the camp died a natural death.

Mr. Littledale found his own way over the mountains by a pass, and reached the head waters of the Buhain Gol. They travelled ten days through a luxuriant grass country, and camped on the shores of Koko Nor. Thirteen days more found them at Lanchan, where they disbanded their caravan; their interpreter, who was an ardent coward, absolutely refusing to go to Pekin. Here some China inland missionaries kindly helped them to arrange a raft, on which they drifted down the

Hoang-ho, a journey of exceptional interest through country which is largely un-mapped. Soon after leaving Lanchan the river dashes through a narrow gorge, and the raft had several narrow escapes of being broken up; it was knocked out of shape, and some of the logs smashed. The boatmen had each an inflated sheep-skin to act as a life-buoy in case of accident, but none were provided for the passengers. Lower down the river became broader and shallower, and they changed their raft for a flat-bottomed scow, and reached Bonto in twenty-five days. From Bonto to the Great Wall they passed through a country abounding in ruined towns and villages, the result of the disastrous Mahomedan rebellion in 1861. On September 27 they passed through the Great Wall, and reached Pekin three days later.

#### ELECTRIC TRACTION.

IN the present state of electrical science and practice, electric traction must be considered as a branch of the electrical transmission of energy. We require, first of all, a natural source of energy, such as coal or other fuel, or water at a high elevation or in motion. In the next place, we require a prime mover to transform energy into work, such as a steam or gas engine, a turbine, or water- or tide-wheel. Then this work has to be transformed into electric current, by means of a dynamo or magneto-electric machine, the so-called primary machine. The electric current has then to be transmitted from the place where it is produced to the place where it has to be used, by means of a conductor or a storage battery. The current has next to be retransformed into work, by means of a motor carried by or attached to the vehicle which has to be moved. This work has then to be mechanically transmitted from the motor to the axle of the wheel of the car which travels along the line.

In each of these transformations and transmissions a loss takes place, reducing the original unit of energy to a less and less fraction of itself. In the case of water, with a turbine as the prime mover, we obtain 60 per cent. of the energy as work or motive power, or an efficiency of '6. With a steam-engine, owing to the coal having to break up water into steam, a proportion only of the heat or expansive energy of which can be applied as pressure to drive the piston, because of the impossibility of obtaining, at least at present, a perfect vacuum, or, stated otherwise, of getting the lower limit of temperature anywhere near the absolute zero; and again, owing to the loss occasioned by transforming the motion of translation of the piston into rotatory motion, we have a much smaller efficiency than in the case of a water-wheel. About one eighth only of the energy of the coal is transformed in a steam engine into work to drive the axle, or we have an efficiency of only '125.

The efficiency of electrical machines is very high, as high as '9 with primary machines or dynamos, and '75 with secondary machines or motors. The conductor, or its substitute a storage battery, offers a resistance to the passage of the current, and when the latter is used its weight is so much extra weight to be carried by the car.

All these considerations seem to lead to the conclusion that before electric traction can be employed on a very large scale, we must possess a means of producing the electricity on the spot and at the time it has to be used, or, in other words, we must possess a battery in which the energy of coal can be transformed directly into electric current, so that we may do without storage batteries in which to carry electric energy about, or heavy copper conductors through which to convey it at moderately low tension from the spot where it is produced to where it is used, or light aerial conductors through which to convey it at high tension.

How long we shall be without this, or how many minds are engaged in the solution of this or some such problem, we know not, but the moment it is solved, and solved doubtless it will be, there will be such a transformation scene in the industrial applications of electricity as one can hardly conceive. It would mean that for almost every purpose except those in which heating is required, electricity would or could be used. An electric light-producing battery in every house, quite independently of any mains in the streets; an electric power-producing battery, to carry us whither we would on rail or on the street; and in every house, to put an end to all the evils attendant on crowded factories and workshops in crowded streets and towns; such

and other advantages would result from turning electricity from a servant into a master, from a mere transformer of energy into a source of energy.

But we have to do with things as they are:—One hundred per cent. of water-power turned into a net motor power of thirty-three and a third per cent. on the average of the best results; and certainly a wonderful result in itself—nothing of the kind could possibly be obtained either with a steam or a gas engine, and it points to the direction in which, at all events in the meantime, we have to look for a cheap supply of energy for electric traction.

Electric traction may be looked upon as the most economically difficult application of the electrical transmission of energy. The problem of the supply of electrical energy to a factory, for driving such industrial machines as lathes and sewing-machines, and for its illumination when need be, from an electrical main; the problem of utilising a single large steam-engine within a works for supplying motive power to all the different shops, so as to get rid of the waste and inconvenience of shafting, gearing and belting, is not without its difficulties; but these problems are, from the nature of the case, economically simple. The work that has to be done is of a uniform steady character within a compact space.

The problem of electric traction is quite otherwise; the load is now on, now off; the electrical resistance of the line is always varying with the distance traversed: here there are gradients, there curves; whilst the demand for cars, and the most economical supply of car-loads, are matters all of which have to be taken into consideration, and have their influence on the economy of the undertaking.

Six systems have been employed for supplying the motor on the car with electricity; these are using the rails on which the cars travel as conductors. This was done in the first undertakings at Lichtenfelde, and at Brighton in the first instance; having a special rail as conductor either beside or between the rails on which the car travels, as used at Portrush, now at Brighton, and on the City and South London underground electric railway; using underground conductors with an open conduit or slot in the road, as at Budapest, Blackpool, and elsewhere; having an insulated underground conductor, such as that laid down for a short distance near Hammersmith; overhead conductors, the system which has the largest application at present, and first used between Frankfurt and Offenbach, and mainly in use in the United States of America, where some 3000 miles of electric tramways are said to exist. In the sixth system the conductors are replaced by storage batteries.

The rails on which the cars run are now seldom used for the transmission of the current, as being an uneconomical application, but the use of the third rail is a simple and convenient method, where, as in this country, a pressure or tension above 500 volts is not permitted, and where a third rail on the surface, as in rural districts, or in special tunnels, is not an inconvenience; in urban districts, on the other hand, underground conductors are more suitable. There are two ways of arranging the circuit in underground conductors; either connecting the positive and negative poles of the generator, to two insulated underground conductors respectively, or connecting one pole to the insulated underground conductors, and the other to the rails, which in the latter case are in continuous conductive connection, besides having cross connections at different points.

The use of thin aerial conducting wires is interesting in connection with the practical appreciation of the fact, which took place some years ago, that electric energy consists of two factors, viz. the electromotive force or tension and the current strength. As it is to the latter only that a metallic conductor offers resistance, a certain amount of energy may be transmitted through a very thin wire, if care is taken that the electromotive force of the current is high enough. This is the system which it is proposed to use on the St. Louis and Chicago Electric Railway. The distance between these two towns is 250 miles, and it is proposed to run the cars at the rate of 100 miles an hour; the line is to be divided into twenty-five sections of ten miles each, and in the centre of each section there will be a transformer station. The current is to be generated at a tension of 500 volts, transformed to a tension of 25,000 volts, at which it will be transmitted to the several transformer stations, and will be there reduced to 3000 volts, transmitted to the wire, and thence to alternating current motors attached to the cars, each driving axle being supplied with a separate motor.

Secondary or storage batteries, which is the sixth system, to which we have referred, are specially suitable for use on existing tramways, on account of their simplicity and immediate applicability. The objections to them are their weight and the necessity of renewing them from time to time. As regards the former, they weigh from  $1\frac{1}{2}$  to 2 tons, and increase the weight to be propelled from 20 to 25 per cent., and there seems to be a real difficulty in making these batteries at the same time light and durable. The batteries which are oxidised by the direct action of the current are found to be too heavy for electric traction, and those in which the oxide is mechanically applied have been more generally used, the positive plate having a paste of red lead,  $Pb_3O_4$ , and the negative a paste of litharge,  $PbO$ . The life of a storage battery depends upon its being discharged at a low rate, whilst in traction high rates of discharge are required. It is the positive plate which becomes disintegrated, and cannot again be brought into the condition of metallic lead; the negative plate lasts for a very long time, and can then be re-cast.

This system has been employed on the Birmingham Electric Tramway. On this line a method of controlling the circuit is in use, obviating the necessity of inserting resistances in the circuit, which is always a wasteful way of employing the current. By this means the driver is able with a switch handle to apply from a fourth to the whole of the power which the batteries can produce; the whole would be available when required to start the tram, or when going up-hill with a heavy load, whilst a fourth would be used when travelling on the level with a light load. There are two other positions in which a half or three-quarters can be used as required.

A consideration of importance in connection with electric traction is the style of motor to be used; it should be able to do its work equally well when starting, when after having started it is under the influence of the full current, or where at the further end of the line the current is reduced by the resistance of the conductor; it must be able to be stopped in a moment, and work efficiently with all variations of speed and load. For these purposes shunt motors are not so suitable as series motors, in which the field-magnet coils are connected up in series with the armature, and hence the latter and compound wound motors are those most frequently used. Its special design depends upon the space at disposal in which to fix it, and upon the gearing—whether spur, chain, or worm gearing—used to transmit its motion to the driving axle of the car. In some instances it is advantageous to drive each pair of wheels by a separate motor.

In conclusion, it may be stated that the present conditions under which electric traction is carried on are altogether in its favour, namely, light tramway cars following one another in frequent succession, and travelling at a moderate speed. What is proposed to be done on the St. Louis and Chicago Railway is something quite different. It will probably be difficult to find passengers enough to fill cars to follow one another at a sufficiently quick rate to make the undertaking pay. And then as regards the very high speeds proposed to be used there and elsewhere, one hundred up to two hundred miles an hour, the cars will have to be made of special forms to resist the enormous pressure of the air at these high velocities, and specially ventilated; whilst the effective horse-power required to be supplied by the motor will greatly increase the weight of the car.

E. F. BAMBER.

#### EDUCATIONAL AGRICULTURAL EXPERIMENTS.

THE Agricultural Research Association of Scotland was founded for the purpose of obtaining trustworthy and useful information on agricultural subjects, by means of scientific investigation and practical experiments. The report of the committee for 1893 shows that the work of the association continues to proceed satisfactorily. Research work is always difficult to maintain, and a committee fostering it must regard it as an unavoidable, though unpleasant, duty to press its claims. "It is a matter of much regret to the committee," we read, "that we should have so constantly to press for adequate means to carry out the work, and that progress should so constantly be checked for want of means. But the reason is obvious, for an association confining itself to investigation holds a peculiar position. It is different, on the one hand, from organisations that are enabled to return interest for the money spent; and, on

the other hand, from those benevolent institutions from which no interest is expected. An experiment can never be in itself a source of money profit. Benefit may be regarded as certain; but while at times it may be immediate, it is often remote, and not unfrequently the benefit is derived in practice without crediting, or even tracing, the source from which the benefit has sprung."

Among other matters in the report from which this extract has been taken, is a description of educational agricultural experiments intended to be performed by schoolmasters in country districts. The suggestion that a scheme of simple experiments should be framed, such as teachers might suitably carry out for illustration, was made at a meeting of the Institute of Agricultural Education for the North-Eastern Counties of Scotland, consisting exclusively of certificated teachers of agriculture. Mr. T. Jamieson, Mr. W. A. Simpson, and Mr. Gavin Grieg, have now drawn up a scheme on the lines proposed. To show the effects of partial manuring, they suggest a series of tests, such as those shown from A to F, inclusive, in Fig. 1. A will thus exhibit the effect of nitrogen alone; B, of potassium alone; C, of phosphorus; D, of nitrogen and phosphorus; E, of phosphorus and potassium; and F, of potassium and nitrogen. The series of experiments indicated by 1 to 6 in the figure have been designed to show the effect of complete manuring. No.

employed. The experiments from Nos. 1 to 6, inclusive, will thus afford comparison with the farm trials to be performed by farmers in different parts of Scotland. The scheme will therefore not only prove of great educational advantage, but will lead to results of scientific value.

THE INFLUENZA EPIDEMIC IN GERMANY  
IN 1889-90.

THE patient compilation of countless facts, and their elaborate arrangement, is a task in the performance of which the Germans are *facile princeps*. If any fresh instance were required, we need only refer the reader to the official report, which has just been issued, of the history of the influenza epidemic which spread through Germany in the years 1889-90. This document covers upwards of two hundred pages of the large quarto volume containing the "Arbeiten aus dem Kaiserlichen Gesundheitsamte," and has been drawn up by Dr. Paul L. Friedrich, Königlicher Sächsische Assistenzarzt I. Klasse, Kommandirt zum Kaiserlichen Gesundheitsamte.

No pains have been spared to secure, as far as possible, trustworthy official data from all parts of the country concerning the various factors intimately connected with the epidemic. The

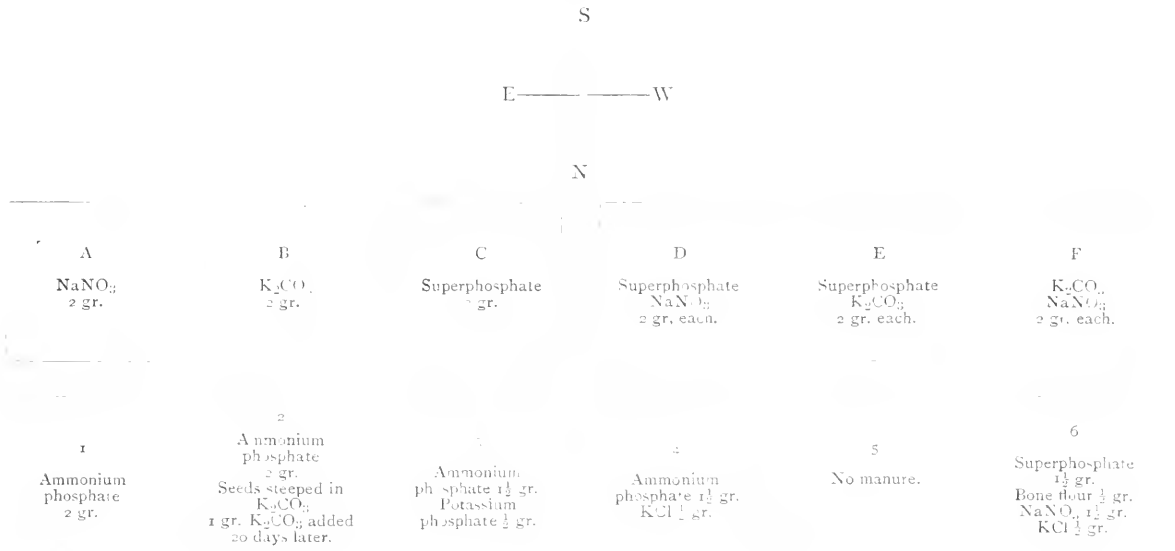

FIG. 1.

5, having no manure, will afford a comparison with the others. No. 6 will show the effect of complete manuring, as given in the usual manure mixtures. Nos. 1 to 4, inclusive, will show the effect of new forms of phosphate proposed for manure. For the steeping of the seeds in No. 2, a solution containing about one or two per cent. of potassium carbonate should be made, and the seeds allowed to lie in it for about twelve hours. The committee have prepared full directions as to the manner in which the experiments should be carried out. Twelve flower-pots are required, or wooden boxes, 9 x 9 x 12 inches deep. The soil with which these are to be filled should be dug out from a cavity 6 x 3 x 1 foot deep, and intimately mixed. It is suggested that five seeds be inserted in each pot or box, thus:—



Fifty days after sowing, the two plants marked x have to be taken up and sent to Mr. Jamieson, at the Research Station, Peterculter, Aberdeen, together with a 1 lb. sample of the soil

first forty pages of the report contain elaborate details and statistics as to the dates when influenza first made its appearance, and the period during which it remained, in the various provinces and cities of the empire. From the information collected it appears that Berlin and Charlottenburg were the first districts in which it declared itself. Statistics have also been gathered together of the varying intensity of the scourge in different parts of the country, and an endeavour has been made to ascertain the influence, if any, of different occupations on the path pursued by the epidemic. So many conflicting reports were received as to the effect exercised by the kind of employment on the susceptibility of the individual to influenza, that it was impossible to arrive at any definite conclusion. In some districts the evidence went to show that a remarkable immunity to the disease was exhibited by people engaged in *out-door* occupations, whilst from other parts the statistics collected pointed equally strongly to the freedom from attacks exhibited by workpeople employed *within doors*. In some glass works, however, careful observations showed that the employes who succumbed first to influenza were those who were farthest removed from the furnaces, and that those whose work was to remove the glass from the latter, and who were therefore working in a very heated atmosphere, enjoyed a remarkable immunity. Dr. Heiszler, who is responsible for these observations, ascribes the undoubted freedom from influenza experienced by these workpeople, to the air in the immediate

vicinity of these furnaces being relatively sterile, the microbes being doubtless unable to exist at such a high temperature. Influenza appears to have but little regard for either sex or age, for it attacked indiscriminately men, women, and children between the ages of fifteen and sixty. Its taste was proved to be equally catholic as regards climate and situation, neither meteorological nor geographical conditions appearing to exercise any sort of control on its genesis and distribution.

The effect of the scourge on the death rate from other diseases has also been carefully investigated, and, as far as the statistics go, it would appear to have materially increased the deaths ascribed to pulmonary consumption.

Innumerable tables are appended to the report, but, perhaps from a popular point of view, the following statement, compiled from official data, showing the time occupied by the epidemic in travelling from east to west, is of most general interest.

Influenza was present as an epidemic in June 1889 in Turkestan, it only reached East Russia (Wjatka) after a lapse of four months, in the middle of October. On October 28 it appeared in West Siberia, and after an interval of three months, travelling eastwards, it reached Japan in January 1890, and Hong Kong in February. On its westward course it moved more rapidly, for it appeared in epidemic form at the commencement of November 1889 in Moscow, and about a fortnight later in St. Petersburg. The capitals of Sweden, Denmark, Germany, Austria, France, and England were all attacked towards the end of November and beginning of December, whilst in Budapest, Brussels, and Madrid it appeared in the middle of December. In New York it was first heard of on December 19, whilst by the end of the month Milan, Rome, Naples, Constantinople, numerous districts in the United States, Canada, and Morocco were all in the hands of the scourge. The commencement and middle of January found it in Turin, Algiers, and Egypt, and by the end of the month it had made its appearance in Central America and in South Africa; owing to the small amount of communication existing between Europe and East Africa, it did not appear in these parts until the end of March. At the end of February it arrived in Bombay. Thus whilst in the absence of definite channels of communication it only made slow progress, requiring upwards of four months to emerge from the heart of Turkestan to European Russia, on once reaching Moscow and St. Petersburg it spread with lightning rapidity over western and southern Europe, crossing the oceans to all parts of the world.

The report manipulates in a masterly manner an immense mass of facts; but valuable as the statistics here collected must be for purposes of reference from an historical point of view, the conclusions indicate only too plainly how far we yet are from an accurate knowledge of the factors which control the genesis and distribution of this terrible disease, convenient hypotheses being continually upset by the conflicting evidence collected as to its course and conduct.

### SCIENTIFIC SERIALS.

*Bulletin of the New York Mathematical Society*, vol. iii. No. 6. (New York: Macmillan, March, 1894). — Prof. Harkness (pp. 135-141) gives a careful and appreciative abstract of the *Cours d'Analyse de l'École Polytechnique*, by Camille Jordan, a work commended by Prof. Klein in "The Evanston Colloquium," and which, in its second edition, is "entièrement refondue." Three interesting, though short, notes on Permutations (pp. 142-148) are furnished by Prof. F. Morley. They are headed a plea for the chess-board in teaching determinants, a special rule of signs, and the enumeration of positions. There are numerous references to the authorities on the subject. Notes and new publications are full as usual.

### SOCIETIES AND ACADEMIES.

#### LONDON.

Royal Society, January 18. — "An Estimate of the Degree of Legitimate Natality, as shown in the Table of Natality compiled by the Author from Observations made at Budapest." By Joseph Korösi, Member of the Hungarian Academy of Sciences, Director of Municipal Statistics.

The author has tabulated the age of the 71,800 married couples given in the Census of 1891, conforming to the single year-combinations. The virtual number of these combinations—

as 45 productive years of the male have to be combined with each of the 40 productive years of the female—is about 2000. Knowing thus the number of all age-combinations, he observed for four years (two before and two after the Census) the 46,931 births amongst couples of those ages. By dividing the figures obtained by four, he got the yearly probability of birth for each age-combination.

As the legitimate natality is to be regarded as a resultant between two distinct forces, the instinct of nature which urges towards multiplication and the forethought which causes moral restraint, it was also desirable to get an insight into the march of the physiological fertility alone.

Two degrees of fertility for each age were therefore obtained. The difference between the degree of physiological and that of the actual fertility shows, a few cases of procreative exhaustion being excepted, the influence of the moral factor. In the somewhat advanced ages this moral restraint exercises an influence exceeding all expectation. With the mothers of 30 to 35 it reduces the fertility to 78 per cent. (instead of 100 per cent.), with those of 43 to 2 per cent., i.e. 98/100 of the physiological faculty is suppressed. With men the influence is also very great, though weaker than with women.

Out of a large number of data here follow some figures to characterise the results:

| The fertility is  | For the mother.   |                          | For the father.   |                          |
|-------------------|-------------------|--------------------------|-------------------|--------------------------|
|                   | Actual. per cent. | Physiological. per cent. | Actual. per cent. | Physiological. per cent. |
| at 25 to 29 years | 29.2              | 30.9                     | 35.8              | 28.0 (?)                 |
| " 30 " 34 "       | 20.6              | 32.9                     | 27.1              | 27.0                     |
| " 40 " 44 "       | 5.9               | 20.4                     | 13.8              | 21.1                     |

"Results derived from the Natality Table of Korösi by employing the Method of Contours or Isogens." By Francis Gilton, F.R.S.

There are three variables in the statistics of natality. The age of the father is one, that of the mother is another, and the percental offspring of parents of those ages is the third. These three variables may be co-ordinated in the same way as that which is daily followed at meteorological offices in dealing with (1) the longitudes of the various stations; (2) their latitudes; and (3) the barometric height at each. After the data have been entered on a chart in their proper places, contours, known by the name of isobars, are drawn to show the lines of equal barometric pressure. In natality tables, the ages of the father and the mother take the place of the longitudes and latitudes in weather charts, and lines of similar birth rates, or as I would call them, "isogens," take the place of isobars. A chart constructed on this principle is shown in Fig. 1. The broken line A B corresponds to the instances in which both parents are of the same age. The chart is practically limited to marriages in which the wife is less than five years older, and less than seventeen years younger, than her husband.

Father's age.

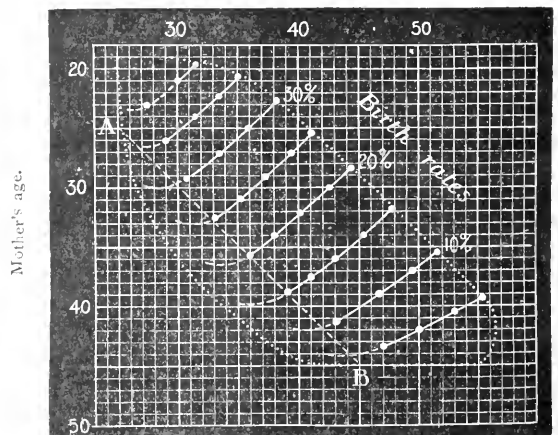

Fig. 1.

It will be noticed that the isogens run in nearly straight, diagonal, and equidistant lines across the greater part of

the chart. As a consequence of this straightness, the *sums of the ages of the parents to which each point in the straight portion of the same isogen refers is constant*. The difference between their ages is of no account whatever in eight or nine tenths of the total number of marriages; it is only when the wife is older than the husband, or when she approaches the limit of the child bearing age, that this curious law ceases to hold true.

Again, through a coincidence between the increasing age of either parent and the decrease of fertility, it happens that the sum of the three elements of (1) father's age, (2) mother's age, (3) per cental birth rate in a year has a value that is itself appropriately constant.

From this follows the curious law that if we wish to calculate the per cental birth rate per annum for a married couple within the limits of the chart where the isogens run straight and parallel, we have only to add the ages of the father and mother and subtract the total from 93 or 94, in order to obtain it with considerable precision. The approximate limits within which this law obtains are: (1) the wife is not to be older than her husband; (2) she is not to be less than twenty-three years of age, nor (3) more than forty.

*Example*.—In any large number of husbands and wives living under like conditions to the inhabitants of Budapest, whose respective ages at their nearest birthdays, to 21st June, 1892, were: that of the father, thirty-five, that of the mother, twenty-seven; then the number of children born to them during the year 1892 would be at the rate of  $93 - (35 + 27)$  per cent. = 31 per cent; the isogen makes it about 32 per cent.

**Entomological Society, March 28.**—Captain H. J. Elwes, President, in the chair.—Mr. McLachlan, F.R.S., announced the sudden death, on the 23rd inst., of Mr. J. Jenner-Weir, who joined the Society in 1845, and had been one of its most regular attendants. He also commented on the scientific attainments of the deceased, and his social qualities and virtues. Mr. Goss and Mr. Merrifield also spoke of their long friendship with the deceased, and of the respect and esteem which they entertained for him.—Mr. W. Borrer, jun., exhibited a wasp's nest which had been built in such a way as to conceal the entrance thereto and to protect the whole nest from observation. He believed the nest to be that of *Vespa vulgaris*. Mr. McLachlan and Mr. Blandford made some remarks on the subject.—Mr. G. F. Hampson exhibited a specimen of *Gaultheritis flavata*, Moore, from the Khâri Hills, and called attention to the existence in the males of this species, in the closely allied British species *Cidaria dotata*, Linn., and also in two Japanese species, of an organ on the under-side of the fore wing, which he suggested might be for stridulation; this organ consisting of a small scar of hyaline membranes situated just below the middle of vein 2, which is much curved; this scar is fringed with long hair, and has running down its middle a row of sharp spines situated on the aborted remains of vein 1, and which is curved up close to vein 2; the spines would naturally rub against part of the costa of the hind wing, but no spines or unusual roughening seems to exist on that or on any of the veins on the upper side of hind wing against which they could strike; below the scar is situated a large shallow fovea or pit in the membrane, slightly developed in *C. dotata* and *C. flavata*, but much more prominently in the two Japanese species, and, should the organ prove to be for stridulation, would probably act as a sounding board. Mr. Hampson said that in the Japanese species closely allied to *flavata*, the males have no trace of this curious organ. Prof. E. B. Poulton, F.R.S., Lord Walsingham, F.R.S., and Mr. Hampson took part in the discussion which ensued.—The Rev. T. A. Marshall communicated a paper entitled "A Monograph of the British Braconidae, part v."—Mons. Louis Péringuey communicated a paper entitled "Descriptions of new Cicindelidae from Mashanaland."—Prof. Poulton gave an account of his recent tour in the United States, and commented on the entomological and other collections contained in the American museums. Lord Walsingham, Mr. Hampson, and the President also made some remarks on the subject.

EDINBURGH.

**Royal Society, March 5.**—Prof. Sir W. Turner, Vice-President, in the chair.—Prof. Crum Brown read the first part of a paper on the division of a parallelepiped into tetrahedra. The subject of the paper was the question suggested by Lord Kelvin: In how many ways can a parallelepiped be cut into

tetrahedra without introducing new corners? In the first part the author discusses the division of the cube into tetrahedra, all the corners of the tetrahedra coinciding with the corners of the cube. Noting the corners of the cube A, B, C, D, A, B, C, D, so that A  $\bar{A}$ , &c. are body diagonals of the cube, and AB, AC, AD, &c. face diagonals, and therefore AB, &c. edges, we have the following five forms of tetrahedra: ABCD, A $\bar{B}$ C $\bar{D}$ , AABC, A $\bar{A}$ BC, and AACB, and no more, for ABCD and A $\bar{A}$ BB have all four corners in one plane. These tetrahedra may be designated O,  $\Delta$ , I, L,  $\Gamma$ , respectively. O has a volume one-third of the cube, has no part of the surface of the cube, and can occur in two positions in the cube, ABCD and A $\bar{B}$ C $\bar{D}$ .  $\Delta$  has a volume one-sixth of the cube, has three faces coinciding each with half of a face of the cube, and can occur in eight positions. I has a volume one-sixth of that of the cube, has one face coinciding with half a face of the cube, and can occur in twenty-four positions. L and  $\Gamma$  are enantiomorph, each has a volume one-sixth of the cube, and each can occur in twelve positions. These give fifty-eight positions in all, which, with the twelve groupings of four corners all four in one plane, make up the seventy groups of four corners. The author then goes on to discuss the number of ways in which these tetrahedra can be built together to form a cube. These are shown to be the following:—

- 1 O and 4  $\Delta$ 's,
- 3  $\Delta$ 's and 3 I's,
- \* 2  $\Delta$ 's, 2 I's, and 2 L's,
- \* 2  $\Delta$ 's, 2 I's, 1 L, and 1  $\Gamma$ ,
- \* 2  $\Delta$ 's, 2 I's, and 2  $\Gamma$ 's,
- 1  $\Delta$ , 1 I, 3 L's, and 1  $\Gamma$ ,
- 1  $\Delta$ , 1 I, 2 L's, and 2  $\Gamma$ 's,
- 1  $\Delta$ , 1 I, 1 L, and 3  $\Gamma$ 's,
- 4 L's and 2  $\Gamma$ 's,
- 3 L's and 3  $\Gamma$ 's,
- 2 L's, and 4  $\Gamma$ 's.

Of these the three marked \* correspond to two different arrangements each, in one of which the plane separating an I from a  $\Delta$  are parallel, in the other inclined to one another. There are therefore fourteen distinct ways in which a cube can be cut into tetrahedra without making new corners.—Prof. Cossar Ewart read a paper on the second and fourth digits of the horse, their development and subsequent degeneration. He referred to cases in which two or even three digits had been recorded. In some cases the presence of such digits is due to subdivision of the normal middle digit, in others it is due to the restoration of those digits which are always found in the fossil horse. Prof. Ewart argues that the terminal "buttons" or tubercles of the splint bones of the horse are vestiges of the lost second or fourth digits. He gives a description of the condition of the digits in embryos of different ages. In embryos under 1 inch in length no evidence was found of the phalanges of the second or fourth digits, but in a slightly larger embryo a rudiment of the second finger, connected by a complete joint to the second metacarpal, could be made out. The second and fourth phalanges attained their greatest development in embryos about 14 inches in length. The second finger then showed a terminal phalanx and an indistinct second phalanx connected to a large first phalanx which was joined by a very complete joint to its metacarpal. The apex of the terminal phalanx was surrounded by a cap corresponding possibly to one of the deeper layers of the normal hoof. In older embryos the joints were never so complete, the second and third joints rapidly disappearing, so that the second and fourth toes of all the limbs consisted of an elongated piece of cartilage connected by more or less distinct joints to the metacarpals. In still older embryos the fused phalanges are ossified and are firmly connected to the splints so as to form the well-known "buttons."

March 19.—Prof. Geikie, Vice-President, in the chair.—Prof. Crum Brown communicated the second part of his paper on the division of a parallelepiped into tetrahedra. He showed that there are 150 distinct ways in which this may be done without introducing a new corner.—A paper, by Mr. Gregg Wilson, on the reproduction of the edible crab, was communicated.—Mr. C. A. Stevenson read a paper on telegraphic communication by induction by means of coils. Such communication has been found possible when two circular coils of 200 yards diameter were placed horizontally at a distance of one quarter of a mile apart.

DUBLIN.

Royal Dublin Society, March 21, 1894.—Sir Howard Grubb, F.R.S., in the chair.—Prof. G. F. Fitzgerald, F.R.S., and Dr. J. Joly, F.R.S., read a paper on a method of determining the ratio of the specific heats of gases.—Dr. J. Alfred Scott described a method for colouring lantern-slides for scientific diagrams and other purposes. The author explained that the gelatine surface should be soaked and then drained. In this damp condition the aniline dyes may be applied in watery solutions with a brush; the depth of colour depending on the strength of the solution and the length of time it is allowed to act on any one spot. The colours most suitable were found to be eosin, tartrazine yellow, vesuvin, indigo-carmin. These colours can be mixed without forming new chemical bodies of a different colour, and spread very evenly. Eosin is, however, liable to fade, if very pale; it should therefore be painted rather more intensely if the slide is intended to be often in the lantern. Coloured inks suitable for writing with a pen on plain, cleaned glass, can be made by thickening solutions of aniline with ten per cent. of dextrine; good colour for this purpose being eosin, and iodine green. A good, nearly black, colour may be made from writing ink, "encre noire," made slightly alkaline with ammonia, and thickened with ten per cent. dextrine.—Prof. Arthur A. Rambaut read a paper on the great meteor of February 8. This remarkable object was seen at a great many places, from Whitby in the north to London in the south, and from Ballinasloe, co. Galway, to Chelmsford. To have been so widely conspicuous within a few minutes of noon in bright sunshine, the meteor must have been one of very unusual dimensions. The time of the occurrence was 28 mins. after noon (Greenwich mean time). As seen from Dunsink the meteor fell vertically from an altitude of 25° to within 5° of the horizon at an azimuth of 10° N. of E. A large number of accounts from different parts of the country reached Prof. Rambaut, from which he concludes that it was first seen at a height of 59.4 ± 4.1 miles, in longitude 2° 54' W. and latitude 53° 40' N., and was last seen at a height of fourteen miles in longitude 1° 35' W., and latitude 53° 35' N. The duration and consequently the velocity is very variously estimated, but the mean of the best estimates gives a velocity of about nineteen miles per second. The path was very distinctly curved; and therefore the radiant is very doubtful. No account of anything unusual, in the way of a fall of meteoric stones or iron, is forthcoming, and the meteor seems to have been wholly dissipated in mid-air.—Prof. Johnson exhibited the sporangia of *Litosiphon laminarie*, Harv., by means of the Society's lantern.

PARIS.

Academy of Sciences, April 2.—M. Lœwy in the chair. The decease of M. Brown-Séquard was announced by M. Troost.—Observations of the new comet Denning (1894, March 26), by M. O. Callandreaux.—Observations of the planet 1894 AZ (Courtis, March 5) and Denning's comet, made with the great equatorial at Bordeaux observatory, by MM. G. Rayet and L. Picart.—Observations of the same comet, made at Paris observatory, by M. G. Bgourdan. In the remarks on this comet, it is noted that the tail points (March 27) in a direction apparently perpendicular to the line joining the comet and the sun.—Observations of the same comet, made at Toulouse observatory (Brunner equatorial), by MM. E. Cosserat and F. Rossard.—Parabolic elements of the same comet, by M. L. Schulhof.—On the movement of a system of variable form, by M. L. Picart.—On the first differential projective invariant of rectilinear congruences, by M. Emile Waelsch.—Distribution of deformations in metals submitted to strains, by M. L. Hartmann. New experiments give the same laws for the effects of percussion as were found for the distribution of deformations produced under the application of a static strain.—Action of water on bicalcic phosphate, by MM. A. Joly and E. Sorel. By boiling with successive quantities of water the tricalcic phosphate,  $\text{Ca}_3\text{P}_2\text{O}_8$ ,  $\frac{1}{2}\text{H}_2\text{O}$ , is produced. With a single quantity of water and long contact at the boiling point, a further action produces anhydrous bicalcic phosphate.—On the blue coloration which leuco-auramine assumes in contact with acids, by M. A. Rosenstiehl.—On the fixation of iodine by starch, by M. E. G. Rouvier.—The disease "Toile," produced by *Botrytis cinerea*, by MM. Prillieux and Delacroix.—On the spark spectra of some minerals, by M. A. de Gramont.

A large number of oxides, arsenides, antimonides, sulpharsenides, and sulphantimonides are given, together with crocoisite, anglesite, and a few others.

BOOKS, PAMPHLETS, and SERIALS RECEIVED.

BOOKS.—Man and Woman: H. Ellis (W. Scott).—A Manual of Microchemical Analysis: Prof. H. Behrens (Macmillan).—A Text-Book of Field Geology: W. H. Penning, 2nd edition (Baillière).—Oodorographia, 2nd series: J. C. Sauer (Gurney).—An Introduction to Structural Botany: Dr. D. H. Scott (Black).—Observations Intérieures: Polaires, 1832-83: Expédition Danoise, observations faites à Godthaab: A. F. W. Paulsen (Copenhagen).—The Ex-Meridian: H. B. Goodwin (Philip).—The Country Month by Month, April: J. A. Owen and Prof. Boulger (Bliss).—Handbook of Tasmania, 1893: R. M. Johnston (Hobart).—Magnetic and Meteorological Observations made at the Government Observatory, Bombay, 1891-92 (Bombay).  
PAMPHLETS.—Report for 1893 on the Lancashire Sea-Fisheries Laboratory at University College, Liverpool: Prof. Herdman (Liverpool).—Illustrated Official Handbook to the Aquarium, &c. under the Control of the Exhibition Trustees, Melbourne (Melbourne).—What has Opium-smoking to do with Christianity? (Shanghai).—Ueber das Verhältniss des Männlichen und Weiblichen Geschlechts in der Natur: Dr. G. Klebs (Jena, Fischer).—Guide to the Exams. in Hygiene and Answers to Questions, Elementary Stage, 1886-93: W. J. Harrison (Blackie).—Guide to the Exams. in Heat and Answers to Questions, Advanced Stage, 1881-93 (Blackie).—Di un Nuovo Elettrometro Idiostatico: Prof. A. Righi (Bologna).—On the Modifications of Clouds, London, 1893: L. Howard: No. 3 of Neudrucke von Schriften und Karten über Meteorologie und Erdmagnetismus (Berlin, Asher).—Bird-Life in Arctic Norway: R. Collett, translated by A. H. Cocks (Porter).  
SERIALS.—Journal of the Royal Statistical Society, March (Stanford).—Minnesota Botanical Studies, Bulletin No. 9, Part 2 (Minn.).—Geological Magazine, April (K. Paul).—Medical Magazine, April (Southwood).—Annals of Scottish Natural History, April (Edinburgh, Douglas).—Zeitschrift für Physikalische Chemie, xiii. Band, 3 Heft (Leipzig, Engelmann).—Engineering Magazine, April (New York).—Himmel und Erde, April (Berlin).

CONTENTS.

|                                                                                                                                                    | PAGE |
|----------------------------------------------------------------------------------------------------------------------------------------------------|------|
| The Future of Civilisation. By Dr. Alfred R. Wallace, F.R.S. . . . . .                                                                             | 549  |
| Essays in Historical Chemistry. By M. M. Pattison Muir . . . . .                                                                                   | 551  |
| The Origin of Glacial Drifts. By G. A. J. C. . . . .                                                                                               | 552  |
| Our Book Shelf:—                                                                                                                                   |      |
| Schulz: "Grundzüge einer Entwicklungsgeschichte der Pflanzenwelt Mitteleuropas seit dem Ausgang der Tertiärzeit" . . . . .                         | 553  |
| Leland: "Elementary Metal Work."—J. S. G. . . . .                                                                                                  | 554  |
| Letters to the Editor:—                                                                                                                            |      |
| Earth Currents.—W. H. Preece, C.B., F.R.S. . . . .                                                                                                 | 554  |
| The Aurora of March 30.—Prof. J. Ryan . . . . .                                                                                                    | 554  |
| Crystalline Schists of Devonian Age.—Arthur R. Hunt . . . . .                                                                                      | 554  |
| William Pengelly.—J. Starkie Gardner . . . . .                                                                                                     | 555  |
| A Rejected Address.—Nubes . . . . .                                                                                                                | 555  |
| The Limbs of Lepidosiren Paradoxa. (Illustrated.) By Prof. E. Ray Lankester, F.R.S. . . . .                                                        | 555  |
| Bees and Dead Carcasses. By W. F. Kirby . . . . .                                                                                                  | 555  |
| Charles Edward Brown-Séquard . . . . .                                                                                                             | 556  |
| Professor Robertson Smith . . . . .                                                                                                                | 557  |
| Notes . . . . .                                                                                                                                    | 558  |
| Our Astronomical Column:—                                                                                                                          |      |
| Denning's Comet . . . . .                                                                                                                          | 562  |
| The Natal Observatory . . . . .                                                                                                                    | 562  |
| A New Comet . . . . .                                                                                                                              | 562  |
| The International Medical Congress: The Organisation of Science.—The Position of the State in Respect to Modern Bacteriological Research . . . . . | 563  |
| Across Central Asia . . . . .                                                                                                                      | 567  |
| Electric Traction. By E. F. Bamber . . . . .                                                                                                       | 567  |
| Educational Agricultural Experiments. (With Diagram.) . . . . .                                                                                    | 568  |
| The Influenza Epidemic in Germany in 1889-90 . . . . .                                                                                             | 569  |
| Scientific Serials . . . . .                                                                                                                       | 570  |
| Societies and Academies. (Illustrated.) . . . . .                                                                                                  | 570  |
| Books, Pamphlets, and Serials Received . . . . .                                                                                                   | 572  |



THURSDAY, APRIL 19, 1894.

## THE THEORY OF HEAT.

*The Theory of Heat.* By Thomas Preston, M.A. Pp. xvi. and 719. (London: Macmillan and Co., 1894.)

FROM the point of view of scope and comprehensiveness this work forms the most important treatise on heat that has yet been published in this country. It does not teem with new ideas or new modes of presentation, like the book bearing the same title that Maxwell contributed to a series of text-books announced as primarily intended for the instruction of artisans; nor does it appeal to the general reader in the same way as the remarkable book in which Tyndall undertook to present to him the "rudiments of a new philosophy" a generation ago. Each in its own way, both the books we have referred to far surpass the one now before us in originality and individuality. These qualities, indeed, are not specially characteristic of the present work. A systematic and comparatively complete presentation of the present state of the science of heat, both in respect of experimental methods and theoretical developments, has been what the author has striven to furnish, and in this he has attained a degree of success which makes his book one of great value, and amounts to a kind of originality. In French and German we find works dealing with the whole round of Physics (*e.g.*, Jamin and Bouty, Wüllner), in which the section devoted to Heat is planned on as comprehensive a scale and carried out in as much detail as the work before us, but hitherto no similar treatises have existed in English. Mr. Preston's book thus supplies, for the branch of which he treats, a distinct want in our scientific literature, and it may be confidently expected to contribute a good deal towards raising the culture and widening the scientific horizon of English students.

Mr. Preston deals with his subject in eight chapters, each of which is divided into sections, and these again into articles. The articles are numbered consecutively throughout for facility of reference.

Chapter i. is entitled "Preliminary Sketch," and is partly historical and partly expository. It contains some valuable and suggestive matter, specially perhaps in the section relating to energy; but on the whole it does not strike us as equally successful with the parts in which the author gets to closer quarters with his subject. He sets out with a luxuriance of language which happily makes room after a page or two to something more common-place and business-like:—

"With its return in springtime the bud breaks into blossom, and new life animates [*sic*] the vegetable kingdom. By its agency the incubation of the egg progresses, a living thing is brought into the world, and heat is still necessary to its support. Finally, to the power which man has acquired over it is due that supernatural strength which has made him superior to all other animals, and master of land and sea."

But this is only while we are getting under way: once fairly started, there is practically nothing more to fear.

Opinions may fairly differ as to the value of an historical sketch so very much in outline as that contained

in the author's first dozen pages. Our own opinion is that the value is little or nothing. It is impossible in a two-line phrase to indicate the points of view and general intellectual surroundings that gave birth to the scientific doctrines of former times. This part of the book accordingly seems defective in historical perspective and "relativity" of view. One statement, not referring to the far past, seems to call for modification or explanation:—

"The systematic study of heat, as a distinct branch of experimental science, commenced little more than half a century ago."

Such a period can hardly be made to include Black, Lavoisier, Laplace, Rumford, Leslie, Gay-Lussac, Dulong and many others whom the rest of the book shows that our author cannot have intended to overlook or under-value.

Chapter ii. deals with "Thermometry," and contains a good and full description of many of the methods that have been devised for the measurement of temperatures. The general nature of the problem of thermometry is dealt with to some extent in chapter i., but with some want of distinctness, and we do not find anywhere a clear statement that what is commonly called measuring a temperature is in reality the comparison of an *interval* of temperature with a conventionally adopted standard interval. The only problem is to find a satisfactory experimental method of making the comparison. As to this, there is again a want of definiteness. At page 17 we are told about the mercury thermometer that "we have now a perfectly definite standard of reference for all other temperatures"; but on page 115 we are told that, in consequence of differences in the glass, two mercury thermometers "generally differ, sometimes considerably, in their indications," and should therefore be "corrected by direct comparison with the standard air thermometer." Apparently, if it were practicable to construct mercurial thermometers to read accurately alike, no appeal to the air thermometer would be wanted. It is not till page 120 that we learn that—

"The ultimate standard for thermometry is, for reasons which will appear later, afforded by the use of a permanent gas, such as hydrogen or nitrogen."

Of course the reference here is to Lord Kelvin's thermodynamic correction of the gas thermometer, but the secret is not fully revealed till we get to the last section of the last chapter of the book. We may admit that, with the arrangement of matter which the author has adopted, the full discussion of this point could not well come earlier than he has placed it; but surely it would be possible, without going beyond quite elementary considerations, to show why a gas thermometer affords a more trustworthy comparison of intervals of temperature than a mercurial thermometer.

The care bestowed on the more purely descriptive parts of this chapter induce us to mention that the author does not seem to have come across M. Guillaume's recent work in the same field, or to be acquainted with the high-range mercurial thermometers now made in Germany, or the instruments made in this country by Messrs. Baly and Chorley with sodium-potassium alloy. Kopp's correction for the exposed part of the stem is also omitted:

it may not be quite accurate, but it gives in most cases a very fair approximation. The method (page 104) of cleaning the bulb and stem of mercurial thermometers, with boiling nitric acid before filling, has not yet, so far as we know, been generally adopted.

Chapter iv. deals with Calorimetry. The general notion of a quantity of heat introduced in the first chapter is here used without further discussion of what is essentially implied in it. This leaves it on a not altogether satisfactory basis. The notion as first brought in is somewhat metaphysical :

"In order to account for the sensation experienced in presence of a hot body, an active agent is postulated and the name given to this agent is heat." (p. 21.)

This is hardly the ground, or the kind of ground, on which the idea of heat as a measurable quantity rests. We need to recognise that objects which can give rise to the sensation of heat can also produce various measurable effects—can melt ice, for instance; that the power to produce these effects is communicable from one body to another; that, unless there is expenditure of some form of energy, such power when possessed by one body is exhausted in proportion as it is transferred to others; and so on.

It is much to be desired that writers on physics would make a point of following, whenever possible, the precise and carefully considered terminology adopted by Prof. Everett in "The C.G.S. System of Units." They would not then speak of *thermal capacity* and *specific heat* as though they meant the same thing.

A useful part of this chapter is a good description, with figures, of Joly's condensation-method of calorimetry.

Chapter v., extending to more than 170 pages, is devoted to "Change of State." It contains valuable discussions of the properties of bodies at and near the "critical point" and the equations by which Van der Waals and Clausius have attempted to express generally the properties of fluids in relation to pressure, volume, and temperature.

This chapter contains much valuable matter that has not previously been made so fully accessible to English students. We are, however, rather surprised not to find any reference to the experiments of Rudorff, Guthrie, Raoult and others on the effect of substances in solution on the freezing points and vapour-pressures of liquids, nor to Van t'Hoff's theoretical discussion of such results. Another even more important omission is any mention of the liquefaction by Cailletet and Pictet of what everybody used to call, and Mr. Preston still calls, the permanent gases. As a natural consequence there is no reference to the determination of the boiling points and critical points of several of these gases by Wroblewski and Olzewski.

Chapter vi. is on "Radiation." The most novel matters included in it are descriptions and figures of Prof. Langley's bolometer and Prof. Boys's radiomicrometer.

In chapter vii., on "Conduction," we must point out a very good description and discussion of Angström's method (alternate heating and cooling) of determining the conductivity of metals.

Chapter viii., on "Thermodynamics," we are inclined

to think the most valuable in the book, in the sense that it contains a specially large amount of important matter that has never before been readily accessible to English students. The section on the dynamical equivalent of heat includes the recent results of Miculescu and of Mr. E. H. Griffiths, as well as a full description of Rowland's experiments, which ought years ago to have attracted more attention in this country than they seem to have done. In the theoretical part of this chapter the author has, in the main, followed Clausius's method of presentation, but he has included admirable expositions of Massieu's Characteristic Function, of Duhem's Thermodynamic Potential, of the allied work of Gibbs, and of the last author's geometrical treatment of thermodynamic questions.

Notwithstanding omissions, some of which we have mentioned, every chapter affords evidence of care in looking up authorities and collecting material. But the value of the book as a work of reference might be a good deal increased by more numerous and more extended tables of numerical results. For some reason French books are quoted very largely, and not only for the work of Frenchmen; even Tredgold is referred to in a French translation.

If, in the course of the above notice, criticism seems to be more prominent than commendation, we should do injustice to ourselves, as well as to the author, if we did not say distinctly that, in our opinion, he has produced a very valuable and useful book which we earnestly recommend to all serious students of the subject. When an author obviously aims at a high standard, he invites a critic to adopt a similar standard. And in a short notice such as this, fault-finding necessarily occupies a disproportionate space as compared with praise: if we find fault, it is only fair to particularise, whereas praise applicable to hundreds of pages can be put into a very few words.

We ought to add that printing, paper, and wood-cuts are all excellent, and for a book of so many pages there are very few misprints. The index has one rather irritating characteristic, which, however, is by no means peculiar to this work. If we wish to know what has been done on a given subject by a particular author, we very likely find his name followed by references to ten or a dozen different pages, but without anything to show on which, if on any of them, we shall find the matter we want.

It may perhaps save some reader trouble if we point out that, on p. 202 (in "Cor. 2"),  $\lambda, \mu, \nu$  are printed instead of  $\alpha, \beta, \gamma$ , and on p. 588, the column headed "C.G.S. System" should be headed Kilogrammetres.

G. CAREY FOSTER.

#### AN EDUCATIONAL ATLAS.

*Philip's Systematic Atlas, Physical and Political, specially designed for the use of Higher Schools and Private Students.* By E. G. Ravenstein. (London: George Philip and Co., 1894.)

THE chief claim of this atlas to consideration, as indicated in the title, is the careful design and plan of construction; the order and selection of the

maps, their scale and mode of colouring being, it is stated, based on a definite system. The work is one of Philip's Geographical Series, which is edited jointly by Mr. Ravenstein, Mr. J. Scott Keltie, and Mr. Mackinder.

An admirable discussion of projections, scales, and measurement on maps with diagrams, is the most interesting part of the introductory text, and these difficult questions are handled with rare conciseness and clearness. The name of the projection and the natural scale are given for every map—a most useful innovation. An original diagram, showing the relative heights, depths, and curvature of the surface of the globe along the equator, and the parallels 30°, 45°, and 60° N. and S. gives a very striking view of the vertical relief of the earth. Ten plates are devoted to general physical geography, and although the scale is small, and the features consequently much generalised, they are clear and satisfactory. The rainfall maps on plate 5 are particularly interesting, including two which are entirely new, representing the average number of rainy days in different parts of the world, and the relative humidity of the atmosphere. Equal praise cannot be given to the maps dealing with the distribution of plant and animal life, the names on which are frequently puzzling, and the species selected for treatment curiously unequal.

The maps of continents and countries, which make up the bulk of the atlas, show configuration by a combination of contour lines and tints with hill-shading. Here we regret that Mr. Ravenstein had not courage to disregard the conventional strong green tint for the lowlands, and to adopt an unbroken system of deepening shades of brown. It is noticeable, also, that the application of the green tint is unsystematic, extending to 300 feet in some maps, to 600 in others, and in one at least to 3000 feet above sea-level. A similar break in the system of indicating density of population is sure to give rise to confusion; the same shade being used to represent regions of over 512 inhabitants to the square mile in Europe, those over 256 in Asia, over 64 in Africa, and over 32 in America. There are several minor defects visible in the maps, such as the omission of links in the through railway system, and difference in the representation of county-boundaries in the maps of England and Scotland, but these are not more frequent than in atlases of much greater pretensions, and will of course disappear in a new edition. The colour-printing of many of the maps may also be improved.

A great feature of the work is the number of inset maps, garnishing the margins of larger plates with enlargements of regions of special interest, or small-scale general maps showing geology, climate, vegetation, race, language, or density of population. In this way the fact that there are as many maps as there are sciences involving distributions is kept to the front, and the teacher or scholar using this atlas is led to see that geography is no haphazard agglomeration of disconnected details, but a shapely system incorporating and elucidating the results of all departments of nature-study. We know of no atlas in any language in which the systematic plan has been more successfully elaborated, the exceptions we have noted above being thrown into undue prominence by the general excellence of the whole.

NO. 1277, VOL. 49]

### OUR BOOK SHELF.

*Life and Rock: a Collection of Zoological and Geological Essays.* By R. Lydekker, B.A., F.G.S., &c. Knowledge Series. (London: Universal Press, 1894.)

MR. LYDEKKER'S name is well known as that of a popular exponent of the results of zoological and palæontological research. The essays which he collects under the title of "Life and Rock," and which deal with a wide range of zoological subjects, from elephants to what he terms "forams," will serve to sustain his reputation in this respect. Mr. Lydekker's chief aim is to convey information which shall not be couched in terms so technical as to discourage those who have neither the inclination nor the desire to become serious students. In this he is eminently successful. His language is simple, clear and direct, without any attempt at a distinctive style; and he shows good judgment in drawing the line beyond which his readers would not be able to follow him, nor care to make any effort to do so. Above all he is accurate, and his information may be relied on as up to date. We question, however, his wisdom of speaking in a book of this popular kind of "those writers who explain evolution by some mode of what they are pleased to call natural selection"; and of "those who put their faith in a mode of evolution dependent only upon so-called natural causes." Let us by all means have the best and most forcible available criticism on natural selection as a valid explanation of the observed facts of organic nature and on the evolution of living and extinct beings by processes which are termed natural. Such criticism is the very life of science. But the words we have italicised are mere side-thrusts, which do the reader no good, and the writer no credit.

*Disease and Race.* By Jadroo. (London: Swan Sonnenschein and Co., 1894.)

"To show some continuity in disease, to evolve a little order out of the existing chaos," these were the objects which led the author to write this book. He collects inculcable diseases, and arranges them in a genealogical table, which is suggestive, to say the least of it. Tuberculosis is shown to be descended directly from scrofula, and scrofula from syphilis, which in turn is regarded as having descended from leprosy. Other diseases are supposed to be connected in a similar manner, though the grounds upon which the supposition is based are not very firm in many cases. The chief point to which the arguments lead is that "every contagious or infectious disease, by either the formation of a hybrid, or by hereditary transmission of the individual modification, tends to eradicate itself." The author is strongly in favour of the establishment of institutes for the purpose of research into the bacteriology, etiology, epidemicsity, and sequence of diseases. As there is a dearth of human subjects upon which to experiment, he suggests that convicted murderers should be given the option of death or the probability of leading a comparatively comfortable existence in a bacteriological institute. It has been said that "the worst use you can put a man to is to hang him"; and certainly, if a murderer were used as a medium for the cultivation of bacteria, he would expiate his offence in a very suitable manner.

### LETTERS TO THE EDITOR.

[The Editor does not hold himself responsible for opinions expressed by his correspondents. Neither can he undertake to return, or to correspond with the writers of, rejected manuscripts intended for this or any other part of NATURE. A notice is taken of anonymous communications.]

#### The Mass of the Earth.

THIS month's *Philosophical Magazine* contains an interesting, instructive, and suggestive, criticism of Prof. Poynting's

Adams prize essay on "The Mean Density of the Earth," in which I have to-day read the following paragraph:—

"The author is to be congratulated on the strictly scientific title under which he describes his work—"The Determination of the Mean Density of the Earth," or "The Determination of the Constant of Gravitation," instead of the utterly unmeaning 'Determination of the Weight of the Earth,' which is found even in such a work as Arago's *Popular Astronomy*, and which is a characteristic of too much of our modern popular science *à la mode*. Have we not seen in some old and popular treatise a picture of 'the room in which Mr. Baily weighed the earth'?" It is to be hoped that some day our leading authorities will be induced to abandon that fatal dogma which is still, unfortunately, 'of great emolument'—that science, to be popular must, above all things, be inaccurate."

As comment, I remark that the earth's weight, or mass, is  $6.14 \times 10^{21}$  tons. What is unmeaning or unscientific in this clear, intelligible, and accurate statement?

Prof. Poynting's work was in fact, directly and simply, a weighing of the earth against a lead weight on the same principles, and by the same instrument, as a grocer weighs a quantity of tea against brass or iron weights, with inference calculated by aid of the additional knowledge of the earth's radius. "The determination of the constant of gravitation" is a deduction requiring, not a knowledge of the earth's radius, but the knowledge (derived from pendulum experiments) of the gain of velocity, per unit of time, which a free falling body would experience at the place of the gravitational weighings. The critic is of course quite right in applauding Prof. Poynting's double title, but he is not right in decrying the simple, clear, and scientific expressions, "weighing the earth" and "the weight of the earth."

In Cavendish's original experiment, and in Baily's repetition of it, and in Cornu's corresponding experiment with mercury instead of lead, the more immediate result is "the constant of gravitation": the weight of the earth and the earth's mean density are deductions.

The "constant of gravitation" is not a very good or logical expression, though it is not quite so bad as "coefficient of friction," or "coefficient of thermal conduction," or "coefficient of self-induction."

"Constant of gravitation" does not explain itself, either to the learned scientific mind, or to the intelligent, non-scientific, reader. K.

April 10.

#### The Royal Society.

It may interest your readers to see the kind of foundation on which rumours with regard to the Royal Society are based. The following paragraph is from the *Daily Chronicle* of April 16, and the fact is that neither the Council nor the officers have as yet met to consider the claims of the numerous candidates.

JOHN EVANS.

The Royal Society, Burlington House.

"It is reported that the list of successful candidates for admission into the Royal Society, which will be issued in a few days, is not calculated to allay the acrid criticism to which the council has of late been subjected. Far apart from its containing some very obscure names, and rejecting some much more notable ones, the official selection, if all tales are true, will exhibit more than ever the influence of that "professorial" element into whose hands the Society has been getting more and more every year. The election of Sir Henry Howorth, which few approved of, was really due to his rejection being advocated by that unpopular clique, the members at large protesting in their rather futile fashion against the nepotism of University and South Kensington officials. This year, however, the college tutor and the tripos hero is said to be more and more in favour. By the way, it is curious to find that Mr. Selous, who has contributed so many papers to the Royal Geographical Society and was one of its gold medallists, has only now cared to be elected a Fellow. But neither Nansen nor Hector, who shared in the same distinction, are enrolled in the Society's membership. One would imagine that a medallist ought to be an honorary Fellow, more especially as some very peculiar people appear *dans cette galère*."

NO. 1277, VOL. 49]

#### *Lepidosiren paradoxa*.

THE villi of the pelvic fins of this fish, referred to by Prof. Lankester in the last issue of *NATURE*, have been already briefly described by Prof. Ehlers (*Nachr. Kais. Gesellsch. der Wiss. Göttingen*, 1894, No. 2), as was shown by Dr. Günther in commenting upon them before the Zoological Society on the 3rd inst. Dr. Günther advanced good reason for regarding the villi as sexual and confined to the male, as is implied in Prof. Lankester's letter. A specimen of a fine male has recently come into my hands, in which, in contradistinction to all others yet described in print, the "anus" (cloacal aperture) is located to the right of the median ventral fin; and it is thus proved that *Lepidosiren*, like *Protopterus*, is individually variable in the inter-relationship of these two parts of its body. Being aware that Brock had recently described the histological structure of dendritic processes occurring in the neighbourhood of the genital orifice, in the male of *Plotosus (Cepidoglanis) anguillarlis* and in the two sexes of *Gasterotokeus biaculeatus*, I requested my pupil Mr. J. Sumner to make sections of those of *Lepidosiren*, hoping that erectile tissue and tactile organs, such as Brock describes, might have been present. We can find neither. The villi are highly vascular and non-muscular. Dr. Bohl's, who captured the specimens that have lately reached Europe, has signified his intention of working out these structures in full; and it is fair to him to assume that he is in possession of material specially prepared for the purpose.

My specimen is further remarkable for an inequality in growth of the pelvic fins—that of the (right) side on which the cloacal aperture occurs exceeding its fellow in length by a quarter of an inch; and, in view of Prof. Lankester's assertion that the forward position of the pelvic fin is one "which the animal can give it in life," the fact that the right pectoral is in my specimen forwardly thrust into the branchial chamber may not be without interest.

No one can doubt the generic distinction of *Lepidosiren* and *Protopterus*; indeed, the late Dr. Anton Schneider fully established this, in reply to Ayers' proposal to regard them as mere varieties of a common species. And it may be incidentally remarked that prior to the acquisition of Dr. Bohl's specimens, authoritative records of six museum preserved examples were established (*cf. NATURE*, vol. xxxviii. p. 126).

G. B. HOWES.

Royal College of Science, April 16.

#### The Aurora of March 30.

ON the night of March 30 there occurred here an exceptionally brilliant auroral display, remarkable, in this latitude, in several respects. When I saw it I was a few miles north of the city proper, and the southern horizon was lit up by the lights in town, so that any faint display near the horizon to the south would have been obscured. I first noticed the aurora about 8.30 p.m. (75th meridian east of Greenwich time), and it continued till midnight, but was much fainter and confined to a simple glow in the north-west to north-east after about ten o'clock. When first noticed, the sky from east to west round by north was either quite deep red or reddish white. No clouds were then visible, and there were no streamers, though the glow extended about to the zenith. Then, as the red grew fainter, a few small clouds formed in the north, and the *still* glow was confined to the sky from east to west along the horizon, and about 50° above it in the north, but less in the east and west. From this arch of light, streamers shot up, not only from the north but from east and west (or east by south and west by south), and met in a place about 10° south of the zenith. These streamers pulsated rapidly, the light at times starting at the arch of (apparently) still glow and travelling without break to the point of meeting. At other times the glow would appear in places along the course of the former streamers—first near the arch, then further on, disappearing again, to again appear nearer the zenith. When these rays met in the place south of the zenith, their paths sometimes crossed, but more generally the rays seemed to mingle and either form a roundish glowing spot about 5° to 10° across, or a roundish, confused mass of glow that looked like glowing smoke. Occasionally an appearance like a hollow-centred whirlpool appeared. When the rays met

without mingling, one ray seemed to cut another off abruptly, only one ray ever appearing to pass the point of meeting. About nine o'clock, rays could be faintly seen in the south extending up to the point of meeting. Then these rays grew brighter, extending from about 30° above the southern horizon, and *throbbing* up from there to the place near the zenith where the northern, eastern, and western rays met. The southern rays were fainter than the others. They may have extended further towards the horizon than 30° above it, but, if they did, the lower part of them was too faint to be seen, on account of the city lights. I have never before seen or heard of an aurora in this latitude, with rays coming upwards from the south. The whole display seems to have been much farther south than usual. It was also much brighter than is usually seen here, even on exceptional occasions.

Finally, a mass of cloud about 12° long and 5° to 7° wide, foamed in the north and drifted very slowly away to the eastward. During the aurora the *relative* humidity seemed to increase, and it grew quite misty. This I have noticed during every exceptionally brilliant auroral display that I have seen. The mass of cloud mentioned above was about 40° above the horizon. No other cloud formed as high as this, though a few very small ones appeared in the north-west to north-east, from 20° to 30° above the horizon. F. R. WELSH.

Philadelphia, U.S.A., April 2.

### Fireball.

ON Wednesday, April 11, a somewhat sudden and heavy thunderstorm passed over the Dunstable and Luton district. The lightning, which was close overhead, killed several cows, and did other damage. The storm was ushered in by banks of lurid coppery and dark grey clouds from the south-west. When the storm was at its heaviest, bright blue sky could be seen towards the north-east.

Whilst watching the incessant forked lightning in the east at 2.30 p.m., I suddenly saw a broad spout of fire drop almost vertically from the clouds to the earth. The band of fire was not at all like lightning, as it was ten or twenty times as broad, and formed a continuous, slightly curved line, without the slightest trace of zig-zag. It was like a large ball of ribbon being quickly unrolled, one end being retained in the clouds. The fall was less rapid than lightning, and was accompanied by a dazzling light. It was immediately preceded and followed by the crash of thunder, but the thunder was at the time continuous.

The fall appeared to be close by, and I soon after learned that a "fireball" had descended on the Dunstable side of Luton, near Dallow Farm, about four miles from here. On visiting the spot, and questioning two or three eye-witnesses of the fall, I was told that the "thunderbolt" was seen as a large "ball of fire," that the fall was accompanied by a loud rushing sound and a dazzling intense light.

The fire descended close to a well, and on to the roof of a small wooden barn or shed packed with firewood, garden tools, and potatoes. The roof was of red pantiles, and the contact of the fire instantly smashed every tile to atoms, and broke up and suddenly lighted the barn, so that every part, with the contents, was totally destroyed. The men on the spot said the sound of the impact on the tiles was so loud that they thought all the cottages near by had had their roofs smashed in. Other barns and sheds near by were visibly shaken.

Immediately before the descent a workman was inside the barn taking shelter from the storm, but being frightened at the unusual violence of the tempest, he put a sack over his shoulders and walked into the open; as soon as he had done so, the ball of fire fell on to the shed or barn, with the result described.

Dunstable, April 15. WORTHINGTON G. SMITH.

### Micro-Organisms and Fermentation.

IN your issue dated April 5, in a review of Jørgensen's "Micro-Organisms and Fermentation," occurs the following:—"In England, however, we are slow in applying scientific research to industrial pursuits, and though a number of brewers already use Hansen's system, it can hardly be said that it has

received the attention it deserves, and chance, tradition, and blind empiricism still govern too much the manufacture of beer in England."

Strange to say, on the same evening a large number of brewers and scientific workers were gathered together at the Hotel Métropole to do honour to an English brewer, who has also made his name known widely in the scientific world—Mr. Horace T. Brown, F.R.S., &c., and the following quotations from a report of the meeting, which I herewith enclose, appear somewhat opposed to the statement above quoted:—

"It is the boast of Englishmen that although behind some other nations in the application of science to many branches of manufacture, in regard to that of malt and beer they rank second to none." Again, to quote Mr. Brown:—"The two really great foundation stones of modern scientific brewing undoubtedly are the vitalistic views of fermentation initiated by Pasteur and the important discoveries of our distinguished countryman, Cornelius O'Sullivan—discoveries which first enabled us to explain the complex chemical changes of the mashing process."

If such firms as Messrs. Bass and Co., Allsopp and Sons, and Wm. Younger and Co., with their regular staff of scientifically trained brewers and skilled analysts, can be accused of "blind empiricism," even though they do not use Hansen's system, the term must have a new meaning.

Speaking from a knowledge of breweries in various parts of the kingdom, one can affirm that there is almost a general desire to hear the latest scientific suggestions for practical brewing, and a marked willingness to adopt methods that can be shown to be practically advantageous; and Mr. Kanthack must, I think, be labouring under a total misapprehension of the English brewers' attitude with regard to the science of brewing.

On the other hand, the natural caution of English and Scotch manufacturers, which has largely assisted in making our country the commercial head of the world, prevents them adopting the innumerable scientific suggestions which have not as yet been demonstrated to be practical improvements as regards the English process of brewing. FRANK E. LOTT.

Burton-upon-Trent.

### The North-East Wind.—Devonian Schists.

ABSENCES from London and pressure of work in the intervals have thrown me back in reading NATURE; hence my delay in replying to Mr. Burbury's criticism.

I have not made a special study of meteorology, and have had to follow authorities, such as Scott, Abercrombie, and Hann, but I believe my statements about the coldness of our spring east winds accord generally with what they say. There is a tendency, according to the first, for the air to flow from land to sea in winter time, and from sea to land in summer; and an anticyclone, according to the last, usually extends in the winter over north-eastern Europe and the adjacent region of Asia, and a cyclonic area over the northern Atlantic. The latter appears, to move somewhat northward about or after the vernal equinox, and to cause a more steady draught westward from the other area. It must be remembered that the maximum of cold lags after midwinter, and that the exceptional conditions of our island—such as the frequent winter "bombardment" by smaller and deeper cyclones, interferes with the regular development of a winter east wind, such as my friend suggests. Still, I speak with all submission, remembering the saying *ne sutor ultra*.

It may save time to add that I have observed how a remark of mine has again stirred up Mr. A. R. Hunt in defence of Devonian schists. In regard to his letter, I content myself with repeating what I have already said: viz., that either I have wasted a good many years in study bearing on this question, both in the field and with the microscope, or his "evidence" is of little value, and his knives of the wrong temper for the dissection which he has essayed. He will not succeed in drawing me into a controversy with him on this question. Life is short. T. G. BONNEY.

### Are Birds on the Wing Killed by Lightning?

A LADY was looking out of the window when a flash of lightning occurred, accompanied simultaneously by a clap of thunder without reverberation. Immediately afterwards she

observed a dead gull, lying in a grass field in front of the window, which, she is convinced, was not there before.

Those who picked the bird up report it as still warm, and it is said that it smelt villainously of "brimstone." I should like to know whether a bird *not perched* can be killed by lightning, and, if so, whether instances are common.

SKELFO.

#### The Early Return of Birds.

THE remarkably early appearance of some of our migratory birds this season is worthy of note. On Wednesday, April 4, while crossing some fields south of Ashtead Station, a solitary chimney swallow (*Hirundo rustica*) passed close to me, flying near to the ground.

On the following Saturday (7th inst.), when strolling through the woods on the Common, I heard two cuckoos, getting quite near to prevent mistake. They have been heard in the neighbourhood each day since.

ROBERT M. PRIDEAUX.

Ashtead, Surrey.

#### The Foundations of Dynamics.

IF no one else cares to raise the question, may I ask Mr. Bassett how he fixes the foundations of his dynamics, viz., the axes of reference to which the positions and velocities of his particles are referred? There are other questions, of more or less metaphysical interest (such as the nature of "Force"), which his paper does not touch; but this one is of importance to the most practical view of the subject; and only an elementary text-book for schoolboys can afford to beg it, while treating of the Foundations of Dynamics.

EDWARD T. DIXON.

Cambridge, April 13.

#### THE ELEVENTH INTERNATIONAL MEDICAL CONGRESS.

LAST autumn, when the public health of Europe was in an unsatisfactory condition, it was thought that it would be wise to postpone the Medical Congress until this spring, though it was feared by everyone that such a determination would be fatal to the efforts of the Congress. The votes of the majority and of the most influential members of the Executive Committee, however, impressed upon Prof. Baccelli the necessity of postponement. It was also thought that the visitors would prefer to enjoy the attractions of the city in the spring rather than in the autumn. No one in Rome expected such a numerous concourse of savants, doctors, and others, as assembled on this occasion. At such an extraordinary meeting we must not only consider the characteristic note of the congress and the certainty of its success, but also ascertain the causes of various inconveniences which members of the congress have had to submit to, and of which complaint has been made.

The object of a congress is to afford an opportunity to its members to make new personal acquaintances and to renew old ones with the view of exchanging ideas between men who live at great distances from each other, and to ventilate their arguments.

A congress provides also a means of estimating the scientific condition of a country, which it is impossible to do through correspondence or through the public press.

The ordinary channel of particularity was abandoned at the Congress, and it will have been seen from the speeches that more general and comprehensive ideas were evolved than is possible through ordinary scientific literature.

Considered in this sense, the Congress at Rome has been a great success, and it has been easy to see that visitors have a growing sense of admiration for medical science in Italy, and especially for the younger branches

of the profession. Italy, however, has been regarded from other points of view. Its reputation led many persons to expect a spectacle of misery, but they, on the contrary, have been agreeably surprised at the enlightened aspect, comforts, and welfare of the land. This has shown visitors that they had formed a wrong impression, and the critical condition has proved only a temporary difficulty; for the original foundation still exists unchanged.

The best proofs of scientific progress were seen while travelling through the Mont Cenis Tunnel and visiting Turin. Passengers found there many large edifices destined shortly to be utilised as scientific institutions.

Only one of the four blocks is entirely finished and one almost furnished. On one side is the Department of General Pathology (Prof. Bizzozero), and that of Experimental Pharmacy in Medicine (Prof. Giacosa). On the other side, Physiology (Prof. Mosso).

Prof. Mosso has distributed to his colleagues of the section of physiology a pamphlet containing the description and drawings of his institute. Everyone has admired the beauty of the new laboratory. The University of Turin is the second in rank in Italy for the number of students it will accommodate.

The Congress was divided into several sections. The conferences were held in the central part of Rome, in a building very badly selected, but which had the advantage of being near the building where the International Exhibition was held. The meetings of the sections were held in the Policlinic buildings, outside of the Porta Pia, at a convenient distance from the centre of the town, but in a quarter very difficult of access.

The Policlinic is a very large institute, built by Prof. Baccelli. It is not yet finished, a small portion only being complete. The essential and historical elements of the eternal city are equally represented in this institute, which has evidently been built regardless of cost in its external appearance and its maintenance hereafter. The Policlinic was built for the accommodation of the clinics. It is arranged not only for the welfare of the sick, but also in the interests of students.

It is interesting to note that the man who has built two edifices for the clinics in the Policlinic has totally overlooked the tuition. The complete buildings are five in number, connected by a passage which in the future will be turned into a portico.

The central building, which is also the largest, has a large marble staircase, which called forth the admiration of more than one of the congressists; it contained the offices of the presidency, secretary, and accommodation for the press, post, and strangers' committee.

The meetings were held from the 30th March to the 5th of April, from 9 a.m. until 3 p.m. At 4 in the afternoon addresses were given, which constituted a most interesting part of the programme. Among these addresses we must mention those of Prof. Virchow, of Bizzozero, growth and regeneration in the organism; Cajal, morphology of nervous cells; Danilewsky, protoplasm and its modifications by life; Foster, the organisation of science. Other addresses were given by Profs. Brouardel, Babes, Nothnagel, Laache, Kocher, Jacoby, and Stockvis.

In some sections the debates were carried on with difficulty. The most rational method has not been always observed, many meetings therefore have left a certain impression of confusion. Certainly for a future congress it will be necessary to make some definite rule on the matter; that is to say, to indicate the special theme and argument, which will conduct the discussion in a more useful manner between competent men, who are always to be found in such a congress. It is a cause of complaint that in such an assembly those who wished

to speak on the arguments and questions interesting to science have been obliged to keep silence, and interesting debates, which would have lost nothing by insertion in the public press, did not take place.

A very good example was given by the Section of General Pathology, one day being dedicated to the discussion of cancer. On this day, many ideas were exchanged between the partisans and adversaries of the parasitical theory of this disease. Prof. Foà (Turin) gave his experiences, which led him to admit the existence of the parasite in cancer, and to his observations M. Cornil and many others replied. Nothing leads more to new researches and helps towards the discovery of the truth than such discussions.

In the Pharmacy Section, Stokvis (whose address we print elsewhere), Lauder Brunton, Fraser, and in the Italian ranks, Colasanti, Fubini, Gaglio, Giacosa, Mosso, and others have made some very interesting suggestions. In the same section, on the proposition of Prof. Giacosa, an order of the day was voted, asserting that the study of the alterations produced in the living body through the absorption of chemical substances constitutes a branch of biological science, having a definite aim, and that it is necessary to give to pharmacological laboratories grants equal to those of physiology and pathology. Many Italian universities have pharmacological laboratories insufficiently equipped, and in many countries pharmacology is taught only as a subsidiary question to therapeutics, which is not a science, but a rational application, and very often empirical.

Physiologists occupied themselves, naturally, with the questions interesting the cerebral function. Prof. Mosso, who brought with him many instruments and animals to serve at his demonstration, showed some of them for the purpose of taking the measurement of the pressure of the blood on the pulse of the patient. The questions of the temperature of the organs were also discussed.

In Surgery many very animated and useful discussions took place.

The principal question which has been discussed was the cure of hernia, ascertaining the large tendency to adopt in every case the most painful process of operation. Jean and Lucas took up the question in opposition to Paci. The surgery of the nervous system was discussed by MacEwan; while D'Antona, of Naples, spoke on the cause of the functional disturbances which follow bone diseases. On this subject a very interesting suggestion was made by Ollier, who is an authority upon it.

Tuberculosis and pneumonia and their therapeutics, and subjects relative to anæmia, with the transfusion of the ferruginous preparations or with organic substances, and malaria, were also the subject of some discussion.

The sudden death of Brown-Séquard was the subject of solemn commemoration in the Medical Section (Prof. Cardarelli) and in the Physiological Section (Prof. Richet).

Altogether the debates raised 2700 questions, and if some were not settled, many others were adjourned which were not included in the orders of the day.

The Medical Exhibition, arranged by Prof. Pagliani, was one of the most complete ever witnessed, and without doubt the most interesting and original part was that relating to the history of medicine by the exhibition of fragments of anatomic models of the Roman epoch; of Egyptian, Greek, Roman surgical instruments of the earliest date; by the illuminated manuscript and by the Greek, Roman, and Arabic classical authors relative to the first works on surgery; by the diplomas and the cards of the old universities; by the manuscripts, pocket-books, drawings of the celebrated anatomists and physiologists of the sixteenth, seventeenth, and eighteenth centuries. All these documents, extracted from the

archives of libraries and museums, were shown to a public competent to appreciate them.

It would be unfortunate if all those riches were dispersed again, and with the view of keeping them together, the Pathological section of the Congress has invited the Minister of Public Instruction to compile a catalogue.

It would be difficult to assert that every one was pleased with the fêtes; but even if the organisation of all the services was not the acme of perfection, there was the beautiful and grand city, its animated streets, its incomparable monuments, its enchanting landscape, and specially its sun. It rained one day, but with the return of the sun the visitors found themselves in the royal garden of the Quirinal, dominant over the town, and with the eternal lines of the landscape coloured by the setting sun. We must mention also the lunch at the Thermal Baths of Caracalla. It is very difficult to say whether the food and drink were distributed equally among the guests, and if some people went away hungry while others went away with their handkerchief full; but I am sure no one will ever forget those grandeurs and immense drawing-rooms, those splendid tables around which thousands of people were delighted, those quiet corners under the shadow of the trees, the bands, and especially the heavens, so beautiful that it caused one cold Teuton to dance on the old mosaic floor of the Imperial Bath.

PIERO GIACOSA.

#### THE ROYAL METEOROLOGICAL SOCIETY'S EXHIBITION.

THE Royal Meteorological Society's fourteenth exhibition of instruments was opened on Tuesday, the 10th instant, in the rooms of the Institution of Civil Engineers, Great George Street, Westminster. Each annual exhibition has been devoted to the illustration of some branch of meteorology, the object being to show the progress that has been made in each particular department. The subject chosen for the present exhibition is "Clouds: their Representation and Measurement." From this title it will be readily understood that this is largely a pictorial exhibition, although it includes a considerable number of instruments.

Luke Howard, F.R.S., was practically the first person to carefully study the clouds and to classify them; and in 1803 he published a memoir "On the Modifications of Clouds, &c.," setting forth his classification, which is that in general use at the present time. A fine crayon portrait of Howard occupies a prominent place in the exhibition, as well as two original sketches by him showing clouds gathering for a thunderstorm, and also the commencement of a stratus. The first and third editions of Howard's memoir are shown, while alongside of them is a reprint of the first edition, with facsimiles of the plates, which has just been published under the direction of Dr. Hellmann, of Berlin.

Since Howard's time many attempts have been made to amend or improve his classification of clouds; most of the various nomenclatures which have been proposed are illustrated in the exhibition, such as those recommended by Admiral FitzRoy, M. A. Poey, Rev. W. Clement Ley, Dr. H. H. Hildebrandsson, and the Hon. Ralph Abercromby.

A most interesting and valuable collection of photographs, showing the various forms and modifications of clouds, is arranged around the walls of the rooms. Among the photographs of cirrus and cirro-cumulus, the highest forms of clouds, are specimens taken by M. P. Garnier, at Boulogne-sur-Seine; by M. A. Angot, at Paris; by Prof. A. Riggenbach, at the Sântis Observatory, Switzerland; and by Signor Mannucci, at the

Vatican Observatory, Rome. Mr. A. W. Clayden exhibits a number of enlargements of cloud photographs taken by reflection from a black glass mirror, and he also shows the camera by which they were obtained. The mirror is placed in front of the lens so that the plane of the mirror makes an angle of about  $33^\circ$  with the axis of the lens. The mirror extinguishes the polarised light, and so causes the image of the cloud to stand out brightly on a dark background. Mr. Birt Acres contributes some fine specimens of cloud photography, as also do Dr. F. G. Smart, Dr. A. Sprung, Colonel H. M. Saunders, and Captain D. Wilson-Barker.

Some interesting photographs of several remarkable clouds are exhibited. Two of these show the "festooned cumulus" (or pocky cloud) that formed part of a storm-cloud which passed over Sydney, New South Wales, on January 18, 1893. Mr. H. C. Russell, F.R.S., exhibits two photographs illustrating the "southerly burster" (which is a violent inrush of Polar wind) at Sydney on November 13, 1893. The first was taken at 6 p.m., and shows the clouds preceding the "burster." In the second, which was taken an hour later, the "roll cloud" had come near enough for its peculiar character to be distinctly seen, and the evident rolling up of the cloud is very well shown, as well as the light rain squall which sometimes accompanies these winds. Three photographs of tornado clouds are exhibited, in two of which the cloud funnel was twelve miles distant, and in the third the spiral-shaped funnel is seen trailing at a considerable altitude in the air.

A collection of pictorial illustrations of clouds, from various meteorological works, is also set out in the exhibition. The earliest of these is a plate showing the method of measuring the height of clouds, by means of two theodolites, from J. F. Glöckner's *De Pondere Nubium*, 1722.

The instruments used for observing the direction of motion of the clouds are called "nephoscopes"; and of these there are several specimens in the exhibition, amongst them being those devised by Mr. Goddard, Herr Fineman, General R. Strachey, F.R.S., and Mr. F. Galton, F.R.S. These consist of circular mirrors with radial or parallel lines marked on them, the points of the compass being engraved on the outside of the frames. The direction of motion of a cloud is ascertained by turning the mirror on its axis until the image of the cloud passes along one of the lines. Photo-nephographs, designed by Captain Abney, F.R.S., and by MM. Teisserenc de Bort and G. Raymond, are also exhibited; as well as a model showing the manner in which the pair of photo-nephographs are mounted for use at the Kew Observatory, and the apparatus designed by the late Mr. G. M. Whipple for ascertaining the height, direction, and rate of motion of clouds from the photographs. In this case simultaneous photographs of a cloud are taken by two cameras half a mile apart, and fixed in such a way that their optical axes point to the zenith. The dark slides of the cameras carry a pair of fiducial lines at right angles to each other, and adjusted so that one of the lines shall be parallel to the measured base, and these lines are reproduced upon the cloud photographs. The two negatives are super-imposed in the sliding frames of the apparatus, which are then moved till the images of the cloud exactly coincide, when the parallax is given by a line joining the intersections of the fiducial lines. The parallax having been measured by a pair of compasses, the height of the cloud is at once determined by means of a prepared curve. A similar operation is then performed with one of the same negatives, and a second taken in the same camera after the lapse of one or more minutes. The pictures having been made to coincide as before, the distance between the intersections of the fiducial lines indicates the drift of the cloud. The direction

of the drift is indicated by the position of the line joining the two intersections relatively to the fiducial line parallel to the base. The velocity of the drift, or the rate of motion of the cloud, is found graphically by means of a prepared diagram. Mr. R. Inwards exhibits a simple appliance for estimating the height of clouds of the roll-cumulus type by means of their perspective effect.

The exhibition includes a number of instruments invented or first constructed since the previous exhibition. Mr. R. W. Munro shows a very fine specimen of Dines' recording pressure-tube anemometer, as well as two other patterns of Dines' pressure and velocity gauge for use with the tube anemometer. Mr. J. J. Hicks exhibits Bartrum's open scale barometer, Callendar's compensating open scale barometer, Keating's hydrometer, and some useful and pretty circular levels with the fluid hermetically sealed. Mr. L. P. Casella shows Goad's geodetic altazimuth, a universal sun-dial, some artificial horizons, an alarm thermometer by MM. Richard Frères, and a hypsometer or boiling-point thermometer. Mr. H. Hainsby, a shoemaker at Shanklin, exhibits three ingenious instruments which he has himself devised and constructed. These are an inverted tube-hygrometer, a vapour condenser, and a compensating siphon evaporator for large water surfaces. Mr. H. N. Dickson shows a model of his bottle for collecting samples of sea water from moderate depths, and Dr. W. G. Black shows his louvered glass evaporator.

A number of sketches and photographs of meteorological phenomena are also exhibited, as well as photographs and diagrams of instruments.

A special feature of the exhibition is the large and interesting collection of lantern slides, nearly 300 in number, and mostly of cloud subjects.

WM. MARRIOTT.

#### NOTES.

THE next meeting of the American Association for the Advancement of Science will be held in August, at Brooklyn. The mayor of that city has just appointed a large and influential local committee to make arrangements for the meeting.

THE fine weather of the past few weeks has enabled General Pitt-Rivers, F.R.S., to resume his excavations at Wor-Barrow, a large twin-barrow near Woodyates, on the borders of Dorset and Wilts. An extensive section has been cut through the tumulus, and quite recently the work of the investigator was rewarded by the discovery on the *old surface line* of two human skeletons. Anthropologists will await with interest the results which may be deduced from the examination and measurement of these remains, and their relation to those already made by General Pitt-Rivers in the round barrows, and in the Romano-British settlements explored in the immediate neighbourhood.

THE Royal Commissioners appointed "to inquire and report what light-houses and light-vessels it is desirable to connect with the telegraphic system of the United Kingdom by electrical communication, for the purpose of giving information of vessels in distress or casualties at sea to places from which assistance could be sent, and of transmitting storm warnings," have presented their second report. Although the general question of signalling was not referred to the Commissioners, it is so intimately connected with the subject of electrical communication that they have considered it, and in the first report they stated that in cases "where the distance from the shore is not great, an improved system of distress-signals (distinct from the usual fog-signals) might, both at rock-stations and on light-vessels, prove an effective temporary substitute for the more costly expedient of electrical communication." This view has



been confirmed by the experience gained during the last tour of inspection. The Commission therefore recommends that the general light house authorities be invited to consider the subject with the view of instituting a universal system of visual and sound signals at all the various light stations on the coasts of Great Britain and Ireland. Appended to these recommendations is a report by Sir Edward Birkbeck on the system of coast communication in Canada and the United States, from which it appears that while both these countries possess an efficient system of electrical communication round their coasts, none of the light-vessels are electrically connected with the main-land.

THE Franklin Institute, through its Committee on Science and the Arts, has recommended the award of John Scott medals and premiums to Mr. F. Pontrichet, of New York, for his improved "black-print" process; Herr S. Riefler, of Munich, for the invention of a pendulum escapement for clocks of precision; and Mr. E. G. Acheson, of Monongahela City, for his invention of carborundum.

THE Technical Instruction Committee of the Cheshire County Council have set aside £5000 towards an agricultural college in Cheshire, and £1,000 for the furnishing of it. The Royal Agricultural Society of England have promised the sum of £1000 towards the fund, and an offer of £500 has been received from a private donor. It is thought that £11,000 would be required for the college, and £1000 for its equipment.

DR. A. H. HASSALL died at San Remo, on April 9, at the age of seventy-six. He was the author of a work on British freshwater algæ, published in 1845, and of one on the microscopic anatomy of the human body, published in 1852. In 1850 he took up the question of food adulteration, and made a series of analytical reports, which led to a parliamentary inquiry into the pernicious and systematic adulteration that had been going on. He also assisted in the microscopical investigation of the water supply of London, especially during the cholera outbreak of 1854. In 1877 Dr. Hassall removed to San Remo, and there passed the remainder of a busy and useful life.

THE Council of the Royal Society of Edinburgh have recently made the following awards:—The Gunning Victoria Jubilee Prize for 1891–94 to Dr. Alexander Buchan, for his varied, extensive, and extremely important contributions to meteorology, many of which have appeared in the Society's publications. The Keith Prize for 1891–93 to Prof. T. R. Fraser, F.R.S., for his papers on *Strophanthus hispidus*, *Strophanthin*, and *Strophanthidin*, read to the Society in February and June 1889 and in December 1891, and printed in vols. xxxv. xxxvi. and xxxvii. of the Society's Transactions. The Makdougall-Brisbane Prize for 1890–92 to Dr. H. R. Mill, for his papers on the Physical Conditions of the Clyde Sea Area, the first part of which was published in vol. xxxvi. of the Society's Transactions. The Neill Prize for the period 1889–92 to Mr. John Horne, for his investigations into the Geological Structure and Petrology of the North-West Highlands.

A VERY interesting series of experiments were lately made by Mr. Charles A. Stevenson, with a view to proving that it is possible to communicate between lighthouses and lightships without a submarine cable requiring to be laid. After a number of laboratory experiments, made with a view to ascertaining the size of the coils and the number of turns necessary to give workable results with the ordinary commercial telephones, some experiments on a large scale were tried near Edinburgh. Two coils, 200 yards in diameter, and each containing nine turns of ordinary telegraph wire, were erected on poles, a distance of 800 yards intervening between the two. So well did the system act that it was possible to read, by induction, the messages

passing in the ordinary telegraph wires which were situated at a distance of 200 yards. After the sending of messages along this telegraph wire was stopped, it was found possible to send messages from one coil to the other with great ease.

THE official report of the cases treated for hydrophobia at the Institut Pasteur during the past year has been drawn up by M. Henri Poltevin, and appears in the current number of the *Annales de l'Institut Pasteur*. The mortality table issued by the institute only includes those deaths from hydrophobia which occurred after the lapse of fifteen days from the date of the last inoculation, such deaths being regarded as taking place in spite of the treatment. Any deaths which happen within this prescribed period are excluded. Last year two such deaths occurred, and as three other cases ended fatally during the treatment, and one other in consequence of the patient refusing to permit the completion of the inoculations, these also are excluded. Out of the 1648 persons treated at the institute during the past year, observing the above reservations, only four died. Of these cases, 135 were admitted suffering from bites on the head, 857 from bites on the hands, and 656 from bites on the limbs. Since the commencement of the inoculations, in 1886, 14,430 persons have been treated at the institute, and out of this number only seventy-two deaths are recorded. The following table shows the nationality of the 188 foreigners who presented themselves for treatment at the institute. It is significant that England again has been by no means loth to avail herself of the benefits of the anti-rabic treatment in Paris, although the opposition to the establishment of a similar institute in this country remains unabated.

*Nationality of the Foreigners treated at the Pasteur Institute in 1893.*

|                      |    |                    |    |
|----------------------|----|--------------------|----|
| Germany ... ..       | 2  | Greece ... ..      | 35 |
| England ... ..       | 23 | Holland ... ..     | 9  |
| Austria ... ..       | 1  | India ... ..       | 14 |
| Belgium ... ..       | 22 | Morocco ... ..     | 1  |
| Brazil ... ..        | 1  | Portugal ... ..    | 6  |
| Egypt ... ..         | 18 | Russia ... ..      | 1  |
| Spain ... ..         | 43 | Switzerland ... .. | 9  |
| United States ... .. | 1  | Turkey ... ..      | 2  |

THE last number of Dr. Danckelman's *Mitteilungen von Forschungsreisenden und Gelehrten aus den Deutschen Schutzgebieten* bears evidence to the energy with which the officials of the German protectorates in Africa set themselves to the scientific study of the lands which they administer. Sets of meteorological observations for 1891 and 1892 at Bismarckburg in the Togo district, and at two stations in the Camaroons, are published with a partial discussion. The magnetic constants of the Togo district are also given, together with long lists of astronomically-determined positions in both West and East Africa. Dr. C. Lent gives a report on the scientific station on Kilimanjaro, which stands at 1560 metres above sea-level on the southern slope of the mountain. The work in progress at this station is the exact mapping of the immediate neighbourhood, which is being done by triangulation. A geological survey is being carried on simultaneously, with special reference to the character of the superficial soil, but including the determination of the volcanic and sedimentary rocks as well. Complete meteorological observations have been set on foot, and before long the scientific geography of this island of temperate climate, rising above the hot plains of East Africa, will be sufficiently known to allow the question of its suitability for permanent colonisation by Europeans to be put to a practical test in the conditions best likely to ensure success.

DR. OSCAR BAUMANN, whose successful journeys in Eastern Equatorial Africa we have frequently referred to, has written a short but valuable article on topographical surveying for travellers

in the last number of the *Mitteilungen* for German protectorates, edited by Dr. Danckelman. Dividing the requisites for a complete topography into route surveying, compass bearings, measurement of altitude, and astronomical determination of latitude and longitude, he insists on the importance of all travellers being adequately instructed before setting out, so that they may use their instruments to the best advantage when in the field.

THE difficult question of the delimitation of the Congo State in the south-east, where the district of Lunda was in dispute with the Portuguese, has been settled by a commission consisting of the Rev. George Grenfell and Captain Gorin for the Congo State, and Lieutenant Sarmento for the Portuguese Government. The work of surveying and settling the frontier was completed in May last year, and the treaty was ratified at Brussels in March 1894. A map and brief report on the conditions of the border country are published in the *Mouvement Géographique*. The country is richly wooded, and *Elais Guineensis* is abundant at levels below 2000 feet. The commission did not meet with many animals, except on the rivers, and few birds were to be seen.

THE Lubudi, one of the upper tributaries of the Congo which joins the Lualaba about 9° south, was reported by Cameron on the strength of native rumour, and was not properly laid down on the map until the Katanga Expedition of Francqui and Cornet in 1892. An account of the river, with a map, is given in the last number of the *Mouvement Géographique*. The Lubudi rises on the high land known as Mount Kamea, the southern slopes of which drain to the Zambesi, and before it reaches the Lualaba follows a longer course than the main river itself. The confluence is somewhat remarkable, the two large rivers flowing parallel to each other for about a mile and a half, separated by a narrow strip of low alluvial land. The lower part of the Lubudi only has been explored as yet, although it has been crossed higher up by Mr. Arnott and others.

AN improved form of Blackburn's pendulum for the slow production of Lissajous's figures has been exhibited before the Istituto di Bologna by Prof. Augusto Righi. The ordinary simple form, in which a cup filled with sand is suspended by two strings joined in the shape of a Y, and the sand traces the compound oscillations about the two centres of suspension on a plate underneath, is unable to exhibit the figures obtained when the two periods are equal. In Righi's modification both the cup and the plate are suspended separately, and oscillate in planes at right angles to each other. By means of a clamp sliding vertically along the support, the cup can be given a great variety of periods, and a graduated scale enables the experimenter to adjust the two periods to any desired ratio. The strewing of the sand is controlled by a small valve at the bottom of the cup worked by an electromagnet, the current being transmitted along the suspending wires. This renders possible a very beautiful modification of the experiment. By making the current intermittent with regular intervals, the lines of sand are broken up into short pieces, whose length represents the velocity of the moving cup with respect to the plate. Another electromagnetic contrivance enables the observer to fix the exact phase of the vibrating plate at which the cup shall start on its own vibrations. The apparatus may easily be adapted to the composition of two oblique oscillations, and the curves, which are neat and sharply defined, may be fixed by means of steamed gum or sensitive paper.

IN dealing with refractive index as an aid in the elucidation of chemical constitution, one of the most important questions which has to be answered is how to eliminate or allow for the effect of wave-length. The relationships obtained vary with

the colour of the light used. According to Maxwell's theory, for infinitely long waves the square root of  $K$ , the dielectric constant, is equal to the refractive index;  $\sqrt{K}$  may therefore be taken as a measure of the "dispersion-free" refractive index. In the *Zeits. für phys. Chem.* xiii. 385, Jahn and Möller give a series of relative values of  $K$  for a number of liquids consisting of alkyl and aromatic halogen compounds and fatty acids. The communication forms an addition to that published by Landolt and Jahn (*loc. cit.* 10, 289) in 1892, and which dealt with liquid hydrocarbons. The first term,  $A$ , in Cauchy's dispersion formula has been generally used as giving the refractive index for infinite wave length. The present work shows, however, that of all the above liquids the paraffins alone give values of  $\sqrt{K}$  which approximate to those of  $A$ . The paraffins alone exhibit normal dispersion. Moreover, the values of the molecular refraction as calculated by means of  $\sqrt{K}$  differ considerably from those obtained by using  $A$  or refractive indices for light of a particular wave-length such as the red hydrogen line. Indeed, isomers which have the same molecular refractions for the red hydrogen line may give values which differ considerably when  $K$  is used, and in general the values of  $K$  are largely influenced by chemical constitution. The communications are important contributions to the connections which exist between optical properties and chemical nature.

A CATALOGUE has been issued of works on Italian Literature, Art, Archæology, and History offered for sale by Mr. Bernard Quaritch.

M. A. KLOSSOVSKY has prepared a memoir (in Russian) on the climate of Odessa, from observations made at the Meteorological Observatory of the Imperial University.

THE *Zoologischer Anzeiger's* index to the zoological literature of the second semester of last year has just been published. The titles are classified under forty-one heads; hence there is little difficulty in finding the various papers.

MM. J. B. BAILLIÈRE ET FILS, of Paris, have issued a catalogue of old botanical works (prior to the nineteenth century) and works on the history of botany, comprising more than 1000 volumes and pamphlets.

PROF. W. TRELEASE republishes, from the fifth annual report of the Missouri Botanic Garden, a monograph of the American species of two little-known genera of Onagraceæ, *Gayophytum* and *Boisduvalia*.

FURTHER papers have been issued by Mr. C. A. Barber on the "Diseases of the Sugar-cane in the West Indies," and suggestions made for their remedy, which consist chiefly in the selection of those strains which appear to be least susceptible to the disease.

IN *Bulletin* No. 9 of the *Minnesota Botanical Studies* is an interesting article by Miss Josephine E. Tilden, on the elaters of the Hepaticæ, especially of *Conoccephalus*, in which their tendency to branching is described. In a young state the elaters always contain starch.

MESSRS. BAILLIÈRE, TINDALL, AND COX have re-issued the second edition of Mr. Henry Penning's "Text-Book of Field Geology," published in 1879. The book contains a section on Palæontology, by Mr. A. J. Jukes-Browne.

MESSRS. BAILLIÈRE have also published a fourth edition of Mr. C. T. Kingzett's "Nature's Hygiene," the first edition of which appeared fourteen years ago. The book has been carefully revised, and a chapter has been added on the subject of phagocytosis and immunity, as well as one on alimentation and foods.

A VOLUME containing the results of magnetic and meteorological observations made at the Government Observatory, Bombay, during 1891 and 1892, under the direction of Mr. Charles Chambers, F.R.S., has recently been issued. The publication also includes a paper on the secular variation of magnetic dip at Bombay.

MM. TH. AND E. DURAND, of Brussels, are preparing for publication, with the assistance of other orchidologists, a *Census Orchidearum*. In this work will be enumerated about 8000 species of orchids, with their synonyms, spontaneous or cultivated varieties, and natural or artificial hybrids. For each species will be given the place and date of first publication, a reference to the figures, and the geographical distribution. The work will probably extend over more than 1000 pages, and is intended to be published in five fascicules, at six francs the fascicule to subscribers.

AN interesting account, by Sir Archibald Geikie, of the nature and extent of the work carried on by the Geological Survey, is contained in the *Journal* of the Royal Agricultural Society of England (vol. v. part i. March). The *Journal* also contains, among other papers, one by Mr. C. F. Archibald, on useful and injurious wild birds, the birds described being warblers, tits, pipits, buntings, and finches. Mr. Archibald's contribution should be read by all agriculturists who wish to be able to distinguish their friends from their enemies.

PROF. S. H. GAGE's excellent work on "The Microscope and Microscopical Methods" (Comstock Publishing Co., Ithaca, N.Y.), reviewed by us in September 1892, has reached a fifth edition. We have received part i., dealing with the microscope and histology; part ii. is in preparation, and will deal with the application of the microscope to study and investigation in vertebrate histology. The edition has been considerably enlarged, the additions including a chapter on photo-micrography. The expansions and emendations have been judiciously carried out, thus adding to the value of one of the best elementary works on the technique of the microscope.

A BIOGRAPHICAL sketch of Dr. Marcellus Malpighi, the distinguished physiologist and investigator, whose researches have figured in medical treatises since the middle of the seventeenth century, appears in *The Asclepiad* (vol. x. No. 40), accompanied by his portrait. Though he seemed to have worked with a simple microscope not better than a half-crown lens of the present time, he made some very important discoveries. He was elected a Fellow of the Royal Society in 1668, and between 1671 and 1684 contributed eight papers to it. His complete works, very copiously illustrated, were published by the Royal Society in 1686, in two volumes. Sir B. W. Richardson, the author of the biography, summarises most of Malpighi's work, comparing it with other physiological and anatomical researches of the seventeenth century, and with the knowledge that has since been gained.

A USEFUL journal for bacteriologists is *Modern Medicine and Bacteriological Review*, the "Bulletin of the Sanitarium Hospital and Laboratory of Hygiene, Sanitarium, Battle Creek, Michigan." It is edited by Dr. J. H. Kellogg, Superintendent of the Sanitarium and Hospital at Battle Creek, and the number before us not only contains three original papers by him, but a translation, also, of a paper by Prof. A. Charrin, M.D. A special section is devoted to "Bacteriological Notes," whilst abstracts and notes of medical and other papers are freely scattered throughout the journal. Articles on special subjects also form an important feature in this magazine. Amongst the twenty-two collaborators whose names figure on the cover we note that of Prof. Metchnikoff, of Paris. Following the usual complement of advertisements, we find a picture of the Sanitarium Hospital, and three

pages setting forth its special objects, as well as its constitution and management.

AN illustrated official handbook to the aquarium, picture galleries, and museum collections under the control of the Exhibition Trustees, Melbourne, has been compiled by Mr. James E. Sherrard. The Melbourne Exhibition Aquarium was opened in 1885, and was the first established in Australia. Some useful experiments have been carried out by workers in it, pointing the way to further developments of the fishing industries of the colony. Mr. Sherrard's little handbook contains a large amount of information about the fish of Victoria, and the aquarium equipment. He has made a number of experiments with a view to keeping fish alive in artificial sea water, but only with partial success. In sea-water, prepared according to chemical analysis, the fish became blind and only lived a few days. In water brought up to a standard strength with refined salt made from sea-water, the more hardy kinds of fish did very well, and in water made with Southall's sea-salt the fish seemed quite as much at home as in their natural element.

THE volume of *Transactions of the Sanitary Institute* for 1893 has been received. It includes papers read at the sessional meetings of the Institute, reports of a series of lectures on the sanitation of industries, and two lectures delivered to sanitary officers. We have also received the first number of the *Journal of the Sanitary Institute*, which it is intended to issue quarterly, in place of the annual volume of *Transactions*. The journal contains a paper on the etiology, spread and prevention of diphtheria, by Dr. R. Thorne Thorne, C.B., F.R.S.; one on the sanitation of places where food is prepared, by Dr. F. J. Waldo; and a report of a lecture on sanitary building construction, by Mr. Keith D. Young. Mr. G. J. Symons, F.R.S., contributes a list of works and papers on sanitation, and Prof. A. Wynter Blyth is the author of notes on legislation and some recent law cases. As the journal is a new development, a short epitome of the history of the growth of the Institute forms an appropriate introduction to its contents. The next Congress of the Institute will be held at Liverpool from September 24 to 29. The Health Exhibition in connection with the Congress will remain open until October 20.

A REPORT, by Mr. F. V. Coville, on the botany of the expedition sent out in 1891 to make a biological survey of the region of Death Valley, California, has been received from the U.S. Department of Agriculture. The botanical work undertaken by Mr. Coville was to collect and identify the plants of the region traversed by the expedition, to collate those data which had references to the range of species, and to arrange the material accumulated in such form that it would be useful in studying the facts and problems of geographical distribution. The report contains an itinerary, a section on the principles of plant distribution, and one on the distribution of plants in South-eastern California. In the section devoted to the characteristics and adaptations of the desert flora, a statement is given of the environmental conditions of the Death Valley desert region, and the resultant adaptive modifications of the flora are discussed. The report also contains a systematically arranged catalogue of the plants collected, a list of specimens, and a bibliography. We note that the metric system of linear measurements is used throughout the report, the itinerary excepted. The mass of matter brought together by Mr. Coville, and the fine plates which illustrate his descriptions, call for the highest commendation. By making grants for the expedition, the United States Congress has shown that it understands the importance of accumulating scientific observations, while the organisation of the work reflects great credit upon the Department of Agriculture.

MR. VICTOR COLLINS has compiled a catalogue of the library of the late Prince Louis-Lucien Bonaparte, and it has just been published by Messrs. H. Sotheran and Co. Prince Bonaparte's collection of linguistic works is regarded by many authorities as the finest in the world. From his youth upwards, he devoted his best energies and talents to the formation of his library. His high social position and rare literary attainments allowed him to give full scope to his philological enthusiasm, and assisted largely in the attainment of his ambition. According to Mr. Collins, the primary object of the Prince was the acquisition of works on every language and dialect represented in Europe; but in the course of years his ambition went further, and he collected specimens of every known language which possessed even the most rudimentary literature. Though it must always be a matter of regret that Prince Bonaparte did not carry out his intention of compiling a catalogue of his library on a scientific basis, Mr. Collins' compilation will be of considerable assistance not only to the bibliophile, but also to the philologist. The books are classified into three divisions, dealing respectively with monosyllabic, agglutinative, and inflectional languages; and the list of them covers more than seven hundred pages. We have previously noted that these linguistic treasures are for sale *en bloc*. It is to be hoped that they will be acquired by some learned institution, where they may be studied at leisure by experts, for they afford a unique means of research on the relations of languages and dialectal connections.

DURING the year 1892, Mr. W.B. Evermann spent six months on board the U.S. Fish Commission steamer *Albatross*, and made some interesting observations on the Ptarmigan of the Aleutian Islands (*Proceedings* Indiana Acad. Sci. 1892, p. 78). Among the birds collected were Willow Ptarmigan (*Lagopus lagopus*) and Rock Ptarmigan (*L. rupestris*) from Kadiak Island. The former ranges near the bases of the mountains and among the sparse willow growth of the lower portions of the island. At the time of Mr. Evermann's visit, the snow had melted from considerable areas frequented by this species, while higher up the mountains, where the Rock Ptarmigan was found, and where there was little or no woody vegetation, the snow covered everything completely. The principle of adaptation to environment was clearly illustrated by these two species. The one which ranged in the region still covered entirely with snow had not begun to change from winter to summer plumage; not one of the sixty odd specimens collected showing a single brown feather; the plumage of every one was a solid white. This was not so, however, with the Willow Ptarmigans. Their plumage had begun to change with the slowly melting snow, and in most cases the head and neck had almost completely changed to the summer brown, while brown feathers were scattered here and there through the rest of the plumage. It is easy to see, Mr. Evermann points out, that it is greatly to the advantage of each of these species to change from winter to summer plumage synchronously with the melting snows; too rapid or premature change, as well as change too long delayed, would defeat the object of protective colouration.

DURING the last few days Mr. Rowland Ward has had on view, in his Piccadilly establishment, a remarkably fine specimen of the so-called white rhinoceros (*Rhinoceros simus*). The late Mr. Burchell described this rhinoceros many years ago, and reported it as very numerous at that time at Latakoo. It is the largest of the genus, and has now become nearly if not quite extinct. Some ten years since Mr. F. C. Selous shot a specimen in Mashonaland, which he gave to the Cape Town Museum, and beyond one other which was shot by the late Mr. J. S. Jameson whilst hunting with Mr. Selous, no authentic records of any specimen of this

rare animal have been published. Mr. R. T. Coryndon shot two specimens early in July 1893, both of which have been modelled by Mr. Ward. On account of the weight of the specimens the skins were cut up into several pieces, which has made the work of modelling them one of the greatest difficulty. The largest rhinoceros is to form part of the Hon. Walter Rothschild's collection at the Tring Museum; the remaining one, which is not yet completed, has been acquired by the trustees of the Natural History Museum. The specimens are adult males, and the two skeletons are being macerated. Mr. Coryndon is leaving England again in a few days, his object being to travel to the northern end of Lake Tanganyika, in Central Africa, and to station himself there, build a permanent station, and collect insects, moths, butterflies, birds and small mammals for several English collections and museums. He hopes to gain some definite information in regard to the supposed new species of rhinoceros, and to determine the exact geographical district of the square-mouthed rhinoceros, the animal exhibited by Mr. Rowland Ward.

DR. K. VON CHRUSTSCHOFF, of St. Petersburg, has recently succeeded in preparing artificially the cubic modification of silica, which was discovered some years ago by Von Rath, and called christobalite. The manner in which the substance has been formed is as follows: Dry crystals of boric acid are saturated with dry silicon-tetrafluoride gas, when it is found that the boric acid crystals swell up and give rise to a very voluminous white mass, which is a combination of boric acid and silicon-tetrafluoride. This substance being thrown into an excess of dilute ammonia, gives rise to borate of ammonia, which is easily dissolved, and a white residue, and must be repeatedly washed with ammonia, water and alcohol, till every trace of the ammonia and boric acid is removed. The snow-white granular mass, which is not in the least gelatinous, is soluble to such an extent in pure water that aqueous solutions containing from 5 to 7 per cent. of silica can be obtained. Once dried, however, the solubility of the silica is completely destroyed. The silica thus prepared, with water containing a slight trace of hydrofluoric and boric acids, is introduced into the platinum apparatus used by the author in his previous experiments in mineral synthesis, and is heated to 200° C. for two hours, under a pressure of from fifteen to twenty atmospheres; when clear and colourless crystals from 0.1 to 0.3 mm. in diameter make their appearance. These crystals were isolated by treating the mass with alkalis and dilute hydrochloric acid. The crystals are found to be various combinations of the octahedron, cube and rhombic dodecahedron; they are completely isotropic, and show no trace of the anomalous double refraction described by Mallard and others in the natural crystals. On analysis they yielded 99.78 per cent. of silica.

A NEW mode of demonstrating the electrolysis of hydrochloric acid upon the lecture table is described by Prof. Lothar Meyer in the latest issue of the *Berichte*. As the late Prof. von Hofmann himself pointed out, in describing the well-known apparatus for this purpose which bears his name, the electrolysis of hydrochloric acid is not a very satisfactory experiment, as it invariably happens, even when the acid has been previously saturated with chlorine gas, that the volumes of hydrogen and chlorine obtained are unequal, the hydrogen being considerably in excess. A somewhat nearer approximation to equality is obtained by employing, as recommended by von Hofmann, a concentrated solution of common salt mixed with ten per cent. of the strongest hydrochloric acid, but even in this case the volume of the chlorine is always less by some few cubic centimetres than that of the hydrogen. This discrepancy is due to the fact that after closing the taps of the collecting tubes, the liberated gases

accumulate under continually increasing pressure, the liquid being forced up the reservoir tube, and under this higher pressure the liquid is able to take up more chlorine, and hence a portion of the rising gas is absorbed. This difficulty is overcome by adopting the following arrangement:—The two collecting tubes, joined as usual by a connecting cross tube near their lower ends, are made shorter than usual and without taps. The upper end of each is connected by a ground joint or a piece of thick caoutchouc tubing with a delivery tube bent outwards horizontally at a little distance above the joint; each delivery tube is sealed, a few inches along the horizontal limb, into a three-way tap which forms the summit of a measuring cylinder standing in a glass trough, and upon the other side of the tap the delivery tube is continued for a short distance as an exit tube. The carbon electrodes are not cemented in glass enclosing tubes, but merely closely fitted with loose enveloping tubes, in order to prevent mixture of the gases in the connecting cross tube. In order to carry out the experiment the electrolysis vessel is three-fourths filled with ordinary strong acid, the delivery tubes attached, the glass trough on the cathode side nearly filled with water, and that on the anode side with chlorine water. By attaching an aspirator, conveniently in the form of a caoutchouc ball, to the short exit tube attached to each three-way tap, the liquids in the troughs may be drawn up to the tops of the measuring cylinders; when this is achieved the aspirator is removed, and the taps so arranged that the measuring vessels are shut off and the electrolysis apparatus is open to the air. The electrical circuit is then completed, and the gases allowed to escape for a few minutes, during which they may be shown to be chlorine and hydrogen, the former by its action upon starch and potassium iodide paper, or indigo solution contained in a test tube held under the mouth of the exit tube, and the latter by collecting a quantity in another test-tube held above the open end of the other exit tube, and igniting the gas. Both taps may then be simultaneously turned so as to shut off the electrolysis apparatus from the air, and connect it with the measuring cylinders, when the gases will rapidly fill the latter to precisely the same extent. When sufficient has accumulated the current may be switched off, or the measuring vessels closed by suitable movement of the tap, and the volumes of the two gases shown to be exactly equal.

FURTHER details of the preparation of the salts of diazamidogen, hydrazine,  $\begin{matrix} \text{NH}_2 \\ | \\ \text{N} \\ | \\ \text{NH}_2 \end{matrix}$ , from the interesting diazo-derivative of acetic acid,  $\begin{matrix} \text{N} \\ | \\ \text{N} \\ | \\ \text{CH} \cdot \text{COOH} \end{matrix}$ , are given in the current

number of the *Berichte* by Prof. Curtius and Dr. Jay. Diazoacetic ether is first prepared, essentially as follows. Equal weights of chloroacetic acid and ammonium chloride are dissolved in water, and twice as much powdered lime added by degrees, so as to avoid undue heating. After standing the liquid is saturated with hydrochloric acid and converted by evaporation over the water bath to a yellow solid. This product is subsequently dissolved in alcohol and again saturated with hydrochloric acid gas, after which the alcohol is removed and the residue dissolved in water. In order to diazotise it sodium acetate is first added, so as to modify the action of sodium nitrite, then ice and sodium nitrite, when diazoacetic ether is formed and may be extracted by means of ether. In order to obtain the hydrazine salt from diazoacetic ether, the latter may be reduced either with ferrous sulphate and soda or zinc dust and soda, the former reducing agent being preferable, and affording 92 per cent. of the theoretical yield. Upon acidification with the acid whose hydrazine salt is required, the salt in question is pro-

duced. The theory of the reaction is that hydrazoacetic acid,  $\begin{matrix} \text{HN} \\ | \\ \text{HN} \end{matrix} \text{CH} \cdot \text{COOH}$ , is formed upon reduction of diazoacetic ether in alkaline solution, and that this substance is decomposed by acids with formation of a salt of hydrazine and glyoxylic acid. Thus, with sulphuric acid hydrazine sulphate is produced as follows:—

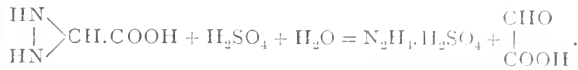

The silver salt of the unstable hydrazoacetic acid has actually been isolated from the liquid by action of silver nitrate. It is an insoluble substance which yields crystals of hydrazine sulphate upon addition of dilute sulphuric acid and evaporation. The glyoxylic acid by-product has also been isolated in the form of its hydrazone by addition of phenyl hydrazine. Hence the above reaction, memorable as the one by which Prof. Curtius first isolated di-amidogen, is now fully cleared up.

THE additions to the Zoological Society's Gardens during the past week include a Rhesus Monkey (*Macacus rhesus*, ♂) from India, presented by Mr. Robert O'Callaghan; a Macaque Monkey (*Macacus cynomolgus*, ♀) from India, presented by Mr. J. Pearson Callum; a Meller's Duck (*Anas melleri*) from Madagascar, presented by Mr. H. H. Sharland; a Rose Hill Parrakeet (*Platycecus eximius*) from Tasmania, presented by Mrs. Carter; a Smooth Snake (*Coronella laevis*) European, presented by Mr. Ignatius Bulfin; a Cape Zorilla (*Ictonyx zorilla*) from South Africa, a Hairy Armadillo (*Dasyfus villosus*) from La Plata, two Rabbit-eared Perameles (*Perameles lagotis*) from Western Australia, an Adorned Ceratophrys (*Ceratophrys ornata*) from South America, three White's Tree Frogs (*Hyla Cerula*), four Golden Tree Frogs (*Hyla aurea*) from New South Wales, deposited; a Tayra (*Galictis barbara*), a — Coot (*Fulica*, sp. inc.), an Orange-chested Hobby (*Falco fusco-caerulescens*) from South America, purchased; a Bennett's Wallaby (*Halmaturus bennetti*, ♀) from Tasmania, received in exchange; three Raccoons (*Procyon lotor*), a Crested Porcupine (*Hystrix cristata*), born in the Gardens.

OUR ASTRONOMICAL COLUMN.

THE PRESENCE OF OXYGEN IN THE SUN.—At the meeting of the Paris Academy of Sciences on April 9, Dr. Janssen described a convenient method of raising gases to a high temperature, used by him in connection with investigations on the spectrum of oxygen. The question of the presence of oxygen in the gaseous envelopes of the sun comes under two distinct cases. In the first place, oxygen may exist in the exterior parts of the corona, that is to say, in a medium where the temperature approaches that of the terrestrial atmosphere. In this case the spectrum of the gas would be similar to that which is produced by our atmosphere, and, in order to prove its absence in such parts of the coronal envelope, it is sufficient to show that the lines and bands due to oxygen in the solar spectrum are entirely produced, both as regards number and intensity, by the earth's atmosphere. Dr. Janssen's observations from the summit of Mont Blanc, and his experiments at Meudon, have been made with a view of settling this point. But the case of observations on oxygen at ordinary temperatures only represents a part of the question. Any oxygen existing in the lower portions of the corona, in the chromosphere, and in the photosphere, must be at a high temperature, and in order to decide, by means of spectrum analysis, as to whether it is present or not in these solar layers, it is necessary to know the modifications which the spectrum of oxygen undergoes when the temperature of the gas is elevated. This research, however, is attended with special difficulties. The absorption lines and bands of oxygen are only produced by great thicknesses of the gas. The B group, for example, only appears in the spectrum when a

luminous beam has traversed a thickness of 60 metres of the gas under the pressure of two atmospheres. The dark band situated near D requires for its production a thickness of 60 metres at a pressure of six atmospheres. It is extremely difficult to raise such long columns of gas to high temperatures, and the better plan is to reduce the length and increase the pressure. By means of an electrical method, Dr. Janssen has been able to heat a column of oxygen to incandescence without sensibly heating the tube containing the gas. He has used a steel tube 2.2 metres long and about 6 centimetres in external diameter, with an internal diameter of 3 centimetres. This tube is able to resist pressures of over 1000 atmospheres. The temperature of the gas is raised by means of a platinum spiral traversing the length of the tube, and insulated from it by means of a layer of asbestos. Dr. Janssen will shortly give an account of the results obtained when oxygen was introduced into the tube, heated, and spectroscopically observed.

MELTING OF THE POLAR CAPS OF MARS.—In the April number of *Astronomy and Astro-Physics*, Prof. W. H. Pickering calls the attention of astronomers to the fact that on May 30 Mars will reach the same part of its orbit with regard to the sun that it did on July 12, 1892, when a series of conspicuous changes were observed upon the planet's surface (see *NATURE*, vol. xlv. p. 179). It is therefore presumable that a similar series of changes will occur about the end of next month, and though the planet will not be so favourably situated for observation, the phenomena will probably be observable with any telescope of moderate size. Mars is a morning star at the present time, rising an hour or two before the sun. At the end of May it will be in Aquarius, and will then rise shortly after midnight, and be on the meridian at about 6.30 a.m. Prof. Pickering points out that the centre of the Northern Sea, around which a series of striking changes of shape and colour occurred, is central on May 30, at 17h. 50. Eastern Standard Time. There is no reason, however, for expecting the meteorological phenomena to occur on precisely the same date in two different years, and observers would do well to take every opportunity of watching the planet, as it is possible that the southern ice-cap may begin to melt earlier than usual.

EPHEMERIS FOR DENNING'S COMET ( $\alpha$  1894).—The following ephemeris is given for Denning's comet in *Astronomische Nachrichten*, No. 3223.

*Ephemeris for Berlin Midnight.*

| 1894.    | R.A. |    |     | Decl.        |
|----------|------|----|-----|--------------|
|          | h.   | m. | s.  |              |
| April 19 | 11   | 4  | 0   | + 19° 59' 6" |
| 21       | 8    | 19 | ... | 19 7' 0"     |
| 23       | 12   | 29 | ... | 18 15' 9"    |
| 25       | 16   | 30 | ... | 17 26' 1"    |
| 27       | 20   | 25 | ... | 16 37' 6"    |
| 29       | 24   | 14 | ... | 15 50' 3"    |
| May 1    | 27   | 55 | ... | 15 4' 4"     |
| 3        | 31   | 32 | ... | 14 19' 7"    |
| 5        | 35   | 4  | ... | 13 36' 1"    |
| 7        | 38   | 32 | ... | 12 53' 6"    |
| 9        | 41   | 55 | ... | 12 12' 2"    |
| 11       | 45   | 14 | ... | 11 31' 8"    |
| 13       | 48   | 30 | ... | 10 52' 4"    |
| 15       | 51   | 43 | ... | 10 14' 0"    |

The comet's brightness on April 22 is 0.31, that at the time of discovery (March 26) being taken as unity. It is fading, and on the last date given in the above ephemeris it will only be about one-tenth of the original brightness, and therefore extremely difficult to see.

THE SPECTRUM OF NOVA NORMÆ.—Prof. W. W. Campbell made some visual observations of the spectrum of Nova Normæ during February (*Astr. Nach.* 3223). On February 13 the star exhibited an exceedingly faint continuous spectrum in the yellow and green, and four bright lines apparently identical in position and relative intensity with the bright lines at wave-lengths 575, 501, 496, and 486 in the spectrum of Nova Aurigæ in August 1892. Rough measures of the two brightest lines gave the positions 5013 and 4953. Prof. Campbell says that there can be no doubt that the star has a nebular spectrum.

A NEW SOUTHERN COMET.—Mr. Gale, of Sydney, discovered a comet in R.A. 37° 42', Decl. 55° 35' S., on April 3. This was the second comet of this year, and will therefore be known as comet *b*.

*IRRITABILITY OF PLANTS.*

AT the last meeting of the *Versammlung*, or meeting of German naturalists and physicians, Prof. Pfeffer gave an address on the above subject—one which his own work has done so much to elucidate. Irritability, he points out, is not an exceptional characteristic found in special plants: it is a fundamental quality existing in all plants, from the highest to the lowest, although its manifestations in great measure escape superficial observation. The sensitiveness of a *Mimosa*, the curling up of tendrils when touched, or the curvatures of growing internodes in response to light and gravitation, are well known and easily observed instances of irritability. But the less obvious reactions are of equal interest. Pfeffer instances the remarkable researches of Hegler on the effect of mechanical traction on growth stems, which when stretched by a weight, gain mechanical strength through the development of the mechanical tissues, which follows as a response to the pull to which they are subjected. Pfeffer has recently shown that resistance put in the way of growing roots increases enormously the energy with which they grow. Other instances of adaptive stimulation escape ordinary observation because of the microscopic character of the reaction. For instance, the extraordinary directive influence of malic acid on the movement of the antherozoids of ferns, or of potash salts on the movement of bacteria. In the same way the irritability of the higher plants is commonly exhibited by movements so slow as to be imperceptible to the naked eye. It is no wonder indeed that the layman does not realise that plants have the same power of reaction to stimulation as animals. Pfeffer remarks, in a striking passage, that—“Man would not have inherited such a belief, if the world of plants had been visible to him from childhood as it appears under the higher powers of the microscope. Then he would have had constantly before his eyes the innumerable host of free swimming plants and other low organisms; and the hurrying bacterium turning and rushing towards its food, would have been as familiar as the beast of prey springing on its victim. To such eyes the growing stems and roots of the higher plants would have appeared circling with a search-like movement, and many other rapid reactions to stimulus would have been apparent. Under the influence of a multitude of such images, irritability would, without a doubt, have seemed to be a self-evident and universal property of plants.”

He goes on to point out how necessary it is to clear our judgments in regard to reactions in which movement is the observed factor. A bacterium rushing across the field of the microscope moves nothing like so fast as a snail, yet it moves rapidly in reference to its own minute dimensions, since it will traverse three to five times its own length in a second, while man at a walk only gets over half his height per second.

The one thing common to all the varied stimulus-reactions is that in each of them we recognise a phenomenon of release (*Auslösung*), or, to put it in familiar language, a trigger-action. Stimulation is therefore release-action in living matter.

In classing irritability among trigger-effects, we express the fact that the stimulus is only the releasing agent: the nature of the effect depending on the specific qualities of the organism. Just as the touch of a finger may, in the case of human machines, either blow up a powder magazine, start a steam-engine, or set a musical-box a-playing, so in the case of plants, the same stimulus produces different or even opposite effects on different species.

In machines, as in the living organism, every degree of disproportion between the releasing agent and the amount of energy released occurs. The latent period again is not peculiar to the manner of reaction of organisms, but finds a place in machines of human manufacture. In a clock set in action, a period elapses before the striking of the hour (part of released action) comes into play.

It is again no peculiarity of the organism that reaction to stimulus is usually adaptive, since machines are adaptive and self-regulating. The adaptive character of most reactions is as comprehensible as the failure of an organism to adapt itself to conditions not met with in nature. A bacterium being lured to certain death in a mixture of corrosive sublimate and extract of meat, is an example of what is meant.

Doubts may arise whether or no certain processes are to be called release-actions. Take the case of enzymes, from the point of view of the plant they serve to bring about a wide change at the cost of a relatively small amount of energy. Or take a

simpler instance, the tensions which allow the capsule of *Impatiens* to burst or the stamens of *Parietaria* to explode, are the product of vital activity, and have, moreover, an adaptive quality. But the release is purely mechanical; there is nothing like *perception* in the ordinary sense of the word, so that these phenomena differ from the reaction of *Mimosa*. Pfeffer, therefore, prefers not to consider the explosions of *Mimulus*, *Parietaria*, &c. as cases of irritability, while he acknowledges that there is no real objection to the word irritability having a wide enough meaning to embrace such cases. All that matters is that we should have a clear conception of the existence and importance of release action in the vegetable organism. Pfeffer points out that in his "Physiology" (1881) he laid down the same general principles that are developed in the present address, together with examples in various regions of change, and that even earlier, in his "Osmotische Untersuchungen" (1877), he expressed, without reserve, the same views as applicable to the phenomena of life generally. He claims for these views a practical priority in botanical literature, although he fully recognises that Dutrochet, in 1832, set forth perfectly clear and sound views on the subject.

In 1881, too, he used the word *Reiz*, i.e. stimulus-effect, as equivalent to physiological release-action; and he used the expression *Release* intentionally, because of the mystic conception attaching to the terms stimulus and irritability. In fact, he would at the present moment throw over altogether the word *Reiz* if it were not that the time has gone by for those mystic conceptions of life which are inconsistent with the law of the conservation of energy.

Pfeffer goes on to point out that when, in 1882, Sachs set forth his belief in the general existence of irritability, and in its necessity for the machinery of the organism, he spoke of it not as a phenomenon in the wider category of release-actions in general, but as a specific peculiarity of living organisms. Sachs, according to Pfeffer, holds the specific character of irritable organs to be not so much their unstable equilibrium as the fact, that after stimulation they return automatically to the labile condition. Pfeffer claims that this definition does not apply to many undoubted cases of stimulation. When callus is produced by injury, or when adventitious roots are developed in response to certain stimuli, there is no such automatic return, but a permanent alteration.

To produce a stimulus-reaction, a change in external or in inner conditions is necessary. The sensitive-plant does not react to steady pressure, but to variation in pressure. An analogous state of things is found when a plant in a condition of cold-rigor is made to grow by heat. For the change in temperature is merely a stimulus, since it only releases activities which are carried on by the energy at the plant's disposition, not by the heat. At a constant temperature the plant is in a static condition of irritability, which is a necessary condition for the realisation of vital activity. If the results of temperature-changes are not generally recognised by botanists as phenomena of stimulation, this is only a proof of the need of accurate conceptions in this branch of physiology. The association of the word with strikingly visible phenomena is partly to blame for this. Everyone recognises that, for instance, in the opening of the crocus or tulip flower, the change of temperature is a stimulus. In these instances the action of heat may be compared to the regulation of certain machines of human construction by the heat-expansion of a metallic rod.

Even when the increased temperature, by increasing molecular action, brings about a union with oxygen, still the temperature-change is only the indirect cause of the combustion; and this reasoning applies to respiration.

In a similar sense the addition of a salt of potassium to a culture-fluid produces a release action in a plant in which growth was checked by the absence of this element.

Pfeffer has some interesting remarks on the condition of irritability of organs in a condition of equilibrium: for instance, on the continued action of the gravitation stimulus on a geotropic organ growing vertically. Bacteria are less sensitive to the attraction of meat-extract when themselves immersed in dilute extract; that is to say, the homogeneous medium, which has no directive action, shows its effect in diminished irritability. The same is true of heat, which stimulates when it varies, and which, when constant, is a necessary condition for certain states of irritability. The idea is not a new one, for no less a man than Johannes Müller (Pfeffer points out) defined the formal conditions of animal and plant life as *Lebensreize* or *integrirrende Reize*.

The stimulus need not come from the outside, for just as a clock by internal machinery strikes at intervals, so in the organism combinations occur which function as stimuli for certain effects. These are naturally obscure, and for this reason we do well to fix our attention principally on external stimulation; but it can hardly be too much impressed on us that the development and ordered activity of the living body is inconceivable without the co-operation of stimulus from the inside.

With regard to stimulus and reaction, we are in the position of a man, ignorant of mechanics, who sets a machine in motion by a touch of his finger, and who has no idea whether the effect is due to a falling weight, to water-power, or to steam. Considerations of this sort make us realise our ignorance, so that when a new result is observed (in a case of stimulation) we do not even know whether the cause is to be sought in the perception of the stimulus or in the machinery of reply. While denying himself the discussion of cognate points, Pfeffer finds room to call attention to one or two interesting points of resemblance in the irritability of plants and animals. Thus, for instance, in plants as in man, an increase in the stimulus produces a dulling of sensitiveness. Just as a beggar is stimulated by the gift of a shilling, which on a rich man has no such effect, so a starving bacterium is stimulated to movement by excessively minute quantities of meat extract, while the same organism living in the midst of plenty can only be stimulated to similar movement by an absolutely greater quantity of extract. In the irritability of plants we find, in fact, the relations which are expressed in Weber's law—a proof that the relation in question has nothing to do with the higher psychic functions.

A plant or a plant-organ is never sensitive to a single stimulus only; thus during a geotropic curvature mechanical traction may bring about a strengthening of cell walls, and an injury may produce protoplasmic movement. Here lies a proof that different stimuli do not produce one and the same effect in a given cell, that, in fact, the cell does not react like our eyes, in which the most varied stimuli produce the effect of light. In the case of plants there can be no question of such a limited capacity—of specific energies in the sense of Johannes Müller.

The development of distinct organs of sense whose function is the perception of a single agent, is well known to be as little characteristic of plants as of the lower forms of animal life. But distinct organs of sense are no more a condition of irritability than they are of life. Indeed, plants exhibit a variety of sensibilities equal to that of animals, while in delicacy of perception the vegetable kingdom has the advantages. Bacteria are attracted by a billionth or trillionth of a milligram of meat-extract or of oxygen, infinitesimal quantities which we cannot weigh, and of which indeed we cannot form any adequate conception. It is just because the whole secret of life is contained in protoplasm, that the simplest organism, such as a bacterium, can be the theatre of as rich and varied a play of stimulus and reaction as the most complicated plant.

#### CHEMISTRY IN RELATION TO PHARMACOTHERAPEUTICS AND MATERIA MEDICA.

[BY the courtesy of the editor of the *Lancet* we are able to give the following translation of an address delivered at the Eleventh International Medical Congress, by Prof. B. J. Stokvis of Amsterdam University.]

##### THE TERM AND SCOPE OF PHARMACOTHERAPEUTICS.

"Therapy" or "therapeutics," by which terms we understand the art of serving the cause of humanity by assuaging human suffering and healing human ill, avails itself of every means in its power to arrive at these ends; *elle prend son bien où elle le trouve*. And the art of therapeutics, like all of us here assembled at this Eleventh International Medical Congress, has discovered that all ways lead to Rome. To Rome therapeutics has come—now in the guise of electricity, now as a water cure, now as psychical influence; so that we here are able to review, as they defile like armies before us, electro-therapy, pneumo-therapy, hydro-therapy, hypnosis, and psychic suggestion, and compare their merits as healing agents when placing themselves at our orders to combat disease and put death to flight. But most ancient of all the branches of medical art is that which makes use of drugs; and in

the hands of the inexperienced drugs can cause death (*φαρμακία*—the use of medicines or poisons), so that the science and art of the introduction of medicaments into the human body with the view of healing it carry with due right the appropriate title of "Pharmaco-therapeutics." And at one time, pharmaco-therapeutics was the most important branch of the healing art, though in our days it has declined and occupies but a second, or perhaps, I should say, third place; operative surgery, proud of its victories, and as admired as admirable, full of vigour and sap, has distanced the ancient branch. And, again, we see hygiene, young, fresh, lovely, and assured beforehand of all suffrages, taking its place in the front of all medical science, confident in the future success of its attempts to render the arts of healing superfluous by preventing the malady. Why, then, it may be asked, do I essay to interest you in an art which seems to be growing old under our eyes; whose past, it is true, is very honourable, but whose future hardly seems to promise the triumphs that have fallen to the lot of surgery and of hygiene. My reply is simple—because we shall not be able to dispense with this essential branch of our art; because, as much in external as internal medicamentation, we must for the present make use of pharmaco-therapeutics.

#### THE PRIME IMPORTANCE OF CHEMISTRY.

The substances that we employ in medicine are composed of chemical bodies, or are, perchance, pure chemical bodies; and to understand their physiological action we must have recourse to biology and chemistry; while to appreciate their application in disease it is necessary to study pathology and therapeutics. Chemistry, in its wide sense, enables us to understand the composition, the structure, and what I would term the affinities of a substance, as it is chemistry that enables us to analyse by tests, and to construct and reconstruct by synthesis. The relations between chemistry, on the one hand, and pharmaco-therapeutics and materia medica, on the other, are so intimate, so indissoluble, and so obvious that it almost seems to me superfluous to trouble you with their consideration. However, you will not mind, I hope, if I take the liberty of submitting to you a few points which may not be new, but which at any rate have the merit of being *apropos*, and may by thought upon them make us better appreciate chemistry. To pile stones on the top of each other is not to construct an edifice. Without a definite plan, without a general view—that is, a comprehensive conception of the whole constructive scheme—there can be no scientific edifice durably reared. Therefore, it would not be sufficient to constitute pharmaco-therapeutics a science to say that if it has arisen without preconceived ideas it is founded upon observations extending from the most ancient date with regard to the effects produced by the administration of certain substances to the sick; nor is it sufficient to claim that pharmaco-therapeutics has availed itself of experiments on healthy man and on animals, and has taken into consideration physiological results and the fruits of clinical study. A sound basis of operation from which to inquire into the use of medical substances is required. We must know, if we would satisfy the claims of science, the mode of action of these substances, and understand how it comes about that they possess the power to produce or remove functional troubles. And it is here that chemistry comes to our aid—chemistry in general, chemistry in its largest sense. I in no way lose sight of the incomparable services of biological chemistry and physiological experiment. Who of us would overlook the assiduous and successful work of Coppola, Gracosa, Pellacano, Albertoni, and of all that young Italian school that is now marching victoriously along the route traced out for them by Fraser and Brown? The method of action of medical substances has been and will be rendered more clear and comprehensible by their researches; but this is not enough. The conscientious striver after truth will always find himself face to face with one problem, a problem in the solution of which lie concealed—an inextricable secret so far—the true phenomena of life. We recognise this, for everywhere; where we are powerless to comprehend the action of medical substances upon the living organism as being due to their own inherent properties, we do not hesitate to call to our assistance the unknown properties of living protoplasm, and attribute the phenomena to them; but it is chemistry that should tell us that we must not be discouraged by the enigma of life. Enigma there is doubtless, but let us recall that Lavoisier first named life "a

chemical function," and that—once given that the creature lives—from that it obeys neither more nor less than dead or material nature the general laws of chemistry.

#### VITAL PHENOMENA AND THEIR MEANING.

The familiar phrases "living force" or "vital phenomena" serve us to design the outward expressions of condensed energy in dead material, being borrowed from the manifestations of life. In dead material, we are all aware, force can appear as thermal energy, as electricity, as light, or as mechanical expression, and we can go back along this line of transformations and see all the changes unmake themselves. In living protoplasm—considered as the unit of the psychic and reproductive functions—the essential phenomena are the same. There is the same change of *roles*, the same production of warmth, electricity, mechanical energy, and chemical energy. We know that the living cell "reacts," as we please to term it, to variations of temperature, electricity, light, and energy, chemical and mechanical; but this irritability in the cell, this aptitude of the cell to change one form of energy for another, resembles the transformations that take place in dead material, as the stimulants of the living cell, without which the vital phenomena do not appear, are just the different forms of energy which arrive to it from its environment, and which it changes into chemical energy.<sup>1</sup> For life the cell must have warmth and moisture. Take away the moisture or lower the temperature to the necessary point, and life becomes latent or disappears. In dead nature the same takes place. We are all familiar with the admirable experiments of Prof. Pictet, bearing upon this point. He proved by them beyond dispute that chemical energy disappeared and reappeared in accordance with the temperature to which certain substances were submitted, and that water is every whit as indispensable as a proper temperature for the maintenance of the phenomena of life. Certain it is that life is a chemical function, but the point is—Is not the chemical function a sort of life? Did not the father of medicine show a wonderful insight in counting water and fire among the four elements of which the universe is composed?

Now if we examine closer the special problems which fall within the scope of pharmaco-therapeutics, if we examine the results which follow the introduction of drugs—healing or poisonous—into the organism of man and animals, it must appear that we can never learn how to solve the problems without looking for their explanation in these "vital elements," as I may term them. The manifestations of their agency in the behaviour of living organism have so characteristic an imprint that even Claude Bernard himself did not hesitate to place chemical and purely physical action in the comparative background. I will give examples of my meaning. How are we to understand the fact that the ingestion of infinitesimal quantities of certain substances which pass through the organism without causing in it the least change can provoke such disordered chemical actions as to occasion death? How are we to understand the fact that different parts of the organism seem to be able to distinguish these substances the one from the other? We must admit special elective functions proper to the life of the cells. How are we to understand the facts that nothing but a change in the quantity of their dosage, the duration of their administration, and the method of their application suffices to make of certain toxic substances stimulants or paralyzants? How are we to understand the fact that insoluble substances like arsenic, cannabis indica, and lead can defy that well-known axiom, *Corpora non agunt nisi soluta*, and manifest therapeutic and toxic action. We must admit the presence and agency of some unknown power within the living cell. How, again, are we to understand the therapeutic power exhibited by solutions of iodine and bromine which have apparently been diluted to the deprivation of all chemical action, unless we attribute to the living cell the power of liberating the iodine and the bromine from such dilute solutions? Thanks to my compatriot and dear colleague at the University of Amsterdam, Prof. van t'Hoff, thanks to the admirable work of Arrhenius and of Ostwald, thanks to congresses of physicians and chemists, light seems to me to be about to be shed upon all these dark places in pharmaco-therapeutic science. And it has not been Mahomet who has gone to the mou<sup>nt</sup>

<sup>1</sup> It must be remembered that all of this is qualified by Prof. Stokvis's original reservation, "Once given that the creature lives."



but the mountains which have come to him. In other words the study of the chemical affinities of dead matter has revealed to us the secrets of the living cell.

#### THE APPEARANCE OF "VITAL PHENOMENA" IN CERTAIN CHEMICAL SOLUTIONS.

We have been accustomed to regard the neutral solution of sugar or of some neutral alkaline salt in water as an inert liquid deprived of all molecular power. We know to-day that such a solution must be held to possess the same kinetic power as if the substance dissolved were present in the gaseous state. Placed in contact with other solutions it will exercise pressure according to the laws that Avagrado and Dalton have discovered for gas. It will exercise an osmotic pressure in direct proportion to its molecular weights. But this is not all. We have to remember the electrolytic phenomena of such solutions by which their kinetic power may be rendered enormous. This conception of the molecular properties of solutions is of the highest importance both in biology and pharmaco-therapeutics. It is not by accident that life is so closely leagued, as it were, to water. It is not by accident that living organisms contain without exception more water than solid properties, that they contain much more of it in proportion than any other terrestrial object of palpable and visible formation. It is not by accident that the youngest and most energetic organisms, those in which life is the most intense, are distinguished by containing the most water, while the tissues in which life is ready to expire have the least. Life has been compared to a torch. From a chemical point of view life is not only a torch—it may also be compared to a river. It is an ocean in which the molecules of the chemical substances there constantly dissolve, constantly develop chemical, electrical, thermal, and mechanical energy, an energy whose seat is the living cell.

From all of this it follows as an absolute necessity that the chemical actions which constitute vital phenomena become stimulated, troubled, or altogether upset from the moment that we introduce into the system some new complicated substances in solution, whose molecular forces are now added to those of the cellular system. We are only embarrassed what example to choose when we seek in organic and inorganic chemistries proof of this point. I only wish to name one to you which seems to me conclusive. By warming pure chlorate of potassium we obtain pure oxygen, but the presence of the smallest quantity of chloride of potassium is sufficient to change part of oxygen into ozone. In giving rise to this development of ozone the chloride of potassium remains itself completely unaltered; but, what is more remarkable yet, this chloride of potassium itself has, like peroxide of manganese—which acts in an identical manner—the property of destroying ozone.

We find, then, here, as M. Brunck, to whom belongs the honour of having discovered the reactions, has said, a most remarkable phenomenon. We see a chemical substance, without itself appearing to undergo the least appreciable molecular change, favours the formation of a new chemical body, which, on the other hand, it has the power to destroy the moment that it is formed. There is, in fact, in the domain of organic chemistry, with no question of fermentation, a catalytic force, in considering which we have to make for dead nature a complete pendant of that which should we scarcely consider characteristic for therapeutic actions—the phenomena of excitement and paralysis, manifested by the slightest possible quantities of one and the same substance which itself remains unaltered! And speaking always with these phenomena before our eyes and looking on the cell as a colloid or membranous mass containing several substances organic and inorganic at the same time dissolved in water, there is no longer any reason to be astonished that slight changes in the quantity of one substance or the other, or that the presence in one of a body that is absent in the other, suffice perfectly to change the chemical affinity of the cells, as well as to differentiate them in such a manner that each of them seems to be endowed with an elective affinity peculiar to itself. As for the manifestation of therapeutic and toxic action by bodies considered to be insoluble, of which Nageli in a posthumous work has made so profound a study, they are also capable of the simplest interpretation. The insolubility of these bodies is not absolute, but only relative. If we throw, for example, metallic copper into water, and wait for some

days, we shall find that a certain proportion of the copper has dissolved, *i.e.* one part to seventy-seven million parts of water. The copper dissolves in this manner without the least intervention of any living organism. In the same way it is not the vital function of the human organism which makes arsenic, cannabis indica, and lead, display active properties when introduced in a metallic state under the skin. It is the mass of water which is the agent (for the human body may be regarded as a jug of water containing forty-five litres, and the temperature.

The view that regards the solutions of salts as mediums in which the chemical molecules are perpetually striving to assert their individuality has contributed, on the other hand, in the most efficacious manner to elucidate the action of some of the drugs that are most in use. I have particularly in my eye now the purgative and diuretic salts, the chlorates, iodides, and bromides, whose therapeutic effects are obtained upon doses that may be called massive when comparing them with the infinitesimal doses of which we have just spoken. Since my dear and honoured colleague of the University of Amsterdam, Prof. Hugo de Vries, discovered the law of i-o-tonic solutions, and since the admirable work of Prof. Hofmeister of Prague and his pupils, the effects of purgative and diuretic salts have been recognised to depend uniquely upon their pure chemo-physical properties. On the other hand, we owe to the zeal and perseverance of Prof. Hofmeister of Prague again a series of very beautiful researches on the imbibition of salt solutions by tablets of pure agar-agar gelatine, which demonstrate to proof that all that we have hitherto considered the elective affinity of the living cell can be explained in the most natural manner in the world by its colloid condition and chemical constitution. Add to this that the quickness of chemical action, according to the interesting chemical researches of Vladinarsky, is in no way impaired by the colloid state of the medium in which the substances are placed, and you will easily arrive at a conception of the immense progress that pharmaco-therapeutics has made by the agency of physical chemistry. Among the salts that I have named, the iodides and bromides are also to be found. Their therapeutic effects are, I need not say, altogether specific. What is more natural than the belief that we ought to attribute the results to the iodine and bromine themselves; and we all know that some long time ago, my colleague at the University of Bonn, Prof. Binz, has been able to demonstrate that it is the living cell which frees the iodine and bromine from solution. The fact is not, however, proved to universal satisfaction.

I should never finish my task if I tried to place before you all the points of the new view on the action of drugs, poisonous and otherwise, whose pharmaco-therapeutics are traceable to the theories of modern chemistry. Let us glance only at the catalytic fermentative action which takes place everywhere in live protoplasm, and which without doubt plan a preponderating *role* in the therapeutic effects of drugs. These can no longer be considered the appanage of the living cell. They also take place in dead matter.

#### CHEMISTRY IN RELATION TO MATERIA MEDICA.

If I now stop theorising it is not from fear lest anyone in this Areopagus of science should say: To what practical good does all this tend? Evidently it is not to-day or to-morrow that the art of medicine will profit by chemistry. But all these new ideas have rendered necessary new methods of experimentation, and new methods of investigation; and a new track is now being traced by human genius, along which there is much to discover; and from the moment that the new physical methods shall have been applied to the study of drugs (all honour to M. Dreser, who has here taken the initiative in his investigation into diuresis) medical art will profit and will find in chemistry a sure and trusty guide in its efforts to serve humanity.

In speaking of chemistry in its relation to materia medica I do not employ the words *materia medica* in the sense in which Di-corides used them. I employ them in their strictest and primitive sense to mean the collection of drugs and medicaments in use in our days—our *thesaurus medicaminum*. *Materia medica* recruits from botany, zoology, and above all from chemistry; but its immense progress of late is due to chemistry. The active principle of almost all our drugs are now known to us. They have been isolated, prepared, and elaborated; the chemical constitution of their active principles is no longer a secret. We know that sugar and glucosides, and aromatic oils

belong to chemical groups, and are as well defined as the alkaloids derived from pyridine or chinoline. Every day the number of contumelious substances—substances which do not wish to reveal to us their secrets—grows less. Chemistry has revealed to us the presence of more than twenty alkaloids in opium, and of more than six in quinine; and it will soon be extremely difficult to name the drug, of animal or vegetable origin, in which there have not been found one or several active principles. And, going from victory to victory, chemistry has also succeeded in producing a great number of alkaloids by the synthetic manner. These have not been the exceptional lucky strokes (*coups de maître exceptionnels*). No constitution and composition of other bodies that chemistry has not yet reproduced for us is already familiar to the chemist who can transform morphia into codeia and *vice versa*, and worthless cupreine into effective quinine. We may predict with every confidence that the manufacture by synthesis of all the known alkaloids is only a question of time for chemistry. But the triumphal march of chemistry does not stop here; it has constructed for us new alkaloids endowed with therapeutic effects of great value. It has furnished us, *inter alia*, with apomorphine and apocolaine.

It would be unequalled ingratitude to fail to recognise the imperishable services that chemistry has rendered to materia medica in endowing it with the alkaloids and the pure active principles because there are a few black clouds on the horizon. That there are such I do not deny, but they are not wholly the fault of chemistry. Is the gunsmith responsible for the accidents that a new firearm may cause in the hands of a client who does not know how to use the weapon properly? Surely not. Why did not the purchaser take the trouble to understand the structure of the gun? Why was he not more careful? Why did he pay no attention to warnings? Why did he behave like a happy child, with nothing more important to do than to display his new acquisition to all the world and to put it to the test with the innocence of youth? On the other hand, should not the gunsmith help to avoid such disasters by explaining matters to the purchaser? And if he is not himself sufficiently informed and does not thoroughly understand the mechanism of the weapon, should he have offered it for sale? Either party may be to blame. What I want to convey by my parable is this: by a very pardonable illusion, to which the many physicians and some chemists have given way, it has become generally believed that the active principles of drugs, when chemistry can furnish them for us in a crystallised state, are purely chemical bodies, and that identity of name guarantees identity of chemical composition. This illusion is rapidly being dispelled, but, alas! not without having done harm to physicians and their patients. As far as the chemical purity of crystalline products is concerned, it is to-day a secret of Polichinello that crystallised quinine contains cinchonidine, that atropine contains hyoscyamine, and atropamine, and that pilocarpine contains jaborandi. As much in organic as in inorganic chemistry we come across this phenomenon of mixed crystallisation. The crystallisation of substances is no guarantee of their chemical purity. These facts are sufficient to condemn entirely the new therapeutic system that M. Burggraave has wished to inaugurate under the name of "dosimetric medicine." Dosimetric medicine is doubly on the wrong track—first, in assuming the chemical purity of active crystallised principle of which it exclusively makes use, and secondly, in enunciating the therapeutic heresy that the administration of a single active principle is worth much more than the administration of the drug from which the active principle has been derived. I do not hesitate to describe this dosimetric profession of faith as a heresy. The drugs that are most used are admirably made compositions in which different principles, working for or against each other, are found together. Their therapeutic effect on the system is altogether different from the effect that would be obtained by adding and subtracting the therapeutic effects of each ingredient. Recent pharmaceutical researches have conclusively demonstrated this fact. I do not wish to say too much against domestic medicine. I think it has been, on the whole, inoffensive. Alas! I cannot say as much of the unreasonable faith which leads persons to believe that similarity of name and of active principle in crystalline form will produce chemical and pharmaceutical identity. *Ingentem, regina, jubes renovare dolorem!* We all know the grievous results that may be caused by giving aconitine or

digitalin derived from different sources. Here again the progress of chemistry promises improvement. The animal organism is most sensitive to stimulus, and modern chemistry has so many methods of stimulus at its disposal that the task will not be too arduous. It is a question which interests all civilised countries, which is brought forward at all medical and pharmaceutical international congresses, and which is in most urgent need of a satisfactory solution.

#### THE VAGARIES OF MODERN PHARMACY.

The services rendered by chemistry to therapeutics is not an exhausted subject. Certainly our predecessors already possessed a goodly medicinal treasury, but it seems very insignificant when compared with what we now utilise. Chemistry has loaded *Materia Medica* and *Pharmacology* with wealth; it is the mother of new remedies, and we are proud of its aid; it has given us our anæsthetics, antiseptics, hypnotics, and antipyretics. These groups of remedies enable us to give relief in many cases where our forefathers were quite helpless. To them chloroform, ether, carbolic acid, iodoforn, creosote, chloral, the salicylates, antipyrin, were all alike unknown. But here, again, and more so than with respect to the alkaloids, there are shades in the picture. Chemists and chemical manufacturers add more and more to our store of remedies day by day without stint or truce, without heeding the great despairing physician already overstocked with drugs. We are tempted to cry out for mercy. This is no exaggeration, for these new chemical products are all forced upon the same therapeutic market under the most attractive names, and all proclaimed aloud with the noise of the most perfect advertising machinery. This is now done to an extent that, in my opinion, is detrimental to the interests of therapeutics. I am not speaking of quack remedies, the *ovietara* of our day, of these secret specifics which the medical man views with wholesome horror, to which, and to whose use, the old adage, *Trompeurs, trompés, trompettes* can be so well applied. I am speaking of genuine well-known products; for, unfortunately, modern and industrial chemistry, in manufacturing and in placing at the disposal of doctors these drugs, does not at all object to their being purchased by the general public. If this is not so, why do their proprietors select for their names the fascinating names that act as veritable flags to attract the public—for instance, anti-nerve, anti-phthisine, anti-rheumatic, anti-dysenterine, and, most expressive of all, migrainine. I fully appreciate the difficulty of finding new names for these new products, and can understand that the manufacturer should shrink from giving them the names derived from their chemical composition, for these, generally speaking, could only be pronounced with linguistic gymnastics and intolerable strain upon our memory. I must, with great regret, note that we have departed from the ancient method, which taught us to denominate new products according to their origin, and we have followed freely a course that I cannot blame too severely—that of seeking for euphonious, sonorous names, pompously proclaiming the therapeutic use and effect of the drugs designated by them. It is not sufficient nowadays to have a good remedy—say agathine;—we must be assured of its superlative excellence, hence aristol. Do you want to prescribe for a patient who is "out of sorts," you have euphorine; for a lack of appetite, you have orexine. You desire to procure sleep for him: you have hypnal, hypnon, somnal, or somniferine. You wish to lower a febrile temperature: do not let the emergency trouble you, for you have antipyrine, antifebrine, antithermine, thermomine, thermofugine, pyrodine, and thermidine. You want to assuage pain? *Eh bien*, you have awaiting your orders analgesine, analgeine, exalgine, exodyne, and neurodyne. Or you desire to stimulate urinary secretions, you have diuretine, pheduretine, and uropheime. To check the formation of pus there is a remedy termed pyoktonine; and to combat spasms antispasmine. I do not wish to exhaust your patience, and I will spare you the enumeration of the antiseptics, the disinfectants, the microbicides *e tutti quanto*. Ten years exactly have elapsed since my honoured colleague, Prof. Rossbach of Jena, published an article full of wit and sound sense in ridicule and blame of these tendencies of modern therapeutics, and in those days we had not the long lists of antiseptic and antipyretic remedies. Nor was it then imagined that the essential extracts of the organs of animals, of which the late Prof.

Brown-Séguard and M. C. Paul were the earliest to explain the therapeutic value, would find a place in materia medica, nor cultures of microbes. It was not foreseen that we should have to chronicle in 1894 the sale not only of sequardine, but also of veritable bacterial products such as tuberculine, tuberculocidine, antituberculine, antitoxine, κ.τ.λ. How shall we check the fury of this flood? There seems no reason why it should ever come to an end.

### TRANSPARENT CONDUCTING SCREENS FOR ELECTRIC AND OTHER APPARATUS.<sup>1</sup>

IT is well known that electrostatic instruments require to be screened from outside electric disturbance, in order that their indications may be correct; but it is not so generally recognised that instruments intended to measure small forces, such as certain types of *electro-magnetic* voltmeters, delicate vacuum gauges, &c. are liable to give wrong readings from an electric attraction being exerted on the pointer, such as is produced by the glass cover when it is touched or cleaned.

There is on the table here a well-known type of gravity *electro-magnetic* voltmeter, which may be found on the switch-boards of many English and continental electric light stations. At the present moment its terminals are not connected with the electric light mains of the building, so that it should indicate zero pressure. Let me, however, but stroke the right-hand side of the glass cover with my finger, and the pointer, as you see, at once turns to eighty volts or more. Conversely, let the terminals of the voltmeter be connected with the electric light mains; the pointer should point to about 100 volts, for that, as you know, is the pressure supplied by the Westminster Company. The voltmeter appears to be indicating correctly, but, on stroking the left-hand side of the glass cover, the pressure, as read by the instrument, appears to suddenly fall to some forty volts. And a similar effect is produced if a piece of wash-leather or dry waste be used in place of the finger.

If, then, it is possible to cause this instrument to indicate at will sixty or eighty volts too high or too low, how impossible must it be to feel sure that the glass cover—which is, of course, maintained in a dry condition in a hot engine room—has not been electrified by some accidental touch of the coat sleeve sufficiently to cause an error of three or four per cent. in the reading of this voltmeter!

We find that it is not merely with this particular type of voltmeter that an error can be produced by stroking or rubbing the glass cover, for other *electro-magnetic* instruments that we have tried can also have their pointers deflected in the same way, but not to the same extent.

Nor, of course, is this source of error in any way connected with a voltmeter being an instrument constructed to measure an electrical magnitude, for it would equally exist if the glass were clean and dry and the controlling force remained of the same magnitude, no matter what was the quantity the instrument was constructed to measure. For example, on the table there is a vacuum gauge the wheel-sector-pinion of which has been replaced with an Ayrton-Perry magnifying spring. This gauge is, no doubt, very sensitive, for you observe that the pointer moves even when I produce an extremely slight diminution of pressure by rotating the short length of india-rubber tube as slowly as I can; the change of pressure on pinching the tube, or even on dropping it, is indicated by the pointer. On the other hand, the pointer is of glass, and therefore is not suitable for being acted on by an electrostatic force; still, a stroke on the glass cover, as you see, causes the pointer to deflect through several degrees.

It has been known for a long time that it is possible to screen an instrument from such outside electrostatic disturbances by surrounding it with a metallic cage composed of wire or of strips of tinfoil. Such a method of screening, however, has the great disadvantage that it renders it difficult to observe the exact position of the pointer from a distance, for the wires or strips of tinfoil cover up the pointer more or less. We therefore thought of placing the pointer underneath the metallic dial of our electrostatic voltmeters, and of only allowing the tip to project through a slot in the dial plate. But this method we abandoned on trying it eighteen months ago, for to make the

screening good the visible part of the pointer must be reduced to a spot, and the exact position of this spot we found less easy to read at a distance of several feet than that of a long black line, which is the appearance of a pointer when it is visible along its whole length. This method of screening has, however, we understand, been recently adopted by a firm of instrument makers.

We next considered whether it was not possible to make a perfectly transparent conducting screen, so that, while the electrostatic screening of the pointer should be practically perfect, the pointer and dial should be as easily seen as if the screen were not present. Our first idea was to make the glass cover double, and to insert between the two sheets of glass a layer of clear conducting liquid. Fearing, however, trouble from leakage of the liquid, or from the liquid becoming gradually turbid and giving the dial a dirty appearance, we turned our attention to depositing films of solid matter on the inside of the glass cover, or shade, of sufficient thinness to be practically transparent, but with the solid particles near enough together to be conducting. We tried smoke, silver deposited in layers of various thicknesses, mercury vaporised and deposited, sal-ammoniac vaporised and deposited, &c., but we were quite unable to obtain in this way both transparency and electric conduction.

After a conversation with Prof. Boys, when discussing the problem that we were then engaged in solving, we commenced experimenting on varnishes, with the view of arriving at a varnish which should be as hard and as transparent as *clear* shellac, but which, instead of being an insulator like shellac, should be a sufficiently good conductor to allow of the instantaneous production of an induced electric charge to balance the electrostatic action of any outside body. Glass plates were coated with gum, with coaguline, with the gelatinous electrolyte used in accumulators (composed of sodium silicate and dilute sulphuric acid), with isinglass dissolved in acetic acid, with gelatine dissolved in acetic acid, with i-isinglass dissolved in a mixture of acetic and sulphuric acids, and with gelatine dissolved in the same mixture. After much experimenting, we arrived at the following two methods of coating a glass cover, or shade, which gives perfectly satisfactory results:—

No. 1.—Dissolve  $\frac{1}{2}$  ounce of transparent gelatine in 1 ounce of glacial acetic acid by heating them together in a water bath at 100° C. To this solution add half the volume of dilute sulphuric acid which has been prepared by mixing 1 part of strong acid with 8 of distilled water by volume, and apply the mixture while still warm to the glass shade, which should be previously polished and be warm. When this film has become very nearly hard, apply over it a coating of Griffith's anti-sulphuric enamel.

Method No. 2.—Thin the gelatine solution, prepared in the manner previously described, by the addition of acetic acid (say 2 volumes of acid to 1 of the solution), and, after polishing the glass, float this thinned solution over the glass cold. Drive off the excess of acetic acid by warming, allow the glass to cool, and repeat the floating process, say, twice. Thin the anti-sulphuric enamel by the addition of ether, and float it over the gelatine layer applied as just described. Expel the ether by heating, and apply a second layer of this thinned anti-sulphuric enamel.

With experience, such as Messrs. Elliott and Messrs. Paul have at length acquired after much practice, a layer can be applied, either according to method No. 1 or No. 2, so that, when finished, it is quite hard to the touch, and so transparent that it is only by looking at the glass plate obliquely that the presence of the varnish can be detected. It is also so conducting that when a P.D. of several thousand volts, alternating with a frequency of 200, is set up between the needle and inductors of one of our electrostatic voltmeters, the pointer, which is metallically part of the needle, is not visibly attracted by a metallic rod held just outside the glass close to the pointer, this metallic rod being electrically connected with the stationary inductors.

Without experience, however, it is somewhat difficult to apply the coating so that it is not either cloudy, or a comparatively poor electrostatic screen, or both.

This second *electro-magnetic* voltmeter—which, like the former, has been kindly lent us by Mr. Barley, of the Knightsbridge electric light central station—looks exactly like the other one, and, indeed, behaved exactly like the other one when we received it. It has, however, had a layer of our transparent varnish applied on the inner side of the glass subsequently, and you will find that you may rub the glass as much as you like, or even hold a rubbed

<sup>1</sup> A paper by W. E. Ayrton, F.R.S., and T. Mather, read at the Institution of Electrical Engineers on April 12.

stick of ebonite near it, without producing any effect on the pointer.

Again, these two clear glass shades, belonging to gold-leaf electroscopes, are one of them coated with our varnish, and the other not. Which is the uncoated one is at once apparent from the alteration produced in the deflection of the gold leaves when I approach a stick of rubbed ebonite near the lower part of the glass shade of the uncoated one, for no such change in the deflection is produced, as you see, when the ebonite rod is brought near the glass shade, which is protected by a layer of this varnish applied on the inside.

### THE CURRENTS IN THE GREAT LAKES OF NORTH AMERICA.

A PAPER, entitled "The Currents of the Great Lakes," prepared by Prof. Mark W. Harrington, from data collected by means of bottle-papers during the navigation seasons of 1892 and 1893, has just been published by the U.S. Department of Agriculture as a Weather Bureau *Bulletin*. We reprint some of the more interesting parts of the paper, and reproduce a map showing the results of the inquiry.

Early in 1892 the Weather Bureau published a wreck chart of the Great Lakes, prepared in the winter of 1891-92. The wrecks noted on this chart were only those due to meteorological agents, and a striking feature of the chart was the clustering of wrecks in certain parts of the surface of the lakes. This suggested that unknown currents might play a considerable part in wreckage, and steps were at once taken to get some idea of what these currents are.

The method pursued was that of bottle-papers, which have frequently been used to study ocean currents, but had not been employed in the lakes, and is as follows:—A bottle, containing a paper on which is written the time and place of floating, is thrown overboard at some definite point, left to float freely, and when picked up the enclosed paper is marked with the time and place of finding. In this way two points in the line of current are obtained, and by considering a very large number of these, satisfactory conclusions can be drawn as to the currents which convey the bottles.

A large number of bottles were specially made for this purpose, with the name of the Bureau blown into the glass. They were of an unusual colour, but the contents could be easily seen by anybody who picked them up. The weight of a bottle was about 420 grams; total external displacement, 460 cubic centimetres; volume displaced when floating, 430 c.c.; volume exposed above water, 30 c.c.

From the position of flotation it appears that enough of the bottle was above the surface of the water to give the wind some power in drifting it. This would probably make little difference with the direction of the drift, for the wind that drifted the bottles would drift the surface water in the same direction. It may have made some difference in the speed with which the bottles travelled, making them move, perhaps, faster than the water, but this effect would be slight. Within each bottle a franked envelope was placed, addressed to the chief of the Weather Bureau, at Washington. Before a bottle was thrown overboard a blank form in the envelope had to be filled up, giving the name of the vessel and its captain, the date of floating, and the place where floated. Another space was left for the finder to insert similar data.

The bottles actually picked up were, for the most part, on shore, very few of them having been found in the water. It is impossible to say what proportion of the bottles was recovered, but it was not great. Though probably more than five per cent., it did not exceed ten per cent. The figures cannot be given exactly, because it is not known how many of the bottles are still in the hands of masters of vessels. A considerable portion of the papers recovered was found on the Canadian shore, and, curiously, a large number of them came from shores which are for the most part uninhabited.

The investigation covers the years 1892 and 1893, but it must be remembered that the observations could be taken only during the season of navigation. This practically limits the conclusions to the summer months, as when the bottles are floated in the spring they will probably be found in the autumn, and those that are floated in the autumn will be lodged in ice, and their routes be variously changed, so that trustworthy conclusions cannot be drawn from them. In general, the finds of

the latter sort—that is to say, the finds of bottles floated in the autumn and picked up in the spring—have been left out of consideration. The currents shown in the accompanying map are herefore those of the season of navigation, and practically the currents of summer.

#### CLASSIFICATION OF THE CURRENTS.

The currents in the Great Lakes can be grouped under the four following heads:—

(1) *The Body Currents*.—These lakes all have an outflow, and there must be a general motion of the water towards the outlet. This is visible upon the map of each lake, and the currents which result from it must be continuous throughout the year, and must affect most of the water.

(2) *A Surface Current due to the Prevailing Winds*.—That the winds have great effect on the currents in large bodies of water is widely recognised, and the more constant they are the more marked is the effect. The westerly winds, in case of lakes lying nearly east and west, cause a surface current from the west which is in the same direction as the body current. In the case of the lakes which lie across the direction of the wind, the surface drift is from the west across the lake. The details of the direction, however, depends on where the outlet is, on the form of the lake, and on the position of the inlet.

(3) *The Return Currents*.—It will be seen from the illustration that, in the case of three of the lakes, the main currents hug the shore. In the case of Lake Superior, it is on the southern shore; in the case of Lake Michigan, it is on the eastern shore; and in that of Lake Huron, it is on the western shore. Lakes Erie and Ontario do not show this phenomenon so plainly. This feature can be explained by the two sorts of currents already mentioned, combined with the lay of the lakes as to the prevailing direction of the wind and the position of the outlet. In any case, however, the drive of the water from one end of the lake to the other necessitates more or less a return current, providing the outlet is not sufficiently large to allow this water to pass through. In the Great Lakes, the outlets are comparatively small, hence in all these cases there are return currents.

(4) *Surf Motion*.—Owing to this motion, the bottles have been found to show a decided tendency shoreward whenever they came within its vicinity, and especially so when the water was shallow.

#### VELOCITIES OF THE CURRENTS.

The directions of currents can be ascertained with much more precision by means of bottle-papers than can the velocities. It has therefore been very difficult to arrive at any satisfactory conclusions concerning the speed of the currents in the Great Lakes. In a general way, the speed appears to vary from four to twelve miles a day. In a few special cases, very much higher velocities have been found, but these are probably due to surf motion rather than the motion of the surface water as a whole. It is not at all improbable that the general surface motion of the lakes has a higher velocity than from four to twelve miles a day, but the only conclusion which it seems safe to draw from the data is that the velocities are at least as high as the figures mentioned.

#### LAKE SUPERIOR.

In this lake thirty-five bottles were recovered in 1892, and the same number in 1893. From the courses of the bottles it appears that there is a general surface current along the south shore of the lake, from the Apostle Islands eastward, and that to the east of Keweenaw Point this eastern current has very great breadth. Still further eastward, toward the eastern end of the Lake, it spreads out in a fan-shaped way, and a branch of it seems to pass to the northward and westward, reaching the extreme northern coast of the lake. A branch of this current also turns southerly round Keweenaw Point, and at the bottom of the bay, on the south coast of the lake, an eastern current is taken up, which joins the main current to the eastward of Marquette, Michigan. The minimum velocity of the main eastward current of the lake appears to be from four to six miles a day.

#### LAKE MICHIGAN.

In this lake 163 bottles were recovered in 1892, and thirty-five in 1893. The currents indicated by the floating of the bottles are of unusual interest. There is first a

strong and well-marked current up the eastern coast, passing between the Manitow Islands and the Michigan mainland, and ending in the reefs and rocks to the north of Little Traverse Bay. There is a current down the west coast, but at some distance offshore. In the space between its margin and the shore there are varying currents, sometimes to the northward and sometimes to the southward—on the whole rather from the south than from the north. There is a great but gentler whirl about Beaver Island in a direction contrary to the hands of a watch. The velocities found in these currents are greater than those found in Lake Superior, and this is especially true of the northern end of the current, which passes up along the east coast. In the case of the bottles which crossed Lake Michigan, the velocities obtained in the best cases varied from four to four and a half miles a day. Taking only the bottles which passed between Manitow Islands and the mainland, the velocities obtained varied from six and a half to ten a day.

developed at no great distance from the south coast, and much farther from the north coast, which is cut by two long points extending out to about one-third of its width.

LAKE ONTARIO.

In Lake Ontario 56 bottles were recovered, of which 55 belonged to the season of 1892, and one to that of 1893. The directions taken by the bottles in the lake are somewhat similar to those in Lake Erie, but quite distinct from those of the upper lakes. There is a general current extending diagonally across the lake from opposite the mouth of Niagara River to the outlet near Kingston. The bottles exhibited a strong tendency to seek the east coast, passing down into the bay on which Sacketts Harbour, N.Y., is situated. There are evidences of a whirl in the western end of the lake, west of the meridian of Toronto.

The general conclusions of the paper relate only to the



Walker & Boutall sc.

LAKE HURON.

In this lake 186 bottles were recovered, 142 for the season of 1892, and forty-four for 1893. From the courses of the bottles, it is concluded that the arrangements of currents is very much like that of Lake Michigan. In this case, however, it seems that the main current is along the west coast, while in Lake Michigan it is along the east coast. It is found that in Lake Huron there is a strong current passing down the west coast and some little distance out, the whole length of the lake, turning on itself near the point of the lake, and passing up the east coast, possibly turning again along the north shore and rejoining the other current in the vicinity of Bois Blanc Island. A branch of this return extends into Georgian Bay.

LAKE ERIE.

The number of bottles recovered in Lake Erie was 96, of which 66 belonged to the season of 1892, and 30 to 1893. The general course of these bottles was eastward along the axis of the lake, with a tendency from point to point toward the coast. The indications are that the main current along the axis is best

greater currents of the lakes. These currents must be substantially as indicated by the five or six hundred bottle-papers which have been recovered. There will, however, be some modifications due to season and direction of wind, but these modifications will be superficial, while the regular currents of the Great Lakes, which are described above, must be fairly persistent. Many of the modifications will be found in the bays and at the extreme angles of the lakes, and these remain for further investigation.

SCIENTIFIC SERIALS.

*L'Anthropologie*, tome v. No. 1, January-February.—M. Émile Cartailhac contributes certain new facts with regard to the prehistoric history of the Pyrenees; in the present number he describes some quartzites of the St. Acheul type that have been recently found in the cave of Herm (Ariège). The examination of the animal remains was confided to M. Marcelin Boule who communicates a short note on the remains of the Glutton (*Gulo luscus*) and the Cave Lion (*Felis spelæa*) which were found

there in association with the worked flints. The mandible of *Felis spelæa* found in the cave of Herm presents characters intermediate between the lion and the tiger, and M. Boule would prefer to look upon this great cave cat as merely a polymorphous race of the modern lion; he suggests that it should be called *Felis leo*, race *spelæa*.—M. Salomon Reinach treats of sculpture in Europe prior to Greco-Roman influence; and M. G. Capus describes the ethnical migrations in Central Asia from a geographical point of view. From the Himalaya, southwards, to the Altai, northwards, the great mountain ranges of Central Asia form a series of practically parallel ridges running from east to west; but from the 35th to the 45th parallels of latitude there is also a mountainous barrier extending from north to south, and separating the western plains from the valleys and plateaus of the east. This barrier has played an important part in determining the course of the migration of nations and the distribution of the two great Asiatic races. It is formed more particularly by the Pamir plateau, extending from the valley of the upper Indus as far as the Thian-Shan, to the north of the Trans-Alai range. The whole of the surrounding region is thus divided into three great sections—the Indo-Afghan, the Turanian (including Kashgar), and the Tibetan, and each of these three districts is characterised by certain physical features which distinguish it from the others. The Turanian slopes, with their grassy steppes and their arid deserts, possess a climate, a fauna, and a flora of great uniformity; the absence of great forests, the predominance of pasturage over arable land, the rarity of summer rains, and the great variations of temperature, clearly distinguish this section from the other two. On the high Tibetan plateaus which extend from the Kuen-lun to the Himalayas, the climatic conditions caused by the great altitude are, in general, so unfavourable to human life that they serve by themselves sufficiently to characterise this region. The plateaus and valleys of Afghanistan and the northern plains of India enjoy, on the other hand, a soil less unequal in richness, a climate less extreme, and a vegetation more abundant, thanks to the moisture that they receive from the south-west monsoons. The cultivation of the soil is more extensive, and is, at the same time, carried on with greater energy, so that arable land is less localised, and is in greater proportion to pasturage. But the aptitude of the soil to support nomadic cattle-breeders or sedentary agriculturists is an efficient factor in determining the routes chosen by the one and the other in their movements of migration or exodus; and so we find that the sedentary Aryan who has trusted to agricultural pursuits from time immemorial has moved from the west to the south-east and the east; while the Turco-Mongol, who has devoted himself to the raising of cattle and nomadism, has chosen the Turanian route from the east to the north-west and west.—M. R. Verneau describes a new human cranium from a lacustrine city. This is one of two crania found at Concise, by Dr. Gilbert, with some 1700 objects of bronze and stone, and is confidently attributed to the bronze age; it is almost perfect with the exception of the lower jaw, and is remarkable for its extreme brachycephaly (91'46).

THE number of the *Nuovo Giornale Botanico Italiano* for April, and Nos. 2-4 of the *Bullettino* of the Italian Botanical Society, are almost entirely occupied with papers of special interest to Italian botanists, with whom the study of the galls produced on plants by insects occupies a large share of attention.

## SOCIETIES AND ACADEMIES.

### LONDON.

Royal Microscopical Society, March 21.—A. D. Michael, President, in the chair.—Mr. C. L. Curties exhibited and described a new form of photo-micrographic camera and drawing apparatus, designed by Prof. Edinger, and constructed by Herr E. Leitz.—Dr. W. H. Dallinger exhibited and described a new model microscope by Messrs. Swift.—Messrs. Watson and Sons exhibited a new super-stage plate fitted with two steel springs; they also showed a Ramsden screw micrometer and an Abbe camera lucida, both made in aluminium.—Mr. R. T. Lewis described a scale insect from Natal, which he believed to be *Trioxa pellucida*.—Mr. J. G. Grenfell exhibited and described specimens of Dicyemida, parasites found on the renal organs of cephalopods.—The President read a paper entitled "Notes on the Uropodinae," a sub-family of the

Gamasidæ, one of the higher families of Acari. The classification was first considered, that by former authors was reviewed, and a new classification proposed suitable to the present state of knowledge on the subject. Two new genera were established: one, *Glyphopsis*, for species with the body of irregular form sculptured on the dorsal surface, and with excavations for the legs on the ventral surface, which the author claimed as forming a natural group; the other, *Trachetes*, to replace *Celano*, which name has failed by the operation of the law of priorities and for other reasons. Three new species were described, two from Cornwall and one from the Tyrol. One of the former, *Glyphopsis Bostocki*, is the largest and handsomest of known Uropodinae; the Tyrolese species, *Uropoda hamulifera*, is also a remarkable creature. A list of the British species, which has not been attempted before, was then given, and the synonymy, which has fallen into great confusion, elucidated. The author then treated of the anatomy of *Glyphopsis formicaria*, a curious species found some years since by Sir John Lubbock in the nests of the ant *Sasius flavus*, and lately found by Mr. Michael in considerable numbers in Cornwall, in similar nests. This anatomy varies a good deal from that of other Uropodinae previously investigated. The alimentary canal is more of the type of other Gamasidæ than of the Uropodinae, the ventriculus being small and its cæca long. The male genital organs also present special features; but the most remarkable novelties consist in a number of branched "racemose glands" of various sizes underlying the dorsal cuticle in fixed situations, and probably functioning as dermal glands; the coxal gland, which is attached to the second leg on each side, is also noticeable specially for the extremely large size and fleshy nature of its duct. It is probably the most striking coxal gland yet found in the Acarina.

Victoria Institute, March 19.—Sir G. G. Stokes, Bart., F.R.S., President, in the chair.—On a possible cause for the origin of the tradition of the flood, by Dr. Prestwich, F.R.S. The paper described at considerable length the various phenomena which came under the author's observation during long years of geological research throughout Europe and the coasts of the Mediterranean. He concluded by giving the reasons why he considered that these were "only explicable upon the hypothesis of a widespread and short submergence of continental dimensions, followed by early re-elevation, and this hypothesis satisfied all the important conditions of the problem." The age of man was held to be divided into Palæolithic and Neolithic, and he considered rightly so. He concluded by saying that thus there seemed cause for the origin of that widespread tradition of a flood. The paper was followed by reference to a communication from Sir W. Dawson, F.R.S., who welcomed the paper as confirming his conclusion, come to on geological and palæontological grounds, as to a physical break in the anthropic age. The evidence for this was afforded by the cave remains and from a vast quantity of other sources. The discussion which ensued was joined in by a considerable number, including Dr. Woodward, F.R.S., Prof. T. R. Jones, F.R.S., T. McK. Hughes, F.R.S., E. Hull, F.R.S., and Sir H. Howorth, F.R.S.

Zoological Society, April 3.—Sir W. H. Flower, K.C.B., F.R.S., President, in the chair.—The Secretary read a report on the additions that had been made to the Society's menagerie during the month of March 1894.—Dr. Günther exhibited and made remarks on some specimens of the American Lepidosiren (*Lepidosiren paradoxa*) from the Upper Rio Paragua, collected by Dr. Bohls.—Captain H. G. C. Swayne, R.E., gave a description of the physical features of Somaliland, and an account of the expeditions he had made into the interior of that country during the past nine years, pointing out the localities in which the larger mammals were usually met with. The paper was illustrated by the exhibition of a large series of well-mounted heads of the various species of antelopes and other animals of Somaliland.—Mr. O. Thomas read a paper on the dwarf antelopes of the genus *Madoqua*, in which three species from Somaliland were described as new, and named *M. swaynei*, *M. phillipsi*, and *M. guntheri*. A revised classification of the six known species of this genus of antelopes was added.—Mr. R. T. Coryndon gave an account of his pursuit of the white or Burchell's rhinoceros (*Rhinoceros simus*) in Mashonaland, and of the way he had obtained the specimens which would shortly be placed in the British Museum, the Tring Museum, and the Cambridge University Museum (see p. 584).—A communication

was read from Miss E. M. Sharpe containing a list of the butterflies collected by Captain J. W. Pringle, R.E., while on the march through British East Africa from Teita to Uganda. A new *Papilio* was proposed to be called *P. pringlei*, and a new genus and species of Satyridæ was named *Raphicropsis pringlei*. Altogether examples of 134 species were obtained.

Linnean Society, April 5.—Mr. F. Crisp, Vice-President, in the chair.—Sir Joseph Hooker, K.C.S.I., exhibited a portrait, in oils, of Sir Samuel Bentham, Kt., a colonel in the service of the Empress of Russia, painted at St. Petersburg in 1784. He was father of George Bentham, the distinguished botanist, and former president of this society, 1861-74 (*Proc. Linn. Soc.*, 1886, pp. 90-104).—Dr. B. Shillitoe, exhibited some specimens of a primrose having abnormal leaf-like bracts immediately below the true calyx, and found growing with ordinary flowers of the same species.—An exhibition of some Trap-door spiders and nests, by Mr. F. Enoch, was deferred to a subsequent meeting.—Mr. R. H. Burne read a paper on the aortic-arch system of *Saccobranclus*, in which he elucidated the method by which respiration is effected in certain fishes which in tropical countries, but more especially in India, have acquired the power of living for a longer or shorter time out of water. Referring particularly to a paper by the late Surgeon-Major Francis Day, on amphibious and migratory fishes of Asia (*Journ. Linn. Soc. Zool.* vol. xliii. p. 198), he detailed the results of some recent investigations he had made, and were characterised by Prof. Humes as original and valuable.—The Secretary read a paper by Mr. H. N. Ridley, on the *Orchidææ* and *Apostasiaceæ* of the Malay Peninsula from the Kedah State (long. 99°30' to 104°30' lat. 7°N.) to Singapore, including the islands adjacent to the west coast, and those on the east coast of Johore, with the addition of a few from Southern Siam on the borders of the Malay Peninsula, the entire area comprising about 50,000 square miles. Mr. C. B. Clarke, who criticised the paper, commented upon the important additions made to the existing knowledge of the *Orchidææ* of this region, of which so large a portion was even yet botanically unknown.

## PARIS.

Academy of Sciences, April 9.—M. Lœwy in the chair.—On the unoccupied spaces in the zone of small planets, by M. O. Callandreaux. An investigation into the character of the stability of motion of small planetary bodies as affected by the commensurability of their periods of revolution with the period of revolution of Jupiter. The regions of instability correspond with the regions unoccupied by asteroids.—On the spectrum of oxygen at high temperatures, by M. J. Jansen. A description of the method employed for studying the spectrum of oxygen under pressure, the source of heat being a platinum spiral electrically heated. Results are to be published in a further paper.—On differential equations containing an arbitrary parameter, by M. Émile Picard.—On some copper objects belonging to ancient Egypt, by M. Berthelot.—On the slow alteration of copper objects when buried in earth and in museums, by M. Berthelot.—On a new octopus of Lower California inhabiting the shells of bivalve Mollusca, by MM. Ed. Perrier and A. T. de Rochebrune.—On the signification of hermaphroditism in relation to the differentiation of plants, by M. Ad. Chatin.—Note by M. Edmond Perrier accompanying the presentation of a work on the "Histoire des Etoiles de mer."—Report of the section of geography and navigation on the disasters of the Iceland fishery, by M. Guyou.—New parabolic elements of the comet Denning, by M. L. Schulhof.—Observations of the comet Denning (March 26, 1894) made at Algiers Observatory, by MM. Trépied and Renaux.—Observations on the comet Denning (March 26, 1894) made at Toulouse Observatory, by MM. E. Cosserrat and F. Rossard.—Observations of the planet AX and of the comet Denning (March 26, 1894) made at Lyons Observatory, by M. G. Le Cadet.—Occultation of Spica Virginis, observed at Lyons Observatory, by MM. G. Le Cadet and J. Guillaume.—On the *rapport conique et la relation conique*, by M. Mozat.—On reflection of electrical waves at the end of a conducting thread terminating in a plate, by MM. Ed. Sarasin and Kr. Birkeland.—Magnetic properties of iron at various temperatures, by M. P. Curie. The deduction is drawn, from data given, that at high temperatures iron commences to be magnetised with an enormous initial coefficient, but this almost immediately suddenly changes in the direction of the curve  $I = f(H)$ , the field and the intensity of magnetisation being yet very feeble; the curve afterwards presents itself as a

right line much less inclined and appearing to pass through the origin.—On the fusibility of mixtures of salts, by M. H. Le Chatelier. The mixtures (a) potassium and lithium carbonates and (b) sodium borate and sodium pyrophosphate have been studied in all proportions. The fusibility curves indicate, for (a) a very definite combination in equivalent proportions: for (b) a combination not so distinctly marked.—On the combinations of molybdenum dioxide and disulphide with alkaline cyanides, by M. E. Péchard.—On the use of polishing in the study of the structure of metals, by M. Osmond.—Action of halogens on homopyrocatechol, by M. H. Cousin. Chlorine has given (1) trichloro-homopyrocatechol, (2) the ortho quinone of (1), (3) more highly chlorinated substances now being examined. Bromine has yielded similar derivatives. Iodine does not seem to yield iodo-derivatives.—On a new earthworm of the family of the *Phreoryctes* (*Phreoryctes eudela*, Gd.), by M. Alfred Giard.—On the nerves of the antennæ and the chordotonal organs among the ants, by M. Charles Janet.—On the reviviscence of the Tardigrades, by M. Denis Lance.—The course of resin canals in the cauline parts of the silver fir (*Abies pectinata*, D. C.), by M. J. Godtrin.—On a siderolithic bed of mammals of the Middle Eocene, at Lissieu, near Lyons, by M. Ch. Depéret.—Discovery of fossil remains of the striped hyæna in the grotto of Montsaunés (Haute-Garonne), by M. Édouard Harlé.—On the glyptic race, by M. Édouard Piette.—On the "cassage" of wines, by M. A. Bouffard.—Squalls and storms, by M. Durand-Gréville.

## BERLIN.

Physical Society, February 16.—Prof. von Helmholtz, President, in the chair.—Prof. Planck delivered an address in memory of Heinrich Hertz, in which he drew, in warmly appreciative words, a clear picture of the development of the career, character, and work of the distinguished savant so early removed from science.

March 2.—Prof. du Bois-Reymond, President, in the chair.—Dr. Roepel had previously described an apparatus for the relative measurement of the magnetic properties of different kinds of iron suitable for technical purposes. This was composed of two coils of wire in which the needles to be compared were so placed that the north pole of the one lay immediately opposite to the south pole of the other. In the magnetic field so produced was placed a flat wire coil connected with a torsion needle, and by means of this the strength of the magnetic fields was measured. Dr. Roepel now described a new apparatus for obtaining absolute measurements which depended upon the yoke method. After a short discussion of the principle of this method, he described the experiments which had finally led to the introduction of that instrument for technical purposes. It consists of a half-yoke which is pierced through in the middle by two semicircular holes 1 mm. broad; the iron bar goes through the two limbs of the yoke, inside of which the magnetising coil lies. The small coil which measures the magnetisation of the bar passes through the small hole in the yoke, and carries a pointer by means of which its deflection can be measured. Dr. du Bois spoke concerning the need for very intense magnetic fields in the experimental examination of certain still unsolved problems of physics, and described minutely ring electromagnets, already mentioned and examined in detail by him, which were made in the works of Siemens and Hulske, and which, under the application of currents accessible in the laboratory, gave between conical poles of 60° a strength of field of 38,000 c.g.s.

March 16.—Prof. du Bois-Reymond, President, in the chair.—Prof. Börnstein reported on electric measurements which he had made in the previous year during two balloon ascents on August 18 and September 23. At the first ascent he had, on the ground of previous statements, expected that the fall of potential would increase with the height. The measurements were made with two polished aluminium points—these were soon of no use—and also with a water-collector consisting of a funnel, which acted well. The result was that the fall of potential decreased with the height, and at 3000 m. no conduction to the electroscopes occurred. The supposition that the measuring apparatus was in disorder was shown to be wrong, for in a lower air current, under 1900 m., electricity was again shown. At the second ascent observation was made with a collector in a metal funnel, and here also a diminution of the fall of potential was found at greater heights. Two subsequent balloon ascents, which were carried out in Paris, and a third carried out in Berlin in the previous

month, have given similar results. The views hitherto held concerning atmospheric electricity, and which originate from Exner, therefore need modification; at any rate, the view that the aqueous vapour produces negative electricity at the higher levels can no longer be held to be correct. What part it plays can only be determined by further electrical measurements from balloons.—Prof. von Bezold explained how the condition of the atmospheric electricity could be represented in the simplest and most diagrammatic manner by the aid of the graphic method.—Dr. Gross described new experiments on the electrolysis of sulphates in alkaline solutions, as, for instance, silver sulphate and silver oxide in ammonia solution, which led again to results from which he believed a dissociation of sulphur might be inferred.

**Physiological Society, February 23.**—Prof. du Bois Reymond, President, in the chair.—Prof. H. Munk spoke concerning Prof. Golz's lately published research on a dog which had survived for a long time extirpation of the cerebrum, and on whose behaviour evidence against the localisation of sense perceptions in defined regions of the cerebral cortex were founded. Prof. Munk, in the discussion which followed, explained that all the phenomena which can be referred to the presence of visual, auditory, olfactory, and gustatory perceptions in a dog which has been deprived of its cerebrum, were simple reflex phenomena which are awakened through general sensation without the participation of a sense perception. Dr. Ullmann described experiments which led him to the view that the red blood corpuscles are not biconcave discs, but are biconvex bodies.

**Meteorological Society, March 6.**—Prof. Hellmann, President, in the chair.—Dr. Schubert reported on the results of his further observations of the temperature and humidity in woods and in the open. The observations were taken last year at the same time, and were made at least twice daily, three hours after noon and at sunrise, by means of an aspiration hygrometer. On each occasion nine single measurements were taken in three groups, which were separated from one another by a quarter of an hour, while in the groups the single observations followed at intervals of one minute. The mean of twenty-six days' observations showed that in the morning the temperature in the woods was 0.08° higher than outside them, while after midday the temperature in the open air was 0.3° higher than in the woods. The humidity, both absolutely and relatively, was greater in the open than in the woods both in the morning and in the afternoon; the difference was similar to the temperature difference, only smaller. Measurements in the tent gave similar but greater differences than those made with the aspiration hygrometer. Prof. Sprung spoke concerning the diurnal range in velocity and direction of the wind on the Eiffel Tower. From the Espy Köppen explanation of the daily variation of wind velocity at the plain and summit stations, Prof. Sprung has derived an explanation for the opposed direction of the wind at the lower and at the higher levels; he has pointed out that from the presence of ascending currents about midday it follows that, at the lower level the wind must change direction with the hands of a watch, while at the higher station it must change against the hands. As, however, the wind observations at the summit stations are not free from the friction of the surface of the earth, Prof. Sprung has examined the reports of the wind observations on the Eiffel Tower, and has found here also a decrease of the wind velocity during the day, and an increase during the night, as was found on the summit station. The minimum wind velocity occurs, however, in summer as early as 9 a.m., while in winter it occurs first at 1, and in spring and autumn between 10 and 11. The wind direction, as on the summit stations, shows a maximum of turning with the watch before noon, and a maximum of turning against the watch after noon, the changes occurring also earliest in summer and latest in winter, but the changes of direction show themselves about three hours after the minimum velocity. The wind observations on the Eiffel Tower, therefore, confirm the Espy-Köppen explanation, and show that the influence of rising air-currents is already sensible at these moderate heights.

GÖTTINGEN.

**Royal Society of Sciences.**—The *Nachrichten* is now issued in distinct series, dealing respectively with literary, biological, and mathematico-physical memoirs. The first number of the *Mathematisch-physikalische Klasse* contains the following papers:—

January 13, 1894.—Ed. Riecke: A contribution to the theory of swelling by imbibition (*Quellung*).  
 February 3.—Prof. O. Henrici: On a new harmonic analyser.—W. Voigt: On an apparently necessary extension of the theory of elasticity (continued).—C. Brodmann: Some observations on the rigidity of glass rods.—O. Wallach: On the behaviour of the oximes of cyclic ketones (II.).

BOOKS, PAMPHLETS, and SERIALS RECEIVED.

**BOOKS.**—Transactions of the Sanitary Institute, Vol. xiv. (Stanford).—Machines Frigorifiques a Gaz Liquéfiables: K. E. de Marchena (Paris, Gauthier-Villars).—A Treatise of Natal Astrology: G. Witde and J. Dodson (Halifax, Occult Book Company).—Attempt at a Catalogue of the Library of the late Prince Louis-Lucien Bonaparte: V. Collins (Sotheman).—Tell el Amarna: W. M. F. Petrie (Methuen).—Man's Place in Nature, and other Anthropological Essays: T. H. Huxley (Macmillan).—Nature's Hygiene: C. T. Kingzett, 4th edition (Baillière).—Recherches sur l'Histoire de l'Astronomie Ancienne: P. Tannery (Paris, Gauthier-Villars).—Smithsonian Institution Report to July 1892 (Washington).  
**PAMPHLETS.**—Recherches Géologiques sur les Environs de Vichy (Allier): G. F. Dollfus (Paris).—Report of the Board of Managers of the Department of Archaeology and Palaeontology of the University of Pennsylvania, 1893 (Philadelphia).—Die Temperatur-Verhältnisse des Bodensees: Dr. F. A. Forel (Lindau i. B.).—Die Schwankungen des Bodensees: Dr. F. A. Forel (Lindau i. B.).—Transparenz und Farbe des Bodensees: Dr. F. A. Forel (Lindau i. B.).—La Lava Incandescente: A. Ricco (Roma).  
**SERIALS.**—Journal of the Sanitary Institute, April (Stanford).—Journal of the Chemical Society, April (Gurney and Jackson).—Record of Technical and Secondary Education, April (Macmillan).—American Journal of Science, April (New Haven).—American Naturalist, April (Philadelphia).—Annalen der K.K. Universitäts-Sternwarte in Wien, viii. and ix. Band (Wien).—The Asclepiad, No. 46, Vol. x. (Longmans).—Mind, April (Williams and Norgate).—Transactions and Proceedings of the Botanical Society of Edinburgh, pp. 233-656 (Edinburgh).—Journal of the Franklin Institute, April (Philadelphia).—Zoologischer Anzeiger, xvi. Jahrg. 1893, Litt. 2 (Leipzig).—American Meteorological Journal, April (Ginn).—Astronomy and Astro-Physics, April (Wesley).—Contributions from the U.S. National Herbarium, Vol. iv. Botany of the Death Valley Expedition (Washington).—Proceedings of the Aristotelian Society, Vol. 2, No. 3, Part 1 (Williams and Norgate).

CONTENTS.

|                                                                                                                         | PAGE |
|-------------------------------------------------------------------------------------------------------------------------|------|
| The Theory of Heat. By Prof. G. Carey Foster, F.R.S.                                                                    | 573  |
| An Educational Atlas . . . . .                                                                                          | 574  |
| Our Book Shelf:—                                                                                                        |      |
| Lydekker: "Life and Rock: a Collection of Zoological and Geological Essays" . . . . .                                   | 575  |
| Jadroo: "Disease and Race" . . . . .                                                                                    | 575  |
| Letters to the Editor:—                                                                                                 |      |
| The Mass of the Earth.—K. . . . .                                                                                       | 575  |
| The Royal Society.—Sir John Evans, K.C.B., F.R.S. . . . .                                                               | 576  |
| Lepidosiren paradoxa.—Prof. G. B. Howes . . . . .                                                                       | 576  |
| The Aurora of March 30.—F. R. Welsh . . . . .                                                                           | 576  |
| Fireball.—Worthington G. Smith . . . . .                                                                                | 577  |
| Micro-Organisms and Fermentation.—Frank E. Lott . . . . .                                                               | 577  |
| The North-East Wind.—Devonian Schists.—Prof. T. G. Bonney, F.R.S. . . . .                                               | 577  |
| Are Birds on the Wing Killed by Lightning?—Skelfo . . . . .                                                             | 577  |
| The Early Return of Birds.—Robert M. Prideaux . . . . .                                                                 | 578  |
| The Foundations of Dynamics.—Edward T. Dixon . . . . .                                                                  | 578  |
| The Eleventh International Medical Congress. By Piero Giacosa . . . . .                                                 | 578  |
| The Royal Meteorological Society's Exhibition. By Wm. Marriott . . . . .                                                | 579  |
| Notes . . . . .                                                                                                         | 580  |
| Our Astronomical Column:—                                                                                               |      |
| The Presence of Oxygen in the Sun . . . . .                                                                             | 585  |
| Melting of the Polar Caps of Mars . . . . .                                                                             | 586  |
| Ephemeris for Denning's Comet (a 1894) . . . . .                                                                        | 586  |
| The Spectrum of Nova Normæ . . . . .                                                                                    | 586  |
| A New Southern Comet . . . . .                                                                                          | 586  |
| Irritability of Plants. By Prof. Pfeffer . . . . .                                                                      | 586  |
| Chemistry in Relation to Pharmaco-therapeutics and Materia Medica. By Prof. B. J. Stokvis . . . . .                     | 587  |
| Transparent Conducting Screens for Electric and other Apparatus. By Prof. W. E. Ayrton, F.R.S., and T. Mather . . . . . | 591  |
| The Currents in the Great Lakes of North America. (With Map.) . . . . .                                                 | 592  |
| Scientific Serials . . . . .                                                                                            | 593  |
| Societies and Academies . . . . .                                                                                       | 594  |
| Books, Pamphlets, and Serials Received . . . . .                                                                        | 596  |



THURSDAY, APRIL 26, 1894.

## BIOLOGY AT THE ANTIPODES.

The "Macleay Memorial Volume." Published by the Linnean Society of New South Wales. (London: Dulau and Co., 1893.)

THE "Macleay Memorial Volume," dated September 1893, is a handsome work of 308 pp. quarto, with 42 plates and woodcuts. It contains a biography, by the editor, Mr. J. J. Fletcher, Secretary of the Linnean Society of New South Wales, with an accompanying portrait, and a series of thirteen representative memoirs, which deal chiefly with certain indigenous worms, molluscs, crustaceans, fishes, and mammals. Botany and vegetable palæontology are duly represented; and the claims of anthropology as a branch of biological science are rightly recognised, in the incorporation of an article by Mr. R. Etheridge, jun., on a series of exhibits forwarded by the Commissioners for New South Wales to the Chicago Exhibition of last year. The class Aves is, curiously, unrepresented; and we could have wished that Prof. Parker's revisionary monograph of the *Dinornithidæ* might have been reserved for its pages.

The project, which is commemorative of the work of the man who, as the scientific world knows well, has done more than all others for the furtherance of biology at the antipodes, emanated with Prof. Haswell, of the Sydney University, himself a contributor of two of the most important monographs, and it was carried into effect by a small committee, of which he and the editor were members.

William Macleay was born at Wick in 1820, and educated at the Edinburgh Academy. He emigrated in 1839; and, after spending fifteen years as a squatter, and thirty-five as a politician (serving under seven successive parliaments), he retired, to devote the rest of his life wholly to biology. As a politician he appears to have been neither a mere jobber nor an office-seeker, and he will be long remembered as the friend of the inland districts, and the foremost advocate of railway extension. The connection of his family with scientific progress in Australia is now historical; his own work in the same field dates from the year 1860. His entomological collection, originally associated with the foundation of the Entomological Society of New South Wales, became in time the nucleus of the Macleay Museum, which has now reached famous proportions. Having founded the Linnean Society of New South Wales, he proceeded to develop it, chiefly in association with the labours of a personally equipped and conducted expedition to the north-east coast of Australia and New Guinea, in the working out of the results of which he was materially assisted by others whose latent enthusiasm and abilities he aroused by his influence and example. The purchase and presentation of the Linnean Hall, to make good the loss by fire of its predecessor, the Garden Palace, set the seal to his life's labours, his total benefices being estimated at a value of £100,000. His work for the University has since his death entered upon a new phase, by his having bequeathed the sum of £12,000 for the endowment of a chair of bacteriology, and one of

£35,000 for that of four research fellowships in natural science, open only to members of the Sydney University, on the condition that they reside in New South Wales and publish their work in its Linnean Society's volumes. The energy and enthusiasm of professional workers in biological science at the antipodes is now sufficiently evident, although perhaps insufficiently recognised at home: and that of more private inquirers, such as is associated with the names of Bracebridge Wilson, Chilton, G. M. Thomson, Maskell, and others, has been already productive of most interesting and important results. The "Linnean Macleay Fellowships," indeed worth the having, cannot fail to inspire investigations of a high order; and owing to the conditions of their tenure, they must ever remain peculiarly suggestive of a welding together of the highest aims of their founder, in a manner destined to keep his memory green. Zoology is especially favoured; and the great desideratum of the moment is the fuller cultivation of the botanical field, which is wide enough for an army of workers, and, in consideration of the localisation of the various climatic conditions under which the colony is placed, must abound in treasures perhaps undreamt of. The investigation of this on broad morphological lines is imperative.

The first monograph which the volume contains is by Prof. Spencer, "On the Blood-vessels of *Ceratodus*," and he incidentally records some observations upon the habits of that animal. His confirmation of Günther's discovery of its vena cava inferior, and that of its pulmonary artery, of its anterior abdominal venous system, of its circulus cephalicus, and of the origin of its hyoidean artery from the first efferent branchial, are all of intense interest and very welcome, especially in anticipation of Prof. Semon's work upon the development of the fish, now progressing. This is followed by a monograph upon the "Pliocene Mollusca of New Zealand," by Prof. F. W. Hutton. Prof. Haswell contributes a "Revisionary Monograph of the *Temnocephalæ*," in extension of his well-known work upon the type genus; and it heightens the interest in these anomalous animals at all points. The discovery of a ciliated integument and of other features of a unique order for the Trematoda, leaves him still in doubt as to the affinities of these worms, and of an equally remarkable proboscis-bearing ally (*Actinodactylella*), leading the life of a scavenger on the burrowing crayfish, *Engæus fossa*, which he describes as new. Not the least generally interesting of Prof. Haswell's incidental discoveries are those of the behaviour of the *Temnocephalan* in relation to the surface film of water, of the presence of a series of ciliary flames within the substance of a single cell, and of the apparent passage of chromatic substance into the tail of the developing spermatozoon. Prof. Parker and Miss Rich contribute an elaborate monograph upon "The Myology of the New Zealand Sea-Crayfish (*Palinurus Edwardsii*)," and it is in the spirit suggestive of Dr. Johnson's famous remark that easy reading is precious hard writing. The discovery that Milne-Edwards' flexor abdominis is in part an extensor is apparently perfectly sound; and that of vestigial muscles in relation to the bases of the antennules and their sterna with which they are continuously calcified, is particularly welcome,

as it opens up new possibilities of approaching difficulties now arising in certain quarters, as to the exact interpretation of parts of the arthropod body where similar fusion is effected. Messrs. Wilson and Martin contribute a couple of papers on "The Muzzle of *Ornithorhynchus*," and inform us that the beak of that animal is in life "no more horny than a dog's nose." They show that Turner's "fibrous membrane" is really a cartilaginous tract, and that the immense pre-nasal cartilage is the inter-trabecular one of Parker, highly specialised. Their observations on the "rod-like tactile organs," which Poulton first described and discussed in their exquisite bearings on the functions of end-organs of the Pacinian type, appear on the whole unsatisfactory, in consideration of their having worked upon fresh material. Their illustrations are crude, and they do not seem to have made the most of their preparations. Then follows a paper by Mr. C. Hedley, on the aberrant gasteropod *Parmacochilea*, and one by Prof. Ralph Tate on the "Geographical Relations of the Floras of Norfolk and Lord Howe Islands," in which he concludes that the latter are to be regarded as outliers of the New Zealand region. Baron von Mueller contributes two papers on systematic botany, and Mr. R. Etheridge, jun., one, already alluded to, upon "Some Implements and Weapons of the Alligator Tribe, Port Essington, North Australia." The series closes with a monograph of 51 pages, by Mr. W. A. Cobb, on "Nematodes, mostly Australian and Fijian," in which eighty-two species (half of which are new, and many of which are European) are worked out, in relation to a plan under which the unit of measurement equals the 1-100th part of the worm's length, and certain longitudinal and transverse measurements, taken at points which mark the disposition of leading organs and apertures, are ingeniously formulated for ready comparison.

Such is the scope of the volume, and we congratulate the committee upon it. So far as the editor is concerned, there is internal evidence of the great labour of his task, and that its execution has been to him a labour of love. When it is considered that during the compilation of a work so costly and unremunerative, the country lay under a sore financial depression, we earnestly hope that the meagre list of subscribers announced within its covers will be supplemented by a number sufficient for adequate repayment.

The illustrative plates are somewhat unequal in merit, those of the Photoline Printing Company being in particular not a little crude and muzzy. We note, however, with intense satisfaction, the work of a native lithographer, Wendel by name. Anything more satisfactory than his draughtsmanship it is difficult to conceive; and illustrations such as those numbering pl. xi., fig. 9, and pl. xiv., fig. 1, betoken, on his part, artistic feeling (*Geist*) of a high order, and, on that of the printer, manipulative skill worthy the highest encouragement. For the "discovery" of this artist Prof. Spencer has to be thanked; and it is not a little irritating to us at home that it should have remained for our antipodean *confrères* to first reach that standard of excellence in scientific illustration which, in association with the well-known names of certain continental lithographers, has been so long the admiration of the biological world.

NO. 1278, VOL. 49]

The contents of the volume, when broadly estimated in correlation with the work which the Australasian biologists have during the last decade made public, amply testifies to a determination on their part to leave the study of histogenesis and the refinements of microscopy to us at home, in preference for the monographing of their indigenous fauna and flora, along those broader lines upon which the great problems to which they hold the keys must be solved. The resolution is as wise as it is noble on their part, and in adopting it they are unquestionably furthering the foremost desires of the generous and far-sighted man whose pioneer's work they have so successfully combined to memorialise.

G. B. H.

#### HARMONIC ANALYSIS.

*An Elementary Treatise on Fourier's Series, and Spherical, Cylindrical, and Ellipsoidal Harmonics, with Applications to Problems in Mathematical Physics.*

By W. E. Byerly, Ph.D., Professor of Mathematics in Harvard University. (Boston, U.S.A.: Ginn and Co.)

THIS treatise contains, in an expanded form, the subject-matter of a course of lectures by Prof. Byerly, on the functions mentioned in the title. The properties of the functions are developed, to a large extent, by means of special examples of their application to obtain solutions of problems involving the differential equations of physics. The object of the treatise appears to be rather to give examples of the practical applications of the functions, than to develop in detail their analytical properties; many important theoretical points are accordingly passed over, the results of investigations being in many cases merely stated. In the introductory chapter the functions of Legendre and Bessel are introduced by means of some of the simpler differential equations of physics. As a matter of method, we think it might have been better to have referred all the functions to Laplace's equation in the first instance, leaving the cases of the equations of heat, vibrations, &c. for subsequent treatment; thus, for example, the circular and exponential functions, spherical harmonics, and Bessel's functions should make their first appearance in the *normal forms*,

$$e^{\pm\sqrt{m^2+n^2}z} \frac{\cos mx \cdot \cos ny}{\sin mx \cdot \sin ny}, \quad r^n \frac{\cos m\phi \cdot P_n^m(\cos \theta)}{\sin m\phi \cdot P_n^m(\cos \theta)},$$

$$e^{\pm kz} \frac{\cos m\phi \cdot J_n(k\rho)}{\sin m\phi \cdot J_n(k\rho)},$$

which satisfy the equation

$$\nabla^2 V = 0.$$

The least satisfactory part of the book appears to us to be the treatment of Fourier's series in chapters ii. and iii.; it is neither desirable nor possible in an elementary treatise to give a complete discussion of the various points which arise in such a subject as the expansion of arbitrarily given functions in series of circular functions, but it is eminently desirable that it should be distinctly pointed out whenever a result is obtained by a method which falls short of demonstration, and the nature of the assumptions made, should as far as possible be indicated. If this is not done, the student is misled into thinking

that results have been demonstrated which have really only been suggested as possibly true. A case in which the criterion we have laid down is not satisfied, occurs on p. 35, where, after having shown that a finite series of sines can be found, the sum of which coincides with the values of a prescribed function at  $n$  points, the author states that since this result holds good however large  $n$  may be, the limiting form of the curve represented by the series absolutely coincides with the arbitrarily given curve between the limits of the variable. A precisely parallel argument would show that a similar result was true for a power series, which is well known not to be the case. No sufficient safeguard is given by the statement on the next page that the infinite series must be convergent, or by the limitation introduced on p. 38. The method by which Fourier's double integral is obtained on p. 53, is another example of a case in which the student will be apt to believe that the result has been proved. We think that it is very doubtful whether the simplification of Dirichlet's proof of the convergence of Fourier's series obtained by considering a particular case of the series, as in chapter iii., is sufficiently great to compensate for the loss of generality.

In chapter iv. a number of interesting and instructive special problems in heat and in vibrations are considered, a considerable number of exercises being left for the student to solve.

The treatment of spherical harmonics in chapters v. and vi. is satisfactory; a little more space might, however, have been with advantage devoted to the discussion of solid harmonics as developed by Thomson and Tait, and by Maxwell.

In chapter vii., in which Bessel's functions are considered, the infinities of the two Bessel's functions, both for real and imaginary arguments, should have been evaluated, as the selection of the proper forms for the solution of potential problems requires a knowledge of the values of the functions when the argument is infinite. Chapter viii. gives a good introduction to Lamé's functions, the toroidal functions being also briefly mentioned. The interesting historical summary, added by Dr. Bôcher, adds considerably to the value of the book.

In spite of some defects, the treatise is in many ways in advance of any other on the same subjects, in the English language, and should be consulted by all students of mathematical physics. E. W. H.

#### OUR BOOK SHELF.

*Bird Life in Arctic Norway.* By Robert Collett, Professor of Zoology in the University of Christiania. Translated by A. H. Cocks, M.A. (London: R. H. Porter, 1894.)

THE snow-covered peaks of the Land of the Midnight Sun possess irresistible powers of attraction for most lovers of nature. And they who make periodical migrations to this Switzerland of North Europe, as well as casual tourists, cannot do better than provide themselves with a copy of the popular *brochure* now before us. In it the traits of the bird-life in the three natural zones of which Arctic Norway consists will be found interestingly treated. These three natural divisions are (1) the coast district and the belt of islands girding the coast up to North Cape; (2) the deep fjords of the Arctic Ocean and the adjacent river basins in East Finmarken; and

(3) the interior plateaus of Finmarken, or Lapland proper. Each region is brightly described, and the peculiar characteristics of the bird-life in it are plainly set forth. The information imparted by the guide is accurate and well adapted for the general reader; and the ornithologist will also find in it much that is worth reading, especially as a list of the birds of Norway, arranged according to the rules of the British Ornithologists' Union, is given in an appendix. It would be an advantage if, in future editions of the book, the names of places referred to by means of capitals and dashes, thus, M—, T—, &c. were printed in full. To guess the locality from these designations is sometimes difficult, and the signs themselves are always tantalising.

*A Text-Book of Euclid's Elements.* (Books ii. and iii.) By H. S. Hall, M.A., and F. H. Stevens, M.A. (London: Macmillan and Co., 1894.)

IN this work the authors deal exclusively with the second and third books of Euclid. The propositions and their proofs are clearly stated and proved, and very little additional matter, with the exception of corresponding algebraical formulae and exercises, is inserted between the propositions themselves. Later in the book, following a few words on the method of limits as applied to tangency, several of the well-known theorems on Book iii., with numerous examples, are given; thus one is brought into contact with problems on tangency, orthogonal circles, properties of the pedal triangle loci, maxima and minima, &c., concluding with a series of harder miscellaneous examples. A short appendix contains one or two propositions on the pole and polar, and radical axes. The book is thoroughly suited for work in schools and colleges, and is printed neatly with distinct figures. W.

#### LETTERS TO THE EDITOR.

[The Editor does not hold himself responsible for opinions expressed by his correspondents. Neither can he undertake to return, or to correspond with the writers of, rejected manuscripts intended for this or any other part of NATURE. No notice is taken of anonymous communications.]

#### Panmixia.

IT is now twenty years ago that I published in these columns the doctrine of Panmixia, or Cessation of Selection, and since this doctrine was independently re-announced by Prof. Weismann I have repeatedly had occasion both to explain and to defend our common views upon the subject. For it is surprising how many of our foremost English evolutionists seem to have found a difficulty in understanding exactly what is meant by the doctrine. In view, therefore, of Prof. Weismann's forthcoming lecture at Oxford, it seems desirable that the present standing of the matter should be presented to the consideration of English biologists. An opportunity may thus be afforded him of answering the objections which they have raised against one of the fundamental doctrines of his entire system.

In NATURE of April 12 Mr. Wallace writes:—"He (Mr. Kidd) is under the mi-taken impression that the theory (*i.e.* the state) of *panmixia* leads to continuous and unlimited degeneration. Many writers have pointed out that this is an error. The amount of degeneration thus produced would be limited to that of the average of those *born* during the preceding generations in place of the average of those that had *survived*. As Prof. Lloyd Morgan puts it, the survival-mean would fall back to the birth-mean."

This way of putting it, however, was originally due to Prof. Ray Lankester, whose views and terms relating to the subject were afterwards adopted provisionally by Prof. Lloyd Morgan. It may still be remembered by your biological readers that about four years ago Prof. Ray Lankester somewhat vigorously attacked my views on the Cessation of Selection as a cause of degeneration, and disputed their identity with those of Prof. Weismann on Panmixia. He urged that by Panmixia Weismann meant, not the merely passive *cessation* of selection, but an active *reversal* of it, through Economy of Nutrition, &c.

And he strenuously maintained that a merely passive cessation of selection could not be a cause of degeneration in any degree at all. After a prolonged discussion, however, he allowed that it must be a cause of degeneration to the extent of reducing the previous "survival-mean" to the "birth-mean," but no further. In adopting this view, Prof. Lloyd Morgan estimated that "the amount" of degeneration thus produced "might be set down at 5 per cent. More recently still Mr. Herbert Spencer, in the *Contemporary Review*, took the same points of exception to my Cessation of Selection as Prof. Ray Lankester had originally taken—*i.e.* that it was not the same doctrine as Weismann's Panmixia (the latter being in Mr. Spencer's understanding of it the active reversal of selection due to Economy of Nutrition, &c.), and that it could not be, in any circumstances or in any degree, a cause of degeneration.

Both these points, however, were soon settled, as far as the question of Weismann's opinion was concerned, by his replying to Mr. Spencer that the doctrine of Panmixia was identical with that of the Cessation of Selection, and also that in his opinion the principle was not merely a cause of degeneration, but, as a general rule, the *sole* cause. Moreover, he has repeatedly stated that in his opinion "the amount of degeneration thus produced" is unlimited, so that any organ which has fallen under the influence of Panmixia may, by such influence alone, be reduced to a "vestige," and finally abolished altogether. Thereupon Mr. Spencer, like his predecessors, put the question—What is there in the state of Panmixia that determines a numerical excess of *minus* over *plus* variations, such as must be supposed if the amount of degeneration due to Panmixia alone is to proceed further than the survival-mean falling to the birth-mean? Now this very pertinent question has never been answered by Prof. Weismann. He has simply taken it as self-evident, that when the maintaining influence of selection is withdrawn as regards any organ (owing to the latter having ceased to be useful) atrophy of that organ must ensue in successive generations, and this to an unlimited extent. Therefore I am unable to say what his views upon this important point may be. But in answering Mr. Spencer I gave what my own views have always been with regard to it. I hold that there are at least three very good reasons why, as soon as selection is withdrawn from an organ, the *minus* variations of that organ outnumber the *plus* variations, and therefore that it must dwindle in successive generations. These three reasons are as follows:—

(1) The survival-mean must descend to the birth-mean. This is now on all hands acknowledged. But it will only produce, at the outside, 5 per cent. of dwindling.

(2) Atavism is always at work in our domesticated varieties; and although there is no evidence to show (as is generally assumed) that but for artificial selection this would in time cause any domesticated variety to revert to its wild type, there is abundant evidence to show that the cessation of such selection is soon followed by deterioration of the artificial type—*i.e.* degeneration to a very much greater amount than can be explained by the cause above mentioned (1). And, notwithstanding that atavism in the case of specific characters is less pronounced than it is in that of domesticated varieties (owing presumably to their having been much longer inherited), still we know that even here its occurrence is neither rare nor insignificant. And it seems evident that in whatever degree it does occur in the case of any specific character, in that degree it must determine a preponderance of *minus* over *plus* variations—at any rate through 10 to 20 per cent. of degeneration. So long as the character is of use to its possessor, natural selection will suppress these atavistic (*minus*) variations. But when the character ceases to be of use, natural selection will be withdrawn as regards that character, and the resulting preponderance of *minus* variations due to atavism will lead to degeneration—more slowly, no doubt, than in the case of our domesticated productions, but still, and eventually, to some amount considerably more than that contemplated by the English naturalists who object to the doctrine of Panmixia (1). Hence, it appears to me, these naturalists must have overlooked the necessary presence of this factor under a state of Panmixia—at all events in the earlier stages of degeneration, or before atavism begins to cut both ways.

(3) As long as an organ or structure is under the influence of natural selection, any failures in the perfection of hereditary transmission will be weeded out. But as soon as natural selection ceases with regard to this organ or structure, all such imperfections will be allowed to survive, and, just as in the case of

atavistic variations, will act as a dead weight on the side of degeneration. Be it observed, degeneration may occur either in regard to size (dwindling of bulk) or to structure (disorganisation of machinery); and it is in the latter case that the present cause of degeneration under a state of Panmixia is presumably of most importance. Thus, for example, we can understand why some of the blind crustacea in dark caves should have lost their eyes, while they have not yet lost their eye-stalks. The latter, although of larger bulk than the eyes can have been, are of much less complexity in regard to structure.

These, then, are my reasons for holding that there is no "error" attaching to Weismann's theory of Panmixia as a cause of degeneration, and, so far, no one has attempted to show that there is any error attaching to these reasons. It seems to me desirable that either Mr. Wallace or some of the English naturalists who think with him should now do so, if only for the sake of seeing what Prof. Weismann may have to say upon the whole subject a week or two hence. But I write in no spirit of controversy. I merely ask for information as to what is the "error" into which both he and I are said to have fallen.

There are certain other points of comparative detail connected with the theory of Panmixia as to which, owing to his reticence, I am uncertain whether Prof. Weismann is in agreement with me. But it seems unnecessary to go into them on the present occasion. For they refer to degeneration by Panmixia below 10 to 20 per cent. of dwindling, and the importance of the doctrine lies in the fact of its destroying the direct evidence of the inherited effects of disuse on which Darwin relied in the case of domesticated animals, where, as he showed, there is no Economy of Growth or Reversal of Selection, to account for the 10 to 20 per cent. which their disused organs have undergone. Hence, one can understand why the doctrine should be obnoxious to Lamarckians, but not why such should be the case with those who disbelieve in the transmission of acquired characters. Prof. Weismann may well ask these naturalists what cause, other than Panmixia, they have to suggest whereby to supplant Darwin's explanation of these particular cases of degeneration. GEORGE J. ROMANES.

Hyères, France, April 16.

#### The Late Mr. Pengelly, F.R.S., and the Age of the Bovey Lignite.

HAVING enjoyed the inestimable privilege of the acquaintance, and latterly of the friendship, of the late Mr. Pengelly, for nearly forty years, I ask permission to make a few remarks on Mr. Starkie Gardner's letter on the Bovey beds, which appears in your issue of the 12th inst. (*NATURE*, vol. xlix. p. 554).

From the year 1878 to 1885 Mr. Pengelly published an annual paper in the *Trans. Dev. Assoc.* entitled "Notes on Slips connected with Devonshire." It was a pillory of which the writer stood in wholesome dread, and which by the utmost care he succeeded in escaping. Had Mr. Gardner's letter appeared within the years named, its author would not have been so fortunate.

Mr. Gardner, in lightly attributing one slip to Mr. Pengelly, himself stumbles thrice.

Mr. Gardner, speaking of the Bovey beds, says (for the sake of clearness his remarks are quoted in italics):—

(1) "*They are, however, not lacustrine but fluvialite, consisting of current-bedded coarse grits alternating with lignitic muds.*" Now, according to Pengelly, the beds from the second to twenty-seventh were composed of sand, clay, and lignite; whereas all below the twenty-seventh consisted of clay and lignite only; of these latter beds there were forty-five. Among these occurred not even sand, to say nothing of coarse grits.

(2) "*Neither are they Miocene.*" This caution might lead some of your readers to infer that Mr. Pengelly considered that the beds referred to were Miocene. He, however, carefully avoided defining the horizon of the beds in his paper thereon, his title being, "On the Correlation of the Lignite Formation of Bovey Tracey, Devonshire, with the Hempstead beds of the Isle of Wight."

On this question of age Mr. Pengelly wrote:—"The question it will be seen is simply one of classification. It in no way affects the contemporaneity of the formations which have been spoken of, and which are, all Lower Miocene, or, all Upper Eocene; for they must certainly go together."

(3) "*In determining the age of the deposits, great stress was*

laid on the supposed identity of the *Sequoia coultsii* of Bovey with that of the *Hempstead* beds." (*Hempstead?*) Now in Mr. Pengelly's paper *Sequoia coultsii* occurs in the *Hempstead* list, but so far from special stress being laid on it, it is not referred to again. The correlation is shown not by the evidence of a single species, but by converging lines of argument all bearing on the same point.

"The mistake having been made by such 'heroes of geology' as Heer and Pengelly, is extremely hard to eradicate." The mistake referred to is the recognition of *Sequoia coultsii* at *Hempstead*. If mistake it be, it is one for which Pengelly could not be held responsible, as it was eminently a case in which he could only rely on a specialist in botany. There is, however, no proof that Pengelly made any mistake in correlating the *Hempstead* and *Bovey* beds. What he did was this: suspecting the *Hempstead* beds to be on about the same horizon as *Bovey*, he commissioned Mr. Keeping, who made the excavations at *Bovey*, to collect fossils at *Hempstead*. The evidence of these fossils confirmed Mr. Pengelly in the belief that the *Hempstead* and *Bovey* beds were of the same age, but whether Eocene or Miocene, depended upon where the line of demarcation was to be drawn. This disputed point, about which English and French geologists had long been at issue, did not affect Pengelly's argument, as his object was to show the contemporaneity of *Bovey* and *Hempstead*, not to define the boundary between Eocene and Miocene.

Geologists will await with interest Mr. Starkie Gardner's proofs that the *Bovey* beds are not lacustrine.

Prof. Boyd Dawkins well describes Pengelly as one of the old heroes who laid the foundations of geological science. Pengelly's papers are models of scientific writing, with every fact tested, quotation verified, authority cited, and argument polished, to the utmost of the author's ability.

Two extempore interjections of Pengelly will suffice to reveal the cause of his strength, and his springs of action. On one occasion the present writer, seeking to turn a discussion which was getting wide of the mark, said: "That fact is unimportant." Pengelly instantly broke in with: "No fact is unimportant." On another occasion a member of the Devonshire Association, when on the platform replying on a paper, incautiously used the words "I think." Pengelly at once ejaculated, "We want to hear what Mr. X. *knows*, not what he *thinks*."

Taken seriously these pithy comments lie at the very root of all sound research, and of every paper worth printer's ink, which many are not.

A. R. HUNT.

Torquay, April 14.

#### A Fine Aurora Australis.

ON February 25 one of the finest displays of auroral light seen in Australia for many years took place. It was seen first at Balranald at 8.30 p.m., and latest at Albury at 11.30 p.m., Albury, 190 miles east of Balranald, being the farthest east of reporting stations, and the last display being seen in the east.

At Adelaide Observatory, the farthest west, the latest time given is 10 p.m.: the range in longitude between these places is 8° 30', the point farthest north is Wilcannia, latitude 31° 35', and the farthest south in New South Wales was Deniliquin, 36° 10': it is however, reported to have been seen in Melbourne also. In Sydney it was not visible, the night being very cloudy. At Deniliquin it was first seen at 9.30 p.m., presenting the form of an intense crimson arch from south to south-west, which lasted until nearly 11 p.m., when streamers of crimson and yellow were observed. The highest point reached was 30' above the horizon, and it was partly obscured by black clouds all the time. The postmaster at Balranald, who gives the best account of it, says: "An intensely brilliant aurora began here at 8.30 p.m.; it was by far the most extensive ever seen here. The display commenced at 8.30 p.m. with a dull red flush in the south, which disappeared at 9 p.m. At 9.50 the whole sky from a few degrees east of south to west-north-west, and almost up to the zenith, suddenly flashed into brilliant crimson. At intervals of a few minutes intensely bright steely shafts darted quite up to the zenith, and these changing gradually through phases of yellow to deepest red. At 10.40 p.m. the display trended more to eastward, and terminated with several very remarkable broad streaky and variegated flashes of dazzling brilliance, which shot up from east-south-east about 11.50 p.m."

March 17.

H. C. RUSSELL.

NO. 1278, VOL. 49]

#### Lepidosiren paradoxa.

PROF. HOWES says in NATURE, April 19, that the villi of the pelvic fins of this fish were "referred to" by me in NATURE of April 12. I think it is desirable to correct this inaccuracy. The villi in question were not "referred to" by me, but were described and figured by me on March 20 (published April 12). The description and figures were sent to NATURE a fortnight before the meeting of the Zoological Society at which Dr. Günther exhibited his specimens and mentioned the fact that Prof. Ehlers had "referred to" their existence in a recently published number of the *Göttingen Nachrichten*. I have not yet seen Prof. Ehlers's remarks on the subject. My specimens were purchased from a well-known London dealer; and I know nothing of Dr. Bohl or the "signification of his intentions" as to specimens collected by him.

Prof. Howes is correct in his statement that six specimens of *Lepidosiren paradoxa* have been authoritatively recorded before the appearance of several in the market during the present year; but the arrival of these specimens tends to the conclusion that his statement in NATURE (vol. xxxviii.) to the effect that this species is "rapidly approaching extinction" is due to imagination, and does not correspond with the facts. E. RAY LANKESTER.

Oxford, April 23.

[The communication from Prof. Lankester was received on March 22. Proofs were sent to him on March 31 and April 2. The proofs were returned by him for press on April 6.—ED. NATURE.]

#### Are Birds on the Wing Killed by Lightning?

I CAN answer the question put in NATURE (of April 19) by "Skelfo," not only from several authentic records in my possession, but from personal observation. Many years ago I was standing on the steps of a woollen mill stair (outside) in the village of the Haugh, Ayrshire, in the company of others, some of whom are still alive, watching a terrific thunderstorm over the fields adjoining the river Ayr. What was then familiarly termed "forked lightning" was playing in the valley with great brilliancy. A lurcher puppy dog chased some ducks from behind an old gas-works building. One bird rose in the air, and with the characteristic cry of fright flew over the mill-race in the direction of a corn-field. When on the wing it was struck by lightning and killed "like a shot." I remember examining the dead bird, but do *not* remember if it really "smelt villainously of brimstone." I think not.

G. W. MURDOCHS.

Kendal, Westmorland, April 19.

P.S.—One of the reasons why so few birds are killed by lightning on the wing is because during a thunderstorm they are in shelter, and take to it before the storm comes on.

G. W. M.

#### A Remarkable Meteor.

YESTERDAY evening, Sunday, April 22, a very fine meteor was seen to traverse the sky, from near the zenith to near the horizon, in an easterly or south-easterly direction. It is reported to me as having appeared about 7.25 p.m., when twilight was strong, and before any stars had come out. It threw off sparks like a rocket, and was followed by a bright train. No noise was heard after the explosion.

Haslemere, Surrey, April 23.

R. RUSSELL.

#### AFFORESTATION IN THE BRITISH ISLES.

THE question of extending the woods of the United Kingdom has recently been brought forward in the press, and questions have been asked in Parliament as to the willingness of Government to assist in furthering a scheme for stocking certain of our waste lands with trees. Now, afforestation may be required owing to those indirect advantages it affords to the climate and soil of a country, which have been described in detail by Dr. Schlich,<sup>1</sup> and again quite recently in NATURE, by Dr. Nisbet,<sup>2</sup> or merely to increase the national wealth in

<sup>1</sup> "Manual of Forestry," vol. i. p. 25-58.

<sup>2</sup> "Climatic and National Economic Influence of Forests," NATURE, January 25.

forest produce. In our case, forests are certainly not required merely to reduce the air and soil temperatures, or to increase the atmospheric humidity; they may afford useful shelter against the strong westerly gales, or cutting east winds, and in our more mountainous districts they may assist in preventing denudation of the soil, which on a large scale has proved so destructive to agriculture in the Rhone Valley and other regions, but is not very much to be feared in our islands.

The chief use of forests with us is, therefore, for our timber supply, and to render us more independent than at present of imports of this valuable and bulky material, the inland transport of which is so costly. Our mild moist climate is admirably adapted for producing oak, ash, beech, and other broad-leaved timber, as well as larch, silver fir, Scotch pine and spruce; and were the land stocked with trees whenever experience shows that it cannot be profitably used for agriculture, our wealth would be considerably increased, and so would be the demands for agricultural labour.

Exclusive of an import of £3,000,000 worth of teak, mahogany, and other tropical woods, which we cannot grow ourselves, we also import annually £12,000,000 worth of oak, ash, and coniferous timber, all of which we might grow at home. Dr. Schlich<sup>1</sup> has estimated that if 6,000,000 acres of our waste lands were planted, they would eventually yield sufficient timber to render these latter imports unnecessary. It is even probable that a smaller area would suffice, were the productiveness of our existing woodlands increased by better management.

This extension and improvement of our woodlands is the more urgent, as the forests of Canada, Scandinavia and Russia, from whence most of our timber imports come, are not sufficiently well managed to secure the production of a steady supply of timber for export. The markets for their timber are also extending in France, Italy, the Netherlands, the United States, South Africa, and other insufficiently wooded countries. The following table, comparing the ratio of the woodland area in 1892 of our own and other European countries, with their total area, places us at the bottom of the list:—

| Name of country.            | Area of forests per 1000 acres. | Remarks.                                            |
|-----------------------------|---------------------------------|-----------------------------------------------------|
| Austria-Hungary . . . . .   | 343                             | } Area of forests less by 102,000 acres since 1872. |
| Russia . . . . .            | 342                             |                                                     |
| Germany . . . . .           | 257                             | } Countries importing more timber than they export. |
| Sweden and Norway . . . . . | 250                             |                                                     |
| France . . . . .            | 159                             |                                                     |
| Italy . . . . .             | 145                             |                                                     |
| Belgium . . . . .           | 143                             |                                                     |
| Holland . . . . .           | 72                              |                                                     |
| Denmark . . . . .           | 60                              |                                                     |
| British Isles . . . . .     | 39                              |                                                     |

If our present area of woodlands, 3,000,000 acres, were increased by 6,000,000 acres, as proposed by Dr. Schlich, we should still have only 117 acres of woodland per 1000 acres total area, and should stand between Belgium and Holland on the list.

These 6,000,000 acres would chiefly be taken from our unenclosed mountain and heather land, which, in the agricultural returns for 1892, is given as 12,117,000 acres for Great Britain, figures for Ireland apparently not being available. But as in 1880 there were  $4\frac{1}{2}$  million acres of waste land in Ireland, it is probably within the mark to estimate the total area of unenclosed mountain and heather land for the United Kingdom at 15 million acres.

<sup>1</sup> "Manual of Forestry," vol. i. p. 65.

Much of this land is at present used for pasturing sheep, and leased in the Highlands of Scotland at from one to four shillings an acre, according to quality. Large areas of it are also let as deer forests, the rent being fixed at about £25 for each stag which may be shot; and as 2500 acres will support about 25 deer, five only of which are mature stags, the rent of average deer forests, exclusive of the buildings on them, cannot be more than one shilling an acre. It is the poorer lands at high altitudes, where sheep pasture does not pay, which are generally let as deer forests.

The cost of planting or sowing varies considerably according to circumstances, and is given in Brown's "Forester" (1882) as varying between £3 and £10 an acre, according to the nature of the fencing and draining required, which are the chief items. In calculating the returns from a plantation, the initial cost of planting must be reckoned at 2½ per cent, compound interest up to the date of felling, and this sum deducted from the proceeds of the felling. Any intermediate proceeds from thinnings will of course be added with interest allowed up to the date of the final felling.

Before a landowner would venture to plant his land on a large scale, he would have to answer the following questions:—

Is the land suitable for the successful growth of any particular forest species; and if so, what are these species, and how should they be grown? Will the sale of the timber be more profitable than the present rent of the land? As a rule, most of these rough pasture lands, except in their moister depressions, are only fit for conifers, and in many cases only for Scotch pine. A large part of the area also is at present stocked with game, and although forest growth may be compatible with pheasants, black game, capercaillie, or a moderate number of deer, it certainly cannot be expected to thrive where rabbits abound; so that the value of the land as a game-preserve will also intervene.

Experiments might certainly be made to plant up the extensive tracts in the Midlands and elsewhere, which are now encumbered with shale and slag from abandoned ironworks, and which may be bought for an old song. Ash and maple grow well on heaps of slag in the Ardennes, and these species, and probably some others, might certainly be planted on similar areas in our Black Country. It is true that the cultivation of trees will not prosper within a certain distance from factory chimneys belching out sulphurous and other noxious fumes, but means may be adopted to fix the sulphur within the factory, and to prevent the air from being contaminated; whilst much of the shale and slag is already sufficiently distant from the obnoxious chimneys.

As regards the increased demands which an extended area of woodlands would afford to labour, Dr. Schlich has calculated that if 6,000,000 acres of our waste lands were planted up at the rate of 300,000 acres a year, this would employ annually some 15,000 labourers, and that eventually, once the forests had been grown, about 100,000 labourers would find in them steady employment, besides the large number of hands required by the special forest industries which this large forest area would certainly call into existence.

Such an industry already exists in the chair-making business of Buckinghamshire. The forests on the Chiltern Hills supply thousands of people with beech-wood, 500,000 cubic feet of which are worked up annually into chairs in the town of High Wycombe and the surrounding villages. Some of these beech forests are getting thin and unproductive, owing to excessive felling and other bad management; but wherever a moderate amount of care is taken not to overcut the woods, as much as 20s. an acre per annum is obtained, without any expenses for planting, as the beech reproduces itself naturally. The poor dry soil above the chalk, on which the beech

thrives, would, if the forest were rooted up and the soil limed at considerable expense, only yield a rental of 12s. an acre as farm-land. Evidently here we have a district where forestry is more productive than agriculture, and where planting might be extended; and the same may be said of the large area of heather land above the Bagshot Sands in Surrey, Berkshire, and Hampshire, which might all be stocked with conifers were sensible measures adopted to stop the progress of the annual heath fires.

When it is remembered that we import 70,000 tons of pit-props every year, chiefly from the cluster pine forests near Bordeaux, and that in the Belgian Ardennes, at a distance of 80 miles from the coal mines, 40-year old Scotch pine, used for pit-wood, can be sold standing for £55 per acre, exclusive of the value of thinnings, which would pay for the cost of producing and tending the forests, and this means an annual profit of 16s. an acre, including an allowance for compound interest at 3 per cent., there can be no reason why we should not grow our own pit-props on waste land unsuitable for agriculture.

Many farms on heavy land are at present either going out of cultivation or paying very badly, and as an example of the successful forest treatment of similar land on the London clay, the Princes Coverts, near Esher, in Surrey, may be cited.

Leopold of Saxe Coburg, the consort of our Princess Charlotte, and afterwards King of the Belgians, about seventy years ago united several small woodland areas, by planting up the land of two farms, in which they were situated, with hazel and ash coppice and oak standards. The present extent of the coverts is 868 acres, and their yield, after deducting all costs of management, amounts to at least 16s. an acre per annum, and probably more; but Messrs. Clutton, the agents of the Crown lands, in which these woods are at present included, might supply the correct figures. The coppice is felled every ten years, and yields supports for fruit and ornamental trees, bean- and pea-sticks, clothes-props, kindling fuel, &c., which are largely in demand for gardens, orchards, and laundries around London; while the oaks, which in seventy years attain a girth of about five feet, are readily sold standing at 1s. 6d. and 2s. a cubic foot, according to quality.

Whilst, however, the work of planting up our waste lands must necessarily be chiefly left to private agency, the State should bring the Crown forests into a high state of productiveness, and render them examples of good forest management. Forestry is eminently a practical business, and when a landowner wishes to plant, he should be able to see the ideal way of dealing with different localities on economic principles in our Crown forests. This at present is far from being the case. Very large sums of public money were spent in planting up the Crown forests in 1813-25, when there was a fear of our running short of timber for the Navy. It is true that our Navy now depends on teak and iron, rather than on oak and pine; but oak and pine are still valuable commodities, and the present condition of the Crown plantations, made about seventy-five years ago, is certainly not satisfactory, owing to the want of underwood, and the excessive nature of the thinnings to which they have been subjected. Over an extensive area in the New Forest the Scotch pine mosses have been allowed to out-grow the oaks they were intended to shelter temporarily. The fact is, a forester is wanted at the head of our Crown forests, who will see, among other things, that they are properly underplanted, and that all blanks are restocked; but in order to do this successfully, the rabbits, which now swarm in some of the woods, must be kept down. This was not the case twenty years ago; but their increase of late has been prodigious, and they not only eat every natural seedling which appears, but

also threaten the existence of the older trees by barking them in the winter.

It should be noted that the Crown forests are managed by the State, and their proceeds go into the Treasury, but that the sporting rights in some of them are vested in the Crown. Surely the Royal sportsmen might be contented with a moderate number of rabbits, and with pheasants, which do no injury to the woods, and not require the enormous multiplication of rabbits, which no continental prince would suffer in his forests.

It may be objected that by treating our Crown forests for economic forestry, as is the case with the Crown woodlands in other European countries, we should introduce uniformity, and spoil much of their picturesque-ness. There are, however, 5000 acres in Epping Forest, 4000 in Windsor Park, and extensive tracts in the New Forest, which might be reserved for the lovers of the picturesque, and even then 100,000 acres might be found in the Crown forests which could be made into models of good forest management, which are at present not to be found anywhere in Britain.

W. R. FISHER.

#### NOTES.

IT is stated that the Emperor of Austria has just made a graceful recognition of the important services which the Geological Survey of India has rendered to science, by the presentation of gold medals to the two senior members of the Survey, Dr. W. King and Mr. C. L. Griesbach. Surely for the Emperor of Austria we should read Empress of India.

THE next annual meeting of the Museums Association is to be held in Dublin, beginning on the 26th of June, and lasting four days. Dr. Valentine Ball, C.B., F.R.S., is the President-elect, and a strong local committee has been formed, with Dr. R. F. Scharff and T. H. Longfield as honorary secretaries. There will be a reception of the members on Tuesday, June 26, at the Zoological Gardens, and on the following Thursday an excursion will be made to the Wicklow Mountains. Last year's meeting of the Association in London, under the presidency of Sir William H. Flower, resulted in the accretion of a considerable number of new members, and the Association has now become a strong and successful body.

THE sixty-sixth annual meeting of German scientific and medical men will be held this year at Vienna, from 24th to 30th September. This function is still more all-embracing than the British Association, maintaining as it does the true brotherhood of natural and physical sciences with the branches of medicine. If all accounts be true which we hear of the section work at the recent Medical Congress in Rome, the best-meant efforts at organisation may sometimes fall short of their mark at a very large meeting. But no city knows better than Vienna how to entertain and, at the same time, to keep work going on smoothly. Active preparations have already been begun for the September meeting, and the programme of arrangements will be issued in the beginning of July.

A COMMISSION, nominated by the physical section of the Amsterdam Society for the Advancement of Physics and Medicine, and consisting of Profs. Gunning, van't Hoff, Polak, van Deventer, and Lobry de Bruyn, has made arrangements for the celebration of the centenary of the death of Lavoisier on May 8. Prof. Gunning will deliver a commemorative address, and Dr. van Deventer will describe the apparatus of the Dutch physicist van Marum, by means of which he has repeated the experiments of Lavoisier on combustion. The apparatus, constructed like Lavoisier's, but improved by van Marum, are contained in the museum of Teyler's Society at Harlem. Some of the works, portraits, and letters of the French investigator will also be exhibited at the coming celebration.

AT the end of last week a series of severe earthquake disturbances passed over Greece, causing great destruction of property and loss of life. A sharp shock was felt at Athens about seven o'clock on April 20. It appeared to pass from west to east, and lasted for about half a minute. The shock was also felt throughout the kingdom, though with less severity in the Peloponnesus than in Northern Greece, while Zante and the other Ionian Islands appear to have escaped injury. Thebes was almost completely wrecked by the first disturbance, and a second shock, which took place at six o'clock on Saturday morning, completed the destruction. Shocks were also felt at Athens on Saturday morning, but no very serious casualties have occurred there. The district that has felt the effects of the disturbance most severely is that lying between Thebes, Livadia, Atalanti, and Chalcis. According to the reports, the intensity of the shocks diminished in proportion to the distance from this centre. The villages round Atalanti have suffered terribly, Larymni, Proskina, Malesina, Martino, and Pelli being left in ruins. In the town of Chalcis, also, the earthquake has effected considerable damage. A violent shock was felt there at noon on Sunday, and caused great devastation. There is some uncertainty as to the number of persons killed by the effects of the earthquakes. The official estimate gives the number of lives lost as about 200, but other reports make it as many as 300. Tremors continue to be felt at Athens and other places, but no great shock has been reported since that which visited the districts of Chalcis and Atalanti on Sunday.

THE Royal Geographical Society has awarded its gold medals for the current session to Captain H. Bower, for his remarkable journey across Tibet from west to east, and to M. Elisée Reclus, on the completion of his great work on comparative geography, entitled "Nouvelle Geographie Universelle." The minor awards were given as follows:—The Murchison grant to Captain Joseph Wiggins, for his services in opening up the Kara Sea route to Siberia; the Back grant to Captain H. J. Snow, for his surveys of the Kurile Islands; the Gill Memorial to Mr. J. E. Ferguson, a native of Sierra Leone, for his elucidation of the geography of the Gold Coast interior; and the Cuthbert Peek grant to Dr. J. W. Gregory, in recognition of his journey to Lake Baringo and Mount Kenia. The Duke of York has consented to become Honorary President of the Society. Dr. H. Mohn (Norway), Mr. Frederic Jeppe (Transvaal Republic), and Mr. Justin Winsor (United States) were elected honorary corresponding members.

THE philosophical faculty of the University of Göttingen has offered two prizes—the first of 3400 marks, and the second of 650 marks—for the best investigations of the solubility of mixed crystals. At present this question is of especial interest, as according to van't Hoff's hypothesis a mixed crystal may be regarded as a solution in a solid solvent. By an application of the thermodynamical equations of Willard Gibbs, Roozeboom has also studied the conditions of equilibrium of mixed crystals when in contact with their saturated solutions. These considerations lead to a result which may be stated as follows:—If a substance A form a mixed crystal with another substance, when the mixed crystal is in contact with its saturated solution, the ratio of the concentration of A in the mixed crystal to its concentration in the saturated solution should be the same, no matter what the absolute value of the concentration may be, provided the molecular weight of A in the mixed crystal and in the saturated solution is the same. Measurements of the solubility of mixed crystals will therefore test the validity of the above theoretical views, and may lead to a method of estimating the molecular weights of substances in the solid state. Competitors must send in their results, written in German, Latin,

French, or English, to the Dean of the Faculty by August 31, 1896. The awards are to be announced in March 1897.

THE international character of the Naples Zoological Station shows each year increasingly. Great Britain is at present represented by Mr. Riches for Cambridge, Dr. Günther and Mr. H. Vernon for Oxford, and Mr. Moore for the British Association. Germany maintains two tables, and keeps them both occupied. Among those present at Naples now are Prof. His of Leipzig, Prof. Ludwig of Bonn, Prof. Ewald of Strasburg, Dr. Klaatsch and Baron v. Uexküll of Heidelberg. Austria-Hungary's three tables are occupied by two physiologists of Vienna, Dr. Beer and Dr. Fuchs, and Prof. Klein, botanist, from Buda-Pest. The ten Italian tables are occupied all the year round. Russia has sent Dr. Golenkin, Prof. Ognew, and Miss Perejaslewzewa from Moscow. Switzerland, Holland, and Belgium maintain one table each, and Dr. Staehelin (Basel), Dr. Schmidt (Utrecht), and Prof. Heymans (Ghent) occupy them. It is said that Roumania will join the other nations this spring, taking a table and sending Prof. Sihleanu from Bucharest, and that negotiations are pending with Bulgaria. The contract with Spain will probably be renewed this year; indeed, nearly every State in Europe—France and the Scandinavian kingdoms excepted—is represented at Naples. A striking feature this year is the great number of Americans. Some years ago, no relations having then been established between the Zoological Station and the United States authorities, Major. Alex. H. Davis, of Syracuse, New York, instituted a table for his countrymen, but the demand becoming greater, a movement was set on foot among American naturalists asking the Smithsonian Institute to take a table, while at the same time Prof. Agassiz proposed the like to the authorities of Harvard College. The development of interest in the work is shown by the fact that not only are these tables continuously occupied by Americans, but that Major Davis has again stepped forward to take another to meet the urgent demand, and that Prof. Dohrn has consented to place provisionally one or two others at the disposal of American students who wished to work at the Naples Station this year. It is not improbable that, in the near future, California and Japan, representing respectively the eastern and western shores of the Pacific, may have their delegates working side by side in the famous "Stazione." It may then fairly claim to have girdled the world with the far-reaching influence of its aims and its methods. Of that imitation which is "the sincerest flattery" there has been no lack. Other and excellent stations have come into being; others still are projected, all doubtless, in varying degree, to serve for purposes of use; but as first exemplar, as foremost in equipment, as incomparably richest in its intimacy of association with the chief biologists of our time, and, above all, in its international comprehensiveness and representation, the Naples Station is now, and bids fair long to remain unchallenged, the universal clearing-house of the world's biological science.

THE death is announced of M. G. Salet, of the Paris Sorbonne.

M. GRIMAUD, Professor of Chemistry at the École Polytechnique, has been elected a member of the Paris Academy of Sciences, in the place of the late M. Frémy.

DR. W. A. TILDEN, F.R.S., Professor of Chemistry in the Mason College, Birmingham, has been appointed Dr. T. E. Thorpe's successor at the Royal College of Science.

MR. W. ESSON, F.R.S., has been appointed Deputy Savilian Professor of Geometry at Oxford, the continued illness of Prof. Sylvester having rendered him unable to perform the statutory duties of his office.



THREE research scholarships, each of the value of £250, and open only to British subjects, have been instituted by the Grocers' Company "as an encouragement to the making of exact researches into the causes and prevention of important diseases."

THE University College of Liverpool has a generous friend in Mr. George Holt, who has recently offered £10,000 to the Council for the endowment of a chair of pathology in the Medical School. The only endowed chair hitherto possessed by the school is that of physiology, which was also a gift from Mr. Holt.

THE *Chemist and Druggist* says that the herbarium of the late Isaac C. Martindale, of Philadelphia, comprising over 200,000 different plants and ferns gathered from every country in the world, and valued at ten thousand dollars, has been presented to the Philadelphia College of Pharmacy. The herbarium was bought from the heirs of the late proprietor by Mr. Howard B. French and Messrs. Smith, Kline, and French jointly, and given to the College by these gentlemen.

THE agricultural correspondent of the *Times* points out that the appointment of an official agrostologist to the Department of Agriculture at Washington is an event of exceptional interest, for it involves a recognition of the primary importance of the grasses in the rural economy of the nation. The duties of the United States agrostologist will include the identification of grasses and the investigation of forage plants, the preparation of monographs on grasses, and the conduct of various inquiries into grasses and forage plants. The gentleman who has been selected to fill the post is Prof. Frank L. Scribner. He has already filled the position of chief of the section of vegetable pathology in the Agricultural Department at Washington, and has recently been Director of the Tennessee Agricultural Experiment Station.

THE recent operations in Epping Forest have given rise to a large amount of correspondence in the daily papers, all the writers, with one or two exceptions, being opposed to the thinning of the timber and to the other improvements being effected by the Conservators. The Epping Forest Committee of the Corporation of London have so far met the public view of their proceedings as to promise that further operations shall be suspended till a select committee of experts have gone over the ground and reported upon the matter. Without prejudicing the decision of this committee, it may fairly be stated that the newspaper correspondents have given a most exaggerated account of the number of trees felled. In the meantime, the Essex Field Club has convened a meeting for Saturday, April 28, to examine the districts under discussion, and to give an opportunity for the ventilation of the whole question of the Forest management. The meeting will be conducted by the verderers, Sir T. Fowell Buxton and Mr. E. N. Buxton, Prof. Meldola, F.R.S., who as first president of the Club has in these columns expressed his views on the question (vol. xxvii. p. 447), and Prof. C. Stewart, the President of the Linnean Society. Mr. Angus D. Webster, a well-known expert in forest matters, who is now manager of woods to the Duke of Bedford, will be present at the meeting, and many other authorities are expected to take part in the proceedings.

THE Romanes lecture for 1894 will be delivered by Prof. Weismann, at the Sheldonian Theatre, Oxford, on Wednesday, May 2, at 2.15 p.m.

DR. JOHN HOPKINSON, F.R.S., will deliver the "James Forrest" lecture at the Institution of Civil Engineers, on Thursday, May 3, at 8 p.m., his subject being "The Relation of Mathematics to Engineering."

A COURSE of five lectures on "Geographical Distribution" will be delivered by Mr. F. E. Beddard, F.R.S., in the Lecture Room in the Zoological Society's Gardens, Regent's Park, on Saturdays at 4 p.m., commencing Saturday, May 19.

ON Thursday, May 3, Prof. Dewar will deliver the first of a course of lectures at the Royal Institution, on "The Solid and Liquid States of Matter"; on Saturday, May 5, Captain Abney delivers the first of the Tyndall Lectures on "Colour Vision," and on Tuesday, May 1, Prof. Judd begins a course of lectures on "Rubies."

DURING the present term, Prof. Clifton is lecturing at Oxford on the optical properties of crystals; Messrs. W. W. Fisher and Watts on inorganic and organic chemistry respectively; Prof. A. H. Green on field geology and applied geology; Prof. Ray Lankester on the Mammalia; Prof. Burdon Sanderson on the special senses; and Prof. Vines continues his advanced course in botany. Dr. Tylor lectures on the races of mankind, as classified by language, civilisation, and history; and Mr. H. Balfour on the progress in the arts of mankind, particularly as illustrated by the Pitt-Rivers collection. Numerous supplementary lectures by demonstrators and others are announced in all the departments.

THE programme of the meeting of the Iron and Steel Institute, to be held at the Institution of Civil Engineers on May 2 and 3, has been issued. Mr. Windsor Richards will preside and deliver an address. Prof. J. O. Arnold will read a paper on the "Physical Influence of certain Elements upon Iron"; Mr. William Hawdon will describe a new departure in the construction of blast furnaces; and Mr. Jeremiah Head will point out the growing importance of Scandinavia as a source of iron ore supply. Mr. D. Selby-Bigge will discuss the uses of electricity in the way of replacing steam and other motors in the iron and steel industries. Mr. G. J. Snelus will explain a new French process—a Bessemer process on a small scale. A paper on the relations between the chemical constitution and ultimate strength of steel will be read by Mr. W. R. Webster; and Mr. J. E. Stead and Mr. H. K. Bamber will speak, the former on the microscopic examination of iron and steel, and the latter on the analysis of steel.

*La Nature* credits Mr. J. Lancaster, an American ornithologist, with the assertion that he has seen frigate-birds flying continuously for seven days. According to his observations, the birds do not get fatigued even after staying such a long time in the air; in fact, not only can the frigate-bird maintain itself in the air almost without moving its wings, but it can travel with a velocity of 160 kilometres per hour with very little exertion. Though the albatross has usually a greater breadth of wing than the frigate-bird, it can only sustain itself in the air four or five days.

THE Roman villa at Llantwit-Major has been described, and the remains figured, by General Pitt-Rivers. In the *Western Mail* of Monday last, Mr. John Storrer says that he has visited a Roman villa at Ely, near Cardiff, and found that the wall plaster is painted with exactly the same patterns as that of the villa at Llantwit. There is other evidence that both villas were erected by the same workmen. Mr. Storrer also found relics not only of the pre-historic village, but of palæolithic man, thus indicating that the district examined may have been a settlement of man continuously from the time of the palæolithic men of the river gravels, then the marsh dwellers, then the Romans, and that it was only deserted when the present village of Ely took its rise probably during the early Norman period.

THE fourth trip of H.M.S. *Jackal*, for physical observations in the northern part of the North Sea, takes place next week,

completing the quarterly observations for one year undertaken by the Fishery Board for Scotland, in association with the researches simultaneously carried out by Prof. Krümmel of Kiel, and Prof. Pettersson of Stockholm. Mr. H. N. Dickson has had charge of the observations at sea, and will present a comprehensive report to the Fishery Board in the course of this year. While the trip of August 1893 was very successful, those of November 1893 and February 1894 were unfortunate as regards weather, the *Jackal* encountering the full force of the two most violent storms of the winter on these occasions, and being thus unable to complete the full programme of work.

IN consequence of the break-down of the proposed expedition (under Dr. Stein) to Ellesmere Land, efforts are being made in this country and in Sweden to ensure that an adequate search is made by whalers, or by a special expedition, for the missing Swedish naturalists, Björling and Kalstennius, and the Newfoundlanders who were in their company. It will be remembered that the young Swedes set out from St. John's, in 1892, in a small schooner, the *Ripple*, the wreck of which was discovered last summer on the Carey Islands. The survivors intended to make for the Eskimo settlement on Ellesmere Land, where they hoped to be rescued. It is just possible that they may survive, and prompt action is needed to make up for the time lost in trusting to the intentions of the American expedition. Mr. Clements R. Markham has opened a subscription list at the Royal Geographical Society, 1, Savile Row, where a considerable sum has already been received.

THE expedition of the German Cameroons Government, under Baron von Uechtritz, to delimit the Hinterland of the Cameroons has, according to a private letter of its scientific member, Dr. Passarge, published in Dr. Danckelman's *Mittheilungen*, had more than a political object. It proceeded up the Benue to Yola, and after being well received by the Sultan, left for the east, and reached Garua in the autumn of last year, where, in company with the French mission, the boundary line between French and German territory was settled, and access to Lake Chad from the south behind the Cameroons insured to the French Congo territory east of the Shari. Dr. Passarge has made the most complete geological survey of the Benue that has yet been attempted, and his observations throw much light on the geology of the Western Sudan generally.

THE May number of the *Geographical Journal* announces two new expeditions into Africa of more than ordinary scientific interest. Dr. Donaldson Smith, an American traveller who has already had some experience in Somaliland, is to make another effort to force a way from the north coast of Somaliland to the Lake Rudolph region. The expedition will probably start in May. Mr. R. T. Coryndon, well known as a hunter and collector in South Africa, is on his way, *via* the Cape and Lakes Nyasa and Tanganyika, to the eastern edge of the great Congo forest, where he intends to make a permanent camp, from which natural history collecting may be carried on for a year or more. Both explorers are trained in the use of surveying instruments, and if all goes well, the results obtained cannot fail to be of the greatest interest and value.

A SERIES of long, nearly parallel lakes, lying in Central New York State, has been investigated by Mr. Ralph S. Tarr (*Bull. Geol. Soc. Amer.* vol. v. pp. 339-356, 1894). Several of these lakes, known as Finger lakes, and notably lakes Cayuga and Seneca, are extremely long compared with their width. With the exception of one or two minute ones, they all drain northwards and eventually enter Lake Ontario through the Oswego or through the Genesee river. Mr. Tarr gives reasons

for believing that "Lake Cayuga, and presumably other of the Finger lakes, is situated in a rock-basin with a maximum depth of approximately 435 feet. The nature of the proof is that the pre-glacial tributaries to this valley are found to be rock-enclosed, and that their lowest points are above the present lake surface." There appear to be various reasons why a rock-basin should be constructed with comparative ease in the region discussed. Mr. Tarr finds that the course of the pre-glacial Cayuga was northward, and probably tributary to a river which drained at least one of the great lakes, Ontario. And as the tributaries of Cayuga river seem to prove the rock-basin origin of Lake Cayuga, it is argued that the Cayuga river tributary to the Ontario stream indicates that Lake Ontario is also a rock-basin.

KIRCHHOFF'S law connecting the absorptive and emissive powers of substances has been tested for glass by G. B. Rizzo, who has communicated his results to the *Accademia di Torino*. Kirchhoff's law states that any substance absorbs those rays which it is capable of emitting at the same temperature, and that the emissive and absorptive powers are, under similar conditions, numerically proportional. The glass tested had been coloured blue by means of oxide of cobalt. It was heated to a red heat in a Bunsen flame, and placed in front of the slit of a spectroscope in which a bolometer was substituted for the telescope. The absorptive power was measured by comparing the intensity of the continuous spectrum given out by an Auer lamp with that of the absorption spectrum due to the glass, and the emissive power was determined by noting the effect of the spectrum of the hot glass alone upon the bolometer. The results show that while the emissive power decreases nearly uniformly between the wave-lengths 685 and 580, the absorptive power shows decided maxima in the red, yellow, and green, which show no relation whatever to the emissive power. It must therefore be concluded that Kirchhoff's law does not hold good for this and similar cases.

AT a recent meeting of the *Accademia dei Lincei*, Prof. Riccò drew attention to the difference of time between the seismometer records of Zante and Catania during the first four months of last year, and communicated some important conclusions regarding the mode of propagation of earthquake shocks between the two places. The distance between the stations is 515 km. (320 miles), and the difference in time between the four earthquake shocks originating at Zante ranged from 4 min. 20 sec. to 7 min. 30 sec., and gave a mean velocity of 1439 m. per second. This velocity, curiously enough, nearly coincides with the velocity of sound in water. This means that the shock was not propagated along the bottom of the Ionian Sea—in which case it would have travelled with a speed of something between 2000 and 4000 m. per second—but was transmitted by the water to Sicily. The circumstance that no shock was propagated through the ground, Prof. Riccò attributes to the probability that the ground to the east of the Etna district is discontinuous and much broken up.

IN a paper communicated to the R. Accademia delle Scienze dell'Istituto di Bologna, Prof. Augusto Righi gives a description of a very sensitive idiostatic electrometer which he has constructed. The essential part of the instrument consists of a thin aluminium disc about 9 c.m. in diameter, having a hole 1 c.m. in diameter at the centre, and also two sector-shaped windows. A light aluminium needle, of the usual shape employed in quadrant electrometers, is suspended above this disc by a bifilar suspension, and carries a thin platinum wire which dips into a vessel containing sulphuric acid. Two metal discs, pierced with central holes, are placed one above the needle, and the other below the disc with the windows. These two discs are generally placed in metallic connection with the conducting case which surrounds the instrument, and they form one plate of a con-

denser, the other consisting of the middle disc and the needle. If a difference of potential exists between these two systems of conductors, then the needle will be deflected, the deflection being approximately proportional to the square of the difference of potential. The sensitiveness of the instrument can be varied by altering the distance between the upper and lower discs and the middle one, or by placing the lower disc in metallic communication with the needle and middle disc, instead of having it connected with the upper disc. With a scale at a distance of five metres a deflection of one millimetre corresponds to 0.14 volts. On account of the deflection being proportional to the square of the difference of potential the sensitiveness increases with the deflection, so that when the instrument is employed in measuring a difference of potential of three volts, one millimetre of the scale corresponds to a change of potential of 0.0033 volts.

IN No. 7 of the pamphlets which the Physical Laboratory of the University of Leyden is issuing under the direction of Prof. Kamerlingh Onnes, there is an interesting paper by Dr. L. H. Siertsema on the magnetic rotatory dispersion of oxygen. In most substances the magnetic rotatory dispersion approximately, at any rate, follows the law that governs natural rotation, viz. that the rotation varies inversely as the square of the wavelength. In strongly magnetic bodies, such as solutions of iron salts, the dispersion is much greater; according to Becquerel the rotation being proportional to the fourth power of the wavelength. Oxygen seems to be an exception, for while Becquerel thought he obtained a small dispersion, more recently Kundt and Röntgen obtained no dispersion. The arrangement of the apparatus employed by the author resembles that used by Kundt and Röntgen. The gas under high pressure is enclosed with a polariser and analyser in a long tube, and the rotation is obtained by fixing one end of the tube and turning the other, so that torsion is given to the tube. The tube lies in a long magnetising coil containing 3600 turns, and through which a current of 70 amperes is passed. Some preliminary experiments, made with commercial oxygen at a pressure of about 100 atmospheres, have shown that, contrary to the result given by Becquerel, Verdet's constant for oxygen decreases regularly with increasing wave-lengths, and that for violet it is twice as large as for red.

At a recent meeting of the Kaiserliche Akademie der Wissenschaften of Vienna, Prof. Klemencic read a paper on the magnetisation of iron and nickel wires by rapid electrical oscillations. From the amount of heat developed in a wire of a magnetic material traversed by electrical oscillations the author calculates, by means of the formula given by Lord Rayleigh and Stefan, the value of  $\mu$  (the permeability). The heat developed in the wire under observation was determined by means of a thermoelectric couple, and was compared with the heat developed in a non-magnetic wire under similar circumstances. The following are some of the values obtained for  $\mu$ :—Soft iron 118; steel wire, soft 106, hard 115; Bessemer steel, soft 77, hard 74; nickel 27. These values agree very well with those obtained by Lord Rayleigh and Bauer for very feeble magnetising forces. The results obtained by these observers show that for certain values of the magnetising force the permeability is constant, and that it afterwards rapidly increases. Now the results obtained by the author show that over the range he is employing  $\mu$  has a constant value. This fact may be explained either by supposing that the magnetising forces employed are so small that we are dealing with that part of the curve where  $\mu$  is constant, or that, although the magnetising forces are much greater than those to which the former supposition limits us, the magnetisation is unable to follow the rapid changes in the magnetising force, so that the magneti-

sation never reaches that part of the curve where  $\mu$  is variable and has very much greater values. A rough estimation has shown that, at least on the surface of the wire and at the commencement of the oscillations, the magnetising force exceeds more than a hundredfold the maximum limit within which  $\mu$  is constant. Thus in these experiments there must exist a time lag in the magnetisation which must not be confused with the hysteresis. It would also appear that Bauer and Lord Rayleigh's results which refer to longitudinal magnetisation, also apply to circular magnetisation.

THAT it is easy to find microbes in the soil capable of assimilating atmospheric nitrogen, if culture media devoid of all combined nitrogen are employed, was pointed out by M. Winogradsky last summer, and in a recent number of the *Comptes Rendus* an account is given of important progress made by him in this most interesting subject. By progressive cultivation of a mixture of microbes derived from soil, in a nutritive liquid from which all traces of combined nitrogen were carefully excluded, Winogradsky reduced the varieties present to three bacilli, of which one was finally separated out and discovered to be endowed with this function of assimilating atmospheric nitrogen. This organism is strictly anaerobic, and will not grow in either broth or gelatine. It ferments glucose, producing butyric, acetic, and carbonic acid, and hydrogen. The amount of atmospheric nitrogen assimilated is proportional to the quantity of glucose contained in the culture material, and which undergoes decomposition in the presence of this bacillus. Winogradsky concludes his paper by suggesting that this phenomenon of the fixation of atmospheric nitrogen may be due to the union within the living protoplasm of the microbial cell, of atmospheric nitrogen and nascent hydrogen, resulting in the synthesis of ammonia.

A CATALOGUE of second-hand books, including many rare and scarce volumes on scientific matters, has been issued by Messrs. E. George and Son, Booksellers, Whitechapel Road.

A REPORT upon the work of the City and Guilds of London Institute during 1893 has just been issued, and it affords satisfactory evidence of the advance of technical education, both in London and the provinces. A fact well worth recording is that the Salters' Company have recently offered to found, in connection with the Institute, a studentship or fellowship of the annual value of £150, to be awarded for the encouragement of higher research in chemistry in its relation to manufactures. A scheme of regulations for the award and tenure of this studentship is being drawn up, and the Council of the Institute hope that the action of the Company may result in increased cultivation of original research, and a consequent important advance in the application of chemistry to manufacturing industries. The report shows that the withdrawal of payment on the results of examinations in technology at centres outside the metropolis has had little or no effect in diminishing the number of candidates presenting themselves. It is pointed out that this is partly due to the pecuniary assistance which County Councils are now able to give for the furtherance of technical education, and partly to the recognised value of the certificates granted by the Institute in connection with these examinations.

WE have received a copy of Luke Howard's treatise "On the Modifications of the Clouds" (London, 1803), which has been issued by Dr. G. Hellmann as No. 3 of the reprints of important and rare works relating to meteorology and terrestrial magnetism. The first edition of this work is very scarce. The paper was first presented to the Askesian Society in the winter of 1802-3, and printed in vols. xvi. and xvii. of the *Philosophical Magazine*. It was the first successful attempt at cloud nomenclature, and up to the present time has formed the

basis of all classifications. Many attempts of improving it have from time to time been made, but the problem of obtaining a more perfect nomenclature still remains, to a great extent, unsolved. When such an accomplished bibliographer as Dr. Hellmann undertakes the reproduction of a work, we may be sure that he will tell us all that can be known about it, and few persons can read his introductory remarks without learning something. Comparatively few copies appear to have been reprinted from the *Philosophical Magazine*, and Dr. Hellmann points out that the first part of the text was set up afresh, as some of the lines do not exactly agree; also, that some small omissions were made in the separate copies of 1803 which have been added to this new edition. In 1832 a second edition was issued without plates; but in 1849 L. Howard appears to have drawn a new set of cloud pictures, and these, although not considered to be equal to the first, were included in the third edition, published in 1865. Many other details of great interest are given by Dr. Hellmann, to which we cannot now refer. We may mention that the plates only are actual *facsimiles*, while the type of the text is as nearly as possible like that of the original work.

THE additions to the Zoological Society's Gardens during the past week include a Slow Loris (*Nycticebus tardigradus*) from Malacca, presented by Captain Spalding; two Sooty Mangabeys (*Cercocebus fuliginosus*, ♀ ♀), an African Civet Cat (*Viverra civetta*), two Royal Pythons (*Python regius*) from West Africa, presented by the Rev. Canon J. Taylor Smith; two Crested Porcupines (*Hystrix cristata*) from South Africa, presented by Mr. Adrian Vander Byl; a Water Vole (*Arvicola amphibius*) British, presented by Colonel L'Estrange; a Buzzard (*Buteo vulgaris*) British, presented by Colonel C. B. Rashleigh; a Raven (*Corvus corax*) British, presented by Miss P. L. Graham; two Pin-tailed Sand Grouse (*Pterocles alchata*, ♂ ♀) South European, a Black Gallinule (*Limnocorax niger*) from East Africa, two — Moorhens (*Gallinula* sp. inc.) from Madagascar, presented by Mr. H. H. Sharland; four Swainson's Francolins (*Francolinus swainsoni*), a Delalande's Lizard (*Nucras delalandii*), a Rough-keeled Snake (*Dasypeltis scabra*) from South Africa, presented by Mr. J. E. Matcham; a Chimpanzee (*Anthropopithecus troglodytes*, ♂) from West Africa, a Lioness (*Felis leo*) from India, deposited; a Chimpanzee (*Anthropopithecus troglodytes*, ♀) from West Africa, a White-backed Trumpeter (*Psoiphia leucoptera*), a Short-tailed Parrot (*Pachyus brachyurus*) from the Upper Amazons, a Blackish Sternothere (*Sternotherus subniger*) from Madagascar, purchased; two Barbary Wild Sheep (*Ovis tragelaphus*, ♀ ♀) born in the Gardens.

#### OUR ASTRONOMICAL COLUMN.

FOUR NEW VARIABLE STARS.—Prof. E. C. Pickering announces (*Astr. Nach.* 3225) that four new variable stars have been discovered by Mrs. Fleming from the presence of bright hydrogen lines in photographs of their spectra taken in connection with the Henry Draper Memorial. The first of these is a star in the constellation Sculptor, having the co-ordinates R.A. oh. 10<sup>h</sup> 4m. Decl. - 32° 36'. The range of variability of this star is from magnitude 6.5 or 6.6 to 10.0, and the period 366 days. The second star is Arg-Oeltz 16121, in Scorpius, its exact position being R.A. 16h. 50<sup>m</sup> 3m. Decl. - 30° 26'. The range of variability is from 7.3 to 11.6 magnitude, and the period is 278 days. The star B.D. = 1° 3417, in the constellation Ophiuchus (R.A. 17h. 14<sup>m</sup> 5m. Decl. + 1° 37') is the third of the variables discovered, the range in this case being from magnitude 8.5 to 12.5, and the period 348.4 days. The fourth star is B.D. + 4° 4250, in the constellation Aquila (R.A. 19h. 46<sup>m</sup> 5m. Decl. + 4° 13'). Its period is about a year, and at the last maximum on August 12, 1893, its photographic magnitude was 9.5. At a minimum it becomes fainter than the twelfth magnitude.

SPEED OF PERCEPTION OF STARS.—When working at the Etna Observatory during a high wind, Prof. Riccò noticed how the pole star and its companion appeared to change their mutual distance at every vibration of the telescope. The phenomenon was not observed on the following night, which was calm, but could be reproduced by shaking the telescope. The pole star appeared in every case to move more rapidly than its companion. This observation has been communicated to the *Società degli Spettroscopisti Italiani*, and connected with Prof. Schaeberle's investigation of the difference of personal equation between bright and faint stars observed in transit. Schaeberle estimated the apparent retardation of faint stars at 0.02 sec. per magnitude. Prof. Riccò proposes to redetermine this by measurements of stellar distances by the micrometer as compared with the transit instrument. That the colour may have a determining influence is shown by the fact that when a spectrum is displaced rapidly at right angles to its length, the more refrangible portions appear to lag behind.

ELEMENTS AND EPIHEMERIS OF GALE'S COMET (b 1894).—The following elements and ephemeris are given in a supplement to *Astronomische Nachrichten*, No. 3225:—

T = 1894 April 13<sup>h</sup> 75 G. M. T.

$$\begin{aligned} \omega &= 324 \ 19 \\ \Omega &= 206 \ 15 \\ i &= 87 \ 15 \\ q &= 0.9849 \end{aligned} \left. \begin{array}{l} \\ \\ \\ \end{array} \right\} \text{Mean Eq. 1894.0.}$$

Ephemeris for Greenwich Midnight.

| 1894.        | R.A.       | P.D.   |
|--------------|------------|--------|
| April 26 ... | 101 38 ... | 124 23 |
| 30 ...       | 115 22 ... | 109 31 |

The comet is increasing in brightness, and on April 30 it will be 6.05 times brighter than at the time of discovery.

A MISTAKEN COMETARY DISCOVERY.—From a note by Prof. Krueger in *Astronomische Nachrichten*, No. 3224, it appears that the object seen by Mr. Holmes on April 9, and afterwards announced as a new comet, is really the nebula No. 6503 in the New General Catalogue.

#### THE INSTITUTION OF MECHANICAL ENGINEERS.

THE meeting of the Institution of Mechanical Engineers was held last week in the theatre of the Institution of Civil Engineers, on Thursday and Friday evenings, April 19 and 20. The chair was taken by the President, Prof. Alexander B. W. Kennedy, F.R.S. Two papers were read at the meeting: the first, "On the Grafton High Speed Engine," by Mr. E. W. Anderson; and the second, "On Fluid Pressure Reversing Gear," by Mr. David Joy. The President's address was, however, the chief feature of the meeting, and to this we shall mainly confine our report, more especially as it would be difficult to give an adequate description of the mechanical devices upon which the two papers were founded without somewhat elaborate illustrations.

After the usual formal proceedings, Prof. Kennedy read his address. It had been expected that in consequence of the leading part the President has recently taken in the development of electrical engineering that the address would deal largely with that subject, and in this respect the result proved to be in accordance with general expectation. The address pointed out that practical electrical problems divided themselves into three main sections, in which electrical energy is used, respectively: firstly, for lighting; secondly, for power; and thirdly, for physico-chemical processes. The third section, which relates to the deposition of metals, the reduction of chemical compounds, &c., was one in which the President had not had experience, but he had no doubt that there was a great future before it. In this section he also included the application of electricity to heating, and said it was to be hoped that there being so many competent workers engaged in the study of this subject, success would soon attend their efforts. The commercial problem of producing the heat sufficiently cheaply to allow of its general use was yet to be overcome. Remembering, however, that something like 95 per cent. of all the energy that goes to incandescent lamps appears only as heat and not as light, there would seem to be an ample opening here for another "thermal storage"

process. The use of electrical energy for power, *i.e.* for transformation into mechanical energy, is, the President pointed out, a matter which lies obviously in the closest possible communication with mechanical engineering. He divided this branch of the subject into three sections, namely: (1) Transmission from a distance for whatever purpose; (2) transmission to a number of isolated points pretty near together, as the tools in a factory; (3) transmission for the purpose of traction on railways or tramways. Transmission comes in in every case, because we have as yet no electric prime mover analogous to a steam engine. With regard to transmission of power from a distance, the President said that Prof. Unwin had so fully and ably dealt with the matter recently, that it was unnecessary for him to go over the same ground again. The question of driving tools in a factory by electric motors instead of through counter shafting, is one which has recently come to the front. The carrying out of such work is obviously purely a matter of mechanical engineering. Prof. Kennedy had been at pains to collect information in regard to practical work bearing on this subject. In any given factory running on the ordinary system there is a large continuous waste of power due to the running of the whole shafting, no matter how many or how few machines are at work. The President gave the following figures as the approximate distribution of total work:—

|                                                                                                                                                                     | H.P.  |
|---------------------------------------------------------------------------------------------------------------------------------------------------------------------|-------|
| Average useful work ... ..                                                                                                                                          | 100   |
| Waste in belts and shafting ... ..                                                                                                                                  | 25    |
| Waste in engine friction, the engine being supposed large enough to give 150 horse-power at tools as a maximum (at about 10 per cent. of maximum horse-power) .. .. | 20    |
|                                                                                                                                                                     | <hr/> |
|                                                                                                                                                                     | 145   |

On the other hand, if all machines in a similar case were driven by separate motors, each having an electrical efficiency of 88 per cent., and these motors worked from a dynamo having an efficiency of 92 per cent. (both of which are high figures for ordinary work at two-thirds of the output), the figures would stand as follows:—

|                                         | H.P.  |
|-----------------------------------------|-------|
| Average useful work ... ..              | 100   |
| Waste in motors and dynamo ... ..       | 24    |
| Waste in leads (say 2 per cent.) ... .. | 2     |
| Waste in engine friction ... ..         | 20    |
|                                         | <hr/> |
|                                         | 146   |

The two sets of figures it will be seen are practically the same, and the President pointed out that the electrical efficiencies which he had assumed were not likely to be exceeded. It is not, however, the really absolute saving so much as the proportionate saving which should be considered. It is little use to show an engineer that he can make even 20 per cent. saving in one item of expenditure, if that item only represents 3 or 4 per cent. of his costs, and if at the same time he has to expend a considerable amount of capital in making the change. One does not make important and expensive changes, especially changes whose results are by no means very certainly predicted to bring about an estimated saving of one-half of 1 per cent. to 1 per cent. in one's total expenditure. There are, however, other points to be considered, such as the practical convenience of getting rid of the huge mass of shafting gear and belting which fills up the upper half of many engineers' shops, and also that a properly arranged motor may give a much larger range of speed to each tool, than can be readily obtained in the ordinary way. On the other hand, the President pointed out that the cost of dynamo, leads, and motors is very greatly in excess of the cost of shafting in almost every case. It is hardly certain as yet, he said, how the costs of attendance, lubrication, renewals and repairs to the electrical plant, compare with the similar costs in the case of shafts and belting; probably, he said, on the whole they would be less.

The difficulty which besets the electrical engineer, of unequal demand for energy, was dwelt upon in the address. As is sufficiently well known, the demand for lighting energy varies enormously throughout the twenty-four hours, so that a plant which is giving 2500 horse-power for a couple of hours every day, will only be giving an average of 350 horse-power for the whole week, and not even half this for many hours every day and night. If it could be arranged that during the time of light

load for lighting purposes, the plant could be used for power purposes, then electrical energy might be sold at a low price. This, however, is not possible, the electrical station must be prepared for any demand, and in case of fog, for instance, lights might be required when the factories were at work; the plant would therefore have to be designed to supply both demands. Electric transmission of power has, however, this advantage over belts and shafting, that when the machinery is not at work there are no losses in the motors; whereas, whilst shafts are being run and belts are at work there is loss through friction.

Prof. Kennedy, in referring to the driving of trains or tram-cars by electric power, said that conditions were by no means so favourable as were sometimes supposed. The ordinary engine exerted about 80 per cent. of the gross indicated horse-power in pulling its load along the line. In an electric railway there was a somewhat lighter locomotive to be moved, but against this advantage, and the fact that a stationary engine can have a greater economy than a locomotive, was to be placed the fact that only about 35 per cent. of the indicated horse-power is available for useful work for pulling a train, the loss of course being the number of transformations through which the energy has to pass. In reference to this part of the question the following figures were given:—

|                                                | Per cent. |
|------------------------------------------------|-----------|
| Mechanical efficiency of engine ... ..         | 85        |
| Efficiency of belt driving, if employed ... .. | 94        |
| Efficiency of dynamos ... ..                   | 90        |
| Efficiency of line ... ..                      | 85        |
| Efficiency of motors... ..                     | 85        |
| Efficiency of gearing of motors ... ..         | 75        |
|                                                | <hr/>     |
| Total efficiency ... ..                        | 39        |

From this would be deducted the power required for driving the locomotive, leaving 35 per cent. for pulling the train. In spite of this great drawback of loss of power, some conditions rendered electrical traction absolutely necessary. In the public streets there is the great mechanical difficulty of getting the current to the motors on the cars. In America overhead wires are used, and in country places, the President said, this is possibly the best solution of the problem; but in cities he considered it to be impossible, and that the introduction of electricity for car driving in this country will still wait for a practical underground system to be devised. In the meanwhile, electricity is being hard pressed by its rivals, cable and compressed gas, Prof. Kennedy thinking the latter far the more formidable. It has the advantage of being even more direct than a steam engine, and it can be applied to each individual car even more easily than an electric motor, and it enables the car to run freely on ordinary lines without their reconstruction and without any mains either above or below ground. It has had but a short trial, but what the President had seen of it made him sanguine as to its ultimate possibilities. Prof. Kennedy also referred to the Serpollet boiler and engine, which he wondered had not been introduced for tram work. The Serpollet machinery takes so little space that it might very possibly be put on the car itself, but he supposed some difficulty had been found in the application; at any rate, the proposal had not been made, so far as he knew. We may mention that a number of road carriages, propelled by the Serpollet boiler and engine, have been in use for some time past in Paris.

The address next dwelt at some length on the question of security in running, in efficiency of regulation, and economy of work. In regard to the former the President pointed out the necessity of duplication of plant in order to provide against breakdown of engines or dynamos, and the difficulty of starting boilers with rapidity supposing a sudden call to be made for additional steam. In regard to security in connection with mains, he referred to Mr. Bailey's looped main system. In speaking upon the question of economy, Prof. Kennedy said that in an electric light station the cost of coal averages not far from four-tenths of the total of working expenses. He did not know of any one type of boiler which was better than all others under the conditions of an electric light station; in fact, he said there were five or six types equally good. One thing which tells very much against the economy of electric light stations is that fires must be kept alight and pressures maintained in boilers capable of giving eight or ten times the actual output; added to this is the extent to which in all stations fuel must be expended in getting boilers ready for the heavy load

which comes on only once in twenty-four hours. Prof. Kennedy found that the total stand-by losses can be reduced in some cases to 8 per cent. of the total fuel; below this he had not yet succeeded in going, and he thought it was often considerably more than 10 per cent. He was of opinion that the greater waste of fuel occurred beyond the boilers, as it is more easy to get a good evaporation per pound of coal than a small consumption of water per indicated horse-power. Heavy causes of loss are by the condensation in steam pipes and by leakage. These are probably greater in electric light stations than in most other places, because security requires the use of a very elaborate system of steam pipes. Of steam traps Prof. Kennedy has not much that is favourable to say; he refers to them as the "apparatus which we call by courtesy steam traps," and says they require more looking after than the whole of the rest of the machinery put together. He thought also that sufficient attention is not paid to the proper covering of the pipes, including their flanges. He thought the use of super-heated steam might be found very largely to reduce this particular cause of waste. The cost of oil, water, and stores he puts down as averaging about one-fifth the cost of coal alone. Discussing the losses between the indicated horse-power developed and the records of the consumers' metres, the President said that the loss in the engine itself might be taken as about 10 per cent. of the full power of the engine, and remained very nearly constant at all powers so long as the speed was constant. The efficiency of the dynamo at full load might be as much as 95 per cent., so that the ratio of electrical indicated horse-power of a first-class steam-engine and dynamo might be 85 per cent. at full load, whilst at half load it would be about 76 per cent. This was assuming that the engine drove the dynamo direct, and he considered that direct driving with equal running engines was the proper method of proceeding. The losses between the dynamo terminals and the consumers' lamps in a low tension system are simply losses in the leads; in a high tension system they cover the losses in general, which are much smaller in the leads and in the transformers as well. Prof. Kennedy did not consider it desirable, however, to enter into a discussion on the respective merits of the two systems, but stated that as far as the figures to which he had access were concerned, he found that in the case of a low tension system where the maximum proportion of loss in the feeders is allowed to reach 20 per cent. or thereabouts, the actual average loss of energy throughout the whole year amounts to about 10 per cent. This was of course entirely due to ohmic resistance of the feeders themselves and of the network. He had no corresponding figures for the alternating current system, but he had reason to believe the total losses both in mains and transformers in the high tension system are not less than 25 per cent. the energy generated, but he thought it certain that this figure will be very considerably reduced in cases where banked transformers are employed with low tension distributing mains. In any case, however, he hardly thought that it could be expected that the total losses would ever be so low as with the low tension system.

In conclusion Prof. Kennedy referred to the ease and accuracy with which electrical measurements may be made with continuous currents, a fact which he thought had helped very much in the extremely rapid progress made during the last few years in matters electrical. In the case of the Westminster Electric Supply Corporation, the unaccounted for quantity as between the energy developed at the dynamo terminals and the readings of the metres of consumers has been reduced to 1.8 per cent. Unfortunately alternating current measurements are much more difficult and troublesome, and Prof. Kennedy thought that the fact had, to a certain extent, hindered their adoption. There were, however, he considered alternating current watt-metres practically free from error due to circuit induction and capable of giving results with quite sufficient accuracy under the actual conditions of station practice. He believed that very great improvements in the economy of alternating current working will date in every case from the time when the station commences to make accurate determinations of the true energy generated and the way in which it has been expended.

At the conclusion of the address a vote of thanks was proposed by Sir Frederick Bramwell, as the Senior Past President, and seconded by Dr. William Anderson, the Junior Past President. It was carried by acclamation, and responded to by Prof. Kennedy in a short speech.

The next business was the reading of a paper by Mr. Edward W. Anderson, of Erith, in which was described the Grafton

high speed steam-engine. The design of this novel engine was illustrated by many large cartoons hung upon the wall of the theatre. As we have said, without the aid of illustrations we can only hope to give a general idea of the design of this engine. It consists, firstly, of a foundation casting, the engine being of the vertical type. Upon this casting is erected a second, forming a standard and also a cover for the whole mechanism, the engine being of the enclosed type and the crank shaft running in an oil bath, upon the system common with single-acting engines of this type. The upper casting has a cylinder formed in it by means of two loose liners, one placed in from each end till the liners nearly meet; the space thus left between them forms the admission port, and, as its width is the circumference of the cylinder bore, its length is only required to be very small in order to get a large area of opening. Communication with the steam pipe is effected through an external annular channel in the casting directly surrounding the space between the two liners or admission port. At a little distance from the steam port the upper liner has a circle of holes drilled through it, which holes open into a similar external annular channel connected with the exhaust branch. The liners are open at both their ends, forming a cylinder, without covers, in which two cast-iron pistons reciprocate. The lower of these is an ordinary trunk piston and has a connecting-rod attached working upon the centre throw of the crank shaft below. The upper piston serves both for a piston and for a valve. It is essentially a short cylinder having a strong diaphragm across the middle of its length, and just below the diaphragm a circle of holes is cut through the rim of the piston, and these holes communicate, therefore, with the space between the two pistons. The diaphragm in the upper piston has a hemispherical recess; this receives the steel ball attached to the crosshead. The latter spans the cylinder and acts on the two outer throws of the crank shaft by means of a return connecting rod attached to each end. The advantages claimed for this engine are:—That the waste spaces to be filled by steam are reduced to a minimum, as the steam is cut off close to the bore of the cylinder, and the long steam passages between the cylinder and the slide valve are done away with; the weight of the piston and that of the piston-valve, instead of being wholly unbalanced, act in the same line and for the most part in opposite directions so as nearly to balance each other, the result being that the unbalanced moment is small. The valve, instead of having a moving part that is idle as regards the transmission of power, performs the same function as an ordinary piston in rotating the crank shaft. The friction of the valve is also no greater than that of an ordinary piston valve of the same dimensions and stroke. The engine described was single-acting and non-compound, but the author said there was no reason why a combination of engines ranged side by side should not be made to work compound if desired. An experiment carried out on a 12-inch engine, working with an initial pressure of 100 lbs. per square inch at  $60\frac{1}{2}$  revolutions per minute, indicating a mean of 36.77 horse-power, gave a consumption of 28.2 lbs. of feed water per indicated horse-power per hour.

A discussion followed the reading of the paper. The general opinion appeared to be that the invention was one of great ingenuity, but no fresh points of importance were brought forward.

Mr. Joy, in his paper, dealt with the hydraulic reversing gear, which he described in his paper read before the recent meeting of the Institution of Naval Architects, and which we referred to in our report of that meeting in our issue of March 22.

The summer meeting will be held in Manchester during the first week in August.

#### WHAT ARE ZOOLOGICAL REGIONS?<sup>1</sup>

THE subject which I now propose to discuss, is the purport and use, and therefore the essential nature, of what are termed zoological regions. This seems necessary because, although such regions have been more or less generally adopted for more than thirty years, there has of late grown up a conception as to their nature and purport which seems to me to be altogether erroneous, and which, if generally adopted, is calcu-

<sup>1</sup> A paper read at the 500th meeting of the Cambridge Natural Science Club, March 12, by Dr. A. R. Wallace, F.R.S.

lated to lead to confusion, and to minimise, if not to destroy, whatever advantages may be derived from their use.

The time has therefore come when this question must be discussed and, if possible, settled, and, in the hope of leading to such a settlement, I propose to point out what seem to me to be the essential characteristics of such regions, considering them to be established for the purpose of facilitating the study of geographical distribution as one phase of the problem of evolution. In order to come at once to the question at issue, I will first summarise the statements or assumptions which seem to me to imply a misconception of the nature and uses of zoological regions. These fall under two heads:—

(1) It is asserted that the same regions will not answer to show the distribution of all groups of land animals. Some of the classes, or orders, or sometimes even the families, require us to establish different sets of regions—regions which may differ both as to their number and their limits—in order to represent and study the distribution of such groups.

(2) As a guide to what constitutes a region, it is laid down that areas which have few peculiarities in the higher groups—such as families, even though of continental extent, rich and varied in genera and species, and having a large number of peculiar types, are not of regional status. The criterion of a region is said to be the exclusive possession of peculiar groups of higher rank than genera; and this without any regard to proportionate area, or to the poverty and monotony of the fauna as a whole.

Now the first of these assumptions—that the same set of regions will not serve for the study of the distribution of all animals—raises the whole question of the nature and practical utility of zoological regions, and is a proposition which the chief purpose of this article is to disprove: it must therefore be considered in some detail.

In the first place, it implies that the students of any particular group—reptiles, beetles, butterflies, land shells, &c.—should each mark out the globe into regions exhibiting the chief features of the distribution of its families, genera, and species, and that any other division, arrived at by the study of other groups, will be of little or no use to them. But if this is true, it must be carried further; for not only do the various classes and orders of animals differ considerably in their distribution, but many of the tribes and families. To take the case of the mammalia, which, for distributional study, has always been treated as a whole, how different is the distribution of the Edentata from that of the Ungulata. In the former group South America is so rich that it is of more importance than all the rest of the globe, while in the latter it is so poor that even when joined with North America it would hardly equal either of the other continental regions in importance. But if we constructed a set of regions to correspond with the distribution of each of these orders, we should not bring out the facts more clearly than can be done by means of the regions most usually adopted for the whole class, while we should lose the advantage of easy comparison with each other, and with the remaining orders of the class, as well as with other classes of animals. But comparative distribution is the one essential feature of our study, without facilities for which the bare facts are uninteresting and of hardly any scientific value.

This point has been very clearly brought out in the case of birds, in a work specially devoted to the geographical distribution of one family—the plovers. These birds are, as a whole, cosmopolitan, so much so that Mr. Seebohm tells us “they have not even a remote connection” with the usually adopted zoological regions; and he adds: “These birds only recognise three regions—Arctic, Temperate, and Tropical.” Again, after describing the distribution of the chief genera during the breeding season, he says: “The inevitable conclusion is that the Charadriadæ do pay considerable attention to the climatic or isothermal regions, but appear practically to ignore the Sclaterian regions.”

These very positive statements would lead a reader to conclude that here, at all events, the regions established by Dr. Sclater for birds as a whole are of no use. Yet we find that in the great work above referred to—the “Geographical Distribution of the Charadriadæ”—Mr. Seebohm rarely uses these three climatal regions, but throughout the book gives the distribution of the species of each genus in terms of the six Sclaterian regions. And if we consider the habits of these birds, so many of which get their food on sea-shores and tidal estuaries, while all of them have great powers of flight, and many of them

migrate along the coasts of all the continents, it is really surprising to find so many of the genera and species which are nevertheless strictly limited to certain of the Sclaterian regions. Owing, no doubt, to the peculiarities of habit just referred to, about half the genera are cosmopolitan, being found in all the six regions during some part of the year; but, even of these, certain groups of species are often confined to one or two regions.

When we turn to the non-cosmopolitan genera, however, we find some very instructive facts, which well serve to illustrate my main contention as to the sufficiency of one set of regions. The following table gives the distribution of these genera, taken from Mr. Seebohm's volume:—

|                                                          |                                                                                  |
|----------------------------------------------------------|----------------------------------------------------------------------------------|
| <i>Edicnemus</i> (Stone Curlews)                         | All regions except the Nearctic.                                                 |
| <i>Lobivanellus</i> (Wattled Lapwings) ... ..            | All regions except the Nearctic and Neotropical.                                 |
| <i>Vanellus</i> (Lapwings) ... ..                        | All regions except the Nearctic and Australian.                                  |
| <i>Cursorius</i> (Coursers) ... ..                       | Palæarctic, Oriental, and Ethiopian regions.                                     |
| <i>Glareola</i> (Pratincoles) ... ..                     | All regions except the Nearctic and Neotropical.                                 |
| <i>Ibidorhynchus</i> (Ibis-billed Oyster-catcher) ... .. | Palæarctic only.                                                                 |
| <i>Phalaropus</i> (Phalaropes) ... ..                    | Palæarctic and Nearctic, migrating or straggling into most of the other regions. |
| <i>Limosa</i> (Godwits) ... ..                           | All regions except the Ethiopian.                                                |
| <i>Ereunetes</i> (Snipe-billed Sandpipers) ... ..        | Palæarctic and Nearctic.                                                         |
| <i>Phegornis</i> (Short-winged Sandpipers) ... ..        | Australian and Neotropical                                                       |
| <i>Rhynchæa</i> (Painted Snipes) ...                     | The four Tropical regions.                                                       |

Now we have here to notice two points:

(1) That in most of these genera not only are they absent from one or more of the Sclaterian regions and present in others, but in the regions where they do occur they are usually widely dispersed, thus showing that their range is defined and limited by the very same barriers which so well mark out the general range of land birds.

(2) We also find that the use of the old-established and widely accepted six regions of Dr. Sclater, enables us very clearly and concisely to describe or to tabulate the comparative distribution of the genera and species of this great family of wading birds, which have been thought to be such erratic wanderers that the author of a work devoted to them declares that—“the zoological regions of Sclater have nothing whatever to do” with them.

Now this case of the plovers is perhaps as strong as any that can be brought to prove that different groups require different sets of regions; and it at once brings us to the question at issue, which is, whether anything would be gained by establishing a set of Charadriine regions. The climatic regions—which Mr. Seebohm suggests as more natural in this case—would not bring out such facts as the absence of *Edicnemus* from the Nearctic and of *Limosa* from the Ethiopian regions; the limitation of *Glareola* to the eastern hemisphere, and of *Phegornis* to the Australian and Neotropical regions, unless the Sclaterian regions were also used as sub-regions—thus introducing complication in place of simplicity, and gaining, so far as I can see, no advantage whatever.

But further, if the plovers are to have their own regions and sub-regions, there are probably 50 or 100 of the orders and families of the animal kingdom which would equally require to be so treated; and as in all these cases the new regions must have separate names, it is quite clear that by far the larger part of them would remain for ever unknown, except to their inventors.

A little consideration will, I think, convince us that this plan, of practically unlimited distinct sets of regions, would be a positive hindrance to any intelligent study of the distribution of animals, a study which derives its chief interest and importance from its relation to the theory of organic evolution, and which must therefore include the comparative distribution of the various classes, orders, and minor groups. But how will it be possible to make the necessary comparison if the distribution of the groups to be compared is given in terms of as many distinct

sets of regions all differing in their names and in their boundaries? It would be like comparing the structures of different animals as described in the works of a number of anatomists each of whom had a different classification and a different set of technical terms, so that before a single comparison could be made the terms used in one description would have to be translated into the terms used in the other. In the study of geographical distribution, should this system prevail, the student would find it necessary to adopt some one set of regions for his own use, and then endeavour to translate the facts given by each specialist into terms of that set before he could obtain any clear conception or accurate knowledge of their comparative distribution.

An idea seems to be prevalent among biologists that there is some law of distribution, that may differ for different groups, and that may require different regions to exhibit it or to conform to it. This, however, is a mere supposition; but, if it is a correct one, we shall certainly not be likely to discover the "law" by recording the facts of distribution in such a way as to render a comparative study of them as difficult as possible. Laws of distribution can only be arrived at by comparative study of the different groups of animals, and for this study we require a common system of regions and a common nomenclature.

It appears to me, however, that the "law," or at all events the general principles on which the diversities of distribution among land animals depend, is already fairly well understood. What we require is to be able to work out the details in the different groups, and thus explain certain difficulties or anomalies. To detect anomalies it is essential to compare the distribution of the different groups by means of a common system of regions. If we construct regions to fit each group, the student of each separate group will be apt to forget that it presents any anomalies which require explanation.

Before leaving this part of the subject it may be well to give a short account of the reasons which led to the original establishment of the six Scattered regions for the purpose of facilitating the study of the geographical distribution of animals: in order to show that they are not arbitrary divisions, but are founded on a large body of observations. It is evident, in the first place, that many of the ordinary divisions of the geographer serve well to define the areas characterised by special groups of animals or plants. The South European, the Malayan, the Brazilian, or the South African faunas and floras, are constantly referred to, because those districts are really characterised by distinct assemblages of animals and plants, and this undoubtedly depends partly on their possessing peculiarities of climate resulting in peculiarities of vegetation—as forest, prairie, desert, or woodland; partly in their being limited by more or less effective barriers, climatic or geographical; and partly on their past geological history and on the more recent changes of physical geography they have undergone. But such areas as these are too small and too numerous to enable us to express the broader features of the distribution of animals, and the larger or primary geographical divisions—which were those used by the older naturalists—are often unsuitable and misleading, because they are not coincident in their boundaries with those more permanent natural barriers which have mainly determined the zoological specialities of different parts of the globe. Yet some of the divisions of the geographer are such well-defined and ancient areas that they do nearly coincide with characteristic assemblages of animals; and thus the geographical units, Europe, Asia, Africa, North America, South America, and Australia, can be easily modified into six zoological regions, which do represent with considerable accuracy the broad features of animal distribution. These modifications may be briefly enumerated in order to show how the limits of the regions have been arrived at.

Beginning with Europe, we see at once that it is zoologically homogeneous, since a large proportion of the species and all the larger genera range over the whole of it. But the same genera, in the case of the higher animals, at all events, prevail in North Africa, mingled only with a few desert types, and we therefore, for zoological purposes, add this area to Europe. It is interesting to note that we have a clear explanation of this identity, in the proofs that quite recently—that is, during the Pleistocene period—Europe and North Africa were connected both at Gibraltar, and from Sicily and Malta to Tripoli, as indicated both by submarine banks which still unite them, and by the fossil hippopotami and elephants of the Maltese, Sicilian, and Gibraltar caverns. But further, if

we go eastward from Europe into Siberia and Central Asia, we find the same genera and many of the same species of mammals and birds ranging all the way to the shores of the Pacific. To such an extent is this the case that about fifty-six species of British passerine birds range to Central and North-East Asia, while no less than fifty-three species (or representative subspecies) of land-birds are common to Great Britain and Japan. Europe and North Asia are therefore parts of one zoological region, the reason being that there is not, nor has been in recent geological times, any effective barrier between them, while in climate they are sufficiently alike.

Here, then, we have roughly marked out our first great zoological region—the Palearctic, or northern old-world region. Southward its limits are undefined, and where there are no well-marked barriers, such as the Himalayas or the desert, there will always be a greater or less width of border-land between two conterminous regions.

Now this Palearctic region is, fortunately, the only one that differs very largely from the ordinary geographical quarters or divisions of the globe. For when we go to Africa we find that, leaving out the northern portion, which we have seen to be essentially European, the remainder constitutes a very distinct and compact area zoologically—the land of giraffes, zebras, hippopotami, baboons, and antelopes—which has been termed the Ethiopian region. Then we have southern or tropical Asia, together with the larger Malay Islands, which we know must recently have formed a part of it, constituting the Indian or Oriental region, and corresponding almost exactly with tropical Asia. Then we come to Australia, which forms the nucleus of another well-marked region, including with it, however, most of the Pacific Islands, with New Guinea and the Moluccas. Turning now to the western hemisphere, we have South America and North America, which, with slight modifications, form two well-defined regions—the Neotropical, including all South America with the tropical portion of North America and the West Indian Islands; the Nearctic, comprising the remainder of North America.

Now, I do not think that any one has denied that these are truly natural divisions of the earth from a broad zoological point of view. The controversy respecting them has turned wholly on whether they are of equal rank. This point, however, will be referred to later on. We are now dealing with the question of the need of other modes of dividing the earth's surface in order to exhibit and to study the distribution of certain groups of animals. I have already urged that to do so would defeat the very object aimed at, and render the study of geographical distribution very much more difficult. I have shown how readily the Scattered regions enable us to describe or tabulate the distribution even of a group which has been said to "pay no attention to them whatever"; and I have now just pointed out that these six regions are, admittedly, natural, which can only be because during the more recent geological periods they have formed single more or less continuous areas, while separated either by geographical, climatal, or biological barriers from the adjacent areas.

Now the only real interest of the study of geographical distribution lies in its giving us a clue to the causes which have brought about the very divergent and often conflicting distribution of the various species, genera and higher groups, and by thus being able to explain most of the anomalies of distribution. These causes we can trace, in many cases, either to geographical or climatal changes in the past, which temporarily removed the barriers that now exist or interposed others that are now absent: or, on the other hand, to the recent extinction of groups in certain regions where they formerly abounded; or, again, to the very different powers of dispersal possessed by different organisms, which enable some groups to spread easily where others are stopped by an insurmountable barrier. Now it is usually this last phenomenon, of varying powers of dispersal, that has led the students of certain groups to urge that the old-established regions do not serve their purpose. But when a group can more or less easily traverse the barrier between two regions, however permanent that barrier may be, the fact enables us to explain the exceptional distribution of that group, but it does not render the established regions less natural, or require a fresh set of regions, which would certainly not be natural in any broad sense, to explain them.

Again, it will usually, perhaps always, be found that even in the groups appealed to as requiring a new set of regions, a portion of the species, and even of the genera, are limited to the



older regions. I have already shown that this is the case with the almost cosmopolitan plovers, and it also occurs in another instance where it has been very strongly urged that the Sclaterian regions will not apply. I allude to the distribution of insects in the Oriental and Australian portions of the Malay Archipelago. Here, in the case of birds and mammals, there is a most abrupt and striking change on passing from Borneo and Java to the Moluccas and New Guinea; but in insects this is not conspicuously the case, and it has been said that the whole Archipelago, from Sumatra to New Guinea, and even to the Solomon Islands, is characterised by one uniform insect-fauna. This, however, is by no means a correct statement. There are undoubtedly many genera common to the whole Archipelago, as might be expected from the great similarity of climate and the uniformly forest-clad nature of the islands, together with the power of crossing narrow seas possessed by all winged insects. Yet, both among butterflies and beetles, especially the latter, there are a considerable number of genera confined respectively to the Indo-Malayan and Austro-Malayan divisions of the Archipelago, giving to the fauna of each a characteristic facies.

Now if we adopt for insects, as has been proposed, a single Malayan region including the whole of the Archipelago, we should be apt to lose sight of the two distinct elements it contains, the one due to an ancestral diversity corresponding to that which still exists in all the higher animals, the other dependent on a comparatively recent process of intermigration between the two portions of what are fundamentally distinct insect faunas: while it is not clear what corresponding advantage would be obtained by the student of geographical distribution.

From the point of view I have now endeavoured to set forth, we may, I think, draw the conclusion that the six Sclaterian regions are natural zoological divisions, because they are separated by barriers of considerable antiquity and permanence, which have led to their being characterised each by well-marked assemblages of the higher animals. Further, when groups of organisms which from their exceptional powers of dispersal, or from any other cause, have been able to extend themselves beyond these barriers, that is no reason whatever for establishing new regions—which would *not* be marked out by equally important barriers—since the divergencies in the distribution of the various classes or orders, as exhibited by means of a common series of regions, is one of those interesting problems of distribution which can only be solved by comparative study. Not only, therefore, is one set of regions all that is required to exhibit the distribution of the various terrestrial organisms: but, for all purposes of comparative study it is immeasurably superior to the establishment of numerous sets of special regions, constructed so as to accord with the distribution of special animal groups.

We now come to the second objection—the supposed inequality of the six Sclaterian regions. Some of them are said to be really only sub-regions, while others are said to be so diverse as to be rendered more equal if divided into two regions.

This question of equality is decided almost exclusively by one characteristic, and one that seems to me to be not the most important for the purpose we have in view. This character is the possession of peculiar groups of the rank of family or order, taking no account either of the richness and variety of life-development, or of the geographical extent of the area in question. From this point of view Australia is sometimes said to be equal to all the rest of the world, both on account of its rich development of the marsupial order, but especially because in the duck-bill and spiny ant-eater it possesses a distinct subclass of mammals. From another point of view, however, Australia, Africa, and South America are united in one primary region, because they alone possess one of the sub-classes of birds—the *Ratitæ*.

New Zealand and Madagascar have each been proposed as regions, the first on account of its Apteryx and moas, with its isolated lizard-like Hatteria; the second for its peculiar families of Lemurs and Insectivora, and equally peculiar families and genera of birds. In contrast with these, we have the proposal to unite the rich and extensive Palearctic and Nearctic regions to form one region only, because they do not possess a sufficient number of peculiar families and genera of mammals and birds, although the new region thus constituted is perhaps twenty times as rich as New Zealand in varied forms of life.

Those who adopt these views appear to me to attach a very exaggerated importance to the possession by a limited area of some remnant of an otherwise extinct group, which has been preserved owing to its long-continued isolation in a district where it has been secure from the competition of higher forms—almost always, therefore, in an island. Such survivals are exceedingly interesting; but I cannot see what they have to do with the division of the whole land-area of the globe into zoological regions, whose sole purport and use is to facilitate the study of the geographical distribution of all land animals.

The conception of zoological regions expressed in the views I am now combating seems to me to be altogether erroneous, and to lead to results which are neither useful nor instructive, and far less natural than that which takes account of a variety of characters as the best guides to an approximate equality. I urge, therefore, that zoological regions, to be at once natural and useful in the highest degree, must be founded on a combination of essential features, as follows:—

(1) They should be founded upon, and approximate to, the great primary geographical divisions of the earth, which there is reason to believe have been permanent during considerable geological periods.

(2) They should be rich and varied in *all* the main types of animal life.

(3) They should possess great individuality; whether exhibited by the *possession* of numerous peculiar species, genera, or families, or by the entire *absence* of genera or families which are abundant and widespread in some of the adjacent regions.

Tested by these conditions the six Sclaterian regions seem all that can be desired—subject of course to modification in details. If we make some allowance for the inevitable poverty of the temperate as compared with the tropical regions—due both to present and to past conditions of climate—they present a greater amount of equality than might be expected. The Neotropical region is somewhat the richest—very much the richest in birds and insects—and this may be traced to its possessing so enormous an area of tropical forest-clad land, together with the greatest of the mountain ranges situated wholly within the tropics—the Andes, and two other isolated mountain groups of great extent and antiquity in Brazil and Guiana; while the Nearctic is the poorest—due perhaps to its rather limited area, its large extent of arid lands, but more especially to its extreme climate, a severe winter prevailing to considerably south of the parallel of 40° N. Latitude.

The subdivisions of the primary regions is far less important; and with the same facts before them, naturalists arrive at different conclusions. I would suggest, therefore, that for the present, at all events, no definite named subdivisions should be attempted, but that the continental portion of each region be subdivided by the use of the terms north, south, east, west, and central, with their combinations where required. By the use of these terms the range of a genus or species within the regions may be defined with sufficient accuracy, and in a manner at once intelligible to every student.

The conclusions to which this discussion has led us may now be briefly summarised as follows: Zoological regions are those primary divisions of the earth's surface of approximately continental extent, which are characterised by distinct assemblages of animal types. Though strictly natural, in the sense already pointed out, they have no absolute character as equal independent existences, since they may have been different in past ages, but are more or less conventional, being established solely for the purpose of facilitating the study of the existing geographical distribution of animals in its bearing on the theory of evolution. There is thus, in my opinion, no question of who is *right* and who is *wrong* in the naming and grouping of these regions, or of determining what are the *true* primary regions. All proposed regions are, from some points of view, natural, but the whole question of their grouping and nomenclature is one of convenience and of utility in relation to the object aimed at.

It is because I think that the future progress of a branch of biological study in which I take great interest will depend on our arriving at some uniformity of view as to this question of zoological regions, that I have devoted so much space to its discussion.

FURTHER LIGHT UPON THE NATURE OF  
THE BENZENE NUCLEUS.

AN important memoir, containing an admirable compendium of the data now accumulated bearing upon the much-discussed question of the nature of the fundamental hydrocarbon of the aromatic compounds, together with the results of new spectrometric observations of great value, is contributed to the current issue of the *Journal für praktische Chemie*, by Prof. J. W. Brühl, of Heidelberg. The main question now at issue is whether benzene is best represented by the well-known structural formula of Kekulé,

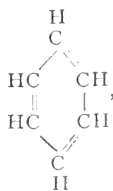

in which the carbon atoms are linked together by alternate double and single linkages, or by a formula in which there are no double linkages, and each carbon atom is attached to three others, the three extra linkages being diagonal,

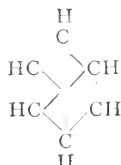

a view which has latterly received some support at the hands of Prof. von Baeyer. A full discussion of the valuable experimental work of the latter chemist is given, together with the thermochemical work of Thomsen, Dieffenbach, Horstmann and Stohmann.

Prof. Brühl has recently determined the specific gravities and optical constants of the three compounds benzene dihydride  $\text{C}_6\text{H}_8$ , benzene tetrahydride  $\text{C}_6\text{H}_{10}$ , and benzene hexahydride  $\text{C}_6\text{H}_{12}$ , the two former of which were prepared some time ago by Prof. von Baeyer, together with those of hexylene. There have now been fully investigated as regards the spectrometric constants eight compounds which are so closely related as to enable most important deductions to be derived from their comparison. These compounds are: benzene itself  $\text{C}_6\text{H}_6$ , benzene dihydride  $\text{C}_6\text{H}_8$ , benzene tetrahydride  $\text{C}_6\text{H}_{10}$ , benzene hexahydride  $\text{C}_6\text{H}_{12}$ , hexane  $\text{C}_6\text{H}_{14}$ , hexylene  $\text{C}_6\text{H}_{12}$ , diallyl  $\text{C}_6\text{H}_{10}$ , and dipropargyl  $\text{C}_6\text{H}_6$ . The second, third, and fourth are the graduated products of the addition of hydrogen to benzene, two atoms at a time; the fifth, hexane, is the open chain six carbon paraffin, hexylene the six carbon olefine with one double linkage, diallyl the six carbon fatty compound containing two double linkages, and dipropargyl the six carbon compound containing two acetylene triple linkages.

Upon comparing the specific gravities at  $20^\circ$  of these eight compounds it is observed that the density steadily decreases from benzene to benzene hexahydride; there is then a sudden large fall upon the disruption of the ring and formation of the open chain compound hexane. The density then slightly increases through hexylene and diallyl, and again a sudden break of continuity, a large rise, occurs upon the passage to the acetylene derivative dipropargyl. Still more striking are the changes exhibited by the molecular volumes. There is an exceptionally large rise of twenty-three units between benzene hexahydride and hexane, and a similar large decrease between diallyl and dipropargyl. Passing to the molecular refraction, it is observed that upon the graduated addition of hydrogen to benzene, this constant becomes gradually larger as far as the hexahydride, then there is a great leap upon the breaking of the ring and production of hexane. Similarly as the hydrogen is again removed step by step a continuous decrease occurs until diallyl is reached, when upon removal of  $2\text{H}_2$  and formation of dipropargyl, the two ethylene groups being changed into acetylene radicles, the molecular refraction falls precipitately.

The whole of these physical properties thus exhibit a break of continuity on passing from benzene hexahydride to hexane, that is upon the opening of the ring into a straight

chain, and also when the ethylene derivatives are converted into derivatives of acetylene. Moreover, if the isomers among these eight compounds are compared, benzene with dipropargyl, benzene tetrahydride with diallyl, and benzene hexahydride with hexylene, it is found that the physical constants differ very materially. From these considerations Prof. Brühl concludes that the Kekulé structural formula is most in accordance with the facts.

In addition to the above new observations, the spectrometric constants of the ethyl ester of phthalic acid have been determined. Prof. von Baeyer considered that he had proved that phthalic acid cannot be constituted according to Kekulé's conception of the aromatic nucleus, but that a nucleus with three diagonal single linkages must be present. Upon comparing, however, the observed molecular refraction and dispersion of the ethyl ester with the values for these constants calculated upon the assumptions of the two hypotheses, they are found to correspond closely with those demanded by the Kekulé structural formula, and are very far removed from those calculated upon the basis of three diagonal linkages.

Prof. Brühl considers it to be well founded that in benzene tetrahydride and in hexylene there is one ethylenic double linkage, and that in benzene dihydride and in diallyl there are two such linkages. Now the continuity in the entire physical properties as hydrogen is removed step by step from hexane to diallyl on the one hand, and from benzene hexahydride to benzene itself upon the other, points conclusively to a continuity in the nature of the alteration of the constitution in both series. Benzene must therefore, according to Prof. Brühl, likewise contain ethylenic double linkages, three in number, if benzene dihydride contains two such linkages and the tetrahydride one. The view that three effective diagonal linkages, or, as has recently been surmised by certain chemists, three central potential linkages, can bring about in benzene the same physical action as three ethylenic bonds, appears to Prof. Brühl to be out of the question. He shows, moreover, that the values for the whole of the eight substances agree most remarkably with the numbers calculated upon the basis of the Kekulé formula, and further, that the thermodynamical data all point to the same conclusion.

The relation of the atoms to one another in the benzene nucleus is not, however, ideally expressed by Kekulé's structural formula. This can only be achieved by a spacial representation. The happiest conception of the spacial configuration of benzene, according to Prof. Brühl, is that of Sachse. This model is constructed by taking a cardboard octahedron, removing two parallel sides, and upon each of the six remaining ones placing a regular tetrahedron. The six tetrahedra represent the six carbon atoms, and the hydrogen atoms are supposed to be attached at the six apices. The six carbon atoms then lie in two parallel planes, as do likewise the six hydrogen atoms. The properties of such an arrangement would be such as accord with the observed facts. The gradual addition of hydrogen would cause a regular and continuous movement of the tetrahedra, corresponding with the observed continuity in physical properties. The best representation of this model in one plane is the structural formula of Kekulé.

A. E. TUTTON.

THE FACE OF THE EARTH.<sup>1</sup>

AT the present time we all acknowledge the value of the accepted classification of the relief-forms of the earth's surface in continents and islands, mountain chains, plateaus, plains, &c.; into ocean-basins, seas, lakes, and the like. But few of us ask ourselves the very natural questions, "What is the fundamental unit among all these morphological individuals, great and small? Is there any surface unit existent among them which, like the species of the biologist, once identified, will not only be found to group its individuals rank over rank into the genera, the families, the orders, and the kingdoms of the surface world; but the study of whose life-history and necessary interactions with its fellow-species will eventually afford us some clue to the relationships and the natural classification of the whole?"

This aspect of the subject perhaps excepted, there is probably no theory possible upon the matter of the grouping of the forms of the earth's surface which has not, either as a whole or in part,

<sup>1</sup>A paper read by Prof. Chas. Lapworth, F.R.S., at the Royal Geographical Society, on April 23.

been already suggested by one investigator or another. In the speculative parts of the subject, the names of Werner, Hutton, De Beaumont, Humboldt, Guyot, Lyell, and Peschel stand conspicuous amongst past investigators; and, among those of the present day, Le Conte, Dana, Crosby, Dutton, and Gilbert in America; Heim, Suess, Penck, and Reyer in Germany; Réclus, De Lapparent, and Bertrand in France; and the Geikies, Wallace, Murray, Fisher, Reade, and Mill in Britain.

Turning first to the general disposition of the recognisable parts of the terraqueous surface of the globe, the author passed in review a few of the fundamental facts and conclusions worked out by students of the subject, and showed that it had long since been acknowledged that between all the grander forms of the earth's surface there existed a curious correspondence of shape and of size, combined with a mysterious contrast of geographical arrangements or disposition. Next it was discovered that among the minor elements of surface form, the study of geographical homologies showed us that all the recognisable forms of a higher order discernible upon the earth's surface are made up of a kind of rhythmic repetition of forms of a lower order possessing in miniature the characteristics of the major forms. These conclusions had been practically arrived at by the students of the relief of the globe previous to the recent discoveries of the *Challenger* and other exploring expeditions, but the result of these deep-sea researches were so strange and so unexpected as almost to dwarf, for the time, these earlier ideas into insignificance.

Deep-sea researches showed that former ideas of the similarity of size and form between the surfaces of the land and water areas as such must be relinquished. For the mean height of the land was found to be only one-sixth of the mean depth of the ocean; and the entire volume of the solid lands above the level of the sea was discovered to be only one-fourteenth of the volume of the ocean waters below that level. Further, what was far more startling and far more important, it was found that the shore-lines of the visible continents by no means mark the true edges of the great ocean-basins: the dry lands were ascertained to be merely the undrowned portions of one universal continental plateau, the surface of which sinks at first very gently from the shore-line through a shallow water area many miles across, and then plunges rapidly downwards in a sudden slope to the true or abyssal floor of the ocean. This spreads out as a broad undulating plain some twelve thousand feet and more below the sea-level, and descends even still deeper locally in magnificent lake-like hollows to depths of from twenty thousand to thirty thousand feet. These results gave us for the first time a map of the forms of a region of the earth's surface at least twice as large as that of the whole of the dry lands united together. Nothing so important, from a geographical point of view, has been accomplished since the days of Columbus. It is the discovery of a new world. But in this new world it is plain that if the deductions of the earlier students of the earth's surface are of any value whatever, they must prove to be equally natural and inevitable.

Leaving the discussion of these deep-sea discoveries for a while, the author next summarised the fundamental conclusions arrived at by the geologist. The geologist has discovered that in all dry lands of the earth which he has hitherto investigated in detail, the local surface of the country is composed of the outcropping edges of solid rock sheets known as the "geological formations." These formations show distinctly, by their composition and by the relics of marine life which they contain, that they were originally laid down as layers of gravel, sand, and mud upon the floor of the sea. In other words, the surface of every geological formation must have constituted, at the date when it was deposited, an integral portion of the submarine relief of the earth's surface of its time. But while it is clear that these formations were laid down below the sea-level and in an approximately horizontal position, they are now found, wherever we can examine them upon the dry lands, usually far above that sea-level; and, instead of being horizontal, the surface of each formation is now found to be typically warped into great undulations like the surface of a folded cloth, or that of a rolling sea.

The undulations or wave-like forms of the surfaces of the geological formations are of all degrees of importance, the smaller waves riding on the backs of the larger ones, like ripples on the backs of the sea-waves. But in spite of the extreme complexity of this arrangement, it is comparatively easy of study, for we find the whole to be made up of endless

repetitions of one and the same fundamental unit—namely, an undulation or wave-like form; and the study of the characteristics and life-history of one of these typical undulations gives us, within certain limits, the key to those of all the rest.

Each simple geological undulation consists of two parts, an arch-like rise and a trough-like fall, and these two reciprocal elements are most naturally and conveniently united by the geologist under the single title of the "crust-wave" or "geological fold."

This curious wave-like disposition of the surface of any geological formation is apparent, whether we follow that surface, say, from east to west, or whether we follow it from north to south. So that the present surface of a formation is most simply pictured if we regard it as having been bent up into two sets of undulations, the one set crossing the other at right angles.

With this geological result as a guide, the author returned to the investigation of the main features of the earth's surface. It was pointed out that any straight line drawn completely round the globe from west to east over the earth's surface, either along the equator, the tropics, or along any of the neighbouring parallels, shows a more or less regularly alternating elevation and depression of that surface, of the same general type as the undulations of a geological section. Along these parallels we have three successive elevations, the Americas, Eurafica, and Asia-Australia; and three intermediate depressions, the ocean-basins of the Atlantic, the Indian Ocean, and the Pacific. That is to say, the broad forms of these surface undulations naturally suggest the theory that the exterior parts of the earth-crust are bent into three primary meridional waves ranging practically from pole to pole, each wave consisting of a single rise and a single fall. Again, if the crest of any one of the three meridional continental ridges is followed in a transverse direction, *i.e.* from north to south, it is found that the surface of the crest itself rises and falls in its turn in three successive undulations. For example, in the case of the ridge of the Americas, it is crossed by the three transverse ridges of North America, South America, and the Antarctic continent; and the three transverse depressions of the Arctic Ocean, the Carribean, and the depression south of Cape Horn.

Thus (precisely as in the case of the surface of a geological formation) the surface of the earth-crust at the present day is most simply regarded as the surface of a continuous sheet which has been warped up by two sets of undulations crossing each other at right angles. But in the case of the earth-surface, the one set ranges parallel with the equator, and the other ranges from pole to pole.

By means of a figure giving the natural disposition of the resultant forms and nodal lines characteristic of the surface of an elastic film warped by two orthogonal and simultaneous sets of undulations, the author showed how the phenomena apparent upon this cross undulated film suggested at a glance, (1) the forms and disposition of the terrestrial continents; (2) the triangular shapes of their extremities; (3) the diagonal trends of their shores; and (4) the courses of the archipelagic lines.

Carrying the method a stage farther, and breaking up each of the major waves symmetrically in a corresponding manner, the author showed how the subordinate forms so obtained now suggested the typical vertical contour of continents, namely a plain bounded by two marginal ridges and that of an ocean-floor, a submerging plain warped up centrally by a submarine elevation. The same correspondence was shown to hold good even in the broadest grouping of the forms, the collective land, and water areas.

After indicating that we have here the hint that the fundamental unit of form of the earth's surface is the *wave* or *fold*, and that the surface-contours of the globe are primarily the resultants of the two sets of undulations into which the outer parts of the earth-crust are warped up, the author pointed out that these results up to this point were reliable only as generalities, but appear at first sight valueless when we descend to particulars, and he next endeavoured to explain how the known minor variations and anomalies might be perhaps accounted for.

Returning to the subject of the geological fold, he showed how the various forms of the geological fold, and even many of the phenomena of its life-history, could be imitated by the lateral compression of flexible sheets of material; and how as the pressure increases the original symmetrical undulation becomes progressively deformed. The fold divides itself ultimately more or less definitely into three parts; the "arch-

limb," the "trough-limb," and a central limb of contrary motion, which is known as the "middle limb" or "septum." In the different regions studied by the geologist, the mode in which this middle limb or septum yields varies greatly according as the material which is being folded behaves as if it were elastic, flexible, or rigid: the strata in the septum or middle limb being sometimes sheared, sometimes bent, but in the majority of cases becomes twisted and broken, while the parts of the fold move most easily and rapidly in proportion as the septum approaches the perpendicular.

Illustrating the behaviour of this middle limb or septum by the corresponding behaviour of its representative in tidal waves, wind waves, and waves of the sea, &c., and in flexible and brittle sheets of material, the author pointed out that in all these cases the wave or fold, however much deformed, always consisted in essence of the two reciprocal halves of the arch and the trough; but as it became more compressed, the deformation became more and more concentrated within the middle or septal portion of the fold.

These results not only constitute the key of the geological position, but give us a clue to several of the more remarkable secondary phenomena of the earth's surface, and at the same time afford us a means of grouping together and reducing to fairly natural order many of its supposed anomalies.

From this fresh point of view we now regard the undulations of the earth's surface not only as wave-forms, and consequently each made up of two reciprocal and balanced elements, the one positive and the other negative, but we also look upon them as folds of various degrees of development, all undergoing a progressive deformation.

The recognisable amount of this deformation in any surface fold affords us a rough index of that especial stage in its life-history which the fold has attained; and such a fold should present the phenomena characteristic of a typical geological fold at that special stage of its development.

The counterbalance or dissymmetry of the positive and negative parts of the narrower and more continuous earth-folds is well illustrated in the case of the great western marginal ridge of the Americas. The crest of the Rocky Mountain-Andes plateau is the longest, straightest, and most continuous ridge on the face of the globe; and it is bordered throughout, as it should be, by its natural reciprocal—the Eastern Pacific depression or trough, which is correspondingly long, deep, straight, and continuous; and the two together constitute a single crust-fold.

Where, on the other hand, the component crests of the great compound earth-ridges are short, irregular, and confused, the reciprocal compound depressions are correspondingly short and irregular; as, for example, the compound arch of the Alpine ranges, when compared with its compound reciprocal, the Mediterranean troughs.

The same balance of parts of the two component halves of every crust-wave is discernible even in those subordinate examples where, as in the cases of the archipelagoes, the entire wave is almost wholly carried under water in the trough of a larger oceanic wave, for the collective island-arch immediately overlooks its reciprocal—a deep groove in the ocean-floor. Again, where, as in the cases of the Alps and the Himalayas, the subordinate wave is lifted on the back of a grander continental arch completely out of water, its necessary reciprocal or depression, which at first glance appears to be presumably absent, is found by the geologist to be tucked in in the form of a buried valley, for miles below the great mountain ridge, which has been forced forward, beyond, and above it.

The same rule holds good even when the collective dry-land areas are regarded as constituting a single arch. Where the marginal septal zone of this continental arch dies down insensibly towards the North Pole, we have the shallow reciprocal basin of the Arctic Ocean; but upon the opposite edge of the arch, where the septal slope rises up steeply and boldly, as along the outer and higher and shattered rim of the continents facing the Pacific and Indian Oceans, the grandly elevated but broken crest, the continental wave looks out immediately, as theoretically it should do, over its negative reciprocal the most greatly depressed and broken parts of the ocean-floor.

In the case of the geological fold, the study of its life-history shows that the region of yielding and fracture is of necessity the middle region or septum, and that the folding movement takes place most swiftly and easily as this septal portion increases in steepness.

These natural phenomena of the fold we also find paralleled

in the case of the earth-waves, whether major or minor. The septal areas and lines dividing the two component halves of the great earth-surface folds mark out distinctly the areas and lines of maximum present volcanicity and earthquake movement on the face of the globe. In proportion as the septal slopes are well marked, long, steep, and continuous, or *vice versa*, so the intensity of crust-movement and volcanicity seem to vary from region to region.

The septal area of the seaward edge of the great Rocky-Mountain-Andes fold is not only the septum of the longest and most continuous crust-fold of the present day, but it actually constitutes the longest and most continuous line of present volcanic and earthquake action. The steep outward septal edge of the collective continental mass of the globe, sweeping from Behring Strait to the East Indies, thence to the Cape of Good Hope and Cape Horn back to Behring Strait, shows from end to end its littoral or submarine volcanoes; while the almost insensible septal edge of the collective continental arch facing the shallow Arctic depressions, shows not a single volcano along the gentle septal declivity for the whole of its extent. In obedience to the same law, surface land marking the steeper edges of all (or, in other words, their septal slopes) of the great mountain plateaus of the Old World, where they face their reciprocals (the deeper plains in front of them), from the Bay of Bengal through the Himalayas, Hindoo Koosh to the Alps and the Mediterranean shores, constitutes the most active and typical zone of continental earthquakes. This rule of septal yielding and movement not only obtains when the great earth-surface waves are regarded in *section*, but also when they are figured in *plan*.

The great compound trough or basin of the Pacific shows all along its septal edge dividing it from its reciprocal or complement, namely, the higher parts of the earth's surface which bound it, an almost complete ring of active volcanoes; and when a projection is made of the entire earth's superficies, having the North Pole as its centre, it is found that this long volcanic band of the Pacific practically divides that surface in two. It is the primary septal band of the earth's superficies, ranging twice from pole to pole.

It was next shown that the minor local surface wrinkles of the earth-crust are not only folds in section, and domes and basins when seen in plan, but that they comport themselves as folds even when regarded laterally or horizontally; the line marking the axes of their crests creeping or flowing horizontally outwards and forwards towards the reciprocal deeps in front. In this way the festoon islands which margin the Pacific, and also the outwardly curving shores of the continents, find an additional explanation.

Finally, it was pointed out that if the theory of the fundamental character and domination of the fold or wave in the forms of the earth's surface be well founded, it must necessarily include the most conspicuous features of the earth's surface-relief regarded as a whole. The existence of this paramount feature was first made known to us by the recent deep-sea researches, which made it evident that the vertical relief of the earth-surface regarded collectively consisted of two members—namely, the so-called Continental Plateau (of which our present lands are merely the unsubmerged portions), and the so-called Abyssal Region, 12,000 feet and more in depth; these two contrasted elements being united normally by a rapid transitional slope, which lies buried from sight, at a depth of from 1000 to 2000 fathoms below the sea-level.

This remarkable phenomenon the author now interpreted as perfectly natural, and indeed inevitable upon the theory of the crust-fold. The Continental Plateau is merely the collective arch (or dome) of the entire relief of the globe, and the Abyssal Region is the collective trough (or basin), while the intermediate slope is merely the natural septal slope common to the two. But, of course, if this view is correct, it follows of necessity, from the characteristics of a fold (1) that the line marking the position of the axial horizontal plane separating the great earth-arch from the great earth-trough must be about midway down this septal slope; (2) the entire area of the surface of the dome must be equal to that of the basin; (3) the collective volume of the dome must be equal to that of the basin; and (4) that wherever the septal slope is fairly straight it must coincide in direction with the nodal lines of the earth's surface.

It was pointed out by the author that it had already been satisfactorily demonstrated by the results of the calculations and

researches of Mr. Murray, Dr. H. R. Mill, and others, that all these necessary correlations actually existed, although hitherto some of them had been looked upon as mere curious and inexplicable coincidences.

But if the fold or wave rules in the arrangement of the forms of the earth-surface of the present day, it must of necessity rule also in corresponding planetary surfaces, both in space and time; and the author gave it as his opinion that it afforded an equally natural and plausible explanation of cycles, systems, and transgressions of the geological formations, and of the surface (for example) of the planet Mars.

The final conclusion which the author drew from a consideration of the known facts and phenomena was, that the wave or fold appeared to be the natural unit of classification of all the grander forms of the earth-surface. The recognisable surface undulations of the present earth-surface are, broadly speaking, the surfaces of corresponding waves or wrappings of the outer parts of the earth-crust, in part obliterated by erosion, &c., and in part masked by deposition. In the crust-wave, its divisions, modifications, combinations, and intersections, we seem to find the key to the dissymmetries, the harmonies, the contrasts, and even the supposed anomalies of the surface features of the globe. Upon the surface of the earth, the crust-deformation expressible in terms of this unit seems to be the paramount factor. Denudation, deposition, earthquake movement, volcanicity, and even the surface forms and distributions of the main land and water areas, appear to be all subordinated to this ruling element. As the minor undulations stand related to the major undulations as subordinates, it is probable that not the slightest local change can be brought about without disturbing to that extent the balance of parts, and so leading to a readjustment of the equilibrium of the whole. The fold theory, however, affords us merely a natural and convenient means of classification of surface form, and in the meantime does not concern itself with the mode of origin of these forms. It is a theory, not of causes, but of the most natural grouping of effects.

#### SCIENTIFIC SERIALS.

*American Journal of Science*, April.—Further studies of the drainage features of the Upper Ohio basin, by T. C. Chamberlin and Frank Leverett. The general view adopted is that of Carl, according to whom the present drainage system of the Upper Ohio basin has been formed by the union of several pre-glacial systems that formerly flowed into what is now the Lake Erie basin. These were blocked up by the ice of the earlier glacial period, which invaded their lower courses and forced them to flow over low divides and unite to form a common south-westward flowing system nearly parallel to the border of the ice. The evidence for reversals and displacements of river beds is given in detail, and four hypotheses are presented to account for them. They all greatly emphasise the importance of the first glacial epoch, and indicate that, while the last glacial invasion was very much more pronounced in its apparent effects, it was, after all, much the smaller factor in the glacial period.—An apparatus to show, simultaneously to several hearers, the blending of the sensations of interrupted tones, by Alfred M. Mayer. A short brass tube is cemented in a hole in the bottom of a glass flask. When the tube is closed the flask resounds powerfully to a tuning-fork of suitable pitch vibrating near its mouth. When the tube is open the resonance is very feeble. The opening and closing is effected by a perforated disc rotating in contact with the brass tube. At a certain velocity the interrupted sounds blend into the sound of the tuning-fork, the velocity giving an indication of the amount of residual sensation.—The appendages of the pygidium of *Triarthrus*, by Charles E. Beecher. Further studies of the Yale Museum specimens have enabled the author to make out the main characteristics of the appendages of the caudal shield. At the pygidium, the endopodites preserve the slender, jointed, distal portion found at the thorax, but the proximal part is composed of segments which are considerably expanded transversely, thus making a paddle-like organ, the anterior edge of which is straight, while the posterior one is serrated by the projecting points of the expanded segments. These points bear small bundles of setæ. The specimens from which these details are gathered are very perfectly preserved. The author proposes next to describe the structure of the under side of the head, and then to review the

present enlarged knowledge of *Triarthrus*, with its bearings upon the position and affinities of the Trilobites generally.

*Bulletin de l'Académie Royale de Belgique*, No. 2.—The sense and the period of the Eulerian movement, by F. Folie. The sense of the Eulerian movement of the pole of inertia round the instantaneous pole is direct; that of the movement of the instantaneous pole at the surface of the earth is retrograde. The period of the latter is 321 days; for an integral number of years, a direct and somewhat slower motion may be substituted for this, giving the commonly accepted period of 423 days. But the shorter period is free from the geometrical objections attached to the latter.—The influence of pressure upon specific heat, taken below and above the critical temperature, by P. de Heen. The law governing this influence is analogous to that determining the relation between pressure and compressibility. Little variable at first, the specific heat rises with increasing pressure up to a certain limit, and then diminishes.—On the phenomenon of beats in luminous vibrations, by Dr. J. Verschaffelt. Prof. Righi showed in 1878 that if two rays are brought to interference whose periods are only slightly different, fringes are obtained which move with such velocity that a number equal to the difference of frequency passes each point of the screen in one second. Righi realised this practically by means of a rotating Nicoll prism and Fresnel's mirror. The principle applied by Dr. Verschaffelt is that of Doppler, according to which a motion of the source with respect to the ether changes the wave-length of the light emitted. The retardation was produced by a moving wedge of quartz cut parallel to its axis, and placed at 45° between the crossed Nicolls of a polarising microscope.—On absorption by the bile ducts, by Celestin Tobias. Ligature of the thoracic canal suppresses absorption of acids and biliary pigments, as pointed out by Harley. But it does not affect that of sodium ferrocyanide, of strychnine, or of atropine at the surface of the bile ducts. Sodium iodide is not absorbed at all. Whether the absorption is lymphatic or sanguine depends upon the nature of the substance.

#### SOCIETIES AND ACADEMIES.

##### LONDON.

Physical Society, April 13.—Prof. A. W. Rucker, F.R.S., President, in the chair.—The President invited discussion on Prof. Henrici's paper on calculating machines, and said a description of Mr. Sharp's harmonic analyser, giving direct readings of the amplitude and epoch of the various constituent simple harmonic terms, had been sent in. This machine requires no adjustments to be made before using. The amplitude is given by the length of a line joining the initial and final positions of the point of contact of a roller with a rotating disc, whilst the epoch is determined by the angle which this line makes with the plane of the roller in its initial position.—Prof. Perry congratulated Prof. Henrici on the success attained with his analysers. Referring to planimeters, he said the average error made in working out indicator diagrams with Hine and Robertson's instrument was only about one-third that made with Amsler's. After pointing out the great importance of Fourier's series to practical men, and especially to electrical engineers, he said that in studying reciprocating motions, such as those of pistons, valve gears, &c., it was most useful to resolve the motion into its fundamental harmonic motions and its overtones. In this way remarkable differences could be seen between various motions which have the same fundamental, and which are usually considered equivalent. In the *Electrician* of February 5, 1892, he had published the numerical work for a given periodic curve developed in Fourier's series, and he now exhibited a graphical solution done by one of his students, who was probably the first to carry out the late Prof. Clifford's idea of wrapping the curve round a cylinder and projecting it on different planes. Prof. Henrici had, he said, based the construction of his first analyser on Clifford's method, but used the Henrici principle (viz.  $\int y \sin \theta \, d\theta = \int \cos \theta \, dy$ , when integrated over a complete period) to explain the later machines. As a matter of fact the first machine in which the coefficients were determined by an Amsler planimeter carried by a reciprocating tangent plane, was a beautiful example of the Henrici principle, and he, Prof. Perry, saw far greater possibilities before it. The defects in the first instrument were mechanical ones, and could be got over by in-

creasing the amplitude of the harmonic motion. Not only was the machine useful for Fourier expansions, but by giving suitable motions to the tangent plane developments of arbitrary functions in spherical harmonics, Bessel's functions, Lamé's functions, and other normal forms could be determined. He had designed a machine which, on Prof. Henrici's principle, develops arbitrary functions in Bessel's, and hoped to have shown it in working order at the meeting; the Easter holidays had prevented its being finished in time. In this machine the motion is given to the table by a cam and roller, the cam being shaped so that the displacement of the table is  $x \times J(x)$  when the shaft turns through an angle proportional to  $x$ . The revolving cylinder is driven by variable gearing from the cam shaft. By using cams of other shapes, developments in many normal forms may be obtained; and the machine is therefore of general analytical use. An example of development in Bessel's worked out arithmetically by two of his students, Messrs. Hunt and Fennel, was given, and the process of performing the integration by the machine described. Prof. Boys, speaking of arithmometers, said Prof. Selling's machine had several inconveniences. In the first place, it occupied a large space, and the projecting racks were apt to upset things put behind the machine. Secondly, the result of any operation was indicated by continuous motion, and therefore cannot be read off instantly with certainty. On the other hand the "Brunsviga" machine was very compact and convenient, the only serious defect being that one cannot carry on figures obtained as the result of one operation to work with again, as was possible in the well-known Colmar machine. As another improvement he suggested that the two sets of numbers on the wheels showing the result of any operation, should be coloured differently, so that it would be easy to see whether multiplication or division had been performed. The labour of operating with large digits could then be considerably reduced with certainty. For example, in multiplying by 2998, instead of 28 (2+9+9+8) turns of the handle, 5 would be sufficient, viz. 3 in the forward direction and 2 backward, thus giving 3002. In his opinion logarithm tables were not nearly so convenient for ordinary calculations as this machine.—Mr. A. P. Trotter described how, by the use of templates cut to suitable shapes, one could obtain true curves from those given by recording voltmeters and similar apparatus. Mr. Yule said he had recently seen the newest analyser made by Coradi for Prof. Weber, and was present when it was tested by the latter on a simple harmonic curve. It gave excellent results, the errors not amounting to 1 part in 2000. Speaking of the "hatchet" planimeter, he thought the first one was exhibited by Mr. Goodman at the Institution of Civil Engineers. Mr. A. Sharp, he said, remarked that since last meeting he had designed an inversion of the mechanism in his harmonic analyser, which made it much more practical. Prof. Henrici, in reply, said the uses of his first machine, suggested by Prof. Perry, might lead to great developments in this subject. Lord Kelvin had shown that with the sphere and roller integrator products of two functions such as  $\int f(x) F(x) dx$  could be got. Referring to Prof. Boys' criticism on the Selling arithmometer, he did not consider the difficulty in reading off the result at all serious. Mr. Trotter's method of solving problems by templates might be very useful. Speaking of the "hatchet" planimeter, he said he believed it was first brought out in Denmark. Mr. F. W. Hill, of the City of London School, had sent him a solution of its action. Mr. Sharp, he said, had made a very considerable improvement in his machine, and the elements of this integrator may be useful for other purposes.—Mr. P. L. Gray read a paper on the minimum temperature of visibility, describing experiments made to find the lowest temperature at which bright or blackened platinum becomes visible in the dark. The instrument used was a Wilson and Gray's modification of Joly's maldometer, in which a thin strip of platinum, about 10 c.m. long and 1 c.m. wide, is heated by an electric current. The expansion of the strip is indicated by an optical method, and used for estimating the temperature of the strip. To calibrate the arrangement, small particles of substances having known melting points were placed on the strip, and observed through a microscope, the position of the spot of light showing the expansion being noted when the substance melted. The general conclusions arrived at are:—(1) That the minimum temperature of visibility is the same for a bright polished surface as for one covered with lampblack, although the intensity of radiation in the two cases may be different. (2) That the visible limit at the red end of the spectrum varies greatly for a normal eye according to its state of preparation. Exposure to bright light diminishes the sensitiveness of

the eye, and darkness increases it. (3) That for the less sensitive condition, the minimum temperature of visibility for the surface of a solid is about 470° C., but this may be much reduced by even a few minutes in a dark room. (4) That at night a surface at 410° C. is visible, and that by resting the eyes in complete darkness this may be reduced to 370° nearly. (5) That different people's eyes differ somewhat in their "minimum temperature of visibility," but probably not to any great extent if tested under the same conditions as to preparation, &c. To most observers the strip at these low temperatures had no appearance of red, but looked like a whitish mist. Inserting a plate of glass or a layer of water in the line of vision had no effect on the temperature of visibility. Mr. Blakesley inquired if the author had tried condensing the light from the strip? As to colourlessness, he observed that the parts of the retina active in oblique vision were less sensitive to colour than the central portions. Dr. Burton remarked that in the experiments, the presence of light and not colour was being observed. When illumination was faint, as in twilight or moonlight, it was very difficult to distinguish colours. In the solar spectrum one did not see any whitish termination at the red end. Mr. Elder said Captain Abney had shown that all colours appear grey when of small intensity. The President thought the question as to whether visibility depends on wave-length or on energy was an important one. Probably a minimum amount of energy was essential. At such low temperature the emission curves of the different wave-lengths may not have become sufficiently separated to be distinguished. Mr. Gray, in reply, said Prof. Langley had shown that a minimum, but very small, amount of energy was necessary to vision in all parts of the spectrum.—Dr. Burton's paper on the mechanism of electrical conduction was postponed.

**Mathematical Society, April 12.**—A. B. Kempe, F.R.S., President, in the chair.—The following communications were made:—On regular difference terms, by the President. (Prof. Greenhill, F.R.S., Vice-President, *pro tem.*, in the chair.) In the expression of the invariants of a binary quantic  $Q_n$  in terms of the roots, we employ functions such as

$$\Sigma(T),$$

where  $T$  is a product of differences of the roots into which each root enters the same number of times, and the summation extends to all expressions derivable from  $T$  by transpositions of the roots. If the number of roots be  $n$ , and each root enters  $v$  times into  $T$ , then  $T$  is a *regular difference term* of the system of roots considered, and is said to be of degree  $n$  and order  $v$ . For a given degree  $n$  the simplest regular difference terms are of order 1 or 2, according as  $n$  is even or odd, and are called *elemental terms* of the system of roots. The object of the paper is to show that every regular difference term of a given system of roots is a rational integral function of the elemental terms of that system. One result of this theorem is that every invariant of the binary quantic  $Q_n$ , which is a rational integral function of the roots of  $Q_n$ , is expressible as a rational integral function of such of those invariants as are of the form

$$\Sigma(E_1^{\lambda} E_2^{\mu} E_3^{\nu} \dots)$$

where  $E_1, E_2, E_3, \dots$  are elemental terms of the  $n$  roots of  $Q_n$ .—Theorems concerning spheres, by S. Roberts, F.R.S.—Second memoir on the expansion of certain infinite products, by Prof. L. J. Rogers.—A property of the circum-circle, ii., by Mr. R. Tucker.—A proof of Wilson's theorem, by Mr. J. Perott.—On the sextic resolvent of a sextic equation, by Prof. W. Burnside, F.R.S. The group of an irreducible equation of the fifth degree, after adjunction of the square root of the discriminant, is either the ico-ahedral group, the dihedral group for  $n = 5$ , or the cyclical group for  $n = 5$ ; the two latter being sub-groups of the former. In the two latter cases the equation is solvable by radicals, and in the former not. For a given equation with numerical coefficients the two latter cases may be distinguished from the former by constructing the sextic resolvent and determining whether or no this has a rational root. This sextic resolvent has been calculated by Cayley ("Collected Papers," vol. iii. 2) for the general quintic. When the quintic is taken in its standard form,  $x^5 + ax + b = 0$ , the calculation is enormously simplified (see C. Runge, *Acta Math.* vol. vii.). For a given irreducible sextic there is a greater range of possibilities. After adjoining the square root of the discriminant, the group of the equation may be either the alternating group of 6 variables, a transitive group of 6 variables which is iso-

morphous with the icosahedral group, or a group of order less than 60, which is necessarily solvable. In the first case the solution of the given equation cannot be made to depend on an equation of lower degree than the 6th; in the second case the roots of the equation are rationally expressible in terms of the roots of an equation of the 5th degree; and in the last case the equation can be solved by radicals. For a given equation with numerical coefficients the cases are distinguished by forming the resolvents of the 6th and 10th degrees and determining whether either of these have a rational root. If the resolvent of the 10th degree has a rational root the equation can be solved by radicals, and if that of the 6th degree has a rational root the solution depends on a quintic. It is this latter resolvent which is calculated in the present paper, on the supposition that the sextic is reduced to the standard form

$$x^6 + ux^2 + vx + w = 0,$$

which is always possible by solving a cubic equation. Representing the roots of the equation by  $\alpha, 1, 2, 3, 4, 5$ , a transitive icosahedral group is generated (see Serret, "Cours d'Alg. Sup." vol. ii.) by the two even permutations

$$(12345) \text{ and } (\alpha 1) (25).$$

There is no function of the roots of the 2nd degree that is invariable for this group, but it is easily verified that

$\alpha 12 + \alpha 23 + \alpha 34 + \alpha 45 + \alpha 51 + 124 + 235 + 341 + 452 + 513$  is such a function; and therefore that this function takes 6 values for all even permutations of the 6 roots. If

$$y^6 + f_1 y^5 + f_2 y^4 + f_3 y^3 + f_4 y^2 + f_5 y + f_6 = 0$$

is the equation whose roots are these 6 values,  $f_1$  &c., must be rational in  $u, v, w$ , and  $\sqrt{\Delta}$ , where  $\Delta$  is the discriminant of the sextic. By comparing the degrees of these functions it is seen that

$$f_1 = 0, f_2 = m_1 w, f_3 = m_2 uv, f_4 = m_3 u^3 + m_4 w^2, f_5 = m_5 v^3 + m_6 uvw + m_7 \sqrt{\Delta}, f_6 = m_8 u^2 v^2 + m_9 w^3 + m_{10} u^3 w,$$

where the  $m$ 's are numbers; and it is further easily shown that

$$m_2 = m_5 = m_6 = 0.$$

Finally, by choosing suitable special cases, the values of the other  $m$ 's are completely determined. The final result is that this sextic resolvent has the form

$$y^6 + 30zw^2 y^4 + (165w^2 - 4u^3) y^2 + 25u^2 v^2 - 80w^3 + 64u^3 w = y^2 \sqrt{\Delta}.$$

It is obvious that the twelve values that the function

$$\alpha 12 + \alpha 23 + \dots + 513$$

takes for all permutations of the roots are, for the standard sextic equal and opposite in pairs, so that  $y^2$  is a 6-valued function for the symmetric group. If then the above equation be squared, while  $z$  is written for  $y^2$  and its value in terms of  $u, v, w$  substituted for  $\Delta$ ,

$$(z^3 + 30zw^2 + (165w^2 - 4u^3)z + 25u^2 v^2 - 80w^3 + 64u^3 w)^2 - \Delta z = 0$$

is the resolvent, a rational root of which will indicate that the solution of the sextic depends on that of a quintic.—Mr. Perigal exhibited some diagrams illustrating circle-squaring by dissection.

**Entomological Society, April 11.**—Henry John Elwes, President, in the chair.—The Hon. Walter Rothschild exhibited male and female specimens of *Ornithoptera paradisea*, Stmgr., from Finisterre Mountains, New Guinea; *O. trojana*, Stmgr., from Palawan; *O. andromache*, Stmgr., from Kina Balu, Borneo; *Ctenus mirabilis*, R. thsch., from Cedar Bay, Queensland, and a few other splendid species from the Upper Amazons. The President, Mr. J. J. Walker, R.N., Mr. Osbert Salvin, F.R.S., Lord Walsingham, F.R.S., Colonel Lang, R.E., Mr. Champion, and Mr. Hampson made remarks on the geographical distribution of some of the species and the elevation at which they were taken.—Mr. H. Goss exhibited, for Mr. G. A. J. Rothney, several specimens of a species of Hemiptera (*Serinetha augur*, Fab.), and of a species of Lepidoptera (*Piaula flammans*, Walk.), the latter of which closely resembled and mimicked the former. He said that Mr. Rothney had found both species abundantly on the roots and trunks of trees in Mysore, in November last, in company with ants (several species of *Camponotus* and *Cremastogaster*). The Hemiptera appeared to be distasteful to the ants, as they were never molested by them,

and he thought that the species of Lepidoptera was undoubtedly protected from attack by its close imitation of the Hemipteron. Mr. Goss said he was indebted to Mr. C. J. Gahan for determining the species. A discussion followed on the mimicking species, in which the President, Mr. Waterhouse, Mr. J. J. Walker, Colonel Swinhoe, and Mr. Hampson took part.—Mr. J. W. Tutt exhibited a typical specimen of *Lycæna corydon*, captured in July 1893; a hybrid male (*L. corydon* and *L. adonis*), taken in copuli with a typical female *L. adonis*, May 20, 1893; a typical male *L. adonis*, May 20, 1893; a female *L. adonis*, the pigment failing in one hind wing; a pale var. of *L. corydon*, probably to be referred to *var. albicans* of Zeller, usually taken in Italian mountains, or var. *albicans*, II. S., taken in Andalusia. Mr. Tutt remarked that, of the first, Staedinger (Cat. p. 12) says "pallidior," of the latter "albicans." He also remarked that the hybrid retains the external features of the species *corydon*, but has taken on to a great extent the coloration of *L. adonis*. It was captured in copuli with a female *L. adonis*, at a time when *L. adonis* was very abundant, and some weeks before *L. corydon* occurred.—The question having been raised by the President as to the number of meetings of the Society which it was desirable to hold during the year, and the most convenient dates for such meetings, a long discussion on the subject ensued, in which Mr. Waterhouse, Mr. Salvin, the Hon. Walter Rothschild, the Rev. T. Wood, Mr. S. Stevens, the Rev. Seymour St. John, and others took part.

**Royal Meteorological Society, April 18.**—Mr. Richard Inwards, the President, delivered an address on some phenomena of the upper air. He said that there are three principal ways in which the higher atmosphere may be studied: (1) by living in it on some of the great mountain chains which pierce many miles into the air in various parts of the globe; (2) by ascending into it by means of balloons; and (3) by the study of the upper currents as shown to our sight by the movements of the clouds. After describing the effects of rarified air on animal life and natural phenomena, Mr. Inwards proceeded to give an account of various balloon ascents which had been undertaken with the object of making meteorological observations. In 1850 Messrs. Barral and Bixio, when they had ascended to 20,000 feet, found the temperature had sunk to 15° F.; but this was in a cloud, and on emerging from this 3000 feet higher, the temperature fell as low as -38°, or 70° below freezing point. In 1862, Mr. Glaisher and Mr. Coxwell made their famous ascent when they reached an altitude of about seven miles from the earth. A short time ago a balloon without an aeronaut, but having a set of self-recording instruments attached, was sent up in France, and from the records obtained it is shown that a height of about ten miles was attained, and that the temperature fell to -104° F. Clouds are simply a form of water made visible by the cooling of the air which previously held the water in the form of invisible vapour. Every cloud may be regarded as the top of an invisible warm column or current thrusting its way into a colder body of air. After referring to the various classifications and nomenclatures of clouds, of which that proposed by Luke Howard in 1803 is still in general use, Mr. Inwards said that whatever system of naming and classifying clouds be adopted, it should depend on the heights of the various clouds in the air, and he gave a few rough rules by which the comparative altitudes of the clouds may be judged when there is no time or opportunity to make exact measurements. Among the indications by which a cloud's height in the air may be gathered are its form and outline, its shade or shadow, its apparent size and movement, its perspective effect, and the length of time it remains directly illuminated after sunset. By the last method some clouds have been estimated to have been at least ten miles above the surface of the earth. The cloud velocities at high altitudes have been carefully noted at the Blue Hill Observatory, Mass., U.S., and show, practically, that at about five miles' height, the movement is three times as fast in summer, and six times in winter, as compared with the currents on the earth's surface. After showing a number of lantern slides illustrating the various types and forms of clouds, the aurora borealis, rainbows, &c., Mr. Inwards concluded his address by urging the desirability of establishing a good cloud observatory somewhere in the British Isles. At the close of the meeting, the Fellows and their friends inspected the exhibition of instruments, photographs, and drawings relating to the representation and measurement of clouds, which had been arranged in the

rooms of the Institution of Civil Engineers. A lantern display of slides, showing cloud effects and other meteorological phenomena, was also given.

PARIS.

Academy of Sciences, April 16.—M. Loewy in the chair.—On mountain observatories in connection with cyclones, by M. Faye. A polemical paper discussing the evidence afforded as to the causes of cyclones by the institution of meteorological observatories at high altitudes. The author contends that the convection theory is completely overthrown. He observes that the theory of the constitution of the sun should benefit from the work possible at these observatories.—M. Grimaux is elected a member of the chemistry section in place of M. Frémy.—Report concerning a demonstration of Fermat's theorem on the impossibility of the equation  $x^n + y^n = z^n$ , submitted by M. G. Korneck. The demonstration depends on a lemma which is inexact, and hence is not valid.—On the photography of the chromosphere of the sun, by M. H. Deslandres.—On an application of the theory of continuous groups to the theory of functions, by M. Paul Painlevé.—On the generalisation of algebraical continued fractions, by M. Padé.—On the determination of the number of prime numbers inferior to a given quantity, by M. H. von Koch.—On the structure of diffraction waves from the same source, by M. G. Meslin.—Achromatism and chromatism of interference fringes, by M. J. Macé de Lépinay.—On the magnetic properties of iron at different temperatures, by M. P. Curie. The intensity of magnetisation slowly decreases, then more rapidly lessens, with rise in temperature, the rate of loss attaining its maximum for soft iron between 740 and 750°. There is no definite point for the temperature of transformation of iron. At temperatures above 750°, the intensity of magnetisation continues to decrease at a continually lessening rate in general; from 950° to 1280°, the coefficient of magnetisation is almost constant. Between 755° and 1365°, the coefficient is independent of the intensity of the field.—On an electrochemical method of observation of alternating currents, by M. P. Janet. By means of paper soaked in potassium ferrocyanide and ammonium nitrate, and wrapped on a revolving metallic drum, a metallic style registers the periodic variations of the E.M.F.—The general problem of transformers in a closed magnetic circuit, by M. Désiré Korda.—On the allotropic transformation of iron, by M. Georges Charpy.—Evolution of organised beings. On certain cases of duplication of Galton's curves due to parasitism and on dimorphism of parasitical origin, by M. Alfred Giard.—On the poison organs of the Hymenoptera, by M. Bordas.—The ejection of blood as a means of defence among some of the Coleoptera, by M. L. Cuénot. The author has particularly studied the following species:—*Timarcha tenebricosa* and *coriaria* Fabr., *Adimonia tanacetii* Fabr., *Coccinella septempunctata* and *bipunctata* L., *Meloe proscarabeus* L., and *majalis* L., and *autumnalis* Oliv.—On the muscular buds (*bourgeons musculaires*) of the paired fins of *Cyclopterus lumpus*, by M. Frédéric Guéiel.—On the parasitism of a species of Botrytis, by M. Louis Mangin. The conditions under which copper or zinc salts may be used to combat with this parasite are indicated. Anatomical modifications of plants of the same species in the Mediterranean region and in the region of the neighbourhood of Paris, by M. W. Russell. Plants in the Mediterranean climate differ from those of the Parisian region by (1) the cellulose of the epidermis are larger, and have more regular contours and thicker walls; (2) the bark has assimilating tissue supported on parenchyma without chlorophyll (transformed into protective tissue); (3) the diameter of the vessels is greater; (4) the thickness of the leaves is augmented owing to the great development of the palisade tissue.—On the structure of certain varieties of rust; their analogy with the sedimentary ferruginous minerals of Lorraine, by M. Bleicher. The combination of ferric hydroxide and silica in presence of soft water underground may be so rapid as to form rusts comparable in appearance and structure with iron minerals of geological age.—On the fruits of palms found in the Cenomanian near Sainte-Menehould, by M. P. Fliche.—Researches on a mode of striation of rocks independent of glaciation, by M. Stanislas Meunier.—Researches on rigor mortis, by M. J. Tissot.—The mechanism of hyperglycæmia determined by diabetic *figüre* and by anaesthetics. Experimental facts serving to establish the theory of sugar diabetes and of the regulation of the glucose-forming function in the normal state, by M. Kaufmann.

BOOKS, PAMPHLETS, and SERIALS RECEIVED.

Books.—The New Technical Educator, Vol. 3 (Cassell).—Elementary Meteorology: Prof. W. M. Davis (Boston, Ginn).—The Microcosm and the Macrocosm; B. Waller (K. Paul).—Law and Theory in Chemistry: J. S. Carnegie (Longmans).—Rainfall in the East Indian Archipelago, 1892 (Batavia).—Observations made at the Magnetical and Meteorological Observatory at Batavia, Vol. xv. 1892 (Batavia).—Practical Paper-making: G. Clapperton (Lockwood).—Müller-Pouillet's Lehrbuch der Physik und Meteorologie, new edition, Erster, Zweiter (Erste Abthg., Erste Liefg.) und Dritter Band (Braunschweig, Vieweg).—Histories of American Schools for the Deaf: edited by Dr. E. A. Fay, 3 Vols. (Washington).—Recenti Progressi nelle Applicazioni dell' Eletticità: Prof. R. Ferrini, Parte II. (Milano, Hoepli).—La Trazione Elettrica: G. Martinez (Milano, Hoepli).—Trasmissione Elettrica: G. Sartori (Milano, Hoepli).—A Guide to Palmistry: Mrs. E. Easter-Henderson (Gay and Bird).  
PAMPHLETS.—The Egg-Blower's Companion: W. M. Roberts (J. Heywood).—The Eight Hours' Day in British Engineering Industries: J. S. Jeans (Ballantyne).—The Constitutional Beginnings of North Carolina: J. S. Bassett (Baltimore).—Geological Club of Philadelphia, Charter, &c. (Philadelphia).  
SERIALS.—Journal of the Institution of Electrical Engineers, No. 110, Vol. XXIV. (Spon).—Tufts College Studies, No. 1 (Tufts College, Mass.).—Palestine Exploration Fund Quarterly Statement, April (Watt).—Journal of Anatomy and Physiology, April (Griffin).—Quarterly Review, April (Murray).—Notes from the Leyden Museum, October, January, and April (Leyden, Brill).—L'Anthropologie, Tome v. No. 2 (Paris, Masson).—Proceedings of the American Academy of Arts and Sciences, new series, Vol. xx. (Boston, Wilson).—Royal Natural History, Vol. 1, Part 6 (Warne).—Morphologisches Jahrbuch, 21. Band, 2. Heft (Leipzig, Engelmann).—Journal of the Royal Microscopical Society, April (Williams and Norgate).—Bulletin of the Geological Club of Philadelphia, Vol. 1, No. 2 (Philadelphia).—Bullettino della Società Geografica Italiana, serie 3, Vol. 7, fasc. i.-ii. (Roma).—Mittheilungen der Deutschen Gesellschaft für Natur- und Völkerkunde Ostasiens in Tokio, Band vi. Seite 103-148 (Tokio).—Ergebnisse der Meteorologischen Beobachtungen, Jahrg. iv. (Bremen).—Mathematical Gazette, No. 1 (Macmillan).—Sitzungsberichte der K. Akademie der Wissenschaften Math.-Naturw. Classe.—Anatomie und Physiologie, 1893, January, February, March bis July.—Chemie, 1893, January, February, March, April, May bis July.—Mineralogie, &c., 1893, January bis March, April, May, June, July.—Mathematik, &c., 1893, January, February, March, April, May, June, July (Wien).

CONTENTS.

PAGE

|                                                                                       |     |
|---------------------------------------------------------------------------------------|-----|
| Biology at the Antipodes. By G. B. H. . . . .                                         | 597 |
| Harmonic Analysis. By E. W. H. . . . .                                                | 598 |
| Our Book Shelf:—                                                                      |     |
| Collett: "Bird Life in Arctic Norway" . . . . .                                       | 599 |
| Hall and Stevens: "A Text-Book of Euclid's Elements."—W. . . . .                      | 599 |
| Letters to the Editor:—                                                               |     |
| Panmixia.—Dr. George J. Romanes, F.R.S. . . . .                                       | 599 |
| The Late Mr. Pengelly, F.R.S., and the Age of the Bovey Lignite.—A. R. Hunt . . . . . | 60  |
| A Fine Aurora Australis.—Hon. H. C. Russell, C.M.G., F.R.S. . . . .                   | 601 |
| Lepidosiren paradoxa.—Prof. E. Ray Lankester, F.R.S. . . . .                          | 601 |
| Are Birds on the Wing Killed by Lightning?—G. W. Murdochs . . . . .                   | 601 |
| A Remarkable Meteor.—Hon. R. Russell . . . . .                                        | 601 |
| Afforestation in the British Isles. By Prof. W. R. Fisher . . . . .                   | 601 |
| Notes . . . . .                                                                       | 603 |
| Our Astronomical Column:—                                                             |     |
| Four New Variable Stars . . . . .                                                     | 608 |
| Speed of Perception of Stars . . . . .                                                | 608 |
| Elements and Ephemeris of Gale's Comet ( <i>b</i> 1894) . . . . .                     | 608 |
| A Mistaken Cometary Discovery . . . . .                                               | 608 |
| The Institution of Mechanical Engineers . . . . .                                     | 608 |
| What are Zoological Regions? By Dr. A. R. Wallace, F.R.S. . . . .                     | 610 |
| Further Light upon the Nature of the Benzene Nucleus. By A. E. Tutton . . . . .       | 614 |
| The Face of the Earth. By Prof. C. Lapworth, F.R.S. . . . .                           | 614 |
| Scientific Serials . . . . .                                                          | 617 |
| Societies and Academies . . . . .                                                     | 617 |
| Books, Pamphlets, and Serials Received . . . . .                                      | 620 |



# CAMBRIDGE UNIVERSITY PRESS.

**THE COLLECTED MATHEMATICAL PAPERS OF ARTHUR CAYLEY, Sc.D., F.R.S., Sadlerian Professor of Pure Mathematics in the University of Cambridge.** Demy 4to. (To be completed in 10 vols.) Vols. I.-VI. now ready, 25s. each.

**CATALOGUE OF SCIENTIFIC PAPERS COMPILED BY THE ROYAL SOCIETY OF LONDON.** Vols. I.-VI. for the years 1800-1863. Royal 4to. Cloth (Vol. I. in Half-morocco) £4 (net); Half-morocco, £5 2s. (net). Vols. VII. and VIII. for the years 1864-1873. Cloth, £1 11s. 6d. (net); Half-morocco, £2 5s. (net). Single volumes, Cloth, 20s. (net), or Half-morocco, 28s. (net).

Vol. IX. New Series for the years 1874-1883. Cloth, 25s. (net); Half-morocco, 32s. (net). [*Vol. A. in the Press.*]

**MATHEMATICAL AND PHYSICAL PAPERS.** By LORD KELVIN (Sir W. THOMSON), LL.D., D.C.L., F.R.S., Professor of Natural Philosophy in the University of Glasgow. Collected from different Scientific Periodicals from May, 1841, to the present time. Demy 8vo. Vol. I., 18s. Vol. II., 15s. Vol. III., 18s.

**MATHEMATICAL AND PHYSICAL PAPERS.** By Sir G. G. STOKES, Sc.D., LL.D., F.R.S., Lucasian Professor of Mathematics in the University of Cambridge. Reprinted from the Original Journals and Transactions, with Additional Notes by the Author. Demy 8vo. Vol. I., 15s. Vol. II., 15s. [*Vol. III. in the press.*]

**THE SCIENTIFIC PAPERS OF THE LATE PROF. J. CLERK MAXWELL.** Edited by W. D. NIVEN, M.A., formerly Fellow of Trinity College. In 2 Vols. Royal 4to, £3 3s. (net).

**A TREATISE ON THE THEORY OF FUNCTIONS OF A COMPLEX VARIABLE.** By A. R. FORSYTH, D.Sc., F.R.S., Fellow of Trinity College, Cambridge. Royal 8vo, 21s. net.

**THEORY OF DIFFERENTIAL EQUATIONS.** Part I. Exact Equations and Pfaff's Problem. By A. R. FORSYTH, D.Sc., F.R.S. Demy 8vo, 12s.

**A TREATISE ON THE MATHEMATICAL THEORY OF ELASTICITY.** By A. E. H. LOVE, M.A., Fellow of St. John's College, Cambridge. 2 Vols., Demy 8vo. Vol. I., 12s. Vol. II., 12s.

London: C. J. CLAY & SONS, Cambridge University Press Warehouse, Ave Maria Lane.

**HISTORY of the THEORY OF ELASTICITY, and of the STRENGTH of MATERIALS, from GALILEI to the PRESENT TIME.** By the late T. TODHENTER, Sc.D., F.R.S. Edited and Completed by Prof. KARL PRAGER, M.A. Vol. I. GALILEI to SAINT-VENANT, 1639-1850. Demy 8vo. 25s. Vol. II. SAINT-VENANT to LORD KELVIN (Sir William Thomson). Demy 8vo, in 2 Parts. 30s.

**A TREATISE ON PLANE TRIGONOMETRY.** By E. W. HOBSON, D.Sc., Fellow of Christ's College and University Lecturer on Mathematics. Demy 8vo. 12s.

**PLANE TRIGONOMETRY.** By S. L. LONEY, M.A., late Fellow of Sidney Sussex College. Crown 8vo, 7s. 6d. Part I., up to and including the SOLUTION of TRIANGLES, may be had separately. Crown 8vo, 3s.

**A TREATISE ON ANALYTICAL STATISTICS.** By E. J. ROUTH, Sc.D., F.R.S., Fellow of the University of London, Honorary Fellow of Peterhouse, Cambridge. Demy 8vo. Vol. I., 14s. Vol. II., 10s.

**ELEMENTARY HYDROSTATICS.** By JOHN GREAVES, M.A., Fellow and Lecturer of Christ's College. Crown 8vo. [*Nearly ready.*]

## CAMBRIDGE NATURAL SCIENCE MANUALS. BIOLOGICAL SCIENCE SERIES.

General Editor, A. E. SHIPLEY, M.A., Fellow of Christ's College.

**ELEMENTARY PALÆONTOLOGY—INVERTEBRATE.** By HENRY WOODS, B.A., F.G.S. Crown 8vo. 6s.

**PRACTICAL PHYSIOLOGY of PLANTS.** By F. DARWIN, M.A., F.R.S., and E. H. ACTON, M.A. [*Nearly ready.*]

## PHYSICAL SCIENCE SERIES.

**HEAT.** An Elementary Text-book, Theoretical and Practical, for Colleges and Schools. By R. T. GLAZEBROOK, M.A., F.R.S., Assistant Director of the Cavendish Laboratory. 3s. [*A fuller List of forthcoming Volumes will be sent on application.*]

# MR. MURRAY'S LIST.

2 Vols. Crown 8vo. 24s. With Maps and Illustrations. SECOND EDITION of

**THE PAMIRS** Being a Narrative of a Year's Expedition on Horseback and on Foot through Kashmir, Western Tibet, Chinese Tartary, and Russian Central Asia. By the Earl of DUNMORE. *TIMES*.—"A trustworthy record of an interesting journey. . . . The book gives a very fair idea of the character of the Pamirs, of the relations between Russia and China in that region, and of politics generally in Central Asia." *DAILY TELEGRAPH*.—"For sportsmen there is much to read in these two volumes of grand hunting days after the 'ovis poli,' the Tibetan antelopes and wild horses."

Medium 8vo. 18s.

**ALONE WITH THE HAIRY AINU; or, 3800 Miles on a Pack-Saddle in Yezo and a Cruise to the Kurile Islands.** By A. H. SAVAGE LANDOR. With Map and numerous Illustrations by the Author. *DAILY TELEGRAPH*.—"Mr. Landor's book is one of the most attractive records of research which has been brought to public notice in the present year." *TIMES*.—"Mr. Landor is to be thanked for letting in light on this strange people, and for brushing away many fables circulated about them."

Crown 8vo. 3s. 6d. each.

**TYPEE; or, The Marquesas Islanders.**

**OMOO: A Narrative of Adventure in the South Seas.**

*New Edition of the Works of HERMAN MELVILLE, with Maps and New Illustrations taken on the spot.* *TIMES*.—"We cordially welcome a new edition of this once well-known and justly-appreciated 'Typee,' with its sequel, 'Omoo.'" *SPEAKER*.—"More delightful reading no man of any age need wish for."

With Illustrations, Crown 8vo. 3s. 6d.

**CHAPTERS IN MODERN BOTANY.** By PATRICK GEDDES, Professor of Botany, University College, Dundee. Forming a New Volume of MURRAY'S UNIVERSITY EXTENSION SERIES. *DAILY CHRONICLE*.—"The present work is a most charmingly written account of some of the more striking phenomena of plant life."

Medium 8vo. 12s.

**ST. JOHN'S WILD SPORTS AND NATURAL HISTORY OF THE HIGHLANDS OF SCOTLAND.** A New and Cheaper Edition. With Portrait of Mr. ST. JOHN, and several New Illustrations. *ART JOURNAL*.—"The book is a delightful one, worth a hundred of the so-called 'publications of the season'—ephemera that are hardly worthy to live the limited lives they live."

JOHN MURRAY, Albemarle Street.

PUBLICATIONS OF THE CLARENDON PRESS.

MESSRS. BELL'S BOOKS.

CAMBRIDGE MATHEMATICAL SERIES.

NEW VOLUMES AND NEW EDITIONS.

JUST PUBLISHED. Crown 8vo. 6s.

The Elements of Applied Mathematics. Including Kinetics, Statics, and Hydrostatics. By C. M. JESOP, M.A., late Fellow of Clare College, Cambridge, Lecturer in Mathematics in the Durham College of Science, Newcastle.

Elementary Analytical Geometry. By the Rev. T. G. VVYVAN, M.A., Mathematical Master at Charterhouse.

Unimmediately. "An elementary treatise, dealing with the subject only so far as the right line and circle, and intended specially for candidates for the Army and London Intermediate Examinations.

Elementary Trigonometry. By J. M. DYER, M.A., and Rev. R. H. WHITCOMBE, Assistant Masters at Eton College. 2nd Edition, thoroughly Revised. Crown 8vo. 4s. 6d.

In use at Eton, Winchester, Charterhouse, Dover College, &c., &c. "The work is well adapted for school use. The explanations of book-work are clearly expressed, and the text is amply illustrated by a store of exercises. . . . A work which treats an hackneyed subject with all the freshness one can look for in an elementary text-book."—Nature.

Exercises on Euclid and in Modern Geometry. By J. M. DOWELL, M.A., F.R.S. 4th Edition. Crown 8vo. 7s.

Introduction to Plane Trigonometry. By the Rev. T. G. VVYVAN, M.A., Senior Mathematical Master at Charterhouse. 3rd Edition. Crown 8vo. 3s. 6d.

Mathematical Examples. By J. M. DYER, M.A., and R. PROWDE SMITH, M.A. Crown 8vo. 6s.

The Elementary Geometry of Conics. By C. TAYLOR, D.D., Master of St. John's College, Cambridge. 7th Edition, Revised. Crown 8vo. 4s. 6d.

An Elementary Treatise on Solid Geometry. By W. S. ALDIS, M.A., Principal of the University College, Auckland, New Zealand. 4th Edition, Revised. Crown 8vo. 6s.

An Elementary Treatise on Geometrical Optics. By W. S. ALDIS, M.A. 2nd Edition. Crown 8vo. 4s.

An Introductory Treatise on Rigid Dynamics. By W. S. ALDIS, M.A. Crown 8vo. 4s.

Examples and Examination Papers in Elementary Physics. By W. GALLAGHER, M.A., Assistant Examiner London University. Crown 8vo. 4s.

Elementary Dynamics, for the use of Colleges and Schools. By WILLIAM GARNETT, M.A., D.C.L., Principal of the College of Physical Science, Newcastle-upon-Tyne. Fifth Edition, Revised. Crown 8vo. 6s.

Dynamics, a Treatise on. By W. H. BESANT, Sc.D., F.R.S., Fellow of St. John's College, Cambridge. 2nd Edition. Crown 8vo. 6s.

Heat, An Elementary Treatise on. By WILLIAM GARNETT, M.A., D.C.L. 6th Edition, Revised. Crown 8vo. 4s. 6d.

Elementary Hydrostatics. By W. H. BESANT, Sc.D., F.R.S. 75th Edition. Crown 8vo. 4s. 6d. Key, 5s.

A Treatise on Hydromechanics. By W. H. BESANT, M.A., Sc.D. Part I., Hydrostatics. 5th Edition, Revised and Enlarged. Crown 8vo. 5s.

WORKS BY A. B. BASSET, M.A., F.R.S.

An Elementary Treatise on Hydrodynamics and Sound.

Designed for the use of Students in the Universities. 7s. 6d. "A admirable specimen of an examination book. Mr. Basset is to be congratulated on having produced a work that ought to achieve success."—Nature.

A Treatise on Hydrodynamics. With numerous Examples.

Vol. I., 10s. 6d.; Vol. II., 12s. 6d. "The appearance of the present treatise is very welcome, containing as it does the results of the most important investigations in the mathematical theory of hydrodynamics which have been made in modern times carefully brought down to date as closely as possible."—Philosophical Magazine.

A Treatise on Physical Optics. 10s. 10s.

The Theory of Numbers. Part I. By G. B. MATHEWS, M.A., Fellow of St. John's College, Cambridge, Professor of Mathematics in the University College of North Wales. 8vo. 12s.

"We regard the book as a most valuable contribution to the small library of Higher mathematical treatises. . . . Part II. of the task Mr. Mathews has set himself to accomplish will, we hope, soon appear."—Nature.

Vol. III. Now Ready, Post 8vo. 7s. 6d.

Bright Fungus Flora. A Classified Text-book of Mycology. By GEORGE MASSEE, Author of "The Plant World." With numerous Illustrations.

"A Supplementary Volume, completing the Work, is in the press. "We have not the slightest hesitation in saying that it should be in the hands of every student, and on the shelves of every naturalist's library."—Naturalist.

London: GEORGE BELL & SONS.  
Cambridge: DEIGHTON, BELL, & CO.

TEXT-BOOKS FOR STUDENTS.

A TREATISE ON THE KINETIC THEORY OF GASES. By HENRY WILLIAM WATSON, D.Sc., F.R.S., formerly Fellow of Trinity College, Cambridge. Second Edition, Revised and Enlarged, crown 8vo. 4s. 6d.

"Dr. Watson's work has been for many years the recognised text-book on the kinetic theory of gases; it is well adapted to the wants alike of actual Motibrators and of would-be Wranglers."—Nature.

PRACTICAL WORK IN HEAT. For Use in Schools and Colleges. By W. G. WOOLLE COMBE, M.A., B.Sc., Senior Science Master in King Edward's High School, Birmingham. Crown 8vo. 5s.

"This book contains a practical course in heat that we should like to see introduced into every school which includes physical science in its curriculum."—Nature.

A TREATISE ON ELECTRICITY AND MAGNETISM. By J. CLERK MAXWELL, M.A. Third Edition. Two Vols. 8vo. 6s. 12s.

NOTES ON RECENT RESEARCHES IN ELECTRICITY AND MAGNETISM. Intended as a sequel to Prof. Clerk Maxwell's "Treatise on Electricity and Magnetism." By J. J. THOMSON, M.A., F.R.S., Professor of Experimental Physics in the University of Cambridge. 8vo. 12s. 7d.

"An important and learned work."—Times.

"Prof. Thomson is to be congratulated on being the author of a book which is well worthy of being called a sequel to Maxwell's great treatise. This volume is certainly the most important electrical book which has been written since the issue of Maxwell's work."—Electrician.

A CLASS-BOOK OF ELEMENTARY CHEMISTRY. By W. W. FISHER, M.A., Demonstrator of Chemistry, Oxford, late Fellow of Corpus Christi College. Crown 8vo. Cloth, 4s. 6d.

"The book is of sterling value, and will be welcomed by the teacher of elementary chemistry as a guide to his students, which he will have pleasure in full confidence in placing in their hands."—Nature.

HYDROSTATICS AND ELEMENTARY HYDROKINETICS. By G. M. MINCHIN, M.A. Crown 8vo. 10s. 6d.

"We can strongly recommend it."—Science and Art.

ELEMENTARY MECHANICS OF SOLIDS AND FLUIDS. By A. L. SELBY, M.A. Crown 8vo. 7s. 6d.

"A serious and painstaking work by a scholarly-minded mathematician."—Saturday Review.

Full Catalogue of Clarendon Press Publications, Post Free.

LONDON: HENRY FROWDE,

CLARENDON PRESS WAREHOUSE, AMEN CORNER, E.C.

MESSRS. WM. BLACKWOOD & SONS' PUBLICATIONS.

CAPTAIN LUGARD'S WORK ON BRITISH EAST AFRICA.

THE RISE OF OUR EAST AFRICAN EMPIRE. Early Efforts in Nyasaland and Uganda. By Captain F. D. LUGARD, D.S.O., Hon. F.R.G.S., Diplo. F.R.S.G.S. With 130 Illustrations and 14 Maps, specially prepared for the Work by E. G. RAVENSTIFF. 2 Vols., large 8vo. 11s. 8d. 9s. 42s.

"There are valuable chapters upon the vegetable and mineral products, the flora and fauna of the country, and many interesting details of the elephant and zebra."

IMMEDIATELY WILL BE PUBLISHED.

SCOTTISH LAND-NAMES: their Language and Lessons; with Rules to direct the Study of them. Being the Rhind Lecture in Archeology for 1893. By Sir HERBERT MAXWELL, Bart., M.P., A.itor of "Life and Times of the Right Hon. W. H. Smith, M.P." "Passages in the Life of Sir Lucian Elphin," "Meridiana." In One Vol., Crown 8vo.

NATURE BOOKS.

By "A Son of the Marshes"

WITH THE WOODLANDERS AND BY THE TIDE. Edited by J. A. OWEN. Second Edition, Crown 8vo. 7s.

"An indescribable charm links in every page of this entertaining work, the outdoor life of sedulous and loving observation. . . . The book cannot be too highly praised for widely read."—Daily Telegraph.

WITHIN AN HOUR OF LONDON TOWN. AMONG WILD BIRDS AND THEIR HAUNTS. Edited by J. A. OWEN. Crown 8vo. 6s.

"There is nothing better in the English language than the sketch of the wild land on the borders of Surrey and Hampshire."—Daily Chronicle.

ON SURREY HILLS. Fourth Edition. Crown 8vo. 6s.

"Charming descriptive power, added to an enthusiast's love of nature, could not fail to produce a delightful volume."—Land and Water.

ANNALS OF A FISHING VILLAGE. New Edition, with Illustrations. Edited by J. A. OWEN. Crown 8vo. 7s.

"No one who takes up the story of 'Den's' delightful life, and has been introduced to 'Scout' and 'Wind-r', to 'Titlark' and 'Genus,' will put the book down again until they have with much regret finished its last page."—Guardian.

WM. BLACKWOOD & SONS, Edinburgh and London.

## SUPPLEMENT TO "NATURE."

## THE STORY OF OUR PLANET.

*The Story of our Planet.* By T. G. Bonney, D.Sc., LL.D., F.R.S., &c. Pp. 592. (London: Cassell and Co., 1893.)

IN the workshop of science there are many labourers, both skilled and unskilled, and the particulars of their toil, which are not always interesting even to fellow-workers, can seldom be appreciated or even understood by the majority of well-educated persons. The increasing detail of geological work and the number of technical terms introduced, necessary as they are to progress, are calculated to repel not only the unemployed, who might like to gain a general knowledge of the subject, but also the numerous workers in other branches of science, who cannot keep themselves informed on the meaning of the many new terms. Nor can text-books, intended for serious study, be made interesting to the general reader, for the student wants his mental food in a concentrated form, with particulars sufficient for the class-room and examination; while the general reader can only be tempted with the net results of science in a diluted and yet attractive form. Such a reader, too, may approve of the Frenchman's dictum (quoted by William Spottiswoode in his address to the British Association, 1878), that no scientific theory "can be considered complete until it is so clear that it can be explained to the first man you meet in the street." It may, however, take a long time or a big book to do this, though we may agree that conclusions are not of much service unless they are intelligible.

In old days, Lyell's "Principles of Geology," as remarked by Prof. Bonney, "would have been understood with little difficulty by any man of good general education." Twenty-one years have passed since the last edition of that work was published, and we quite agree with the present author that there is "room for a book which covers somewhat the same ground."

The "Story of our Planet" is intended "for men and women of good general education who might desire to know something of the methods of reasoning which are adopted in geology, and of the general conclusions to which these have led." Thinking it would be helpful to get an independent opinion on the book, the writer, after cutting its leaves, placed the volume in the hands of his wife (who is by no means geological), and asked her to read a few pages. She did so, and without a pause read steadily to the end of the first chapter, exclaiming "It is most interesting." This independent testimony was satisfactory, but it requires a little qualification when applied to the volume as a whole. The author commences his work with an account of three specimens, taken almost haphazard, from a collection of fossils. Curiously enough, and perhaps unconsciously, he has returned to an old love, for one of the fossils is *Melania inquinata*, a shell which he obtained thirty-four years ago from the Eocene beds of Charlton, near Woolwich. It is mentioned among others in a short account, perhaps his earliest geological communication, which was printed in the *Geologist* for 1859 (p. 296). Since then the author has wandered in

many fields, and has found much happiness of a kind he is wishful to impart to others. Around Cambridge he has examined and written about the Cretaceous and Jurassic strata. He has gone deeper, and discussed the origin of Triassic rocks. Finally, he has descended to the lower regions, and plied his hammer among "The Foundation Stones of the Earth's Crust," as he would call them. Thus from the top to the bottom of the series he has studied the records of the rocks, but ever and anon the vestiges of ancient volcanoes have attracted great attention, and fired an enthusiasm that had, perhaps, to be tempered by many a visit to the Alpine glaciers.

Leaving the first chapter of the book, which, as we have hinted, is well calculated to attract and interest, we are introduced to "The Land Region," and find our-elves confronted with a good many statistics, after which we are led on to the study of the earth's crust and its rocky constituents. Then we come to "The Air Region," in which atmospheric pressure, winds and tornadoes, and rainfall are considered; and pass on to "The Water Region," to an account of oceans and seas, of tides and currents, of snow crystals and glacier ice. This concludes the first part of the work, which is almost wholly devoted to physical geography and meteorology. We had expected to proceed into the "Fire Region," but that is dealt with in Part iii. On the whole, this first part is somewhat disappointing from a geological point of view. Lyell would doubtless have given a good account of the geological results of the *Challenger* Expedition, but these are nowhere summarised.

Part ii. is devoted to the processes of sculpture and moulding, to the polishing of rocks by nature's "sand-blast," to the raising of sand-dunes and the formation of earth-pillars. The formation of escarpments is pointed out, with especial reference to those of the Weald, as explained by Foster and Topley, and the general action of rivers is described. Landslips receive attention; and here the author has himself made a slight slip, for we are told that near Lyme Regis "the cliffs rise to a height of full a hundred feet," but where the great landslip of 1839 took place, the chalk cliffs rise to 400 or 500 feet. "Ice as Sculptor" forms the subject of one chapter, and homely illustrations are given of the bursting of water-pipes, and of the crumbling of mortar and bricks in the jerry-built structures of the nineteenth century, facts which supply the tenant and landlord with useful object-lessons. On the more serious subject of glacier-erosion, the author's conclusions have certainly the weight of personal experience. He believes the effects of a glacier are considerable, but that it acts like a plane or file rather than a chisel or gouge. Yet he admits that the tarns in mountain corries, the lakelets in mountain valleys, may be attributed to the action of ice, but not the broad sheets of Geneva or Constance. The discussion is by no means dead, for quite recently Dr. A. R. Wallace strongly maintains the truth of Ramsay's theory (*Fortnightly Review*, December). "Ice as a Carrier" and "The Work of the Ocean" are duly considered in reference to the transport of material and the carving of features. We now come to the somewhat formidable heading, "The Proletariat of Nature," which may be taken to mean the actions of the lower classes of organisms, some of which

are destructive, some protective or constructive. Peat and coal are considered, so also Foraminifera, Radiolaria, and Corals. Part iii. is headed "Changes from Within," and the old Temple of Serapis comes before us as a witness to the fluctuations of level. Movements in the earth's crust, faults, flexures and overthrusts, and the formation of mountains are considered. We pass on to volcanic action and earthquakes, and eventually to the subjects of joints, spheroidal structures, nodules, and mineral veins, all of which are briefly noticed.

In Part iv. we come to what some may consider as geology proper; or, "The Story of Past Ages." Naturally we most of us like to go back to the very beginning, and glean what knowledge we can of the earth's probable origin; and the author briefly reviews the evidence. More interesting, however, is the chapter which deals with the eras and subdivisions in geological history, and we feel at any rate on *terra firma*. In regard to questions of correlation, the views of Prof. Huxley on "homotaxis" are given more prominence than some students of "zones" will admit to be justified by the present state of our knowledge. Nevertheless, it must be admitted that the philosophy of zones has yet to be understood, and, as the author urges, "geological contemporaneity from the general similarity of fossils must not be pressed too far." Each area must be interpreted as far as possible by its own evidence, and when the sequence of organic remains is found to be alike in areas widely apart, even the highest authorities do not claim precise, but only approximate, contemporaneity.

The Archæan era is one to which the author has paid much attention. It is a complex and comprehensive group, and barren of life, so far as our present knowledge goes. Many crystalline schists and gneisses are provisionally referred to this division, and the author is inclined to regard their general characters as a witness to their age. He points out how evidence to the contrary has in several cases broken down. Still, an attitude of reserve is desirable, when we bear in mind that great earth-movements have taken place in Tertiary times, and that deep-seated metamorphisms, as Mr. Barrow has shown in the south-eastern Highlands of Scotland, is all that is wanted to produce the results.

From the chaos of the Archæan era we pass on to a chapter dealing with "The Building of the British Islands," and we are furnished with a brief account of the Cambrian, Ordovician, and Silurian periods. Restorations of the possible geography of Britain in early Carboniferous and subsequent times are given, after Jukes-Browne, and we are led on stage by stage with brief descriptions through the series of formations. With regard to the origin of boulder clay, the agency of coast-ice is maintained in opposition to that of ice-sheets; but in this, as in other cases, where serious alternative opinions are held, the different views are stated.

"The Building of Europe and other Continents" is the next subject provided for us, and we are given a brief sketch of the history of the Alps. Then follows "A Sketch of the Earth's Life History," which might better have been incorporated with the accounts of the several formations whose history was previously told, for the leading types of life are treated stratigraphically. Here, in some respects, the popular meanings given to the names

of fossils are more amusing than useful. Thus we have the *Microlestes* or "little thief," the *Dromatherium* or "running beast," the *Turritella* or "cockspur," the *Plesiosaurus* or "neighbour-lizard," the *Pliosaurus* "more nearly a lizard," and so on.

The concluding part is "On Some Theoretical Questions." It deals with the age of the earth, which "is long but it is very far from being boundless." The author, in fact, as stated in his preface, thinks that we can discover "by processes strictly inductive, some sign of its beginning and some foreshadowing of its end." We are not disposed to challenge the statement.

The permanence of ocean basins and of land areas is a well-worn theme, on which "agreement ceases"; but the author is far from dogmatic on the subject. The problems of climatal change and of the distribution of life on the earth, form the topics discussed in the closing chapters.

The general reader who peruses this volume cannot but gain a sound general knowledge of geological science. In the ordinary sense of the term we cannot call it a very "popular" book, for it contains too much solid reading to please those who would read for entertainment. It must be read by those desirous of instruction; by them it will be appreciated, and for them we believe the work has been written. To the more serious student it will be of service in regard to Prof. Bonney's views; but as a work of reference it lacks importance, from the fact that the author does not, as a rule, cite original authorities, but gives references mainly to text-books and other works of a general character. That he has laboured with enthusiasm, and lightened his labours with many a pleasant, and sometimes a pungent, remark on things in general, will be evident to all who take up this volume.

#### CAYLEY'S PAPERS.

*The Collected Mathematical Papers of Arthur Cayley, Sc.D., F.R.S., Sadlerian Professor of Pure Mathematics in the University of Cambridge.* (Cambridge: University Press, 1889, *et seq.*)

LATE in the year 1887 the Syndics of the University Press requested Prof. Cayley to allow his mathematical papers to be reprinted in a collected form. To this he acceded, and also undertook the work of superintending the impression and of adding such notes and references as appeared to him desirable.

Cayley's papers, commencing in the year 1841, have appeared in every periodical mathematical publication of importance in Europe and America. A worker in pure mathematics, in whatever special department of geometry or analysis, is well-nigh certain to find that his subject has come under Cayley's hand, so comprehensive are the researches that he has presented to the scientific world. A study of one or more of these papers being thus inevitable, it is easy to appreciate the importance to a student of this wonderful collection—wonderful alike in regard to extent, to variety, and to quality. It is not our intention to attempt a sufficient review of the six volumes that have appeared in the five years that have elapsed since January, 1889. If this were the end in view, a volume would be necessary. On this occasion we purpose to glance rapidly at some of the great dis-

coveries, here set forth, which will be for ever linked to the Professor's fame.

The first volume comprises 100 papers, numbered consecutively and nearly in chronological order, produced between the dates 1841 and 1853. The paper No. 13, "On the Theory of Linear Transformations" (1845), marks a distinct epoch. Boole, in 1843, had proved the invariantive property of the discriminant of a quantic homogeneous in  $m$  variables, and Hesse, in 1844, had established certain covariantive properties of the ternary cubic. Here we find the general problem of "invariants" proposed, and some progress made towards its solution. The first step was the generalisation of Boole's theorem to a quantic of order  $n$ , containing  $n$  sets of  $m$  variables, the variables of each set entering linearly. This led to a function of the coefficients which possesses Boole's invariantive property, but it was not the discriminant as first pointed out by Ischläfli. This function, however, was seen by Cayley to necessarily satisfy a certain system of partial differential equations, and he was thence led to the capital discovery that a class of functions satisfied the same equations, and that each member of the class possessed the invariantive property. Other papers followed, and finally, in the year 1854, Cayley commenced the series of memoirs on Quantics which at intervals during the succeeding five-and-twenty years appeared in the *Philosophical Transactions* of the Royal Society. In this way the theory of algebraic invariants was gradually evolved. To this result there were many other contributors, notably Sylvester (to whom most of the nomenclature is due), Salmon, and Hammond in this country, and Aronhold, Clebsch, Gordan, and Hilbert in Germany. The first six memoirs are presented in vol. ii. of the collection. In vol. i. may be noted also the theory of conics of involution in connection with curves of the third order; the theory of "Pfaffians"; and the theory of surfaces of the third order. The last paper mentioned—a very important one—was developed in a correspondence with Dr. Salmon, to whom is attributed the enumeration of the twenty-seven lines on the surface. In vol. ii. we find in the notes which conclude the volume an account of the early bibliography of the theory of invariants; also the remarkable memoir on the theory of matrices, a subject which, at the present day, is exhibiting considerable vitality. The memoir appears to have been overlooked by mathematicians for more than twenty years after it appeared in 1858. The single exception appears to have been the paper by Laguerre, "Sur le Calcul des Systèmes Linéaires" (*Four. Ec. Polyt.*, t. xxv.), in 1867. However, the subject was ultimately taken up by Sylvester, in his "Lectures on Multiple Algebra," in the *American Journal of Mathematics*, and is now an important branch of pure mathematics, both in its results and in its ideas. The volume is also remarkable for researches on the "Partitions of Numbers," "Skew Symmetric Determinants," the "Theory of Groups," "Caustics," and "Curves of the Third Order."

Vol. iii. contains notably the contributions to dynamics and astronomy. There is the valuable "Report on the recent Progress of Theoretical Dynamics," from the "Report of the British Association for the Advancement of Science, 1857." The review extends from Lagrange,

1788, to Bertrand, 1857. It, principally, gives an account of the notable contributions of Lagrange, Poisson, Sir W. R. Hamilton, and Jacobi. There are papers on Lunar Theory, Elliptic Motion, and the Problem of Three Bodies; also an extensive series of "Tables of the Development of Functions in the Theory of Elliptic Motion." The paper (No. 221) "On the Secular Acceleration of the Moon's Mean Motion" is interesting as supplying an independent verification of Prof. Adams' correction of Plana's expression for the true longitude.

Vol. iv. is chiefly remarkable for the "Report on the Progress of the Solution of certain Special Problems of Dynamics," from the Report of the British Association for the Advancement of Science for the year 1862. At the commencement the author adverts to a serious omission in his former report in volume iii. This has reference to the memoir by Ostrogradsky, "Mémoire sur les équations différentielles relatives au problème des Isopérimètres," *Mém. de St. Pétersbourg*, t. iv., 1850, which contains, in the most general form, the transformation of the equations of motion from the Lagrangian to the Hamiltonian form, and also the transformation of the system arising from any problem in the calculus of variations to the Hamiltonian form. The remark is also made that in a work by Cauchy, "Extrait du Mémoire présenté à l'Académie de Turin le 11 Oct., 1831," published in lithograph under date Turin 1832, there is satisfactory evidence that Cauchy, in the year 1831, was familiar with the Hamiltonian form of the equations of motion. Mention is made of papers on theoretical dynamics, notably by Bour, Jacobi, Natani, Clebsch, and Boole, which had appeared subsequent to the writing of the first report.

The second report includes various problems relating to the "particle" and the "solid body," "the problem of three bodies," &c. A list of memoirs is added, and increases the historical value of the report. One paper, No. 265, "Addition to the Memoir on an Extension of Arbogast's Method of Derivations," is published in this volume for the first time. The general subject of "quantics" is resumed in a seventh memoir, which is principally devoted to ternary forms. An important paper is that on the "Theory of Equations of the Fifth Order." The quintic equation cannot be solved algebraically. By the "resolution of the quintic" mathematicians understand the expression of its roots in terms of those of its resolvent sextic. During the fifteen years preceding 1861 considerable progress had been made with this problem by Cockle and Harley. In the year mentioned Cayley obtained a new auxiliary sextic equation, and showed that the roots of the quintic are, each of them, rational functions of its roots. A fresh impulse was given to the subject by George Paxton Young and Emory McClintock in vols. vi. and viii. of the *American Journal of Mathematics*, 1884-1886. The former indicated the general form of the roots of the quintic, and the latter made it possible to directly and visibly express them. In a long note at the end of the volume Prof. Cayley supplies the links between his own work and the later work of McClintock, which he considers very important and remarkable. In vol. v. there are two papers on the theory of curves in space, and in the "notes" the Professor gives his present views, taking into considera-

tion the later work of Halphen, Nöther, Valentine, and Hilbert. These authors make considerable use of Cayley's conception of the monoid surface, the curve being regarded as the partial intersection of a cone with a monoid surface; Halphen obtained the fundamental theorem which shows the existence of a monoid surface of order  $n + 1$ , where  $n$  is the order of the cone of lowest order which passes through all the nodal lines of the aforesaid cone. Important remarks are made on the theory arising from this notion. In the Professor's view, the question of the classification of curves in space, according to the representation, as the partial intersection of a cone and a monoid surface is that which properly first presents itself.

There are many papers on geometry, including those on "skew surfaces" and "sextactic points of a plane curve," with which all geometers are familiar.

The paper No. 347, "On the Notion and Boundaries of Algebra," considers in particular the line of separation between finite and transcendental analysis. The views of so eminent a man on this subject are necessarily of interest and importance. In stating algebra to be both an art and a science, the author is in agreement with the constantly reiterated opinion of Prof. Sylvester, and indeed with that of the great majority of those who have made algebra a subject of special study. The two great divisions of algebra are stated to be "tactic" and "logistic," and the remark is made that every algebraical theorem rests, ultimately, on a tactical foundation. Mathematicians will, we think, perceive in the word "tactic" a singularly felicitous expression to denote those operations which relate to an arrangement of material.

The paper No. 312, "On the Partitions of a Close," generalises Euler's polyhedral relation,

$$F + S = E + 2$$

and is a first step towards Listing's well known developments.

The frontispiece of vol. vi. is a portrait of Prof. Cayley, attired in gown, seated at his desk in the act of writing. The picture is somewhat dark and not quite so pleasing as those which of recent years have appeared in NATURE and in the *American Journal of Mathematics*. The volume is principally on geometry. The memoir No. 412, on "Cubic Surfaces," adopts a classification depending on the nature of the singularities. In the notes the notation is compared with that of Zeuthen, and several apparent discrepancies in the results are explained.

There is a long memoir on the polyzomal curves

$$\sqrt{U} + \sqrt{V} + \dots = 0$$

$U, V, \&c.$ , being rational integral functions of the same degree in the variables. The general  $r$ -zomal curve (*i.e.*  $r$  functions  $U, V, \&c.$ ) is considered, and the branches, singularities, order, class,  $\&c.$ , determined. The investigation is intimately connected with Casey's work, on Bircircular Quartics, published in 1867 in the Proceedings of the Royal Irish Academy.

Other geometrical subjects considered are "Reciprocal Surfaces," "Skew and Developable Surfaces," "Abstract Geometry," "Cubical Divergent Parabolas,"  $\&c.$  In

analysis we have the eighth memoir on quantics, which relates chiefly to the binary quintic; and, finally, mention may be made of the reproduction of Euler's memoir of 1758, on the rotation of a solid body.

The number of papers which appear in the six volumes is 416. Several hundreds of papers have yet to appear, and it seems improbable that a total of ten volumes will be found sufficient. This improbability is increased from the circumstance that Prof. Cayley is still producing a considerable amount of mathematical work.

For excellence of mathematical printing, and general care of production, unstinted approval may be awarded to the Cambridge University Press. These handsome volumes, as they appear, are rearing a fitting monument of the work of an eminent man, and are causing gratification and congratulation amongst mathematicians the world over.

P. A. MACMAHON.

#### THE PAMIRS.

*The Pamirs: being a Narrative of a Year's Expedition on Horseback and on Foot through Kashmir, Western Tibet, Chinese Tartary, and Russian Central Asia.* By the Earl of Dunmore, F.R.G.S. In two volumes. (London: John Murray, 1893.)

LORD DUNMORE embodies in these volumes the journal of a somewhat remarkable journey of a year's duration, the initial and terminal points of which were Karachi and Constantinople. During most of the time he was accompanied by Major Roche, and the object of the journey was sport, especially the pursuit of the *Ovis poli*. Unfortunately this great sheep—of which Lord Dunmore (vol. ii. p. 56) appears to doubt the ovine character—inhabits a country the political geography of which is still undergoing spasmodic evolution, and there is reason to suspect the censorship of the Indian Government on all English writings bearing on the region. Thus we cannot expect any great contributions to the detailed topography of the Pamirs to be made public, and as the author makes no claim to any scientific acquisitions, the botany and geology of the vast tracts wandered over are left no clearer than they were before. Major Roche, however, made an entomological collection. It is deeply to be deplored that every traveller, who is so fortunately circumstanced as to be able to push his way where few intelligent Europeans have been before, should not make some sort of preparation to fit himself for utilising his rare opportunities. For such preliminary instruction in science the Royal Geographical Society has made ample provision specially adapted to the wants of travellers, and as years go on we trust that the imputation of ignorance of what and how to observe may no longer be the necessary prelude to the criticism of works of travel in a scientific journal. Major Roche was fortunately provided with a camera, and made splendid use of it, although most of his negatives were unfortunately destroyed. Lord Dunmore himself is something of an artist, and much value must be attached to the landscapes which illustrate his book. Both travellers carried aneroids and, presumably, some surveying instruments, as a map with several new features is one of the results of the journey. We may point out that the larger-scale map of the Pamirs should have been

bound with vol. ii, in which alone that region is discussed, while the general map showing the route to Yarkand would be more useful in vol. i. One other criticism must be made before turning to the pleasanter

each volume, we can only guess darkly from the context the significance of *chikore*, *chit*, and *fank*, to mention only a few we have puzzled over.

Lord Dunmore has travelled extensively in many parts



FIG. 1.—Ovis Pam.

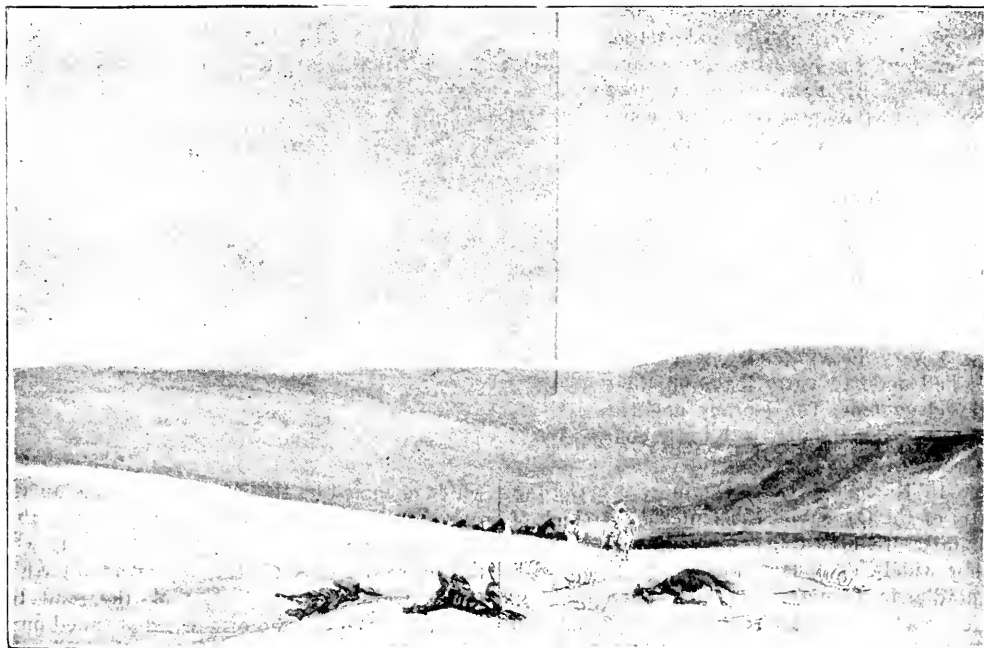

FIG. 2.—The Roof of Asia, plateau 18,000 feet above sea lev.l.

consideration of the merits of the work. Native words are introduced in unnecessary profusion, and although *akoi*, *jigit*, *puttoo*, and seventy-five other uncouth terms are interpreted in a glossary considerably prefixed to

of the world, and he is able to brighten his descriptions by many shrewd comparisons with distant places and diverse peoples. His power of description is above the average of the sporting traveller, and from first to last

the two volumes may be read with pleasure and with profit. It is particularly pleasing to notice the reticence regarding his own doings, and the generous recognition given to his native attendants and the merchants and officials who showed his party kindness by the way.

Starting from Rawal Pindi on April 9, 1892, Lord Dunmore passed through Kashmir to Leh over familiar ground, climbed the Laoche Pass (18,000 feet) on yaks, crossed the Shyok valley, the scenery of which appeared on a grander scale than any in the Rocky Mountains, and completed the outfit of the expedition at Panamik, the last outpost of civilisation. On July 1, the expedition, including 30 men, 60 yaks, and 56 ponies, left Panamik, crossed the great Dapsang Plateau, an undulating plain averaging over 16,000 feet of elevation, which Lord Dunmore names "the Roof of Asia," easily surmounted the Karakoram Pass (about 19,000 feet, but all these measurements varying within a few hundred feet as determined by different aneroids), and reached Yarkand on August 4, after passing through the finest scenery of the whole journey. For eight days they camped at elevations exceeding 17,000 feet, but experienced no difficulty from mountain sickness. At Yarkand fresh supplies were laid in, and on August 13 the expedition set out again, crossed the waterless desert of Shaitankum, penetrated the difficult "Sariq-qol" country, and on September 6 formed a permanent camp in the Kukturak valley of the Taghdumbash Pamir, at an elevation of 15,000 feet. It was too late in the year for good sport, as the *Ovis poli* were able to find pasture close to the edge of the perpetual snow, and were often driven by herds of wild dogs right up amongst the glaciers; but some sport was obtained and the camp inhabited in spite of the growing cold until October 30. The Kirghiz were found to be an extremely hospitable and pleasant people whenever their encampments were visited, but they were curiously lacking in notions of space or time. They could not in the least understand the laboriousness of the Tibetan coolies, supposing that only as a very heavy punishment could people be called upon to carry loads on their heads, or travel on foot. The journey now led zig-zagging across the Pamirs, in bitterly cold weather, past frozen lakes and along the beds of

frozen rivers to Kashgar. Lord Dunmore crossed the source region of the Oxus, and speculates as to which of several tributaries, rising within a few miles of each other, but pursuing widely devious routes, is the true "high mountain cradle in Pamere." From a geographical point of view such a discussion is vain, since only an accurate survey could decide which stream of all the streams was the longest, highest, or possessed of the greatest drainage area, and then it is a matter of hair-splitting definition to determine whether one or another of several nearly equal tributaries should retain the name of the main stream. There is, we imagine, no system akin to primogeniture which could discriminate the

rights of the twin or triplet sources of the Amu-daria to exclusive physical continuity with the mature river in which they all converge. The similarity of the name Aksu, which belongs to one of them, with the name Oxus, even if, as Lord Dunmore urges, not accidental—which it certainly is—could only prove that an earlier and more ignorant generation had imagined some sort of continuity. On Lake Victoria, in the Great Pamir, a thousand miles from the sea, Lord Dunmore reports that he saw a common seagull, but he did not secure the specimen. He also discovered a new pass leading to the Alichur Pamir, to which he gave the name of Hauz Dawan, from a remarkable cistern-like lakelet



FIG. 3.—The Gez defile.

which occupied its summit. Following up the Alichur river and crossing the Rangkul Pamir, the caravan wound its way through the long Gez defile which forms the narrow access to Kashgar, and after a short stay under Chinese protection, took the road to Osh, in Russian territory, where it was disbanded on January 1, 1893. Major Roche returned to Kashmir, the Russian officials not allowing him to cross the frontier, and Lord Dunmore proceeded by tarantass and sledge through Khokand and Tashkent to Samarkand, whence the trans-Caspian Railway brought him back to Europe.

The meteorological data obtained are incomplete, as the registering thermometers were only graduated to



—20° F., and could not be left outside the tents at night for fear of damage to the index by the low temperatures experienced. They are not tabulated, nor is there a detailed itinerary, but an interesting appendix shows graphically the heights of the various passes as compared with the summit of Mont Blanc.

The illustrations reproduced are selected from a profusion of admirable pictures. Fig. 1 represents the *Ovis poli* in their summer feeding-grounds close to the snow-line, and the others are typical of the most impressive plateau and gorge scenery of the region.

### THE GENUS MADREPORA.

*Catalogue of the Madreporarian Corals in the British Museum (Natural History).* Vol. 1. "The Genus Madrepora." By George Brook. (London, 1893)

IT is with feelings of sad regret that we turn over the pages of this monograph. Mr. Brook laboured long and hard at the book, carried it through the press, but did not live to see his labours recognised by his colleagues. His sudden and premature death has already been noticed in NATURE (vol. xlvi. pp. 376, 420), and the present writer would like to add his testimony to the accurate and painstaking character of the work of George Brook. Happily free from pecuniary anxiety, he was able to, and did, devote his time to scientific work without regard to its paying qualities, either as to money or to immediate scientific reputation.

The monograph now under review was to be the first of a series of memoirs on the classification of the Madreporaria which were to form part of the great series of the catalogues of the British Museum. As a detailed account of the anatomy of soft parts, of histology, and of morphological problems is foreign to the general plan of this series, we must not expect to find these subjects fully dealt with in this volume; but Mr. Brook does give a succinct account of the anatomy of the genus Madrepora, so far as is at present known. For some years Mr. Brook had been studying the anatomy of the Madreporaria, and in due time he would have published his results, which would have been of great value. It is to be hoped that what has already been accomplished by him, but not yet published, will not be lost to science.

The name Madrepora appears to have been first used by Imperato in 1599; but its precise significance, or rather the sense in which the term was originally employed, does not appear to be generally understood. Imperato clearly regarded what we now speak of as the "corallum" as a stony "nurse," in the porous cups of which animal polyps undergo their development, and "stony mother" appears to indicate the meaning intended. There is no doubt that the word is, in the first instance, Italian, and Linnæus applied it to the same group of zoophytes as Imperato had done. As, however, the term was originally used to indicate the "maternal" character of the "stone" rather than its porosity, it appears that the root should be referred to the Greek *πάρος*, *i.e.* stone, and the English pronunciation of the word altered accordingly. There is no need

to detail here the complicated synonymy of the name; it is evident that its retention depends for its justification on custom rather than on priority. Dana and all subsequent writers, except Ehrenberg, have followed Lamarck who retained Linnæus's name for non-typical species (*M. muricata*) of the original species. Ehrenberg proposed in 1834 a new name (Heteropora) for the restricted genus as we now know it, but unfortunately his name had been preoccupied by Blainville. Prof. F. Jeffrey Bell (*A. N. H.* viii. 1891, p. 109) has also shown that the name "Holothuria" is in an analogous position. In these and similar cases, good sense, rather than a rigid adherence to rules of priority, should determine the retention of a well-known name, especially when zoologists are agreed as to the forms which are included under the term in question; but in the great majority of cases it is better to adhere to the generally accepted rules.

Dr. Duncan (*A. N. H.*, 1884, p. 181) has given an account of the structure of the corallum in three varieties of growth. As was to be expected, the quick-growing species have a lax tissue, while the slow-growing forms are very dense. Mr. Brook objects to the use of the term "costæ" for the external longitudinal ridges on the wall. The porous corallite wall is essentially composed of synapticulae, and is therefore not a theca, as it differs both in structure and origin. According to G. von Koch's view of the origin of a theca, costæ are to be regarded as the distal extremities of septa which pass beyond the thecate wall. In the genus Madrepora the so-called costæ undoubtedly do not come under this category. They appear before the septa, and bear no regular relation to them, either in number or position.

Although the Anthozoa are generally regarded as typical radiate animals, those who have studied their embryology and anatomy recognise a fundamental bilateral symmetry which is masked by the tendency to a radial habit which characterises sessile forms. The typical number of septa is 12, viz 6 primary and 6 of a second cycle, which is usually less developed; rarely a third cycle occurs; in many species the primary cycle alone is present. The septa are generally most fully developed in the axial corallites. It is often stated as characteristic of the genus Madrepora that the axial or directive septa are more prominent than the other primary septa; but this is by no means always the case; nor is that condition confined to the genus. Whilst in axial corallites the most usual arrangement is for the primary septa to be sub-equal, in the radial corallites the directive septa are most frequently better developed—either stouter or broader—than the other primaries. In certain groups of species, however, the outer directive septum is more important than the inner; and in case only one septum is present, it is invariably the outer directive. It appears that in these cases the corresponding tentacle is longer than the remaining eleven.

For a knowledge of the soft parts, we are mainly indebted to Dr. Fowler (*Q. J. M. S.* xvii. 1886, p. 1), although Mr. Brook did not omit to make investigations on his own account. The structure of the polyp is, in its general features, Actinian, but there is a marked bilaterality

arrangement of parts. The corallum is penetrated by an intercommunicating series of canals which put the coelentera of all the polyps into communication with each other. The mouth is elongated in the sagittal axis. The stomatodæum is supported by twelve mesenteries. The two pairs of directive mesenteries, and one mesentery on each side (Nos. 4 and 9 of Fowler's Fig. 8) — which, as in the Antipatharia, may be termed the transverse mesenteries, and are the first to be developed—are more important than the others, and extend to a lower level: they are also the longest, and are the only ones which bear reproductive organs. Similar elongate mesenteries occur in Alcyonaria, in Antipatharia, and in Seriatopora and Pocillopora amongst the Madreporaria. In Antipatharia, also, they are the only ones which bear reproductive organs. The present writer has more than once (Trans. Roy. Dublin Soc. iv. 1889, p. 300; Proc. R. D. S. 1890, vii. p. 128) suggested the employment of names for the primary mesenteries which are independent either of empirical numbers or of the order of their appearance in ontogeny. According to that enumeration, here, as in the Actiniaria generally, the first mesenteries to appear are the sulculo-sulcar laterals (Lacaze Duthiers' 1, and Fowler's 4 and 9). In *Madrepora Durvillei* the other important mesenteries are the sulculo-sulcular laterals and the sulcar directives, to which must be added in *M. aspera* the sulcular directives. The inconspicuous mesenteries are the sulco-sulcar laterals and the sulco-sulcular laterals (with the addition of the sulcular directives in *M. Durvillei*). There may be details of structure peculiar to certain species of *Madrepora*, or even to individuals, as in dimorphic forms; but the relative values of the several mesenteries can be matched in the young and in some adults of the Actiniaria, and in the larva of Euphyllia, and among other Madreporaria.

We cannot enter into the question of classification or the characters upon which classifications have been based; suffice it to say that Mr. Brook relies primarily on the structure of the corallum. Very little is yet known upon the arrangement of the soft tissues in their relation to the corallum. It is to be expected that the varied skeletal characters are the outcome of a difference in the structure or arrangement of the soft parts; in the meantime the corallum is all there is to deal with, and the author has naturally assumed that a similarity of structure involves a close relationship, and therefore places little reliance on habit. To a certain extent the species fall into well-marked groups, if one does not regard habit of prime importance. The genus is divided into ten divisions or sub-genera; the chief place is given to the character of the axial corallite (this is analogous to the growing point of the stem or branches of a plant), and secondly to that of the radial corallites which are produced by means of indirect budding around the wall of an axial corallite. The texture of the corallum is also an important diagnostic feature, and of least value is the mode of growth or habit. We are at present quite in the dark as to the reasons why individuals of the same species should grow in a flabellate (or palmate) manner, or be luxuriantly arborescent; there is, however, a general tendency for the members of a morphological group to have a similar habit of growth.

Those who have attempted to name specimens of

madrepores from the older descriptions will welcome this masterly monograph; but it is to be regretted that outline figures illustrating the details employed in classification were not appended to the synopsis of the sub-genera on p. 22. The colotype plates, although beautifully executed, illustrate more the general habit, and the critical characters therein are not readily discerned.

The genus *Madrepora* contains a large number of species. Mr. Brook recognises 221, of which the British Museum has 180 species out of a total of over 1100 specimens. Mr. Brook reduced 169 old species to 130 in number, but has been obliged to describe 91 new species; of these 62 appeared in the *Annals of Natural History* for 1891 and 1892. No fossil representatives are alluded to. Mr. Brook had travelled extensively in Europe in order to study the type specimens in various museums, but he had not seen the types in American museums. Eighty-six species are illustrated in the twenty-five plates, which are beautiful collotypes by Messrs. Morgan and Kidd, from the author's own negatives. Owing to the necessity for large plates the monograph is quarto in size, instead of the usual octavo of the other catalogues of the British Museum.

It is by no means an easy task to identify the species of this genus, owing to their number and varied habit. The genus *Madrepora* is now flourishing abundantly, and it is difficult in some cases to determine whether certain forms should be regarded as species or varieties. It is widespread, abundant, and variable forms, such as these, which are the despair of old-fashioned systematists, but serve as stimulating problems for the modern naturalist.

ALFRED C. HADDON.

#### PHYSIOLOGICAL CHEMISTRY.

*Physiological Chemistry of the Animal Body.* By Arthur Gamgee, M.D., F.R.S. Vol. II. The Physiological Chemistry of Digestion. London: Macmillan and Co., 1893.

THE examination of the subject of physiological chemistry may obviously be made from two separate points of view. In the first place, the different problems of the subject may be discussed from the standpoint of the organic chemist, who looks to physiology for illustration and extension of truths established by laboratory practice. In the second place, the various chemical processes occurring in the animal body may be considered from the biological standpoint, and here the domain of chemistry is invaded simply as far as necessity compels for the adequate comprehension of the biological problems presented.

The result of writing a treatise from either of these points of view alone is to largely limit the usefulness of the work, and yet it requires no inconsiderable courage to attempt to furnish a work which may be of important service both to the chemist and biologist. Dr. Gamgee has, however, been inspired with the courage of his well-recognised ability, and has presented the scientific world with a work which must at once appeal to the chemist for the thoroughness of its chemical explanation and detail, and to the biologist for the general completeness of its critical review of physiological work.

Dr. Gamgee expresses the hope that the text-book may supply a want which is at present experienced of some guide to the more advanced student and original worker. The fulness of the references given in the work alone would warrant this hope being fulfilled; and the fact that some of the most recent work is included in the volume will not lessen its anticipation. The author has not confined himself to purely physiological considerations. The pathology of jaundice, the pharmacology of ieterogenic poisonous agents, the formation of gall-stones, and the nature of the gastric contents in different pathological conditions, are all treated with an amount of fulness that might not be expected in a work on physiological chemistry.

In addition to the general record and criticism of physiological work, all the important analytical methods are supplied, and it will be to some an encouragement to know that Dr. Gamgee has himself tried, as far as possible, all the experimental processes mentioned.

The present volume does not complete Dr. Gamgee's treatise on physiological chemistry. He proposes, after re-editing the first volume, to finish his work with yet another volume giving the results of a study from the chemical point of view of other animal functions. We may be permitted to express the hope that circumstances will favour the elapse of a much shorter interval than has occurred between the publication of volumes i. and ii. At the same time, the vast amount of important work that has been done during the last decade, and which has largely revolutionised our ideas of the physiological chemistry of digestion, makes the present time auspicious for the presentation of a record of such work.

The present volume is divided into thirteen chapters of varying length. The first is occupied with a consideration of *saliva*. The most recent views as to the constitution of the starch molecule, and the results of the action upon it of a diastatic ferment, are well described.

The second chapter, however, which treats of gastric digestion, will probably be regarded as the most important in the book. It commences with a short histological account of the structure of the stomach. We think that these short histological descriptions are out of place in the present work; they are not sufficiently full to be of much value to those who are likely to have occasion to use the book. The histological preliminaries are succeeded by a historical account of our knowledge concerning gastric digestion, in which the views of Van Helmont, Sylvius, Borelli, Réaumur, and Spallanzani are recorded. The nature of pepsin, the method of preparing artificial gastric juice, the nature of the acid of the stomach, are all treated upon with considerable detail. Then follows an account of the changes occurring in proteids by the action of gastric juice. After referring to the views of Meissner, Brücke, and Schutzenberger, the author goes on to record the observations and views of Kühne. The large amount of work done in recent years by Kühne, Chittenden, and Neumeister in the direction of refining our knowledge of what a few years ago was called *peptone*, is fully described. We are disposed, however, to take part with Halliburton in preferring the term *proteose* to that of *albumose*. Dr. Gamgee considers that a confusion might arise between the term *proteose* and *proto-albumose*, and prefers the general term

*albumose*. But the difficulty at present experienced of causing students to understand that albumose can be derived from other proteids than albumin makes the confusion suggested by Dr. Gamgee a comparatively insignificant matter. When the terms *globulose*, *caseose*, and so on exist, it is obviously unscientific to retain the term albumose as embracing all these bodies. We are hopeful, therefore, that the change suggested by Halliburton will gradually find its way into our physiological text-books.

The milk-curdling enzyme of the stomach is referred to, and a brief account of the change that milk undergoes by its action is given. Dr. Gamgee prefers to leave a detailed consideration of these changes to a later volume dealing generally with the chemistry of milk. We think it is more desirable to treat of the change milk undergoes at the instance of a ferment in the stomach in connection with gastric digestion than at any other place. There is a rather unaccountable inconsistency in Dr. Gamgee's reference to absorption of water in the stomach. On p. 154 he states in the paragraph indicator that the stomach is "the seat of absorption of much water." In surveying the work on this subject later (p. 439 *et seq.*) he describes how recent research has established beyond a doubt the fact that the stomach does not absorb water at all (p. 441, line 20).

The third chapter treats very fully of pancreatic digestion, and appears with that on bile (chapter iv.) to be amongst the best in the volume. In connection with the latter the author has given us some very beautiful reproductions of MacMunn's spectra of bile-derivatives. The nature of the albuminoid substance of bile is referred to, and the fact that it is no longer to be regarded as *mucin*, but as a *nucleo-albumin*, is emphasised. The nature of nucleo-albumin is also briefly described. The digestive processes occurring in the small intestine are treated of in chapter ix. The different methods of experimenting are fully described. As regards the action of the enzyme of the intestinal juice, we think Dr. Gamgee has been somewhat over-influenced by tradition, which has led him to attach perhaps too much importance to its existence and action. And the fact that observers have always experienced more difficulty in obtaining positive results with extracts of the fresh mucous membrane than with so-called intestinal juice, justifies us in accepting with considerable caution inferences based upon observations on so-called permanent fistulae.

The last chapter is devoted to a description of intracellular digestion in lower invertebrata, the digestion occurring in fishes, birds and ruminants, and supplies a becoming sequel to a comprehensive work.

Appendices are added, giving in more detail Neumeister's views concerning the albumoses, some very recent work of Kühne on the separation of albumoses and peptones; also some additional methods for the detection and estimation of the acidity of the stomach.

We should have preferred to see the index divided into two portions—one treating of subjects and the other of authors. A few mistakes occur in it, but only of trifling importance; however, it has the defect of being somewhat incomplete.

Taken altogether, we have only congratulation to offer to Dr. Gamgee on the production of this work, and have

no hesitation in stating that he is certainly justified in hoping, as he does in the preface, "that the present volume may . . . further the advancement of, and prove not altogether unworthy of, the present position of Physiology in England."

J. S. EDKINS.

AN ESSAY ON NEWTON'S "PRINCIPIA."

An Essay on Newton's "Principia." By W. W. Rouse Ball. (London: Macmillan and Co., 1893.)

THE name of Newton has become now quite a household word amongst us, and one instance of its familiarity was strikingly brought home in an answer given by a small child, who when asked who was Newton, replied, "the man who found the first apple!" That two important epochs in the world's history should have been marked by the presence of this fruit, seems curious indeed; and Mr. Ball informs us that the apple anecdote in Newton's case rests on good authority, for besides written evidence, local tradition confirms it by the careful treatment the tree received, which kept it alive until the year 1820.

For the essay which we have before us, Mr. Ball should receive the thanks of all those to whom the name of Newton recalls the memory of a great man. The "Principia," besides being a lasting monument of Newton's life, is also to-day the classic of our mathematical writings, and will be so for some time to come. During Newton's lifetime three editions of this great work were brought out, the first appearing in 1687; the second, edited by Cotes, in 1713; and the third, by Pemberton, in 1726. Since the last-mentioned date, the history of the "Principia" has been discussed by Sir David Brewster and Prof. S. P. Rigaud, but both of these works are now out of print and very scarce. At the present time, as Mr. Ball informs us, it seems fitting to collect, from these and other sources, the references to the leading events in the preparation and publication of the "Principia," and the present volume contains the result of his labours. In the subject-matter, of course, there is much that is not new, but the value of the work lies in the fact that, besides containing a few as yet unpublished letters, there are collected in its pages quotations from all documents, thus forming a complete summary of everything that is known on the subject.

Mr. Ball divides his essay into six main sections, dealing with Newton's investigations in 1666, in 1679, in 1684, in 1685-1687, compilation and publication of the "Principia," the two last treating of the contents of the "Principia," and the subsequent history and preparation of later editions.

Mr. Ball commences with the works of Newton at the time when the latter had taken his degree at Cambridge, and therefore had more leisure to pursue his studies in his own way. The reader is made acquainted with Newton's early views, and there are several interesting quotations from some original manuscripts inserted. The investigations of 1679 refer, in great part, to the correspondence he had with Hooke, which turned his attention to the problem of planetary motion. It was in this year that Newton suggested the method of demonstrating the earth's motion of rotation on its axis by the letting fall of

a stone from a high position, and observing the direction of the deviation from the vertical; he also repeated his calculations (with new data) for finding the relation between terrestrial gravity and the centripetal force which retained the moon in her orbit.

In 1684, Halley, after attempting to deduce the motion of the heavenly bodies from Kepler's laws, with unsuccessful results, made a visit to Cambridge, when he found that Newton "had brought this demonstration to perfection." During that year Newton gave in his professional lectures an account of his work then in manuscript form, entitled, "De Motu Corporum," which may be said to be "a rough draft of the beginning of the first book of the 'Principia.'" This period includes also Halley's second visit to Cambridge with reference to Newton's publication of this tract, and it was at this time also that Halley asked him to communicate his results to the Royal Society. The tract which Newton finally communicated was entitled, "Propositiones de Motu," and may be looked upon as marking the point at which Newton had arrived about the end of this year. Mr. Ball reproduces this tract *in extenso*, as it has only once been printed, and copies of it are scarce.

The fifth chapter deals with the investigations from 1685 to 1687, during which time Newton was preparing the "Principia." A most interesting account is given of the details concerned in the preparation of the subject-matter, while he refers also, by no means too fully, to the extreme generosity that Halley displayed, both as regards the cost of printing the books, and also to the interest he took in their progress, criticising some parts, and revising sheets for press. Rigaud, in his essay on the first publication of the "Principia," referring to this point, says, "that under the circumstances it is hardly possible to form a sufficient estimate of the immense obligation which the world owes in this respect to Halley, without whose great zeal, able management, unwearied perseverance, scientific attainments, and disinterested generosity the 'Principia' might never have been published." Mr. Ball also discusses here briefly Newton's controversy with Hooke, "the universal claimant," as he was called.

Chapter vi. is devoted to an analysis of the "Principia," a few words of introduction relating to the main differences between the first editions being given. Mr. Ball limits himself in the main to a statement of the propositions, lemmas, &c., but occasionally he breaks in with a few words of explanation, or of historical interest.

The remaining period, ending with the year 1726, contains matter dealing with the large correspondence Newton had on the contents of his "Principia," to his revision of the whole work, the extension of some of the results, and finally to the preparations of the two later editions.

The appendices contain the correspondence between Newton and Hooke and Halley, besides some memoranda on the correspondence concerning the production of the second and third editions.

From the above brief sketch of the contents of this essay, our readers may perhaps gather some idea of the ground it covers. The author is so well known a writer on anything connected with the history of mathematics, that we need make no mention of the thoroughness

of the essay, while it would be superfluous for us to add that from beginning to end it is pleasantly written, and delightful to read. Those well acquainted with the "Principia" will find much that will interest them, while those not so fully enlightened will learn much by reading through this account of the origin and history of Newton's greatest work.

#### WELLS ON ENGINEERING DESIGN.

*Engineering Drawing and Design.* By Sydney H. Wells, Wh.Sc., A.M.Inst.C.E. In Two Parts. (London: Chas. Griffin and Co., Ltd., 1893.)

THIS book is intended for the use of engineering students in schools and colleges, and as a text-book for examinations in which a knowledge of practical geometry and machine drawing is required. The author says in the preface that the chief reason which has led to its preparation is that during the time he was engaged in teaching on the engineering side of Dulwich College, he found it impossible to obtain a suitable text-book.

The work is published in two parts. Vol. i. deals with the geometrical part of the subject, but includes many references to practical questions and machinery wherein is to be found the applications of the particular geometrical construction. In the earlier treatment of this subject we find much excellent instruction for beginners, written in a clear and concise manner. The methods of construction described are all clearly illustrated, and appear to have been chosen from the best examples.

Vol. ii. deals with "machine and engine drawing and design." In the preface we find the following statement: "A student ought not to be told the sizes of bolts and nuts, or the diameter of flanges, or the details of stuffing-boxes, in drawing an engine cylinder, any more than we should expect to have to prove to him the truth of the triangle of forces, at each step in the graphical determination of the stresses in a roof truss." This statement evidently comes from the technical school view of mechanical engineering. The triangle of forces is certainly a safe assumption; but to allow one of Mr. Wells' students fresh from college to run wild in a drawing-office of an engineering works where standards are the rule, and not the exception, would be a treat not to be missed. No doubt he could turn out an excellent "technical school" drawing, but whether it would "pay" is another matter. A draughtsman generally has standards for flanges, glands, studs, &c. for an engine cylinder. Notwithstanding this, we congratulate the author on the contents of vol. ii. of his book; he has gone as far as he can to lead his students into the way of being draughtsmen; and of course this, after all, can only be accomplished—or, rather, completed—in the drawing-office of a mechanical engineer.

For the many examples and questions included in the second part we have nothing but praise; they are taken from every-day practice, and are amply elucidated. On page 183 we are told that copper pipes are made from malleable sheets, and may be as thin as  $\frac{1}{16}$ ". Very few

copper pipes of small diameters are now used by engineers made in this way; they are usually solid drawn. When iron or copper pipes require flanges, these are generally brazed to the pipes; screwed flanges with lock-nuts are seldom, if ever, used. Unions for small brass and copper pipes are usually brazed, and not screwed on the pipes, as shown in Fig. 124*d*.

Section 26, on steam engine design, is well done. It is quite refreshing to find in a text-book of this kind that questions of manufacture and shop practice are considered worthy of notice; and as a rule, such details are carefully omitted—to the student's loss. The piston-rings shown in Fig. 180*a* are far too narrow for general work; and again, in Fig. 187, illustrative of a crosshead for a single slipper guide, the slipper is far too light for its work, besides being defectively attached to the crosshead. Further on, in Fig. 191, showing a connecting-rod end, surely the author would not recommend the strap to be machined out square at the corners as shown; the much-abused "practical man" would put in a radius instead, and by so doing increase the strength considerably. The brasses are also shown apart; whereas they must be tightly brought together for the type of rod end illustrated.

Beyond these few points, the two volumes are exceedingly well written, and will be of great use to students in our technical colleges. The author has taken great pains to ensure the clearness of his descriptions, and has succeeded in producing a thoroughly useful work.

N. J. LOCKYER.

#### THE EGYPTIAN COLLECTIONS AT CAMBRIDGE.

*Catalogue of the Egyptian Collection in the Fitzwilliam Museum.* By E. A. Wallis-Budge, Litt.D. (Cambridge: University Press, 1893.)

WE recently noticed at some length Dr. Wallis-Budge's book entitled "The Mummy," and mentioned that it was intended as an introduction or a supplement to his catalogue of the antiquities which belong to the University. The catalogue itself is now before us, and is, as might be expected, a scholarly piece of work. There are people who like to read catalogues; to them this volume should prove to be of greater interest even than its companion "The Mummy"; but fortunately tastes differ, and we confess that, except perhaps to a scholar of endowments equal to those of Dr. Budge himself, "The Mummy" is the better of the two. It is satisfactory, however, to remember that the Fitzwilliam collection has been duly catalogued by competent hands, and that this catalogue is now published in an accessible form, Cambridge thus taking the lead among English universities in allowing the world to know what treasures it possesses of ancient Egyptian art. This knowledge is very valuable to the student. How many of us, for example, have seen and admired at the Louvre the granite sarcophagus of Rameses III.? Yet how few of us have known till now that the lid of the same coffin is at Cambridge? When Oxford has published a catalogue like this, and when the British Museum has followed suit, the cross references from one collection to another will in

# CASSELL AND COMPANY'S ANNOUNCEMENTS.

## MR. NORMAN LOCKYER'S NEW WORK.

READY SHORTLY. Price 21s.

### The DAWN of ASTRONOMY. A Study of the Temple Worship and Mythology of the Ancient Egyptians. By J. NORMAN LOCKYER, C.B., F.R.S., &c. Illustrated.

The author endeavours to show that the Egyptian temples were built so as to secure observations of the sun and stars at certain times of the year. He next attempts to determine the stars so used, to find the astronomical ideas underlying the observations, and to trace some of the myths which arise out of them. A close similarity is suggested between the Babylonian and Egyptian astronomical ideas.

Just Published. Price 31s. 6d.

### The STORY of OUR PLANET. By Prof. T. G. BONNEY, D.Sc., LL.D., F.R.S., F.S.A., F.G.S. With Coloured Plates and Maps, and about 100 Illustrations.

"A companion volume to Sir Robert Ball's 'Story of the Heavens.' In every respect worthy of its companionship. . . . The work of a writer singularly well qualified by his scientific eminence and his rare literary gifts to render the main principles and results of geological reasoning intelligible to non-scientific readers of ordinary education."—*The Times*.

"The volume is excellently and profusely illustrated, and the letterpress and paper are excellent."—*Liverpool Post*.

CASSELL & COMPANY, LIMITED, LUDGATE HILL, LONDON.

# WALTER SCOTT'S LIST.

## THE CONTEMPORARY SCIENCE SERIES.

Edited by HAVELOCK ELLIS. *Crown 8vo, Cloth, 3s. 6d. each; Half-morocco, 6s. 6d. Illustrated.*

- |                                                                      |                                                                  |
|----------------------------------------------------------------------|------------------------------------------------------------------|
| THE EVOLUTION OF SEX. By Prof. Patrick Geddes and J. Arthur Thomson. | PRIMITIVE FOLK. By Elie Reclus.                                  |
| ELECTRICITY IN MODERN LIFE. By G. W. de Tunzelmann.                  | BACTERIA AND THEIR PRODUCTS. By Dr. Sims Woodhead.               |
| THE ORIGIN OF THE ARYANS. By Dr. Taylor.                             | EVOLUTION OF MARRIAGE. By Letourneau.                            |
| PHYSIOGNOMY AND EXPRESSION. By P. Mantegazza.                        | EDUCATION AND HEREDITY. By J. M. Guyau.                          |
| EVOLUTION AND DISEASE. By J. B. Sutton, F.R.C.S.                     | THE MAN OF GENIUS. By Prof. Lombroso.                            |
| THE VILLAGE COMMUNITY. By G. L. Gomme.                               | GRAMMAR OF SCIENCE. By Prof. Peareson.                           |
| THE CRIMINAL. By Havelock Ellis.                                     | PROPERTY: Its Origin and Development. By Letourneau.             |
| SANITY AND INSANITY. By Dr. Charles Mercier.                         | VOLCANOES: PAST AND PRESENT. By Prof. Edward Hull, LL.D., F.R.S. |
| HYPNOTISM. By Dr. Albert Moll (Berlin).                              | PUBLIC HEALTH PROBLEMS. By Dr. J. F. J. Sykes.                   |
| MANUAL TRAINING. By Dr. C. M. Woodward                               | MODERN METEOROLOGY. By Frank Waldo, Ph.D.                        |
| THE SCIENCE OF FAIRY TALES. By Edwin Sidney Hartland.                | THE GERM PLASM: A THEORY OF HEREDITY. By A. Weismann. 6s.        |
|                                                                      | INDUSTRIES OF ANIMALS. By F. Houssay.                            |

London: WALTER SCOTT, Limited, 24 Warwick Lane, Paternoster Row.

### To SCIENTISTS and LANTERNISTS, &c.

**THE ART OF PROJECTION, AND COMPLETE MAGIC LANTERN MANUAL**, by an Expert. Over 100 fine Illustrations, with Priceless wrinkles in all Branches of Optical Projection. Never before Published. How to choose, what to avoid, and how to use Oil, Limelight, Disolving, Electric, Opaque, Microscopic, and Polarising Lanterns, Slide Making and Painting, Enlarging, Registering, &c., &c. Prof. MALDEN says:—"A thoroughly practical Work, and should be studied by the experienced operator and amateur alike. A complete *code mecum* of Optical Lantern Manipulations. Price, bound in Cloth, 3s. 6d.; Postage, 5d. Worth its weight in gold. Send for Opinions of the Scientific Press to Mr. HUGHES, Brewster House, Mortimer Road, Kingsland, North London.

On the 1st of every Month.

### THE JOURNAL OF BOTANY, BRITISH AND FOREIGN.

Edited by JAMES BRITTEN, F.L.S., British Museum.

CONTENTS:—Original Articles by leading Botanists.—Extracts, and Notices of Books and Memoirs.—Articles in Journals.—Botanical News.—Proceedings of Societies.

Price 1s. 3d. Subscription for One Year, payable in advance, 12s.  
London: WEST, NEWMAN, & CO., 54 Hatton Garden, E.C.



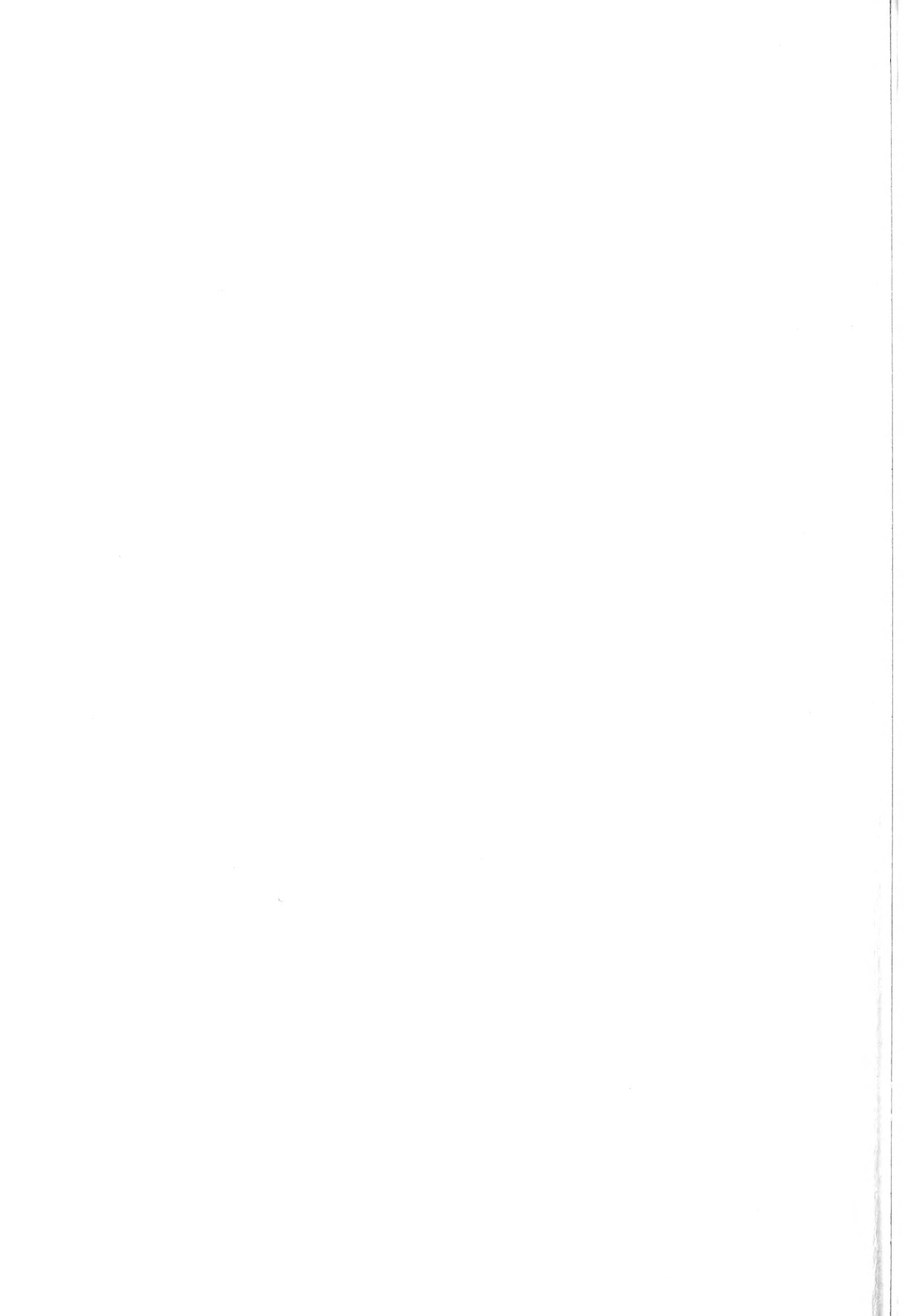



Q Nature  
1  
N2  
v.49  
cop.2

Physical &  
Applied Sci.  
Serials

PLEASE DO NOT REMOVE  
CARDS OR SLIPS FROM THIS POCKET

---

UNIVERSITY OF TORONTO LIBRARY

---

193<sub>4</sub> 246 387/41 <sup>529/30</sup> 578 569/70 575/6

